

December 2016 | EIR Addendum

SKYLINE RANCH MODIFIED TRACT 60922 ADDENDUM

for County of Los Angeles

Prepared for:

County of Los Angeles Department of Regional Planning

Contact: Steven D. Jones, AICP, Principal
Regional Planning Assistance, Land Divisions
320 West Temple Street
Los Angeles, California 90012
213.974.6433

Prepared by:

PlaceWorks

Contact: JoAnn Hadfield, Principal, Environmental Services
3 MacArthur Place, Suite 1100
Santa Ana, California 92707
714.966.9220
info@placeworks.com
www.placeworks.com



Table of Contents

Section	Page
1. INTRODUCTION.....	1
1.1 PURPOSE OF ADDENDUM	1
1.2 CONTENT AND ORGANIZATION OF THIS ADDENDUM	3
2. ENVIRONMENTAL SETTING	5
2.1 PROJECT LOCATION	5
2.2 ENVIRONMENTAL SETTING.....	5
3. PROJECT DESCRIPTION.....	11
3.1 PROJECT BACKGROUND	11
3.2 MODIFIED PROJECT DESCRIPTION	11
3.3 COUNTY ACTION REQUESTED	14
4. ENVIRONMENTAL CHECKLIST	25
4.1 BACKGROUND.....	25
4.2 ENVIRONMENTAL FACTORS POTENTIALLY AFFECTED	26
4.3 DETERMINATION (TO BE COMPLETED BY THE LEAD AGENCY).....	26
4.4 EVALUATION OF ENVIRONMENTAL IMPACTS	27
5. ENVIRONMENTAL ANALYSIS	29
5.1 AESTHETICS	29
5.2 AGRICULTURE AND FOREST RESOURCES	40
5.3 AIR QUALITY	42
5.4 BIOLOGICAL RESOURCES	49
5.5 CULTURAL RESOURCES	59
5.6 ENERGY.....	65
5.7 GEOLOGY AND SOILS.....	68
5.8 GREENHOUSE GAS EMISSIONS.....	77
5.9 HAZARDS AND HAZARDOUS MATERIALS.....	81
5.10 HYDROLOGY AND WATER QUALITY	87
5.11 LAND USE AND PLANNING	102
5.12 MINERAL RESOURCES.....	104
5.13 NOISE.....	105
5.14 POPULATION AND HOUSING	111
5.15 PUBLIC SERVICES.....	114
5.16 RECREATION	121
5.17 TRANSPORTATION/TRAFFIC.....	123
5.18 UTILITIES AND SERVICE SYSTEMS	131
5.19 MANDATORY FINDINGS OF SIGNIFICANCE	140
6. LIST OF PREPARERS	143
7. REFERENCES.....	145

APPENDICES

- Appendix A. Geotechnical Study
- Appendix B. Traffic Study and Memo

Table of Contents

List of Figures

Figure		Page
Figure 1	Regional Location	7
Figure 2	Local Vicinity	9
Figure 3	Approved TTM.....	15
Figure 4	Approved TTM vs. Proposed Concept Plan.....	17
Figure 5	Development Footprint Comparison.....	19
Figure 6	Modified Conceptual Lot Plan	21
Figure 7	Open Space and Trails Map	23
Figure 8	Visual Simulation Comparison – Part 1	33
Figure 9	Visual Simulation Comparison – Part 2	35
Figure 10	Visual Simulation Comparison – Part 3	37

List of Tables

Table		Page
Table 1	Modified Project Housing Product Breakdown	12
Table 2	Approved and Modified Development Comparison.....	13
Table 3	Approved and Modified Projects Housing Product Type Comparison	13
Table 4	Visual Simulation Impacted Comparison	31
Table 5	Historic Energy Use in Los Angeles County, 2006–2013.....	66
Table 6	Approved Project vs. Modified Project, Projected Energy Use.....	67
Table 7	HMA Ordinance Consistency Analysis.....	73
Table 8	Skyline Ranch Approved Project GHG Emissions	78
Table 9	Approved Project vs. Modified Project – Population.....	113
Table 10	Approved Project vs. Modified Project, Student Generation	118
Table 11	Modified Project Trip Generation Rates.....	126
Table 12	Trip Generation Comparison	126
Table 13	Proposed Roundabouts LOS and Delay Summary.....	127
Table 14	Queue Lengths for Each Leg of Roundabouts.....	127
Table 15	LOS, Delay & Queue Summary at School and Park.....	128
Table 16	Approved Project, Estimated Water Demand	132
Table 17	Approved Project, Estimated Wastewater Generation.....	133
Table 18	Approved Project, Estimated Solid Waste Generation	134
Table 19	Approved Project vs. Modified Project, Estimated Wastewater Generation	136
Table 20	Approved Project vs. Modified Project, Estimated Water Demand.....	137
Table 21	Sunshine Canyon and Chiquita Canyon Landfills Information	138
Table 22	Approved Project vs. Modified Project, Solid Waste Generation	139

1. Introduction

This Addendum is an analysis of proposed changes to the Skyline Ranch Project (Approved Project) (Approved Tentative Tract Map[TTM] No. 60922, County Project No. 04-075) for which an Environmental Impact Report (EIR) (State Clearinghouse No. 2004101090) prepared by the County of Los Angeles was certified on December 7, 2010. This document uses the County of Los Angeles' adopted CEQA checklist as a format to identify the appropriate level of environmental review (i.e., an addendum, supplemental EIR, etc.).

The Skyline Ranch EIR analyzed development of 622 acres of the 2,173-acre project site, which included a total of 1,313 total lots—1,260 residential lots, an approximately 11-acre elementary school site, 10 lots for park areas, 13 debris basin lots, 4 water tank/booster pump station lots, and 25 open space lots (1,313 total lots). This Addendum evaluates the incremental environmental impacts of proposed modifications to the Approved Project, including a realignment of Skyline Ranch Road, reduction of 40 residential lots (but inclusion of age-qualified homes and a recreation center), modifications to housing product types, relocation and expansion of park sites, and extension of multipurpose trails and bike lanes. After consideration of the incremental environmental impacts of the proposed modifications to the Approved Project, the County of Los Angeles will be able to clearly determine whether an addendum or supplemental EIR is required to provide appropriate analysis and legal defensibility.

1.1 PURPOSE OF ADDENDUM

1.1.1 CEQA Requirements

According to Section 21166 of CEQA and Section 15162 of the State CEQA Guidelines, when an EIR has been certified or a negative declaration adopted for a project, no subsequent EIR or negative declaration shall be prepared for the project unless the lead agency determines that one or more of the following conditions are met:

1. Substantial project changes are proposed that will require major revisions of the previous EIR or negative declaration due to the involvement of new significant environmental effects or a substantial increase in the severity of previously identified significant effects;
2. Substantial changes would occur with respect to the circumstances under which the project is undertaken that require major revisions to the previous EIR or negative declaration due to the involvement of new significant environmental effects or a substantial increase in the severity of previously identified significant effects; or

1. Introduction

3. New information of substantial importance that was not known and could not have been known with the exercise of reasonable diligence at the time the previous EIR was certified or the negative declaration was adopted shows any of the following:
 - a. The project will have one or more significant effects not discussed in the previous EIR or negative declaration.
 - b. Significant effects previously examined will be substantially more severe than identified in the previous EIR.
 - c. Mitigation measures or alternatives previously found not to be feasible would in fact be feasible, and would substantially reduce one or more significant effects of the project, but the project proponent declines to adopt the mitigation measures or alternatives.
 - d. Mitigation measures or alternatives that are considerably different from those analyzed in the previous EIR would substantially reduce one or more significant effects on the environment, but the project proponent declines to adopt the mitigation measures or alternatives.

Preparation of an Addendum to an EIR is appropriate when none of the conditions specified in Section 15162 (above) are present and some minor technical changes to the previously certified EIR are necessary.

After consideration of the potential environmental impacts of the proposed modifications to the Approved Project, the County of Los Angeles has determined that 1) none of the conditions requiring preparation of a subsequent or supplement to an EIR have occurred, and 2) the circumstances described in Section 15164 of the CEQA Guidelines exist. Therefore, an Addendum to the Skyline Ranch EIR has been deemed appropriate.

1.1.2 Scope of Analysis in this Addendum

The discretionary approval subject to CEQA for this project is the modification of Approved TTM 60922. As lead agency under CEQA for this action, the County of Los Angeles is required to evaluate the environmental impacts associated with this discretionary approval (modified tract map). The “scope” of the review for project-related impacts for this Addendum is limited to changes between the Approved Project and the requested modifications to the project (Modified Project). The previously certified environmental documentation and related approved mitigation for impacts associated with the Approved Project effectively serve as the “baseline” for the environmental impact analysis. This Addendum also addresses changes in circumstances or new information that would potentially involve new environmental impacts.

1. Introduction

1.2 CONTENT AND ORGANIZATION OF THIS ADDENDUM

This Addendum uses the County of Los Angeles' adopted CEQA checklist, included as Section 2.0, *Environmental Checklist*; the analysis for each environmental topic is provided in Section 5.0, *Environmental Analysis*. Each environmental topic has the following subheadings:

- Summary of Impacts Identified in the Certified EIR (County Project No. 04-075)
- Impacts Associated with the Modified Project
- Adopted Mitigation Measures Applicable to the Modified Project
- Level of Significance After Mitigation

Formerly adopted mitigation measures as part of the Certified EIR are identified and carried forward or noted as being satisfied. Where necessary, mitigation measures have been updated, refined, and/or supplemented to ensure mitigation is implemented as intended for the Modified Project. Such changes are shown in ~~strike-out~~/**underlined bold** format and will be incorporated in the final mitigation monitoring program for the Modified Project.

1. Introduction

This page intentionally left blank.

2. Environmental Setting

2.1 PROJECT LOCATION

As shown in Figure 1, *Regional Location*, the 2,173-acre Skyline Ranch project site is in the community of Canyon Country in the Santa Clarita Valley of unincorporated Los Angeles County. The project site is north of Highway 14 (Antelope Valley Freeway) and the City of Santa Clarita. The site includes undeveloped parcels west of Sierra Highway between the Santa Clara River and Vasquez Canyon. Figure 2, *Local Vicinity*, shows the site roughly bounded by the Sierra Highway (Mint Canyon) to the east and southeast, residential communities in the City of Santa Clarita to the south and southwest, Plum Canyon Road to the west, Bouquet Canyon Road to the northwest, and Vasquez Canyon Road to the northeast.

Primary access to the project site is provided by the proposed extension of Whites Canyon Road (as Skyline Ranch Road) from Plum Canyon on the western boundary of the site and by Skyline Ranch Road and Sierra Highway in the southeast corner of the project site.

2.2 ENVIRONMENTAL SETTING

2.2.1 Existing Land Use

The project site is completely vacant and undeveloped. The site is dominated by irregular, brush-covered terrain with ridges between Plum Canyon to the north and Whites Canyon to the south.

Additionally, a substantial portion of the Cruzan Mesa Vernal Pools Significant Ecological Area (SEA) is in the northern two-thirds of the project site. This SEA was adopted by the County as part of the Santa Clarita Valley Area Plan Update: One Valley One Vision in November 2012. SEAs are officially designated areas within the County for their biological value. The Cruzan Mesa Vernal Pools SEA includes mesas, canyons, and interior slopes supporting coastal sage scrub or scrub-chaparral vegetation. The Cruzan Mesa vernal pool complex lies within an elevated, topographically enclosed basin atop an eroded foothill between Mint and Bouquet canyons. The Plum Canyon vernal pool, situated in a landslide depression on a hillside terrace, is smaller than the Cruzan Mesa pools, but possesses the same essential vernal pool characteristics as the larger system, and the two areas together form an ecologically functional unit. Refer to Section 5.4, *Biological Resources*, for additional information on the Cruzan Mesa Vernal Pools SEA.

2.2.2 Surrounding Land Use

Surrounding uses near the project site include undeveloped, open space to the north and northeast, existing and planned residential uses in the City of Santa Clarita and unincorporated Los Angeles County to the south and west, and residential uses in the community of Forest Park to the east near Sierra Highway.

2. Environmental Setting

The Angeles National Forest is further south of the site, and the Castaic Lake Recreation Area is to the northwest. The Santa Clara River flows in an east-west direction through the City of Santa Clarita.

2.2.3 General Plan and Zoning

According to the County of Los Angeles General Plan's Santa Clarita Valley Area Plan Land Use Policy Map, the entire project site is designated H2 (Residential 2, 0–2 dwelling unit [du]/acre) and RL 5 (Rural Land 5, 1 du/5 acres) (Los Angeles 2012a). The area proposed for development under the Approved and Modified Projects are designated H2.

The County of Los Angeles Zoning Code designates the project site R-1 (Single-family residence), A-1-2 (Light agriculture), and A-2-2 (Heavy agriculture) (Los Angeles 2012b). The area proposed for development under the Approved and Modified Projects are zoned R-1.

Figure 1 - Regional Location

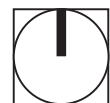
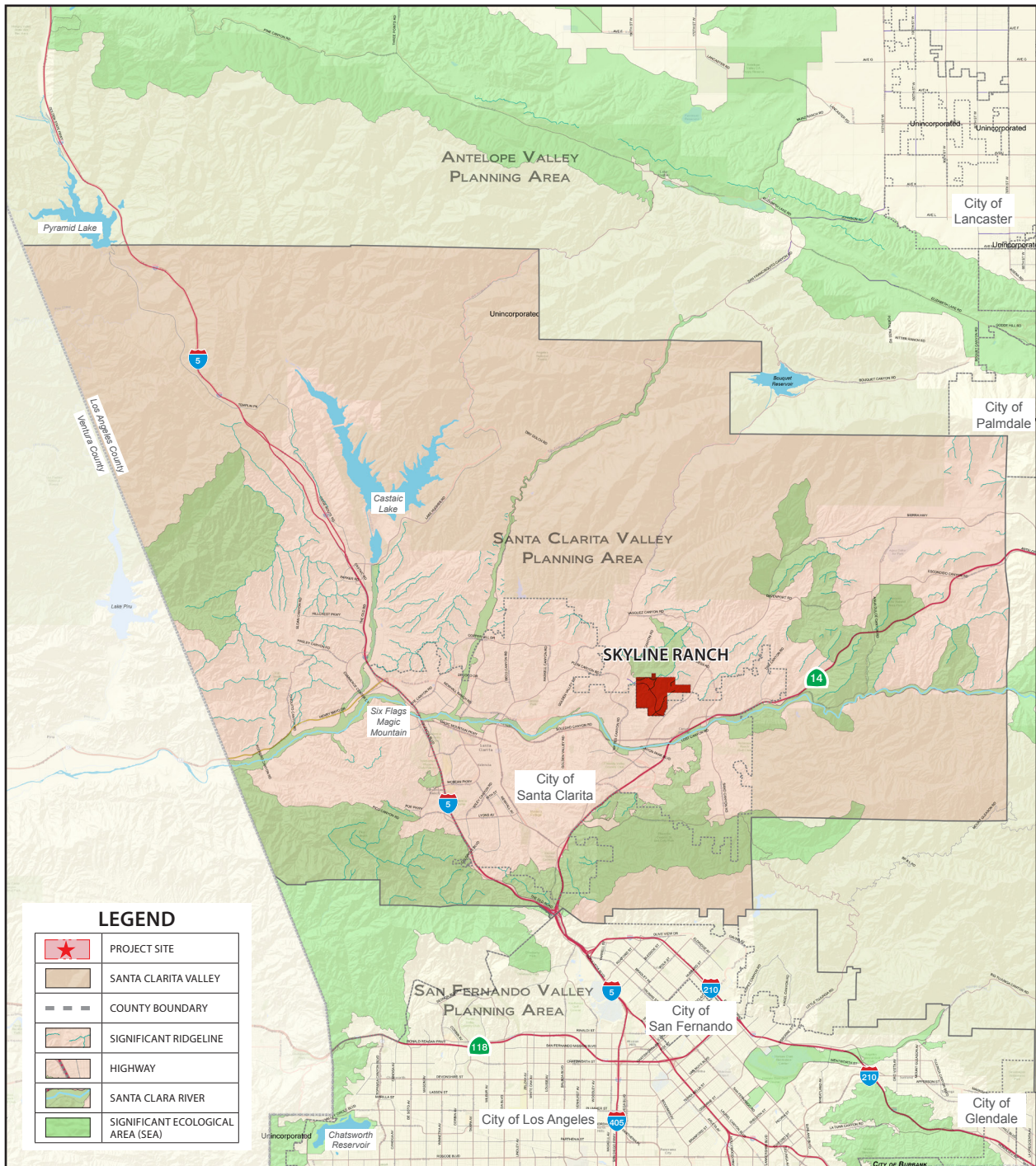

2. Environmental Setting

This page intentionally left blank.

Figure 2 - Local Vicinity

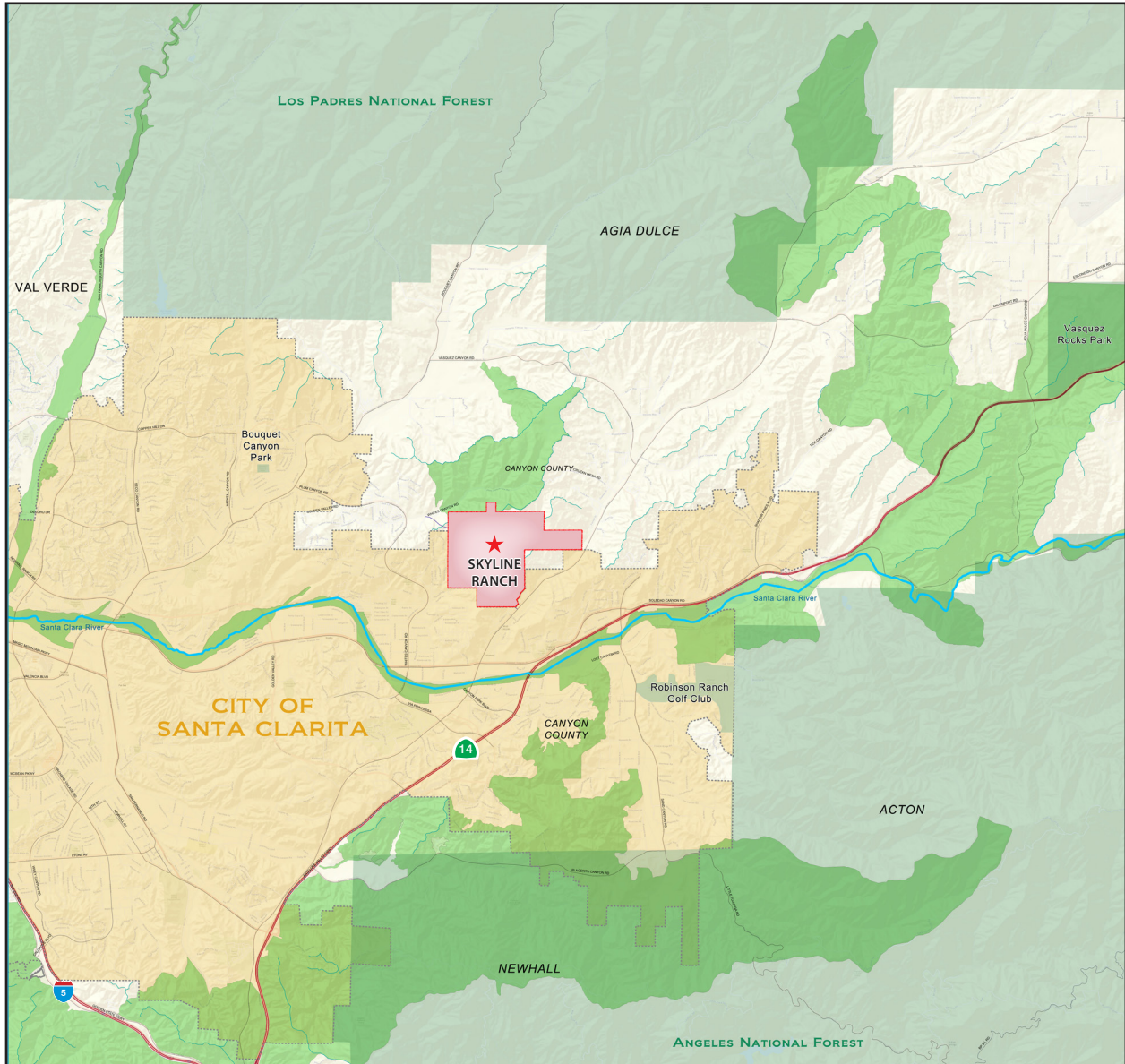

LEGEND

	PROJECT SITE
	CITY BOUNDARY
	SIGNIFICANT RIDGELINE
	HIGHWAY
	SANTA CLARA RIVER
	NATIONAL FOREST
	SIGNIFICANT ECOLOGICAL AREA (SEA)

0 12,000
 Scale (Feet)

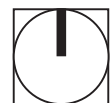

2. Environmental Setting

This page intentionally left blank.

3. Project Description

3.1 PROJECT BACKGROUND

The Skyline Ranch project site occupies approximately 2,173 acres in unincorporated Los Angeles County. As shown on Figure 3, *Approved TTM*, the Approved Project includes development on approximately 622 acres of the 2,173-acre site with 1,260 single-family residential lots, an approximately 11.6-acre elementary school site, about 12 acres of public parkland to be dedicated to the Los Angeles County Department of Parks and Recreation, and about 6.2 acres of private parkland. Nearly three-quarters of the site (the northern 1,551 acres) would remain undeveloped, with approximately 1,355 acres dedicated or designated as natural open space through establishment of the proposed Skyline Ranch Conservation Area (SRCA). Approximately 166 acres of undeveloped land in the northern portion of the site would remain undeveloped and designated as Non-development/Continuing Use Area. Also, within the northern portion of the site, approximately 22 acres would be preserved as a Mitigation Exchange Area for 22 acres of preserve area within adjacent recorded Tract 46018 that would be disturbed due to the construction of Skyline Ranch Road. These three areas would preserve approximately 80 percent of the land in the County's Cruzan Mesa Vernal Pools SEA. No development associated with the Skyline Ranch Project would occur in the SEA areas.

A proposed trail would extend the existing Mint Canyon Trail from Vasquez Canyon Road to the Plum Canyon Fire Road along an existing dirt path and southwesterly toward a lookout point. The proposed trail easement would run approximately 2.2 miles within portions of the SRCA and Non-development/Continuing Use Area. The Approved Project would include two miles of hiking trails, one mile of paseo trails, and eight miles of bike lanes.

3.2 MODIFIED PROJECT DESCRIPTION

The Modified Project includes minor technical changes to the approved Skyline Ranch project. Figure 4, *Approved TTM vs. Proposed Concept Plan*, shows the proposed conceptual site plan, which includes the modifications described below. Figure 5, *Development Footprint Comparison*, shows an overlay of the Modified and Approved Projects. The Modified Project would have a smaller development footprint within the footprint of the Approved Project. In total, the site would be divided into seventeen planning areas (PAs), designated PA A through Q, one park sites, seven recreation center sites, and one school site (see Figure 6, *Modified Conceptual Lot Plan*).

- **Realignment of Skyline Ranch Road.** The Modified Project would shift Skyline Ranch Road west of the original alignment. All residential development would be east of the roadway rather than divided by the original alignment. Skyline Ranch Road would maintain its designation as a secondary highway and is proposed to have roundabouts at intersections within the project boundaries. The two access points of Skyline Ranch Road at Plum Canyon Road (to the west) and Sierra Highway (to the southeast) would not change.

3. Project Description

- **Reduction of residential development and inclusion of age-qualified housing.** Residential development would be reduced from 1,260 to 1,220 lots (40 fewer units). The homes along the western edge of the property would be removed and/or shifted east of the realigned Skyline Ranch Road, and 284 units of age-qualified housing with a recreation center would be provided in the northern portion of the planned community in PAs G through K.
- **Modifications to housing product types.** A broader range of lot sizes and housing types is now proposed, including smaller, more affordable homes for first-time buyers or move-down buyers that were not included in the original plan. There would be a total of six product types and 1,220 dwelling units. The breakdown of housing product types is provided in Table 1 and Figure 6, *Modified Conceptual Lot Plan*, below.

Table 1 Modified Project Housing Product Breakdown

Product Type	Dwelling Units	Percentage of Total
Market Rate Units		
Grayson ¹	344	28
55' x 90' Lot	198	16
50' x 100' Lot	186	15
55' x 100' Lot	119	10
65' x 100' Lot	89	7
<i>Market Rate Subtotal</i>	<i>936</i>	<i>77%</i>
Age Qualified Units		
55' x 90' Lot	122	10
50' x 100' Lot	88	7
65' x 90' Lot	74	6
<i>Age Qualified Subtotal</i>	<i>284</i>	<i>23%</i>
GRAND TOTAL	1,220	100%

Note: du/ac = dwelling units per acre

¹ TRI Pointe Group's Grayson housing product is a motor court home design with 45'x75' condominium lots that include stub street access and are configured in six lots to create a court.

- **Relocation of park and recreation sites.** The park sites proposed under the Approved Project would be relocated and combined into one large park adjacent to the school, as shown on Figure 4, *Approved TTM vs. Proposed Concept Plan*. Approximately 16.9 acres of public parkland to be dedicated to the Los Angeles County Department of Parks and Recreation would be relocated to be accessible without crossing streets—in particular without crossing Skyline Ranch Road. Seven recreation centers would be located within the Skyline Ranch community and connected by a multi-purpose trail system. Additionally, the Modified Project includes 2.7 acres of private parkland (a recreation center for age-qualified housing).
- **Addition of multipurpose trails.** The Modified Project would include 10.75 miles of pedestrian connections, which includes 3 miles of hiking trails, a 2.2-mile trail easement, 3.3 miles of paseo trails, and 2.3 miles of multipurpose trails (see Figure 7, *Open Space and Trails Map*).

3. Project Description

- **Extension of bike lanes.** Bike lanes within the Skyline Ranch community would extend from 8 miles to 9.8 miles under the Modified Project.

A comprehensive comparison of the Approved and Modified Projects' land use development and housing product types is provided in Tables 2 and 3.

Table 2 Approved and Modified Development Comparison

	Approved Project	Modified Project
Developed Acres	622 acres (ac)	492 ac
Single Family	348	313
Slopes	277	178
Dwelling Units	1,260 units	1,220 units
Parks	18.2 ac	19.6 ac
Pocket Parks	3.7	6.5
Private Parks	2.5	2.7
Neighborhood Parks	12.0	10.5
Pedestrian Connections	5.2 miles	10.75 miles
Hiking Trails	2	3
Trail Easement	2.2	2.2
Paseo Trails	1.0	3.3
Multipurpose Trails	—	2.3
Bike Lanes	8 miles	9.8 miles
School	11.6 ac	11.9 ac

Table 3 Approved and Modified Projects Housing Product Type Comparison

	Approved Project	Modified Project
Grayson	—	344
55x90	—	198
50x100	—	186
55x100	—	119
55x105	658	—
60x100	—	—
60x105	337	—
65x100	—	89
70x105	265	—
Subtotal	1,260	936
Age Qualified		
55x90	—	122
50x100	—	88
65x90	—	74
Subtotal	0	284
Grand Total	1,260	1,220

3. Project Description

Additionally, the Modified Project would reduce the number of basins from 13 to 12, but the 4 water tanks at the northern portion of the developable area under the Approved Project would remain. Overall, the Modified Project would have a reduced development footprint within the Approved Project's development footprint (see Table 2 and Figure 5, *Development Footprint Comparison*). Compared to the Approved Project, grading quantities would decrease by approximately 18 and 19 percent for cut and fill quantities, respectively. The cut and fill quantities would decrease to approximately 17.1 million cubic yards (cy) cut and 16.9 million cy fill.

3.3 COUNTY ACTION REQUESTED

As part of the Modified Project, the following discretionary actions are required by the County of Los Angeles:

- Approval of Modification to Approved Tentative Tract Map No. 60922
- Approval of the Skyline Ranch Modified Tract 60922 Addendum

Figure 3 - Approved TTM

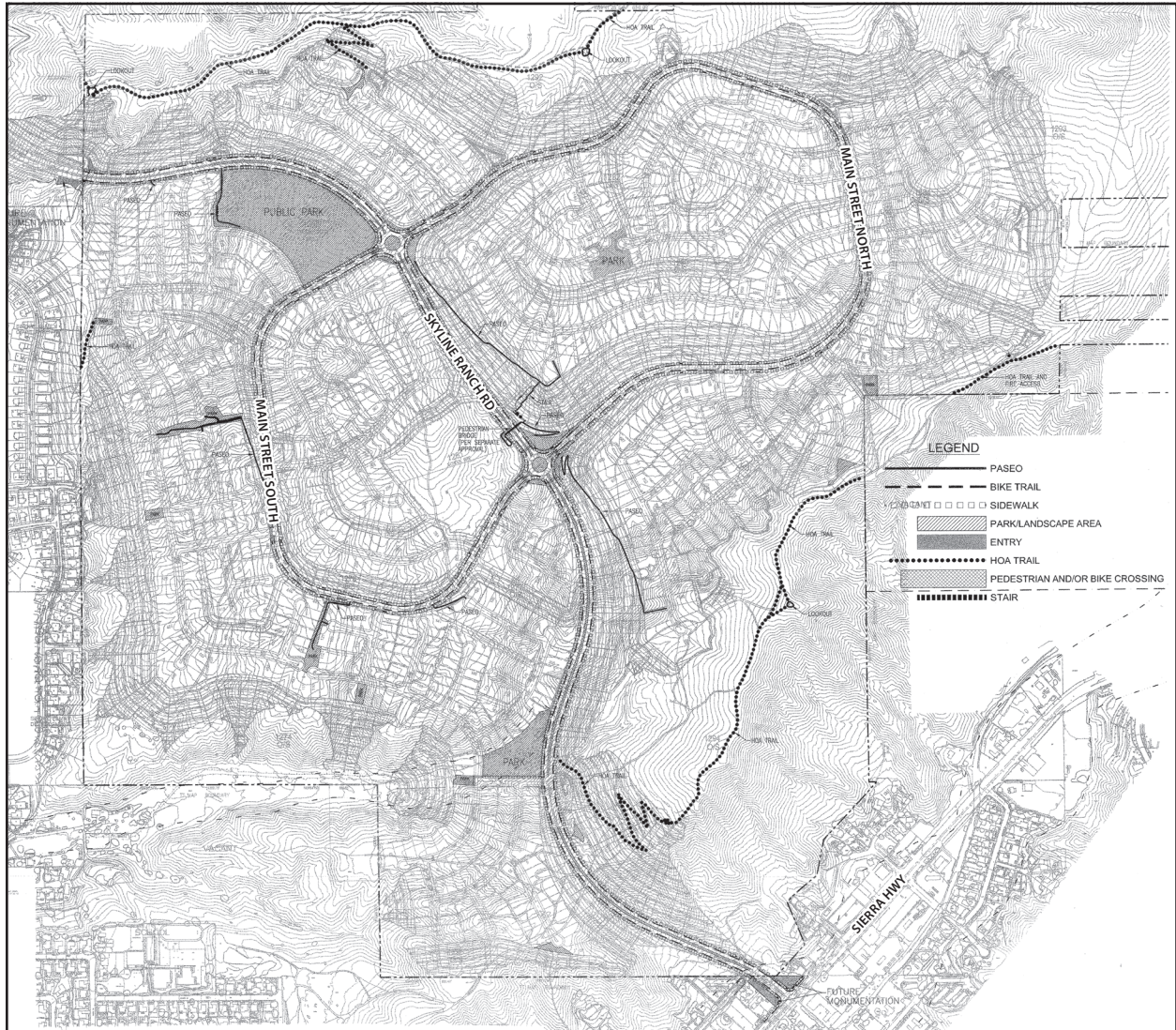

3. Project Description

This page intentionally left blank.

Figure 4 - Approved TTM vs Proposed Concept Plan

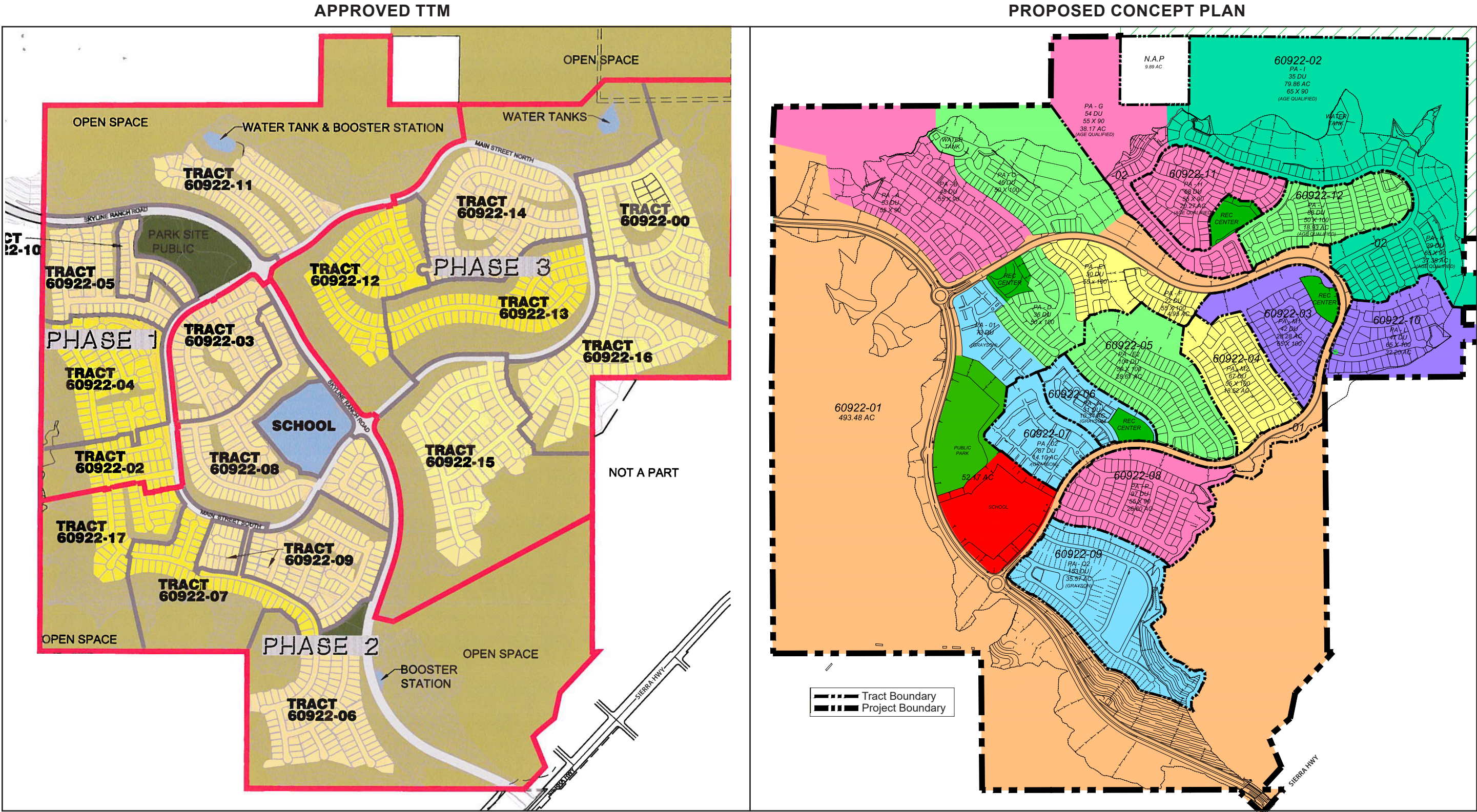

Base Map Source: PlaceWorks, 2015; Sikand 2016

3. Project Description

This page intentionally left blank.

Figure 5 - Development Footprint Comparison

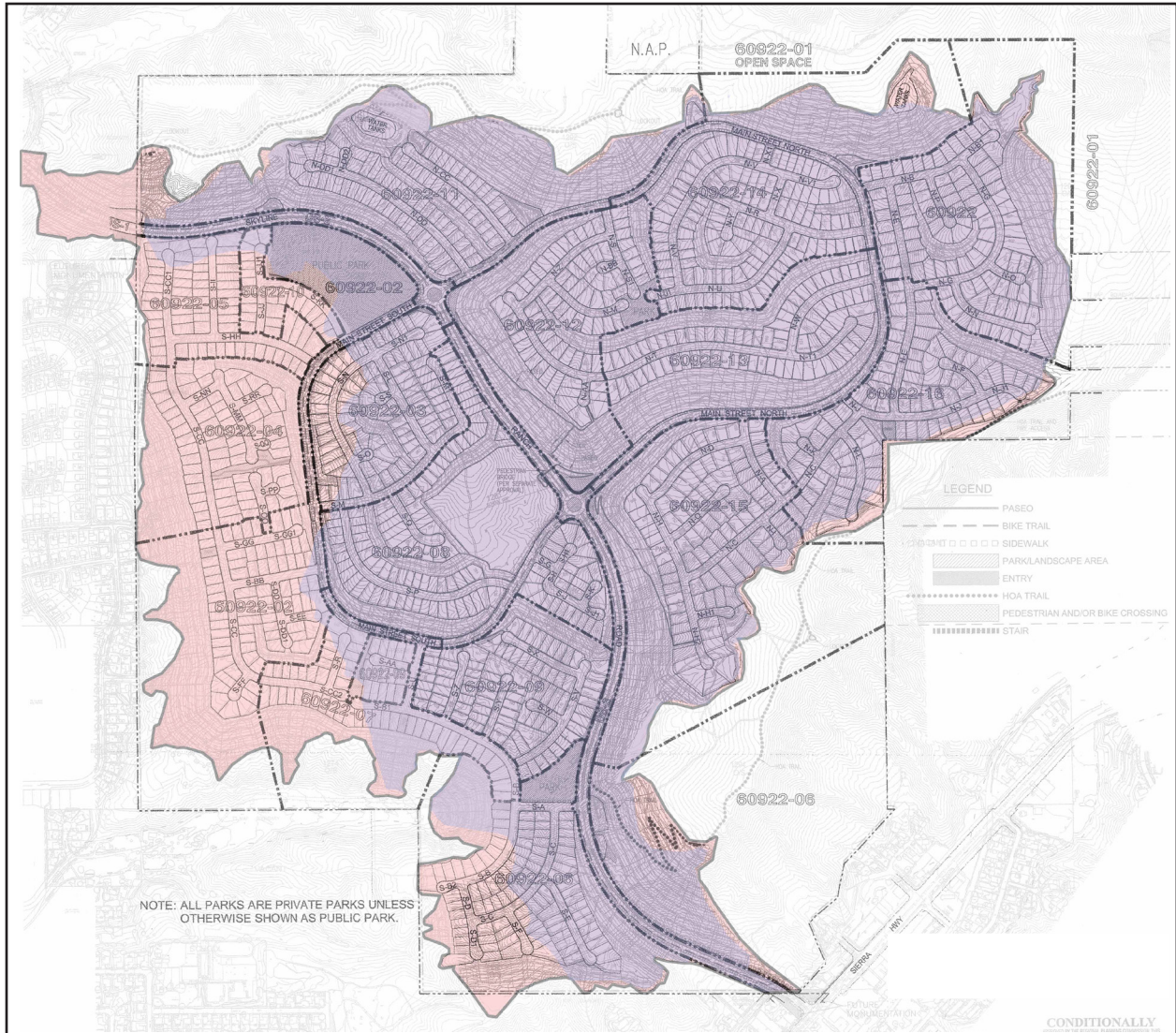

LEGEND

	APPROVED TTM DEVELOPMENT AREA
	PROPOSED PLAN DEVELOPMENT AREA

0 1,200
 Scale (Feet)



3. Project Description

This page intentionally left blank.

Figure 6 - Modified Conceptual Lot Plan

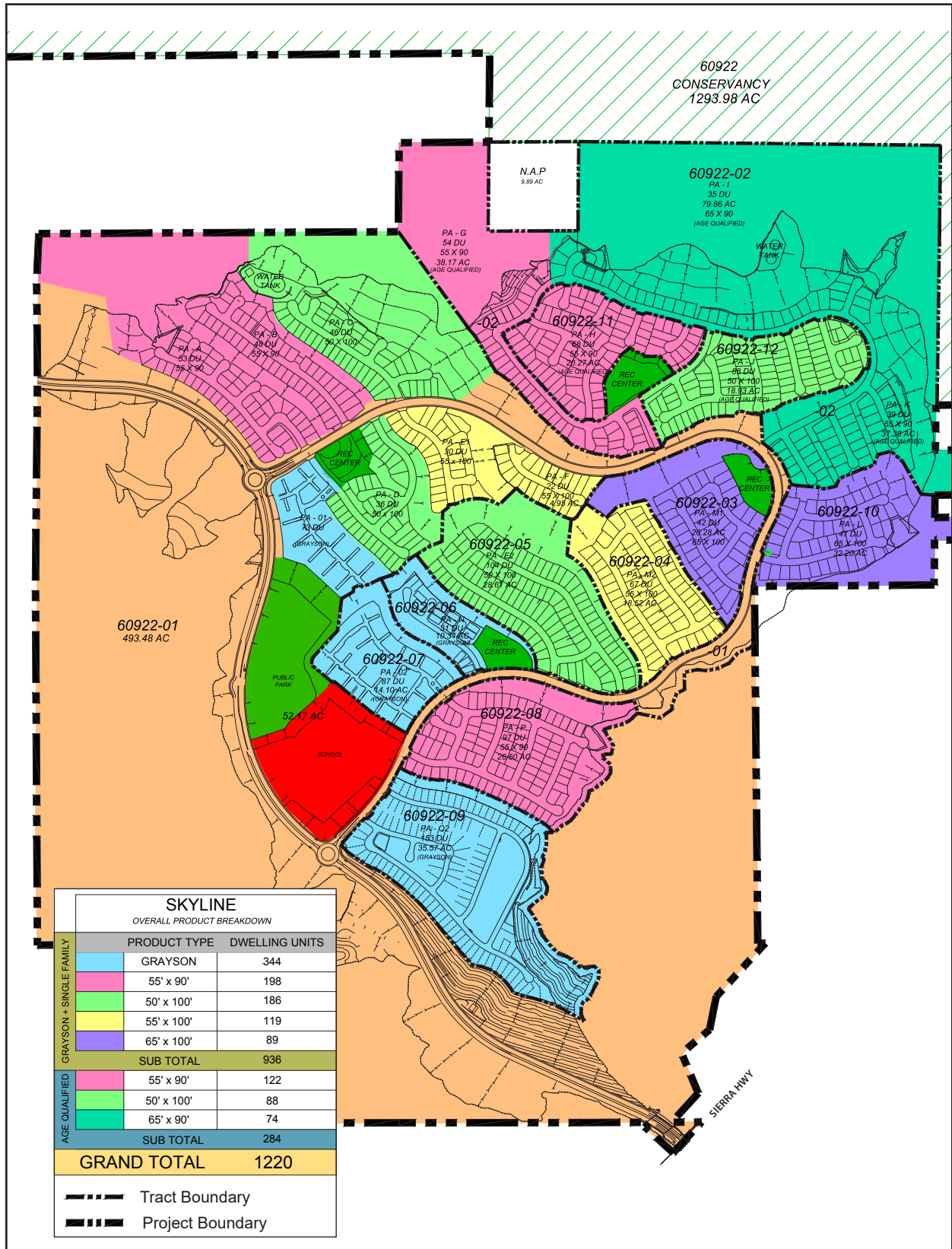





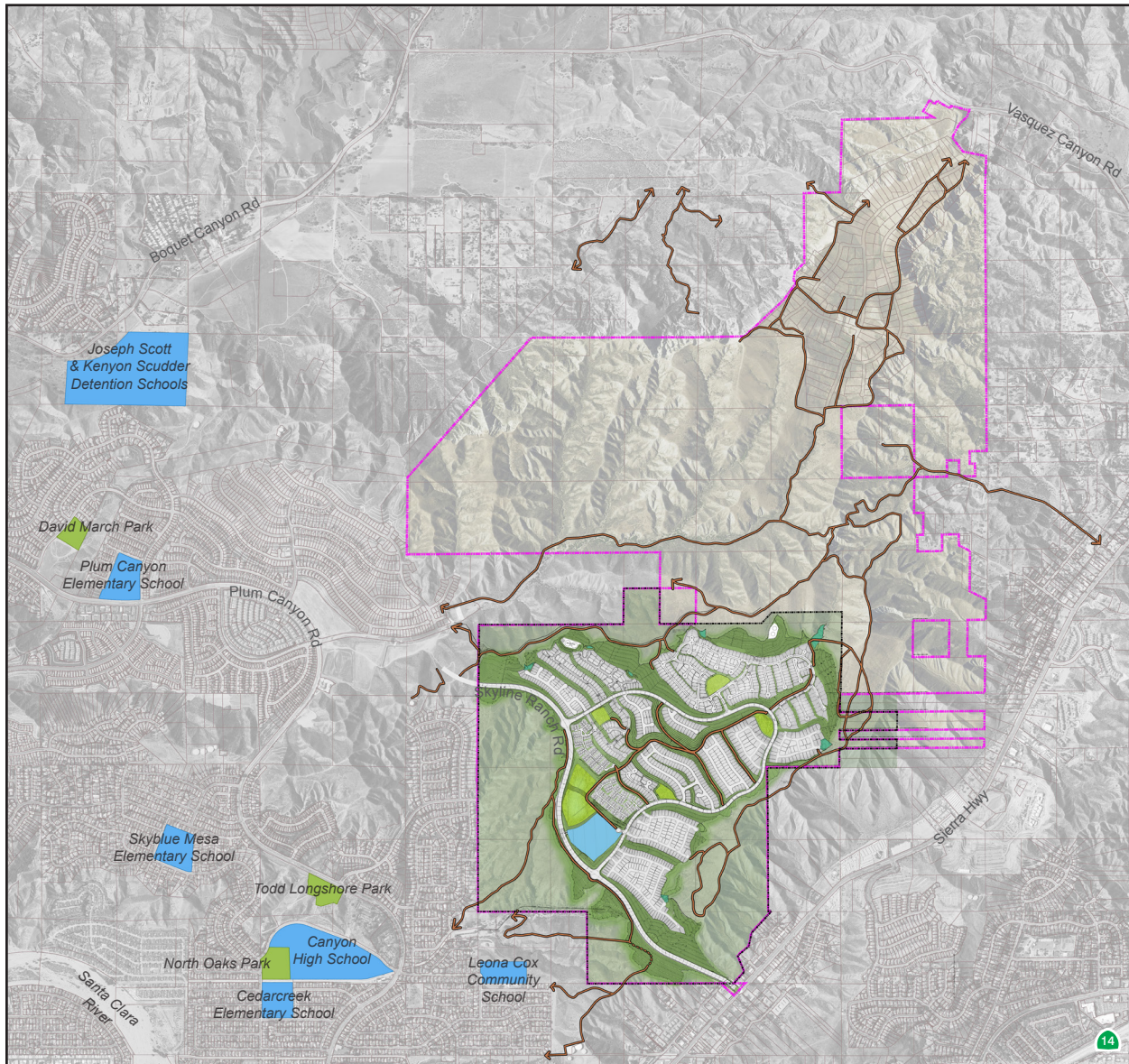

3. Project Description

This page intentionally left blank.

Figure 7 - Open Space and Trails Map



LEGEND

	SCHOOL
	PARK
	SLOPE
	TRAILS
	SITE BOUNDARY
	OWNERSHIP BOUNDARY

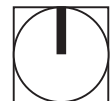

3. Project Description

This page intentionally left blank.

4. Environmental Checklist

4.1 BACKGROUND

1. Project Title: Skyline Ranch Modified Tract 60922 Addendum

2. Lead Agency Name and Address:

County of Los Angeles
Department of Regional Planning
320 West Temple Street
Los Angeles, CA 90012

3. Contact Person and Phone Number:

Steven D. Jones, AICP, Principal Regional Planning Assistant, Land Divisions
(213) 974-6433

4. Project Location: The 2,173-acre project site is in the Santa Clarita Valley north of Highway 14 and the City of Santa Clarita in unincorporated Los Angeles County. The site is roughly bounded by the Sierra Highway to the east and southeast, residential communities in Santa Clarita to the south and southwest, Plum Canyon Road to the west, Bouquet Canyon Road to the northwest, and Vasquez Canyon Road to the northeast.

5. Project Sponsor's Name and Address:

TRI Pointe Group
Mike McMillen, Vice President
19540 Jamboree Road, Suite 300
Irvine, CA 92612

6. General Plan Designation: H2 (Residential 2, 0-2 du/acre), RL 5 (Rural Land 5, 1 du/5 acres)

7. Zoning: R-1 (Single-family residence), A-1-2 (Light agriculture), and A-2-2 (Heavy agriculture)

8. Description of Project: The proposed project would modify Approved TTM 60922 within the development footprint of the Skyline Ranch property. Modifications include a realignment of Skyline Ranch Road, reduction by 40 residential lots (but inclusion of 284 units of age-qualified homes and a recreation center), modifications to housing product types, extension of trails and bikes lanes, and relocation of park and recreation center sites.

9. Surrounding Land Uses and Setting: Surrounding uses near the project site include undeveloped, open space to the north and northeast, residential uses in the City of Santa Clarita to the south and southwest, and residential uses in the community of Forest Park to the east.

10. Other Public Agencies Whose Approval Is Required: None.

4. Environmental Checklist

4.2 ENVIRONMENTAL FACTORS POTENTIALLY AFFECTED

The environmental factors checked below would be potentially affected by this project, involving at least one impact that is a “Potentially Significant Impact,” as indicated by the checklist on the following pages.

- | | | |
|---|--|---|
| <input type="checkbox"/> Aesthetics | <input type="checkbox"/> Agricultural and Forest Resources | <input type="checkbox"/> Air Quality |
| <input type="checkbox"/> Biological Resources | <input type="checkbox"/> Cultural Resources | <input type="checkbox"/> Geology / Soils |
| <input type="checkbox"/> Greenhouse Gas Emissions | <input type="checkbox"/> Hazards & Hazardous Materials | <input type="checkbox"/> Hydrology / Water Quality |
| <input type="checkbox"/> Land Use / Planning | <input type="checkbox"/> Mineral Resources | <input type="checkbox"/> Noise |
| <input type="checkbox"/> Population / Housing | <input type="checkbox"/> Public Services | <input type="checkbox"/> Recreation |
| <input type="checkbox"/> Transportation / Traffic | <input type="checkbox"/> Utilities / Service Systems | <input type="checkbox"/> Mandatory Findings of Significance |

4.3 DETERMINATION (TO BE COMPLETED BY THE LEAD AGENCY)

On the basis of this initial evaluation:

I find that the proposed project COULD NOT have a significant effect on the environment, and a NEGATIVE DECLARATION will be prepared.

I find that although the proposed project could have a significant effect on the environment, there will not be a significant effect in this case because revisions in the project have been made by or agreed to by the project proponent. A MITIGATED NEGATIVE DECLARATION will be prepared.

I find that the proposed project MAY have a significant effect on the environment, and an ENVIRONMENTAL IMPACT REPORT is required.

I find that the proposed project MAY have a “potentially significant impact” or “potentially significant unless mitigated” impact on the environment, but at least one effect 1) has been adequately analyzed in an earlier document pursuant to applicable legal standards, and 2) has been addressed by mitigation measures based on the earlier analysis as described on attached sheets. An ENVIRONMENTAL IMPACT REPORT is required, but it must analyze only the effects that remain to be addressed.

I find that although the proposed project could have a significant effect on the environment, because all potentially significant effects (a) have been analyzed adequately in an earlier EIR or NEGATIVE DECLARATION pursuant to applicable standards, and (b) have been avoided or mitigated pursuant to that earlier EIR or NEGATIVE DECLARATION, including revisions or mitigation measures that are imposed upon the proposed project, nothing further is required.

Signature

Date

Printed Name

For

4. Environmental Checklist

4.4 EVALUATION OF ENVIRONMENTAL IMPACTS

In Section 5.0, the Addendum identifies the incremental effects of the Modified Project in comparison with the Approved Project. This comparative analysis has been undertaken, pursuant to the provisions of CEQA, to provide the factual basis for determining whether any changes in the project or its circumstances or any new information requires additional environmental review or preparation of a subsequent or supplemental EIR.

The incremental environmental changes of the Modified Project may involve one or more of the following: (1) new significant environmental impacts, (2) a substantial increase in severity of significant impacts previously identified, (3) substantial changes to the circumstances under which the project is undertaken involving such new impacts or such a substantial increase in the severity of significant impacts, or (4) new information of substantial importance as defined by CEQA Guidelines Section 15162. Under these circumstances, the lead agency shall prepare a subsequent or supplemental EIR. If the incremental changes of the Modified Project result in no impacts and/or minor technical additions or additions, the lead agency shall prepare an addendum. Therefore, the analysis in Section 5.0 will determine whether a supplemental/subsequent EIR or addendum is the appropriate means to analyze the Modified Project. The bases for findings listed in the Environmental Checklist are explained in Section 5.0, *Environmental Analysis*.

4.4.1 Terminology Used in the Checklist

For each question listed in the Environmental Checklist, a determination of the level of significance of the impact is provided. Impacts are categorized in the following categories:

Substantial Change in Project or Circumstances Resulting in New Significant Effects. A Subsequent EIR is required when 1) substantial project changes are proposed or substantial changes to the circumstances under which the project would be undertaken, 2) those changes would result in new significant environmental effects or a substantial increase in the severity of previously identified significant effects, and 3) project changes require major revisions to the EIR (CEQA Guidelines § 15162).

New Information Showing Greater Significant Effects than Previous EIR. A Subsequent EIR is required if new information of substantial importance that was not known and could not have been known with the exercise of reasonable diligence at the time the EIR was certified shows 1) the project would have one or more significant effects not discussed in the EIR; 2) significant effects previously examined would be substantially more severe than shown in the EIR; or 3) mitigation measures or alternatives previously found not to be feasible would in fact be feasible (or new mitigation measures or alternatives are considerably different) and would substantially reduce one or more significant effects of the project, but the project proponents decline to adopt the mitigation measure or alternative (CEQA Guidelines § 15162).

New Mitigation or Alternative to Reduce Significant Effect is Declined. A Subsequent EIR is required if new information of substantial importance that was not known and could not have been known with the exercise of reasonable diligence at the time the EIR was certified shows that mitigation measures or alternatives previously found not to be feasible would in fact be feasible (or new mitigation measures or

4. Environmental Checklist

alternatives are considerably different) and would substantially reduce one or more significant effects of the project, but the project proponents decline to adopt the mitigation measure or alternative (CEQA Guidelines §15162). A Supplement to an EIR can be prepared if the criterion for a Subsequent EIR is met, but only minor additions or changes would be necessary to make the EIR adequately apply to the Modified Project (CEQA Guidelines § 15163).

Minor Technical Changes or Additions. An Addendum to the EIR is required if only minor technical changes or additions are necessary and none of the criteria for a subsequent EIR are met (CEQA Guidelines § 15164).

No Impact. A designation of No Impact is given when the Modified Project would cause no changes to the environment as compared to the original project analyzed in the EIR.

5. Environmental Analysis

This section provides evidence to substantiate the conclusions in the environmental checklist. The section will briefly summarize the conclusions of the 2010 Skyline Ranch EIR and then discuss whether or not the Modified Project is consistent with the findings contained in the Skyline Ranch EIR. Mitigation measures referenced are from the Skyline Ranch EIR.

5.1 AESTHETICS

5.1.1 Summary of Impacts Identified in the Certified EIR

This section summarizes the analysis contained in Section 4.E, *Visual Qualities*, of the 2010 Certified EIR.

Construction Impacts

Development of the Approved Project would cause temporary visual impacts during construction, which is estimated to last approximately seven years. The grading operation would remove native vegetation and alter the natural landform of approximately 622 acres onsite. Other site preparation activities include roads, sewers, water, streets, dry utilities, entry monumentation, and landscaping/irrigation. These temporary activities would substantially degrade the visual quality of the site, mostly impacting the neighborhood to the southwest of the proposed development area due to the higher elevation of this neighborhood relative to the site. Single-family communities west of the project site near the intersection of Whites Canyon Road and the proposed Skyline Ranch Road would also observe landform alterations. Impacts of construction activities would be **significant and unavoidable** until construction activities are completed.

Visual Impacts

Photo simulations were prepared to illustrate the conceptual design, massing, and views of the Approved Project from short-range and long-range views. To reduce significant impacts on views toward the project site, onsite landscaping mitigation is provided. However, impacts associated with the change in views from the existing residential neighborhood to the west—particularly from residences west of the project site that are oriented to the east—would remain **significant and unavoidable** due to the alteration of a scenic vista and the modification of hillsides and ridgelines.

Light and Glare

Implementation of the Approved Project would introduce new sources of light and glare to the project site and surrounding areas. Project lighting would be typical of lighting in other residential neighborhoods south and west of the project site. Lighting will be shielded and concentrated along streets to the interior of the development area, rather than along the edges of the site. Lighting impacts would be less than significant.

5. Environmental Analysis

Glare is primarily a daytime occurrence caused by the reflection of sunlight or artificial light by highly polished surfaces, such as window glass or reflective materials and, to a lesser degree, from broad expanses of light-colored surfaces. The Approved Project would use building materials that are nonreflective in nature and typical of residential development throughout the area. Therefore, the project was not anticipated to have a significant impact associated with glare.

5.1.2 Impacts Associated with the Proposed Project

Would the Modified Project:

Issues	Substantial Change in Project or Circumstances Resulting in New Significant Effects	New Information Showing Greater Significant Effects than Previous EIR	New Mitigation or Alternative to Reduce Significant Effect is Declined	Minor Technical Changes or Additions	No Impact
a) Have a substantial adverse effect on a scenic vista?				X	
b) Be visible from or obstruct views from a regional riding or hiking trail?				X	
c) Substantially damage scenic resources, including, but not limited to, trees, rock outcroppings, and historic buildings within a state scenic highway?					X
d) Substantially degrade the existing visual character or quality of the site and its surroundings because of height, bulk, pattern, scale, character, or other features?				X	
e) Create a new source of substantial shadows, light, or glare which would adversely affect day or nighttime views in the area?				X	

Comments:

a) Have a substantial adverse effect on a scenic vista?

Minor Technical Changes or Additions. Impacts to visual quality are due to the alteration of landform and development of rural hillside areas. As approved, the character of the Skyline Ranch master-planned residential community has a scenic backdrop, primarily to the north and northeast of natural open space consisting of vegetated steep terrain, canyons, and ridgelines. The proposed modifications to the Approved Project would consist of realigning Skyline Ranch Road, reducing residential lots by 40 units (but including 284 units of age-qualified homes and a community center), modifying housing product types, relocating and expanding park and recreation center sites, and extending multipurpose trails and bike lanes. These modifications would occur within the development footprint of the Approved Project, and no additional grading or construction would occur outside of the developable area analyzed in the previously certified EIR. Grading quantities would be reduced from 20.8 million cy each of cut and fill to 17.1 million cy of cut and 16.9 million cy of fill under the Modified Project.

5. Environmental Analysis

The Modified Project would shift the location of the residential lots within the project site farther north, away from existing uses to the south and west of the site (see Figure 4, *Approved TTM vs. Proposed Concept Plan*). Therefore, views from the south and west toward the Skyline Ranch community and rural hillsides to the north would be improved in comparison to the Approved Project. Figures 8 through 10, *Visual Simulation Comparison*, compare the visual impacts of the Approved and Modified Projects' development. The development footprint of the Approved Project is shown in purple, and the footprint of the Modified Project is shown in orange. Seven viewpoints from the south and west of the project site were chosen to represent major public views toward the site and are numbered on Figures 8 through 10:

1. Sierra Highway looking northeast
2. Sierra Highway looking west
3. Hawks Ridge Drive and Canyon Creek Drive looking west
4. Via Princessa and Whites Canyon looking north
5. Todd Longshore Park looking east
6. Canyon high School looking east
7. Canyon Springs Elementary School looking northeast

Table 4 compares the seven viewsheds' impact percentages based on development of the Approved Project and that of the Modified Project. The impact percentages compare how much of the complete viewshed (100 percent) is changed by development of the Approved and Modified Projects.

Table 4 Visual Simulation Impacted Comparison

Viewshed No.	Location	Impact Percentage		Percentage Change
		Approved Project	Modified Project	
1	Sierra Highway looking northeast	2.72%	2.88%	0.16%
2	Sierra Highway looking west	5.07	6.08	1.01
3	Hawks Ridge Drive and Canyon Creek Drive looking west	4.77	1.12	-3.65
4	Via Princessa and Whites Canyon looking north	1.36	0.85	-0.51
5	Todd Longshore Park looking east	3.14	1.28	-1.86
6	Canyon High School looking east	3.30	1.05	-2.25
7	Canyon Springs Elementary School looking northeast	4.15	2.06	-2.09

All seven views toward the project site would have a decrease in impact percentage with the exception of Views 1 and 2 from Sierra Highway. However, this is because the Modified Project does not require expansive grading of the hillsides shown in Views 1 and 2, and would actually preserve the natural topography of the hills. Also, the changes in percentage impacted for Views 1 and 2 are nominal, approximately 0.2 and 1.0 percent, respectively.

Overall, scenic views looking toward the residential community under the Modified Project would be less impacted and remain more in character with existing conditions compared to development of the Approved

5. Environmental Analysis

Project. Therefore, the proposed modifications would have no new significant impact to scenic vistas in the project area.

b) Be visible from or obstruct views from a regional riding or hiking trail?

Minor Technical Changes or Additions. The Bouquet Canyon Trail, Mint Canyon Trail, and one unnamed trail are in the vicinity of the project site and are part of the approved adopted County trail system detailed in the Santa Clarita Valley Area Plan. The Bouquet Canyon Trail is approximately one mile northwest of the site and generally follows Bouquet Canyon Road. The Mint Canyon Trail is immediately north and northeast of the project site in an area proposed to remain as open space and adjacent to Sierra Highway and Sand Canyon Road.

Similar to the Approved Project, the Modified Project would include a trail easement of approximately 2.2 miles that would connect to the Mint Canyon Trail to the north and the existing Plum Canyon fire road to the south. The proposed development under the Approved and Modified Projects would not be visible from the Mint Canyon or Bouquet Canyon trails due to irregular topography looking southerly toward the developable area. Therefore, modifications to the Approved Project would have no new significant impacts to regional trails.

c) Substantially damage scenic resources, including, but not limited to, trees, rock outcroppings, and historic buildings within a state scenic highway?

No Impact. The project site is not visible from a designated scenic highway, and the Modified Project would not impact scenic resources within a state scenic highway (Caltrans 2011). The incremental differences of the proposed modifications to the recorded map do not result in substantial impacts to scenic resources. Therefore, no new significant damage to scenic resources would occur as a result of the Modified Project or changed circumstances.

d) Substantially degrade the existing visual character or quality of the site and its surroundings because of height, bulk, pattern, scale, character, or other features?

Minor Technical Changes or Additions. Skyline Ranch Road would maintain its approved roadway cross-section details, including roundabouts at intersections within the project boundary. Modifications include reducing the number of residential lots by 40 units (but including age-qualified housing and a community center) and modifying housing product types (see Tables 2 and 3). As detailed in Table 3, the Modified Project would have fewer and smaller houses compared to the Approved Project, and the lots would be shifted north within the project site, farther away from existing residential uses to the west and south. The homes would be built with a similar character to the existing suburban community. Therefore, these modifications would not degrade the visual character or quality of the proposed Skyline Ranch community.

Figure 8 - Visual Simulation Comparison - Part 1

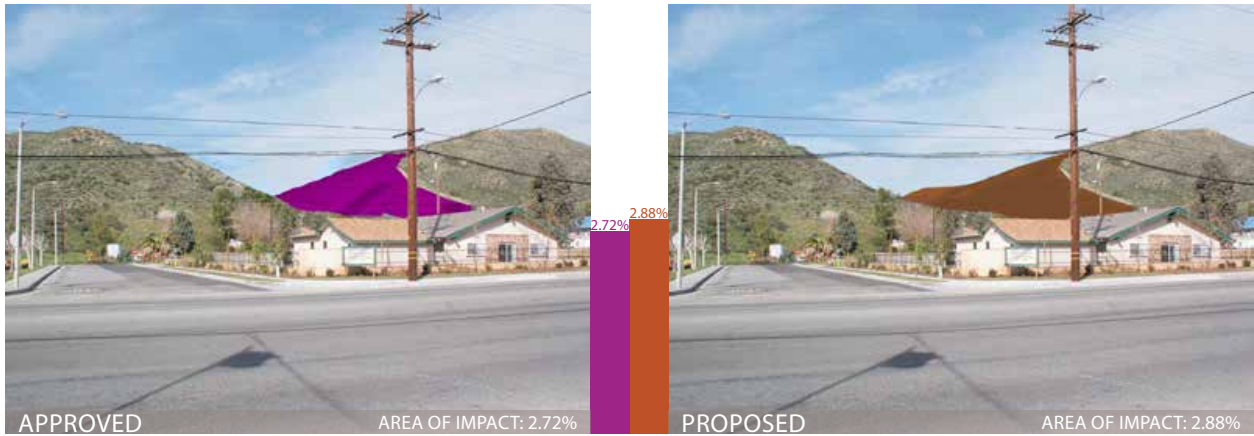

① SIERRA HIGHWAY LOOKING NORTH EAST

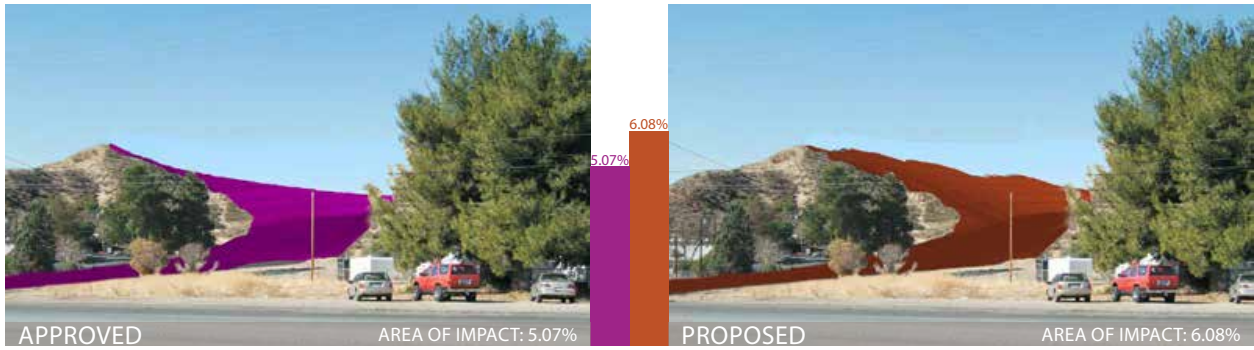

② SIERRA HIGHWAY LOOKING WEST



5. Environmental Analysis

This page intentionally left blank.

Figure 9 - Visual Simulation Comparison - Part 2



③ HAWKS RIDGE DR & CANYON CREEK DR LOOKING WEST

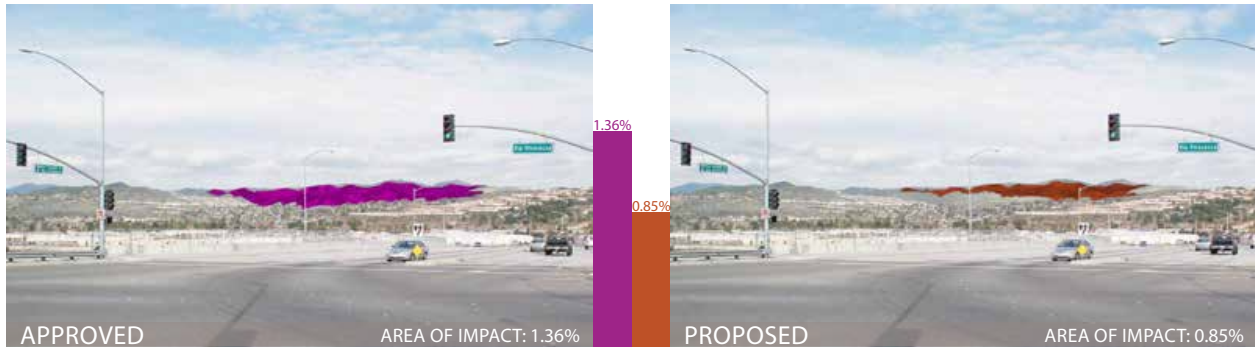

④ VIA PRINCESA & WHITES CANYON LOOKING NORTH



5. Environmental Analysis

This page intentionally left blank.

Figure 10 - Visual Simulation Comparison - Part 3

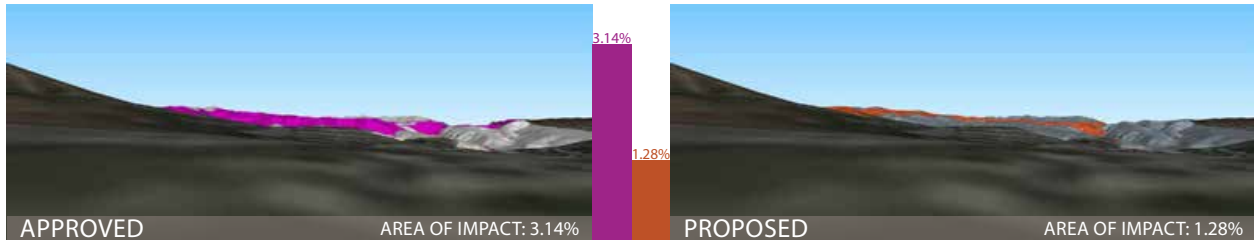

⑤ TODD LONGSHORE PARK LOOKING EAST

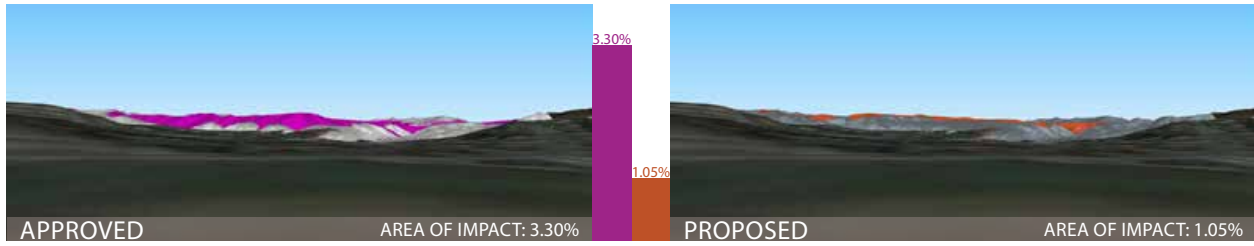

⑥ CANYON HIGH SCHOOL LOOKING EAST

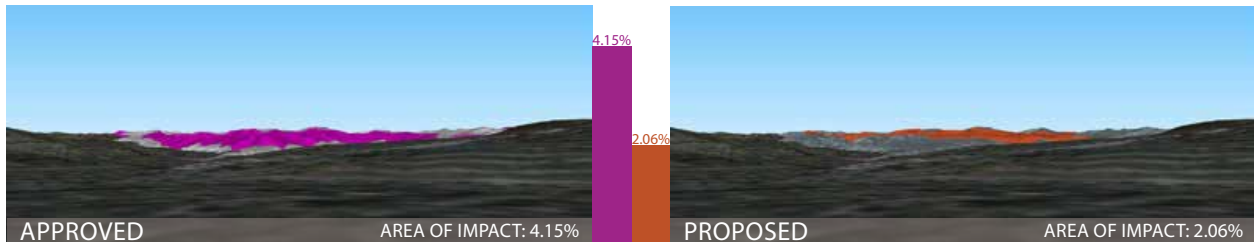

⑦ CANYON SPRINGS ELEMENTARY SCHOOL LOOKING NORTH EAST



5. Environmental Analysis

This page intentionally left blank.

5. Environmental Analysis

e) Create a new source of substantial shadows, light, or glare which would adversely affect day or nighttime views in the area?

Minor Technical Changes or Additions. Outdoor nighttime lighting in residential areas is generally limited to security lighting and street lighting. The reduced development footprint and 40-unit reduction in residential lots under the Modified Project would reduce the overall need for lighting in the developable area of the project site. Additionally, similar to the Approved Project, the Modified Project would be required to comply with the exterior lighting, signage, parking lot, and security standards of the Los Angeles County Code.

General requirements include maximum fixture heights, shielding standards, and limits on the intensity of light that can be reflected onto neighboring properties (light trespass). Compliance with existing codes would ensure that lighting would not result in outdoor illumination that would exceed established standards. Therefore, nighttime lighting and glare impacts would not be greater than those identified in the certified EIR, and impacts would remain less than significant.

5.1.3 Adopted Mitigation Measures Applicable to the Modified Project

Construction Impacts

4.E-1 During construction, the applicant or his contractors shall locate equipment, stockpiles, and staging areas out of direct public or private view to the extent feasible.

Visual Impacts

4.E-2(a) To reduce the significant aesthetic impact associated with graded slopes and paved terrace drains along the southern entrance to the project site, the slopes on both sides of proposed Skyline Ranch Road shall be revegetated and landscaped as soon as feasible following grading and roadway development. Landscaping in this area shall be selected and planted to screen proposed terrace drains from public views and to merge ornamental and native materials such that sharp contrasts in form and color with undeveloped areas are avoided.

4.E-2(b) A landscape plan for the planned residential development shall be prepared by a Landscape Architect with a plant palette that will merge ornamental and native materials such that shape contrasts in form and color are avoided with adjacent undeveloped areas. Trees and shrubs on streets, slopes and ridgelines should emphasize mounded rather than columnar forms (such as palm trees and cypress). Plantings on the hillsides to the south and east of the entry road shall be specifically selected, sized, and placed to soften angular forms created by grading at the interface of manufactured slopes and natural hillsides. Furthermore, every effort shall be made as grading plans are finalized and during grading to create rounded landforms that are generally reflective of the natural topography of the area. Planting of common landscape areas shall be undertaken as soon as possible following grading to avoid prolonged view degradation. Landscaping on the site shall be routinely maintained by a homeowners association and/or through Covenants, Conditions and Restrictions (CC&Rs)

5. Environmental Analysis

throughout the life of the project. The landscape plan shall be subject to review and approval by the County prior to issuance of any grading permits.

5.1.4 Level of Significance After Mitigation

The Modified Project would only result in minor technical changes or additions to the previously certified EIR, and would not result in significant impacts upon implementation of applicable regulatory requirements and mitigation measures.

5.2 AGRICULTURE AND FOREST RESOURCES

5.2.1 Summary of Impacts Identified in the Certified EIR

Impacts to agricultural resources were closed out in the Initial Study prepared for the 2010 Certified EIR. The Approved Project would have no impact on prime, unique, or farmland of Statewide importance; would not conflict with existing zoning for agricultural use or with a Williamson Act contract; would not conflict with existing zoning for forest land or timberland; would not result in the loss of forest land or conversion of forest land to non-forest use; and would not involve other changes to the existing environment that may involve the conversion of either farmland or forest land to non-farm or non-forest land.

5.2.2 Impacts Associated with the Proposed Project

Would the Modified Project:

Issues	Substantial Change in Project or Circumstances Resulting in New Significant Effects	New Information Showing Greater Significant Effects than Previous EIR	New Mitigation or Alternative to Reduce Significant Effect is Declined	Minor Technical Changes or Additions	No Impact
a) Convert Prime Farmland, Unique Farmland, or Farmland of Statewide Importance (Farmland), as shown on the maps prepared pursuant to the Farmland Mapping and Monitoring Program of the California Resources Agency, to non-agricultural use?					X
b) Conflict with existing zoning for agricultural use, with a designated Agricultural Opportunity Area, or with a Williamson Act contract?					X
c) Conflict with existing zoning for, or cause rezoning of, forest land (as defined in Public Resources Code § 12220 (g)), timberland (as defined in Public Resources Code § 4526), or timberland zoned Timberland Production (as defined in Government Code §51104(g))?					X

5. Environmental Analysis

Issues	Substantial Change in Project or Circumstances Resulting in New Significant Effects	New Information Showing Greater Significant Effects than Previous EIR	New Mitigation or Alternative to Reduce Significant Effect is Declined	Minor Technical Changes or Additions	No Impact
d) Result in the loss of forest land or conversion of forest land to non-forest use?					X
e) Involve other changes in the existing environment which, due to their location or nature, could result in conversion of Farmland, to non-agricultural use or conversion of forest land to non-forest use?					X

Comments:

- a) **Convert Prime Farmland, Unique Farmland, or Farmland of Statewide Importance (Farmland), as shown on the maps prepared pursuant to the Farmland Mapping and Monitoring Program of the California Resources Agency, to non-agricultural use?**

No Impact. The Modified Project would not involve changes outside of the development footprint already analyzed in the 2010 Certified EIR. Therefore, similar to the Approved Project, the Modified Project would have no impact on prime farmland, unique farmland, or farmland of statewide importance.

- b) **Conflict with existing zoning for agricultural use, or a Williamson Act contract?**

No Impact. Based on the Santa Clarita Valley Area Plan Zoning Map, the developable area of the project site (southern 492 acres) is zoned R-1 (Single-family residence) and does not have land under Williamson Act contracts (Los Angeles 2012b, DOC 2013). The remaining undevelopable area of the project site is zoned A-1-2 (Light agriculture) and A-2-2 (Heavy agriculture); however, no development is proposed in these areas. Thus, no impact would occur.

- c) **Conflict with existing zoning for, or cause rezoning of, forest land (as defined in Public Resources Code section 12220(g)), timberland (as defined by Public Resources Code section 4526), or timberland zoned Timberland Production (as defined by Government Code section 51104(g))?**

No Impact. Although the northern portion of the project site is zoned A-1-2 and A-2-2, no development is proposed in these areas. Therefore, no impact would occur.

- d) **Result in the loss of forest land or conversion of forest land to non-forest use?**

No Impact. See response to Section 5.2.2(c), above.

- e) **Involve other changes in the existing environment which, due to their location or nature, could result in conversion of Farmland, to non-agricultural use or conversion of forest land to non-forest use?**

No Impact. See response to Section 5.2.2(b) and (c), above.

5. Environmental Analysis

5.2.3 Adopted Mitigation Measures Applicable to the Modified Project

No mitigation measures related to agricultural resources were outlined in the 2010 Certified EIR.

5.2.4 Level of Significance After Mitigation

The Modified Project would have no impact on agriculture or forestry resources.

5.3 AIR QUALITY

5.3.1 Summary of Impacts Identified in the Certified EIR

This section summarizes the analysis contained in Section 4.H, *Air Quality*, of the 2010 Certified EIR.

Construction Impacts

Construction of the Approved Project has the potential to create air quality impacts through the use of heavy-duty construction equipment and through vehicle trips generated from construction workers traveling to and from the project site. In addition, fugitive dust emissions would result from demolition and construction activities. Based on project construction emissions modeling, regional emissions from construction phases would exceed the South Coast Air Quality Management District (SCAQMD) daily significance thresholds for PM₁₀, PM_{2.5}, CO, NO_x, and volatile organic compounds (VOC). Regional construction emissions for SO_x would not exceed daily significance thresholds. Therefore, project construction activities would result in a temporary but **significant and unavoidable** regional air quality impact.

Based on localized construction air quality analysis, development of the Approved Project could cause exceedance of the PM₁₀ and PM_{2.5} incremental thresholds but would not cause ambient concentrations to exceed NO₂ or CO ambient air quality standards. Localized impacts to PM₁₀ and PM_{2.5} would be **significant and unavoidable**.

An assessment of toxic air contaminants (i.e., diesel particulate emissions) yielded that the project would not emit carcinogenic or toxic air contaminants that individually or cumulatively exceed the maximum individual cancer risk of ten in one million. Additionally, compliance with SCAQMD Rule 1166 and 1113 would limit the amount of VOC emissions from potentially contaminated soils or architectural coating sand solvents. Thus, no construction activities or building materials would create objectionable odors.

Operational Impacts

Operational emissions would be generated by area and mobile sources as a result of normal day-to-day activities on the project site. At buildout and in full operation, the project would generate total emissions that would exceed the SCAQMD recommended thresholds for regional CO, VOC, NO_x, PM_{2.5}, and PM₁₀. Thus, operational emissions would result in **significant and unavoidable** air quality impacts. Additionally, the Approved Project would contribute to regionwide emissions on a cumulative basis, and therefore, the project's contribution to cumulative air quality impact is concluded to be **significant and unavoidable**.

5. Environmental Analysis

Additionally, single-family residences on the project site would be occupied while later phases of construction activities would be occurring. Concurrent construction and operational emissions would exceed SCAQMD daily thresholds for CO, NO_x, PM₁₀, PM_{2.5}, and VOC. Thus, regional air quality impacts from concurrent construction and operational activities would be **significant and unavoidable**.

Based on traffic intersection analysis for local area CO impacts, the Approved Project would not have a significant impact upon 1-hour or 8-hour local CO concentrations due to mobile source emissions (primarily vehicle exhaust). Therefore, sensitive receptors would not be significantly affected by CO emissions generated by the net increase in traffic. Localized operational air quality impacts would be less than significant.

The Approved Project would not generate substantial quantities of toxic air contaminants (TACs). Any air pollutants to the project vicinity which would be well below any levels that would result in a significant impact on human health. As such, no significant impact on human health would occur.

The Approved Project does not include any uses identified by the SCAQMD as being associated with odors. Therefore, the Approved Project would not create adverse odors as discussed above and would have no impact related to objectionable odors.

AQMP Consistency

The determination of air quality management plan (AQMP) consistency is primarily concerned with the long-term influence of the Approved Project on air quality in the Southern California Air Basin (SoCAB) and whether or not a project will exceed the assumptions utilized in preparing the AQMP. Although the project may cause an exceedance of the localized PM₁₀ and PM_{2.5} significance criteria, this exceedance would be short-term in nature. This impact would only occur during the grading phase of project construction and would not have a long-term impact on the region's ability to meet state and federal air quality standards. In addition, the Approved Project would comply with SCAQMD Rule 403 and would implement all feasible mitigation measures for control of PM₁₀ and PM_{2.5}. Also, the Approved Project would be consistent with the goals and policies of the AQMP for control of fugitive dust. Therefore, the Approved Project would be consistent with AQMP strategies to bring the SoCAB into PM₁₀ and PM_{2.5} attainment. With regard to the second criterion, the Approved Project is well within and consistent with the population growth for the subregion identified in the Southern California Association of Governments (SCAG) Regional Transportation Plan and subsequent updates. Consequently, the Approved Project would be consistent with local air quality plans and policies.

5.3.2 Impacts Associated with the Modified Project

Regulatory Background

The environmental and regulatory settings for the Modified Project have changed since certification of the 2010 Certified EIR. The following discussion is provided to update conditions relative to development of the Modified Project.

5. Environmental Analysis

The SoCAB is designated nonattainment for O₃, PM_{2.5}, PM₁₀, and lead (Los Angeles County only) under the California and National AAQS and nonattainment for NO₂ under the California AAQS (CARB 2014a).^{1, 2} SCAQMD prepares an AQMP that details measures taken to achieve the national and California AAQS. The most recent AQMP is the 2012 AQMP.

SCAQMD Air Quality Management Plan

SCAQMD is responsible for preparing the AQMP for the SoCAB in coordination with SCAG. After the Skyline Ranch EIR was certified in 2010, SCAQMD adopted the 2012 AQMP, which employs the most up-to-date science and analytical tools and incorporates a comprehensive strategy aimed at controlling pollution from all sources, including stationary sources, on- and off-road mobile sources, and area sources. It also addresses several state and federal planning requirements, incorporating new scientific information, primarily in the form of updated emissions inventories, ambient measurements, and new meteorological air quality models. The 2012 AQMP builds upon the approach identified in the 2007 AQMP for attainment of federal PM and ozone standards and highlights the significant amount of reductions needed. It also highlights the urgent need to engage in interagency coordinated planning to identify additional strategies, especially in the area of mobile sources, to meet all federal criteria air pollutant standards within the time frames allowed under the Clean Air Act. The 2012 AQMP demonstrates attainment of federal 24-hour PM_{2.5} standard by 2014 and the federal 8-hour ozone standard by 2023. It includes an update to the revised EPA 8-hour ozone control plan with new commitments for short-term NO_x and VOC reductions. The plan also identifies emerging issues—ultrafine (PM_{1.0}) particulate matter and near-roadway exposure and an analysis of energy supply and demand.

The SCAQMD is in the process of updating the AQMP. The 2016 AQMP will address strategies and measures to attain the 2008 federal 8-hour ozone standard by 2032 and the 2012 federal annual PM_{2.5} standard by 2021. The 2016 AQMP will also take an initial look at the 2015 federal 8-hour ozone standard. It will also update previous attainment plans for ozone and PM_{2.5} that have not yet been met (SCAQMD 2015).

¹ The California Air Resources Board (CARB) approved the SCAQMD's request to redesignate the SoCAB from serious nonattainment for PM₁₀ to attainment for PM₁₀ under the national AAQS on March 25, 2010, because the SoCAB has not violated federal 24-hour PM₁₀ standards during the period from 2004 to 2007. In June 2013, the Environmental Protection Agency (EPA) approved the State of California's request to redesignate the South Coast PM₁₀ nonattainment area to attainment of the PM₁₀ National AAQS, effective on July 26, 2013.

² CARB has proposed to redesignate the SoCAB as attainment for lead and NO₂ under the California AAQS (CARB 2013).

5. Environmental Analysis

Would the Modified Project:

Issues	Substantial Change in Project or Circumstances Resulting in New Significant Effects	New Information Showing Greater Significant Effects than Previous EIR	New Mitigation or Alternative to Reduce Significant Effect is Declined	Minor Technical Changes or Additions	No Impact
a) Conflict with or obstruct implementation of applicable air quality plans of the South Coast AQMD (SCAQMD) or the Antelope Valley AQMD?				X	
b) Violate any air quality standard or contribute substantially to an existing or projected air quality violation?				X	
c) Result in a cumulatively considerable net increase of any criteria pollutant for which the project region is non-attainment under an applicable federal or state ambient air quality standard (including releasing emissions which exceed quantitative thresholds for ozone precursors)?				X	
d) Expose sensitive receptors to substantial pollutant concentrations?				X	
e) Create objectionable odors affecting a substantial number of people?				X	

Comments:

a) Conflict with or obstruct implementation of applicable air quality plans of the South Coast AQMD (SCAQMD) or the Antelope Valley AQMD?

Minor Technical Changes or Additions. By reducing residential development, the Modified Project would reduce impacts on housing and population projections within the SCAG region and would reduce vehicle trips relative to the Approved Project since fewer homes would be developed. Similar to the Approved Project, the Modified Project would not conflict or obstruct implementation of the SCAQMD's AQMP. Impacts would be less than significant.

b) Violate any air quality standard or contribute substantially to an existing or projected air quality violation?

Minor Technical Changes or Additions. The Modified Project would develop 40 fewer residential homes and require less grading compared to the Approved Project. The Modified Project would require 17.1 million cy of cut and 16.9 million cy of fill, approximately 18 and 19 percent less cut and fill than the Approved Project. The Modified Project would also reduce the number of residential lots by 40 and would result in a decrease in vehicle trips compared to that analyzed in the 2010 Certified EIR. This would result in a decrease of construction- and operational-phase air pollutant emissions due to a decrease in area, energy, and mobile-source emissions. Overall, air quality impacts would be less than generated by the Approved Project. The incremental difference would result in a beneficial impact. Mitigation measures applied for the previous project would be applicable to the proposed project.

5. Environmental Analysis

- c) **Result in a cumulatively considerable net increase of any criteria pollutant for which the project region is non-attainment under an applicable federal or state ambient air quality standard (including releasing emissions which exceed quantitative thresholds for ozone precursors)?**

Minor Technical Changes or Additions. The SoCAB is designated nonattainment for O₃, PM₁₀, PM_{2.5}, and lead (Los Angeles County only) under the California and National AAQS, and nonattainment for NO₂ under the California AAQS (CARB 2014a). In accordance with SCAQMD methodology, any project that does not exceed or can be mitigated to less than the daily threshold values does not add significantly to a cumulative impact (SCAQMD 1993). The CalEEMod modeling included in the 2010 Certified EIR demonstrates that unmitigated concurrent operation and construction emissions associated with the Approved Project would exceed thresholds for CO, NO_x, PM₁₀, PM_{2.5}, and VOC.

The modifications to the project would result in a decrease of construction and operational air pollutant emissions compared to the Approved Project due to the decrease in residential units (40 fewer units). Mitigation measures applied for the Approved Project would also be applicable to the proposed Modified Project.

- d) **Expose sensitive receptors to substantial pollutant concentrations?**

Minor Technical Changes or Additions. Sensitive receptors near the project site include residential areas to the west and south of the site, Canyon High School, Leona Cox Community School, Montessori Preschool, Super-8 Motel, Santa Clarita Little People Daycare and Preschool, and Travel Lodge (Los Angeles 2010). As stated above, the construction activities associated with the Approved Project would expose sensitive receptors to substantial pollutant concentrations that exceed PM₁₀ and PM_{2.5} incremental thresholds. Construction equipment used to develop the Modified Project would be same as that of the Approved Project and would include, but not be limited to, concrete mixers, heavy-duty trucks, scrapers, dozers, graders, backhoes, pavers, and front-end loaders. Given that the Modified Project would reduce grading quantities, the overall development footprint, and the number of residential lots onsite, construction activities and associated pollutant concentrations would also be slightly reduced in the project area. Overall, development of the Modified Project would have a beneficial impact compared to the Approved Project.

- e) **Create objectionable odors affecting a substantial number of people?**

Minor Technical Changes or Additions. The Modified Project would not emit objectionable odors that would affect a substantial number of people. The threshold for odor is if a project creates an odor nuisance pursuant to SCAQMD Rule 402, Nuisance, which states:

A person shall not discharge from any source whatsoever such quantities of air contaminants or other material which cause injury, detriment, nuisance, or annoyance to any considerable number of persons or to the public, or which endanger the comfort, repose, health or safety of any such persons or the public, or which cause, or have a natural tendency to cause, injury or damage to business or property. The provisions of this rule shall not apply to odors emanating from agricultural operations necessary for the growing of crops or the raising of fowl or animals.

5. Environmental Analysis

The types of facilities that are considered to have objectionable odors include wastewater treatments plants, compost facilities, landfills, solid waste transfer stations, fiberglass manufacturing facilities, paint/coating operations (e.g., auto body shops), dairy farms, petroleum refineries, asphalt batch plants, chemical manufacturing, and food manufacturing facilities. Residential developments are not associated with foul odors that constitute a public nuisance; therefore, odor impacts would be less than significant.

During construction activities, equipment exhaust and application of asphalt and architectural coatings would temporarily generate odors. Any construction-related odor emissions would be temporary and intermittent, and would not affect a significant number of people. Neither the Approved Project nor the Modified Project would generate substantial odors, and impacts would be less than significant.

5.3.3 Adopted Mitigation Measures Applicable to the Modified Project

The following mitigation measures were taken directly from the 2010 Certified EIR. All of these mitigation measures apply to and would be implemented for the Modified Project. Modifications to the original mitigation measures reflect changes in current emission control technologies and are identified in ~~strikeout text~~ to indicate deletions and **underlined/bold** to signify additions.

Construction Emissions

(1) Regional Emissions

- 4.H-1(a) Develop and implement a construction management plan, as approved by the County of Los Angeles prior to issuance of a grading permit, which includes the following measures recommended by the SCAQMD to implement SCAQMD Rule 403.
- a. Ground cover shall be replaced in disturbed areas as quickly as practicable;
 - b. Soil stabilizers/dust suppressants shall be applied to inactive disturbed areas in sufficient quantity and frequency to maintain a stabilized surface;
 - c. Haul roads and site access roads shall be watered no less than three times daily;
 - d. Disturbed surfaces shall be watered no less than two times daily;
 - e. All stockpiles shall be covered with tarps as soon as practicable;
 - f. Travel speed on unpaved surfaces shall not exceed 15 miles per hour;
 - g. Provide a publicly visible sign and directly notify property owners in the vicinity of a contact person and telephone number to call regarding dust complaints; the contact person shall respond with appropriate corrective actions within 24 hours;
 - h. Prohibit construction vehicle idling in excess of 10 minutes;

5. Environmental Analysis

- i. Stockpiles, haul routes, staging locations, and parking areas shall be located as far as possible from adjacent residential uses;
 - j. Pave or place gravel on all construction access roads at least 100 feet on to the site from the main road;
 - k. Configure construction parking to minimize traffic interference;
 - l. Provide temporary traffic controls when construction activities have the potential to disrupt traffic to maintain traffic flow (e.g., signage, flag person, detours);
 - m. Schedule construction activities that affect traffic flow to off-peak hours (e.g., between 7:00 P.M. and 6:00 A.M. and between 10:00 A.M. and 3:00 P.M.);
 - n. Develop a construction traffic management plan that includes the following measures to address construction traffic that has the potential to affect traffic on public streets:
 - Consolidate truck deliveries
 - Provide temporary dedicated turn lanes for movement of construction trucks and equipment on and off of the site;
 - o. Suspend use of all construction equipment operations during second stage smog alerts. Contact the SCAQMD at 800/242-4022 for daily forecasts;
 - p. Use electricity from power poles rather than temporary fossil fuel powered generators; and
 - q. Use methanol- or natural gas-powered mobile equipment and pile drivers instead of diesel if readily available at competitive prices.
- 4.H-1(b) Maintain construction equipment and vehicle engines in good condition and in proper tune as per manufacturers' specifications and per SCAQMD rules, to minimize exhaust emissions.
- 4.H-1(c) All on-site heavy-duty construction equipment shall be equipped with diesel particulate traps as feasible.

(2) Local Emissions

Please refer to Mitigation Measures 4.H-1(a), 4.H-1(b), and 4.H-1(c) above.

Operational Emissions

(1) Regional Emissions

- 4.H-2(a) ~~Subdivisions and b~~Buildings will be required to exceed Title 24 of the California Code of Regulations (also known as the California Building Standards Code) ~~2005~~ **2016 Building and Energy Efficiency** requirements by 15 percent.

5. Environmental Analysis

4.H-2(b) Lighting for public streets, parking areas, and recreation areas shall utilize energy efficient light and mechanical, computerized or photo cell switching devices to reduce unnecessary energy usage.

(2) Concurrent Construction and Operational Activity

Please refer to Mitigation Measures 4.H-1(a), 4.H-1(b), 4.H-1(c), 4.H-2(a), and 4.H-2(b) above.

5.3.4 Level of Significance After Mitigation

The Modified Project would only result in minor technical changes or additions to the previously certified EIR, and would not result in significant impacts upon implementation of applicable regulatory requirements and mitigation measures.

5.4 BIOLOGICAL RESOURCES

5.4.1 Summary of Impacts Identified in the Certified EIR

This section summarizes the analysis contained in Section 4.C, *Biological Resources*, of the 2010 Certified EIR.

As part of the Approved Project, approximately 1,355 acres in the northern portion of the project site would be dedicated or designated natural open space and managed through the establishment of the SRCA, which includes the Plum Canyon vernal pool and four artificial pools on the southern portion of Cruzan Mesa. Additionally, the Approved Project would provide approximately 21.6 acres for preservation as a “Mitigation Exchange Area” for 21.6 acres of preserve area that would be disturbed in the adjacent Tract 46018 due to the construction of Skyline Ranch Road.

Sensitive Plant Species

Three plant species on the California Native Plant Society’s List 4 were detected onsite: Paso Robles navarretia, Peirson’s morning-glory, and Palmer’s grappling hook. However, their susceptibility to threat is considered low. The loss of these species resulting from the Approved Project is not expected to reduce regional population levels such that their existence is threatened. Therefore, impacts to these plant species are considered less than significant. Additionally, 43 acres (approximately 5,300 plants) of slender mariposa lily were mapped onsite. Only one acre (approximately 100 plants) would be impacted by the project; therefore, impacts are not considered to be substantial.

Sensitive Wildlife Species

A number of sensitive wildlife species or special-status species were either observed onsite or have the potential to occur onsite due to the presence of suitable habitat; however, considerable habitat for these species would be preserved onsite within the SRCA. Additionally, focused surveys for the Riverside fairy shrimp, San Diego fairy shrimp, and coastal California gnatcatcher did not detect any of these species within the study area. Thus, impacts to sensitive wildlife species are less than significant.

5. Environmental Analysis

Sensitive Plant Communities

Development of the project would impact coastal sage scrub (CSS), disturbed CSS, coastal sage-chaparral scrub, sycamore riparian woodland, and holly-leaved cherry scrub. Additionally, the Approved Project may result in temporary impacts to vegetation communities within a 50-foot grading buffer zone surrounding the permanent grading development footprint. Impacts to these plant communities would be significant prior to mitigation. Thus, the SRCA was proposed as part of the project to offset project impacts on the identified sensitive plant communities.

Wildlife Movement

Proposed open space areas in the northern portion of the project site would continue to foster wildlife movement between areas of the Angeles National Forest to the north and west (i.e., Lake Hughes, San Francisquito Canyon, Bouquet Canyon) and areas to the east and south (i.e., Placerita Canyon State Park, Tujunga Wash). In addition to the project's proposed SRCA, the Approved Project avoids impacts to the Cruzan Mesa, which contributes additional resources (i.e., water, foraging areas, vegetative cover) to facilitate wildlife movement. Therefore, impacts on wildlife movement corridors would be less than significant.

Jurisdictional Areas

Approximately 5.22 acres of waters of the U.S. under the jurisdiction of the Army Corps of Engineers (Corps) and Regional Water Quality Control Board (RWQCB) and 9.30 acres of streambed under the jurisdiction of the California Department of Fish and Wildlife (CDFW) would be permanently impacted by the Approved Project. Mitigation is provided to reduce impacts to these jurisdictional areas.

Oak Trees

The Approved Project would require the removal of two coast live oak trees (one onsite and one offsite in the City of Santa Clarita). The project applicant would be required to obtain oak tree removal permits from the city and County and replace the oak trees as detailed in the mitigation measure below.

5.4.2 Impacts Associated with the Modified Project

Regulatory Background

Cruzan Mesa Vernal Pools SEA

Significant Ecological Areas are officially designated areas within the County for their biological value. These areas warrant special management because they contain biotic resources that are considered rare or unique, are critical to the maintenance of wildlife, represent relatively undisturbed areas of County habitat types, or serve as linkages.

After the Skyline Ranch EIR was certified in 2010, the Santa Clarita Valley Area Plan Update: One Valley One Vision was adopted by the Board of Supervisors on November 27, 2012. As part of the updated plan, the Cruzan Mesa Vernal Pools SEA was adopted. A significant portion of the SEA is within the northern portion of the Skyline Ranch project site.

5. Environmental Analysis

The Cruzan Mesa Vernal Pools SEA includes mesas, canyons, and interior slopes, with Plum Canyon creek running east-west through the southern portion of the overall SEA. Uplands in the SEA consist of slopes and canyons supporting coastal sage scrub or scrub-chaparral vegetation. The Cruzan Mesa vernal pool complex lies within an elevated, topographically enclosed basin atop an eroded foothill between Mint and Bouquet canyons. The Plum Canyon vernal pool, situated in a landslide depression on a hillside terrace, is smaller than the Cruzan Mesa pools, but possesses the same essential vernal pool characteristics as the larger system, and the two areas together form an ecologically functional unit.

Wildlife diversity and abundance within the SEA are moderate, commensurate with the relative homogeneity of the natural open space habitat types. A number of local wildlife species are more or less dependent upon coastal sage scrub or scrub-chaparral formations, and other species are strictly limited to seasonal pool habitats. The vernal pools, when ponded, form aquatic habitats for a moderately diverse fauna of freshwater arthropods and other invertebrates, including native fairy shrimp, aquatic flies, diving beetles, water scavengers, ostracods, and snails. The only insect order presently known to have a vernal pool endemic within the SEA is Coleoptera, with one vernal pool ground beetle species thus far having been found.

Amphibians are relatively common in coastal sage scrub habitats with persistent surface hydrology during the breeding season, and the SEA supports abundant populations of Pacific chorus frog, western toad, and western spadefoot toad. At least two species of salamander may also be present within more moist areas of the surrounding canyons and chaparral.

Reptile populations in the SEA include numerous lizard species, including San Diego banded gecko, yucca night lizard, side-blotched lizard, western fence lizard, western skink, San Diego alligator lizard, coastal western whiptail, San Diego horned lizard, and silvery legless lizard. A robust snake fauna also would be expected within the SEA, including western blind snake, coachwhip (“red racer”), chaparral whipsnake, coastal patch-nosed snake, California rosy boa, San Diego gopher snake, California kingsnake, California mountain kingsnake, night snake, and southern Pacific rattlesnake.

Bird diversity within the SEA is related to habitat opportunities for year-round residents, seasonal residents, migrating raptors, and song birds. Open coastal sage scrub hosts a suite of birds typical of such sites at lower elevations over most of the coastal slopes of Southern California. The most productive sites for resident coastal sage scrub and chaparral birds are around riparian and freshwater systems, which also attract large numbers of migrants during spring and fall. The vernal pools attract moderate numbers of migrating waders and waterfowl, and provide important winter foraging areas for resident and migratory birds of prey. Coastal sage and chaparral birds resident or breeding within the SEA include ashy rufous-crowned sparrow, Bell’s sparrow, black-chinned sparrow, lark sparrow, California thrasher, spotted towhee, California towhee, phainopepla, northern mockingbird, lazuli bunting, and several species of hummingbird, with additional species (western meadowlark, California horned lark, and perhaps also savannah and grasshopper sparrows) nesting and foraging in the grassland and ruderal habitats surrounding the vernal pools. Birds of prey observed around the vernal pools include red-tailed hawk, northern harrier, white-tailed kite, prairie falcon, and golden eagle. Barn owl, great horned owl, and common raven all nest in the cliffs surrounding Cruzan Mesa.

5. Environmental Analysis

Would the Modified Project:

Issues	Substantial Change in Project or Circumstances Resulting in New Significant Effects	New Information Showing Greater Significant Effects than Previous EIR	New Mitigation or Alternative to Reduce Significant Effect is Declined	Minor Technical Changes or Additions	No Impact
a) Have a substantial adverse effect, either directly or through habitat modifications, on any species identified as a candidate, sensitive, or special status species in local or regional plans, policies, or regulations, or by the California Department of Fish and Wildlife (CDFW) or U.S. Fish and Wildlife Service (USFWS)?				X	
b) Have a substantial adverse effect on any sensitive natural communities (e.g., riparian habitat, coastal sage scrub, oak woodlands, non-jurisdictional wetlands) identified in local or regional plans, policies, and regulations or by CDFW or USFWS?				X	
c) Have a substantial adverse effect on federally protected wetlands (including, but not limited to, marshes, vernal pools, coastal wetlands, and drainages) or waters of the United States, as defined by § 404 of the Clean Water Act or California Fish and Wildlife Code § 1600, et seq. through direct removal, filling, hydrological interruption, or other means?				X	
d) Interfere substantially with the movement of any native resident or migratory fish or wildlife species or with established native resident or migratory wildlife corridors, or impede the use of native wildlife nursery sites?				X	
e) Convert oak woodlands (as defined by the state, oak woodlands are oak stands with greater than 10% canopy cover with oaks at least 5 inch in diameter measured at 4.5 feet above mean natural grade) or otherwise contain oak or other unique native trees (junipers, Joshuas, southern California black walnut, etc.)?				X	
f) Conflict with any local policies or ordinances protecting biological resources, including Wildflower Reserve Areas (L.A. County Code, Title 12, Ch. 12.36), the Los Angeles County Oak Tree Ordinance (L.A. County Code, Title 22, Ch. 22.56, Part 16), the Significant Ecological Areas (SEAs) (L.A. County Code, Title 22, § 22.56.215), and Sensitive Environmental Resource Areas (SERAs) (L.A. County Code, Title 22, Ch. 22.44, Part 6)?				X	
g) Conflict with the provisions of an adopted state, regional, or local habitat conservation plan?				X	

5. Environmental Analysis

Comments:

- a) **Have a substantial adverse effect, either directly or through habitat modifications, on any species identified as a candidate, sensitive, or special status species in local or regional plans, policies, or regulations, or by the California Department of Fish and Wildlife (CDFW) or U.S. Fish and Wildlife Service (USFWS)?**

Minor Technical Changes or Additions. The Modified Project would include a realignment of Skyline Ranch Road, reduction of 40 residential lots (but inclusion of age-qualified homes and a community center), modifications to housing product types, relocation and expansion of park and recreation center sites, and extension of multipurpose trails and bike lanes. These modifications would be within a reduced 492-acre development footprint compared to the 622-acre footprint of the Approved Project. Additionally, the proposed 1,355-acre SRCA would preserve suitable habitat for sensitive and special status species within the project site. Thus, no new significant impacts or impacts of greater severity than those previously identified in 2010 Certified EIR would occur.

- b) **Have a substantial adverse effect on any sensitive natural communities (e.g., riparian habitat, coastal sage scrub, oak woodlands, non-jurisdictional wetlands) identified in local or regional plans, policies, and regulations or by CDFW or USFWS?**

Minor Technical Changes or Additions. As stated above, the Modified Project would consist of minor modifications within the 622-acre development footprint of the previously analyzed 2010 Certified EIR. Developable acres would be further reduced to 492 acres under the Modified Project, and the proposed SRCA would preserve 1,355 acres of natural plant habitat onsite. Therefore, no new significant impacts than previously identified would occur.

- c) **Have a substantial adverse effect on federally protected wetlands (including, but not limited to, marshes, vernal pools, coastal wetlands, and drainages) or waters of the United States, as defined by §404 of the Clean Water Act or California Fish and Wildlife Code §1600, et seq. through direct removal, filling, hydrological interruption, or other means?**

Minor Technical Changes or Additions. Development of the Modified Project would be within the 622-acre footprint of the Approved Project previously analyzed and mitigated for in the 2010 Certified EIR. The proposed SRCA would preserve jurisdictional areas of the Corps, RWQCB, and CDFW vernal pools and artificial pool habitats, as detailed in the Habitat Mitigation and Monitoring Plan for the Approved Project. No new significant impacts would occur under the Modified Project.

- d) **Interfere substantially with the movement of any native resident or migratory fish or wildlife species or with established native resident or migratory wildlife corridors, or impede the use of native wildlife nursery sites?**

Minor Technical Changes or Additions. The modifications to the Approved Project would occur within the development footprint previously analyzed in the 2010 Certified EIR. The proposed SRCA would preserve approximately 1,355 acres of contiguous open space, which would protect wildlife movement within and through the project site. Similar to the Approved Project, the Modified Project would not impact the

5. Environmental Analysis

Cruzan Mesa vernal pools that are frequented by migrating waterfowl. Thus, no new substantial impacts would occur.

- e) **Convert oak woodlands (as defined by the state, oak woodlands are oak stands with greater than 10% canopy cover with oaks at least 5 inch in diameter measured at 4.5 feet above mean natural grade) or otherwise contain oak or other unique native trees (junipers, Joshuas, southern California black walnut, etc.)?**

Minor Technical Changes or Additions. Similar to the Approved Project, development of the Modified Project would require the removal of the one isolated mature coast live oak tree onsite that has a 32-inch diameter at breast height, and also potentially remove the one coast live oak trees offsite near the proposed installation of a 78-inch storm drain in the City of Santa Clarita. Although the offsite coast live oak is not within the alignment the storm drain, trenching required for the installation of the storm drain falls within the drip line of the tree and could damage the root system. Therefore, the developer would be required to obtain oak tree removal permits from both the County and city. Mitigation from the 2010 EIR would also require oak tree restoration onsite. Thus, the Modified Project would not introduce new substantial impacts.

- f) **Conflict with any local policies or ordinances protecting biological resources, including Wildflower Reserve Areas (L.A. County Code, Title 12, Ch. 12.36), the Los Angeles County Oak Tree Ordinance (L.A. County Code, Title 22, Ch. 22.56, Part 16), the Significant Ecological Areas (SEAs) (L.A. County Code, Title 22, § 22.56.215), and Sensitive Environmental Resource Areas (SERAs) (L.A. County Code, Title 22, Ch. 22.44, Part 6)?**

Minor Technical Changes or Additions. As stated above, the County of Los Angeles has an oak tree ordinance (Los Angeles County Code Sections 22.56.2050 through 22.56.2260) that prohibits removal or damaging of oak trees and includes guidelines to avoid impacts to oak trees and their protected zones. The project applicant would be required to obtain oak tree removal permits to remove the two oak trees that would be impacted by development.

The County also has a wildflower reserve area ordinance, which protects wildflowers in designated areas, identified in the County code by section, township, and range numbers (Los Angeles County Code § 12.36.020). The project site is not in any of the areas identified as wildflower reserve areas. Therefore, no impacts would occur.

A significant portion of the Cruzan Mesa Vernal Pools SEA falls within the northern portion of the project site. However, the development footprint of both the Approved and Modified Projects would be outside of the boundary, and no impact would occur to the SEA.

Overall, the Modified Project consists of minor technical changes to the Approved Project. No significant impacts to local policies or ordinances protecting biological resources would occur.

- g) **Conflict with the provisions of an adopted state, regional, or local habitat conservation plan?**

Minor Technical Changes or Additions. As stated above, a significant portion of the Cruzan Mesa Vernal Pools SEA falls within the northern portion of the project site. However no development would occur within

5. Environmental Analysis

the SEA boundary. The proposed SRCA would preserve the northern 1,355 acres of the project site as open space. No new substantial impacts would occur under the Modified Project.

5.4.3 Adopted Mitigation Measures Applicable to the Modified Project

Sensitive Vegetation Communities

4.C-1 Mitigation for grading and fuel modification impacts (calculated 200 feet beyond the limits of grading) to 467.9 acres of combined coastal sage scrub and disturbed coastal sage scrub (452.3 acres within on- and off-site, and 15.6 acres within on- and off-site fuel modification zones), 77.0 acres of coastal sage-chaparral scrub (69.9 acres within on- and off-site grading and 7.1 acres within on- and off-site fuel modification zones), and 2.8 acres of holly-leaved cherry scrub (2.1 acres within on-site grading and 0.7 acre within on- and off-site fuel modification zones) shall be provided by establishing a 1,355 acre conservation area [Skyline Ranch Conservation Area (SRCA)] within the northern portion of the study area as shown in Figure 2-3, Aerial View-Development and Conservation Area, of the Skyline Ranch EIR. The applicant shall cause the preservation of this 1,355-acre area through either a Declaration of Restrictions or a Conservation Easement, or dedication or transfer of the land to a conservation organization committed to the preservation of the land in perpetuity. A Declaration of Restrictions, Conservation Easement, or similar recorded instrument shall be placed and recorded in this area to ensure its long-term preservation. The applicant shall arrange for the long-term management of the property to ensure the long-term persistence of the property's biological resources through a nonprofit organization, conservation-oriented entity, or entity with experience in biological resource conservation approved by the County. The applicant shall provide long-term funding to assure the management of the property to protect its biological resources in perpetuity. The SRCA includes approximately 623.9 acres of coastal sage scrub, 115.8 acres of disturbed coastal sage scrub, 248.6 acres of coastal sage-chaparral scrub, and 10.6 acres of holly-leaved cherry scrub. This area shall be preserved as natural open space. These 1,355 acres provide substantial ecological value based on the quantity, quality, and regional value of the habitats preserved.

Establishment of the 1,355-acre SRCA shall achieve the following performance standards:

1. Provision of sufficient quantity of habitat to offset vegetation impacts associated with the proposed project. When considering coastal sage scrub, disturbed coastal sage scrub, coastal sage-chaparral scrub, and holly-leaved cherry scrub collectively, this 1,355-acre area will provide close to 2:1 preservation of like and contiguous habitats [1,354.6 acres preserved vs. 642.1 acres impacted (621.7 acres impacted by grading and 20.4 acres impacted by fuel modification)]. Preserved habitats are similar to those impacted by the project and most vegetation communities (with the exception of sycamore woodland), regionally common species, and special status plant and wildlife species impacted by the project are represented within the SRCA.

5. Environmental Analysis

2. An on-going maintenance and management program shall be adequately funded and implemented to ensure the long-term integrity of biological resources within the 1,355-acre SRCA. Direct and indirect degradation of habitat shall be prevented in part through steep topography that separates the SRCA from the proposed development area and through the prohibition or restriction of uses within the SRCA.
3. The SRCA shall include signage, where appropriate, and other management practices to discourage off-road vehicles, domestic pets, and other activities harmful to natural lands.
4. Any continued use of lands within the SRCA (such as film-making) shall be subject to approval by the SRCA habitat manager and restricted to uses that are not incompatible with the resource conservation objectives of the SRCA.
5. A 21.6-acre Mitigation Exchange Area shall be provided to replace the 21.6 acres of preserve area that would be disturbed within Tract 46018 due to the construction of Skyline Ranch Road. This shall be established separately from the SRCA through an agreement between the applicant, Shapell-Monteverde Partnership (owner of the recorded Tract 46018), the Army Corps of Engineers, and the County of Los Angeles.
6. Following grading operations any areas that have been disturbed within the 50-foot grading buffer zone; which includes coastal sage scrub (10.7 acres), disturbed coastal sage scrub (6.1 acres), coastal sage-chaparral scrub (3.3 acres), non-native grassland (1.8 acres), disturbed (0.8 acres), holly-leaved cherry scrub (0.7 acres) and sycamore riparian woodland (0.2 acres), shall be restored to pre-graded conditions by a qualified biologist. Restoration shall be designed to provide the same vegetation resources and habitat value as those removed within the buffer zone. At the end of all project grading, proposed restoration actions within the buffer zone (if necessary) shall be presented in a restoration plan provided to the County. Following approval by the County, restoration shall be initiated and completed according to the approved restoration plan.

Mitigation for impacts to sycamore riparian woodland (including 96 sycamore trees and nine Fremont cottonwood trees) is discussed in Mitigation Measure 4.C-2.

Jurisdictional Areas

4.C-2 As detailed in the Habitat Mitigation and Monitoring Plan (HMMP) prepared by Glenn Lukos Associates (GLA), mitigation for impacts to 5.22 acres of Army Corps of Engineers (Corps) and **Regional Water Quality Control Board (RWQCB)** jurisdiction, none of which consists of jurisdictional wetlands, and 9.30 acres of California Department of Fish and ~~Game~~ **Wildlife (CDFGW)** jurisdiction (of which 2.91 acres is vegetated riparian habitat) shall be accomplished by the applicant through the following:

1. The preservation of 1,355 acres of natural open space within the SRCA through the use of a conservation easement or the dedication of such land to a qualified conservation organization. This 1,355-acre area includes approximately 5.35 acres of Corps and

5. Environmental Analysis

RWQCB jurisdiction, none of which consists of jurisdictional wetlands and approximately 5.71 acres of CDFG~~W~~ jurisdiction (of which 0.31 acre is vegetated riparian habitat).

2. The preservation of 1.53 acres of southern vernal pool and artificial pool habitats within the SRCA subject to RWQCB jurisdiction.
3. On-site establishment of 7.27 acres of sycamore/cottonwood riparian woodland within Plum Canyon.

As described further in the HMMP, the proposed 7.27-acre sycamore riparian woodland (mitigation site) will be established within portions of Plum Canyon on-site within the SRCA as shown in ~~Figure 4.C-7, Proposed Conservation and Mitigation Areas, on page 4.C-74.~~ Hydrology is currently present at the mitigation site and the mitigation site supports Cortina sandy loam and Saugus loam which are conducive to the establishment of sycamore riparian woodland. A Corps-approved reference site will be used prior to implementation of the mitigation program to provide the necessary data to measure the performance of the mitigation site.

The plant palette for the proposed mitigation site includes the planting of two riparian species: 727 one-gallon containers of Fremont cottonwood and 1,818 one-gallon containers of western sycamore. One-gallon upland buffer species will also be planted including chamise, hoaryleaf ceanothus, California buckwheat, deerweed, coast prickly pear, snake cholla, scrub oak, white sage, black sage, and our Lord's candle. A seed mix of 12 native shrub and herbaceous species will also be used.

The planting of a sycamore riparian woodland in the vicinity of the hollyleafed cherry woodland is not intended to, nor is it expected to, result in an inadvertent conversion of the riparian area from holly-leafed cherry to sycamore woodland. The creation of 7.27 acres of sycamore riparian woodland within Plum Canyon within the SRCA is expected to provide an overstory on the edges of the holly-leafed cherry woodland that replicates the conditions currently found in Drainage 5 (where impacts are proposed). Onsite occurrences of both species indicate that they can exist concomitantly without the risk of conversion from one type to another altogether. With appropriate spacing and the use of drip irrigation on the planted sycamores, the existing swath of holly-leafed cherry will not be adversely affected by the addition of the sycamore riparian woodland.

The HMMP includes a number of features to ensure the success of the mitigation site including supervision by a qualified habitat restoration specialist, a 5-year qualitative and quantitative monitoring program, contractor education, the use of mycorrhizal fungi, supplemental irrigation, regular maintenance (e.g., exotic vegetation control, pest control, trash removal), and adaptive management assurances.

5. Environmental Analysis

The Hybrid Functional Assessment (HFA) conducted by GLA (2009) concluded that the proposed project, considering off-setting mitigation measures, would result in a 25 percent increase in the total functionality of the aquatic features remaining within the SRCA after project implementation.

In addition to the measures proposed above, the project will require permits from the ACOE under section 404 of the Clean Water Act (CWA), from the Regional Water Quality Control Board (RWQCB) under section 401 of the CWA, and from the CDFG~~W~~ under section 1602 of the State Fish and Game Code. Should the Corps, RWQCB, and/or CDFG~~W~~ impose additional or greater mitigation measures on the project for these impacts, those measures – to the extent that they exceed what is required by the measures contained herein – may be substituted for the measures set forth herein, as the County does not intend to require the project to mitigate twice for the same impact once the project has already mitigated the impact below a level of significance.

Nesting Birds

4.C-3 In order to avoid impacts to nesting birds protected by the Migratory Bird Treaty Act and raptors protected by State Fish and Game Code, project grading and vegetation removal should take place outside of the nesting season, roughly defined as mid-February to mid-August. If grading or vegetation removal is to take place during the nesting season, a biologist acceptable to Los Angeles County shall be present during vegetation clearing operations to search for and flag active nests so that they can be avoided. A raptor survey will also be required in the unnamed canyon prior to the fill of that drainage. An avoidance buffer of 100 to 500 feet (exact radius to be determined by the monitoring biologist) will be fenced around any active raptor nests and impacts to nests will be avoided until after the nesting season is over. After mitigation the anticipated impact on nesting birds is less than significant. The results of the nesting bird construction monitoring will be provided in writing to the CDFG~~W~~ and County Department of Regional Planning (DRP).

Trees

4.C-4 To mitigate the loss of the coast live oak on-site (32 inches diameter at breast height [dbh]) in the southeastern section of the study area, an oak tree permit will be obtained from the County. The impacted oak tree will be replaced at a minimum ratio of 10:1 in the appropriate location at the interface between development and undeveloped areas. This ratio is in excess of the mitigation ratio set forth in the County ordinance, which is 2:1.

No mitigation is necessary for oak woodlands regulated under SB 1334 because no oak woodlands occur within the study area.

The loss of two California junipers within mixed coastal sage chaparral scrub shall be replaced in the landscaping scheme along roadways and in parks and other recreational areas at a minimum ratio of 3:1. Trees grown from local area stock shall be used, along with salvaged trees from the development area where possible.

5. Environmental Analysis

To mitigate the potential loss of the coast live oak off-site, the Applicant shall obtain an oak tree removal permit from the City of Santa Clarita for the coast live oak tree that may be adversely impacted by trenching for the proposed 78-inch pipeline installation, prior to initiation of pipeline trenching and construction. To the extent feasible, impacts to areas within the drip line (or root system) should be avoided during construction.

Indirect Impacts – Invasives

- 4.C-5 To mitigate potentially significant indirect impacts to open space areas adjacent to fuel modification zones due to the possible spread of invasive plant species, the proposed project shall incorporate the use of native plant species to the maximum extent practicable and avoid the use of plant species known to be highly invasive adjacent to open space areas. The plant palette for the fuel modification areas adjacent to open space areas shall be consistent with the County of Los Angeles Fire Department Fuel Modification Plan Guidelines and shall focus on native species provided in the table of desirable plant species.

5.4.4 Level of Significance After Mitigation

The Modified Project would only result in minor technical changes or additions to the previously certified EIR, and would not result in significant impacts upon implementation of applicable regulatory requirements and mitigation measures.

5.5 CULTURAL RESOURCES

5.5.1 Summary of Impacts Identified in the Certified EIR

This section summarizes the analysis contained in Section 4.D, *Cultural and Paleontological Resources*, of the 2010 Certified EIR.

According to the Certified EIR, a records search conducted at the California State University, Fullerton, Archaeological Information Center showed that three prehistoric archaeological sites, one historic period archaeological site, and five isolated finds were reported as a result of previous work and recent surveying. The prehistoric sites were subjected to Phase II testing (i.e., subsurface testing and laboratory analysis), and the historic complex was subjected to a site-specific historical records search to develop a context for determining potential significance. The results of these Phase II archaeological studies indicated a low probability for the sites to provide additional information in that the sites are not considered unique archaeological resources as defined in Section 21083.2 of the PRC. However, because archaeological resources were found within the project site, there is potential for construction and grading to uncover unknown subsurface cultural materials.

A records search was also performed by the Los Angeles Museum of Natural History to determine the paleontological sensitivity of the site. The record search determined that there is high fossil sensitivity onsite due to the terrestrial Pliocene Saugus Formation near and within the project area. Also, a fossil horse was located within the project boundary on the east side of the Cruzan Mesa SEA. Overall, the project site has

5. Environmental Analysis

high paleontological sensitivity. Mitigation is provided to ensure impacts to archaeological and paleontological resources are minimized to less than significant.

5.5.2 Impacts Associated with the Modified Project

Regulatory Background

Assembly Bill 52

Under the California Public Resources Code Sections 21073 et seq., the Native American Historic Resource Protection Act (Assembly Bill 52 [AB 52]) took effect July 1, 2015, and incorporates tribal consultation and analysis of impacts to tribal cultural resources (TCR) into the CEQA process. It requires TCRs to be analyzed like any other CEQA topic and establishes a consultation process for lead agencies and California tribes. Projects that require a Notice of Preparation of an EIR or Notice of Intent to adopt a ND or MND on or after July 1, 2015, are subject to AB 52. A significant impact on a TCR is considered a significant environmental impact, requiring feasible mitigation measures.

TCRs must have certain characteristics:

1. Sites, features, places, cultural landscapes (must be geographically defined), sacred places, and objects with cultural value to a California Native American Tribe that are either included or determined to be eligible for inclusion in the California Register of Historic Resources or included in a local register of historical resources.
2. The lead agency, supported by substantial evidence, chooses to treat the resource as a TCR.

The first category requires that the TCR qualify as a historical resource according to PRC Section 5024.1. The second category gives the lead agency discretion to qualify that resource—under the conditions that it supports its determination with substantial evidence and considers the resource’s significance to a California Tribe. The following is a brief outline of the process.

1. A California Native American tribe asks agencies in the geographic area with which it is traditionally and culturally affiliated to be notified about projects. Tribes must ask in writing.
2. Within 14 days of deciding to undertake a project or determining that a project application is complete, the lead agency must provide formal written notification to all tribes who have requested it.
3. A tribe must respond within 30 days of receiving the notification if it wishes to engage in consultation.
4. The lead agency must initiate consultation within 30 days of receiving the request from the tribe.

5. Environmental Analysis

5. Consultation concludes when both parties have agreed on measures to mitigate or avoid a significant effect to a TCR, OR a party, after a reasonable effort in good faith, decides that mutual agreement cannot be reached.
6. Regardless of the outcome of consultation, the CEQA document must disclose significant impacts on TCRs and discuss feasible alternatives or mitigation that avoid or lessen the impact

Given that AB 52 only recently took effect, the previously certified 2010 EIR did not analyze impacts related to tribal cultural resources. The County of Los Angeles also does not include tribal cultural resources as part of its adopted CEQA checklist. However, impacts of the Modified Project on tribal cultural resources are analyzed below using the Office of Planning and Research's proposed update to the CEQA Guidelines Appendix G checklist (see Section 5.5.2(e), below).

Would the Modified Project:

Issues	Substantial Change in Project or Circumstances Resulting in New Significant Effects	New Information Showing Greater Significant Effects than Previous EIR	New Mitigation or Alternative to Reduce Significant Effect is Declined	Minor Technical Changes or Additions	No Impact
a) Cause a substantial adverse change in the significance of a historical resource as defined in CEQA Guidelines § 15064.5?				X	
b) Cause a substantial adverse change in the significance of an archaeological resource pursuant to CEQA Guidelines § 15064.5?				X	
c) Directly or indirectly destroy a unique paleontological resource or site or unique geologic feature, or contain rock formations indicating potential paleontological resources?				X	
d) Disturb any human remains, including those interred outside of formal cemeteries?					X
e) Would the project cause a substantial adverse change in the significance of a tribal cultural resource as defined in Public Resources Code 21074?					X

Comments:

- a) **Cause a substantial adverse change in the significance of a historical resource as defined in CEQA Guidelines § 15064.5?**

Minor Technical Changes or Additions. The development footprint of the Modified Project is reduced and within the footprint of the Approved Project. The entire site is vacant and undeveloped. Grading of the Modified Project would not involve any demolition of existing structures or buildings that may have historic significance. Thus, no impact would occur to any historic resources, and the Modified Project would not result in any new or substantially altered conditions in comparison to the Approved Project.

5. Environmental Analysis

b) Cause a substantial adverse change in the significance of an archaeological resource pursuant to CEQA Guidelines § 15064.5?

Minor Technical Changes or Additions. As discussed above, archaeological resources were discovered onsite; however, Phase II testing determined that the resources were not significant. Similar to the Approved Project, implementation of the Modified Project would involve grading activities that may unearth previously undiscovered archaeological resources. Therefore, mitigation from the 2010 Certified EIR is provided to ensure impacts remain less than significant. The Modified Project would not result in any new or substantially altered conditions in comparison to the Approved Project.

c) Directly or indirectly destroy a unique paleontological resource or site or unique geologic feature, or contain rock formations indicating potential paleontological resources?

Minor Technical Changes or Additions. The record search performed for the Approved Project by the Los Angeles Museum of Natural History determined the project site to have high paleontological sensitivity. Grading activities associated with the Modified Project would be reduced compared to the Approved Project; however, it would still involve grading of the majority of the developable area. Any excavations in the Saugus Formation or Mint Canyon Formation have a high chance of discovering significant fossil vertebrate remains. Thus, mitigation is provided to ensure impacts to archaeological and paleontological resources are minimized to less than significant. However, the Modified Project would not result in any new or substantially altered conditions in comparison to the Approved Project.

d) Disturb any human remains, including those interred outside of formal cemeteries?

No Impact. California Health and Safety Code, Section 7050.5; CEQA Section 15064.5; and Public Resources Code, Section 5097.98 mandate the process to be followed in the event of an accidental discovery of any human remains in a location other than a dedicated cemetery. Specifically, California Health and Safety Code, Section 7050.5, requires that if human remains are discovered on a project site, disturbance of the site shall remain halted until the coroner has conducted an investigation into the circumstances, manner, and cause of any death, and the recommendations concerning the treatment and disposition of the human remains have been made to the person responsible for the excavation, or to his or her authorized representative, in the manner provided in Section 5097.98 of the Public Resources Code. If the coroner determines that the remains are not subject to his or her authority and if the coroner recognizes or has reason to believe the human remains to be those of a Native American, he or she shall contact, by telephone within 24 hours, the Native American Heritage Commission (NAHC). Although soil-disturbing activities associated with development of the Modified Project could result in the discovery of human remains, compliance with existing law and applicable mitigation measure from the Certified EIR would ensure that significant impacts to human remains would not occur.

e) Would the project cause a substantial adverse change in the significance of a tribal cultural resource as defined in Public Resources Code 21074?

No Impact. As part of the Certified 2010 EIR, the NAHC performed a records search of its Sacred Land Files for a one-mile radius around the project site to determine the presence of Native American resources.

5. Environmental Analysis

The record search did not indicate the presence of Native American cultural resources in the area that may be impacted by the Skyline Ranch project development. The NAHC also forwarded a list of Native American groups or individuals that may have additional information on the project area. These groups or individuals were notified of the Skyline Ranch project and asked for input. However, there were no responses to the inquiry. Given the results of the Native American consultation, it is unlikely that there are significant tribal cultural resources onsite. The modifications to the Approved Project would be developed within a reduced development footprint. Therefore, there would be no additional potential to affect other tribal cultural resources on the project site. No impact would occur.

5.5.3 Adopted Mitigation Measures Applicable to the Modified Project

Archaeological Resources

4.D-1(a) **Archaeological Monitoring.** At the commencement of project grading or construction, all workers associated with earth disturbing activities (particularly remedial grading and excavation) shall be given an orientation regarding the possibility of exposing unexpected archaeological material and/or cultural remains by a qualified archaeologist who satisfies the Secretary of the Interior's Professional Qualification Standards for Archaeology (prehistoric/historic archaeology) pursuant to 36 CFR 61. The archaeologist shall also instruct the workers as to what steps are to be taken if such a find is encountered. Due to the moderate sensitivity and possibility of buried cultural materials within the project area, it is recommended that initial grading and ground disturbing activities in areas determined to be sensitive (primarily those areas proximal to recorded sites) be monitored by an archaeologist who meets the Secretary of the Interior's Professional Qualifications Standards for Archaeology (prehistoric/historic archaeology) pursuant to 36 CFR 61. The archaeologist shall have the authority to stop work if sensitive or potentially significant cultural remains are discovered during excavation or ground disturbing activities. Test excavations may be necessary to reveal whether such cultural materials are significant. In the event the archaeologist indicates that a significant or unique archaeological/cultural find has been unearthed, grading operations shall cease in the affected area until the geographic extent and scientific value of the resources can be reasonably verified. Upon such discoveries, the archaeologist shall notify the applicant and Los Angeles County. Any excavation and recovery of resources shall be performed by a qualified archaeologist using standard archaeological techniques. If necessary, a mitigation plan shall be formulated. Work in the area shall only resume with the approval of the project archaeologist. Artifacts, notes, photographs, and other project materials recovered during the monitoring program shall be curated at a facility meeting federal and state standards.

4.D-1(b) **Human Remains.** If human remains are unearthed, State Health and Safety Code Section 7050.5 requires that no further disturbance shall occur until the County Coroner has made the necessary findings as to origin and disposition pursuant to Public Resources Code Section 5097.98. If the remains are determined to be of Native American descent, the coroner will notify the Native American Heritage Commission (NAHC). The NAHC will

5. Environmental Analysis

then identify the person(s) thought to be the Most Likely Descendent (MLD) of the deceased Native American, who will have 24 hours to make a formal recommendation as to disposition of the remains. All work associated with the remains will be done respectfully, and with recognition that the remains are considered sacred. All work in the area of the remains will be monitored by an authorized representative of the MLD.

Paleontological Resources

- 4.D-2(a) **Paleontological Survey and Treatment Program.** Prior to the implementation of grading or construction related activities, a qualified paleontologist shall be retained by the applicant to survey the project area to relocate known fossil localities, and determine the most sensitive areas. Following the survey, a paleontological resources monitoring and mitigation program will be developed that will include salvage of known fossil resources, areas that will be monitored during project-related earth-moving activities. The paleontological resources monitoring and mitigation program shall be submitted to the County for review and approval prior to construction grading activities. The program shall define specific procedures for construction monitoring; emergency discovery; sampling and data recovery, if needed; museum storage of any specimen and data recovered; preconstruction coordination; and reporting.
- 4.D-2(b) **Paleontological Monitoring.** The paleontologist shall monitor earth-moving construction activities at depths determined to be sensitive as specified in the County approved monitoring plan. Monitoring will not be conducted in areas where the ground has been previously disturbed or in areas where exposed sediment will be buried, but not otherwise disturbed.
- 4.D-2(c) **Paleontological Data Recovery.** Prior to the start of grading or construction related activities, construction personnel involved with earth-moving activities shall be informed of procedures to follow if fossil remains are encountered. In the event that paleontological resources are encountered during construction-related earth-moving activities, all work shall cease within the immediate area and be redirected elsewhere until the paleontological monitor has evaluated the situation and provided recommendations for the protection of, or mitigation of adverse effects to, significant paleontological resources assessed. Upon such discoveries, the contractor shall notify the applicant and Los Angeles County. Procedures for mitigating potential impacts to significant paleontological resources shall follow the monitoring and mitigation program previously developed under this mitigation measure. Construction work within this area shall resume upon approval from the principal project paleontologist.

5.5.4 Level of Significance After Mitigation

The Modified Project would only result in minor technical changes or additions to the previously certified EIR, and would not result in significant impacts upon implementation of applicable regulatory requirements and mitigation measures.

5. Environmental Analysis

5.6 ENERGY

5.6.1 Summary of Impacts Identified in the Certified EIR

The topic of energy was not discussed in the 2010 Certified EIR. The 2014 version of the County's checklist includes an energy section, and Appendix F of the CEQA Guidelines discusses energy.

5.6.2 Impacts Associated with the Modified Project

Regulatory Background

Los Angeles County Green Building Standards

The green building standards of Los Angeles County (County Code Title 22, Chapter 22.52, Part 20) are required for all new development to reduce water, energy, natural resources, and solid waste; reduce impacts to infrastructure; and promote a healthier environment.

The green building standards apply to new residential and commercial projects that file for building permits after January 1, 2009. Exemptions include agricultural accessory structures, registered historic sites, and first-time tenant improvements with a gross floor area of less than 10,000 square feet.

Projects that file for building permits with five dwelling units or more (the category under which the proposed project would fall) must meet the County's green building standards:

- **Energy Conservation:** Buildings must reduce energy demand by at least 15 percent below Title 24 (2005 Update).
- **Outdoor Water Conservation:** A smart irrigation controller must be installed for any landscaped area of the project.
- **Indoor Water Conservation:** All tank-type toilets installed must be high efficiency with a maximum 1.28 gallons per flush.
- **Resource Conservation:** At least 65 percent of construction waste (by weight) must be recycled.
- **Tree Planting:** A minimum of two 15-gallon trees must be planted and maintained for each single-family residence lot. At least one of the trees must be listed on the drought-tolerant approved plant list.

In addition to the green building standards, projects of five residential units or more must demonstrate compliance with another certification program. Applicants may choose from the following certification programs: Green Point Rated (GPR), California Green Builder (CGB), or Leadership in Energy and Environmental Design (LEED).

5. Environmental Analysis

Title 21, Subdivisions, Section 21.24.440, Green Building, of the Los Angeles County Building Code requires all subdivision projects to follow the County’s green building standards outlined in Title 22, Chapter 22.52, Part 20 of the County code.

Environmental Setting

Similar to the Approved Project, the Modified Project site is within the service area of Southern California Edison, which supplies both electricity and natural gas in the area. Table 5 summarizes the energy used by the residential and nonresidential sectors in Los Angeles County between 2006 and 2013 (most recent data available). The average electricity consumption between 2006 and 2013 was 69,589.52 million kilowatt hours (kWh) per year, with a high of 73,783 million kWh in 2008 and a low of 66,597 million kWh in 2011. The average natural gas consumption between 2006 and 2013 was 3,055.22 million therms, with a high of 3,130.53 million therms in 2013 and a low of 2,950.07 million therms in 2009.

Table 5 Historic Energy Use in Los Angeles County, 2006–2013

	2006	2007	2008	2009	2010	2011	2012	2013
Electricity (millions of kWh)	70,662.03	70,812.65	73,783.84	70,149.49	67,323.12	66,597.58	69,277.09	68,110.33
Natural Gas (millions of therms)	3,001.95	3,028.12	3,033.47	2,950.07	3,125.79	3,121.43	3,050.37	3,130.53

Source: CEC 2013a, 2013b.

CEQA Guidelines Appendix F

In the 2010 update of the state’s CEQA Guidelines, Appendix F was added to assure that energy implications are considered as part of the project approval process. All potentially significant energy impacts shall be considered in an EIR to the extent relevant and applicable to the project.

Would the Modified Project:

Issues	Substantial Change in Project or Circumstances Resulting in New Significant Effects	New Information Showing Greater Significant Effects than Previous EIR	New Mitigation or Alternative to Reduce Significant Effect is Declined	Minor Technical Changes or Additions	No Impact
a) Conflict with Los Angeles County Green Building Standards Code (L.A. County Code Title 31)				X	
b) Involve the inefficient use of energy resources (see Appendix F of the CEQA Guidelines)?				X	

a) Conflict with Los Angeles County Green Building Standards Code (L.A. County Code Title 31)?

Minor Technical Changes or Additions. Similar to the Approved Project, the Modified Project falls under the County’s Green Building category of “residential projects with 5 or more dwelling units,” which means housing must be constructed in compliance with the County’s green building standards as well as the

5. Environmental Analysis

requirements of GPR, CGB, or LEED. This requirement applies to all projects requiring building permits after January 1, 2010.

Additionally, the Director of Public Works must approve all project applications for building permits and verify that the project has complied with the County's green building standards as well as one of the additional sets of standards, or their equivalent, as described in the County Code (Title 22, Chapter 22.52, Part 20). The Modified Project would be required to demonstrate this compliance; without compliance, the project would not be issued building permits.

Both the Approved and Modified Projects would fall under the category of residential projects of five units or more and would be required to comply with the County's green building standards. The Modified Project would not result in any new or substantially altered conditions in comparison with Approved TTM 60922.

b) Involve the inefficient use of energy resources (see Appendix F of the CEQA Guidelines)?

Minor Technical Changes or Additions. Electricity demand was not calculated for the Approved Project. Based on a projected total of 1,260 units, the Approved Project would have used 10,372,440 kWh of electricity per year and 597,320 British thermal units (BTUs) (or 6.0 therms) of natural gas per year. The Modified Project proposes 1,220 residential units (a decrease of 40 units), which would slightly decrease the projected use of electricity and natural gas per year by 330,681 kWh/yr and 19,043 BTUs/yr (0.2 therms), respectively (see Table 6).

Table 6 Approved Project vs. Modified Project, Projected Energy Use

Units	Population ¹	CEC Electricity Demand Rate (kWh/capita/yr)	CEC Natural Gas Demand Rate (BTUs/capita/yr)	Projected Electricity Use (kWh/yr)	Projected Natural Gas Use (BTUs/yr)
Approved Project					
Residential					
1,260 units	4,360	2,379	137	10,372,440	597,320
Modified Project					
Residential					
1,220 units	4,221	2,379	137	10,041,759	578,277
Difference				(330,681 kWh/yr)	(19,043 BTUs/yr)

Source: USDOE 2008.

Notes: kWh = Kilowatt hours; BTU = British thermal units; yr = year; CEC = California Energy Commission

¹ Based on an average of 3.46 persons per household in Los Angeles County from the 2010 US Census Bureau census tract data for tracts 9200.32, 9200.33, and 9200.34.

As described in the analysis for Section 5.6.2 (a), the Modified Project would also be required to incorporate the County's green building standards as well as demonstrate compliance with another green building certification program, such as GPR, CGB, LEED, or an equivalent, as approved by the Director of Public Works. Additionally, the proposed project would be required to meet the California 2008 Building and Energy Efficiency Standards and the Title 24 Net-Zero Building Standards. By meeting these requirements, total energy use would be further reduced.

5. Environmental Analysis

The development of the Modified Project would result in a lower usage of electricity and natural gas than the Approved Project, which would be a beneficial impact.

5.6.3 Adopted Mitigation Measures Applicable to the Modified Project

The 2010 Certified EIR did not include mitigation measures related to energy resources.

5.6.4 Level of Significance After Mitigation

The Modified Project would only result in minor technical changes or additions to the previously certified EIR and would not result in significant impacts related to energy.

5.7 GEOLOGY AND SOILS

5.7.1 Summary of Impacts Identified in the Certified EIR

This section summarizes the analysis contained in Section 4.A, *Geotechnical Resources*, of the 2010 Certified EIR.

According to the Certified EIR, the Approved Project would be exposed to strong seismic ground shaking if an earthquake occurs along major faults in the vicinity; however, the project would conform to International Building Code (IBC) standards which include design requirements to reduce potential for significant damage to structures from seismic activities. The IBC and County of Los Angeles building standards, including those associated with hillside management, would ensure impacts related to ground shaking would be less than significant.

Canyons within the project site contain very coarse-grained alluvial deposits, landslide debris, and terrace deposits, which are subject to liquefaction. Additionally, much of the sloping terrain onsite have potential for earthquake-induced landslides. Mitigation is provided to ensure potentially significant impacts due to settlement and landsliding are reduced to less than significant levels.

Approximately 20,800,000 cubic yards of soil would be graded within the southern 622 acres of the site and on 33.7 acres of adjacent property to the east, west, south, and southwest. Most of the offsite grading is associated with the extension of roadways. A few areas onsite would be exposed to surficial instability and debris flow hazard. Therefore, mitigation in the form of drainage ditches, impact walls, slop design, berms, and drainage swales is provided to reduce impacts to less than significant.

The extensive excavation and grading associated with the Approved Project could also result in substantial soil erosion regardless of compliance with applicable best management practices and required erosion control plans. Mitigation is provided to reduce soil erosion impacts to less than significant levels.

5. Environmental Analysis

5.7.2 Impacts Associated with the Modified Project

The analysis in this section is based in part on the following technical report:

- *Geotechnical Report Amended Tentative Tract Map 060922, Canyon Country, County of Los Angeles, California, LGC Valley, Inc., March 28, 2016.*

A complete copy of the study is included in Appendix A.

Would the Modified Project:

Issues	Substantial Change in Project or Circumstances Resulting in New Significant Effects	New Information Showing Greater Significant Effects than Previous EIR	New Mitigation or Alternative to Reduce Significant Effect is Declined	Minor Technical Changes or Additions	No Impact
a) Expose people or structures to potential substantial adverse effects, including the risk of loss, injury, or death involving:					
i) Rupture of a known earthquake fault, as delineated on the most recent Alquist-Priolo Earthquake Fault Zone Map issued by the State Geologist for the area or based on other substantial evidence of a known active fault trace? Refer to Division of Mines and Geology Special Publication 42.					X
ii) Strong seismic ground shaking?					X
iii) Seismic-related ground failure, including liquefaction and lateral spreading?					X
iv) Landslides?				X	
b) Result in substantial soil erosion or the loss of topsoil?				X	
c) Be located on a geologic unit or soil that is unstable, or that would become unstable as a result of the project, and potentially result in on- or off-site landslide, lateral spreading, subsidence, liquefaction or collapse?					X
d) Be located on expansive soil, as defined in Table 18-1-B of the Uniform Building Code (1994), creating substantial risks to life or property?					X
e) Have soils incapable of adequately supporting the use of onsite wastewater treatment systems where sewers are not available for the disposal of wastewater?					X
f) Conflict with the Hillside Management Area Ordinance (L.A. County Code, Title 22, § 22.56.215) or hillside design standards in the County General Plan Conservation and Open Space Element?				X	

5. Environmental Analysis

Comments:

- a) **Expose people or structures to potential substantial adverse effects, including the risk of loss, injury, or death involving:**
- i) **Rupture of a known earthquake fault, as delineated on the most recent Alquist-Priolo Earthquake Fault Zoning Map issued by the State Geologist for the area or based on other substantial evidence of a known active fault trace? Refer to Division of Mines and Geology Special Publication 42.**

No Impact. The Modified Project site is the same as the Approved Project site and is not within an Alquist-Priolo Earthquake Fault Zone. There are also no known or potentially active faults that pass through the site. The nearest active faults to the site are the San Gabriel Fault, approximately 4.3 miles to the southwest of the site, and the Holser Fault, approximately 5 miles to the west of the site. Given the distance and lack of active faults across the site, potential damage due to ground rupture from nearby faults is considered nil (LGC 2016). Thus, the modifications to the Approved Project would have no impact on the project's susceptibility to ground rupture.

ii) Strong seismic ground shaking?

No Impact. As discussed above, the Skyline Ranch project site is not within an Alquist-Priolo Earthquake Fault Zone and no active faults pass through the site. However, the project site is situated in southern California, which is a seismically active area. Therefore, seismic ground shaking is anticipated to occur from time to time. Similar to the Approved Project, development in accordance with the Modified Project would be required to comply with the IBC, California Building Code, and County regulations to reduce seismic hazards to persons and structures. Therefore, the proposed modifications to Approved TTM 60922 would not result in new or substantially more severe impacts related to seismic strong ground shaking compared to those already analyzed in the Certified EIR.

iii) Seismic-related ground failure, including liquefaction and lateral spreading?

No Impact. Seismic-related ground failure can include lateral spreading (shallow ground rupture), liquefaction, and seismically induced settlements.

Lateral Spreading

Lateral spreading due to active faulting is not likely to occur on site due to the lack of active or potentially active fault traces across the site. Therefore, this is not considered a significant hazard.

Liquefaction

Liquefaction is a seismic phenomenon in which loose, saturated, granular soils behave similarly to a fluid when subject to high-intensity ground shaking. Liquefaction occurs when three general conditions exist: 1) shallow groundwater; 2) low density noncohesive (granular) soils; and 3) high-intensity ground motion. Liquefaction is typified by a buildup of pore-water pressure in the affected soil layer to a point where a total loss of shear strength occurs, causing the soil to behave as a liquid. Studies indicate that saturated,

5. Environmental Analysis

loose to medium dense, near-surface cohesionless soils exhibit the highest liquefaction potential, while dry, dense, cohesionless soils and cohesive soils exhibit low to negligible liquefaction potential.

Due to the presence of shallow bedrock at the site, complete removal of loose alluvial materials beneath compacted fills, and the general lack of shallow groundwater, the site is considered to have a low liquefaction hazard.

Seismically Induced Settlements

During a strong seismic event, seismically induced settlement can occur within loose to moderately dense, dry or saturated granular soil. Settlement caused by ground shaking is often not uniformly distributed, which can result in differential settlement. Mitigation Measure 4.A-1 from the Certified EIR would ensure that all unsuitable materials would be removed and recompacted in the grading of the site to mitigate potential for seismic settlement.

Overall, modifications to the Approved Project would not result in new or substantially more severe seismic-related ground failure impacts.

iv) Landslides?

Minor Technical Changes or Additions. As identified in the Certified EIR, much of the sloping terrain on the project site has been delineated a Seismic Hazard Zone with potential for earthquake-induced landslides. The Modified Project would reduce cut and fill quantities based on the modifications to Approved TTM 60922, including the realignment of Skyline Ranch Road, relocation of the park sites, and revisions to the product types. As stated above, the Modified Project would reduce cut and fill quantities to 17.1 million cy of cut and 16.9 million cy of fill, decreasing grading quantities under the Approved Project by approximately 18 and 19 percent, respectively.

The design and construction of the Modified Project would still be required to comply with provisions of the IBC, CBC, Los Angeles County Municipal Code, and grading ordinances, which are intended to reduce hazards to persons and damage to structures. Additionally, implementation of Mitigation Measure 4.A-2 would require that landslide soils be removed and recompacted or designated Restricted Use Areas. Therefore, while the proposed modifications to the Approved Project would result in changes to the project's grading footprint and volumes, these changes would not result in new or substantially more severe impacts related to landslides.

b) Result in substantial soil erosion or the loss of topsoil?

Minor Technical Changes or Additions. Erosion is the movement of soil and rock from place to place. Erosion occurs naturally by agents such as wind and flowing water; however, grading and construction activities can cause substantial erosion if effective erosion-control measures are not used. Common means of soil erosion from construction sites include water, wind, and being tracked offsite by vehicles.

The Modified Project would eliminate 40 residential lots, relocate park sites, and realign Skyline Ranch Road. These modifications would significantly decrease the project's required grading areas and volumes.

5. Environmental Analysis

Additionally, the realignment of Skyline Ranch Road to the east would preserve much of the site's western portion as is and would not cause substantial soil erosion or loss of topsoil in the area.

Regardless, both the Approved and Modified Projects would result in exposed slopes that require proper planting and landscaping for the most effective erosion control. Similar to the Approved Project, implementation of the Modified Project would also be required to comply with best management practices, required erosion control plans, and other regulatory requirements (e.g., IBC and CBC standards). Mitigation Measure 4.A-5 from the Certified EIR requires that finer soils be placed and compacted in the upper five feet of fill slopes to reduce the amount of infiltration and erosion. Cut slopes exposing erodible soils would require stabilization with engineered fill. Overall, impacts associated with soil erosion and loss of topsoil would be less than significant.

- c) Be located on a geologic unit or soil that is unstable, or that would become unstable as a result of the project, and potentially result in on- or off-site landslide, lateral spreading, subsidence, liquefaction, or collapse.**

No Impact. As discussed above in Sections 5.7(a) and (b), implementation of the Modified Project in conjunction with applicable mitigation measures from the Certified EIR would ensure that impacts from landslides, lateral spreading, subsidence, liquefaction, and collapse are less than significant. The Modified Project would be on the same geologic unit and soil as the Approved Project and would have a reduced development footprint. Thus, the changes proposed by the Modified Project would not result in any new impacts or increase the severity of impacts, with respect to unstable geologic units and soils.

- d) Be located on expansive soil, as defined in Table 18-1-B of the Uniform Building Code (1994), creating substantial risks to life or property?**

No Impact. The vast majority of the soils on the project site are within very low and low expansion index ranges. However, expansive rock units within the Saugus Formation are located in the westerly portion of the project site. Similar to the Approved Project, the Modified Project would be required to implement Mitigation Measure 4.A-4 from the Certified EIR, which ensures that expansive soils are overexcavated between 7 and 10 feet to mitigate potential for differential expansion. The changes proposed by the Modified Project would not result in any new impacts or increase the severity of impacts, with respect to expansive soil.

- e) Have soils incapable of adequately supporting the use of onsite wastewater treatment systems where sewers are not available for the disposal of wastewater?**

No Impact. Neither the Approved nor Modified Projects would include septic tanks or other alternative wastewater disposal systems. The Modified Project would include sewers connecting to nearby sewer mains. No impact would occur and the proposed modifications would not result in new or substantially more severe impacts related to alternative wastewater disposal systems than those already analyzed in the 2010 Certified EIR.

5. Environmental Analysis

f) Conflict with the Hillside Management Area Ordinance (L.A. County Code, Title 22, § 22.56.215) or hillside design standards in the County General Plan Conservation and Open Space Element?

Minor Technical Changes or Additions. The 2010 Certified EIR did not discuss impacts related to the Hillside Management Area (HMA) Ordinance. The County Board of Supervisors adopted an update to the HMA ordinance as part of the 2035 General Plan Update in March 2015. The HMA ordinance protects resources in significant ecological areas, as specified in the County General Plan, from incompatible development that may result in or have the potential for environmental degradation. Additionally, Section 22.56.217 (Hillside Management Areas – Additional Regulations) was added to the updated HMA ordinance. This section was established to ensure that development preserves and enhances the physical integrity and scenic value of HMAs, provides open space, and is compatible with and enhances community character.

The Conservation and Natural Resources Element of the 2035 General Plan includes Figure 9.8, *Hillside Management Areas and Ridgeline Management Map*, which indicates that the developable footprint of the Modified Project is in an area that has HMAs (slopes greater than 25 percent). A conditional use permit (CUP) is required for any development located wholly or partially in an HMA, including the proposed project. A CUP is granted when several findings are made. The following table provides a consistency analysis of the Modified Project with the HMA Ordinance. As shown, the Modified Project would meet the criteria of HMA compliance and impacts would be less than significant.

Table 7 HMA Ordinance Consistency Analysis

<p>1. The proposed development preserves the physical integrity of HMAs to the greatest extent feasible, resulting in lesser amount of impacts to hillside resources, by: locating development outside of HMAs to the extent feasible, locating development in the portions of HMAs with fewer hillside constraints, and using sensitive hillside design techniques tailored to the site requirements;</p>	<p>Consistent: The Modified Project would have a smaller development footprint than the Approved Project—492 acres compared to 622 acres in the southern third of the project site. The northern 1,355 acres would be preserved as natural open space in the Skyline Ranch Conservation Area. Additionally, as shown on Figure 4, <i>Approved TTM vs. Proposed Concept Plan</i>, the Modified Project would not impact a large portion of slopes and hills in the southwestern portion of the site (west of Skyline Ranch Road) compared to development of the Approved Project. Overall, the Modified Project would reduce grading quantities by approximately 18 and 19 percent for cut and fill, respectively. This preserves the physical integrity of the HMAs to the greatest extent feasible.</p>
<p>2. That the proposed development preserves the scenic value of HMAs to the extent feasible, resulting in lesser amount of impacts to on-site and off-site scenic views of slopes and ridgelines as well as to views of other unique, site-specific aesthetic or significant natural features of the hillside by: locating development outside of HMAs to the extent feasible, locating development in the portions of HMAs with the fewest hillside constraints; and using sensitive hillside design techniques tailored to the site requirements;</p>	<p>Consistent: As indicated in Sections 5.1.2(a) through (e), implementation of the Modified Project and applicable mitigation measures would ensure impacts to scenic views of slopes, ridgelines, and significant natural features of the hillsides are minimized. The Modified Project would shift the residential lots further north within the project site, away from existing views toward the Skyline Ranch community and northern hillsides; thereby reducing impacts on scenic vistas (see Figures 8 through 10, <i>Visual Simulation Comparison</i>).</p>
<p>3. That the proposed development is compatible with or enhances community character, and provides open space as requires in this Section;</p>	<p>Consistent: The Modified Project would be compatible with neighboring existing and planned communities, including the Plum Canyon community west of the project site and the existing residential neighborhoods south of the site in the City of Santa Clarita. The</p>

5. Environmental Analysis

Table 7 HMA Ordinance Consistency Analysis

	<p>design of the project would complement the surrounding natural area and match similar adjacent developments.</p> <p>The remaining northern 1,355 acres of the project boundary would be preserved as natural open space in the Skyline Ranch Conservation Area.</p>
<p>4. That the proposed development is in compliance with the Hillside Design Guidelines.</p>	<p>Consistent: The Approved Project complied with the Los Angeles County Subdivision Section Code 22.56.215 Hillside Management and Significant Ecological Areas guidelines and the density controlled Development Code 22.56.205. The Modified Project would have a smaller development footprint than the Approved Project as shown on Figure 4, <i>Approved TTM vs. Proposed Concept Plan</i>, and would not impact a large portion of slopes and hills in the southwestern portion of the site (west of Skyline Ranch Road) compared to development of the Approved Project.</p>

5.7.3 Adopted Mitigation Measures Applicable to the Modified Project

The following mitigation measures have been carried through from the 2010 Certified EIR.

Liquefaction/Dry Seismic Settlement

4.A-1 The following materials are considered unsuitable and shall be removed and recompacted in the grading of the site: existing fill soils, colluvial deposits and slopewash, alluvial deposits, landslide debris, and terrace deposits. Their removal and recompaction mitigate the potential for seismic settlement.

Landslides

4.A-2 **Landslide deposits within the limits of the planned grading shall be completely removed and replaced with competent material during site grading. The locations of landslide deposits to be removed are identified in the Geotechnical Investigation prepared by LGC Valley (dated March 28, 2016). The actual depth of stripping or overexcavation shall be determined during grading based on field observations by a qualified geotechnical consultant.**

Landslides (or portions thereof) that remain in place and are not removed and recompacted following the grading of the project site shall be designated as Restricted Use Areas, in accordance with Los Angeles County Department of Public Works (LACDPW) requirements. Landslides designated as Restricted Use Areas and landslides that are removed and recompacted are identified in the Geotechnical Investigations prepared by Geolabs-Westlake Village (dated March, 6, 2004, August 23, 2004, January 3, 2005, November 16, 2006, April 13, 2007, and August 28, 2008).

5. Environmental Analysis

Slope Stability

- 4.A-3(a) Interior slopes with daylighted bedding conditions shall be analyzed for appropriate buttress design. Tall cut slopes in the southerly portion of the site are anticipated to expose friable, uncemented bedrock zones and large cobbles and boulders. Several of these slopes require stabilization in order to mitigate the potential for raveling and dislocation of cobbles and boulders. All stability fills and buttresses shall be provided with backdrains and shall incorporate the generalized stability fill key dimensions for the “refacing” of planned cuts slopes.
- 4.A-3(b) Fill caps for cut/fill lots shall be constructed to provide uniform foundational support for future structures. Shallow cut lots and cut/fill lots shall be provided with a minimum 5-foot cap of compacted fill. Cut/fill lots underlain by 10 feet or less of compacted fill on the fill portion of the lot shall have the cut portion overexcavated a minimum of 5 feet below finish grade and replaced with compacted fill, thus providing a fill cap with a minimum 5-foot fill thickness. For those transition lots with 10 to 20 feet of fill on the fill side, the cut side shall be provided with a minimum 7-foot-thick fill cap. For those transition lots with in excess of 20 feet of fill on the fill side, the cut side shall be provided with a minimum 10-foot-thick fill cap. Fill caps shall extend a minimum of 5 feet beyond the perimeter footings.
- Where the backslope is 3:1 or steeper, the last bench prior to reaching the undercut shall be at least 15 feet in width. The 15-foot-wide bench is intended to reduce the steep dip of the fill-bedrock contact commonly created during undercutting.
- 4.A-3(c) All vegetation, trash debris, or other deleterious material shall be stripped from the area to be graded. These materials shall be removed from the site and deposited at a local landfill or recycled on site. Soils bearing sparse grasses may be thoroughly mixed with at least ten parts clean soil and incorporated into the engineered fill. Other materials shall be removed from the site.
- 4.A-3(d) Fill slopes, which toe onto sloping ground, shall be founded in bedrock, below the compressible surface soils. The key shall be at least 20 feet wide and 3 feet deep (measured on the downslope side). The bottom of the key shall be graded so that there is at least 1 foot of fall across its width (toward the upslope side). The key shall be located in front of the toe of slope (as shown on the plan) so that the outside limit of the key lies at or beyond a 1:1 projection from the planned toe of the slope.
- 4.A-3(e) Fill-over-cut slopes shall have the fill founded on a 20-foot-wide bench cut into the bedrock or, where bedrock is not present in the cut portion of the slope, on a key cut below the toe of the slope. The 20-foot bench shall be graded to provide at least 1 foot of fall toward its upslope side. If keyed below the toe of slope, then the key shall be at least 20 feet wide, 3 feet deep (below the toe), and tilted (at least 1 foot) into the slope. The cut portion of the slope shall be exposed (and observed by a representative of a qualified geotechnical firm) prior to constructing the fill portion of the slope.

5. Environmental Analysis

- 4.A-3(f) Exposed surfaces shall be scarified, moistened, or air-dried, as appropriate, and compacted to 90 percent of the material's maximum dry density prior to placement of fill.
- 4.A-3(g) Where the ground slopes steeper than 5:1 (horizontal:vertical), the fill shall be properly benched into bedrock.
- 4.A-3(h) All fill slopes shall utilize mixed soils [sand with some proportion of fines; i.e., clayey sand] in the outer 20 feet of the fill slope in order to minimize the potential for surficial slope deterioration.
- 4.A-3(i) Fill materials shall be placed in thin lifts, watered to near the material's optimum moisture content (or to near two percent over optimum moisture content and compacted to the applicable level of relative compaction prior to placing the next lift).
- 4.A-3(j) The 90 percent relative compaction standard applies to the face of fill slopes. This may be achieved by overfilling the constructed slope and trimming to a compacted finished surface, rolling the slope face with a sheepsfoot, or any method that achieves the desired product.
- 4.A-3(k) All retaining walls constructed within the project site shall be constructed in accordance with the Los Angeles County Building Code requirements and a design-level geotechnical investigation .
- 4.A-3(l) Backfill for retaining walls shall be properly compacted. An impervious cap shall be provided at the top of the backfill to retard infiltration of water.
- 4.A-(m) Slope setbacks set forth in the Los Angeles County Building Code shall be applied to residences and appurtenant structures. Structures situated within the setback area shall require special foundation design, which might include deepening footings, pile/caisson construction, and/or consideration of creep loads.
- 4.A-3(n) Backfill for utility trench excavations shall be compacted to at least 90 percent relative compaction. Where installed in sloping areas, the backfill shall be properly keyed and benched.
- 4.A-3(o) Those lots exposed to ascending natural slope conditions shall be provided with drainage ditches or swales, berms or impact walls, and/or small slopes descending from the pads to the natural slopes, to provide protection from potential debris flow hazard.

Expansive Soils

- 4.A-4 Expansive lithologies shall be overexcavated where encountered within lots and streets in order to mitigate the potential for differential expansion. The depth of such overexcavation shall range between 7 and 10 feet.

5. Environmental Analysis

Soil Erosion

4.A-5 During grading, soils containing significant fines content (cohesive soils) shall be preferentially placed in the outer five feet of fill slopes. In addition, the required 90 percent relative compaction standard shall be applied to the outer face of fill slopes in order to reduce the amount of infiltration and erosion. Cut slopes exposing erodible bedrock formations shall require stabilization with engineered fill.

5.7.4 Level of Significance After Mitigation

The Modified Project would only result in minor technical changes or additions in comparison to the to the previously certified EIR, and would not result in significant impacts upon implementation of applicable regulatory requirements and mitigation measures.

5.8 GREENHOUSE GAS EMISSIONS

5.8.1 Summary of Impacts Identified in the Certified EIR

This section summarizes the analysis contained in Section 4.S, *Global Climate Change*, of the 2010 Certified EIR., which evaluated the greenhouse gas (GHG) emissions impacts of the Approved Project.

GHG Emissions

GHG emissions were calculated for construction and operation of the Approved Project and are shown in Table 8. Construction of the Approved Project was estimated to take approximately seven years to complete and included two separate grading phases. In total, the project would generate 45,406 metric tons of carbon dioxide-equivalent (MTCO_{2e}) from on-road mobile sources and onsite construction equipment. GHG emissions were calculated for existing and projected future uses with implementation of the Approved Project. Total operational emissions generated from on-road mobile sources, electricity, natural gas, and water conveyance associated with the Approved Project was 35,078 MTCO_{2e} per year (36,592 MTCO_{2e} per year if 30-year amortized construction emissions are included).

5. Environmental Analysis

Table 8 Skyline Ranch Approved Project GHG Emissions

Sector	GHG Emissions (MTCO _{2e} /Year)
Total Construction Emissions (2008-2016)	45,406
30-Year Amortized Construction Emissions	1,514
Transportation	27,211
Electricity	3,817
Natural Gas	1,945
Water Conveyance	2,105
Total	36,592
Service Population (SP) ¹	4,360 residents
MTCO _{2e} /SP	8.4 MTCO _{2e} /SP
2010 Working Group SCAQMD Efficiency Metric	4.8 MTCO _{2e} /SP
Exceeds Efficiency Metric	Yes

Source: Los Angeles County 2009.

¹ Based on a service population of Approved Project: 4,360 residents. The Modified Project would result in 190 fewer residents (4,170 people).

The 2010 Certified EIR concluded that, at the time of the analysis, there was no generally accepted methodology to determine the extent to which GHG emissions associated with a specific project represent new emissions or existing emissions and therefore concluded that it was too speculative to determine the significance of impacts on global climate change. The 2010 Certified EIR conservatively concluded that the Approved Project's contribution to global warming was cumulatively considerable. The Approved Project included several mitigation measures to ensure consistency with the goals of Assembly Bill 32 (AB 32) and the California Climate Action Team strategies. Although these features and measures would reduce the Approved Project's GHG emissions impacts, the 2010 Certified EIR identified that the Approved Project would result in cumulatively **significant and unavoidable** impacts to global climate change.

5.8.2 Impacts Associated with the Modified Project

The Draft EIR for the Approved Project was circulated in July of 2009, which was prior to the amendments to the CEQA Guidelines, which were adopted on December 30, 2009, and became effective March 18, 2010. The information provided in this section includes the most current scientific data on GHG emissions and global climate change, but does not change the conclusions of the 2010 Certified EIR. Updated information on GHG emissions and global climate change does not trigger the need for preparation of a subsequent or supplemental EIR pursuant to Public Resources Section 21166 and CEQA Guidelines Section 15162. The current scientific information does not demonstrate that the Modified Project would result in new or more severe significant impacts than those determined in the 2010 Certified EIR.

Regulatory Background

The environmental and regulatory settings for the Modified Project have changed since certification of the 2010 Certified EIR. The following discussion is provided to update conditions relative to development of the Modified Project.

5. Environmental Analysis

State

Recent State of California guidance and goals for reductions in GHG emissions are generally embodied in Executive Order B-30-15, Assembly Bill 32 (AB 32), and Senate Bill 375 (SB 375).

- **Executive Order B-30-15 (2015).** Executive Order B-30-15, signed April 29, 2015, sets a goal of reducing GHG emissions within the state to 40 percent of 1990 levels by year 2030. It also directs CARB to update the Scoping Plan to quantify the 2030 GHG reduction goal for the state and requires state agencies to implement measures to meet the interim 2030 goal of Executive Order B-30-15 as well as the long-term goal for 2050 in Executive Order S-03-5.
- **Assembly Bill 32, the Global Warming Solutions Act (2006).** AB 32 was passed on August 31, 2006 and follows the 2020 tier of emissions reduction targets established in Executive Order S-3-05.
- **Senate Bill 375 (2008).** The intent of Senate Bill 375 (SB 375), the Sustainable Communities and Climate Protection Act, is to reduce GHG emissions from light-duty trucks and automobiles (excludes emissions associated with goods movement) by aligning regional long-range transportation plans, investments, and housing allocations to local land use planning to reduce VMT and vehicle trips.

Regional

SCAG's 2016-2040 RTP/SCS

SB 375 requires metropolitan planning organizations to prepare a sustainable communities strategy in their regional transportation plan. For the SCAG region, the 2016-2040 Regional Transportation Plan/Sustainable Communities Strategy (RTP/SCS) was adopted in April 2016 (SCAG 2016). The SCS outlines a development pattern for the region, which, when integrated with the transportation network and other transportation measures and policies, would reduce GHG emissions from transportation (excluding goods movement). The SCS is meant to provide growth strategies that will achieve the regional GHG emissions reduction targets. However, the SCS does not require that local general plans, specific plans, or zoning be consistent with the SCS; instead, provides incentives to governments and developers for consistency.

The 2016-2040 RTP/SCS projects that the SCAG region will meet or exceed the passenger vehicle per capita targets set in 2010 by CARB. Pursuant to the 2016-2040 RTP/SCS, SCAG anticipates lowering GHG emissions below 2005 levels by 8 percent by 2020, 18 percent by 2035, and 21 percent by 2040. Land use strategies to achieve the region's targets include planning for new growth around High Quality Transit Areas (HQTA), Livable Corridors, and creating Neighborhood Mobility Areas to integrate land use and transportation and plan for more active lifestyles (SCAG 2016).

Would the Modified Project:

5. Environmental Analysis

Issues	Substantial Change in Project or Circumstances Resulting in New Significant Effects	New Information Showing Greater Significant Effects than Previous EIR	New Mitigation or Alternative to Reduce Significant Effect is Declined	Minor Technical Changes or Additions	No Impact
a) Generate greenhouse gas (GHGs) emissions, either directly or indirectly, that may have a significant impact on the environment?				X	
b) Conflict with any applicable plan, policy, or regulation adopted for the purpose of reducing the emissions of greenhouse gases?				X	

Comments:

- a) **Generate greenhouse gas (GHGs) emissions, either directly or indirectly, that may have a significant impact on the environment?**

Minor Technical Changes or Additions. Global climate change is not confined to a particular project area and is generally accepted as the consequence of global industrialization over the last 200 years. A typical project, even a very large one, does not generate enough greenhouse gas emissions on its own to influence global climate change significantly, so the issue of global climate change is, by definition, a cumulative environmental impact. The State of California, through its governor and its legislature, has established a comprehensive framework for the substantial reduction of GHG emissions over the next 40-plus years. This will occur primarily through the implementation of AB 32 and SB 375, which will address GHG emissions on a statewide cumulative basis.

Based on the 2010 Certified EIR, the Approved Project would generate 36,592 MTCO_{2e} per year (see Table 8). Modifications to the Approved Project would reduce the grading quantities, development footprint, and residential lots by 40 units, thereby also reducing trip generation. Therefore, development of the Modified Project would result in less GHG emissions than identified in the 2010 Certified EIR. Although GHG emissions generated by the Modified Project could cumulatively contribute to statewide GHG emissions, the Modified Project would result in a beneficial impact compared to the Approved Project.

- b) **Conflict with any applicable plan, policy, or regulation adopted for the purpose of reducing the emissions of greenhouse gases?**

Minor Technical Changes or Additions. CARB's 2008 Scoping Plan is California's GHG reduction strategy to achieve the state's GHG emissions reduction target established by AB 32, which is 1990 levels by year 2020. Statewide strategies to reduce GHG emissions include the Low Carbon Fuel Standard, California Appliance Energy Efficiency regulations, California Renewable Energy Portfolio standard, changes in the corporate average fuel economy standards (Pavley and the California Advanced Clean Cars program), and other early action measures would ensure the state is on target to achieve the GHG emissions reduction goals of AB 32. In addition, new buildings constructed are required to comply with or exceed the most recent Building and Energy Efficiency Standards and California Green Building Code. The Modified Project's GHG emissions would be reduced through compliance with statewide measures that have been adopted since AB

5. Environmental Analysis

32 was adopted. Compared to the Approved Project, the Modified Project would generate less GHG emissions due to the reduction of residential homes (40 units) and reduced grading quantities. Additionally, compliance with the aforementioned state regulations would ensure that the Modified Project does not interfere with regional plans and policies or the State of California's ability to achieve GHG reduction goals and strategies.

5.8.3 Adopted Mitigation Measures Applicable to the Modified Project

- GCC-1 The builder shall strive to construct at least 10 percent of dwelling units in the proposed project with LIVINGSMART® features so as to achieve a minimum of 25 percent reduction in projected GHG emissions. The builder commits to offer enhanced advertising, education, and, if needed, other incentives to encourage market acceptance of these various energy- and water-conserving options.
- GCC-2 The builder shall plant approximately 40 trees per landscaped acre as a means to capture (sequester) carbon dioxide emissions and to provide shade to the buildings, which can decrease the need for air conditioning.
- GCC-3 To facilitate the extension of existing bus service to include Skyline Ranch Road, the builder shall work with the Santa Clarita Transit District to design and provide bus turnouts and shelters along Skyline Ranch Road.
- GCC-4 In order to increase awareness of green building practices and to promote water and energy conservation, the builder will develop and implement a green educational program. The program will include but not necessarily be limited to a pamphlet that educates and promotes conservation practices that homeowners can implement, with specific guidance on landscaping with drought tolerant plants, use of efficient irrigation systems, compact florescent lighting, and other measures that help lower GHG emissions.

Please also see Mitigation Measures 4.H-2(a) and 4.H-2(b) in Section 5.3.3, and Mitigation Measures 4.I-1 through 4.I-5 in Section 5.18.3.

5.8.4 Level of Significance After Mitigation

The Modified Project would only result in minor technical changes or additions in comparison to the previously certified EIR and would not result in significant impacts upon implementation of applicable regulatory requirements and mitigation measures.

5.9 HAZARDS AND HAZARDOUS MATERIALS

5.9.1 Summary of Impacts Identified in the Certified EIR

Impacts associated with hazards and hazardous materials (previously called “Environmental Safety”) were determined to be less than significant and were closed out in the Initial Study for the 2010 Certified EIR. The

5. Environmental Analysis

Initial Study concluded that no hazardous materials would be used, transported, produced, handled, or stored onsite; no pressurized tanks would be used onsite; no significant hazards due to accidental release of materials would occur; and no hazardous emissions would be emitted. The project is not on a site listed as a hazardous materials site or within an airport land use plan and would not impair or physically interfere with an adopted emergency response plan.

5.9.2 Impacts Associated with the Modified Project

Would the Modified Project:

Issues	Substantial Change in Project or Circumstances Resulting in New Significant Effects	New Information Showing Greater Significant Effects than Previous EIR	New Mitigation or Alternative to Reduce Significant Effect is Declined	Minor Technical Changes or Additions	No Impact
a) Create a significant hazard to the public or the environment through the routine transport, storage, production, use, or disposal of hazardous materials?					X
b) Create a significant hazard to the public or the environment through reasonably foreseeable upset and accident conditions involving the release of hazardous materials or waste into the environment?					X
c) Emit hazardous emissions or handle hazardous or acutely hazardous materials, substances, or waste within one-quarter mile of sensitive land uses?					X
d) Be located on a site which is included on a list of hazardous materials sites compiled pursuant to Government Code § 65962.5 and, as a result, would it create a significant hazard to the public or the environment?					X
e) For a project located within an airport land use plan, or where such a plan has not been adopted, within two miles of a public airport or public use airport, would the project result in a safety hazard for people residing or working in the project area?					X
f) For a project within the vicinity of a private airstrip, would the project result in a safety hazard for people residing or working in the project area?					X
g) Impair implementation of, or physically interfere with, an adopted emergency response plan or emergency evacuation plan?					X
h) Expose people or structures to a significant risk of loss, injury or death involving fires, because the project is located:					
i) within a Very High Fire Hazard Severity Zones (Zone 4)?				X	
ii) within a high fire hazard area with inadequate access?				X	
iii) within an area with inadequate water and pressure to meet fire flow hazards?					X

5. Environmental Analysis

Issues	Substantial Change in Project or Circumstances Resulting in New Significant Effects	New Information Showing Greater Significant Effects than Previous EIR	New Mitigation or Alternative to Reduce Significant Effect is Declined	Minor Technical Changes or Additions	No Impact
iv) within proximity to land uses that have the potential for dangerous fire hazard?					X
i) Does the proposed use constitute a potentially dangerous fire hazard?				X	

Comments:

a) Create a significant hazard to the public or the environment through the routine transport, storage, production, use, or disposal of hazardous materials?

No Impact. No new land uses are proposed that may involve additional hazardous materials that would not already be used during construction and operations of the Approved Project. Construction would involve small quantities of hazardous materials, such as fuels, greases, paints, and cleaning materials. Similar to the Approved Project, the use, storage, transport, and disposal of hazardous materials by the Modified Project would be required to comply with existing regulations of several agencies, including the Department of Toxic Substances Control, the California Environmental Protection Agency, the Occupational Safety & Health Administration, and Los Angeles County Fire Department (LACoFD). Compliance with applicable laws and regulations governing the use, storage, transportation, and disposal of hazardous materials would ensure that all potentially hazardous materials are used and handled in an appropriate manner, and would minimize potential hazards. Long-term operations of the Modified Project (a residential community) would not involve routine transport, storage, use, or disposal of substantial amounts of hazardous materials. Project operation would require use of small amounts of materials such as cleansers, paints, and pesticides for cleaning and maintenance purposes. The use of these materials would be in accordance with the manufacturer's instructions for use, storage, transport, and disposal. Therefore, there would be no significant new impacts arising from the routine handling of hazardous materials as a result of the proposed modifications to the approved TTM.

b) Create a significant hazard to the public or the environment through reasonably foreseeable upset and accident conditions involving the release of hazardous materials or waste into the environment?

No Impact. As stated above, the proposed modifications to the recorded track would not result in new sources of hazardous materials during construction or operations. No hazardous materials would be used other than household and vehicle maintenance materials (i.e., cleaning supplies, paints, fertilizers, oil, and grease) and landscaping and maintenance. Similar to the Approved Project, the use of hazardous materials by the Modified Project would not result in substantial hazards to people or to the environment arising from accidental release of hazardous materials. Therefore, impacts would be less than significant and no new substantial impacts would occur from the proposed modifications.

5. Environmental Analysis

c) Emit hazardous emissions or handle hazardous or acutely hazardous materials, substances, or waste within one-quarter mile of sensitive land uses?

No Impact. Similar to the Approved Project, the Modified Project would include an 11.9-acre school site, which is considered a sensitive land use. Nearby uses to the school would include a park and residential homes (see Figure 4, *Approved TTM vs. Proposed Concept Plan*). However, no hazardous materials would be used other than typical household and landscaping maintenance materials (i.e., cleaning supplies, paints, fertilizers, oil, and grease). Therefore, the proposed modifications to the approved TTM would not result in significant impacts.

d) Be located on a site which is included on a list of hazardous materials sites compiled pursuant to Government Code § 65962.5 and, as a result, would it create a significant hazard to the public or the environment?

No Impact. The proposed modifications to the Approved Project would all be within the development footprint previously analyzed in the 2010 Certified EIR, which concluded that the project site is not located on a hazardous materials site pursuant to Government Code Section 65962.5. Thus, the modifications to the project would not create new significant hazards to the public or environment.

e) For a project located within an airport land use plan, or where such a plan has not been adopted, within two miles of a public airport or public use airport, would the project result in a safety hazard for people residing or working in the project area?

No Impact. There are no public airports within two miles of the project site (AirNav 2014), and the site is not in an airport land use plan. The nearest public airport to the site is Agua Dulce Airpark, approximately 9.2 miles northeast of the developable area of the project site. The nearest major airport is the Bob Hope Airport in Burbank, over 17 miles south of the project site. No impacts would occur.

f) For a project within the vicinity of a private airstrip, would the project result in a safety hazard for people residing or working in the project area?

No Impact. There are no private airstrips near the project site (AirNav 2014).

g) Impair implementation of, or physically interfere with, an adopted emergency response plan or emergency evacuation plan?

No Impact. Modifications to the Approved Project would constitute minor technical changes and would not impair or physically interfere with an adopted emergency response plan or emergency evacuation plan. Modifications include realigning Skyline Ranch Road, reducing residential lots by 40 units (but including age-qualified homes and a community center), modifying housing product types, relocating and expanding park and recreation center sites, and extending multipurpose trails and bike lanes. Similar to the Approved Project, the Modified Project would be required to comply with fire apparatus access road requirements as detailed in the California Fire Code (Title 24, California Code of Regulations, Part 9, Section 503). The design of Skyline Ranch Road and private roads onsite would comply with LACoFD requirements for access roads and turning radii. All onsite roadways and emergency access provisions would also be subject to review and approval by

5. Environmental Analysis

the Los Angeles County Department of Public Works, the LACoFD, and the Sheriff's Department. Therefore, no impacts to emergency access and/or emergency evacuation plans would occur.

h) Expose people or structures to a significant risk of loss, injury or death involving fires, because the project is located:

i) Within a Very High Fire Hazard Severity Zones (Zone 4)?

Minor Technical Changes or Additions. The project site is currently undeveloped and within a large area of natural open space. According to the California Department of Forestry and Fire Protection, the entire project site is in a Very High Fire Hazard Severity Zone (VHFHSZ) (CAL FIRE 2007). In October 2007, the vast majority of the project site was burned as a result of the 38,000-acre Buckweed (Agua Dulce) Fire.

The Los Angeles County Fire Code (Title 32) and County Building Code (Title 26) establish requirements and regulations for the design, construction, and provision of fire protection facilities and equipment related to new development within the LACoFD jurisdiction, including the project site. Basic requirements for new development projects include the provision of multiple ingress/egress access points, fire suppression systems, fire flow standards, and minimum street widths. Additional specific requirements are also applicable to projects in LACoFD-designated VHFHSZ (formerly Fire Zone 4), such as the proposed project.

The modifications to the Approved Project would consist of realigning Skyline Ranch Road, reducing residential lots by 40 units (but including 284 units of age-qualified homes and a community center), modifying housing product types, relocating and expanding park and recreation center sites, and extending multipurpose trails and bike lanes. None of these minor technical changes would alter the project's requirement to comply with the County's fire or building codes. Similar to the Approved Project, the Modified Project would be required to submit for review and approval a fuel modification plan, a landscape plan, and an irrigation plan to the Department of Regional Planning and the Forestry Division of the LACoFD (Fuel Modification Unit). A fuel modification plan requires that a project establish a fuel modification zone where existing vegetation is managed and/or replaced to reduce the risk of fire, and it must be consistent with LACoFD's Fuel Modification Plan Guidelines. Additional site-specific requirements for a fuel modification plan, including the minimum width of a fuel modification zone, are determined by the LACoFD at the time of project plan review and prior to issuance of grading permits. Therefore, impacts would be less than significant.

Additionally, implementation of the Modified Project would comply with other applicable requirements, including the County Fire and Building Codes, the California Fire Code, and conditions of approval from the LACoFD regarding site access, fire hydrant spacing, water storage, building materials, and fire flow. Pursuant to conditions of approval, the proposed water system would be designed to deliver fire flow in compliance with LACoFD requirements for the proposed land uses. Therefore, the Modified Project would provide sufficient fire flows. The Modified Project is also required to equip proposed structures with design features and fire suppression equipment, including an automatic fire suppression system, a fire alarm system, and an evacuation life safety system. Project plans would be reviewed by LACoFD

5. Environmental Analysis

prior to the issuance of building permits to ensure that the project would be compliant with applicable fire codes, regulations, and conditions.

Upon compliance with the above-specified codes, project-related hazards arising from fire hazards would be less than significant. Modifications to the approved TTM would not result in any uses that would expose residents to an unusually high level of fire hazards. Therefore, the Modified Project would not result in new significant impacts as a result of project modifications or a substantial change in circumstances.

ii) Within a high fire hazard area with inadequate access?

Minor Technical Changes or Additions. As required by the Los Angeles County Building and Fire Codes, any project in a VHFHSZ must have adequate access points to allow fire department equipment to enter the site and for residents to evacuate (Los Angeles County Code Title 32 Part 1, Access, and Section 326, Activities in Hazardous Fire Areas). The Modified Project would not alter the accessibility of the approved TTM. Although Skyline Ranch Road would be realigned within the project site, the two main access points would be in the same location as proposed under the Approved Project—Skyline Ranch Road/Whites Canyon Road and Skyline Ranch Road/Sierra Highway. All onsite roadways would be designed to accommodate fire engines, as required by Title 32, Part 1, of the Los Angeles County Code. The Modified Project would not alter the number of access roads or their widths. Therefore, it would not result in new significant impacts as a result of project modifications.

iii) Within an area with inadequate water and pressure to meet fire flow hazards?

No Impact. As discussed in Section 5.9.2(h)(i), the project's water system would be designed to deliver fire flow in compliance with LACoFD requirements for the proposed land uses. Therefore, the project would provide sufficient fire flows. Modifications to the Approved Project would not alter the site design in a way that would prevent inadequate fire flow. No new significant impacts are identified.

iv) Within proximity to land uses that have the potential for dangerous fire hazard?

No Impact. The project site is surrounded by natural open space to the north and northeast and residential uses to the west, south, and east. There is no potential for dangerous fire situations involving flammables, refineries, or explosives manufacturing. No impacts related to these types of fire hazards would occur.

i) Does the proposed use constitute a potentially dangerous fire hazard?

Minor Technical Changes or Additions. The proposed project would modify Approved TTM 60922 within the approved development footprint of the Skyline Ranch property. Modifications include a realignment of Skyline Ranch Road, reduction of 40 residential lots (but inclusion of 284 units of age-qualified homes and a community center), modifications to housing product types, relocation and expansion of park and recreation center sites, and extension of multipurpose trails and bike lanes. These modifications would not constitute a potentially dangerous fire hazard. Therefore, the Modified Project would not result in new significant impacts as a result of project modifications or a substantial change in circumstances.

5. Environmental Analysis

5.9.3 Adopted Mitigation Measures Applicable to the Modified Project

The 2010 Certified EIR did not include mitigation measures related to hazards and hazardous materials.

5.9.4 Level of Significance After Mitigation

The Modified Project would only result in minor technical changes or additions to the previously certified EIR, and would not result in significant impacts related to hazards and hazardous materials.

5.10 HYDROLOGY AND WATER QUALITY

5.10.1 Summary of Impacts Identified in the Certified EIR

This section summarizes the analysis contained in Section 4.B, *Hydrology and Water Quality*, of the 2010 Certified EIR.

Hydrology

Based on the 2010 Certified EIR, implementation of the Approved Project would decrease flow rates for onsite watersheds by 231 cubic feet per seconds (cfs) and would discharge into existing or proposed storm drain systems designed to accommodate this runoff volume. Installation of debris basins, both upstream and downstream, in conjunction with the urbanization of the site would remove approximately 13,009 cubic yards of debris from the site's entire watershed. On-site drainage facilities would be designed and constructed in accordance with City and County standards and would be subject to review and approval by the Los Angeles County Flood Control District, Los Angeles County Department of Public Works, and City of Santa Clarita Public Works Department. As a result, construction of the Approve Project would not have a significant impact on flow rates or debris production.

Flood Plains

Development of the entrance of the project site from Sierra Highway would include a bridge over a series of culverts and catch basins, which would allow water from Sierra Highway to flow under Skyline Ranch Road in order to minimize the potential for flooding at the project entrance and reduce the flow rate along Sierra Highway during a 50-year storm event. With the proposed improvements, total flow rate in this area of the site would decrease by 40 cfs. Water surface levels would not rise above existing conditions during 50-year storm events. In addition, the County Flood Plain Boundary would change upon implementation of these improvements. Although, as proposed, impacts on flooding would be less than significant, because these drainage facilities are preliminarily designed and not yet approved, mitigation was provided.

Water Quality

Construction

Grading and construction activities associated with the Approved Project would remove existing vegetation and expose topsoil. Additionally, construction activities would involve several large construction vehicles, wash areas, temporary facilities, and construction materials and supplies. These sources may come in contact

5. Environmental Analysis

with precipitation or irrigation water and result in polluted runoff from the project site. Mitigation was provided to ensure construction activities do not have a significant impact on water quality.

Operations

Approximately 18 percent of previously permeable surfaces would become impervious due to the development of the Approved Project. This would result in an increase of urban-related pollutants that can be carried offsite by nuisance and stormwater runoff into downstream receiving waters (i.e., Santa Clara River). Therefore, mitigation was provided to reduce impacts on stormwater runoff quality to less than significant levels.

5.10.2 Impacts Associated with the Modified Project

Would the Modified Project:

Issues	Substantial Change in Project or Circumstances Resulting in New Significant Effects	New Information Showing Greater Significant Effects than Previous EIR	New Mitigation or Alternative to Reduce Significant Effect is Declined	Minor Technical Changes or Additions	No Impact
a) Violate any water quality standards or waste discharge requirements?				X	
b) Substantially deplete groundwater supplies or interfere substantially with groundwater recharge such that there would be a net deficit in aquifer volume or a lowering of the local groundwater table level (e.g., the production rate of pre-existing nearby wells would drop to a level which would not support existing land uses or planned uses for which permits have been granted)?				X	
c) Substantially alter the existing drainage pattern of the site or area, including through the alteration of the course of a stream or river, in a manner which would result in substantial erosion or siltation on- or off-site?				X	
d) Substantially alter the existing drainage pattern of the site or area, including through the alteration of the course of a stream or river, or substantially increase the rate or amount of surface runoff in a manner which would result in flooding on- or off-site?				X	
e) Add water features or create conditions in which standing water can accumulate that could increase habitat for mosquitoes and other vectors that transmit diseases such as West Nile virus and result in increased pesticide use?					X
f) Create or contribute runoff water which would exceed the capacity of existing or planned stormwater drainage systems or provide substantial additional sources of polluted runoff?				X	

5. Environmental Analysis

Issues	Substantial Change in Project or Circumstances Resulting in New Significant Effects	New Information Showing Greater Significant Effects than Previous EIR	New Mitigation or Alternative to Reduce Significant Effect is Declined	Minor Technical Changes or Additions	No Impact
g) Generate construction or post-construction runoff that would violate applicable stormwater NPDES permits or otherwise significantly affect surface water or groundwater quality?				X	
h) Conflict with the Los Angeles County Low Impact Development Ordinance (L.A. County Code, Title 12, Ch. 12.84 and Title 22, Ch. 22.52)?				X	
i) Result in point or nonpoint source pollutant discharges into State Water Resources Control Board-designated Areas of Special Biological Significance?					X
j) Use onsite wastewater treatment systems in areas with known geological limitations (e.g., high groundwater) or in close proximity to surface water (including, but not limited to, streams, lakes, and drainage course)?					X
k) Otherwise substantially degrade water quality?				X	
l) Place housing within a 100-year flood hazard area as mapped on a federal Flood Hazard Boundary or Flood Insurance Rate Map, or other flood hazard delineation map, or within a floodway or floodplain?				X	
m) Place structures, which would impede or redirect flood flows, within a 100-year flood hazard area, floodway, or floodplain?				X	
n) Expose people or structures to a significant risk of loss, injury or death involving flooding, including flooding as a result of the failure of a levee or dam?					X
o) Place structures in areas subject to inundation by seiche, tsunami, or mudflow?					X

Comments:

a) Violate any water quality standards or waste discharge requirements?

Minor Technical Changes or Additions. Compared to the approved TTM, the Modified Project would reduce overall net site imperviousness and stormwater runoff as a result of removing 40 residential units, relocating Skyline Ranch Road, and reducing the project's overall development footprint from 622 acres to 492 acres and associated reduction in impervious surfaces.

Construction

The Modified Project would generally have similar grading and construction activities as compared to the Approved Project. Grading would require the removal of existing vegetation, which would expose much of the topsoil in the developable areas and can lead to erosion from construction irrigation (i.e., dust-control

5. Environmental Analysis

measures) and precipitation. Additionally, due to the extent of soils that would be graded, reengineered, and reused, stockpiling of soils would occur within the overall project site and would be subject to erosion from construction irrigation and/or precipitation.

Similar to the Approved Project, construction activities would involve large construction vehicles, wash areas, temporary facilities, and construction materials and supplies. Maintenance and refueling of construction vehicles have the potential to result in spills of petroleum-related engine fluids and coolants. Washing of vehicles and equipment can discharge waters polluted with sediment, oils and grease, trace metals, and detergent-based organics (e.g., adhesives, cleaners, sealants, and solvents). Equipment and facilities that may be required during construction include concrete mixers, portable sanitary and septic systems, and temporary trailers. All of these sources could come in contact with precipitation or irrigation waters and result in polluted runoff from the project site.

However, water quality effects would be controlled and maintained at less than significant levels by preparing and implementing a Storm Water Pollution Prevention Plan (SWPPP) in accordance with State Water Resources Control Board (SWRCB) Order No. 2009-0009 DWQ, which is required prior to receiving site demolition and/or grading permits. The SWPPP would be prepared by the construction contractor and submitted to the Los Angeles County Department of Public Works and RWQCB for approval. The SWPPP would meet all applicable regulations by requiring controls of pollutant discharges that use best available technology economically achievable and best conventional pollutant control technology to reduce pollutants. In compliance with the SWPPP, non-stormwater level best management practices (BMPs) would also be implemented that include controls and objectives for vehicle and equipment maintenance, cleaning, and fueling, and potable water/irrigation practices.

Compliance with BMP would reduce or eliminate soil erosion impacts from construction activities. Common means of soil erosion from construction sites include water, wind, and being tracked offsite by vehicles. Compliance with these BMPs is required by the federal Clean Water Act and the Los Angeles County Department of Public Works Flood Control and Watershed Management Divisions. Title 26 (County of Los Angeles Building Code), Appendix J, also requires compliance with International Building Code provisions for preventing sedimentation. Additional mitigation is provided to ensure erosion, sedimentation, and construction-related pollutants are minimized during construction activities.

As a result, adherence to SWRCB/RWQCB standards and applicable mitigation measures would ensure that the Modified Project would result in less than significant impacts to water quality during construction.

Operations

Development in accordance with the Modified Project or the Approved Project would increase urban pollutants that can be carried offsite by stormwater runoff into downstream receiving waters (i.e., Santa Clara River). Urban pollutants may include roofing materials, atmospheric deposition, grease, oil, suspended solids, metals, solvents, and phosphates. Lawn maintenance and use of fertilizers and pesticides are also potential sources of pollutants that, if untreated, would result in impacts to natural drainage channels and the Santa Clara River.

5. Environmental Analysis

In terms of post-construction stormwater management, the Modified Project would have less of an impact than the Approved Project because the overall net imperviousness of the site and pollutants of concern would be reduced. Regardless, pursuant to existing regulations, the developer would complete and have approved a Stormwater Quality Management Plan (SQMP) and Standard Urban Stormwater Mitigation Plan (SUSMP) outlining BMPs for nonpoint-source pollution control measures to address urban pollutants. Implementation of the SQMP and SUSMP would reduce impacts to a less than significant level and would ensure that the Modified Project would not violate discharge requirements or water quality standards.

Compliance with regulatory standards, applicable mitigation measures, and BMPs would reduce water quality impacts to less than significant levels and ensure that the project would not violate discharge requirements or water quality standards. Adherence to these standards would ensure that operation of the Modified Project, like the Approved Project, would result in less than significant impacts related to water quality during operations.

- b) Substantially deplete groundwater supplies or interfere substantially with groundwater recharge such that there would be a net deficit in aquifer volume or a lowering of the local groundwater table level (e.g., the production rate of pre-existing nearby wells would drop to a level which would not support existing land uses or planned uses for which permits have been granted)?**

Minor Technical Changes or Additions. The project site would receive water supply from the Santa Clarita Water Division, which receives water from both groundwater and imported water sources from the Castaic Lake Water Agency, which receives water from the State Water Project. The Santa Clarita Valley has historically depended for its water supply on an underground water basin (the East Subbasin of the Santa Clara River Valley Groundwater Basin), or aquifer, divided into upper and lower levels. Overall, the groundwater basin covers about 84 square miles and includes a shallow upper basin, the Alluvial Aquifer, and a deeper layer called the Saugus Formation. The Modified Project would develop approximately 492 acres compared to the 622 acres that would be developed under the Approved Project. Since less land would be developed with impermeable surfaces, the Modified Project would have a beneficial impact on preserving pervious areas onsite and allowing more groundwater recharge. Therefore, the proposed modifications to Tract 46018-11 would not result in new substantial impacts.

- c) Substantially alter the existing drainage pattern of the site or area, including through the alteration of the course of a stream or river, in a manner which would result in substantial erosion or siltation on- or off-site?**

Minor Technical Changes or Additions. The existing drainage pattern onsite is by surface flow from northeast to southwest. Similar to the Approved Project, development of the Modified Project would include installation of onsite catch basins to catch surface water flow, which in turn would discharge into the existing storm drains and flood control channels in the City of Santa Clarita and ultimately discharge into the Santa Clara River. Erosion and siltation impacts potentially resulting from the Modified Project would, for the most part, occur during the project's sites preparation and grading phase. However, there is a potential for erosion and siltation to occur during project operation.

5. Environmental Analysis

Project Construction

As discussed in Section 5.10.2(a), the project applicant would be required to prepare and implement a SWPPP. The SWPPP would specify BMPs the project applicant would implement prior to and during grading and construction to minimize erosion and siltation impacts on- and offsite. Erosion controls include installation of mulch, geotextiles, mats, hydroseedings, earth dikes, and swales, and siltation controls include installation of barriers such as straw bales, sandbags, fiber rolls, and gravel bag berms, desilting basins, and cleaning measures (i.e., street cleaning).

Project Operation

As shown in Figure 6, *Modified Conceptual Lot Plan*, the project site would consist of impervious surfaces (residential homes, driveways, and other paved areas), but would mostly consist of significant amounts of open space and landscaped areas. The open space area west of the proposed realigned Skyline Ranch Road would not be disturbed, and the landscaped areas adjacent to the planned community would not be left exposed. Thus, there would be no substantial areas of bare or disturbed soil onsite that would be vulnerable to erosion. Additionally, details of the project's storm drain system and desilting basins would be provided in the final storm drain plans and grading plans to the satisfaction of the Los Angeles County Department of Public Works. As discussed in Section 5.10.2(a), compliance with required regulatory standards, mitigation measures, and BMPs would reduce water quality impacts to less than significant levels. Therefore, the proposed modifications to the approved TTM would not result in significant impacts.

- d) Substantially alter the existing drainage pattern of the site or area, including through the alteration of the course of a stream or river, or substantially increase the rate or amount of surface runoff in a manner which would result in flooding on- or off-site?**

Minor Technical Changes or Additions. See discussion in Section 5.10.2(c). The Modified Project would relocate proposed storm drains and desilting basins in the proposed roadways to connect with the existing storm drain system. Similar to the Approved Project, all storm drains and desilting basins would be designed to accommodate drainage from a 50-year storm event. The rate and volume of runoff from the proposed storm drains would not exceed the capacity of existing or the proposed future storm drains, and would not result in flooding on- or offsite. Additionally, all onsite and offsite drainage facilities would be designed and constructed in accordance with City of Santa Clarita and Los Angeles County standards and would be subject to review and approval by the County Flood Control District, County Department of Public Works, and City of Santa Clarita Public Works Department.

- e) Add water features or create conditions in which standing water can accumulate that could increase habitat for mosquitoes and other vectors that transmit diseases such as West Nile virus and result in increased pesticide use?**

No Impact. Similar to the Approved Project, existing and proposed storm drains and desilting basins have been designed to accommodate drainage onsite and prevent standing water from accumulating. The proposed project modifications would not include any water features, such as ponds and lakes, that could create standing water environments. Therefore, the Modified Project would not create habitat for mosquitoes or other vectors, and no impact would occur.

5. Environmental Analysis

- f) **Create or contribute runoff water which would exceed the capacity of existing or planned stormwater drainage systems or provide substantial additional sources of polluted runoff?**

Minor Technical Changes or Additions. See Section 5.10.2(c).

- g) **Generate construction or post-construction runoff that would violate applicable stormwater NPDES permits or otherwise significantly affect surface water or groundwater quality?**

Minor Technical Changes or Additions. As discussed in Section 5.10.2(a), the Modified Project would not create altered conditions that cause new significant impacts. Adherence to SWRCB and RWQCB standards would ensure that the Modified Project would result in less than significant impacts related to downstream water quality during construction.

- h) **Conflict with the Los Angeles County Low Impact Development Ordinance (L.A. County Code, Title 12, Ch. 12.84 and Title 22, Ch. 22.52)?**

Minor Technical Changes or Additions. The Los Angeles County Low Impact Development (LID) Ordinance encourages site sustainability and smart growth in a manner that respects and preserves the characteristics of the County's watersheds, drainage paths, water supplies, and natural resources. The development requirements of the LID ordinance went into effect January 1, 2009, and apply to any development where a complete discretionary or nondiscretionary permit is filed. Similar to the Approved Project, the Modified Project would be required to implement these design standards. Modifications would not alter the design of the project in a way that would introduce new significant impacts.

- i) **Result in point or nonpoint source pollutant discharges into State Water Resources Control Board-designated Areas of Special Biological Significance?**

No Impact. The project site is not in an Area of Special Biological Significance designated by the SWRCB and would not directly drain into one of these areas (SWRCB 2014). Similar to the Approved Project, the Modified Project would not cause any impacts.

- j) **Use onsite wastewater treatment systems in areas with known geological limitations (e.g., high groundwater) or in close proximity to surface water (including, but not limited to, streams, lakes, and drainage course)?**

No Impact. As with the approved TTM, the Modified Project does not include the use of septic tanks or other private sewer disposal systems. Wastewater would be collected via sewer pipes installed throughout the developable area onsite to connect with the existing sewer network. Therefore, no impacts would occur.

- k) **Otherwise substantially degrade water quality?**

Minor Technical Changes or Additions. As discussed in Sections 3.10.2(a) and 3.10.2(c), compliance with required regulatory standards and guidelines would reduce potential hydrology and water quality impacts to a less than significant level.

5. Environmental Analysis

- l) Place housing within a 100-year flood hazard area as mapped on a federal Flood Hazard Boundary or Flood Insurance Rate Map, or other flood hazard delineation map, or within a floodway or floodplain?**

Minor Technical Changes or Additions. According to the Federal Emergency Management Agency (FEMA) flood insurance rate map for the project area, two small southeast portions of the project site are located in areas designated as Zone A, which means the areas are subject to 100-year flood hazards, but no hydraulic analyses have been performed, and therefore no base flood elevations have been determined (FEMA 2008). Additionally, the County Floodway Map shows the same area designated FEMA Zone A along Sierra Highway as a County flood hazard zone for a 50-year storm event (Los Angeles 2014). Compared to the Approved Project, the Modified Project would not relocate housing or structures in the flood hazard zone. Instead, the modifications would result in a reduced development footprint within the Approved Project's footprint. Additionally, the construction of Skyline Ranch Road at Sierra Highway would be the same as under the Approved Project and consist of a bridge over a series of culverts and catch basins to allow water from Sierra Highway to flow southwesterly under Skyline Ranch Road to minimize the potential for flooding at the project's southwestern entrance and reduce the flow rate along Sierra Highway during a 50-year storm event. Therefore, the Modified Project would not introduce new substantial impacts to flood hazard zones.

- m) Place structures, which would impede or redirect flood flows, within a 100-year flood hazard area, floodway, or floodplain?**

Minor Technical Changes or Additions. See response to Section 5.10.2 (l), above.

- n) Expose people or structures to a significant risk of loss, injury or death involving flooding, including flooding as a result of the failure of a levee or dam?**

No Impact. Lake Castaic is approximately ten miles northwest of the project site and the nearest dam is the Bouquet Canyon Dam ten miles northeast of the site. Given the long distance from the project site, there is no risk of flooding to the site due to levee or dam failure. No new impacts would occur related to flooding and levee or dam failure.

- o) Place structures in areas subject to inundation by seiche, tsunami, or mudflow?**

No Impact. There are no aboveground water tanks, reservoirs, or artificial bodies of water near the project site that could cause inundation by seiches. Additionally, the project site is over 30 miles from the ocean and is not at risk of flooding due to a tsunami. No impact associated with seiches or tsunamis would occur.

At project completion, the developable area would consist of buildings, paved areas, and landscaped areas, and is not expected to pose a hazard of mudflow onsite or downstream from the site. The project would comply with mitigation measures concerning slope stability, soil erosion and sedimentation, and landslides as detailed in Section 5.7.3 (*Geology and Soils*) and below in Section 5.10.3; in addition, the construction phase of the project would use BMPs to minimize erosion, which would help reduce the potential for mudflows. No new significant impacts would result from project modifications or changed circumstances.

5. Environmental Analysis

5.10.3 Adopted Mitigation Measures Applicable to the Modified Project

Storm Drains and Flooding

- 4.B-1 Final drainage plans for the project shall ensure that there is no displacement of flood plain area in the vicinity of Sierra Highway and its intersection with proposed Skyline Ranch Road through construction of a culvert, bridge, or combination thereof, within the flood plain area. Final drainage plans and the culvert or bridge shall be designed during the engineering stage by a licensed engineer to ensure that the water surface shall be equal or lower than existing conditions both downstream and upstream of the proposed project entrance along Sierra Highway and adjacent properties during a 50-year storm event and that post-development flow rates shall be less than existing conditions downstream along Sierra Highway and adjacent properties. Final drainage plans to achieve these standards shall be designed to the satisfaction of, and approved by, the Los Angeles County Department of Public Works and City of Santa Clarita, Department of Public Works.

Erosion and Sedimentation

- 4.B-2 Prior to issuance of grading permits, the construction contractor shall prepare an Erosion Control Plan (ECP) that incorporates BMPs to specifically address and reduce the potential for erosion and sedimentation impacts on downstream receiving waters. The project shall include any combination of the following erosion control BMPs: Hydraulic mulch, preservation of existing vegetation, hydroseeding, streambank stabilization, diversion of runoff (such as earth dikes, temporary drains, slope drains), velocity dissipation devices (outlet protection, check dams, and slope roughening/terracing), and dust control measures (such as sand fences and watering). Sedimentation control BMPs may include filtration devices and barriers (such as silt fencing, check berms, debris basins, sediment traps, fiber rolls, sandbags, gravel inlet filters, and straw bale barriers) and/or settling devices (such as sediment traps or basins). Stabilization control BMPs may include blankets, reinforced channel liners, soil cement, fiber matrices, geotextiles, or other erosion resistant soil coverings or treatments. The construction entrance(s)/exit(s) should also be stabilized (e.g. aggregate underdrain with filter cloth). Specific application of these BMPs shall occur before site runoff is discharged to proposed and existing off-site storm drain/flood control channel systems that ultimately discharge water to the Santa Clara River.

The ECP shall be reviewed by the Los Angeles County Department of Public Works and by the Los Angeles Regional Water Quality Control Board for inclusion of appropriate and effective erosion and sedimentation controls.

Construction-Related Pollutants

- 4.B-3 Prior to issuance of any grading permits, a Notice of Intent (NOI) and a Storm Water Pollution Prevention Plan (SWPPP) shall be prepared by the construction contractor and submitted to the Los Angeles County Department of Public Works and the Los Angeles

5. Environmental Analysis

Regional Water Quality Control Board for approval. The SWPPP shall meet all applicable regulations by requiring controls of pollutant discharges that utilize best available technology economically achievable (BAT) and best conventional pollutant control technology (BCT) to reduce pollutants. The SWPPP shall be certified in accordance with the signatory requirements of the General Construction Permit.

The SWPPP shall be developed and amended or revised, when necessary to meet the following objectives:

- Identify all pollutant sources including sources of sediment that may affect the quality of storm water discharges associated with construction activity (storm water discharges) from the construction site;
- Identify non-storm water discharges;
- Identify, construct, implement in accordance with a time schedule, and maintain Best Management Practices (BMPs) to reduce or eliminate pollutants in storm water discharges and authorized non-storm water discharges from the construction site during construction; and,
- Develop a maintenance schedule for BMPs installed during construction designed to reduce or eliminate pollutants after construction is completed (post-construction BMPs). Paving operations shall be performed using measures to prevent runoff pollution.

In compliance with the SWPPP, non-stormwater level BMPs shall be implemented that include controls and objectives for vehicle and equipment maintenance, cleaning, and fueling, and potable water/irrigation practices. Material/waste management BMPs shall include: liquid waste management, spill prevention and control, hazardous waste management, and sanitary/septic waste management. Specific BMPs to be implemented by the construction contractor may include but are not necessarily limited to the following:

- Paving operations shall be performed using measures to prevent runoff pollution;
- Wash out areas for concrete trucks, construction vehicles and equipment, paint and stucco equipment, and other construction materials shall be designated, and containment measures employed, to prevent discharges of wash water;
- Vehicle and equipment maintenance and fueling activities shall occur offsite to the degree feasible;
- Construction area, street and pavement washing shall be controlled to preclude discharges of wash water;

5. Environmental Analysis

- Discharging super-chlorinated water pipe and sprinkler system flushing and test water to the storm drain system shall be prohibited;
- All waste shall be properly stored and disposed of off-site;
- Employees and subcontractors shall be trained in the prevention of storm water contamination;
- Hazardous material (specifically chlorine- and ammonia-containing products) shall be stored in elevated (e.g., on palates or a deck) and covered structures to prevent any contact between the chemicals and irrigation or precipitation;
- All hazardous and chemical materials generated during construction (i.e., diesel fuel, hydraulic fluid, motor oil, etc.) shall be cleaned up and disposed of in compliance with Federal, State, and local laws, regulations and ordinances; and
- All structure construction and painting areas shall be enclosed, covered, or bermed to prevent run-on/run-off in these areas and associated contamination of storm water.

Discharge of Urban-Related Pollutants

4.B-4 Prior to approval of a NPDES Stormwater Permit No. CAS004001 (Order No. 01-182) and issuance of a grading permit, the applicant or an applicant designee shall complete and have approved a Stormwater Quality Management Plan (SQMP) and a Standard Urban Stormwater Mitigation Plan (SUSMP) outlining usage of BMPs for non-point source pollution control measures to address pollutants from such sources as roofing materials, atmospheric deposition, grease, oil, suspended solids, metals, solvents, phosphates, fertilizers and pesticides. Post-construction structural or treatment BMPs shall be designed to meet performance standards that mitigate (treat) storm water runoff from either: (1) the 85th percentile 24-hour runoff event determined as the maximized capture storm water volume for the area, from the formula recommended in Urban Runoff Quality Management, WEF Manual of Practice No. 23/ASCE Manual of Practice No. 87, (1998), or; (2) the volume of annual runoff based on unit basin storage water quality volume, to achieve 80 percent or more treatment by the method recommended in California Stormwater Best Management Practices Handbook—Industrial Commercial, (1993), or; (3) the volume of runoff produced from a 0.75 inch storm event, prior to its discharge to a storm water conveyance system; and, (4) the volume of runoff produced from a historical record based reference 24-hour rainfall criterion for “treatment” (0.75 inch average for the Los Angeles County area) that achieves approximately the same reduction in pollutant loads achieved by the 85th percentile 24-hour runoff even. Furthermore, project BMPs and design features shall control peak flow discharge to provide stream channel and over bank flood protection, based on design criteria selected by the local agency.

The range of BMPs, which shall meet the performance standards identified above, shall include but not be limited to the following to the extent feasible:

5. Environmental Analysis

Site Planning and Design BMPs

Minimize Impervious Area and Directly Connected Impervious Areas

- Minimize impervious areas by incorporating landscaped areas over substantial portions of the project area. ~~[For the Skyline Ranch Project, the area designated solely for uses with impervious surfaces are about 401 acres or 18 percent of the entire project site. This means the remaining 1,772 acres or 82 percent will be either vacant or in uses with impervious ground surface such as landscaped and park areas.]~~
- If possible, minimize directly connected impervious areas by draining parking lots to landscaped areas, desilting (secondary infiltration) basins or other pervious surfaces to promote filtration and infiltration of storm water, if landscaping slopes are less than 2 percent and the area is not directly adjacent to steep slopes (which promotes further erosion); or the area is being treated with catch basin inserts. Furthermore, lot runoff (from the pervious surfaces) shall be infiltrated from the graded pad areas through onsite pervious soils.
- To the extent practicable, utilize vegetated areas (e.g., parks, setbacks, end islands, and median strips) for biofiltration and/or bioretention of nuisance and storm runoff flows from parking lots.

Selection of Construction Materials and Design Practices

- Select building materials for roofs, roof gutters and downspouts that do not include exposed copper or zinc.
- Construct streets, sidewalks, and parking lot aisles to the minimum widths as specified in the Los Angeles County Department of Public Work's requirements (also in compliance with regulations for the Americans with Disabilities Act) for safety requirements for fire and emergency vehicle access and incorporate landscaped buffer areas between sidewalks and streets.

Conserve Natural Areas

- Concentrate or cluster the development on the least environmentally sensitive portions of the project site while leaving the remaining land in a natural, undeveloped condition. [For the Skyline Ranch Project, about 1,551 acres of the site (71 percent of the project site) is proposed to remain undeveloped, including 1,355 acres to be designated as natural open space through the establishment of the Skyline Ranch Conservation Area (SRCA).]
- Maximize canopy interception and water conservation by preserving existing native trees and shrubs and planting additional native or drought tolerant trees and large shrubs. [For the Skyline Ranch Project, approximately 71 percent of the project site is proposed to

5. Environmental Analysis

remain undeveloped, and along the perimeter of the site, landscaping would consist of a mix of native, drought-tolerant and non-invasive plant species.]

Protect Slopes and Channels

- Protect slopes and minimize erosion potential by covering highly erodible soils with vegetative cover (preferably native or drought tolerant plants), route flows safely from or away from steep and or sensitive slopes, stabilize disturbed slopes. All slopes within the project should be designed and constructed to minimize erosion.
- Protect channels and minimize erosion by controlling and treating flows in landscaping and/or other controls prior to reaching existing natural drainage systems; stabilize channel crossings; ensure that increases in runoff velocity and frequency caused by the project do not erode the channel; install energy dissipaters (riprap), at the outlets of storm drains, culverts and conduits.

Source (non-structural) Control BMPs

- Drain Inlet Stenciling or Signage. Stenciling (or signage) is intended to raise public awareness and limit illegal dumping of trash, debris, oil, and other pollutants into storm drains. "Stenciling" may be accomplished via a traditional stencil or via the use of grates with text such as "Warning! Drains to Ocean" notes or other equivalent symbols. All catch basins and inlets shall be stenciled.
- Irrigation Controls and Management. Irrigation controls shall be implemented to ensure that irrigation is conducted efficiently. Where feasible, plants with similar watering requirements shall be grouped in order to reduce excess irrigation runoff and promote surface filtration. Efficient irrigation systems may include computerized and/or radio telemetry that controls the amount of irrigation based on soil moisture or other indicators.
- Proper Application of Fertilizers and Pesticides. Best management practices shall be implemented to minimize the application of fertilizers, pesticides, and other landscape management products on slopes and landscaped areas maintained by the homeowners' association (HOA) and/or landscape maintenance districts (if any). Examples of these management practices include, but are not to limited to: the use of slow release fertilizers, applying fungicides only to greens to limit the use of pesticides, and closely monitoring weather forecast to ensure appropriate timing (during dry periods) for the application of landscape management products.
- Community Education Program. Public education shall be used to reduce the potential for hazardous materials entering the storm drain system. This shall be accomplished through distribution of brochures or other materials to property managers, owners and occupants, and employees at the time of initial sale or lease of property or hiring of employees and periodically thereafter. Brochures shall discuss, among other topics and

5. Environmental Analysis

as appropriate for the audience: 1) the importance of downstream water bodies, the storm water system, management of fertilizers, pesticides, and other harmful chemicals, 2) the impacts of dumping oil, antifreeze, pesticides, paints, and other pollutants into storm drains and proper handling and disposal of these materials, 3) effective cleaning practices such as the cleaning of vehicles only in maintenance areas where the water will be recycled or routed to the sanitary sewer system to prevent nuisance flows, 4) the benefits of the prevention of excessive erosion and sedimentation, 5) the benefits of proper landscaping practices, 6) pavement clean-up practices, 7) the impacts of over-irrigation, 8) swimming pool draining practices, and 9) other relevant issues.

- Prevention of Nuisance Flows. Grease traps shall be included for school cafeterias (if any). Draining swimming pools into storm drains shall be prohibited. These flows shall be properly connected to sewer lines.
- Pavement Sweeping Program. The majority of roads in the project area are proposed to be dedicated to the public, and would thus be maintained by the Los Angeles County Department of Public Works. The County has street sweeping programs that will help control trash, vegetation debris and sediment that may accumulate on roadways. Other non-public roadways shall also be periodically swept.
- Litter Control Program & Design of Trash Storage Areas. A program for litter control shall be implemented to control litter in common areas. The program may include standards for proper placement and emptying of trash receptacles, practices to ensure that trash bins are maintained in the closed position, and regular removal of trash from parking and landscaped areas. In conjunction with the litter control program, trash storage areas shall be designed to prevent introduction of pollutants into runoff. The design principles to prevent this pollution from occurring are using impervious surfaces for storage areas which prevent run-on from adjacent areas, ensuring that there is no connection of trash drains to the storm drain system, and keeping lids on all trash receptacles in addition to the use of roofs or awnings to minimize direct precipitation.
- Proper Connection and Maintenance of Sewer Lines. Sewer lines shall be properly connected and adequately maintained.
- Activity Restrictions (Conditions, Covenants, and Restrictions). For source control BMPs, County maintenance and implementation of BMPs or Conditions, Covenants, and Restrictions (CC&Rs) shall be prepared requiring maintenance and implementation of BMPs by the HOA for the purpose of surface water quality protection, or use restrictions shall be developed through lease terms.
- BMP Maintenance. Los Angeles County shall assume responsibility for the inspection and maintenance of structural BMPs within their boundaries. For the public school site, the school district with jurisdiction shall be responsible for the inspection and

5. Environmental Analysis

maintenance of structural BMPs. For private roads and private parks the HOA shall be responsible for BMP maintenance.

- Common Area Drainage Facility Inspection. Privately-owned common area drainage facilities shall be inspected each year and, if necessary, cleaned and maintained prior to the storm season.

Structural and Treatment Control BMPs

Implementation of NPDES General Permit requirements entails the use of post-construction structural controls that will remain in service to protect water quality throughout the life of the project. Therefore, these BMPs will need to be regularly maintained for proper function. As Los Angeles County will assume maintenance of BMPs in public rights-of-way, the main structural BMPs recommended below are systems that the County currently approves of for use within their jurisdiction. Final selection, design and siting of structural BMPs will ultimately depend on the project-wide drainage plan approved by the County. The following BMP options were selected due to their relative effectiveness for treating potential pollutants from the project site; as well as consideration for County of Los Angeles requirements and acceptance of these systems (as they would be maintained by the County), site feasibility, relative costs and benefits; and other constraints. The recommended BMP design flow rates, volumes, types and other specifications will be provided during final design stage of the project (with hydrology map approval).

- Hydrodynamic Separator Systems and Gross Solids Removal Devices. Hydrodynamic Separation Systems (HSS) and Gross Solids Removal Devices (GSRDs) are flow-based, flow-through BMPs that are installed within a storm drain line in order to remove large sediment particles and associated storm water pollutants, as well as trash, oils, and grease. HSS and/or GSRDs, such as a Continuous Deflective Separator (CDS), manufactured by CDS Technologies, Inc., supplemented with oil absorbent materials (such as pellets), are recommended for use at various locations in the proposed storm drain systems. Depending on the particular model and manufacturer, maintenance shall occur quarterly to yearly for clean-outs. Cleaning after a storm event may also be required. Inspection is required to make certain that the unit is operating correctly and to make any repairs.
- Stormscreen. The StormScreen is a manufactured patented BMP by CONTECH Stormwater Solutions, Inc., designed to remove mostly trash and debris and larger suspended solids at high flow rates. The StormScreen is comprised of a grouping of StormScreen cartridges placed in a precast or cast-in-place concrete vault. Although maintenance may be required within six (6) months of project completion due to erosion occurring on newly constructed sites, it is intended that the StormScreen be maintained annually by the Los Angeles County Department of Public Works, Flood Control Division. For the StormScreen maintenance, during the first year, an inspection is recommended every other month for the first six months of operation in order to

5. Environmental Analysis

develop an ongoing maintenance schedule. A visual inspection can be conducted without entering the vault. Sediments and water must be disposed of in accordance with all applicable waste disposal regulations.

- **Catch Basin Inserts.** Catch basin inserts are flow-based BMP options for consideration at various locations to treat runoff before it enters the storm drain system by filtering or screening out sediments and associated storm water pollutants during dry weather and low flow events. During large flow events, they are typically designed to allow storm water runoff to bypass the inlet device and continue directly into the storm drain system. Although treatment levels are generally low for the pollutants of concern for this project, the inserts would provide pre-treatment of storm water runoff prior to further treatment at downstream BMPs. Drainage inserts could be replaced with HSS or GSRDs that perform similar functions and are interchangeable. At the time of final design, if the implementation of a CDS is deemed infeasible, a catch basin insert may be used in its place. Although maintenance requirements vary greatly depending on the particular model and manufacturer, they are typically maintained quarterly to yearly for clean-outs. Cleaning after a storm event and in anticipation of storm events after extended dry periods or periods of typical debris removal is recommended. Inspection will be required to make certain that the unit is operating correctly and to make any repairs.
- **Detention/Retention Basins.** Detention and retention basins require a fairly large amount of space to build them. Basins can be used on sites with slopes up to about 15 percent. The design should incorporate enough elevation drop from the basins inlet to the outlet to ensure that flow can move through the system. These systems require regular maintenance (semi-annual and annual), as well as sediment removal from the forebay every 5 to 7 years and monitoring the sediment accumulation and removal when the volume has been significantly reduced (about every 25 to 50 years). Basins shall be properly maintained to avoid safety hazards.

5.10.4 Level of Significance After Mitigation

The Modified Project would only result in minor technical changes or additions to the previously certified EIR, and would not result in significant impacts upon implementation of applicable regulatory requirements and mitigation measures.

5.11 LAND USE AND PLANNING

5.11.1 Summary of Impacts Identified in the Certified EIR

This section summarizes the analysis contained in Section 4.Q, *Land Use*, of the 2010 Certified EIR.

The 2010 Certified EIR concluded that land use impacts associated with the Approved Project would be less than significant. The Approved Project consists of a residential development that supports and encourages

5. Environmental Analysis

the efficient use of infrastructure facilities by placing housing adjacent to existing development; concentrating development in an area via a density transfer to preserve environmentally sensitive lands; developing land uses (such as paseos, bike lanes and hiking trails) that create opportunities for residents to walk and bike; and preserving open space. Project implementation would increase the supply of housing to accommodate the region's growth. The proposed infrastructure improvements and the provision of an on-site school and parks would serve the residents' demand for public services. Therefore, the Approved Project would be consistent with the Southern California Association of Governments' Regional Transportation Plan. Additionally, the project would be supportive of and consistent with the Los Angeles County General Plan policies.

5.11.2 Impacts Associated with the Modified Project

Would the Modified Project:

Issues	Substantial Change in Project or Circumstances Resulting in New Significant Effects	New Information Showing Greater Significant Effects than Previous EIR	New Mitigation or Alternative to Reduce Significant Effect is Declined	Minor Technical Changes or Additions	No Impact
a) Physically divide an established community?				X	
b) Be inconsistent with the applicable County plans for the subject property including, but not limited to the General Plan, specific plans, local coastal plans, area plans, and community/neighborhood plans?				X	
c) Be inconsistent with the County zoning ordinance as applicable to the subject property?					X
d) Conflict with Hillside Management criteria, Significant Ecological Areas conformance criteria, or other applicable land use criteria?					X

Comments:

a) Physically divide an established community?

Minor Technical Changes or Additions. The realignment of Skyline Ranch Road within the project site would enhance the Skyline Ranch community in comparison to its planned alignment under the Approved Project (see Figure 4, *Approved TTM vs. Proposed Concept Plan*). By realigning the roadway, the entire residential community would be developed on the east side of Skyline Ranch Road, rather than divided by the approved alignment. This modification would enhance and centralize the planned Skyline Ranch community, which would be a beneficial impact. Additionally, the inclusion of age-qualified homes and a community center in the northern portion of the developable area would further benefit the community. The other modifications to the Approved Project (i.e., reduced residential lots, modified housing product type, and relocation of park sites) would have no impact on dividing communities. Overall, the Modified Project would be a beneficial change from the Approved Project.

5. Environmental Analysis

- b) Be inconsistent with the applicable County plans for the subject property including, but not limited to the General Plan, specific plans, local coastal plans, area plans, and community/neighborhood plans?**

Minor Technical Changes or Additions. The proposed project would modify Approved TTM 60922 within the development footprint analyzed in the 2010 Certified EIR. Modifications include a realignment of Skyline Ranch Road, reduction of 40 residential lots (but inclusion of 284 units of age-qualified homes and a community center), modifications to housing product types, relocation and expansion of park and recreation center sites, and extension of multipurpose trails and bike lanes. These minor technical changes would be consistent with all applicable County plans, including the Los Angeles County General Plan and Santa Clarita Area Plan.

- c) Be inconsistent with the County zoning ordinance as applicable to the subject property?**

No Impact. Based on the Santa Clarita Valley Area Plan Zoning Map, the project site is zoned as R-1 (Single-family residence), A-1-2 (Light agriculture), and A-2-2 (Heavy agriculture) (Los Angeles 2012b). The Modified Project would only develop 492 acres (zoned R-1) in the southern portion of the 2,173-acre project site. The remaining 1,681 acres zoned Agriculture would not be developed. Thus, no impact would occur.

- d) Conflict with Hillside Management criteria, Significant Ecological Areas conformance criteria, or other applicable land use criteria?**

No Impact. See response to Sections 3.4.2(f) and 3.7.2(f), above.

A portion of the Cruzan Mesa Vernal Pools SEA falls within the northern portion of the project site. However, this northern portion is outside of the 492 acres of developable land onsite. Therefore, no impact would occur.

5.11.3 Adopted Mitigation Measures Applicable to the Modified Project

The 2010 Certified EIR did not include mitigation measures related to land use and planning.

5.11.4 Level of Significance After Mitigation

The Modified Project would only result in minor technical changes or additions to the previously certified EIR, and would not result in significant impacts related to land use and planning.

5.12 MINERAL RESOURCES

5.12.1 Summary of Impacts Identified in the Certified EIR

Impacts to mineral resources were closed out in the Initial Study prepared for the 2010 Certified EIR. The Approved Project would not result in the loss of known mineral resources or locally-important mineral resource recovery site. No impact would occur.

5. Environmental Analysis

5.12.2 Impacts Associated with the Modified Project

Would the Modified Project:

Issues	Substantial Change in Project or Circumstances Resulting in New Significant Effects	New Information Showing Greater Significant Effects than Previous EIR	New Mitigation or Alternative to Reduce Significant Effect is Declined	Minor Technical Changes or Additions	No Impact
a) Result in the loss of availability of a known mineral resource that would be of value to the region and the residents of the state?					X
b) Result in the loss of availability of a locally-important mineral resource recovery site delineated on a local general plan, specific plan or other land use plan?					X

Comments:

- a) **Result in the loss of availability of a known mineral resource that would be a value to the region and the residents of the state?**

No Impact. Modifications to the Approved Project would be implemented within the development footprint already analyzed in the 2010 Certified EIR. Therefore, similar to the Approved Project, no impact would occur to any known mineral resources or locally important mineral resource recovery sites.

- b) **Result in the loss of availability of a locally important mineral resource recovery site delineated on a local general plan, specific plan or other land use plan?**

No Impact. See Section 5.12.2 (a), above.

5.12.3 Adopted Mitigation Measures Applicable to the Modified Project

No mitigation measures related to mineral resources were outlined in the 2010 Certified EIR.

5.12.4 Level of Significance After Mitigation

The Modified Project would have no impact on mineral resources.

5.13 NOISE

5.13.1 Summary of Impacts Identified in the Certified EIR

This section summarizes the analysis contained in Section 4.G, *Noise*, of the 2010 Certified EIR.

5. Environmental Analysis

Construction Noise and Vibration

Occupied noise-sensitive uses with an uninterrupted line of sight to the construction noise sources could periodically be exposed to temporary noise levels that exceed the County's construction noise standards (depending on the location of the uses), which would be a significant impact. For example, onsite grading and building construction activities could occur as close as 25 feet from existing residential subdivisions to the west of the project site, and construction of offsite infrastructure improvements at Sierra Highway would also occur within 25 feet of existing residential homes. Grading activities involving heavy-duty construction equipment would exceed the County's 60 dBA construction noise thresholds of significance. Although temporary, these impacts were found to be **significant and unavoidable** even with implementation of feasible mitigation measures.

Ground-borne vibration would be generated primarily during the site clearing, grading, and soils compaction processes. Vibration values from bulldozer and heavy truck operations are below the architectural damage threshold of 0.2 inch per second as well as the annoyance PPV threshold of 0.1 inch per second for all vibration-sensitive receptors. Therefore, vibration impacts associated with construction would be less than significant.

Operational Noise and Vibration

As detailed in Section 5.17, *Transportation and Traffic*, the Approved Project would generate approximately 13,121 vehicle trips. The proposed residences onsite that are within 50 feet from Skyline Ranch Road right-of-way central to the project site would experience a noise level in excess of 60 dBA CNEL without mitigation. Point-source impacts (e.g., people talking, air conditioning units, lawn care equipment, domestic animals) would not exceed ambient noise level standards and would be consistent with adjacent uses in the project vicinity. However, the proposed school and park sites could generate noise levels in excess of the standards in the County code for single-family residences. Impacts would be significant; therefore, mitigation is provided.

Additionally, offsite roadway noise levels were also calculated at various sensitive receptors along arterial and highway segments. Noise levels at these sensitive uses are already considered unacceptable; therefore, offsite mobile noise levels associated with the Approved Project would result in **significant and unavoidable** impacts. Cumulative noise impacts at sensitive receptors along segments of Sierra Highway and Whites Canyon Road would also be **significant and unavoidable**.

5. Environmental Analysis

5.13.2 Impacts Associated with the Modified Project

Would the Modified Project result in:

Issues	Substantial Change in Project or Circumstances Resulting in New Significant Effects	New Information Showing Greater Significant Effects than Previous EIR	New Mitigation or Alternative to Reduce Significant Effect is Declined	Minor Technical Changes or Additions	No Impact
a) Exposure of persons to, or generation of, noise levels in excess of standards established in the County General Plan or noise ordinance (Los Angeles County Code, Title 12, Chapter 12.08), or applicable standards of other agencies?				X	
b) Exposure of persons to or generation of excessive groundborne vibration or groundborne noise levels?				X	
c) A substantial permanent increase in ambient noise levels in the project vicinity above levels existing without the project, including noise from parking areas?				X	
d) A substantial temporary or periodic increase in ambient noise levels in the project vicinity above levels existing without the project, including noise from amplified sound systems?				X	
e) For a project located within an airport land use plan or, where such a plan has not been adopted, within two miles of a public airport or public use airport, would the project expose people residing or working in the project area to excessive noise levels?					X
f) For a project within the vicinity of a private airstrip, would the project expose people residing or working in the project area to excessive noise levels?					X

Comments:

- a) **Exposure of persons to, or generation of, noise levels in excess of standards established in the County General Plan or noise ordinance (Los Angeles County Code, Title 12, Chapter 12.08), or applicable standards of other agencies?**

Minor Technical Changes or Additions.

Mobile Source Impacts

Noise impacts from operation of the Modified Project would occur primarily from project-generated traffic. The Modified Project would eliminate 40 single-family dwelling units, which would reduce vehicle trips compared to the Approved Project. Traffic noise generated by the Modified Project would be slightly below that estimated for the Approved Project, and no new significant impacts would occur as a result of the Modified Project or as a result of changed circumstances.

5. Environmental Analysis

Stationary Source Impacts

Project implementation would result in the generation of noise from stationary sources related to the planned single-family homes (e.g., heating, ventilation, and air conditions units). By eliminating 40 single-family homes, stationary-source noise impacts associated with the Modified Project would be reduced compared to the Approved Project. No new significant impacts would occur as a result of the project modifications.

b) Exposure of persons to or generation of excessive groundborne vibration or groundborne noise levels?

Minor Technical Changes or Additions. The Modified Project would result in the construction of 40 fewer single-family residential dwelling units on a reduced development footprint compared to the Approved Project. In general, construction equipment associated with the Modified Project would be the same as for the Approved Project; however, the construction schedule may be shorter for less development. Therefore, groundborne vibration and noise impacts would likely be lessened under the Modified Project.

c) A substantial permanent increase in ambient noise levels in the project vicinity above levels existing without the project, including noise from parking areas?

Minor Technical Changes or Additions. As described in Section 5.13.2(a), operational noise levels related to the Modified Project would be similar or slightly reduced in comparison to the Approved Project. Therefore, the Modified Project would not introduce new substantial ambient noise impacts.

d) A substantial temporary or periodic increase in ambient noise levels in the project vicinity above levels existing without the project, including noise from amplified sound systems?

Minor Technical Changes or Additions. The operation of the Modified Project would not involve the use of amplified sound systems. Temporary noise levels associated with construction activities would be higher than the project area's existing ambient noise levels, but would subside once construction of the proposed project were completed. Generally, two types of short-term noise impacts could occur during construction: 1) mobile-source noise from transport of workers and material deliveries and 2) stationary construction noise from use of onsite equipment. Construction noise from on-road vehicles associated with the Modified Project would be similar to the Approved Project because it would likely generate a similar number of construction worker and vendor trips.

In general, construction activities associated with the Modified Project would require the same type of construction equipment as the Approved Project and therefore would generate similar magnitudes of noise. Since the Modified Project would involve constructing 40 fewer residential units within a reduced development footprint, construction activities would be slightly reduced. Therefore, the Modified Project would not introduce new substantial temporary noise impacts.

5. Environmental Analysis

- e) **For a project located within an airport land use plan or, where such a plan has not been adopted, within two miles of a public airport or public use airport, would the project expose people residing or working in the project area to excessive noise levels?**

No Impact. The Skyline Ranch project site is not within an airport land-use plan or within two miles of a public use airport. The nearest major airport, Bob Hope Airport in Burbank, is over 17 miles to the south of the project site. The nearest public airport, Agua Dulce Airpark, is over 9 miles northeast of the project site. The residents and workers of the Modified Project would not be exposed to excessive noise levels from a public airport. No impact would occur.

- f) **For a project within the vicinity of a private airstrip, would the project expose people residing or working in the project area to excessive noise levels?**

No Impact. There are no private airstrips near the project site. The residences and workers onsite would not be exposed to excessive noise levels from a private airstrip. No impact would occur.

5.13.3 Adopted Mitigation Measures Applicable to the Modified Project

Construction Noise

(1) Movement of Construction Equipment Noise

- 4.G-1(a) Construction truck routes and equipment shall, to the extent feasible, avoid residential areas and roadways adjacent to noise sensitive receptors.
- 4.G-1(b) Wherever heavy duty truck traffic associated with project construction utilizes roadways with adjacent noise sensitive receptors, the trucks shall avoid peak hour traffic in order to minimize potential truck idling in proximity to these receptors.

(2) Grading/Building Construction Noise

- 4.G-2(a) All construction activities within 300 feet of an occupied single- or multifamily residential lot shall be restricted to between the hours of 7:00 A.M. and 7:00 P.M. Monday through Friday, and between 8:00 A.M. and 6:00 P.M. on Saturday. Construction work shall be prohibited on Sundays, New Year's Day, Independence Day, Thanksgiving Day, Christmas Day, Memorial Day, and Labor Day.
- 4.G-2(b) The construction contractor shall provide at least 72-hour advance notice of the start of construction activities to all noise sensitive uses within 300 feet of on-site and off-site occupied residences. Notification shall be by mail. The announcement shall state specifically where and when construction activities will occur, and provide contact information for filing noise complaints. Notices shall provide tips on reducing noise intrusion, for example, by closing windows facing the planned construction.
- 4.G-2(c) When construction operations occur within 300 feet of on- or off-site occupied residences, all feasible measures to reduce construction equipment noise levels at the residences shall be

5. Environmental Analysis

employed. These measures shall include among other things changing the location of stationary construction equipment to increase the distance between the equipment and the receptors, shutting off idling equipment, notifying residents in advance of construction work, and installing temporary acoustic barriers around stationary construction noise sources.

- 4.G-2(d) Prior to construction of structures on the residential lots east of existing residences east of Falcon Crest Drive and Bakerton Avenue, temporary acoustic barriers, shall be erected along the rear lot lines within 300 feet of the western site boundary. The extent of this requirement, including the height, length, number of properties, etc., shall be determined by an acoustical consultant retained by the applicant with access to project-related design and construction information. These barriers may be constructed of any solid material, shall be continuous with no gaps, and shall remain in place until building construction on these lots is completed.

Operational Noise

(1) On-Site Roadway Noise

- 4.G-3(a) Prior to construction of any residential development along Skyline Ranch Road a detailed acoustical analysis report prepared by a qualified acoustical consultant shall be submitted to the County for review and approval. For all on-site single family residences that have rear and/or side yard lines within 100 feet from the centerline of the proposed Skyline Ranch Road, the acoustical analysis report shall describe and quantify the noise sources impacting the area and the measures required to meet the 60 dBA CNEL residential noise standard. Based on a preliminary acoustical analysis included in Appendix G of ~~the~~ **Skyline Ranch** Draft EIR, the placement of a 6-foot high solid masonry wall is recommended at the locations shown in Appendix G, Figures 1 through 8, in order to achieve this noise standard.
- 4.G-3(b) Balconies, greater than six (6) feet in depth, are considered exterior living areas and must also meet the exterior noise standard. Therefore, balconies shall either be discouraged from exposure to exterior noise levels greater than the 65 dBA CNEL (residences that are within 50 feet from the edge of the proposed Skyline Ranch Road) standard for single-family residences through architectural or site design, or balconies shall be enclosed by solid noise barriers, such as 3/8-inch glass or 5/8-inch Plexiglas or other equally effective construction materials to a height specified by a qualified noise consultant.
- 4.G-3(c) All on-site single-family residences within 50 feet of the Skyline Ranch Road right-of-way shall include whole-house air conditioning so that windows facing the roadway may be closed without compromising a comfortable interior living environment.

(2) Point Source Noise

5. Environmental Analysis

4.G-4(a) Prior to issuance of building permits, a detailed acoustical analysis study shall be prepared by a qualified acoustical consultant for all on-site single family residences that have rear and/or side yard lines within line-of-site of the proposed school and/or park and shall be submitted to the County. This acoustical analysis report shall describe and quantify the noise sources impacting the area. In the event the report shows that noise levels for the residences would exceed applicable standards, measures shall be required to reduce noise to levels that are within applicable standards. Such measures may include:

- Locate student pick-up/drop-off and parking areas as far away from residences as feasible;
- Arrange school buildings such that they will provide shielding between the play field and the residences; or
- Provide acoustical walls with sufficient mass, length and height to break the line-of-sight between the residences and the play field.

The acoustical analysis report shall be subject to review and approval by the County and shall ensure compliance with applicable noise standards in the County Code.

4.G-4(b) Prior to completion of plans for the proposed elementary school and public park, a detailed acoustical analysis report shall be prepared by a qualified acoustical consultant in consultation with the Sulfur Springs School District and the County of Los Angeles Department of Parks and Recreation. The requirements set forth in the report shall ensure that on-site single family residences that have rear and/or side yard lines within line-of-site of the proposed school and/or park are not subject to unacceptably high levels of noise (i.e., noise levels in excess of the standards provided in the County Code) from school yard or park activities. The acoustical analysis report, subject to review and approval by the County, shall include requirements relating to the locations of courts and playfields and the materials and heights of property walls as necessary to support compliance with applicable noise standards in the County Code.

5.13.4 Level of Significance After Mitigation

The Modified Project would only result in minor technical changes or additions to the previously certified EIR, and would not result in significant impacts upon implementation of applicable regulatory requirements and mitigation measures.

5.14 POPULATION AND HOUSING

5.14.1 Summary of Impacts Identified in the Certified EIR

This section summarizes the analysis contained in Section 4.R, *Population, Housing and Employment*, of the 2010 Certified EIR.

5. Environmental Analysis

The 2010 Certified EIR concluded that impacts to population and housing would be less than significant. The Approved Project would allow for up to 1,260 residential units and 4,158 residents (based on an average household size of 3.3 persons per household). Based on SCAG’s adopted growth forecasts for the regional, subregional, and local areas, the project-generated population represented only 0.6, 1.6, and 6.0 percent of the total forecast population, respectively.

The 1,260 units proposed under the Approved Project represents a total of 0.4 percent, 1.6 percent, and 5.5 percent of the total housing unit growth projected by SCAG for the regional, subregional, and local areas during that period, respectively.

Additionally, the proposed school and park would generate 62 new jobs. The employment opportunities generated by the project represent 0.32 percent of the SCAG employment growth forecast for the local area, which is negligible. The relative employment for the regional and subregional areas is less.

Overall, population and housing impacts were concluded to be less than significant.

5.14.2 Impacts Associated with the Modified Project

Would the Modified Project:

Issues	Substantial Change in Project or Circumstances Resulting in New Significant Effects	New Information Showing Greater Significant Effects than Previous EIR	New Mitigation or Alternative to Reduce Significant Effect is Declined	Minor Technical Changes or Additions	No Impact
a) Induce substantial population growth in an area, either directly (for example, by proposing new homes and businesses) or indirectly (for example, through extension of roads or other infrastructure)?				X	
b) Displace substantial numbers of existing housing, especially affordable housing, necessitating the construction of replacement housing elsewhere?					X
c) Displace substantial numbers of people, necessitating the construction of replacement housing elsewhere?					X
d) Cumulatively exceed official regional or local population projections?				X	

Comments:

a) Induce substantial population growth in an area, either directly (for example, by proposing new homes and businesses) or indirectly (for example, through extension of roads or other infrastructure)?

Minor Technical Changes or Additions. In comparison to Approved TTM 60922, the Modified Project would allow for 1,220 single-family homes rather than 1,260 homes. This would reduce the expected population onsite by 139 persons (see Table 9).

5. Environmental Analysis

Table 9 Approved Project vs. Modified Project – Population

Tract 60922	Number of Residential Units	Generation Rate (persons per household)	Total Population
Approved	1,260	3.46	4,360
Modified	1,220	3.46	4,221
Difference	-40 Units	—	-139 Persons

Thus, while population growth would occur upon development of the Modified Project, the 40-unit reduction from the Approved Project would reduce the project’s total population. Impacts would be less than significant.

b) Displace substantial numbers of existing housing, especially affordable housing, necessitating the construction of replacement housing elsewhere?

No Impact. Neither the Approved TTM 60922 nor the Modified Project would displace substantial numbers of existing housing, because the site is vacant and undeveloped. The Modified Project would allow for up to 1,220 residential units compared to 1,260 units under the Approved Project. Existing housing would not be displaced, and no impact would occur.

c) Displace substantial numbers of people, necessitating the construction of replacement housing elsewhere?

No Impact. As stated in Section 5.14.2(b), Approved TTM 60922 and the Modified Project would not displace residents from the project site because the site is currently vacant and undeveloped. The Modified Project would allow for up to 1,220 single-family homes, which would generate a population of approximately 4,221 persons. This is a rate of 3.46 persons per household taken from the 2010 US Census Bureau for Los Angeles County Tracts 9200.32, 9200.33, and 9200.34. No impact would occur.

d) Cumulatively exceed official regional or local population projections?

Minor Technical Changes or Additions. According to the 2010 US Census Bureau for Los Angeles County Tracts 9200.32, 9200.33, and 9200.34, the average household size is 3.46 persons. Applying this average household size, development of the Modified Project would add approximately 4,221 additional residents to the existing population, 139 fewer residents than Approved TTM 60922 (see Table 9). The Approved Project would not cumulatively exceed official regional or local population projections. Thus, given that the Modified Project would result in fewer residents, impacts would not result in significant cumulative growth.

Furthermore, as discussed in Section 5.18, *Utilities and Service Systems*, adequate infrastructure and utilities are available in the immediate vicinity of the project site, and no substantial new infrastructure or extension of existing infrastructure would be required that could directly induce additional population growth in the project area. Impacts would be less than significant.

5. Environmental Analysis

5.14.3 Adopted Mitigation Measures Applicable to the Modified Project

The 2010 Certified EIR did not include mitigation measures related to population and housing.

5.14.4 Level of Significance After Mitigation

The Modified Project would only result in minor technical changes or additions to the previously certified EIR, and would not result in significant impacts.

5.15 PUBLIC SERVICES

5.15.1 Summary of Impacts Identified in the Certified EIR

This section summarizes the analysis contained in Sections 4.L, *Law Enforcement Services*, 4.M, *Fire Services and Hazards*, 4.N, *Education*, and 4.O, *Libraries*, of the 2010 Certified EIR.

Law Enforcement Services

Primary law enforcement protection services to the project site are provided by the Los Angeles County Sheriff's Department, and traffic regulation enforcement and traffic incident response are provided by the California Highway Patrol (CHP). The nearest sheriff's station is the Santa Clarita Valley Station, approximately five miles from the site. The nearest CHP station is the Newhall Ranch Station, approximately eight miles from the site. Based on the Certified EIR, implementation of the Approved Project would increase calls for service and demand on the Santa Clarita Valley Sheriff's station. Under Chapter 22.74 of the Los Angeles County Code, the project is subject to developer impact fees that would fully fund the project's share of capital improvements and reduce the project's impacts on police services. Additionally, development in accordance with the Approved Project would increase annual revenues in the form of taxes (e.g., income, property, sales tax). The project-generated revenue would be deposited in the County's General Funds, which would allocate a portion for the Sheriff's Department's services.

The Approved Project would also increase demand on CHP services and further extend existing resources for traffic control and incident responses if additional staffing and upgrades are not adequately funded in the future. The Certified EIR concluded that if sufficient County and state funds were not allocated to support increases in law enforcement services in the area, project-related impacts to the Los Angeles County Sheriff's Department and CHP would be **significant and unavoidable**.

Fire Services and Hazards

The Los Angeles County Fire Department (LACoFD) provides fire protection services to the project site. The closest fire stations are Fire Station 107 in Canyon Country and Fire Station 128 in Santa Clarita, approximately 1.0 mile south and 3.7 miles west of the site, respectively. Buildout of the Approved Project would require additional staff, equipment, and facilities. The project would be required to pay developer impact fees pursuant to the Los Angeles County Fire Department's Developer fee program, which would help fund land acquisition, facility improvements, and new equipment. Additionally, the County's General

5. Environmental Analysis

Funds would proportionally increase with project-generated tax revenue from development of the Approved Project.

The project site is in an area highly susceptible to wildfires and is designated a Very High Fire Hazard Severity Zone (VHFHSZ) due to the Santa Clarita Valley weather conditions and the topography and vegetation onsite. Because the site is in a VHFHSZ, the Approved Project would be required to prepare a fuel modification plan, a landscape plan, and an irrigation plan. The Approved Project would also be required to adhere to applicable standards in the County Fire Code, Building Code, and California Fire Code. Mitigation measures are proposed to ensure fire hazards are reduced to less than significant levels.

Education

The project site is within the attendance boundaries of the Sulphur Springs School District (SSSD), Saugus Union School District (SUSD), and William S. Hart Union High School District (HUHSD). The Approved Project included an 11-acre school site that would be developed, operated, and maintained by SSSD. Approximately 305 elementary school students would be generated in SSSD by the Approved Project. These students would be accommodated by the proposed SSSD elementary school on-site, which has a proposed capacity of 750 students. In addition, the Approved Project would generate approximately 178 elementary school students within SUSD, and approximately 160 junior high students and 301 senior high students in HUHSD. Under the provisions of SB 50, the payment of developer fees is “deemed to provide full and complete school facilities mitigation” for purposes of CEQA.

Libraries

The Canyon Country Jo Anne Darcy Library would service the project residents and is approximately 1.15 miles from the site. Project residents would increase the demand for library services and resources (i.e., items, facility space, and staffing). Since the Darcy Library currently has a deficit of 88,070 items and 21,345 square feet of library space, the project would contribute to this deficit and further hinder the library’s efforts to meet its service guidelines. However, the project would be subject to the payment of library impact fees pursuant to Section 22.72 of the Los Angeles County Code. Fees would be used to compensate for the project’s increased demand for library resources. The County Public Library has indicated that payment of fees would mitigate the project’s impacts on libraries to less than significant.

5.15.2 Impacts Associated with the Modified Project

Would the Modified Project result in substantial adverse physical impacts associated with the provision of new or physically altered governmental facilities, need for new or physically altered governmental facilities, the construction of which could cause significant environmental impacts, in order to maintain acceptable service ratios, response times or other performance objectives for any of the public services:

5. Environmental Analysis

Issues	Substantial Change in Project or Circumstances Resulting in New Significant Effects	New Information Showing Greater Significant Effects than Previous EIR	New Mitigation or Alternative to Reduce Significant Effect is Declined	Minor Technical Changes or Additions	No Impact
Would the project create capacity or service level problems, or result in substantial adverse physical impacts associated with the provision of new or physically altered governmental facilities in order to maintain acceptable service ratios, response times or other performance objectives for any of the public services:					
a) Fire protection?				X	
b) Sheriff protection?				X	
c) Schools?				X	
d) Parks?				X	
e) Libraries?				X	
f) Other public facilities?				X	

Comments:

a) Fire protection?

Minor Technical Changes or Additions. The minor technical changes to the approved TTM would not result in substantial impacts to fire protection services. Payment of LACoFD developer fees would ensure that the Modified Project funds its fair share of fees to offset its demand for services. Additionally, development in accordance with the Modified Project would proportionally increase taxes (e.g., income, property, and sales tax), which would increase the County's General Funds and allocate more funding to LACoFD for staffing and equipment.

Emergency access to the project site would be provided primarily via Skyline Ranch Road and the Sierra Highway. The proposed realignment of Skyline Ranch Road through the Modified Project site would not alter the alignments of the access points at the borders of the project site. Internal access within the project site would be provided via the project's internal residential streets. All project roadways would be constructed to meet the requirements (minimum street width, turning radii, slope, etc.) of the LACoFD conditions of approval, which are required to be implemented as part of project approval.

Similar to the Approved Project, the Modified Project would still be required to prepare a fuel modification plan, landscape plan, and irrigation plan to minimize fire hazards onsite. Project buildings would also adhere to all applicable state and County fire and building codes. Project plans would be reviewed by LACoFD prior to the issuance of building permits to ensure that the Modified Project would be compliant with applicable fire codes, regulations, and conditions. Additionally, the proposed mitigation measures would ensure that such fire codes, regulations, and conditions are adhered to.

The elimination of 40 single-family homes would reduce the project-generated population by 139 people. The population reduction would also reduce calls for fire service compared to the Approved Project.

5. Environmental Analysis

Additionally, the proposed modifications to the approved TTM would not result in any uses that would expose residents to an unusually high level of public safety risks associated with fire protection services (i.e., earthquakes, fires, etc.). These modifications also would not impact LACoFD's ability to provide fire protection service to the project site. Therefore, no impact would occur as a result of modification to Tract 60922. Project modifications would not result in new or substantially more severe impacts related to fire protection services, either as a result of the project or changed circumstances.

b) Police protection?

Minor Technical Changes or Additions. The elimination of 40 single-family homes would reduce the project's population by 139 people and reduce calls for service. Modifications to the Approved Project would not result in any uses that would expose residents to an unusually high level of public safety risks associated with law enforcement services. Residents would be exposed to the same level of public safety risks, such as break-ins, car thefts, and domestic disturbances. The Modified Project would not result in significant new impacts compared to the Approved Project.

As with other public services, funding for the Sheriff's Department is derived from various types of tax revenue deposited in the County General Fund. The Law Enforcement Facilities Fee provides additional revenue for law enforcement facilities in the unincorporated Santa Clarita, Newhall, and Gorman areas of north Los Angeles County. Under Chapter 22.74 of the Los Angeles County Code, developers of new residential, commercial, office, and industrial development projects in these areas are required to pay a Law Enforcement Facilities Fee to mitigate impacts to law enforcement facilities, including new or expanded sheriff's stations and new patrol vehicles. Fees collected are deposited in a special law enforcement capital facilities fund for the fee zone corresponding with the area in which a project is located. The project site is in Zone 1, Santa Clarita. Fees would be used exclusively for the purpose of land acquisition, engineering, construction, installation, purchasing, or any other direct cost of providing law enforcement facilities to the development. Payment of the fee would ensure that the Modified Project funds its fair share of fees to offset its demand for police services.

Additionally, all onsite roadways and emergency access provisions would be subject to review and approval by the Los Angeles County Department of Public Works, the Los Angeles County Fire Department, and the Sheriff's Department. In addition, development projects are required to incorporate Crime Prevention Through Environmental Design features into the project, in coordination with and to the satisfaction of the Sheriff's Department. Such features may include lighting in parking lots and low-level security lighting; doors and windows visible from the street and between buildings; lighting of building address numbers to ensure visibility from the street for emergency response agencies; and landscaping that would minimize opportunities for hiding. The applicant must also provide the Sheriff's Department with plans indicating the project's street circulation system and building addresses to facilitate emergency response. Therefore, no impacts to emergency access and/or emergency evacuation plans would occur. Pursuant to existing regulations, impacts relating to the exposure of public safety risks would remain less than significant. Project modifications would not result in new or substantially more severe impacts related to police protection services, either as a result of the project or changed circumstances.

5. Environmental Analysis

c) Schools?

Minor Technical Changes or Additions. The student population generated by the Modified Project would be served by SSSD, SUSD, and HUHSD. Similar to the Approved Project, the Modified Project would include an 11.9-acre school site (750-student capacity) to be maintained and operated by SSSD. It is assumed that all student residents on the project site would attend the proposed SSSD school onsite from kindergarten through 6th grade before moving onto junior high and high school in HUHSD.

The elimination of 40 single-family homes would reduce the project’s population to 4,221 residents. Table 10 compares the estimated student generation between the Approved and Modified Projects. As shown, the Modified Project would result in 60 fewer students than the Approved Project. Therefore, the Modified Project would not result in new or substantially more severe impacts related to school services.

Table 10 Approved Project vs. Modified Project, Student Generation

School District	Student Generation Rate ¹	Approved Project (1,260 total units)		Modified Project (1,220 Units)		Difference
		Units	No. of Students	Units	No. of Students	
Sulphur Springs	0.359	849	305	1,220	438	133
Saugus Union	0.4329	411	178	0	0	-178
Hart USD (Jr. High School, Grades 7–8)	0.1270	1,260	160	1,220	155	-5
Hart USD (High School, Grades 9–12)	0.2386	1,260	301	1,220	291	-10
Total		—	944	—	884	-60

Source: County of Los Angeles, *Skyline Ranch Project Draft EIR*, July 2009.

Additionally, under state law, development projects are required to pay established school impact fees in accordance with Senate Bill 50 (SB 50) at the time of building permit issuance. The funding program established by SB 50 has been found by the legislature to constitute “full and complete mitigation of the impacts of any legislative or adjudicative act... on the provision of adequate school facilities” (Government Code § 65995[h]). The fees authorized for collection under SB 50 are conclusively deemed full and adequate mitigation of impacts to SSSD, SUSD, and HUHSD. Therefore, the increases in school facilities and services demand due to development are adequately mitigated by the payment of SB 50 fees. Overall, project modifications would not result in new or substantially more severe impacts related to schools, either as a result of the project or changed circumstances.

d) Parks?

Minor Technical Changes or Additions. See response in Section 5.16, *Recreation*, below.

e) Libraries

Minor Technical Changes or Additions. The project is served by the Canyon Country Jo Anne Darcy Library at 18601 Soledad Canyon Road. Project demand for library services is based on guideline factors of

5. Environmental Analysis

2.75 items per capita and 0.5 square foot of facility space per capita, as provided by the County of Los Angeles Public Library. Compared to the Approved Project, the Modified Project would reduce demand for library services by 139 persons, 382 items, and 69.5 square feet.

Chapter 22.72 of the Los Angeles County Code describes the Library Facilities Mitigation Fee program, which requires developers of any new residential projects to pay fees to mitigate impacts to library services. Fees are deposited in a special library capital facilities fund for the library planning area in which a project is located. Fees are to be used solely for the financing of public library facilities, the need for which is generated directly or indirectly by residential development projects. The Modified Project would be subject to the payment of library impact fees pursuant to Section 22.72 of the Los Angeles County Code. Fees paid would be used to offset the project's demand for library resources. Therefore, impacts on libraries would be less than significant. Overall, the Modified Project would not adversely impact library facilities compared to the Approved Project.

f) Other public facilities?

Minor Technical Changes or Additions. Other public facilities, such as community recreation facilities, would not be substantially affected by the Modified Project. Although this issue was not discussed in the certified 2010 EIR, the Modified Project would include 19.6 acres of parkland and seven recreation centers throughout the site. This would reduce the demand for and use of existing community recreational facilities in the project area. Thus, the development of Modified Tract 60922 would result in beneficial impacts.

5.15.3 Adopted Mitigation Measures Applicable to the Modified Project

Sheriff's Department

4.L-1(a) Prior to issuance of building permits, the project shall incorporate Crime Prevention Through Environmental Design (CPTED) features into the project, in coordination with and to the satisfaction of the Sheriff's Department. Such features should include, but are not limited to the following:

- Lighting in parking lots and low-level security lighting;
- Provision that doors and windows are visible from the street and between buildings;
- Lighting of building address numbers to ensure visibility from the street for emergency response agencies; and
- Landscaping that would minimize opportunities for hiding.

4.L-1(b) Prior to issuance of building permits, the applicant shall provide the Sheriff's Department with plans indicating the project's street circulation system and building addresses to facilitate emergency response.

Fire Protection Services

5. Environmental Analysis

- 4.M-1(a) Prior to issuance of building permits, the applicant shall pay fees to support the Los Angeles County Fire Department (LACoFD) pursuant to the LACoFD Developer Fee Program.
- 4.M-1(b) Development of the project shall occur in accordance with all applicable code and ordinance requirements for construction, access, water mains, fire flows, and hydrants.
- 4.M-1(c) Project buildings shall adhere to all applicable State and County Fire and Building Codes.
- 4.M-1(d) The project shall provide adequate emergency access. Access roads shall:
- Provide a minimum width of 20 feet;
 - extend to within 150 feet of any exterior portion of all structures;
 - meet the minimum width requirements prescribed by the LACoFD;
 - be constructed with an all-weather surface;
 - have a minimum of 10 feet of brush clearance on each side;
 - have an unobstructed vertical clearance clear-to-sky with the exception of protected tree species;
 - have a vertical clearance of 13.5 feet when protected tree species are overhanging; and
 - have a turning radii of no less than 32 feet.
- 4.M-1(e) A turning area satisfactory to the LACoFD shall be provided for all driveways exceeding 150 feet in length and at the end of all cul-de-sacs.
- 4.M-1(f) All fire lanes must be a minimum of 26 feet in width (clear-to-sky) and marked “NO PARKING—FIRE LANE.”
- 4.M-1(g) All access devices and gates for the proposed school shall comply with California Code of Regulations, Title 19, Article 3.05, including providing a minimum paved access width of 26 feet for circulation purposes.
- 4.M-1(h) Proposed traffic calming measures shall be submitted to the LACoFD for review and approval.
- 4.M-1(i) All fire hydrants shall:
- Measure 6”x4” x 2-1/2” brass or bronze, conforming to current AWWA standard C503 or approved equal;
 - On-site hydrants shall be installed a minimum 25 feet from a structure or protected by a two- hour rated firewall;

5. Environmental Analysis

- Fire hydrants shall be installed, tested, and accepted prior to construction;
- Vehicular access to fire hydrants shall be provided and maintained serviceable throughout construction.

Wildfire Hazard

4.M-2 Prior to the issuance of any grading permit, a Fuel Modification Plan, consistent with the Fuel Modification Plan Guidelines, shall be submitted for review and approval by the Department of Regional Planning and the Forestry Division of the LACoFD to reduce the threat of wildfire. The Fuel Modification Plan shall require that applicant or homeowners association provide and maintain fuel modification and brush clearance zones around each on-site structure. Said plan shall be approved by the Forestry Division prior to completion of final landscape plans.

Please also see Mitigation Measures 4.M-1(b), 4.M-1(c), and 4.M-1(d).

5.15.4 Level of Significance After Mitigation

The Modified Project would only result in minor technical changes or additions to the previously certified EIR and would not result in significant impacts upon implementation of applicable regulatory requirements and mitigation measures.

5.16 RECREATION

5.16.1 Summary of Impacts Identified in the Certified EIR

This section summarizes the analysis contained in Section 4.P, *Parks*, of the 2010 Certified EIR.

The Los Angeles County Department of Parks and Recreation is responsible for the operations and maintenance of public parks in unincorporated Los Angeles County. The County has a standard of 4 acres per 1,000 residents for unincorporated areas. The Approved Project would provide approximately 18 acres of public and private park space, which includes a 12-acre public neighborhood park, a 2.5-acre private park, and eight pocket parks totaling approximately 3.7 acres. The proposed public park would dedicate 10.6 acres to the Parks Department. The remaining parks would be maintained by a homeowners' association. Other proposed recreational amenities onsite include 2 miles of hiking trails, 1 mile of paseos, and 8 miles of bike lanes along Skyline Ranch Road, Main Street North, and Main Street South. The undeveloped northern portion of the site would also include approximately 2.2 miles of trail easement that would connect to the Mint Canyon Trail in the north and the existing Plum Canyon fire road in the south.

Based on the County's 4 acres per 1,000 residents standard, the Approved Project is required to provide 12.23 net acres of onsite park space. The Approved Project would provide 10.6 acres of public park space and in-lieu fees to meet the County requirements per Section 21.28.140 of the Los Angeles County Code.

5. Environmental Analysis

Additionally, the Approved Project would not necessitate the construction of additional off-site facilities, which could result in secondary, adverse impacts on the environment. Project residents are expected to primarily utilize the proposed on-site parks and recreational facilities, which provide for both active and passive recreation. Impacts would be less than significant.

5.16.2 Impacts Associated with the Modified Project

Issues	Substantial Change in Project or Circumstances Resulting in New Significant Effects	New Information Showing Greater Significant Effects than Previous EIR	New Mitigation or Alternative to Reduce Significant Effect is Declined	Minor Technical Changes or Additions	No Impact
a) Would the project increase the use of existing neighborhood and regional parks or other recreational facilities such that substantial physical deterioration of the facility would occur or be accelerated?				X	
b) Does the project include neighborhood and regional parks or other recreational facilities or require the construction or expansion of recreational facilities which might have an adverse physical effect on the environment?				X	
c) Would the project interfere with regional open space connectivity?					X

Comments:

- a) **Would the project increase the use of existing neighborhood and regional parks or other recreational facilities such that substantial physical deterioration of the facility would occur or be accelerated?**

Minor Technical Changes or Additions. The Modified Project would reduce the number of residential lots by 40, from 1,260 to 1,220 units. This would reduce the project-generated population by 139 people. Therefore, the Modified Project would generate less demand on existing neighborhood and regional parks. Additionally, the Modified Project would include 19.6 acres of public and private parks; 3.0 miles of hiking trails, 3.3 miles of paseos, 2.3 miles of multipurpose trails, and a 2.2-mile trail easement; and 9.8 miles of bike lanes that would be accessible to the residents onsite.

Based on the County's parkland standard of 4 acres per 1,000 residents, the reduced population would also reduce the project's park dedication requirement from 17.4 to 16.9 acres. The Modified Project includes 16.9 acres of public parks throughout the site, and 2.7 acres of private parks. Therefore, the Modified Project would meet the County's parkland standard. Although not credited under the parkland requirement, it should be noted that the Modified Project would provide an additional mile of hiking trails, 2.3 miles of paseos, 2.3 miles of multipurpose trails, and 1.8 miles of bike lanes compared to the Approved Project (see Table 2, above). Overall, impacts would be less than significant.

5. Environmental Analysis

- b) **Does the project include neighborhood and regional parks or other recreational facilities or require the construction or expansion of recreational facilities which might have an adverse physical effect on the environment?**

Minor Technical Changes or Additions. Similar to the Approved Project, the Modified Project would include a number of public parks and recreational amenities. The Modified Project would relocate and expand the parks into 16.9 acres of public parks and 2.7 acres of private parks, as shown on Figure 7, *Modified Parks and Trails*. As shown on Figure 4, *Approved TTM vs. Proposed Concept Plan*, one of the parks would be relocated near the proposed school site to provide better accessibility to the student population that would likely use the park more than other residents. Additionally, a community center is proposed near the age-qualified residences, and would include a club house, pool deck area, outdoor dining, barbecue area, and seating.

The relocation and expansion of park sites by 1.4 acres, inclusion of a community center, and a reduction in the number of residents generated by the Modified Project would beneficially impact park services and the community. The net incremental impact of the Modified Project on recreational facilities would be less than significant, and no new substantial impacts would occur as a result of the Modified Project or changed circumstances.

- c) **Would the project interfere with regional open space connectivity?**

No Impact. Similar to the Approved Project, the Modified Project would include a 2.2-mile trail easement to connect with the existing regional Mint Canyon Trail in the undeveloped northern portion of the project site. Therefore, no new significant impacts to regional trails would occur as a result of the Modified Project or as a result of changed circumstances.

5.16.3 Adopted Mitigation Measures Applicable to the Modified Project

The 2010 Certified EIR did not include mitigation measures related to recreation.

5.16.4 Level of Significance After Mitigation

The Modified Project would only result in minor technical changes or additions to the previously certified EIR and would not result in significant impacts to recreation.

5.17 TRANSPORTATION/TRAFFIC

5.17.1 Summary of Impacts Identified in the Certified EIR

This section summarizes the analysis contained in Section 4.F, *Traffic/Access*, of the 2010 Certified EIR.

Trip Generation and Intersection Analysis

The Approved Project was forecast to generate 13,121 vehicle trips per day, with 1,268 in the AM peak hours and 1,283 in the PM peak hours. Based on intersection analysis, the project would have a significant impact at

5. Environmental Analysis

the County intersections of Plum Canyon Road with Skyline Ranch Road/Heller Circle (South) and Golden Valley Road with Plum Canyon Road, and at City intersections of Sierra Highway with Soledad Canyon Road and Sierra Highway with Skyline Ranch Road.

The Certified EIR found that significant cumulative impacts would occur on Sierra Highway; however, due to the speculative nature of the timing of implementation and availability of funding to implement short- and long-range plans, the reduction of cumulative impacts to less than significant levels cannot be guaranteed, and therefore cumulative impacts to Sierra Highway between Sand Canyon Road to the south of the Sierra Highway interchange would be **significant and unavoidable**.

CMP Analysis

The Congestion Management Plan (CMP) intersections nearest to the project site are the intersections of Sierra Highway with Sand Canyon Road and Sierra Highway with Soledad Canyon Road. The Approved Project was not anticipated to add 50 or more peak-hour trips to the intersection of Sierra Highway / Sand Canyon Road (15 PM trips), but was expected to add more than 50 trips to the intersection of Sierra Highway / Soledad Canyon Road (455 PM trips). An impact analysis of this intersection concluded that the intersection was forecast to exceed LOS F prior to the addition of project traffic and that the project would cause a significant impact based on the CMP guidelines if mitigation measures were not implemented.

5.17.2 Impacts Associated with the Modified Project

The analysis in this section is based in part on the following technical study and technical memorandum:

- *Skyline Ranch (Revised VTTM 060922) On-Site Roadway Analysis*, Stantec Consulting Services Inc., October 18, 2016.
- *Skyline Ranch (Revised VTTM 060922) Land Use and Trip Generation Update*, Stantec Consulting Services, Inc., December 5, 2016.

A complete copy of the study and technical memorandum is included in Appendix B.

5. Environmental Analysis

Would the Modified Project:

Issues	Substantial Change in Project or Circumstances Resulting in New Significant Effects	New Information Showing Greater Significant Effects than Previous EIR	New Mitigation or Alternative to Reduce Significant Effect is Declined	Minor Technical Changes or Additions	No Impact
a) Conflict with an applicable plan, ordinance, or policy establishing measures of effectiveness for the performance of the circulation system, taking into account all modes of transportation, including mass transit and non-motorized travel, and relevant components of the circulation system, including but not limited to intersections, streets, highways and freeways, pedestrian and bicycle paths, and mass transit?				X	
b) Conflict with an applicable congestion management program (CMP), including, but not limited to, level of service standards and travel demand measures, or other standards established by the CMP for designated roads or highways?				X	
c) Result in a change in air traffic patterns, including either an increase in traffic levels or a change in location that results in substantial safety risks?					X
d) Substantially increase hazards due to a design feature (e.g., sharp curves or dangerous intersections) or incompatible uses (e.g., farm equipment)?				X	
e) Result in inadequate emergency access?				X	
f) Conflict with the adopted policies, plans, or programs regarding public transit, bicycle, or pedestrian facilities, or otherwise decrease the performance or safety of such facilities?				X	

Comments:

- a) **Conflict with an applicable plan, ordinance, or policy establishing measures of effectiveness for the performance of the circulation system, taking into account all modes of transportation, including mass transit and non-motorized travel, and relevant components of the circulation system, including but not limited to intersections, streets, highways and freeways, pedestrian and bicycle paths, and mass transit?**

Minor Technical Changes or Additions. The Modified Project would develop 40 fewer residential units than the Approved Project. Stantec Consulting Services prepared a trip generation analysis to calculate the number of trips that would be generated by the Modified Project.

The trip generation estimates were calculated using the Institute of Transportation Engineers' trip generation rates for single-family residential, Los Angeles County rates for townhouse/condominium, and rates derived

5. Environmental Analysis

from case studies for the proposed elementary school (see Table 11). The elementary school case study rates reflect the higher trip generation characteristics of a typical southern California elementary school.

Table 11 Modified Project Trip Generation Rates

Land Use	Units	AM Peak Hour			PM Peak Hour			ADT
		Inbound	Outbound	Total	Inbound	Outbound	Total	
Trip Rates								
Single Family	DU	0.19	0.56	0.75	0.63	0.37	1.00	9.52
Detached Condominium	DU	0.06	0.48	0.54	0.47	0.26	0.73	8.00
Elementary School	STU	0.25	0.20	0.45	0.13	0.15	0.28	1.29

Source: Stantec 2016.

Notes: DU = dwelling units; STU = students; ADT = average daily trips

Using these generation rates, the Modified Project is forecast to generate a total of approximately 12,059 vehicle trips per day, with 1,181 in the AM peak hour (810 outbound) and 1,127 in the PM peak hour (714 inbound). Table 12 compares the trip generation summaries of the Approved and Modified Projects. The Modified Project would generate 1,062 fewer average daily trips (87 fewer AM peak hour trips and 156 fewer PM peak hour trips) compared to the Approved Project; however, significant and unavoidable impacts to Highway 14 from Sand Canyon Road to the south of the Sierra Highway interchange would not be eliminated. Development of the Modified Project would not result in new significant impacts on the traffic and circulation system, and the level of impact remains unchanged from the Certified EIR.

Table 12 Trip Generation Comparison

Land Use	Amount	Units	AM Peak Hour			PM Peak Hour			ADT
			Inbound	Outbound	Total	Inbound	Outbound	Total	
Approved Project									
Single Family	1,270	DU	241	711	953	813	470	1,283	12,154
Elementary School	750	STU	173	143	315	NA	NA	NA	968
Total			414	854	1,268	813	470	1,283	13,121
Modified Project									
Single Family (210)	876	DU	164	493	657	552	324	876	8,340
Detached Condominium	344	DU	21	165	186	162	89	251	2,752
Elementary School	750	STU	186	152	338	--	--	--	968
Total			371	810	1,181	714	413	1,127	12,059
Net Difference			-43	-44	-87	-99	-57	-156	-1,062

Source: Stantec 2016.

Notes: DU = dwelling units; STU = students; ADT = average daily trips

An analysis for the proposed school access was also provided in the 2016 Stantec report. Initially, four access alternatives were analyzed: 1) full access, unsignalized intersection, 2) a roundabout at the school entrance, 3) a right/left-in and right-out only access point at the school with a roundabout at the park, and 4) a right/left-in and right-out only access point at the school with a U-turn at the park. A fifth alternative was subsequently

5. Environmental Analysis

developed through consultation with the Los Angeles County Public Works staff. This preferred alternative consists of a full access unsignalized intersection at the school with a channelized/dedicated right-turn lane into the school. A dedicated acceleration/merge lane would be provided for the exiting school traffic turning left onto southbound Skyline Ranch Road. A U-turn at the park would also be developed as a secondary means for traffic to head south on Skyline Ranch Road. County Public Works anticipates prohibiting left-turn into the school during the peak times, preferring instead to have the inbound traffic proceed to the southerly roundabout to make a U-turn and return to the school in the northbound direction and enter as right-turns.

Based on the peak hour signal warrant analysis, a traffic signal is not warranted at the school intersection. A traffic signal is not recommended for the school entrance due to the close proximity to the south roundabout and because the traffic signal would not meet the minimum volume warrants.

The Modified Project would also realign Skyline Ranch Road along the western boundary of the proposed community, providing access to the development via two roundabouts—one at the northern end near the park site, and one at the southern end near the school site. An evaluation of the roundabout concepts has been prepared with SIDRA software. The analysis indicates that both the north and the south roundabouts would operate at good LOS based on a single-lane roundabout configuration (see Table 13).

Table 13 Proposed Roundabouts LOS and Delay Summary

Roundabout Locations	AM		PM	
	LOS	Average Delay (seconds)	LOS	Average Delay (seconds)
Skyline Ranch Road & North Roundabout	A	9.7	B	13.0
Skyline Ranch Road & South Roundabout	B	10.6	B	10.4

Source: Stantec 2016.

The queue lengths for each leg of the north and south roundabouts on Skyline Ranch Road are shown in Table 14.

Table 14 Queue Lengths for Each Leg of Roundabouts

	North Roundabout Queue Length (ft)		South Roundabout Queue Length (ft)	
	AM	PM	AM	PM
South Leg (Skyline Ranch Rd)	85.9	101.1	79.1	118.3
East Leg (Loop Rd)	97.7	45.5	66.9	39.5
North Leg (Skyline Ranch Rd)	139.7	277.5	204.7	196.0

Source: Stantec 2016.

To evaluate the operation of the Skyline Ranch Road intersections, a Synchro/SimTraffic simulation model was prepared for Skyline Ranch Road and the north, south, park and school intersections. Simulation results for the school driveway shows that the average vehicle, after dropping off students, would take approximately

5. Environmental Analysis

24.1 seconds and 12.7 seconds to exit left and right, respectively, out of the school driveway during the AM peak.

The park intersection also provides a convenient location for exiting traffic to make a U-turn and proceed south on Skyline Ranch Road. Table 15 summarizes the lane LOS and approach delay at the school and park intersections during both AM and PM peak. The analysis indicates that the school site access would operate at LOS C or better during both AM & PM peak hour with a maximum queue length of 136 feet during the AM peak.

Table 15 LOS, Delay & Queue Summary at School and Park

Location		AM			PM		
		LOS	Delay (sec)	Queue	LOS	Delay (sec)	Queue
Skyline Ranch Rd & School	WBL	C	24.1	136	B	14.2	71
	WBR	B	12.7	52	B	12.6	59
Skyline Ranch Rd & Park	WBL/R	C	20.8	39	C	21.0	43
	SBL	A	8.6	27	A	8.4	21

Source: Stantec 2016.

In addition, the County and City of Santa Clarita have established multiple Bridge and Thoroughfare (B&T) Districts. The project site is in two of the B&T districts: the Bouquet Canyon District, which covers the western portion of the site, and the Eastside District, which covers the eastern portion of the site. Both of these B&T districts were recently updated and are considered full improvement districts. By being full improvement districts, the B&T fees collected in the districts are intended to cover all the anticipated improvements necessary to build out the arterial roadway network. The B&T fees are assessed based on the number of peak hour trips generated by the proposed project collected at the time of recordation of a final tract map.

b) Conflict with an applicable congestion management program (CMP), including, but not limited to, level of service standards and travel demand measures, or other standards established by the CMP for designated roads or highways?

Minor Technical Changes or Additions. According to the CMP for Los Angeles County, the CMP intersections closest to the project site are Sierra Highway at Sand Canyon Road and Sierra Highway at Soledad Canyon Road.

The CMP traffic impact analysis guidelines consider that a project has a significant impact on the regional transportation system when the following thresholds are exceeded:

- The proposed project increases traffic demand on a CMP facility by 2 percent of capacity or more ($V/C > 0.02$), causing LOS F ($V/C > 1.00$); or
- If the facility is already at LOS F, a significant impact occurs when the proposed project increases traffic demand on a CMP facility by 2 percent of capacity or more ($V/C > 0.02$).

5. Environmental Analysis

According to the CMP guidelines, the geographical area examined in a CMP traffic impact analysis consists of the CMP monitoring locations where the proposed project would add 50 or more trips during the AM or PM weekday peak hours (of adjacent street traffic) or main-line freeway locations where the project would add 150 or more trips, in either direction, during either the AM or PM weekday peak hours. Compared to the Approved Project, the Modified Project would reduce project-generated vehicle trips (see Table 12); therefore, it would not add trips to the Sierra Highway/Sand Canyon or Sierra Highway/Soledad Canyon Road intersections or to any main-line freeway locations. Thus, project impacts at CMP intersections and main-line freeway locations are not anticipated. Therefore, no new significant impacts result from project modification or changed circumstances.

c) Result in a change in air traffic patterns, including either an increase in traffic levels or a change in location that results in substantial safety risks?

No Impact. Similar to the Approved Project, the Modified Project would not alter air traffic patterns. The nearest major airport, Bob Hope Airport in Burbank, is over 17 miles to the south of the project site. The project would not increase use of the airport, causing an increase in air traffic levels, and it would not directly cause a change in flight paths due to the construction of tall buildings. No impacts to air traffic patterns would occur. No new significant impacts would result from project modification or changed circumstances.

d) Substantially increase hazards due to a design feature (e.g., sharp curves or dangerous intersections) or incompatible uses (e.g., farm equipment)?

Minor Technical Changes or Additions. As part of the Modified Project, Skyline Ranch Road would be realigned through the site. However, this would not significantly increase hazardous conditions due to design features or incompatible uses. The final map is required to be designed in accordance with the County of Los Angeles design standards for subdivisions, reviewed by the Land Development Division and County of Los Angeles Department of Public Works, and approved by the County Board of Supervisors. By following the design standards for subdivisions, as required by the County, hazardous conditions due to design features and incompatible uses would be reduced. Therefore, impacts would be less than significant.

e) Result in inadequate emergency access?

Minor Technical Changes or Additions. As part of the Approved and Modified Projects, Whites Canyon Road would be extended from Plum Canyon Road on the west (through VITM 46018) to the southeast as Skyline Ranch Road, ultimately connecting to Sierra Highway. Implementation of this road alignment improves area-wide emergency access to areas north of Canyon Country and the City of Santa Clarita. The proposed realignment of Skyline Ranch Road under the Modified Project would not affect emergency access because it would still provide two access points through the site. The onsite roadways, roundabouts, and cul-de-sacs would be designed in accordance with the County's subdivision design standards, and the final tentative map would be subject to review by the County of Los Angeles Public Works Department and approval by the County's Board of Supervisors. By following the design standards in the County Code and through the process of review and approval by the County, emergency access would be maintained. The Modified Project would have less than significant emergency access impacts.

5. Environmental Analysis

f) Conflict with the adopted policies, plans, or programs regarding public transit, bicycle, or pedestrian facilities, or otherwise decrease the performance or safety of such facilities?

Minor Technical Changes or Additions. The project site is served by Santa Clarita Transit Routes 1, 2, and 5, which provide service between Sierra Highway and the Transit Center located in the Valencia Town Center. Additionally, the Santa Clarita Metrolink station on Via Princessa near Whites Canyon Road is approximately two miles south of the site. Given that the Modified Project would reduce residential units and vehicle trips, the project would also decrease potential transit use by project residents.

Bicycle lanes and multipurpose trails are also proposed throughout the Skyline Ranch project site. The Modified Project would develop 10.75 miles of pedestrian connections, including 3.0 miles of hiking trails, a 2.2-mile trail easement, 3.3 miles of paseo trails, and 2.3 miles of multipurpose trails (see Figure 7, *Open Space and Trails Map*). An additional 1.8 miles of bike lanes would be developed in the Skyline Ranch community. Overall, the Modified Project provides more pedestrian and bicyclist connections than the Approved Project.

Thus, the Modified Project would not have any impact on adopted policies, plans, or programs regarding public transit, bicycle, or pedestrian facilities, or otherwise decrease the performance or safety of such facilities. No new significant impacts would result from project modification or changed circumstances.

5.17.3 Adopted Mitigation Measures Applicable to the Modified Project

County Intersections

4.F-1(a) **Plum Canyon Road at Skyline Ranch Road/Heller Circle (South):** Prior to issuance of a certificate of occupancy, the project shall redesign and construct the new east leg (Skyline Ranch Road) to include one left-turn lane, one shared left/through lane, and one right-turn lane; and restripe the existing west leg (Heller Circle South) to consist of one left-turn lane and one shared through/right-turn lane; and restripe the existing north leg (Plum Canyon Road) left-turn pocket to allow the left-turn movement. Implementation of improvements and fair share determination shall be coordinated with adjoining Tract 46018, since many of the stated improvements are conditions of approval for Tract 46018 and are required to be in place prior to occupancy of Tract 46018 or the proposed project.

4.F-1(b) **Golden Valley Road at Plum Canyon Road:** The project shall pay its fair share (53 percent) to restripe the northbound Golden Valley Road approach to provide a second left-turn lane, for a total of two northbound left-turn lanes, one northbound through lane, and one northbound right-turn lane. Timing of improvement shall be determined by the County based on Bridge and Thoroughfare (B&T) District priorities.

City Intersections

4.F-2(a) **Sierra Highway at Soledad Canyon Road:** The project shall pay its fair share (100 percent) to add a second southbound left-turn lane, for a total of five approach lanes and reconfigure the approach lanes as two left-turn lanes, two through lanes, and one right turn

5. Environmental Analysis

lane, so as to mirror the northbound approach. This improvement may require the acquisition of additional right-of-way to widen the southbound approach of the north leg. Timing of improvement shall be determined by the City based on B&T District priorities.

- 4.F-2(b) **Sierra Highway at Skyline Ranch Road:** Prior to the issuance of the first building permit the project shall construct a new intersection for project access; provide one northbound left-turn lane, two northbound through lanes, two southbound through lanes, one eastbound left-turn lane, and two eastbound right-turn lanes; and install a traffic signal. The placement of the new west leg should be of sufficient distance from the Sierra Highway centerline to allow for the eventual addition of a third southbound through lane as identified in the City of Santa Clarita General Plan Circulation Element.

State Highways

- 4.F-3 In the event the State approves a Caltrans impact fee mitigation program prior to implementation of the proposed project, the applicant shall pay a fair share to fund programmed improvements to Highway 14 that would mitigate the project's contribution to cumulative impacts on the highway. Such improvements may include the addition of HOV lanes, truck lanes, and additional mixed flow lanes to the segments of Highway 14 between Sand Canyon Road to south of the Sierra Highway interchange, that have been identified in the Short Range Plan outlined in the North County Combined Highway Corridors Study.

5.17.4 Level of Significance After Mitigation

The Modified Project would only result in minor technical changes or additions to the previously certified EIR, and would not result in significant impacts upon implementation of applicable regulatory requirements and mitigation measures.

5.18 UTILITIES AND SERVICE SYSTEMS

5.18.1 Summary of Impacts Identified in the Certified EIR

This section summarizes the analysis contained in Sections 4.I, *Water Resources*, 4.J, *Wastewater Disposal*, and 4.K, *Solid Waste Disposal*, of the 2010 Certified EIR.

Water Resources

Water Supply

The Approved Project is in the Santa Clarita Water Division (SCWD), which receives water from both groundwater sources and the Castaic Lake Water Agency (CLWA). According to the Certified EIR, the project would have a water demand of 1,831 acre-feet per year (afy), as shown in Table 16. Sufficient water supplies would be available to meet projected water demands. The Approved Project was identified as a pending project in the County and as part of the analysis in the 2005 Urban Water Management Plan. Existing land use data and new housing construction information were compiled from each of the retail

5. Environmental Analysis

water purveyors, and projections were prepared in the “One Valley One Vision Plan,” a joint planning effort by the City of Santa Clarita and Los Angeles County Department of Regional Planning.

Table 16 Approved Project, Estimated Water Demand

Land Use	Units/Acres	Water Use Factor (afy) ¹	Estimated Water Use (afy)
Single-Family Residential	1,260 units	0.82 per unit	1,033
Parks	18 acres	3 per acre	54
Elementary School	11 acres	3 per acre	33
Manufactured Slopes	211 acres ²	3 per acre	633
Road Parkways	26 acres	3 per acre	78
Total	—	—	1,831

¹ Factors provided by CLWA SCWD.

² Acreage includes off-site landscaped slope areas of 7.92 acres (VTM 46018) and 1.96 acres (BLM property).

Impacts to water supply were considered less than significant. However, the reduction in State Water Project supply and Countywide drought conditions reinforce the need to conserve water and comply with County water conservation requirements. Therefore, mitigation was provided to ensure the Approved Project would be consistent with all applicable water conservation plans, programs, and ordinances.

Water Supply Infrastructure

The Approved Project would provide water lines to connect to existing pipelines in Sierra Highway to tie into the CLWA/SCWD system. A new 16-inch pipeline would connect the existing CLWA/SCWD water tank to onsite infrastructure, and potable water would be conveyed to onsite uses by installing a proposed network of 6- to 16-inch pipes. Onsite booster/pump stations and water tanks were also proposed to ensure sufficient water pressure to deliver water onsite. Thus, impacts would be less than significant.

Groundwater Recharge

The Approved Project would increase impervious surfaces onsite by approximately 189 acres, but would not result in a significant reduction in groundwater recharge. Increased runoff from impervious surfaces was estimated to be approximately 284 afy. Most surface runoff enters the Santa Clara River south of the project site and recharges the alluvial aquifer. In addition, the land uses associated with the Approved Project would increase water usage for irrigation of landscaped areas compared to existing conditions (undeveloped land). Given that the increase in impervious surface area is not substantial, the increase in irrigation, and the fact that runoff would contribute recharge, impacts to groundwater recharge would be less than significant.

Wastewater Disposal

Wastewater Collection

Sewer lines ranging from 8 to 12 inches would be installed as part of the Approved Project’s proposed sewer network. These sewer lines would collect wastewater generated within the development, with flows directed southeast into the 21-inch Sierra Highway sewer. Development of the Approved Project would generate

5. Environmental Analysis

approximately 346,200 gallons of wastewater per day (gpd) (see Table 17). Flow rates from the site would equate to 1.41 cubic feet per second (cfs) into the Sierra Highway sewer. The capacity of this sewer was determined to be 9.58 cfs; therefore, it would have capacity to collect wastewater generated onsite.

Table 17 Approved Project, Estimated Wastewater Generation

Land Use	Approved Project Buildout	Wastewater Generation Factor (gpd) ¹	Estimated Wastewater Generated (gpd)
Single-family Residential	1,260 units	260	327,600
Elementary School	750 students	20	15,000
Park	18 acres	200	3,600
Total	—	—	346,200

¹ Factors provided by the Sanitation Districts of Los Angeles County.

Wastewater Treatment

Wastewater treatment for the project area is provided by the Sanitation Districts of Los Angeles County (LACSD) through the Santa Clarita Valley Joint Sewerage System (SCVJSS). The SCVJSS provides primary, secondary, and tertiary wastewater treatment. It has a capacity of 7 million gallons per day (mgd) and an approved expansion of 6 mgd, which would be sufficient to meet forecast demand beyond 2017. The project-generated 346,200 gpd of wastewater (approximately 5 percent of available capacity) would be adequately treated at the SCVJSS. Additionally, the project applicant would be required to pay an annexation fee and a connection fee (based on the number of dwelling units). The project would not have a significant impact on wastewater treatment facilities.

Solid Waste Disposal

Construction Waste

The California Integrated Waste Management Board conservatively estimated that residential construction projects generate approximately four pounds of construction debris (mostly wood and drywall) per square foot. Based on this factor and an approximate average square footage for the residential units of 3,550 square feet, the project would generate approximately 8,946 tons of debris (see Table 18). However, the project is subject to the County's Green Building Ordinance. Pursuant to the County's Green Building Ordinance, 65 percent of the project's construction debris (i.e., 5,815 tons) would be recycled or reused. Thus, project construction would dispose of 3,131 tons of debris, approximately 0.04 percent of the Peck Road Gravel Pit landfill's 7.8 million tons of remaining capacity. Thus, construction-generated waste impacts on solid waste facilities would be less than significant.

5. Environmental Analysis

Table 18 Approved Project, Estimated Solid Waste Generation

Land Use	Approved Project Buildout	Solid Waste Generation Factor ¹	Estimated Solid Waste Generated
Construction			
Single-family Residential	1,260 units (3,550 SF per unit)	4 lbs per SF	8,946 tons
Operations			
Single-family Residential	4,158 residents	0.41 tons per person	1,704.78 tons per year
<small>Note: SF = square feet Factors provided by California Integrated Waste Management Board.</small>			

Operation Waste

The California Integrated Waste Management Board's solid waste generation factor is 0.41 ton per capita per year. Based on this factor, the proposed project would generate approximately 1,704.78 tons of solid waste per year (see Table 16). Solid waste generated at the project site would likely be disposed at Sunshine Canyon Landfill, Chiquita Canyon Landfill, and the Antelope Valley Landfill. The projected solid waste would comprise approximately 0.002 percent of the 95.37 million tons of remaining capacity at these landfills and would represent an increase of less than 0.5 percent of the approximate 3.667 million tons of solid waste disposed in 2008 at these facilities. Thus, existing landfills would have sufficient capacity and impacts would be less than significant.

5.18.2 Impacts Associated with the Modified Project

Would the Modified Project:

Issues	Substantial Change in Project or Circumstances Resulting in New Significant Effects	New Information Showing Greater Significant Effects than Previous EIR	New Mitigation or Alternative to Reduce Significant Effect is Declined	Minor Technical Changes or Additions	No Impact
a) Exceed wastewater treatment requirements of the Los Angeles or Lahontan Regional Water Quality Control Boards?					X
b) Create water or wastewater system capacity problems, or result in the construction of new water or wastewater treatment facilities or expansion of existing facilities, the construction of which could cause significant environmental effects?				X	
c) Create drainage system capacity problems, or result in the construction of new storm water drainage facilities or expansion of existing facilities, the construction of which could cause significant environmental effects?				X	
d) Have sufficient reliable water supplies available to serve the project demands from existing entitlements and resources, considering existing and projected water demands from other land uses?				X	

5. Environmental Analysis

Issues	Substantial Change in Project or Circumstances Resulting in New Significant Effects	New Information Showing Greater Significant Effects than Previous EIR	New Mitigation or Alternative to Reduce Significant Effect is Declined	Minor Technical Changes or Additions	No Impact
e) Create energy utility (electricity, natural gas, propane) system capacity problems, or result in the construction of new energy facilities or expansion of existing facilities, the construction of which could cause significant environmental effects?				X	
f) Be served by a landfill with sufficient permitted capacity to accommodate the project's solid waste disposal needs?				X	
g) Comply with federal, state, and local statutes and regulations related to solid waste?					X

Comments:

a) Exceed wastewater treatment requirements of the Los Angeles or Lahontan Regional Water Quality Control Boards?

No Impact. Similar to the Approved Project, the Modified Project would be required to comply with the wastewater treatment requirements in the Construction General Permit, Order No. 2009-0009-DWQ, issued by the SWRCB. The Modified Project is required apply for coverage under the Construction General Permit by submitting a Notice of Intent to the SWRCB and preparing and implementing a SWPPP specifying BMPs to minimize construction water pollution impacts. By adhering to these BMPs, the Modified Project would not exceed the SWRCB's wastewater treatment requirements, and no new or significant increase in effects would occur.

The modifications to the approved TIM would decrease impervious surfaces and preserve existing slopes and hillsides in the south and southwest portions of the developable area. Regardless, the Modified Project would be required to meet wastewater treatment requirements in Order No. 01-182 by the Los Angeles RWQCB, which includes preparing and implementing a Standard Urban Stormwater Management Plan. The SUSMP would specify BMPs to be used in the Modified Project's design and operation to minimize pollution of stormwater. By adhering to these BMPs, the Modification would not exceed the Los Angeles RWQCB's wastewater treatment requirements, and no new or significant increase in effects would occur.

Additionally, as discussed in Section 5.18.2(b) below, the Modified Project would result in a reduction in wastewater generation as compared to the Approved Project. Therefore, no new substantial impacts would occur.

5. Environmental Analysis

- b) **Create water or wastewater system capacity problems, or result in the construction of new water or wastewater treatment facilities or expansion of existing facilities, the construction of which could cause significant environmental effects?**

Minor Technical Changes or Additions. As discussed in Sections 3.18.2(d), the incremental differences of the proposed modifications to the recorded map would not result in new substantial impacts to water supply. The Modified Project would actually reduce water demand by 324 afy.

Wastewater treatment for the project area is provided by LACSD, specifically the SCVJSS. SCVJSS provides primary, secondary, and tertiary treatment of wastewater. Table 19 compares wastewater generation under the Approved and Modified Projects. As shown, the Modified Project would reduce wastewater generation by 10,080 gallons per day.

Table 19 Approved Project vs. Modified Project, Estimated Wastewater Generation

Land Use	Wastewater Generation Factor (gpd) ¹	Estimated Wastewater Generated (gpd)		
		Approved Project	Modified Project	Difference
Single-family Residential	260	327,600	317,200	-10,400
Elementary School	20	15,000	15,000	0
Park	200	3,600	3,920	+320
Total		346,200	336,120	-10,080

¹ Factors provided by SCVJSS.

Additionally, new development projects in the Santa Clarita Valley area are required to pay fees for direct and indirect connections to and services provided by the SCVJSS. These connection fees would be assessed pursuant to the LACSD's Master Connection Fee Ordinance and Master Service Charge Ordinance. The fee is charged for connecting (directly or indirectly) to LACSD's sewerage system, increasing the strength and/or quantity of wastewater attributable to a particular parcel or operation already connected, or charges for facilities furnished by or available from LACSD. These connection fees and service charges are required to support the incremental expansion of the system as new projects are developed. The connection fees provide additional conveyance, treatment, and disposal facilities (capital facilities) as well as operational and maintenance costs. Payment of a connection fee and service charge are required before a permit to connect to the LACSD system is issued. For new development in the LACSD, the developer funds onsite sewer mains.

Therefore, existing water and wastewater facilities can accommodate the demands generated by the proposed modifications to the approved TTM, and the Modified Project would have a beneficial impact on wastewater services and would have no new substantial impact.

- c) **Create drainage system capacity problems, or result in the construction of new storm water drainage facilities or expansion of existing facilities, the construction of which could cause significant environmental effects?**

Minor Technical Changes or Additions. Impacts to stormwater facilities are as discussed in Section 5.10, *Hydrology and Water Quality*, of this Addendum.

5. Environmental Analysis

- d) **Have sufficient reliable water supplies available to serve the project demands from existing entitlements and resources, considering existing and projected water demands from other land uses?**

Minor Technical Changes or Additions. The proposed modifications to the Approved Project would reduce the single-family homes from 1,260 to 1,220, resulting in 40 fewer homes. As shown in Table 20, the Modified Project would reduce water demand by 324 afy compared to the Approved Project.

Table 20 Approved Project vs. Modified Project, Estimated Water Demand

Land-Use Categories	Water Use Factor (afy) ¹	Estimated Water Use (afy)		
		Approved Project	Modified Project	Difference
Single Family Residential	0.82 per unit	1,033	1,000	-33
Parks	3 per acre	54	59	+5
Elementary School	3 per acre	35	36	+1
Manufactured Slopes	3 per acre	831	534	-297
Road Parkways	3 per acre	78	78	0
Total Difference				-324 afy

¹ Factors provided by CLWA/SCWD.

The project was included in CLWA's 2005 and 2010 Urban Water Management Plans. The analysis provided in the 2010 plan takes into account the available water supplies and water demands for CLWA's service area to assess the region's ability to satisfy demands through the year 2050. It was concluded that sufficient water supplies would continue to be available (including groundwater pumping that would not result in long-term depletion of groundwater resources) to meet projected demand, which includes the Skyline Ranch project. It also concluded that sufficient water supplies would continue to be available for single and multiple dry-year conditions through the year 2050 to meet projected demand. However, given the current drought conditions and uncertainty regarding the availability of imported water supplies from the State Water Project, the Modified Project would be required to comply with County water conservation measures. These include the Water Efficient Landscaping Requirements (Title 26, Chapter 7 of the Los Angeles County Code), Water Conservation Requirements for the Unincorporated Los Angeles County Area (Chapter 11.38, Part 4 of the Los Angeles County Code), and Drought-Tolerant Landscaping and Green Building Standards ordinances. Mitigation is provided to ensure the Modified Project implements these water conservation requirements. Overall, water demand would be reduced under the Modified Project because fewer residential homes would be developed. Therefore, the Modified Project would have a beneficial impact on water supply.

5. Environmental Analysis

- e) **Create energy utility (electricity, natural gas, propane) system capacity problems, or result in the construction of new energy facilities or expansion of existing facilities, the construction of which could cause significant environmental effects?**

Minor Technical Changes or Additions. The topic of energy is discussed also in Section 5.6, *Energy*, of this Addendum.

Development of the Modified Project would require expansion of local utility lines to provide electricity and natural gas service to the residential units. The modifications to the approved TTM would decrease the electrical demand for the project site (see Table 6, *Approved Project vs. Modified Project, Projected Energy Use*), creating a beneficial impact. In addition, the residential units must meet the 2010 California Green Building Standards; Los Angeles County’s Green Building Standards; and another set of certification standards, such as LEED, CGB, GPR, or an equivalent program, with the approval of the Public Works Department Director. Implementation of these requirements would reduce energy impacts. No new significant impacts related to energy utilities would occur as a result of the project modifications.

- f) **Be served by a landfill with sufficient permitted capacity to accommodate the project’s solid waste disposal needs?**

Minor Technical Changes or Additions. Current data indicates that the Sunshine Canyon Landfill, Chiquita Canyon Landfill, and Antelope Valley Landfill have remaining capacities of 96,800,000 cy, 22,400,000 cy, and 20,400,000 cy (CalRecycle 2015a, 2015b, 2015c). Table 21 shows the total remaining capacities, daily capacities, and expected closure dates for the three landfills.

Table 21 Sunshine Canyon and Chiquita Canyon Landfills Information

Landfill	Remaining Capacity (cy)	Daily Capacity (tons per day)	Expected Closure Date
Sunshine Canyon	96,800,000	12,100	12/31/2037
Chiquita Canyon	22,400,000	6,000	11/24/2019
Antelope Valley	20,400,000	3,564	1/1/2042
Remaining Capacity	139,600,000	21,664	—

Source: CalRecycle 2015a, 2015b, 2015c.

Construction Waste

The Modified Project would have less construction debris waste than the Approved Project because 40 fewer residential units would be constructed. Using CalRecycle’s estimate for construction waste (four pounds per square foot) and an average of 5,000 square feet per unit, the Modified Project would reduce construction waste by approximately 400 tons. Therefore, the Modified Project would have a beneficial impact on construction waste.

Operation Waste

The Modified Project would have 40 fewer residential units and 139 fewer residents than the recorded project. Based on CalRecycle, the regional estimate for overall residential waste disposal for Los Angeles

5. Environmental Analysis

County is 0.41 ton per capita per year. Using a solid waste disposal rate of 0.41 ton per capita per year, the Modified Project would generate approximately 57 fewer tons per year (see Table 22).

Table 22 Approved Project vs. Modified Project, Solid Waste Generation

Approved Project		Modified Project		Difference
Population Buildout	Solid Waste Generated	Population Buildout	Solid Waste Generated	
4,360 ¹	1,788	4,221	1,731	-57 tons per year

¹ The estimated population of the Approved Project was adjusted from 4,158 persons to 4,360 persons by using more recent data on average household size for Tracts 9200.32, 9200.33 and 9200.34 from the 2010 US Census Bureau (3.46 persons per household instead of 3.3 persons per household).

Residents of the Modified Project would generate 57 fewer tons of solid waste per year. Therefore, the Modified Project would have a beneficial impact compared to the Approved Project. No new significant impacts would occur as a result of the Modified Project, and the Modified Project would not require any changes to the EIR related to solid waste.

g) Comply with federal, state, and local statutes and regulations related to solid waste?

No Impact. AB 939 (Chapter 1095, Statutes of 1989), the Integrated Waste Management Act, requires every California city and county to divert 50 percent of its waste from landfills by the year 2000. In addition, AB 939 requires each county and each city within the county to prepare a Source Reduction and Recycling Element for its jurisdiction, identifying waste characterization, source reduction, recycling, composting, solid waste facility capacity, education and public information, funding, special waste (asbestos, sewage sludge, etc.), and household hazardous waste.

The Countywide Siting Element (CSE) prepared by Los Angeles County pursuant to AB 939 identifies goals, policies, and strategies that provide for the proper planning and siting of solid waste disposal and transformation facilities for the next 15 years. The CSE was approved by the Los Angeles County Board of Supervisors and CalRecycle in 1998. It provides strategies and establishes siting criteria for evaluating the development of needed disposal and transformation facilities. The County is currently in the process of updating the CSE and has prepared a preliminary draft CSE (2012) to reflect the most recent information regarding remaining landfill disposal capacity and the County's current strategy for maintaining adequate disposal capacity.

The Modified Project would meet the requirements of AB 939 and would generate 57 fewer tons of solid waste per year compared to the Approved Project. The modifications would not hinder compliance with AB 939, and no new significant impacts would occur.

5.18.3 Adopted Mitigation Measures Applicable to the Modified Project

Water Supply

4.I-1 All appliances such as showerheads, lavatory faucets and sink faucets shall comply with efficiency standards set forth in Title 20, California Administrative Code Section 1604(f). Title 24 of the California Administrative Code Section 1606(b) prohibits the installation of

5. Environmental Analysis

fixtures unless the manufacturer has certified to the California Energy Conservation compliance with the flow rate standards.

- 4.I-2 Low flush toilets shall be installed as specified in California State Health and Safety Code Section 17921.3 and the County Green Building Ordinance.
- 4.I-3 All common area irrigation areas shall be capable of being operated by a computerized irrigation system which includes an onsite weather station/ET gage capable of reading current weather data and making automatic adjustments to independent run times for each irrigation valve based on changes in temperature, solar radiation, relative humidity, rain and wind. In addition, the computerized irrigation system shall be equipped with flow sensing capabilities, thus automatically shutting down the irrigation system in the event of a mainline break or broken head. All common area irrigation controllers shall also include a rain sensing automatic shutoff.
- 4.I-4 Common area landscaping shall emphasize drought-tolerant vegetation. Plants of similar water use shall be grouped to reduce over-irrigation of low-water-using plants. Those areas not designed with drought-tolerant vegetation shall be gauged to receive irrigation using the minimal requirements.
- 4.I-5 Residential occupants shall be informed as to the benefits of low-water-using landscaping and sources of additional assistance in such.

Please also see Mitigation Measure GCC-4 in Section 5.8, *Greenhouse Gas Emissions*.

5.18.4 Level of Significance After Mitigation

The Modified Project would only result in minor technical changes or additions to the previously certified EIR and would not result in significant impacts upon implementation of applicable regulatory requirements and mitigation measures.

5.19 MANDATORY FINDINGS OF SIGNIFICANCE

5.19.1 Summary of Impacts Identified in the Certified EIR

The 2010 Certified EIR did not include mandatory findings of significance.

5.19.2 Impacts Associated with the Modified Project

5. Environmental Analysis

Issues	Substantial Change in Project or Circumstances Resulting in New Significant Effects	New Information Showing Greater Significant Effects than Previous EIR	New Mitigation or Alternative to Reduce Significant Effect is Declined	Minor Technical Changes or Additions	No Impact
a) Does the project have the potential to degrade the quality of the environment, substantially reduce the habitat of a fish or wildlife species, cause a fish or wildlife population to drop below self-sustaining levels, threaten to eliminate a plant or animal community, substantially reduce the number or restrict the range of a rare or endangered plant or animal or eliminate important examples of the major periods of California history or prehistory?				X	
b) Does the project have the potential to achieve short-term environmental goals to the disadvantage of long-term environmental goals?				X	
c) Does the project have impacts that are individually limited, but cumulatively considerable? ("Cumulatively considerable" means that the incremental effects of a project are considerable when viewed in connection with the effects of past projects, the effects of other current projects, and the effects of probable future projects)?				X	
d) Does the project have environmental effects which will cause substantial adverse effects on human beings, either directly or indirectly?				X	

Comments:

- a) **Does the project have the potential to degrade the quality of the environment, substantially reduce the habitat of a fish or wildlife species, cause a fish or wildlife population to drop below self-sustaining levels, threaten to eliminate a plant or animal community, substantially reduce the number or restrict the range of a rare or endangered plant or animal or eliminate important examples of the major periods of California history or prehistory?**

Minor Technical Changes or Additions. As discussed in Sections 3.4, *Biological Resources*, and 3.5, *Cultural Resources*, and throughout this Addendum, the proposed modifications to the approved TTM would not significantly change the project's environmental impacts and would not significantly degrade the quality of the environment.

- b) **Does the project have the potential to achieve short-term environmental goals to the disadvantage of long-term environmental goals?**

Minor Technical Changes or Additions. The proposed modifications would result in 40 fewer single-family homes with approximately 139 fewer persons residing onsite, but would include 284 units of age-qualified housing and a community center. The Modified Project would also realign Skyline Ranch Road, modify housing product types, relocate and expand park sites, and extend multipurpose trails and bike lanes.

5. Environmental Analysis

These modifications would not achieve any short-term environmental goals to the disadvantage of long-term environmental goals. Thus, no impacts would occur.

- c) **Does the project have impacts that are individually limited, but cumulatively considerable? ("Cumulatively considerable" means that the incremental effects of a project are considerable when viewed in connection with the effects of past projects, the effects of other current projects, and the effects of probable future projects)?**

Minor Technical Changes or Additions. As discussed throughout this Addendum, the incremental differences of the proposed modifications to the recorded map would not result in substantial increases in demands or new significant cumulative impacts.

- d) **Does the project have environmental effects which will cause substantial adverse effects on human beings, either directly or indirectly?**

Minor Technical Changes or Additions. As analyzed throughout this Addendum, the net incremental impacts of the Modified Project compared to the Approved Project on the project site and its surroundings, including human beings, would be less than significant. Individual environmental impacts are analyzed in Sections 3.1 through 3.18 of this Addendum. Overall, impacts of the minor technical changes under the Modified Project would result in reduced or similar impacts as the Approved Project.

6. List of Preparers

COUNTY OF LOS ANGELES

Steven D. Jones, AICP, Principal Regional Planning Assistant

PLACEWORKS

JoAnn Hadfield, Principal, Environmental Services

Frances Yau, AICP, Associate

6. List of Preparers

This page intentionally left blank.

7. References

- AirNav.com (AirNav). 2014. Airport Information. <https://www.airnav.com/airports/>.
- California Air Resources Board (CARB). 2015, April 24. California Greenhouse Gas Inventory for 2000–2013: By Category as Defined by the Scoping Plan, April 24.
- . 2014a, June 4. Area Designations Maps: State and National. <http://www.arb.ca.gov/desig/adm/adm.htm>.
- . 2014b, May 15. First Update to the Climate Change Scoping Plan: Building on the Framework, <http://www.arb.ca.gov/cc/scopingplan/scopingplan.htm>.
- . 2013, October 23. Proposed 2013 Amendments to Area Designations for State Ambient Air Quality Standards. <http://www.arb.ca.gov/regact/2013/area13/area13isor.pdf>.
- California Department of Forestry and Fire Protection (CAL FIRE). 2007, November 7. Fire Hazard Severity Zones in SRA: Los Angeles County. http://frap.fire.ca.gov/webdata/maps/los_angeles/fhszs_map.19.pdf.
- California Department of Resources Recycling and Recovery (CalRecycle). 2015a. Facility/Site Summary Details: Sunshine Canyon City/County Landfill (19-AA-2000). <http://www.calrecycle.ca.gov/SWFacilities/Directory/19-AA-2000/Detail/>.
- . 2015b. Facility/Site Summary Details: Chiquita Canyon Sanitary Landfill (19-AA-0052). <http://www.calrecycle.ca.gov/SWFacilities/Directory/19-AA-0052/Detail/>.
- . 2015c. Facility/Site Summary Details: Antelope Valley Public Landfill (19-AA-5624). <http://www.calrecycle.ca.gov/SWFacilities/Directory/19-AA-5624/Detail/>.
- California Department of Transportation (Caltrans). 2011, September 7. California Scenic Highway Mapping System: Los Angeles County. http://www.dot.ca.gov/hq/LandArch/scenic_highways/.
- California Energy Commission (CEC). 2013a. Electricity Consumption by County. <http://ecdms.energy.ca.gov/elecbycounty.aspx>.
- . 2013b. Gas Consumption by County. <http://ecdms.energy.ca.gov/gasbycounty.aspx>.
- Department of Conservation, Division of Land Resources Protection (DOC). 2013. Los Angeles County Williamson Act FY 2012/2013. ftp://ftp.consrv.ca.gov/pub/dlrp/wa/LA_12_13_WA.pdf.

7. References

- Federal Emergency Management Agency (FEMA). 2008, September 26. Flood Insurance Rate Map: Los Angeles County, California and Unincorporated Areas. Panel 840 of 2350. Map Number 06037C0840F.
- LGC Valley, Inc. (LGC). 2016, March 28. Geotechnical Report Amended Tentative Tract Map 060922, Canyon Country, County of Los Angeles, California.
- Los Angeles, County of. 2010, February. Skyline Ranch Project Final Environmental Impact Report. County Project No. 04-075-(5).
- . 2012a, September. Los Angeles County General Plan Santa Clarita Valley Area Plan Land Use Policy Map. http://planning.lacounty.gov/assets/upl/project/ovov_2012-land-use-map.pdf.
- . 2012b, September. Los Angeles County General Plan Santa Clarita Valley Area Plan Zoning Map. http://planning.lacounty.gov/assets/upl/project/ovov_2012-zoning-map.pdf.
- . 2014. Flood Zone Determination Website. <http://dpw.lacounty.gov/wmd/floodzone/>.
- Southern California Air Quality Management District (SCAQMD). 2015, August 28. 2016 Air Quality Management Plan Fact Sheet. <http://www.aqmd.gov/docs/default-source/clean-air-plans/air-quality-management-plans/2016-air-quality-management-plan/factsheet-2016-aqmp.pdf?sfvrsn=2>.
- . 2013, February. 2012 Final Air Quality Management Plan. <http://www.aqmd.gov/home/library/clean-air-plans/air-quality-mgt-plan>.
- . 2010, September 28. Agenda for Meeting 15. Greenhouse Gases (GHG) CEQA Significance Thresholds Working Group. [http://www.aqmd.gov/docs/default-source/ceqa/handbook/greenhouse-gases-\(ghg\)-ceqa-significance-thresholds/year-2008-2009/ghg-meeting-15/ghg-meeting-15-main-presentation.pdf?sfvrsn=2](http://www.aqmd.gov/docs/default-source/ceqa/handbook/greenhouse-gases-(ghg)-ceqa-significance-thresholds/year-2008-2009/ghg-meeting-15/ghg-meeting-15-main-presentation.pdf?sfvrsn=2).
- . 1993, April. CEQA Air Quality Handbook.
- Southern California Association of Governments (SCAG). 2016, April. The 2016-2040 Regional Transportation Plan/Sustainable Communities Strategy (RTP/SCS): A Plan for Mobility, Accessibility, Sustainability, and a High Quality of Life. <http://scagrtpsc.net/Documents/2016/final/f2016RTPSCS.pdf>.
- Stantec Consulting Services Inc. (Stantec). 2016, October 18. Skyline Ranch (Revised TTM 060922) On-site Roadway Analysis.
- . 2016, December 5. Skyline Ranch (Revised VTTM 060922) Land Use and Trip Generation Update Technical Memorandum.
- State Water Resources Control Board (SWRCB). 2014, May 2. California's Areas of Special Biological Significance Map. http://www.swrcb.ca.gov/water_issues/programs/ocean/asbs_map.shtml.

Appendix A. Geotechnical Study

Appendices

This page intentionally left blank.



LGC Valley, Inc.

Geotechnical Consulting

**GEOTECHNICAL REPORT
AMENDED TENTATIVE TRACT MAP 060922
CANYON COUNTRY
COUNTY OF LOS ANGELES, CALIFORNIA**

Dated: March 28, 2016

Project No. 153035-01

Prepared For:

**PARDEE HOMES
65 North Raymond Avenue, Suite 220
Pasadena, California 91103**



LGC Valley, Inc.

Geotechnical Consulting

March 28, 2016

Project No. 153035-01

Mr. Dave Little
Pardee Homes
65 North Raymond Ave., Suite 220
Pasadena, California 91103

Subject: *Geotechnical Report, Amended Tentative Tract Map 060922, Canyon Country, County of Los Angeles, California*

In accordance with your request, LGC Valley, Inc. (LGC) is providing this geotechnical report for the amended Tentative Tract Map 060922 in the Canyon Country area of the County of Los Angeles, California. Review of previous work performed by Geolabs-Westlake Village, Inc. (GWV) and a supplemental field investigation was completed in order to prepare this report. The Amended Tentative Tract Map No. 060922, prepared by SIKAND, dated October 6, 2015, depicts the current proposed geometry of the site at 600-scale and is presented herein as Plate 3. Geotechnical Maps prepared at 100-scale are attached herein as Plates 1A through 1E. Geotechnical Cross Sections are presented on Plates 2A through 2F. Remedial Maps depicting estimated removal depths and proposed buttress keyways are attached as Plates 4A through 4E.

LGC will assume the duties of Geotechnical Consultant-of-record; therefore, this report presents the results of our supplemental investigation, incorporates prior geologic and geotechnical data (by GWV), summarizes our geotechnical analysis of the collected data, and provides our conclusions, opinions and recommendations relative to the proposed development of the site.

If you have any questions regarding our report, please contact this office. We appreciate this opportunity to be of service.

Respectfully submitted,

LGC VALLEY, INC.

DRAFT

Susan M. Berger, CEG 2069
Senior Project Geologist

SMB/BIH/MCH

DRAFT

Basil Hattar, GE 2734
Principal Engineer

Distribution: (2) Addressee
(1) SIKAND
(1) County of Los Angeles

TABLE OF CONTENTS

<u>Section</u>	<u>Page</u>
1.0 INTRODUCTION	1
1.1 Purpose and Scope of Services	1
1.2 Engineer-of-Record.....	1
1.3 Site and Project Description.....	2
1.4 Record Review	2
2.0 GEOTECHNICAL CONDITIONS	4
2.1 Regional Geology	4
2.2 Site-Specific Geology	4
2.2.1 Surficial Soils	4
2.2.2 Alluvium	4
2.2.3 Colluvium (Qcol).....	4
2.2.4 Landslide Debris (Qls).....	5
2.2.5 Terrace Deposits (Qt).....	5
2.2.6 Saugus Formation (TQs).....	5
2.2.7 Mint Canyon Formation (Tmc)	6
2.3 Geologic Structure	6
2.4 Groundwater	6
2.5 Surface Water.....	7
2.6 Seismicity, Faulting and Related Effects	7
2.6.1 Seismicity	7
2.6.2 Seismic Design Criteria.....	7
2.6.3 Faulting.....	8
2.6.4 Shallow Ground Rupture.....	9
2.6.5 Liquefaction.....	9
2.6.6 Seismically Induced Settlement	9
2.6.7 Seiches and Tsunamis	10
2.7 Laboratory Testing.....	10
2.7.1 Engineered Fill Shear Strength.....	10
2.7.2 Saugus and Mint canyon Formation Across Bedding Shear Strength	10
2.7.3 Saugus Formation Along Beadding Shear Strength.....	11
2.7.4 Mint Canyon Formation Along Bedding Strength	11
2.7.5 Landslide Slide Plan.....	12
2.8 Slope Stability	12
3.0 CONCLUSIONS	22
4.0 RECOMMENDATIONS.....	24

TABLE OF CONTENTS (Cont'd)

<u>Section</u>	<u>Page</u>
4.1	Site Earthwork 24
4.1.1	Site Preparation 24
4.1.2	Removal and Recompaction 24
4.1.2.1	Topsoil 25
4.1.2.2	Colluvium/Alluvium 25
4.1.2.3	Landslide Deposits 25
4.1.2.4	Terrace Deposits 28
4.1.2.5	Saugus Formation 28
4.1.2.6	Mint Canyon Formation 28
4.1.2.7	Water Reservoir Pad Overexcavation 28
4.1.3	Cut/Fill Transition Conditions 29
4.1.4	Cut Slope Stability/Replacements Fills 29
4.1.5	Side-Hill Shear Keys 30
4.1.6	Buttress Keys 30
4.1.7	Fill Slope Keys 30
4.1.8	Shrinkage/Bulking and Subsidence 30
4.1.9	Temporary Stability of Removal Excavations 31
4.1.10	Fill Placement and Compaction 31
4.1.11	Trench Backfill and Compaction 31
4.2	Control of Ground Water and Surface Waters 32
4.2.1	Canyon Subdrains 32
4.2.2	Stability Fill Subdrains 32
4.3	Settlement Monitoring 33
4.4	Surface Drainage and Lot Maintenance 33
4.5	Foundations 33
4.5.1	General 33
4.5.2	Bearing Capacity 34
4.5.3	Conventional Foundations 34
4.5.4	Post-Tension Foundations 35
4.5.5	Mat Foundations 37
4.5.6	Foundation Settlement 37
4.5.7	Building Clearance and Foundation Setbacks 38
4.6	Lateral Earth Pressures and Retaining Wall Design 38
4.7	Slope Creep 40
4.8	Freestanding (Top-of-Slope) Walls 41
4.9	Pavement Recommendations 41
4.10	Corrosivity to Concrete and Metal 41
4.11	Nonstructural Concrete Flatwork 42
4.12	Slope Maintenance 43
4.13	Construction Observation and Testing 44
5.0	LIMITATIONS 45

LIST OF TABLES, APPENDICES AND ILLUSTRATIONS

Tables

- Table 1 – Seismic Design Parameters (Page 8)
Table 2 – Preliminary Geotechnical Parameters for Post-Tensioned Foundation Design (Page 36)
Table 3 – Lateral Earth Pressures for Retaining Walls (Page 39)
Table 4 – Recommended Minimum Pavement Sections (Page 41)
Table 5 – Nonstructural Concrete Flatwork (Page 43)

Figures

- Figure 1 – Site Location Map (Page 3)
Figure 2 – Settlement Monument Detail (rear of text)
Figure 3 – Retaining Wall Drainage Detail (rear of text)
Figure 4 - Geotechnical Parameters for Top of Slope Walls (Rear of Text)

- Plates 1A-1E – Geotechnical Maps (Pocket)
Plates 2a-2f– Geotechnical Cross Sections (Pocket)
Plate 3 – Tentative Tract Map (Pocket)

Appendices

- Appendix A – References
Appendix B – Boring Logs
Appendix C – Laboratory Test Results
Appendix D - Slope Stability Analysis
Appendix E – General Earthwork and Grading Specifications for Rough Grading

1.0 INTRODUCTION

1.1 Purpose and Scope of Services

The main purpose of this report is to review the amended Tentative Tract Map 060922 in light of prior work performed at the site by Geolabs-Westlake Village, Inc. (GWV) and provide up-dated geotechnical interpretations, conclusions and recommendations where necessary. For this report, a supplemental investigation was undertaken in order to further evaluate the geologic and geotechnical conditions along the southwestern portion of the tract where native slopes will remain in lieu of previous fill slopes.

Our scope of services for preparation of this document included:

- Review of geotechnical reports, geologic maps and other documents relevant to the site (Appendix A, References).
- Perform a site visit to evaluate the existing condition and perform field reconnaissance mapping.
- Perform a subsurface investigation including the excavation, sampling, and logging of four large-diameter borings. The borings are labeled B-LGC-1 through B-LGC-4. Logs of the borings are presented in Appendix B, and their approximate locations are depicted on the Geotechnical Maps (Plates 1A-1E). The excavations were sampled and logged under the supervision of a geologist from our firm.
- Prepare geotechnical cross sections 1-1' through 34-34' to depict interpreted geologic conditions, to evaluate slope stability and to present mitigation measures, Plates 2a through 2f.
- Perform engineering analyses, as necessary, to review slope stability conditions.
- Perform a review of the amended Tentative Tract Map prepared by SIKAND Engineering, dated October 6, 2015.
- Preparation of this report presenting our geologic and geotechnical findings, conclusions, opinions and recommendations with respect to the proposed amended Tentative Tract Map 060922.

1.2 Engineer-of-Record

LGC has reviewed the information presented in the geotechnical reports prepared by Geolabs-Westlake Village, Inc., (References) with respect to the subject site and accepts responsibility as geotechnical engineer-of-record, and concurs with the prior information, except where modified herein.

1.3 Site Location and Project Description

The subject site is located northeast of the City of Santa Clarita, northeast of Plum Canyon/Whites Canyon Road and northwest of Sierra Highway in the County of Los Angeles, California. Legal description is “A portion of Sections 3, 9, 10, 16 & 34, Township 4 North, Range 15 West, S.B.B.M. Unincorporated area of Los Angeles County.” See Figure 1, Site Location Map.

The site occupies approximately 2,173.25 acres that currently consists of vacant open hillside terrain with light to moderate vegetation. Current access to the site is through Tract 46018-11 from Whites Canyon Road or from Sierra Highway.

The Amended Tentative Tract Map No. 060922 depicts a reduced development footprint from the previous Tentative Tract Map. Proposed development will include single-family, multi-family, parks, and school and recreation sites. Additionally, development will include support areas such as, two water tank sites, streets, driveways, debris basins, and open space areas. The development of Skyline Ranch Road from Whites Canyon/Plum Canyon Road to Sierra Highway is also integral to the project. The grading of Skyline Ranch Road will be shared between Toll Brothers and Tri Pointe Group within the limits of Tract 46018-11. Toll Brothers will construct the portion of the road within Tract 46018-11. For information regarding the portion of Skyline Ranch Road within Tract 46018-11, please refer to LGC’s report dated January 22, 2016.

The plan indicates that 16 million cubic yards of cut and 16 million cubic yards of fill operations will be necessary to bring the site to proposed design grades. Maximum design cuts and fills are approximately 95 and 123 feet, respectively. Slopes are planned at gradients of 2:1 (horizontal to vertical; h:v) and 3:1 (h:v). Cut slopes are planned to heights of 184 feet and fill slopes to 154 feet.

Remedial grading will be necessary prior to placing engineered fill in design fill areas. Removal of topsoil, surficial soils, alluvium, colluvium, landslide debris, and weathered bedrock units will be required. The approximate depths of remedial removals are shown on the attached Geotechnical Maps and are anticipated to extend to as much as approximately 62 feet below the existing ground surface.

1.4 Records Review

Review of previous reports for the site included those provided to us and references readily available within our library were used to prepare this report. Reports provided to us were prepared by GWV and are referenced herein. Geologic contacts, exploratory borings (1-92 were drilled between 2002 and 2013), exploratory borings (1-11 in 1995), exploratory test pits (TP-1 through TP-219 excavated between 2003 and 2007) and exploratory test pits (T1 through T23 in 1995) are shown on the Geotechnical Maps, Plates 1A through 1E attached herein. One boring drilled by Pacific Soils (B115) is also included.

Site Location Map

DRAFT

2.0 GEOTECHNICAL CONDITIONS

2.1 Regional Geology

The site vicinity lies in the Transverse Ranges geomorphic province of California. West-trending valleys and ridges, reflecting a parallel series of anticlines, synclines, and reverse faults characterize this province. This structure and geomorphology is generally considered to be the result of south-directed compression caused by right lateral, strike-slip movement on the "Big Bend" segment of the San Andreas Fault (CGS, 1997 Revised 2001).

Specifically, the site lies within the Soledad Basin. The Soledad Basin is rhombohedral shaped with the long axis roughly situated east-west between the San Gabriel Fault and the San Andreas Fault. Mid-Miocene in age the basin represents an extensional or depositional region.

2.2 Site-Specific Geology

Tentative Tract 060922 is underlain by surficial soils, alluvium, colluvium, landslide debris, terrace deposits and bedrock assigned to the Saugus Formation and the Mint Canyon Formation. A brief description of each unit is as follows:

2.2.1 Surficial Soils

Surficial soils are seldom identified in the borings onsite. When surficial soils are noted in the borings they are generally less than 2.5 feet deep and consist of dark to medium brown silty and clayey fine to coarse sands that are typically dry, loose, porous and contain organic debris. Surficial soils are not suitable for support of fills or structures and should be removed and compacted. Although not noted in the borings logs, their presence should be anticipated across the surface of the site.

2.2.2 Alluvium

Alluvial soils are present in the bottoms of natural drainage courses having a relatively gently sloping surface. Alluvium consists of sands, silts, gravels and cobbles that are dry, loose, and porous. Removals of alluvium will be required to competent bedrock. The alluvium has been observed from 5 to 15 feet in depth in the Whites Canyon drainage course.

2.2.3 Colluvium (Oc)

Colluvium is present near the base of slopes and in smaller drainage areas. Colluvium is derived from the downslope movement of surficial soils via gravity. Typically the colluvium onsite consists of brown to dark brown fine to coarse sands with varying amounts of clay, silt, cobbles and boulders. These materials are loose, porous and contain organic debris. Colluvium is not suitable for support of compacted fills or structures and should be removed to competent bedrock where fill is planned for site design. The colluvium will typically be thicker near the bottom of the canyon and thin upwards.

2.2.4 Landslide Debris (Qls)

Landslide debris for this report refers primarily to the larger blocks or zones of bedrock or soils that have moved down slope typically as a single event across the site. Landslide debris may consist of mixed bedrock or relatively intact blocks of bedrock, primarily within the Saugus Formation. Recent landslides are not suitable for foundation support or support of certified fills; therefore, removals of landslide debris may extend beyond the planned grading limits in order to create a 1:1 (horizontal to vertical, h:v) projection down away from the grading limit to competent material and a 1:1 (h:v) projection back up to the ground surface. There are 28 mapped landslides which are discussed in greater detail in the Recommendations section of this report.

2.2.5 Terrace Deposits (Qt)

Terrace Deposits were noted on some of the ridgelines adjacent to Whites Canyon. Terrace deposits are typically reddish brown, clayey sands and silty sands that contain local gravel and cobbles. Depths noted in the field exploration logs indicate thicknesses from 10 to 15 feet. Although not noted by GWV, terrace deposits (older alluvium) are often competent below the surficial weathering zone and are suitable for support of foundations or compacted fills. Field observation of these materials will have to be made in order to evaluate their suitability to remain in place. However, most of the terrace deposits appear to be eliminated in mass cuts.

2.2.6 Saugus Formation (TOs)

The Saugus Formation lies unconformably on the Mint Canyon Formation. The primary difference between the Saugus and the Mint Canyon formations is that the Saugus Formation can contain numerous red beds that signify silty clay and clay that is susceptible to landslides. Saugus Formation bedrock consists of interbedded sandstone, siltstone and claystone that are typically damp to moist, and dense to hard.

Saugus Formation is suitable for support of fill and structures below the weathered rind exposed near the existing ground surface. Where differing materials potentially having significantly different expansion potentials are present at pad grades (i.e. claystone adjacent to sandstone), over-excavation of the building pad and replacement as a fill cap will be required. The minimum depth of over-excavation is five feet and additional over-excavation may be warranted based on the observed conditions at the time of grading.

2.2.7 Mint Canyon Formation (Tmc)

The Mint Canyon Formation is divided into three facies; fluvial-deltaic, forest-bottomset, and marginal (Saul in AEG, 1990). The majority of the Mint Canyon Formation encountered onsite is the upper fluvial-deltaic facies. This portion of the Mint Canyon Formation consists of coarse-grained sandstones and conglomerates that contain volcanic clasts and igneous or crystalline rock types of plutonic origin; however, the igneous clasts are far more common. The sandstones are arkosic and the color is gray to gray brown. Difficulty differentiating the Saugus from the Mint Canyon arkosic sandy sediments may arise; however, Saul (1990) indicates that a primary identifier within the Mint Canyon sediments is the presence of a bright green mineral resembling epidote (under hand lens inspection).

The forest-bottomset and marginal facies of the Mint Canyon Formation are the units that typically contain lake deposits that consist of fine-grained siltstone and claystone susceptible to slope failures. These facies are not identified onsite.

Review of the boring logs by GWV, indicates that the Mint Canyon Formation is often difficult to excavate due to cementation and the presence of boulders. Thus difficult grading conditions will likely persist in the deeper cuts within the Mint Canyon formation.

The site is situated in an area where the basal conglomerate of the Saugus Formation sits on the conglomeratic unit (deltaic facies) of the Mint Canyon Formation. These conglomeratic units are not as severely affected by low angle clay beds subject to broad slope failure regimes as the upper Saugus layers where interbedded claystone and finer-grained sandstone occur.

2.3 Geologic Structure

The geologic structure of the region is that of northwest-southeast trending bedding that dips to the west or south, and faults and folds concurrent with the Transverse Ranges Geomorphic Province. As such, the bedrock formations become younger toward the southwest. Broadly, bedding dips to the southwest across the site. However, bedding within the Saugus and the Mint Canyon Formations is variable due to the cross bedded nature of the coarse-grained deposits. Thus, bedding is not likely to be unfavorable in many cut slopes due to the conglomeratic nature of the materials; however, along bedding analyses have been performed for conservancy.

2.4 Groundwater

Groundwater is generally not present within most excavations performed at the site and is not anticipated during site earthwork. Seepage was noted in many borings but is not thought to be of any significance with regard to grading of the site. However, perched water and groundwater levels fluctuate with the seasons and local zones of heavy seepage that require a sub-drain system may occur.

2.5 Surface Water

Based on our review of local maps and site reconnaissance, sheet flow is currently in all directions with a general trend toward the southwest. Surface water runoff relative to project design is the purview of the project civil engineer, but is anticipated to be directed away from planned structures and into approved drainage devices, where necessary.

2.6 Seismicity, Faulting and Related Effects

2.6.1 Seismicity

The main seismic parameters to be considered when discussing the potential for earthquake-induced damage onsite are the distances to the causative faults, earthquake magnitudes, and expected ground accelerations. We have performed site-specific analysis based on these seismic parameters for the site and the onsite geologic conditions. The results of our analysis are discussed in terms of the potential seismic events that could be produced by the maximum probable earthquakes. A maximum probable earthquake is the maximum earthquake likely to occur given the known tectonic framework. The Santa Susana Fault is located approximately 1.6 miles (2.6 km) from the.

2.6.2 Seismic Design Criteria

The site seismic characteristics were evaluated per the guidelines set forth in Chapter 16, Section 1613 of the 2013 California Building Code (CBC). Representative site coordinates of latitude 34.4396° N and longitude -118.4531° W were utilized in our analyses. The maximum considered earthquake (MCE) spectral response accelerations (S_{MS} and S_{MI}) and adjusted design spectral response acceleration parameters (S_{DS} and S_{DI}) for Site Class D are provided in Table 1.

Table 1

Seismic Design Parameters

Selected Parameters from 2013 CBC, Section 1613 - Earthquake Loads	Seismic Design Values
Site Class per Chapter 20 of ASCE 7	D
Risk-Targeted Spectral Acceleration for Short Periods (S_S)*	2.524g
Risk-Targeted Spectral Accelerations for 1-Second Periods (S_1)*	0.901g
Site Coefficient F_a per Table 1613.3.3(1)	1.00
Site Coefficient F_v per Table 1613.3.3(2)	1.50
Site Modified Spectral Acceleration for Short Periods (S_{MS}) for Site Class D [Note: $S_{MS} = F_a S_S$]	2.524g
Site Modified Spectral Acceleration for 1-Second Periods (S_{M1}) for Site Class D [Note: $S_{M1} = F_v S_1$]	1.352g
Design Spectral Acceleration for Short Periods (S_{DS}) for Site Class D [Note: $S_{DS} = (\sqrt[2]{3}) S_{MS}$]	1.683g
Design Spectral Acceleration for 1-Second Periods (S_{D1}) for Site Class D [Note: $S_{D1} = (\sqrt[2]{3}) S_{M1}$]	0.901g
Mapped Risk Coefficient at 0.2 sec Spectral Response Period, C_{RS} (per ASCE 7)	0.981
Mapped Risk Coefficient at 1 sec Spectral Response Period, C_{R1} (per ASCE 7)	0.996

* From USGS, 2013

Section 1803.5.12 of the 2013 CBC (per Section 11.8.3 of ASCE 7) states that the maximum considered earthquake geometric mean (MCE_G) Peak Ground Acceleration (PGA) should be used for geotechnical evaluations. The PGA_M for the site is equal to 0.896 (USGS, 2013).

A deaggregation of the PGA based on a 2,475-year average return period indicates that an earthquake magnitude of 6.86 at a distance of approximately 10 km (2.1 mi) from the site would contribute the most to this ground motion (USGS, 2008).

2.6.3 Faulting

The subject site is not located within an Alquist-Priolo Earthquake Fault Zone (Hart and Bryant, 1997); therefore, there are no known active or potentially active faults onsite.

The possibility of damage due to ground rupture from earthquake fault rupture is considered nil since active faults are not known to cross the site. However, the site is in proximity of active faults (Sierra Madre/San Fernando, San Gabriel, and San Andreas) which are capable of producing significant ground shaking.

Secondary effects of seismic shaking resulting from large earthquakes on the major faults in the southern California region include shallow ground rupture, soil liquefaction, and seismically induced settlements, seiches and tsunamis.

In general, these secondary effects of seismic shaking are a possibility throughout the Southern California region and are dependent on the distance between the site and causative fault and the onsite geology. The major active fault that could produce these secondary effects is the Sierra Madre/San Fernando Fault located to the southwest of the site. Other active faults that may result in shaking to the site include the Northridge, San Gabriel and San Andreas Fault, among others. A discussion of liquefaction and these secondary effects is provided in the following sections

2.6.4 Shallow Ground Rupture

Shallow ground rupture due to active faulting is not likely to occur on site due to the lack of active or potentially active fault traces across the site. Therefore, this phenomenon is not considered a significant hazard, although it is a possibility at any site.

2.6.5 Liquefaction

Liquefaction is a seismic phenomenon in which loose, saturated, granular soils behave similarly to a fluid when subject to high-intensity ground shaking. Liquefaction occurs when three general conditions exist: 1) shallow groundwater; 2) low density non-cohesive (granular) soils; and 3) high-intensity ground motion. Liquefaction is typified by a buildup of pore-water pressure in the affected soil layer to a point where a total loss of shear strength occurs, causing the soil to behave as a liquid. Studies indicate that saturated, loose to medium dense, near surface cohesionless soils exhibit the highest liquefaction potential, while dry, dense, cohesionless soils and cohesive soils exhibit low to negligible liquefaction potential.

Due to the presence of shallow bedrock at the site, complete removals of loose alluvial materials beneath compacted fills and the general lack of shallow groundwater, the site is considered to have a low liquefaction hazard.

2.6.6 Seismically Induced Settlement

During a strong seismic event, seismically induced settlement can occur within loose to moderately dense, dry or saturated granular soil. Settlement caused by ground shaking is often non-uniformly distributed, which can result in differential settlement.

Provided that the recommendations in this report are followed and removals of unsuitable materials are performed, the site is not anticipated to be susceptible to seismically induced settlement.

2.6.7 Seiches and Tsunamis

A seiche is a standing wave in an enclosed or partially enclosed body of water propagated by earthquake waves. Tsunamis are large ocean waves or series of waves generated by displacement of a large volume of water. The site is not in close proximity to body of water or near the ocean; therefore, the hazard associated with seiches and tsunamis is considered low.

2.7 Laboratory Testing

Based on the results of previous laboratory testing within the vicinity of the project site by GWV, the anticipated near-surface soils are anticipated to have a very low to medium expansion potential with a potential for high expansion, and negligible soluble sulfate attack on normal concrete, and should be considered as corrosive to severely corrosive to ferrous metals. Laboratory test results were previously provided by GWV in the referenced reports. Previous laboratory test results by GWV are provided in Appendix C of this report.

Shear strengths utilized in our analyses conform to those utilized in the previous approved reports by GWV as a part of their review of the previously approved tentative tract map and grading plan review reports. The previous data was based on laboratory testing including Atterberg limits, sieve and hydrometer, and direct shear testing of representative onsite soils, along with the observations of the subsurface soils during site subsurface investigations, along with experience within the area of the project site. LGC reviewed the previous laboratory testing and the determination of the shear strength parameters and concurred with these results. The shear strength parameters used in slope stability calculations are summarized in Appendix D, Table D-1. The following discussions are reiterated from previous approved geotechnical reports by GWV with respect to the previous derivation of the shear strengths.

2.7.1 Engineered Fill Shear Strengths

Representative samples of materials to be utilized as engineered fill were remolded at 90% relative compaction and subjected to direct shear testing. As indicated on Geolabs Plate S-f of Appendix C, a shear strength envelope of $\phi=33^\circ$, $C=200$ psf yields a conservative shear strength for the modeling of the future engineered fill.

2.7.2 Saugus and Mint Canyon Formations Across-Bedding Shear Strengths

Direct shear testing of undisturbed samples of the materials encountered at the site were previously performed in order to develop representative "across-bedding" strengths for the Saugus and Mint Canyon formations. Composite plots of the shear strength test data are presented on Plates S.TQs-1 (Saugus Formation) and S.Tmc-1 (Mint Canyon Formation) included in Appendix C. A shear strength of $\phi=40^\circ$, $C=225$ psf was selected for the Saugus Formation, while a shear strength of $\phi=40^\circ$, $C=200$ psf was selected for the Mint Canyon Formation. The higher angle of internal friction, lower cohesion strengths conform to the overwhelmingly coarse-grained nature of these formations at site.

2.7.3 Saugus Formation Along-Bedding Shear Strength

Based on GWV, in order to determine along-bedding strengths for the Saugus Formation, direct shear tests as well as multi-cycle residual shear tests were previously performed on a variety of material types. Along-bedding strengths were estimated for three categories: coarse-grained lithologies, unsheared fine-grained lithologies, and sheared fine-grained lithologies. The results of undisturbed testing were plotted on two composite shear test diagrams S.TQs-1 and -2 by GWV. The results of the multi-cycle residual shear strength testing for the Saugus Formation is presented on Plate S.TQs-3 included in Appendix C.

Along-bedding shear strengths applicable to the three categories are indicated on the appropriate GWV plots in Appendix C. The envelope for along-bedding shear strength of coarse-grained lithologies is below the lower bound test results, yielding a shear strength of $\phi=25^\circ$, $C=100$ psf. These values logically apply to the very poorly cemented, well sorted sandstones typical of the bedrock.

GWV Plate S.TQs-2 contains the results of direct shear testing of fine-grained undisturbed samples, and corresponding shear strength envelope ($\phi=17^\circ$, $C=150$ psf). This envelope is below the lower bound strength of the data. However, considering the relatively limited amount of data (due to the limited amount of fine-grained beds) the conservative values used in the tentative tract reports, as indicated on the plots, were maintained in the analysis. As seen on Plate S.TQs-3, the along-bedding shear strength envelope ($\phi=11^\circ$, $C=150$ psf) selected for sheared fine-grained beds nearly forms a lower-bound for the data (which is dominated the remolded samples).

2.7.4 Mint Canyon Formation Along-Bedding Strength

Borings performed within the site indicate that the Mint Canyon Formation is primarily composed of sandstone, conglomeratic sandstone, and conglomerate. Even those siltstones and claystones noted in the logs commonly contain significant sand fractions. A shear strength of $\phi=25^\circ$, $C=100$ psf was utilized to model failure surfaces along coarse-grained bedding of the Mint Canyon Formation. This shear strength envelope plots below the data presented on Plate S.Tmc-1 included in Appendix C. Multi-cycle shear test results on undisturbed and remolded samples of fine-grained materials are presented on Plate S.Tmc-2. Based on our review of the boring logs and geologic structure of the site, unsheared, fine-grained shear strength parameters were used for the Mint Canyon Formation in areas assumed to have fine grained lithologies. The unsheared, fine-grained shear strength parameters consisted of a shear strength of $\phi=17^\circ$, $C=150$ psf that was utilized to model failure surfaces along fine-grained bedding of the Mint Canyon Formation.

2.7.5 Landslide Slide Plane

Based on the previous evaluations and testing by GWV, the shear strength parameters $\phi=9^\circ$, $C=150$ psf were used in our analyses for landslide slide plane materials. Two multi-cycle residual shear tests were performed by GWV on slide plane materials. The third test was performed on a soft, sheared claystone retrieved from B17 at 98 feet (see cross section 35-35' below for discussion of this unit). These test results have been added to Plate S.QIs, along with the line representing $\phi=9^\circ$, $C=150$ psf. The landslide shear strengths have been used in slope stability calculations.

2.8 Slope Stability

The proposed site design consists of design cut and fill slopes planned at gradients of 2:1 (horizontal to vertical; h:v) and flatter. The highest cut slope at 3:1 (h:v) gradient is 179 feet high and is located in the northwest corner of the site, which will continue offsite to Tract 46018-11. The highest 2:1 (h:v) cut slope is 275 feet high and is located in the southern portion of the site. The highest fill slope is at a gradient of 2:1 (h:v) to a height 205 feet located in the southern portion of the site to the west of proposed Skyline Ranch Road.

LGC has accepted GWV's work which includes the shear data and determination of shear strengths; however, we disagree with the application of the data to the individual cross sections at some locations. For example, shearing is described in the boring logs as internally sheared, multidirectional, slickensides, grooved and striated. Shearing terms infer movement and movement must be denoted as slides or faults. These materials are not well bedded and are inconsistent. The boring logs indicate bedding, contacts, shears and fractures in all directions not well suited for correlation or stability analyses that conservatively assume well bedded materials. We believe this variability is due to the coarse grained nature of the conglomerates within the basal Saugus Formation and the Mint Canyon Formation. As such, the shears that are steeper than general bedding, and having conglomerate beds above and below, have been applied only where the lateral distance is small as they are unlikely to extend in any direction for more than a few tens of feet. Since they are not likely to continue long distances through conglomerate units, these features are not presented on all slope stability analyses.

For along bedding cases within the Saugus Formation Bedrock, only the along bedding clay beds that have variable terms within the boring logs are deemed applicable to use the lower clay shear strengths (cohesion 150 psf and 11° ϕ). All other cases use the non-sheared clay bed strength (cohesion 150 psf and 17° ϕ), which we conclude is likely far more applicable across the site for the Saugus and Mint Canyon Formation.

After a review of the latest tentative tract map and based on our review of prior field investigations by GWV, twenty-five cross-sections (1-1' through 3-3', 5-5', 7-7' through 15-15', 17-17' through 24-24', 28-28', 29-29', 32-32', and 34-34') were considered representative and critical with regards to slope stability analysis.

Generally, slope stability analyses were conducted using the computer program Slope W. The Bishop's Method was used to analyze rotational failure modes, and the Janbu or Spencer Method was used to analyze translational failure modes. A coefficient of horizontal acceleration of 0.15g (FS of 1.1) was used to evaluate the pseudostatic stability analyses.

Other fill and cut slopes of various orientations and heights are proposed across the site. Based on our inspection of these slopes relative to the collected geologic data and orientation of design slopes, remediation was determined as shown on the geotechnical maps.

Please note: the toe of design fill slopes and other "edge conditions" will require the installation of a standard stability fill in order to lock in the proposed design fills. Stability fills for designed slopes are considered part of the standard of grading and are shown on the attached Geotechnical Maps, where necessary. A brief description of the analysis per section is included herein.

Cross Section 1-1' and 17-17'

Cross sections 1-1' and 17-17' were drawn through a cut slope ascending along the north side of the proposed water tank pad. It ascends at a slope gradient of 2H:1V, with benches, to an approximate height of approximately 85 feet. Also on Section 17-17' a slope descending from the tank pad was also analyzed.

Bedding within the underlying Saugus Formation dips out of slope; a dip range of 3 to 10° was used in our analyses. The upper portion was assigned the fine-grained non-sheared along-bedding shear strengths within the specified dip range, and across bedding parameters outside the range, and the sheared along bedding strength was applied below the available data in the Saugus Formation Bedrock.

Static and pseudostatic slope stability calculations considered both rotational and translational modes of failure. Based on the slope stability analysis an approximately 20 deep by 40 foot wide keyway was designed for the ascending slope and a 5 foot deep by 15 foot wide keyway was designed for the slope descending from the south side of the pad. With the design keyway the static and pseudostatic analysis resulted in a factor of safety (FOS) greater than a 1.5 and 1.1, respectively. The proposed backcut was considered to be 2H:1V, slope stability of the temporary condition resulted in a FOS of greater than 1.25.

Cross Section 2-2' and 3-3'

Cross sections 2-2' and 3-3' were drawn through a south facing cut slope ascending along the north side of the proposed development. It ascends at a slope gradient of 2H:1V, with benches, to an approximate height of approximately 170 feet.

Bedding within the underlying Saugus Formation and Mint Canyon Formation dips out of slope at various angles as shown on the cross-section and analysis. The analysis considered coarse grained shear strength and fine-grained non-sheared along-bedding shear strengths where data was available, and the sheared along bedding strength was applied below the available data in the Saugus Formation Bedrock, and non-sheared along bedding within the Mint Canyon Formation Bedrock. Also three sheared beds were considered in the analysis of Cross section 2-2'.

Static and pseudostatic slope stability calculations considered both rotational and translational modes of failure. Based on the slope stability analysis an approximately 30 deep by 75 foot wide keyway was designed along cross-section 2-2' and a 30 foot deep by 100 foot wide keyway was designed along cross-section 3-3'. With the design keyways the static and pseudostatic analysis resulted in a factor of safety (FOS) greater than a 1.5 and 1.1, respectively. The proposed backcut was considered to be 3H:1V, slope stability of the temporary condition resulted in a FOS of greater that 1.25.

Cross Section 5-5'

Cross section 5-5' was drawn through a southeast facing cut slope ascending along the north side of the proposed development. It ascends at a slope gradient of 2H:1V, with benches, to an approximate height of approximately 70 feet.

Bedding within the underlying Saugus and Mint Canyon Formations dips out of slope at various angles at shown on the cross-section and analysis. The analysis considered coarse grained shear strength for the upper portion of the slope to the depth of the available data and fine-grained sheared along-bedding shear strengths was applied below the available data in the Saugus Formation Bedrock, and non-sheared along bedding within the Mint Canyon Formation Bedrock. Also one sheared beds was considered within the upper/mid height of the slope in the analysis.

Static and pseudostatic slope stability calculations considered both rotational and translational modes of failure. Based on the slope stability analysis an approximately 5 foot deep by 35 foot wide keyway was designed. With the design keyway the static and pseudostatic analysis resulted in a factor of safety (FOS) greater than a 1.5 and 1.1, respectively. The proposed backcut was considered to be 2H:1V, slope stability of the temporary condition resulted in a FOS of greater that 1.25.

Cross Section 7-7'

Cross section 7-7' was drawn through an interior south facing cut slope ascending from an interior road to pads within the proposed development. It ascends at a slope gradient of 2H:1V, with benches, to an approximate height of approximately 70 feet.

Bedding within the underlying Saugus Formations dips out of slope at bedding angles ranging from 4 to 8 degrees as shown on the cross-section and analysis. The analysis considered fine-grained bedding strength for the upper portion of the slope to the depth of the available data and fine-grained sheared along-bedding shear strengths was applied below the available data in the Saugus Formation Bedrock.

Static and pseudostatic slope stability calculations considered both rotational and translational modes of failure. Based on the slope stability analysis an approximately 10 foot deep by 30 foot wide keyway was designed. With the design keyway the static and pseudostatic analysis resulted in a factor of safety (FOS) greater than a 1.5 and 1.1, respectively. The proposed backcut was considered to be 2H:1V, slope stability of the temporary condition resulted in a FOS of greater that 1.25.

Cross Section 8-8'

Cross section 8-8' was drawn through a southwest facing fill over cut slope ascending along the central portion of the proposed development between pads. It ascends at a slope gradient of 2H:1V, with benches, to an approximate height of approximately 120 feet.

Bedding within the underlying Saugus and Mint Canyon Formations dips out of slope at various angles as shown on the cross-section and analysis. The analysis considered coarse grained shear strength for the upper portion of the slope for the Saugus and upper Mint to the depth of the available data and fine-grained non-sheared along-bedding shear strengths was applied below the available data in the Mint Canyon Formation Bedrock.

Static and pseudostatic slope stability calculations considered both rotational and translational modes of failure. Based on the slope stability analysis an approximately 5 foot deep by 45 foot wide keyway was designed. With the design keyway the static and pseudostatic analysis resulted in a factor of safety (FOS) greater than a 1.5 and 1.1, respectively. The proposed backcut was considered to be 2H:1V, slope stability of the temporary condition resulted in a FOS of greater than 1.25.

Cross Section 9-9', 29-29', 32-32', and 34-34'

These cross sections were drawn through Qls-2 and 8 along the western portion of the proposed development. Fills are proposed to be placed within the canyon areas at the toe and above the lower portions of the landslides. The upper portions of the landslide within the proposed development area and within a 2H:1V projection from the limit of the proposed design slope/roadway should be removed. On Cross-section 9-9' an approximately 70 foot high west/southwest facing cut slope was also analyzed.

For cross-sections 9-9', 29-29', 32-32' and 34-34' along Qls 2 and 8, Static and pseudostatic slope stability calculations considered translational modes of failure along the existing landslide rupture surface. Based on the slope stability analysis, with the proposed removals of the upper portion of the slide to a 2H:1V projection from the proposed slopes and roadway and placement of buttress fills in the lower portion of the landslide, the static and pseudostatic analysis resulted in a factor of safety (FOS) greater than a 1.5 and 1.1, respectively.

For the upper portion of cross-section 9-9', bedding within the underlying Saugus and Mint Canyon Formations dips out of slope at various angles as shown on the cross-section and analysis. The analysis considered fine-grained shear strength for the upper portion of the slope for the Saugus to the depth of the available data, and fine-grained sheared along-bedding shear strengths was applied to the lower portion of the Saugus and fine-grained non-sheared below the available data in the Mint Canyon Formation Bedrock. Static and pseudostatic slope stability calculations considered both rotational and translational modes of failure. Based on the slope stability analysis an approximately 30 foot deep by 50 foot wide keyway was designed. With the design keyway the static and pseudostatic analysis resulted in a factor of safety (FOS) greater than a 1.5 and 1.1, respectively. The proposed backcut was considered to be 3H:1V, slope stability of the temporary condition resulted in a FOS of greater than 1.25.

Cross Section 10-10'

Cross section 10-10' was drawn through a south facing cut slope in the northwestern portion of the proposed development. It ascends at a slope gradient of 2H:1V, with benches, to an approximate height of approximately 120 feet.

Bedding within the underlying Saugus Formations dips out of slope at various angles as shown on the cross-section and analysis. The analysis considered fine grained non sheared shear strength for the upper portion of the slope to the depth of the available data and fine-grained sheared along-bedding shear strengths was applied below the available data in the Saugus Formation Bedrock.

Static and pseudostatic slope stability calculations considered both rotational and translational modes of failure. Based on the slope stability analysis an approximately 15 foot deep by 60 foot wide keyway was designed. With the design keyway the static and pseudostatic analysis resulted in a factor of safety (FOS) greater than a 1.5 and 1.1, respectively. The proposed backcut was considered to be 2H:1V, slope stability of the temporary condition resulted in a FOS of greater that 1.25.

Cross Section 11-11'

Cross section 11-11' was drawn through a south facing cut slope in the northwestern portion of the proposed development. It ascends at a slope gradient of 2H:1V, with benches, to an approximate height of approximately 180 feet.

Bedding within the underlying Saugus Formations dips out of slope at various angles as shown on the cross-section and analysis. The analysis considered fine grained non sheared shear strength for the upper portion of the slope to the depth of the available data and fine-grained sheared along-bedding shear strengths was applied below the available data in the Saugus Formation Bedrock.

Static and pseudostatic slope stability calculations considered both rotational and translational modes of failure. Based on the slope stability analysis an approximately 40 foot deep by 200 foot wide keyway was designed. With the design keyway the static and pseudostatic analysis resulted in a factor of safety (FOS) greater than a 1.5 and 1.1, respectively. The proposed backcut was considered to be 3H:1V, slope stability of the temporary condition resulted in a FOS of greater that 1.25.

Cross Section 12-12'

Cross section 12-12' was drawn through a south facing cut slope in the northeastern portion of the proposed development. It ascends at a slope gradient of 2H:1V, with benches, to an approximate height of approximately 175 feet.

Bedding within the underlying Mint Canyon Formation dips out of slope at approximately 8 to 15 degrees as shown on the cross-section and analysis. The analysis considered coarse grained shear strength for the upper portion of the slope to the depth of the available data and fine-grained non-sheared along-bedding shear strengths was applied below the available data in the Mint Canyon Formation Bedrock.

Static and pseudostatic slope stability calculations considered both rotational and translational modes of failure. Based on the slope stability analysis an approximately 50 foot deep by 70 foot wide keyway was designed. With the design keyway the static and pseudostatic analysis resulted in a factor of safety (FOS) greater than a 1.5 and 1.1, respectively. The proposed backcut was considered to be 2H:1V, slope stability of the temporary condition resulted in a FOS of greater than 1.25.

Cross Section 13-13'

Cross section 13-13' was drawn through a south facing fill over cut slope in the northeastern portion of the proposed development. It ascends to the water tank pad at a slope gradient of 2H:1V, with benches, to an approximate height of approximately 140 feet.

Bedding within the underlying Mint Canyon Formation dips out of slope at various angles to as shown on the cross-section and analysis. The analysis considered coarse grained shear strength for the upper portion of the slope to the depth of the available data and fine-grained non-sheared along-bedding shear strengths was applied below the available data in the Mint Canyon Formation Bedrock.

Static and pseudostatic slope stability calculations considered both rotational and translational modes of failure. Based on the slope stability analysis an approximately 5 foot deep by 20 foot wide keyway was designed. With the design keyway the static and pseudostatic analysis resulted in a factor of safety (FOS) greater than a 1.5 and 1.1, respectively. The proposed backcut was considered to be 2H:1V, slope stability of the temporary condition resulted in a FOS of greater than 1.25.

Cross Section 14-14'

Cross section 14-14' was drawn through a west facing cut slope in the eastern portion of the proposed development. It ascends at a slope gradient of 2H:1V, with benches, to an approximate height of approximately 170 feet.

Bedding within the underlying Mint Canyon Formation dips into slope at bedding angles between approximately 12 to 20 degrees as shown on the cross-section and analysis. The analysis considered coarse grained shear strength for the upper portion of the slope to the depth of the available data and fine-grained non-sheared along-bedding shear strengths was applied below the available data in the Mint Canyon Formation Bedrock.

Static and pseudostatic slope stability calculations considered both rotational and translational modes of failure. Based on the slope stability analysis an approximately 25 foot deep by 50 foot wide keyway was designed. With the design keyway the static and pseudostatic analysis resulted in a factor of safety (FOS) greater than a 1.5 and 1.1, respectively. The proposed backcut was considered to be 3H:1V, slope stability of the temporary condition resulted in a FOS of greater than 1.25.

Cross Section 15-15'

Cross section 15-15' was drawn through a west facing cut slope in the eastern portion of the proposed development. It ascends at a slope gradient of 2H:1V, with benches, to an approximate height of approximately 120 feet.

Bedding within the underlying Mint Canyon Formation dips into slope at various bedding angles between approximately 0 to 11 degrees as shown on the cross-section and analysis. The analysis considered coarse grained shear strength for the upper portion of the slope to the depth of the available data and fine-grained non-sheared along-bedding shear strengths was applied below the available data in the Mint Canyon Formation Bedrock.

Static and pseudostatic slope stability calculations considered both rotational and translational modes of failure. Based on the slope stability analysis an approximately 15 foot deep by 30 foot wide keyway was designed. With the design keyway the static and pseudostatic analysis resulted in a factor of safety (FOS) greater than a 1.5 and 1.1, respectively. The proposed backcut was considered to be 2H:1V, slope stability of the temporary condition resulted in a FOS of greater than 1.25.

Cross Section 18-18'

Cross section 18-18' was drawn through a west facing cut slope in the eastern portion of the proposed development. It ascends at a slope gradient of 2H:1V, with benches, to an approximate height of approximately 60 feet.

Bedding within the underlying Saugus and Mint Canyon Formation dips out of slope at various bedding angles as shown on the cross-section and analysis. The analysis considered coarse grained shear strength for the upper portion of the slope to the depth of the available data and fine-grained non-sheared along-bedding shear strengths was applied below the available data in the Mint Canyon Formation Bedrock.

Static and pseudostatic slope stability calculations considered both rotational and translational modes of failure. Based on the slope stability analysis, the static and pseudostatic analysis resulted in a factor of safety (FOS) greater than a 1.5 and 1.1, respectively.

Cross Section 19-19'

Cross section 19-19' was drawn through a south facing cut slope descending below the road and fill over cut slope above the roadway in the central portion of the proposed development. It ascends at a slope gradient of 2H:1V, with benches, to an approximate height of approximately 100 feet below the roadway and 40 feet above the roadway.

Bedding within the underlying Saugus and Mint Canyon Formation dips out of slope at various bedding angles as shown on the cross-section and analysis. The analysis considered fine grained shear strength for the upper Saugus Bedrock with two sheared layers in the upper portions, and coarse grained shear strength for the upper portion of the Mint Canyon Formation to the depth of the available data and fine-grained non-sheared along-bedding shear strengths was applied below the available data in the Mint Canyon Formation Bedrock.

Static and pseudostatic slope stability calculations considered both rotational and translational modes of failure. Based on the slope stability analysis an approximately 20 foot deep by 50 foot wide keyway was designed for the lower slope and an approximately 10 foot deep by 25 foot wide keyway for the upper slope. With the design keyways the static and pseudostatic analysis resulted in a factor of safety (FOS) greater than a 1.5 and 1.1, respectively. The proposed backcut was considered to be 2H:1V, slope stability of the temporary condition resulted in a FOS of greater that 1.25.

Cross Section 20-20'

Cross section 20-20' was drawn through a south facing cut slope in the southeastern portion of the proposed development. It ascends at a slope gradient of 2H:1V, with benches, to an approximate height of approximately 280 feet above the roadway.

Bedding within the underlying Saugus and Mint Canyon Formation dips into slope at various bedding angles as shown on the cross-section and analysis. The analysis considered coarse grained shear strength for the upper Saugus Bedrock with one sheared layer in the upper portions, and coarse grained shear strength for the Mint Canyon Formation Bedrock.

Static and pseudostatic slope stability calculations considered both rotational and translational modes of failure. Based on the slope stability analysis an approximately 15 foot deep by 30 foot wide keyway was designed for the upper portion of the slope. With the design keyways the static and pseudostatic analysis resulted in a factor of safety (FOS) greater than a 1.5 and 1.1, respectively. The proposed backcut was considered to be 3H:1V, slope stability of the temporary condition resulted in a FOS of greater that 1.25.

Cross Section 21-21'

Cross section 21-21' was drawn through a north/northeast facing cut slope in the southeastern portion of the proposed development. It ascends at a slope gradient of 2H:1V, with benches, to an approximate height of approximately 190 feet above the roadway.

Bedding within the underlying Saugus and Mint Canyon Formation dips into slope to slightly out of slope at various bedding angles as shown on the cross-section and analysis. The analysis considered coarse grained shear strength for the slope in the Saugus and Mint canyon Formation Bedrock to approximately 20 to 25 feet below the the toe of slope, and fine grained shear strength for the Mint Canyon Formation Bedrock below that portion.

Static and pseudostatic slope stability calculations considered both rotational and translational modes of failure. Based on the slope stability analysis an approximately 25 foot deep by 60 foot wide keyway was designed for the slope. With the design keyways the static and pseudostatic analysis resulted in a factor of safety (FOS) greater than a 1.5 and 1.1, respectively. The proposed backcut was considered to be 2H:1V, slope stability of the temporary condition resulted in a FOS of greater that 1.25.

Cross Section 22-22'

Cross section 22-22' was drawn through a southwest and north/northeast facing cut slopes in the southeastern portion of the proposed development. The slopes ascend at a slope gradients of 2H:1V, with benches, to an approximate height of approximately 160 feet on the south side of the roadway and 120 feet on the north side of the roadway.

Bedding within the underlying Saugus and Mint Canyon Formation dips into slope to slightly out of slope at various bedding angles as shown on the cross-section and analysis. The analysis considered coarse grained shear strength in the upper portion of the slope in the Saugus and Mint Canyon Formation Bedrock, and fine grained shear strength for the Mint Canyon Formation Bedrock below that portion.

Static and pseudostatic slope stability calculations considered both rotational and translational modes of failure. Based on the slope stability analysis, the design slopes have a static and pseudostatic factor of safety (FOS) greater than a 1.5 and 1.1, respectively.

Cross Section 23-23'

Cross section 23-23' was drawn through a west/southwest facing cut slopes in the southeastern portion of the proposed development. The slopes ascend at a slope gradients of 2H:1V, with benches, to an approximate height of approximately 70 feet above an interior roadway and pad.

Bedding within the underlying Saugus and Mint Canyon Formation dips out of slope at various bedding angles as shown on the cross-section and analysis. The analysis considered coarse grained shear strength in the upper portion of the slope in the Saugus and Mint Canyon Formation Bedrock, and fine grained shear strength for the Mint Canyon Formation Bedrock below that portion.

Static and pseudostatic slope stability calculations considered both rotational and translational modes of failure. Based on the slope stability analysis, the design slopes have a static and pseudostatic factor of safety (FOS) greater than a 1.5 and 1.1, respectively.

Cross Section 24-24'

Cross section 24-24' was drawn through a south/southwest facing sliver fill slope in the southeastern portion of the proposed development. The slopes ascend at a slope gradients of 2H:1V, with benches, to an approximate height of approximately 210 feet on the south side of the roadway.

Bedding within the underlying Saugus and Mint Canyon Formation dips out of slope at various bedding angles as shown on the cross-section and analysis. The analysis considered fine-grained shear strength for the Saugus Formation Bedrock and coarse grained shear strength in the upper portion of the Mint Canyon Formation Bedrock to the depth of available data, and fine grained shear strength for the Mint Canyon Formation Bedrock below that portion.

Static and pseudostatic slope stability calculations considered both rotational and translational modes of failure. Based on the slope stability analysis an approximately 30 foot deep by 100 foot wide keyway was designed for the slope. With the design keyways the static and pseudostatic analysis resulted in a factor of safety (FOS) greater than a 1.5 and 1.1, respectively. The proposed backcut was considered to be 3H:1V, slope stability of the temporary condition resulted in a FOS of greater than 1.25.

Cross Section 28-28'

Cross section 28-28' is representative of cross-section 26-26' and 27-27' drawn through a fill over native condition along the western portion of the site, descending to the west below Skyline Ranch Road. The slopes descend at a slope gradient of 2H:1V, with benches, to an approximate height of approximately 30 to 60 feet on the west side of the roadway.

Bedding within the underlying Saugus and Mint Canyon Formation dips out of slope at various bedding angles as shown on the cross-section and analysis. The analysis considered fine-grained shear strength for the upper portion and coarse grained for the lower portion of the Saugus Formation Bedrock to the depth of available data, and fine grained shear strength for the Mint Canyon Formation Bedrock below that portion.

Static and pseudostatic slope stability calculations considered both rotational and translational modes of failure. Based on the slope stability analysis an approximately 10 foot deep by 55 foot wide keyway was designed for the slope. With the design keyways the static and pseudostatic analysis resulted in a factor of safety (FOS) greater than a 1.5 and 1.1, respectively. The proposed backcut was considered to be 2H:1V, slope stability of the temporary condition resulted in a FOS of greater than 1.25.

3.0 CONCLUSIONS

Based on our review of prior reports, it is our conclusion that the site development proposed on the attached Geologic Maps (Plates 1A-1E) is feasible from a geotechnical standpoint, provided the following recommendations included in this report are incorporated into the project plans and specifications, and followed during site grading and construction.

Our geotechnical conclusions are as follows:

- The site is within the County of Los Angeles and thus is subject to the Specifications and Guidelines set by the County.
- Sandy soils typically obtain the majority of settlement for deeper fills within a much shorter time frame than finer-grained soils. Thus the majority of site settlement for deeper fills is anticipated to occur shortly after the completion of grading.
- Engineered fill shall meet the requirements of 90 percent relative compaction and 93 percent relative compaction for fill zones less than and greater than 40 feet in thickness, respectively.
- Deeper fill zones (>50 feet) will require the review of settlement monuments installed at the completion of major grading operations to help ensure that primary and secondary settlement are within design limits prior to the release of lots for home construction.
- Remedial removals are not anticipated to encounter deep alluvium (greater than approximately 15 feet). Thicker sections of landslide debris and large landslide complexes will be encountered. Estimated depths of removals of these units are shown on the Geotechnical Maps. As such, removal depths are anticipated to vary, and steeper portions of slopes may have to be laid back to accommodate benching and the required cut-fill transition angle of 2:1 (H:V) near pad grade which helps reduce the potential for differential settlement below home sites. The upper portion (20 feet) of native slopes below pads where a cut/fill transition occurs will need to be laid back to a 2:1 (H:V) angle to reduce the potential for differential settlement in these areas.
- No significant groundwater was encountered at the site, though local perched conditions were observed. Groundwater is not anticipated to affect site grading operations. However, water may occur anywhere and be more likely where landslide removals are required.
- Site bedrock and adjacent units are anticipated to be rippable with conventional earthwork machinery; however, the conglomeratic units within the Saugus Formation and the Mint Canyon Formation are anticipated to be difficult to excavate. Additionally, conglomeratic units contain boulders and cemented zones that are anticipated to generate oversized materials requiring disposal in deeper fills.
- Stability fill keyways are depicted on the Geotechnical Maps, Plates 1A through 1E. The typical standard for stability fill keyways is provided within this report.
- Subdrains should be installed in the bottoms of canyons and natural drainage courses once removals of unsuitable materials has been accomplished; subdrains may also be required for stability fill areas. The following pipe diameter versus length of run should be planned for site construction:
 - 4-inch diameter pipe up to 500 feet
 - 6-inch diameter pipe over 500 and up to 1000 feet
 - 8-inch diameter pipe up to 1,500 feet
 - 10-inch diameter pipe Greater than 1,500 feet
(or 2 8-inch pipes)

- Active or potentially active faults are not known to exist on the site; however, faults have been mapped on or trending towards the site. These faults are considered to be inactive based on the work of others and do not require structural setbacks. The location of these faults should be carefully mapped during site grading to review the potential for clay gouge or other features that may negatively affect planned structures which can occur on proposed pads should these features trend across them.
- Previous laboratory test results of representative site soils indicate a very low to medium with potential locally high expansion potentials.
- Previous laboratory test results of the onsite soils indicate a negligible potential for soluble sulfates. However, the Mint Canyon Formation may have a potential for negligible to severe sulfate content.
- Previous laboratory test results of the onsite soils indicate a negligible potential of hydro-collapse.
- From a geotechnical perspective, the existing onsite soils are suitable for use as fill, provided they are relatively free from rocks (larger than 12 inches in maximum dimension), construction debris, and organic material.

DRAFT

4.0 RECOMMENDATIONS

4.1 Site Earthwork

We anticipate that earthwork during the mass/rough grading operations at the site will consist of site preparation, removals of unsuitable soil, excavation of cut material, and fill placement. We recommend that earthwork onsite be performed in accordance with the recommendations herein, the County of Los Angeles grading Requirements, and the General Earthwork and Grading Specifications for Rough Grading included in Appendix E. In case of conflict, the recommendations in the following sections shall supersede those included as part of Appendix E.

4.1.1 Site Preparation

Prior to grading of areas to receive structural fill or engineered structures, all ground surfaces should be cleared of obstructions, any existing debris, unsuitable material, and stripped of vegetation. Heavy vegetation and debris should be removed and properly disposed of offsite. All debris from any demolition activities at the site should also be removed and disposed off-site. Holes or depressions resulting from the removal of buried obstructions should be replaced with compacted fill.

Following remedial removals, areas to receive fill should be scarified to a minimum depth of 6 inches, brought to a near-optimum moisture condition, and recompact to at least 90 or 93 percent relative compaction (based on American Standard of Testing and Materials [ASTM] Test Method D1557) depending on the thickness of fills.

4.1.2 Removal and Recompaction

As discussed in Sections 2.2, portions of the site are underlain by unsuitable soils, which may settle under the surcharge of fill and/or foundation loads. These materials include surficial soils, undocumented fills (stockpiles), alluvium, landslide debris and weathered terrace deposits and bedrock of the Saugus Formation. Compressible materials not removed by the planned grading should be excavated to competent terrace deposits, Saugus Formation bedrock or Mint Canyon Formation bedrock, moisture conditioned or dried back (as needed) to obtain an above-optimum moisture content, and then recompact prior to additional fill placement or surface improvements. The actual depth and extent of the required removals should be determined during grading operations by the geotechnical consultant; however, estimated removal depths are summarized below and are shown on the attached Geotechnical Maps (Plates 1A through 1G). The project geologist should approve all bottoms prior to fill placement.

Debris not suitable for compacted fills, such as, rebar, plastic, trash, metal, etc. should be removed and wasted from the site. Organic debris should be mulched and incorporated into compacted fills such that the fills maintain less than 2 percent organics by volume. Concrete and large rocks (greater than 12 inches in diameter) may be placed in windrows in accordance with the detail provided herein. Windrows should be maintained a minimum of 10 feet below finished grade and 10 from slope faces. Isolated boulders should be maintained a minimum of 20 feet below finish grade.

Survey bottom removals are required for canyon bottoms and keyways. Subdrains and backdrains, and windrows should also be surveyed.

4.1.2.1 Topsoil

Areas to receive fill, which are on slopes flatter than 5:1 (horizontal to vertical) and where normal benching would not completely remove the topsoil, should be stripped to suitable formational material prior to fill placement. Topsoil is expected to be generally 1 to 3 feet thick, although localized deeper accumulations may be encountered during grading.

4.1.2.2 Colluvium/Alluvium

Within the limits of grading, colluvial and alluvial materials should be completely removed to competent material. Alluvial depths have been observed up to 12 feet deep.

4.1.2.3 Landslide Deposits

The landslide deposits within the limits of the planned grading should be completely removed to competent material during site grading in order to remove the highly disturbed and weathered material. The actual depth of stripping or overexcavation should be determined during grading based on field observations by the geotechnical consultant. However, based on our review of previous data, the depth of removals for each slide is shown on the Geotechnical Maps, Plates 1A through 1E in areas of proposed fill.

(NOTE: The following landslide discussion represents estimated depths based on approximate cross section geometry, geomorphic expression, and some borehole data that may not be thoroughly representative.)

There are 28 landslides on site labelled as L1 through L28. A brief description of each landslide follows:

- **L1** – Located mostly offsite on Tract 46018-11 (northwest portion of site), explored by B91, approximately 20-25 feet deep. Strong geomorphic expression and hummocky terrain. Complete removal of slide is recommended.

- **L2** – Located in the northwestern portion of the site, explored by B26 and B54, approximately 31 to 60 feet deep. Geomorphic expression of the headscarp is clear. Partial removal of slide is recommended within the 1:1 (h:v) influence of the planned grading (see cross sections 11-11', 29-29' and 30-30'). Remaining portion of slide will be delineated as Restricted Use Area. Additionally, we recommend a remedial fill be placed in the canyon below the landslide as shown on the Geotechnical Map, Plate 1A in order to provide support for the landslide and inhibit reactivation. The remedial fill will not require removals of unsuitable materials prior to placement; however, a subdrain should be installed to one side within fairly competent material to inhibit bending of the pipe due to settlement. This subdrain will connect and provide outlets for proposed drains further up the canyon.
- **L3** – Located east of L2, TP-102 indicates 2 feet deep at toe only. Weak geomorphic expression with offset drainage at toe. A working cross section indicates a possible depth of 15 feet. Complete removal is recommended.
- **L4** – Located southeast of L3, weak geomorphic expression, explored by TP-104 and TP-105 (8.9 and 12+ feet deep, respectively), cross section 4-4' indicates a potential thickness of 20 feet. Complete removal is recommended.
- **L5** – Small slide on the side of L28, minor geomorphic expression, no exploration, no sections, estimated depth 15-20 feet.
- **L6** – No obvious geomorphic expression, no exploration (steep terrain), section 3-3' indicates nearly complete removal with planned cut grades.
- **L7** – Large landslide, explored by B27, B85, and B86 (slide depths 21.5, 18 and 33.3 feet, respectively), section 4-4' and 9-9', within a planned cut area; however, additional removals of up to 20 feet may be required beneath planned cuts.
- **L8** – Large landslide, explored by B71 and B80 (slide depths 23 and 30 feet, respectively), sections 9-9' and 29-29' depict geometry. Along 9-9' estimate 10-40 feet of removals beneath cut areas. This slide will be remediated with a fill added to the canyon. Portion of slide will remain within a Restricted Use Area.
- **L8a** – Small feature between L7 and L8, not explored, section 9-9' indicates 15 removals required beneath planned grades.
- **L9** – Outside grading limits to the north of the site. Slide will not impact proposed development; however, it will be placed in a Restricted Use Area.
- **L10** – Large feature with good geomorphic expression, explored by B81 and B82 (depths of slide 25 and 27.1 feet, respectively), no sections were created through this feature. The upper portion of the slide will be excavated by planned cuts and the lower portion should be removed to depths of 25 feet.
- **L10a** – Small feature between L10 and L11, no exploration, will partially be removed by planned cuts and should partially require

removals on the order of L10 and L11 of 25 to 30 feet.

- **L11** – Downslope of L10 and L10a, explored by B73, B51 and B83 (slide depths 44.5, 29.4 and 31.9 feet, respectively), depicted on section 27-27' and 28-28'. Situated mostly beneath proposed fill, removals are anticipated to be on the order of 32 feet.
- **L12** – Located downslope of L11 and upslope of L13, no exploration
- **L13** – Located downslope of L11 and L12, explored by B75 and B84 (slide depths not identified to total depths of 28 and 53 feet, respectively), questionable slide.
- **L14** – Located downslope of L11, explored by B74 (questionable slide to total depth of 27.5 feet, refusal on boulder), no sections.
- **L15** – Small feature, not explored, no sections, estimated depth 10-15 feet.
- **L16** – Small feature, explored at the toe by TP-164 and TP-165 (depth of slide 10 and 7 feet, respectively), no sections, estimated depth 15 feet.
- **L17** – Smaller feature, located in the southeastern portion of the site, explored at the toe by TP-46 and TP-47 (both indicate depths greater than 8 feet), no cross sections, estimated depth 35 feet.
- **L18** – Small feature in Mint Canyon Formation, explored at the toe by TP-93 and nearby TP-84 (do not indicate slide debris but describe material as Saugus), possible slopewash, estimated depth 4 to 12 feet.
- **L19** – Similar to L18, no explored, nearby TP-85 indicates terrace deposits to 3 feet then Saugus Formation within an area mapped as Mint Canyon, weathered slopewash, possible depth 10 feet?
- **L20** – Small feature, no exploration, estimated depth
- **L21** – Outside proposed grading limits and will not impact the development. Will be delineated as a Restricted Use Area.
- **L22** – Outside proposed grading limits and will not impact the development. Will be delineated as a Restricted Use Area.
- **L23** – Small feature, south side of Whites Canyon drainage course along the edge of the proposed fill slope, not explored (steep terrain), section 33-33', estimated slide depth 10-15 feet.
- **L24** – Outside proposed grading limits and will not impact the development. Will be delineated as a Restricted Use Area.
- **L25** - Outside proposed grading limits and will not impact the development. Will be delineated as a Restricted Use Area.
- **L27** – Located partially on Tract 46626 (east of site) and Tract 46018-11 (northeast of site). A portion of the slide appears to have been buttressed by grading of Tract 46626. Removals of L27 will be contained inside the property boundary; therefore, a 1:1 cut from the property line will be made along the onsite boundary (TT 060922) and along the boundary of Tract 46018-11. Estimated depth is 20 feet per cross section 25b-25b'.
- **L28** – Large feature, good geomorphic expression, explored by B88, B89 and B90 (slide depths 59, 51 and 67.5 feet, respectively), seepage noted above the slide plane, section 4-4' indicates 45 feet of removals beneath proposed cut areas.

4.1.2.4 Terrace Deposits

The weathered and desiccated surface of the Terrace deposits within the limits of the planned grading should be removed to a competent surface as approved by the Geotechnical Engineer. Depths should be anticipated to range from 1 to 4 feet.

4.1.2.5 Saugus Formation

The weathered and desiccated surface of the Saugus Formation bedrock within the limits of the planned grading should be removed to a competent surface as approved by the Geotechnical Engineer. Depths should be anticipated to range from 1 to 3 feet. Where clay beds are exposed near proposed pad grades, the pad overexcavation will be increased to 10 feet. Portions of the Saugus Formation consist of conglomerate and may be difficult to excavate and may also generate oversized materials which will require disposal in deeper fill areas.

4.1.2.6 Mint Canyon Formation

The weathered and desiccated surface of the Mint Canyon Formation bedrock within the limits of the planned grading should be removed to a competent surface as approved by the Geotechnical Engineer. Depths should be anticipated to range from 1 to 3 feet. The Mint Canyon Formation is more cemented than the Saugus Formation and may require difficult or heavy excavation techniques. This formation may also generate oversized materials that will require disposal in deeper fills. In cut pads and streets areas that will expose Mint Canyon Formation Bedrock, for ease of foundation and utility excavation, it is recommended that these areas be overexcavated a minimum of 5 feet below pad graded within lots areas, and to a depth of 2-feet below the lowest utilities within proposed street areas.

4.1.2.7 Water Reservoir Pad Overexcavations

Two water tank pads are planned within the proposed project site. The proposed water tank pads are anticipated to be within cut bedrock of the Saugus Formation or within cut/fill transition pad within the Mint Canyon Formation. Overexcavation of the tank pads within cut pads will only be necessary if lithologies of different expansion potential are encountered at pad grade, or if a cut/fill transition is encountered within the tank pad. As necessary, the cut portion of the tank pads should be overexcavated at least 7 feet below pad grade or to a depth to match the fill depths across the tank, to at least 10 feet beyond the tank perimeter. The engineered fill placed within this overexcavation and within 15 feet (horizontal) of tanks' footprints should be moistened to optimum moisture content and compacted to at least 95% relative compaction.

4.1.3 Cut/Fill Transition Conditions

In order to reduce the potential for differential settlement in areas of cut/fill transitions, we recommend the entire cut portion of the transition building pads be overexcavated and replaced with properly compacted fill to mitigate the transition condition beneath the proposed structure. For transitions less steep than a 2:1 (horizontal to vertical), the overexcavation of the cut portion of the building pad should be a minimum of 5 feet below the planned finish grade elevation of the pad. Lot overexcavations will be reviewed on a lot by lot basis during grading to determine if deeper overexcavations area required based on the exposed graded conditions.

For cut/fill transitions steeper than a 2:1 (horizontal to vertical), we recommend that native slopes be laid back to nearly a 2:1 slope angle, and that fill below future home sites have no greater than a 3:1 ratio of fill thickness across the pad in any direction to help reduce future potential differential settlement damage to homes and other structures. All overexcavations should extend across the entire lot or laterally at least 5 feet beyond the building perimeter or footprint. Details regarding cut/fill transitions are provided in the attached General Earthwork and Grading Specifications (Appendix E).

4.1.4 Cut Slope Stability/Replacement Fills

Geologic mapping of design cut slopes and fill over cut slopes should be performed by a geologist during grading operation to evaluate the slopes for potential slope instabilities. If unsuitable soils are present or if potential slope instabilities are found, we recommend that the unsuitable cut slopes on the site be replaced with stability fills.

We recommend that the stability/replacement fill have a minimum horizontal width of 15 feet from the backcut to the slope face. We also recommend that the stability/replacement fill key be excavated a minimum of 15 feet wide with a minimum depth of at least 2 to 3 feet below the toe-of-slope. The key bottom should be tilted a minimum of 2 percent into-the-slope. Benching of the backcut as the fill is placed, as well as, overbuilding the slope and trimming it back may be required. Keys for design fill over cut slopes are shown on the attached geotechnical maps, Plates 1A through 1G.

We also recommend that a subdrain be installed along the back bottom edge of the key and at minimum 30-foot vertical intervals if the replacement fill is greater than 30 feet in height. The outlet locations of the subdrains should be determined in the field during site grading. The subdrains should consist of a 4-inch diameter perforated PVC pipe surrounded by 3 cubic feet (per linear foot) of crushed rock wrapped in filter fabric (Marifi 140N or equivalent). The subdrain should have a minimum fall of 1-percent toward the outlet.

4.1.5 Side-Hill Shear Keys

Any side-hill daylight cut situations (i.e. the edge of the cut area will start right at the top edge of a descending natural slope). Due to potentially weathered soils along the edge of the descending relatively-steep natural slope and anticipated steep hillside soil creep conditions; we recommend that a side-hill shear key be constructed along the edge of the side-hill daylight cut.

The side-hill shear key should be excavated a minimum of 12 to 15 feet in horizontal width with the bottom at the outer edge (i.e. closest to the hillside) excavated to a depth of 5 feet or at least 2 feet into competent formational material, whichever is deeper. The key bottom should also have a fall of at least 2-percent into-the-slope.

4.1.6 Buttress Keys

Based on slope stability analysis performed as a part of this review, buttress keys have been designed for proposed site slopes, as necessary. The buttress widths and depths are variable based on the design slope heights and the geologic conditions at those locations. The buttress widths and depths and backcut angles are provided on the geotechnical maps and cross-sections included in this report.

Buttresses should have backdrains in accordance with our typical detail provided herein. Backcuts should be performed in accordance with the recommendations shown on the geotechnical maps and cross-sections provided herein.

4.1.7 Fill Slope Keys

Prior to the placement of fill slopes that will be placed above natural and/or cut areas on the site; a fill slope key should be constructed. The fill slope key should be excavated at least 2 feet into competent soil along the toe-of-slope and constructed approximately 15 feet wide with the key bottom angled a minimum of 2 percent into-the-slope.

4.1.8 Shrinkage/Bulking and Subsidence

Based on the previous evaluation and testing by GWV, both shrinkage and bulking is anticipated at the site. Prior values given by GWV, indicate mostly bulking across the site. The data from the borings onsite do not appear to be representative due to the method of sampling (Kelly bar) and the coarse-grained nature of the materials tested (i.e. conglomerates, cobbles and boulders). Our opinion regarding shrinkage and bulking onsite, based upon experience, is as follows:

Soil/Colluvium/Alluvium – Shrink 10-15%

Landslide Debris – Shrink 0-15% to 15 feet depth; 15'+ bulk 0-2%

Saugus Formation – Bulk 2-4% 0-5 feet depth; 5'+ bulk 5%

Mint Canyon Formation – Bulk 6%

These are preliminary rough estimates which will vary with depth of removal, stripping losses, field conditions at the time of grading, etc. In addition, handling losses are not included in the estimates.

4.1.9 Temporary Stability of Removal Excavations

Temporary excavations maybe cut vertically up to five feet. Excavations over five feet should be slot-cut, shored, or cut to a 1:1 (h:v) slope gradient. Surface water should be diverted away from the exposed cut, and not be allowed to pond on top of the excavations. Temporary cuts should not be left open for an extended period of time. Planned temporary conditions should be reviewed by the geotechnical consultant of record in order to reduce the potential for sidewall failure. The geotechnical consultant may provide recommendations for controlling the length of sidewall exposed.

4.1.10 Fill Placement and Compaction

From a geotechnical perspective, the onsite soils are suitable for use as compacted fill, provided they are screened of rocks greater than 6 inches in maximum dimension, organic material, and construction debris. Areas prepared to receive structural fill and/or other surface improvements should be scarified to a minimum depth of 6 inches, brought to at least optimum-moisture content, and recompacted to at least 90 percent relative compaction (based on ASTM Test Method D1557). Fills greater than 40 feet deep should be compacted to at least 93percent relative compaction. The optimum lift thickness to produce a uniformly compacted fill will depend on the type and size of compaction equipment used. In general, fill should be placed in uniform lifts generally not exceeding 8 inches in loose thickness. Placement and compaction of fill should be performed in accordance with local grading ordinances under the observation and testing of the geotechnical consultant.

If possible, import soils to be used as fill shall be essentially free from organic matter and other deleterious substances, and should contain no materials over 6 inches in maximum dimension, have a very low to low expansion potential (i.e Expansion Index ranging from 0 to 50), and negligible sulfate content. Representative samples of the desired import source shall be given to the Geotechnical Consultant at least 48 hours (2 working days) before importing grading begins so that its suitability can be determined and appropriate tests performed.

Previous testing of the crushed rock (created from the oversize cobbles and boulders) by GWV on the site indicates that the on-site rock is of sufficient quality for use as rip rap, crushed aggregate base, and subdrain/backdrain rock. Periodic testing of any crushed rock product should be performed for verification purposes, should it be proposed for use as a construction material. We anticipate that utilizing oversize rock as crushed aggregate base for future streets would require coordination with the County of Los Angeles Public Works department.

4.1.11 Trench Backfill and Compaction

The onsite soils may generally be suitable as trench backfill provided they are screened of rocks and other material over 6 inches in diameter and organic matter. Trench backfill should be compacted in uniform lifts (generally not exceeding 8 inches in compacted thickness) by mechanical means to at least 90 percent relative compaction (per ASTM Test Method D1557).

If trenches are shallow and the use of conventional equipment may result in damage to the utilities; clean sand, having sand equivalent (SE) of 30 or greater, should be used to bed and shade the utilities. Sand backfill should be densified. The densification may be accomplished by jetting or flooding and then tamping to ensure adequate compaction. A representative from LGC should observe, probe, and test the backfill to verify compliance with the project specifications.

4.2 Control of Ground Water and Surface Waters

4.2.1 Canyon Subdrains

In order to help reduce the potential for ground water accumulation in the proposed fill areas, we recommend subdrains be installed in the bottoms of canyons fill areas prior to fill placement. The canyon subdrains should consist of a 4 to 10-inch diameter PVC pipe surrounded by a minimum of 9-cubic feet (per linear foot) of 3/4-inch gravel wrapped in a filter fabric (Mirafi 140N or equivalent). Where the subdrain is placed on fill in order to outlet the subdrain, the subdrain should consist of solid PVC pipe. The subdrain should have a minimum fall of at least 1 percent.

Preliminary canyon subdrain locations are presented on the Geotechnical Maps (Plate 1A through 1K). Details for subdrain construction are provided in the attached General Earthwork and Grading Specifications (Appendix E). The actual need and/or location of canyon subdrains should be based on the evaluation of the configuration of the canyon bottoms by the geotechnical consultant after the removal of compressible soils have been completed.

A representative of the project civil engineer should survey the installed subdrains for alignment and grade. Sufficient time should be allowed for the surveys prior to commencement of fill placement operations over the subdrain. The subdrain outlets should be installed to discharge water into positive drainage devices (e.g. storm drain boxes, natural canyon bottoms, etc.).

The following pipe diameter versus length of run should be planned for site construction:

4-inch diameter pipe	up to 500 feet
6-inch diameter pipe	over 500 and up to 1000 feet
8-inch diameter pipe	up to 1,500 feet
10-inch diameter pipe (or 2 8-inch pipes)	Greater than 1,500 feet

4.2.2 Stability Fill Subdrains

Subdrains should be provided in the stability fills constructed on-site in order to minimize surficial slope instability. The subdrains should be placed along the heel of the stability fill key (across the entire length of the key) and along the backcut at approximately 30-foot vertical intervals. The subdrains should be placed and constructed in accordance with the recommendations presented in Appendix E.

4.3 Settlement Monitoring

Settlement monuments should be installed in deep fill areas (greater than 50 feet in thickness) to record the fill settlement once design grades are achieved. Locations of these settlement monuments will be determined during grading based on the observed and final site conditions. A detail indicating the construction of the settlement monuments is shown on Figure 2.

The schedule for recording site settlement should be as follows:

Monuments should be surveyed immediately after installation, weekly for the first month, every two weeks for the next three months, and monthly after that. The monitoring should be performed until the survey data plots indicate that the estimated remaining settlement is no longer significant (i.e. three consecutive readings indicate relatively no change).

4.4 Surface Drainage and Lot Maintenance

Positive drainage of surface water away from structures is very important. No water should be allowed to pond adjacent to buildings or the top of slopes. Positive drainage may be accomplished by providing drainage away from buildings at a gradient of at least 2 percent for a distance of at least 5 feet, and further maintained by a swale of drainage path at a gradient of at least 1 percent. Where limited by 5-foot side yards, drainage should be directed away from foundations for a minimum of 3 feet and into a collective swale or pipe system. Where necessary, drainage paths may be shortened by use of area drains and collector pipes. Eave gutters also help reduce water infiltration into the subgrade soils if the downspouts are properly connected to appropriate outlets.

Property owners should be reminded of the responsibilities of hillside maintenance practices (i.e., the maintenance of proper lot drainage; the undertaking of property improvements in accordance with sound engineering practices; and the proper maintenance of vegetation, including prudent lot and slope irrigation).

Planters with open bottoms adjacent to buildings should be avoided. Planters should not be designed adjacent to buildings unless provisions for drainage, such as catch basins, liners, and/or area drains, are made. Overwatering must be avoided.

4.5 Foundations

4.5.1 General

Preliminary recommendations for foundation design and foundation construction are presented herein. When the structural loads for the proposed structures are known they should be provided to our office to verify the recommendations presented herein.

The following foundation recommendations are provided. The three foundations recommended for the proposed structures are: (1) Conventional foundation for very low expansion potential and shallow fills; (2) Post-Tension foundations; or (3) Mat Slabs.

The information and recommendations presented in this section are not meant to supersede design by the project structural engineer or civil engineer specializing in the structural design nor impede those recommendations by a corrosion consultant. Should conflict arise, modifications to the foundation design provided herein can be provided.

4.5.2 Bearing Capacity

Shallow foundations may be designed for a maximum allowable bearing capacity of 1,500 lb/ft² (gross), for continuous footings a minimum of 12 inches wide and 12 inches deep, and spread footings 24 inches wide and 12 inches deep, into certified compacted fill. A factor of safety greater than 3 was used in evaluating the above bearing capacity value. This value may be increased by 300 psf for each additional foot in depth and 100 psf for each additional foot of width to a maximum value of 3,000 psf.

Lateral forces on footings may be resisted by passive earth resistance and friction at the bottom of the footing. Foundations may be designed for a coefficient of friction of 0.35, and a passive earth pressure of 250 lb/ft²/ft. The passive earth pressure incorporates a factor of safety of greater than 1.5.

All footing excavations should be cut square and level as much as possible, and should be free of sloughed materials including sand, rocks and gravel, and trash debris. Subgrade soils should be pre-moistened for the assumed low expansion potential (to be confirmed at the end of grading). These allowable bearing pressures are applicable for level (ground slope equal to or flatter than 5H:1V) conditions only.

Bearing values indicated above are for total dead loads and frequently applied live loads. The above vertical bearing may be increased by one-third for short durations of loading which will include the effect of wind or seismic forces.

4.5.3 Conventional Foundations

Conventional foundations may be used to support proposed structures underlain by very low expansive soils (i.e. Expansion Index less than 20 and Plasticity Index less than 15) and with less than 40 feet of fills.

Continuous footings should have minimum widths of 12 inches, 15 inches or 18 inches for one-story, two-story or three-story structures, respectively. Individual column footings should have a minimum width of 24 inches.

Footings for proposed two story structures should have minimum depths (below lowest adjacent finish grade) of 18 inches and 12 inches for exterior and interior footings, respectively for assumed very low expansion potential (0-20 Expansion Index).

The subgrade should be moisture-conditioned and proof-rolled just prior to construction to provide a firm, relatively unyielding surface, especially if the surface has been loosened by the passage of construction traffic.

The underslab vapor/moisture retarder (i.e. an equivalent capillary break method) may consist of a minimum 15-mil thick vapor/moisture retarder (or equivalent) in conformance with ASTM E 1745 Class A material, placed in general conformance with ASTM E1643, underlain by a minimum 2-inch of sand and overlain by 1-inch of sand, as needed. The sand layer requirements above the vapor barrier are the purview of the foundation engineer/structural engineer, and should be provided in accordance with ACI Publication 302 “Guide for Concrete Floor and Slab Construction”. These recommendations must be confirmed (and/or altered) by the foundation engineer, based upon the performance expectations of the foundation. Ultimately, the design of the moisture retarder system and recommendations for concrete placement and concrete mix design, which will address bleeding, shrinkage, and curling are the purview of the foundation engineer, in consideration of the project requirements provided by the architect and developer. The underslab vapor/moisture retarder described above is considered a suitable alternative in accordance with the Capillary Break Section 4.505.2.1 of the CALGreen code.

Subgrade soils should be pre-saturated to optimum moisture content to a depth of 12 inches for a very low expansion potential. Expansion index testing should be performed at the end of grading for confirmation. The minimum thickness of the floor slabs should be at least 4.5 inches, and joints should be provided per usual practice.

4.5.4 Post-Tension Foundations

Based on the site geotechnical conditions and provided the remedial recommendations provided herein are implemented, the site may be considered suitable for the support of the anticipated structures using a post-tensioned slab-on-grade foundation system, for the anticipated low to high expansive soils and for deeper fill areas. The following section summarizes our recommendations for the foundation system.

Table 2 contains the geotechnical recommendations for the construction of PT slab on grade foundations. The structural engineer should design the foundation system based on these parameters including the foundation settlement as indicated in the following section to the allowable deflection criteria determined by the structural engineer/architect.

TABLE 2
Preliminary Geotechnical Parameters for Post-Tensioned Foundation Design

Parameter	Value		
Expansion Classification (Assumed to be confirmed at the completion of grading):	Low and High Expansion		
Thornthwaite Moisture Index (From Figure 3.3):	-20		
Constant Soil Suction (From Figure 3.4):	PF 3.6		
Center Lift	<u>Low</u>	<u>Medium</u>	<u>High</u>
Edge moisture variation distance (from Figure 3.6), e_m :	9.0 feet	9.0 feet	9.0 feet
Center lift, y_m :	0.3 inches	0.47 inches	0.66 inches
Edge Lift	<u>Low</u>	<u>Medium</u>	<u>High</u>
Edge moisture variation distance (from Figure 3.6), e_m :	5.2 feet	5.0 feet	5.0 feet
Edge lift, y_m :	0.61 inches	1.1 inches	1.6 inches
Soluble Sulfate Content for Design of Concrete Mix in Contact with Site Soils in Accordance with American Concrete Institute standard 318, Section 4.3:	Assume Negligible Exposure (to be confirmed at the completion of grading)		
Corrosivity of Earth Materials to Ferrous Metals:	Severely Corrosive		
Modulus of Subgrade Reaction, k (assuming presaturation as indicated below):	100 pci (low) 85 pci (medium to high)		
Additional Recommendations:			
<ol style="list-style-type: none"> 1. Presaturate slab subgrade to at least optimum-moisture content or to 1.2 times optimum moisture, to minimum depths of 12 and 18 inches below ground surface, respectively for low and medium expansion potentials and 1.3 times optimum moisture, to minimum depths of 24 inches for high expansion. 2. Install a 15-mil moisture/vapor barrier (or equivalent) moisture/vapor barrier in direct contact with the concrete (unless superseded by the Structural/Post-tension engineer*) with 1 to 2 inches of sand below the moisture/vapor barrier. 3. Minimum perimeter foundation embedment below finish grade for moisture cut off should be 12, 18, and 24 inches, respectively for low, medium, and high expansion potentials. 4. Minimum slab thickness should be 5 inches. 			

* The above sand and Visqueen recommendations are traditionally included with geotechnical foundation recommendations although they are generally not a major factor influencing the geotechnical performance of the foundation. The sand and Visqueen requirements are the purview of the foundation engineer/corrosion engineer (in accordance with ACI Publication 302 "Guide for Concrete Floor and Slab Construction") and the homebuilder to ensure that the concrete cures more evenly than it would otherwise, is protected from corrosive environments, and moisture penetration of through the floor is acceptable to future homeowners. Therefore, the above recommendations may be superseded by the requirements of the previously mentioned parties.

4.5.5 Mat Foundations

A mat foundation can be used for support of proposed residential buildings. An allowable soil bearing pressure of 1,000 psf may be used for the design of the mat at the surface under the slab area.

The allowable bearing value is for total dead loads and frequently applied live loads and may be increased by one-third for short durations of loading which will include the effect of wind or seismic forces. A coefficient of vertical subgrade reaction, k , of 85 pounds per cubic inch (pci) may be used to evaluate the pressure distribution beneath the mat foundation.

The magnitude of total and differential settlements of the mat foundation will be a function of the structural design and stiffness of the mat. Based on assumed structural loads, we estimate that total static settlement will be on the order of an inch at the center of the mat foundation. Post construction differential settlement can be taken as one-half of the maximum estimated settlement

Resistance to lateral loads can be provided by friction acting at the base of foundations and by passive earth pressure. Foundations may be designed for a coefficient of friction of 0.35. Minimum perimeter footing embedment provided in the previous sections maybe reduced for the mat slab design.

Coordination with the structural engineer will be required in order to ensure structural loads are adequately distributed throughout the mat foundation to avoid localized stress concentrations resulting in potential settlement. The foundation plan should be reviewed by LGC to confirm preliminary estimated total and differential static settlements.

4.5.6 Foundation Settlement

Based on the site design relative to native grades and considering site remedial removals, fill at the site will range from approximately 5 to over 150 feet in thickness within the site. Surface settlement monuments are planned to be installed in the deep fill areas within the subject tract. It is anticipated that most of the consolidation will be complete by the time final design grades are achieved due to the sandy nature of site soils. To provide documentation that the settlement is complete and three consecutive readings indicate relatively no change approximately three to four months of readings should be anticipated from the time that grading is complete.

Based on a preliminary review of site grading plans major fill differentials are not anticipated across building pad areas. Once site development plans are finalized the anticipated fill thickness and differentials on a lot by lot basis can be determined and considered in future foundation designs.

Based on preliminary evaluations and following the geotechnical release for construction, the preliminary static post-construction settlements are estimated to be up to 1-inch with a differential settlement of approximately of 0.75-inches. The above differential settlement value should be evaluated at the completion of grading based on the final fill conditions.

4.5.7 Building Clearance and Foundation Setbacks

All building foundation located close to slopes should have a minimum setback per Figure 1808.7.1 of the 2013 CBC. The setback distances should be measured from competent materials on the outer slope face, excluding any weathered and loose materials.

Per the 2013 CBC Section 1808.7.1 and Figure 1808.7.1, building clearance from the toe of an ascending slope should be equal one-half of the total slope height to a maximum setback of 15 feet. Retaining walls may be constructed at the base of the slope to achieve the required building clearances.

Per the 2013 CBC Section 1808.7.2 and Figure 1808.7.1, the building foundation constructed on or near a descending slope should be setback or deepened to provide a minimum footing setback equal to the total height of slope (H) divided by 3 (H/3). The footing setback should be a minimum of 5 feet for slopes up to 15 feet in height and vary up to 40 feet for slopes up to 120 feet in height. The footing setbacks should be measured from the edge of the footing to the competent materials on the outer slope face.

4.6 Lateral Earth Pressures and Retaining Wall Design

The following lateral earth pressures may be used for the design of any future site retaining walls. We recommend low expansive soils for retaining wall backfill if no onsite soils fit the required minimum parameters ($SE > 30$). The recommended lateral pressures for approved soils (expansion index less than 30 per U.B.C. 18-I-B, less than 15 percent passing #200 sieve, and PI less than 15) for level or sloping backfill are presented on the table below. The recommended lateral pressures for clean sand or approved select soils for level or sloping backfill are presented on the following Table 3.

Table 3
Lateral Earth Pressures for Retaining Walls

Conditions	Equivalent Fluid Weight (pcf)		
	Level Backfill	2:1 Backfill Sloping Upwards	Seismic Earth Pressure (pcf) *
	Approved Select Material	Approved Select Material	
Active	35	55	13
At-Rest	50	75	- -
Passive	250	- -	-

* For walls with greater than 6-feet in backfill height, the above seismic earth pressure should be added to the static pressures given in the table above. The seismic earth pressure should be considered as an inverted triangular distribution with the resultant acting at 0.6H in relation to the base of the retaining wall footing (where H is the retained height).

Embedded structural walls should be designed for lateral earth pressures exerted on them. The magnitude of these pressures depends on the amount of deformation that the wall can yield under load. If the wall can yield enough to mobilize the full shear strength of the soil, it can be designed for “active” pressure. If the wall cannot yield under the applied load, the shear strength of the soil cannot be mobilized and the earth pressure will be higher. Such walls should be designed for “at-rest” conditions. If a structure moves toward the soils, the resulting resistance developed by the soil is the “passive” resistance.

For design purposes, the recommended equivalent fluid pressure for each case for walls founded above the static groundwater and backfilled with low expansive onsite or import soils is provided in the table above. The equivalent fluid pressure values assume free-draining conditions. The backfill soils should be compacted to at least 90 percent relative compaction. The walls should be constructed and backfilled as soon as possible after backcut excavation. Prolonged exposure of backcut slopes may result in some localized slope instability. If conditions other than those assumed above are anticipated, the equivalent fluid pressure values should be provided on an individual-case basis by the geotechnical engineer.

Surcharge loading effects from any adjacent structures should be evaluated by the geotechnical and structural engineers. Surcharge loading on retaining walls should be considered when any loads are located within a 1:1 (horizontal to vertical) projection from the base of the retaining wall and should be added to the applicable lateral earth pressures. Where applicable, a minimum uniform lateral pressure of 100 psf should be added to the appropriate lateral earth pressures to account for typical vehicle traffic loading.

All retaining wall structures should be provided with appropriate drainage and appropriately waterproofed. The outlet pipe should be sloped to drain to a suitable outlet. Typical wall drainage design is illustrated on the attached Figure 3. It should be noted that the recommended subdrain does not provide protection against seepage through the face of the wall and/or efflorescence. Efflorescence is generally a white crystalline powder (discoloration) that results when water, which contains soluble salts, migrates over a period of time through the face of a retaining wall and evaporates. If such seepage or efflorescence is undesirable, retaining walls should be waterproofed to reduce this potential.

For sliding resistance, the friction coefficient of 0.35 may be used at the concrete and soil interface. Wall footings should be designed in accordance with structural considerations. The passive resistance value may be increased by one-third when considering loads of short duration such as wind or seismic loads. For short term loading (i.e. seismic) the allowable bearing capacity may be increased by one-third for seismic loading.

Foundations for retaining walls in properly compacted fill should be embedded at least 18 inches below lowest adjacent grade. At this depth and a minimum of 12 inches in width, an allowable bearing capacity of 1,500 psf may be assumed. A factor of safety greater than 3 was used in evaluating the above bearing capacity value. This value may be increased by 300 psf for each additional foot in depth and 100 psf for each additional foot of width to a maximum value of 3,000 psf. All excavations should be made in accordance with Cal OSHA. Excavation safety is the sole responsibility of the contractor.

4.7 Slope Creep

Due to the potentially expansive nature of the fill soils within the site, the probability exists for development of a creep condition on the slopes within the site with the passage of time. Creep is a very slow nearly continuous downward and outward movement of slope soils. The movement is minimal under small shear stresses, however sufficient to produce permanent deformation but not large enough to produce a shear failure as occurs in a landslide. For the site slopes, the principal cause for development of a creep condition is a result of repeated cycles of swelling and contraction of expansive soils over a period of time due to seasonal variations in the moisture content and is an irreversible process resulting in a loss of shear strength and subsequent buildup of small shear stresses. Experience has shown that creep can affect surficial soils to vertical depths of several feet depending on the expansiveness of the soils and the slope height and inclination, as well as a number of other factors. Other factors which can contribute to development of a slope creep condition include overwatering and subsequent saturation of the slope soils, prolonged or intense rainfall, prolonged periods of drought, rodent activity, inadequate plant materials used for slope protection, inadequate drainage facilities, and/or lack of a proper slope maintenance program. Creep cannot be stopped or eliminated; however, proper foundation embedment and design can be provided such that the magnitude, depth and rate of creep movement can be mitigated for structures proposed on or near descending slopes. For slope heights greater than 10 feet, the slope creep will impact improvements within approximately 10 to 15 feet from the top of slope. Some settlement and tilting may occur in improvements located in this outer 10 to 15 feet of the pad.

4.8 Freestanding (Top-of-Slope) Walls

Freestanding wall footings should be founded a minimum of 18 inches below the lowest adjacent grade. To reduce the potential for unsightly cracks, we recommend inclusion of construction joints at 10- to 20-foot intervals.

Due to the potential creep of soils, where free standing walls are constructed close to top-of-slope, some tilt of the wall should be anticipated. To reduce the amount of tilt, a combination of grade beam and caisson foundations may be used to support the wall. The system should consist of minimum 12-inch diameter caissons placed at 8 feet maximum on centers, and each 8 feet long and connected together at top with 12-inch by 12-inch grade beam. The geotechnical design parameters for the caisson are shown on the attached Figure 4.

4.9 Pavement Recommendations

Based on a preliminary assumed minimum R-value of 20 and an assumed Traffic Indices (TI's) of 6, 7, and 8.5, we recommend the following minimum pavement sections (Table 4). The R-value should be determined during the concluding stages of grading, and the final pavement section should be designed accordingly. TI's for the streets within the subject project site should be obtained from the appropriate regulatory agency or calculated by a traffic engineer. Final pavement sections should be confirmed by the project civil engineer based upon the project traffic index and the County of Los Angeles Department of Public Works minimum requirements.

TABLE 4
Recommended Minimum Pavement Sections

Traffic Index	6	7	8.5
Asphalt Concrete (in.)	4	4	4
Aggregate Base (in.)	10	12	17

The aggregate base material should conform to the specifications for Class 2 Aggregate Base (Caltrans) or Crushed Aggregate/Miscellaneous Base (Standard Specifications for Public Works Construction). The base material should be compacted to achieve a minimum relative compaction of 95 percent. The subgrade should achieve a minimum relative compaction of 90 percent through the upper 12 inches. Base and subgrade materials should be moisture-conditioned to relatively uniform moisture content at or slightly over optimum.

4.10 Corrosivity to Concrete and Metal

The National Association of Corrosion Engineers (NACE) defines corrosion as “a deterioration of a substance or its properties because of a reaction with its environment.” From a geotechnical viewpoint, the “environment” is the prevailing foundation soils and the “substances” are the reinforced concrete foundations or various buried metallic elements such as rebar, piles, pipes, etc., which are in direct contact with or within close vicinity of the foundation soil.

In general, soil environments that are detrimental to concrete have high concentrations of soluble sulfates and/or pH values of less than 5.5. ACI 318R-08 Table 4.3.1 provides specific guidelines for the concrete mix design when the soluble sulfate content of the soils exceeds 0.1 percent by weight or 1,000 ppm. The minimum amount of chloride ions in the soil environment that are corrosive to steel, either in the form of reinforcement protected by concrete cover, or plain steel substructures such as steel pipes or piles, is 500 ppm per California Test 532.

Based on previous site soil testing by others, the onsite soils are classified as having a negligible sulfate exposure condition with a potential for localized moderate to severe sulfate content in accordance with ACI 318R-08 Table 4.3.1. As a preliminary recommendation due to results of previous sulfate content testing, concrete in contact with onsite soils should be designed in accordance with ACI 318R-08 Table 4.3.1 for the negligible category. It is also our opinion that onsite soils should be considered severely corrosive to buried metals. Site grading will redistribute the materials, which may result in soils with different corrosion potentials. Therefore, the as-graded soil conditions should be verified with confirmatory sampling and testing during the grading phase of the project.

Despite the minimum recommendation above, LGC is not a corrosion-engineering firm. Therefore, we recommend that after site grading, consultation with a competent corrosion engineer be initiated to evaluate the actual corrosion potential of the site and to provide recommendations to reduce the corrosion potential with respect to the proposed improvements, as necessary. The recommendations of the corrosion engineer may supersede the above requirements.

4.11 Nonstructural Concrete Flatwork

Concrete flatwork (such as walkways, bicycle trails, etc.) have a high potential for cracking due to changes in soil volume related to soil-moisture fluctuations because these slabs are typically much thinner than foundation slabs and are not reinforced with the same dynamic as foundation elements. To reduce the potential for excessive cracking and lifting, concrete should be designed in accordance with the minimum guidelines outlined in Table 5. These guidelines will reduce the potential for irregular cracking and promote cracking along construction joints, but will not eliminate all cracking or lifting. Thickening the concrete and/or adding additional reinforcement will further reduce cosmetic distress.

TABLE 5
Nonstructural Concrete Flatwork

	Homeowner Sidewalks	Private Drives	Patios/Entryways	City Sidewalk Curb and Gutters
Minimum Thickness (in.)	4	5	5	City/Agency Standard
Presaturation	Wet down prior to placing	Presoak to 12 inches	Presoak to 12 inches	City/Agency Standard
Reinforcement	—	No. 3 at 24 inches on centers	No. 3 at 24 inches on centers	City/Agency Standard
Thickened Edge	—	8" x 8"	-	City/Agency Standard
Crack Control	Saw cut or deep tool joint to a minimum of 1/3 the concrete thickness	Saw cut or deep tool joint to a minimum of 1/3 the concrete thickness	Saw cut or deep tool joint to a minimum of 1/3 the concrete thickness	City/Agency Standard
Maximum Joint Spacing	5 feet	10 feet or quarter cut whichever is closer	6 feet	City/Agency Standard
Aggregate Base	—	2	2	City/Agency Standard

4.12 Slope Maintenance

To reduce the potential for erosion and slumping of graded slopes, all slopes should be planted with ground cover and deep-rooted vegetation as soon as practical upon completion of grading. Surface water runoff and standing water at the top-of-slopes should be avoided. Oversteepening of slopes should be avoided during construction activities and landscaping. Maintenance of proper lot drainage, undertaking of property improvements in accordance with sound engineering practice, and proper maintenance of vegetation, including regular pad and slope irrigation, should be performed. Trenches excavated on a slope face for utility of irrigation lines and/or for any purpose should be properly backfilled and compacted by a vibratory plate, or equivalent, in order to obtain a minimum 90 percent relative compaction, in accordance with ASTM Test Method D1557, to the slope face. Observation/testing and acceptance by the geotechnical consultant during trench backfill is recommended. A rodent control program should be established and maintained.

4.13 Construction Observation and Testing

The recommendations provided in this report are based on subsurface observations and geotechnical analysis by others. The interpolated subsurface conditions should be checked in the field during construction by a representative of LGC.

Construction observation and testing should also be performed by the geotechnical consultant during future grading, excavations, backfill of utility trenches, preparation of pavement subgrade and placement of aggregate base, foundation or retaining wall construction or when an unusual soil condition is encountered at the site. Grading plans, foundation plans, and final project drawings should be reviewed by this office prior to construction.

DRAFT

5.0 LIMITATIONS

Our services were performed using the degree of care and skill ordinarily exercised, under similar circumstances, by reputable engineers and geologists practicing in this or similar localities. No other warranty, expressed or implied, is made as to the conclusions and professional advice included in this report. The samples taken and submitted for laboratory testing, the observations made and the in-situ field testing performed are believed representative of the entire project; however, soil and geologic conditions revealed by excavation may be different than our preliminary findings. If this occurs, the changed conditions must be evaluated by the project soils engineer and geologist and design(s) adjusted as required or alternate design(s) recommended.

This report is issued with the understanding that it is the responsibility of the owner, or of his/her representative, to ensure that the information and recommendations contained herein are brought to the attention of the architect and/or project engineer and incorporated into the plans, and the necessary steps are taken to see that the contractor and/or subcontractor properly implements the recommendations in the field. The contractor and/or subcontractor should notify the owner if they consider any of the recommendations presented herein to be unsafe.

The findings of this report are valid as of the present date. However, changes in the conditions of a property can and do occur with the passage of time, whether they be due to natural processes or the works of man on this or adjacent properties.

In addition, changes in applicable or appropriate standards may occur, whether they result from legislation or the broadening of knowledge. Accordingly, the findings of this report may be invalidated wholly or partially by changes outside our control.

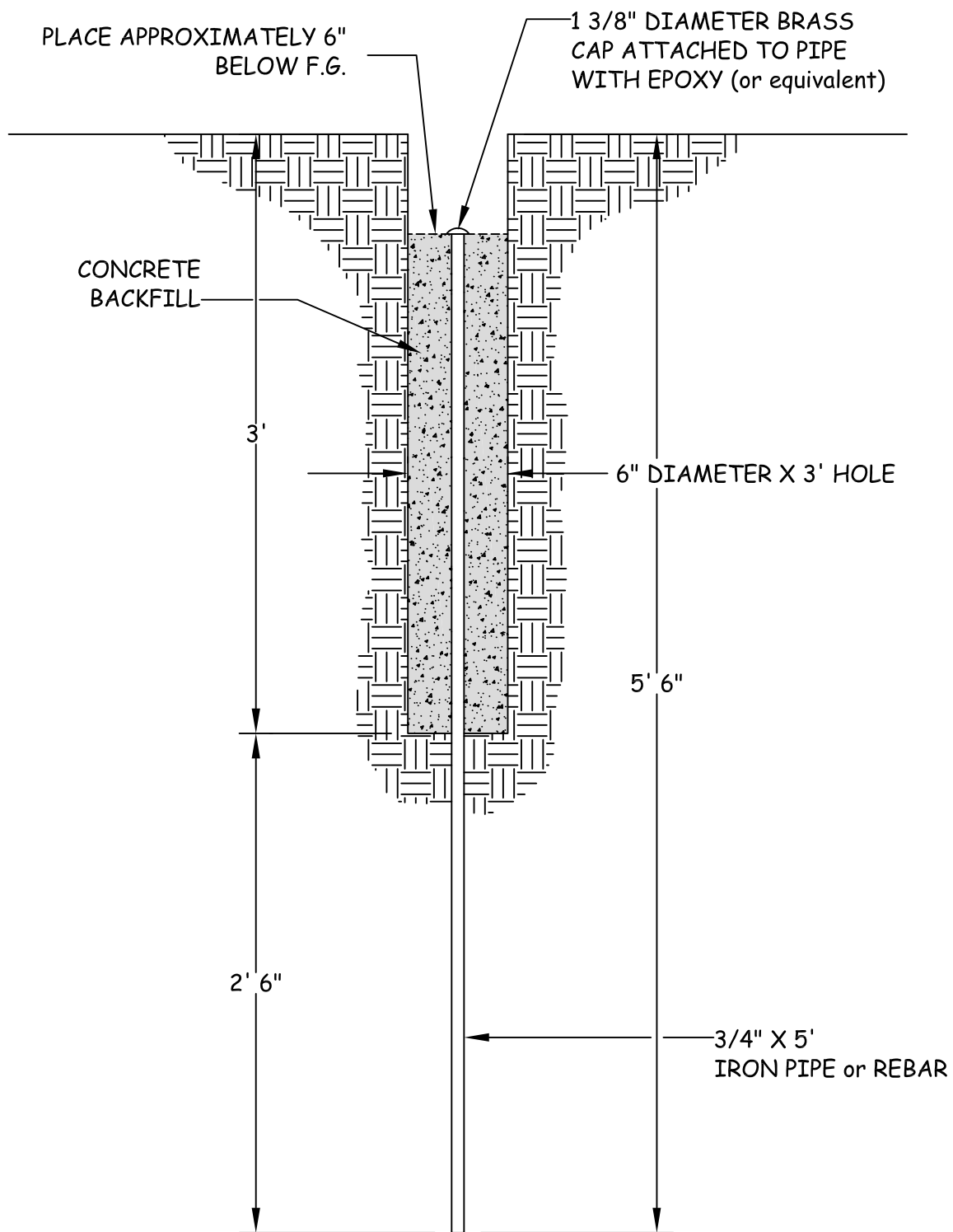
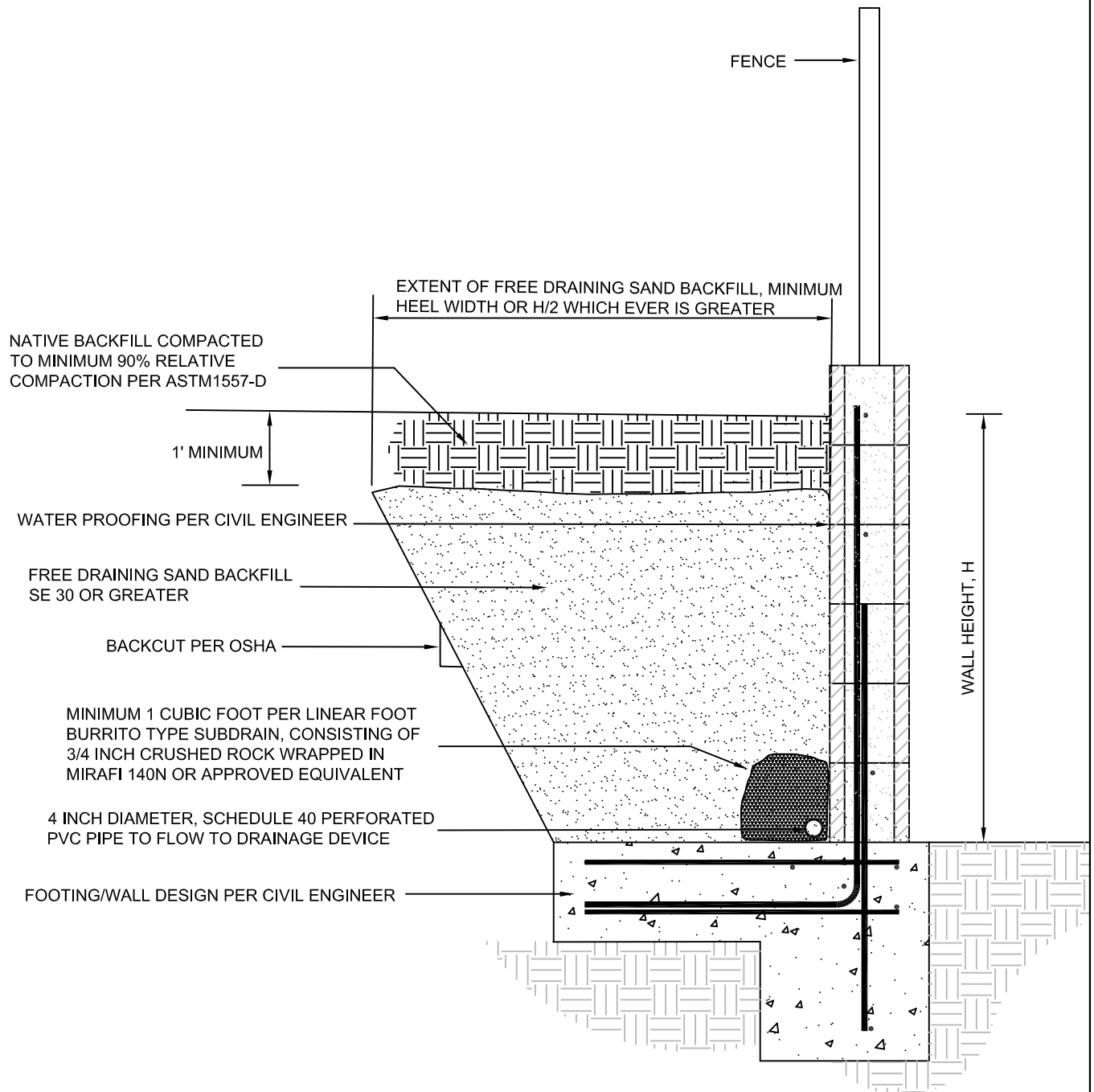

Figure 2



**Figure 3:
Retaining Wall
Detail, Sand
Backfill**

Project Name	Pardee/Skyline
Project No.	153035-01
Eng. / Geol.	BIH/SMB
Scale	n/a
Date	March 2016

ALLOWABLE VERTICAL LOADS

Allowable Bearing Pressures: 1,500 lbs/sq. ft at a Depth of 12 inches Below Creep Zone

Allowable Increase: 250 lbs/sq. ft per foot of increased depth to a Maximum of 2,500 lbs/sq. ft (Neglecting the Top 5 Feet)

Allowable Skin Friction: 600 lbs/sq. ft per foot of Depth (Neglecting the Top 5 Feet)

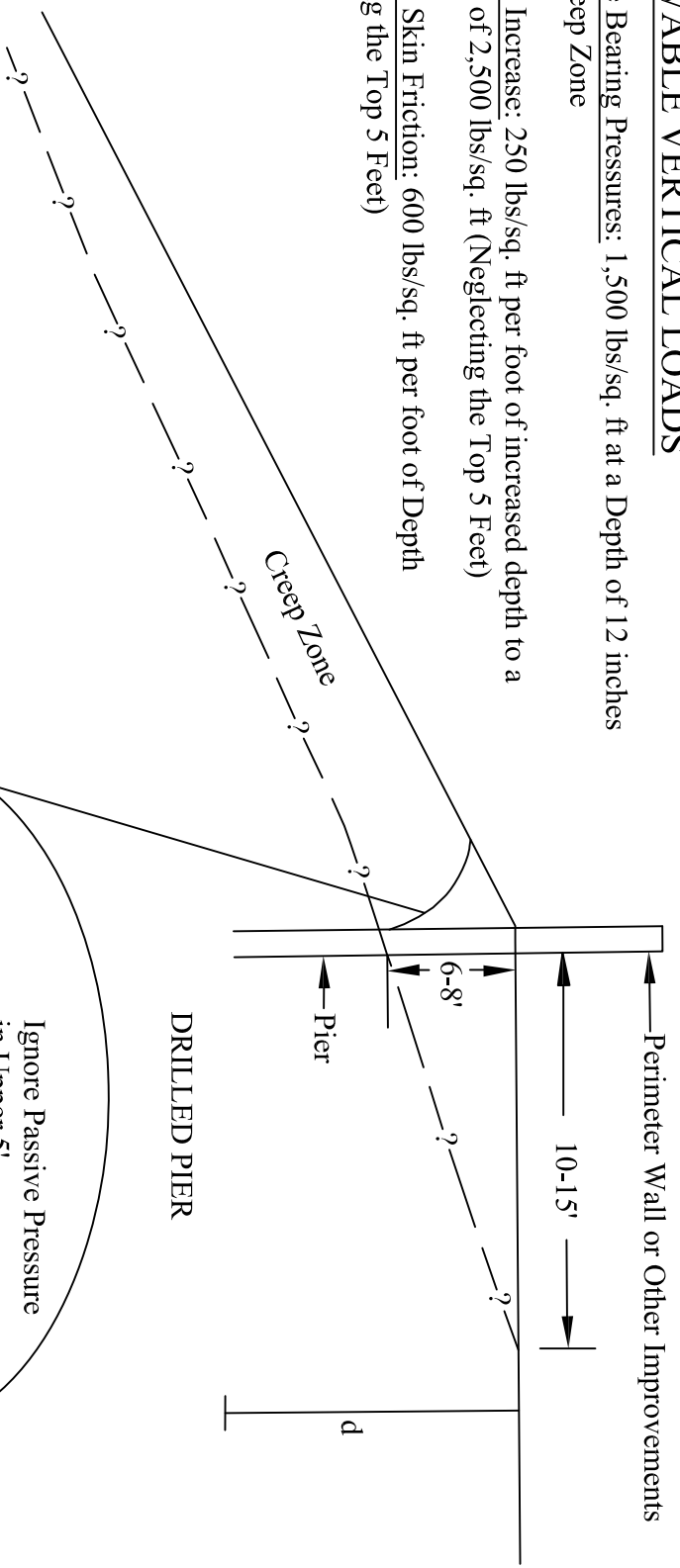

ALLOWABLE LATERAL LOADS

$F_a = (35 \times 5^2 / 2) \times L = 438L$, Where $L = \text{Caisson Spacing}$

$P_p = 120 \text{ psf/ft}$

$F_p = (600 + 120d) / 2 \times (d - 5) \times (3 \times D)$

Where $D = \text{Caisson Diameter}$ and $d = \text{Depth Below Ground}$



**Figure 4:
Geotechnical Parameters For
Top of Slope Walls**

Project Name	Pardee Homes/Skyline
Project No.	153035-01
Eng. / Geol.	BIH/SMB
Scale	N/A
Date	March 2016

APPENDIX A

References

American Society of Civil Engineers (ASCE), 2013, Minimum Design Loads for Buildings and Other Structures, ASCE/SEI 7-10, Third Printing, 2013.

California Geologic Survey, 1998, State of California Seismic Hazard Zone Map, Mint Canyon 7.5 Minute Quadrangle, Los Angeles County, California.

_____, 1998, Seismic Hazard Evaluation Report of the Mint Canyon 7.5-Minute Quadrangle, Los Angeles County, California, SHZR 018.

_____, 2008, Guidelines for evaluating and mitigating seismic hazards in California, Special Publication 117a: California Geological Survey

California Building Standards Commission, 2013, California Building Code, California Code of Regulations Title 24, Volumes 1 and 2, dated July 2013.

County of Los Angeles Department of Public Works, Geotechnical and Materials Engineering Division, Geologic Review and Soils Engineering Review Sheets dated October 29, 2015, Tentative Tract Map 060922-1, Tentative Map Dated October 7, 2015, Santa Clarita.

_____, Geotechnical and Materials Engineering Division, Geologic Review and Soils Engineering Review Sheets dated September 18, 2014, Approval Letter, Tract 60922, Santa Clarita, Skyline Ranch, Miscellaneous Transfer Drain No. 2628, P.D. 2628.

_____, Geotechnical and Materials Engineering Division, Geologic Review and Soils Engineering Review Sheets dated June 16, 2014, Approval Letter, Tract 60922, Santa Clarita, Skyline Ranch, Grading P.C. No 60922-01R1.

Dibblee, T.W., Jr., 1996, Geologic Map of the Mint Canyon Quadrangle, Los Angeles County, California: Dibblee Geological Foundation Map # DF-57, Scale = 1:24,000.

Geolabs-Westlake Village, Inc., July 15, 2014, Response to GMED Review, P.D. 2628, Skyline Ranch, Santa Clarita Area, County of Los Angeles, California (W.O. 8838).

_____, May 20, 2014, Response #4 to GMED Review and Summary of Minor Grading Plan Modification, Phase 1A Grading, Tentative Tract 60922, Skyline Ranch, Santa Clarita Area, County of Los Angeles, California, Grading Plan Check No. 60922-00R1, (W.O. 8838).

_____, January 6, 2014, Response #2 to GMED Review, D.S. 540, Skyline Ranch Road, County of Los Angeles, California (W.O. 8838).

APPENDIX A
References (cont.)

- ___, October 1, 2013, Response #3 to GMED Review, Phase 1A Grading, Tentative Tract 60922, Skyline Ranch, Santa Clarita Area, County of Los Angeles, California, Grading Plan Check No. 60922-00R1, (W.O. 8838).
- ___, August 27, 2013, Grading Plan Review, Phase 3 of Tract 60922, Skyline Ranch, Santa Clarita Area, County of Los Angeles, California, (W.O. 8838).
- ___, April 23, 2013, Response #2 to GMED Review, Phase 1A of Tentative Tract 60922, Skyline Ranch, Santa Clarita Area, County of Los Angeles, California, Grading Plan Check No. 60922-00R1, (W.O. 8838).
- ___, April 1, 2013, Grading Plan Review, Phase 2 of Tract 60922, Skyline Ranch, Santa Clarita Area, County of Los Angeles, California, (W.O. 8838).
- ___, January 25, 2013, Response to GMED Review, D.S. 540, Skyline Ranch Road, County of Los Angeles, California, (W.O. 8838)
- ___, July 27, 2012, Response to GMED Review, Phase 1A of Tract No. 60922, Skyline Ranch, Santa Clarita Area, County of Los Angeles, California, Grading Plan Check No. 60922-00R1, (W.O. 8838).
- ___, March 7, 2012, Geotechnical Review, Storm Drain Plans for P.D. 2627 within D.S. 540, County of Los Angeles, California (W.O. 8838).
- ___, March 5, 2012, Grading Plan Review, D.S. 540, Skyline Ranch Road, County of Los Angeles, California, (W.O. 8838).
- ___, January 20, 2012, Grading Plan Review, Phase 1A of Tract No 60922, Skyline Ranch, Santa Clarita Area, County of Los Angeles, California, (W.O. 8838).
- ___, August 28, 2008, Addendum Geotechnical Report, Tentative Tract Map No. 060922, Skyline Ranch, Santa Clarita Area, County of Los Angeles, California, (W.O. 8838).
- ___, July 25, 2007, Geotechnical Review of Mass Grading Plans (Scale 1" = 40 feet), Tentative Tract Map No. 060922, Skyline Ranch, Santa Clarita Area, County of Los Angeles, California, (W.O. 8838, Volumes I through VI).
- ___, April 13, 2007, Response to Soils Engineering Review Sheet dated February 8, 2007, Tentative Tract Map No. 060922, Skyline Ranch, Santa Clarita Area, County of Los Angeles, California, (W.O. 8838).
- ___, November 16, 2006, Addendum Geotechnical Report, Tentative Tract Map No. 060922, Skyline Ranch, Santa Clarita Area, County of Los Angeles, California, (W.O. 8838).

APPENDIX A
References (cont.)

- Hart, 1994, Fault-Rupture Hazard Zones in California, Alquist-Priolo Special Studies Zones Act of 1974 with Index to Special Studies Zones Maps, CDMG, SP Map No. 1.
- Ishihara, K., 1985, "Stability of Natural Deposits During Earthquakes". Proceedings of the Eleventh International Conference on Soil Mechanics and Foundation Engineering. A.A. Bakema Publishers, Rotterdam, Netherlands.
- Larson, R.A., and C.I. Buckley, November 3, 1990, Geology and Engineering Geology of the Western Soledad Basin, Los Angeles County, California: Southern California Section of the Association of Engineering Geologists, Field Trip Guidebook.
- LGC Valley, Inc., January 22, 2016, 40-Scale Grading Plan Review, Tract 46018-11, Park Site, Skyline Ranch Road, and Multi-Family Site, Plum Canyon, County of Los Angeles, California (W.O. 153034-01).
- Post-Tensioning Institute, 2006, Design of Post Tensioned Slabs-on-ground, Third Addition, Addendum 1 dated May 2007, and Addendum 2 Dated May 2008, with errata February 4, 2010.
- Pradel, D., 1998, "Procedure to Evaluate Earthquake Induced Settlements in Dry Sandy Soils", Journal of Geotechnical and Geoenvironmental Engineering, Vol. 124, No. 4, April 1998.
- Sadigh, K., Chang, C.-Y., Egan, J.A., Makdisi, F., and Youngs, R.R. (1997), "Attenuation Relations for Shallow Crustal Earthquakes Based on California Strong Motion Data," Seismological Research Letters, Vol. 68, No. 1, pp. 180-189.
- Saul, Richard B. and Tom M. Wootton, 1983, Geology of the South Half of the Mint Canyon Quadrangle, Los Angeles County, California: DMG OFR 83-24.
- Seed, H.B., Tokimatsu, K., Harder, L.F., and Chung, R.M., 1985, "Influence of SPT Procedures in Soil Liquefaction Resistance Evaluations," Journal of Geotechnical Engineering, Vol. 111, No. 12, December 1985.
- Tokimatsu, Kohji, and Seed, H.B., "Evaluation of Settlements in Sands Due to Earthquake Shaking," Journal of Geotechnical Engineering, Vol. 113, No. 8, August 1987.
- United States Geological Survey (USGS), 2008a, "2008 National Seismic Hazard Maps – Fault Parameters" Retrieved December 17, 2013, from:
http://geohazards.usgs.gov/cfusion/hazfaults_search/hf_search_main.cfm
- _____, 2008b, "2008 Interactive Deaggregations (Beta)," Retrieved December 12, 2013, from:
<https://geohazards.usgs.gov/deaggint/2008/>
- _____, 2013, U.S. Seismic Design Maps, Retrieved December 12, 2013, from:
<http://geohazards.usgs.gov/designmaps/us/batch.php#csv>

APPENDIX B

LGC Boring Logs

Borings B-LGC-1 through B-LGC-4

DRAFT

Geotechnical Boring Log B-LGC1

Date: January 15 & 19, 2016	GPS: N34.433157° W 118.458521°	Page: 1 of 3
Project Name: Skyline Ranch	Project Number: 1530305-01	
Drilling Company: Tri-Valley Drilling	Type of Rig: Bucket Auger	
Drive Weight: 0-26 3390#, 26-52 2230#, 52-80 1197#	Drop: 12" Hole Dia: 26"	
Elevation of Top of Hole: 1700 feet [msl]	Hole Location: See Map	

Elevation (ft)	Depth (ft)	Graphic Log	Attitudes	Sample Number	Blow Count	Dry Density (pcf)	Moisture (%)	USCS Symbol	DESCRIPTION	
		N S							Logged By: CB/RKW Sampled By: CB	
	0			B1				SW	<p>Saugus Formation (QTs): silty SAND with minor gravel; red brown, damp, medium dense; scattered carbonate stringers; massive; scattered fine cobbles</p> <p>@5.8' sharp contact to silty CLAY; dark red brown, damp, stiff; discontinuous around hole</p> <p>@7.8' silty fine to medium SAND; light yellow brown, damp, dense; slightly friable; irregular upper and lower contacts; red brown claystone ripup clasts in lower 2-inches</p> <p>@9.8' plastic CLAYSEAM; red brown, moist, stiff; fissile; 1/2-inch thick</p> <p>@9.9 silty fine sandy CLAY; red brown, damp, stiff; scattered small carbonate blebs throughout; 3 by 4 inch highly weathered granite cobble along upper contact</p> <p>@12.0' grades to clayey to silty fine to medium SAND; red brown, damp, dense</p> <p>@13.8' grades to silty fine to coarse SAND</p> <p>@15.0' grades to silty fine to medium SAND; mottled light green gray, light yellow brown, and light red brown, damp, dense; scattered coarse sand and fine gravels, subangular</p> <p>@16.3' grades to silty fine to coarse gravelly SAND; scattered highly weathered gravels and fine cobbles</p> <p>@21.5' silty fine to medium SAND with minor gravel; light brown, damp, dense</p> <p>@23.3' iron-oxide stained rinds around gravels and fine cobbles, up to 3- to 4-inches</p> <p>@23.7' silty fine SAND; light red brown and light green gray, damp, dense to very dense</p> <p>@26.0' silty fine SAND; light yellow brown, damp, dense to very dense; scattered coarse sand and fine gravel, subangular to subrounded; occasional pockets of silty fine to coarse grally sand, discontinuous 4- to 5- inches thick</p> <p>@28.1' silty fine to medium SAND with minor coarse sand and fine gravel</p>	
-5	5									CL
-10	10			B: N52W 22° SW CB: N80E 6-8° SE	R1	5				SM
										SW
										SM
				B: N25W 5° SW						SW
-15	15									
-20	20				R2	14				SM
-25	25		B: N25W 7° SW							
-30	30									

LGC	LGC VALLEY, INC. GEOTECHNICAL CONSULTING
-----	---

Geotechnical Boring Log B-LGC1

Date: January 15 & 19, 2016	Page: 2 of 3
Project Name: Skyline Ranch	Project Number: 1530305-01
Drilling Company: Tri-Valley Drilling	Type of Rig: Bucket Auger
Drive Weight: 0-26 3390#, 26-52 2230#, 52-80 1197#	Drop: 12" Hole Dia: 26"
Elevation of Top of Hole: 1700 feet [msl]	Hole Location: See Map

Elevation (ft)	Depth (ft)	Graphic Log	Attitudes	Sample Number	Blow Count	Dry Density (pcf)	Moisture (%)	USCS Symbol	DESCRIPTION	
		N S							Logged By: CB/RKW Sampled By: CB	
-30	30		B: N30-40W 6° SW	R-3	40/11"			GW	<p><u>Saugus Formation (QTs) con't</u>: silty fine to coarse sandy cobble CONGLOMERATE; light yellow brown, damp, very dense; subangular cobbles; few red brown siltstone clasts</p> <p>@30.6' grades to silty fine SAND with gravel</p> <p>@31.9' silty fine to medium SAND; faintly bedded</p>	
								SW		<p>@34.2' silty fine to coarse gravelly SAND; light yellow brown, damp, dense to very dense; massive</p> <p>@35.4' grades to silty fine to medium SAND with gravel</p>
								SM		
			SW	<p>@37.2' grades to silty fine to coarse gravelly SAND; light yellow brown, damp, dense</p>						
-40	40			B: N25E 5° SE	R4	29/11"			GW	<p>@41.1' silty fine SAND bed; 2- to 4-inches thick</p> <p>@41.4' increase in fine cobbles; iron-oxide stained clay rinds on scattered gravel and cobble</p>
									SW	<p>@43.8' grades to silty fine to coarse sandy cobble CONGLOMERATE; cobbles 10- to 12-inches</p>
									SM-SC	<p>@44.9' grades to silty fine to coarse gravelly SAND; pale yellow brown, damp, very dense; scattered cobbles</p>
									SM-SC	<p>@51.3' grades to clayey to silty fine to medium SAND; light brown, moist, very dense; scattered gravel; less clay with depth</p> <p>@53.2' 10-inch by 16-inch boulder</p>
									GW	<p>@58' scattered red brown siltstone clasts; up to 4- to 5-inches</p> <p>@59.5 grades to silty fine to coarse cobble CONGLOMERATE; light brown, damp, very dense</p>
-60	60				R5	21/7"			GW	

	LGC VALLEY, INC. GEOTECHNICAL CONSULTING
--	---

Geotechnical Boring Log B-LGC1

Date: January 15 & 19, 2016	Page: 3 of 3
Project Name: Skyline Ranch	Project Number: 1530305-01
Drilling Company: Tri-Valley Drilling	Type of Rig: Bucket Auger
Drive Weight: 0-26 3390#, 26-52 2230#, 52-80 1197#	Drop: 12" Hole Dia: 26"
Elevation of Top of Hole: 1700 feet [msl]	Hole Location: See Map

Elevation (ft)	Depth (ft)	Graphic Log	Attitudes	Sample Number	Blow Count	Dry Density (pcf)	Moisture (%)	USCS Symbol	DESCRIPTION
		N S							Logged By: CB/RKW Sampled By: CB
-60	60			R6	34/5*			GW	Saugus Formation (QTs) con't: silty fine to coarse cobble CONGLOMERATE; light brown, damp, very dense
-65	65							SW	@65' grades to silty fine to coarse gravelly SAND;
-70	70							GW	@67' grades to silty fine to coarse cobble CONGLOMERATE
-75	75				R7	37/9*			SW
-80	80								TOTAL DEPTH = 78 FEET GEOLOGICALLY LOGGED TO 73.5 FEET NO GROUNDWATER SEEPAGE BACKFILLED WITH NATIVE SOIL ON JANUARY 19, 2016
-85	85								
-90	90								

	LGC VALLEY, INC. GEOTECHNICAL CONSULTING
--	---

Geotechnical Boring Log B-LGC2

Date: January 19-21, 2016	GPS: N34.434097° W 118.458844°	Page: 1 of 3
Project Name: Skyline Ranch	Project Number: 1530305-01	
Drilling Company: Tri-Valley Drilling	Type of Rig: Bucket Auger	
Drive Weight: 0-26 3390#, 26-52 2230#, 52-80 1197#	Drop: 12" Hole Dia: 26"	
Elevation of Top of Hole: 1698 feet [msl]	Hole Location: See Map	

Elevation (ft)	Depth (ft)	Graphic Log	Attitudes	Sample Number	Blow Count	Dry Density (pcf)	Moisture (%)	USCS Symbol	DESCRIPTION	
		N S							Logged By: CB/RKW Sampled By: CB	
0	0							SC	<u>Topsoil</u> : clayey fine to medium SAND; red brown, damp, medium dense, scattered rootlets; carbonate stringers; few subangular gravels	
								SW	<u>Saugus Formation (QTs)</u> : @2.2' silty fine to coarse SAND with few gravels; red brown, moist, dense; slightly friable; gradational upper contact	
								SM-SC	@3.8' grades to silty to clayey fine to medium SAND; red brown, damp, dense; blocky; scattered carbonate stringers	
								SW	@6.0' irregular gradational contact to silty fine to coarse SAND with gravel; light green gray mottled orange brown, damp, dense; scattered highly weathered granite cobbles	
				B: N65W 7° SW				CH	@6.4' silty CLAY; red brown, moist, stiff; slightly plastic; 1/2 to 1-1/2 inches thick	
								SC	@6.5' clayey fine to medium SAND with fine gravel; red brown, damp, dense to very dense; few small carbonate blebs, massive	
				CS: N75-80W 8° SW				CL	@7.5' fine sandy CLAY; red brown, damp, stiff; blocky; few small pockets of fine to medium sand; increasing sand with depth	
								CL-CH	@9.2' CLAYSEAM; red brown mottled gray brown, moist, stiff; 1/16-inch thick; plastic; slightly undulating	
					R1	14		SC	@9.3' clayey fine to medium SAND; red brown mottled orange brown and light green gray, damp, dense to very dense; scattered coarse sand and fine gravel; discontinuous layers of light green gray silty fine to medium sand; slightly friable	
				B: N70W 13° SW				SW	@11.5' grades to silty fine to coarse SAND with rare gravels	
									@12.3' relatively sharp erosional contact to silty fine to coarse gravelly SAND; light green gray, damp, dense; iron-oxide staining in upper 2-inches	
				C: N60W 18-23° SW					@13.0' few small cobbles, subrounded to subangular	
									@14.2' interbedded silty fine to medium SAND beds, 2- to 3-inches thick	
									@15.1' 4- to 10-inch thick silty fine to medium SAND bed; relatively sharp irregular upper contact and gradational lower contact	
									@16.6' grades to silty fine to coarse gravelly SAND; abundant iron-oxide staining throughout	
					R2	14			SM-SC	@18.5' sharp undulating contact to silty to clayey fine SAND; red brown and light green gray, damp, dense to very dense
								ML	@19.2' grades to fine sandy SILT; red brown, moist, hard; scattered coarse sand grains; 2- to 3-inches thick	
								SM-SC	@19.4' silty to clayey fine SAND	
								SM	@20.1' sharp contact to silty fine SAND; light gray brown mottled orange and red brown, damp, dense to very dense	
								SW	@21.0' becomes light yellow brown	
								@23.0' very undulation contact to silty fine to coarse SAND with minor gravel and fine cobbles; mottled orange and red brown, damp, dense; few siltstone clasts		
								@24.5' increase in gravels and cobbles, subrounded to subangular		
								@26.4' silty fine to coarse sandy gravel and cobble CONGLOMERATE; matrix supported, cobbles up to 4-inches		
							GW	@28.0' silty fine to coarse SAND with gravels		
								@28.9' silty fine to medium SAND bed; light orange brown, damp, dense to very dense		
							SW	@29.6' sharp contact to silty fine to coarse gravelly SAND		

	LGC VALLEY, INC. GEOTECHNICAL CONSULTING
--	---

Geotechnical Boring Log B-LGC2

Date: January 19-21, 2016	Page: 2 of 3
Project Name: Skyline Ranch	Project Number: 1530305-01
Drilling Company: Tri-Valley Drilling	Type of Rig: Bucket Auger
Drive Weight: 0-26 3390#, 26-52 2230#, 52-80 1197#	Drop: 12" Hole Dia: 26"
Elevation of Top of Hole: 1698 feet [msl]	Hole Location: See Map

Elevation (ft)	Depth (ft)	Graphic Log	Attitudes	Sample Number	Blow Count	Dry Density (pcf)	Moisture (%)	USCS Symbol	DESCRIPTION	
		N S							Logged By: CB/RKW Sampled By: CB	
-30	30			R-3	31/9"			SW	<p>Saugus Formation (QTz) con't: silty fine to coarse gravelly SAND; light orange brown, damp, dense to very dense</p> <p>@30.3' silty fine to medium SAND</p> <p>@31.4' silty fine to coarse sandy gravel CONGLOMERATE; light yellow brown mottled orange brown, damp, very dense; matrix supported; scattered red brown siltstone clasts</p> <p>@32.6' silty fine to coarse gravelly SAND</p> <p>@34.2' to 35.3' scattered subangular gravels and fine cobbles</p> <p>@36.6' 6- to 8-inch white gneiss cobble</p> <p>@38.5' grades to silty fine to coarse sandy gravel CONGLOMERATE; few cobbles and red brown siltstone clasts</p> <p>@41.9' grades to silty fine to coarse sandy cobble CONGLOMERATE; light yellow brown, damp, dense to very dense; cobbles up to 8-inches, subangular</p> <p>@43.8' grades to silty fine to coarse gravelly SAND</p> <p>@45.2' silty fine to coarse sandy cobble CONGLOMERATE</p> <p>@46.5' silty fine to coarse sandy gravel CONGLOMERATE with rare cobbles</p> <p>@50.7' silty fine to coarse sandy cobble CONGLOMERATE</p> <p>@54.7' silty fine to medium SAND minor coarse sand and fine gravels; light yellow to orange brown mottled orange brown, moist, dense; faintly bedded; slightly friable</p> <p>@55.3' gradational contact to silt fine to coarse gravelly SAND; scattered red brown siltstone clasts</p> <p>@56.2' silty fine to coarse sandy cobble and small boulder CONGLOMERATE; rock supported; white gneiss boulders up to 14- to 15-inches</p> <p>@59.3' silty fine to coarse sandy gravel CONGLOMERATE; light yellow brown to light brown, slightly moist, dense to very dense; gravel supported; scattered red brown siltstone clasts</p>	
										GW
										SW
-35	35									
										GW
-40	40				R4	26/6"				
										SW
										GW
-45	45									
										SW
								GW		
-50	50			R5	25/7"					
								SW		
								GW		
-55	55									
			B: N53W 7° SW							
-60	60									

LGC

LGC VALLEY, INC.
GEOTECHNICAL CONSULTING

Geotechnical Boring Log B-LGC2

Date: January 19-21, 2016	Page: 3 of 3
Project Name: Skyline Ranch	Project Number: 1530305-01
Drilling Company: Tri-Valley Drilling	Type of Rig: Bucket Auger
Drive Weight: 0-26 3390#, 26-52 2230#, 52-80 1197#	Drop: 12" Hole Dia: 26"
Elevation of Top of Hole: 1698 feet [msl]	Hole Location: See Map

Elevation (ft)	Depth (ft)	Graphic Log	Attitudes	Sample Number	Blow Count	Dry Density (pcf)	Moisture (%)	USCS Symbol	DESCRIPTION
-60	60		C: N73E 13° SE	R6	37/8"			GW	<p style="text-align: center;">Logged By: CB/RKW Sampled By: CB</p> <p><u>Saugus Formation (QTs) con't:</u> silty fine to coarse sandy gravel CONGLOMERATE; light yellow brown to light brown, slightly moist, dense to very dense @61.6' sharp contact to silty fine to medium SAND; light orange brown, moist, dense @62.5' contains scattered fine cobbles @63.0' white carbonate along bedding; 1/4-inch thick @64.1' silty CLAY; olive brown mottled orange brown, moist, hard; massive; few subrounded gravels @65.6' lower 1- to 2-inches of the clay contains abundant parting surfaces parallel to bedding @65.7' silty fine to coarse sandy gravel CONGLOMERATE; light brown mottled orange brown, moist to very moist, dense; matrix supported; scattered red brown siltstone clasts</p> <p>@69.3' silty fine to coarse sandy cobble CONGLOMERATE; cobble supported</p> <p>@71.8' silty fine to coarse sandy gravel CONGLOMERATE; matrix supported</p> <p>@74' silty fine to coarse sandy cobble CONGLOMERATE; cobble supported</p>
-65	65		B: N20W 8° SW					SM	
-70	70		B: N30W 6° SW					CL	
-75	75		GW						
-80	80								TOTAL DEPTH = 79 FEET GEOLOGICALLY LOGGED TO 76 FEET NO GROUNDWATER SEEPAGE BACKFILLED WITH NATIVE SOIL ON JANUARY 21, 2016
-85	85								
-90	90								

LGC	LGC VALLEY, INC. GEOTECHNICAL CONSULTING
-----	---

Geotechnical Boring Log B-LGC3

Date: January 21 & 22, 2016	GPS: N34.434820° W 118.458880°	Page: 1 of 3
Project Name: Skyline Ranch	Project Number: 1530305-01	
Drilling Company: Tri-Valley Drilling	Type of Rig: Bucket Auger	
Drive Weight: 0-26 3390#, 26-52 2230#, 52-80 1197#	Drop: 12" Hole Dia: 26"	
Elevation of Top of Hole: 1710 feet [msl]	Hole Location: See Map	

Elevation (ft)	Depth (ft)	Graphic Log	Attitudes	Sample Number	Blow Count	Dry Density (pcf)	Moisture (%)	USCS Symbol	DESCRIPTION	
		N S							Logged By: RKW Sampled By: RKW	
0	0		C: N25W 18° NE J: N47E 88° NW J: N15E 68° SE					SC	<p><u>Topsoil</u>: clayey fine to coarse SAND; red brown, damp, medium dense; scattered roots; blocky; few subrounded gravels</p> <p><u>Saugus Formation (QTs)</u>: @2.1' silty fine to medium SAND; light red brown, damp, dense; blocky, carbonate along surfaces; few roots; gradational upper contact</p> <p>@2.8' grades to silty fine to coarse SAND; light red brown, damp, dense; rare subangular gravels; scattered carbonate stringers</p> <p>@3.4' silty CLAY; red brown, damp, stiff to hard; very irregular upper contact; blocky; carbonate blebs and stringers</p> <p>@4.2' grades to clayey to silty fine SAND; red brown, damp, dense; very blocky; somewhat jointed</p> <p>@5.3' grades to silty fine to medium SAND; less blocky than above</p> <p>@6.5' silty fine to coarse SAND; light green gray mottled orange and red brown, damp, dense; very gradational upper contact; increasing sand grain size with depth</p> <p>@9.0' silty fine to coarse sandy gravel CONGLOMERATE; mottled light green gray orange brown and light red brown, damp, very dense; subrounded to subangular gravel; few fine subangular fine cobbles</p> <p>@10.2' gravelly CLAY; red brown, moist, stiff; subrounded to subangular gravel</p> <p>@10.5' plastic CLAY; red brown, very moist, "soft"; 1.5- to 2-inches thick; scattered carbonate blebs sharp upper and lower contacts, upper contact somewhat irregular</p> <p>@10.7' silty fine to medium SAND; red brown, slightly moist, dense to very dense; scattered coarse sand and fine gravels</p> <p>@11.2' silty fine to coarse SAND; minor fine gravels</p> <p>@11.8' silty to clayey SAND to sandy CLAY; red brown, moist, dense/stiff</p> <p>@12.4' about 1-inch thick "soft" plastic CLAY; somewhat platy</p> <p>@12.8' silty fine to medium SAND; red brown, moist, dense to very dense; scattered coarse sand grains, fine carbonate blebs, and subrounded gravels; occasional zones of fine to coarse sand</p> <p>@13.9' gravel CONGLOMERATE; 2- to 4-inches thick</p> <p>@14.2' silty fine to medium SAND</p> <p>@14.8' silty fine to coarse SAND</p> <p>@15.9' silty fine to medium SAND</p> <p>@16.2' grades to silty to clayey fine SAND; to clayey sandy SILT; red brown, moist, dense/stiff</p> <p>@17.2' silty fine to coarse gravelly SAND; light green gray, moist, dense to very dense; scattered pockets of sandy gravel conglomerate and silty fine to medium sand</p> <p>@18.8' grades to silty fine to coarse SAND with minor gravel and cobbles; light green gray, moist, dense to very dense; well graded; subangular to subrounded gravel and cobbles; few red brown siltstone clasts</p> <p>@20.7' interbedded light green gray silty fine to medium SAND and silty fine to coarse gravelly SAND; damp, dense; 2- to 4- inches thick beds; scattered zones of iron-oxide staining; rare cobbles</p> <p>@24.1' slightly irregular erosional contact to silty fine SAND; light green brown to light yellow brown, damp, dense; upper contact is iron-oxide stained</p> <p>@25.3' grades to silty fine SAND; red brown, damp, dense, poorly graded</p>	
-5	5		CB: N43W 6° SW	R1	9					SM SW CL SC-SM SM SW GW CL/CH SM SW SC-CL CH SM GW SM/SW
-10	10		B: N12W 3-4° SW B: N28E 6° SE	R2	14					SM/ML SW SM/SW
-15	15		B: N15W 8° SW							SW
-20	20									
-25	25									
-30	30									

LGC	LGC VALLEY, INC. GEOTECHNICAL CONSULTING
-----	---

Geotechnical Boring Log B-LGC3

Date: January 21 & 22, 2016	Page: 2 of 3
Project Name: Skyline Ranch	Project Number: 1530305-01
Drilling Company: Tri-Valley Drilling	Type of Rig: Bucket Auger
Drive Weight: 0-26 3390#, 26-52 2230#, 52-80 1197#	Drop: 12" Hole Dia: 26"
Elevation of Top of Hole: 1710 feet [msl]	Hole Location: See Map

Elevation (ft)	Depth (ft)	Graphic Log	Attitudes	Sample Number	Blow Count	Dry Density (pcf)	Moisture (%)	USCS Symbol	DESCRIPTION
-30	30		B: N48W 8° SW	R-3	19/9"			SW GW SW	<p>Saugus Formation (QTz) con't: @26.0' silty fine to coarse gravelly SAND; light yellow brown, damp, dense; minor interbeds of silty fine to medium sand and cobbly gravel beds; 1- to 5-inches thick</p> <p>@30.5' 6-inch thick cobble rich bed</p> <p>@31.0' silty fine to coarse SAND; scattered gravels and fine cobbles, subrounded to subangular</p> <p>@34.6' fine to coarse sandy fine cobble gravel CONGLOMERATE; light brown, damp, dense to very dense; matrix supported; scattered siltstone clasts up to 4-inches</p> <p>@35.4' silty fine to coarse SAND; scattered gravels and fine cobbles</p> <p>@35.8' becomes a cobble CONGLOMERATE, cobble supported, cobbles up to 10- to 12-inches</p> <p>@39.0' grades to a gravel CONGLOMERATE with fine cobbles; matrix supported; scattered siltstone clasts up to 4-inches</p> <p>@40.6' relatively sharp irregular contact to silty fine to medium SAND with minor coarse sand and fine gravels; light brown to light yellow brown, damp, dense to very dense; subrounded to subangular gravel</p> <p>@41.9' grades to fine to coarse sandy cobble gravel CONGLOMERATE</p> <p>@46.5' to 48.5' sandy cobble CONGLOMERATE with gravels; slightly cemented below 47.5'</p> <p>@50.2 grades to silty fine to coarse SAND with minor gravels and fine cobbles</p> <p>@52.0' silty fine to coarse sandy gravel CONGLOMERATE with cobbles</p> <p>@55.8 grades to silty fine to coarse SAND; light yellow brown mottled light orange brown, moist, very dense; scattered zones of siltstone clasts, 1/2-inch or less in size above 57.5'</p> <p>@58.2' silty fine to coarse sandy gravel CONGLOMERATE with cobbles</p> <p>@59.6 grades to silty fine to coarse SAND with gravel</p>
-35	35			GW SW GW					
-40	40			R4	37/10"	SW GW			
-45	45			R5	35/6"	SW GW SW GW SW			
-50	50								
-55	55								
-60	60								

LGC	LGC VALLEY, INC. GEOTECHNICAL CONSULTING
-----	---

Geotechnical Boring Log B-LGC3

Date: January 21 & 22, 2016	Page: 3 of 3
Project Name: Skyline Ranch	Project Number: 1530305-01
Drilling Company: Tri-Valley Drilling	Type of Rig: Bucket Auger
Drive Weight: 0-26 3390#, 26-52 2230#, 52-80 1197#	Drop: 12" Hole Dia: 26"
Elevation of Top of Hole: 1710 feet [msl]	Hole Location: See Map

Elevation (ft)	Depth (ft)	Graphic Log	Attitudes	Sample Number	Blow Count	Dry Density (pcf)	Moisture (%)	USCS Symbol	DESCRIPTION	
-60	60			R6					<p style="text-align: center;">Logged By: RKW Sampled By: RKW</p> <p><u>Saugus Formation (QTz) con't:</u> grades to silty fine to coarse SAND with gravel; light yellow brown mottled light orange brown, moist, very dense</p> <p>@60.8' silty fine to coarse sandy gravel and cobble CONGLOMERATE</p> <p>@62.0' grades to silty fine to coarse SAND with gravel</p> <p>@63.7' silty fine to coarse sandy gravel CONGLOMERATE with cobbles</p> <p>@64.4' sandy cobble CONGLOMERATE; cobble supported, cobbles up to 6- to 8-inches</p> <p>@68.5' becomes matrix supported with fewer cobbles</p> <p>@70.3' grades to silty fine to coarse SAND with gravel; light yellow brown, moist, very dense; scattered siltstone clasts</p> <p>@74' sandy cobble CONGLOMERATE; cobble supported</p>	
				R6	29/6"					
-75	75									
-80	80								TOTAL DEPTH = 78.5 FEET GEOLOGICALLY LOGGED TO 75 FEET NO GROUNDWATER SEEPAGE BACKFILLED WITH NATIVE SOIL ON JANUARY 22, 2016	
-85	85									
-90	90									

LGC	LGC VALLEY, INC. GEOTECHNICAL CONSULTING
-----	---

Geotechnical Boring Log B-LGC4

Date: January 22 & 25, 2016	GPS: N34.435381° W 118.459591°	Page: 1 of 3
Project Name: Skyline Ranch	Project Number: 1530305-01	
Drilling Company: Tri-Valley Drilling	Type of Rig: Bucket Auger	
Drive Weight: 0-26 3390#, 26-52 2230#, 52-80 1197#	Drop: 12" Hole Dia: 26"	
Elevation of Top of Hole: 1725 feet [msl]	Hole Location: See Map	

Elevation (ft)	Depth (ft)	Graphic Log	Altitudes	Sample Number	Blow Count	Dry Density (pcf)	Moisture (%)	USCS Symbol	DESCRIPTION
		N S							Logged By: RKW Sampled By: RKW
0	0							SM	<u>Topsoil</u> : silty clayey fine to medium SAND with minor gravel; dark red brown, moist, medium dense; scattered rootlets
								SW	<u>Saugus Formation (QTs)</u> : @2' silty fine to coarse SAND with minor fine gravel; light orange brown to light red brown, damp, dense; few carbonate stringers; subangular gravels
								SM	@3.4' grades to silty fine to medium SAND; red brown, damp, dense; scattered pockets of slightly friable silty fine SAND; somewhat blocky texture
			J: N67W 88° SW	B1				SM-ML	@4.2' grades to silty to clayey fine SAND to fine sandy SILT; dark red brown, damp, dense/very stiff; blocky; abundant carbonate along blocks; indistinctly jointed
			CB: N38W 8° SW					ML-CL	@4.6' grades to fine sandy CLAY/SILT' red brown, moist, stiff
			CB: N65W 5° SW	R1	9			SM-SW	@6.4' 2-3 inch thick "soft" CLAY bed; smooth upper and lower contacts, 1/2-1 inch thick zone with abundant carbonate and slightly cemented above clay bed; 3/8-inch carbonate blebs within the clay bed
			B: N75W 7° SW					ML-CL	@6.6' silty fine to medium SAND; light red brown, damp, very dense; sharp contact
								SW	@6.8' grades to silty fine to coarse SAND; light red brown, damp, very dense; few fine gravels; scattered carbonate blebs
								GW	@7.7' 4-inch thick fine sandy SILT/CLAY bed; red brown, damp, hard; massive
									@8.0' silty fine to coarse SAND; light red brown, damp, very dense; few fine gravels; scattered carbonate blebs
									@9.0' irregular erosional contact to silty fine to coarse gravelly SAND; light brown and light green gray, damp, very dense; upper contact iron-oxide stained; scattered iron oxide staining throughout
			C: N75E 4-5° SE					SM	@10.1' grades to silty fine to coarse sandy gravel CONGLOMERATE; matrix supported; few siltstone clasts and fine cobbles up to 4-inches
								GW	@13' grades to fine to coarse sandy gravel and cobble CONGLOMERATE; rock supported; scattered gravels with iron-oxide stained clay rinds
								SW	@14.2' irregular erosional contact to silty fine SAND; light green gray mottled red brown, moist, very dense; massive
								GW	@14.5' becomes red brown
			B: N67W 16° SW	R2	18/9"			GW	@15.8' silty fine to coarse sandy gravel CONGLOMERATE; few subangular fine cobbles
								SW	@16.2' silty fine SAND with interbedded silty fine to coarse beds
									@17.0' to 17.3' silty fine to coarse sandy gravel CONGLOMERATE bed
								SW	@18.1' to 18.3' silty fine to coarse SAND with minor gravels; light yellow brown
								GW	@18.9' to 19.1' gravelly fine to coarse SAND
									@19.4' silty fine to coarse sandy gravel and cobble CONGLOMERATE; light green gray mottled red brown and orange brown, damp, very dense; iron-oxide stained subrounded gravels; mainly matrix supported
								SW	@20.6' to 21.6' cobble supported
								GW	@21.6' silty fine SAND; light green gray mottled red brown, moist, very dense; massive
								SW	@21.8' becomes red brown

LGC	LGC VALLEY, INC. GEOTECHNICAL CONSULTING
-----	---

Geotechnical Boring Log B-LGC4

Date: January 22 & 25, 2016	Page: 2 of 3
Project Name: Skyline Ranch	Project Number: 1530305-01
Drilling Company: Tri-Valley Drilling	Type of Rig: Bucket Auger
Drive Weight: 0-26 3390#, 26-52 2230#, 52-80 1197#	Drop: 12" Hole Dia: 26"
Elevation of Top of Hole: 1725 feet [msl]	Hole Location: See Map

Elevation (ft)	Depth (ft)	Graphic Log	Attitudes	Sample Number	Blow Count	Dry Density (pcf)	Moisture (%)	USCS Symbol	DESCRIPTION		
-30	30		B: N15W 12° SW	R-3	32			SW	<p><u>Saugus Formation (QTs) con't:</u> @22.5' grades to silty fine to coarse gravelly SAND; light green gray and light orange brown, moist, very dense; subangular gravels</p> <p>@23.6' grades to silty fine to coarse sandy gravel CONGLOMERATE; red brown, moist, very dense</p> <p>@24.1' becomes mottled light green gray and light orange brown</p> <p>@25.4' 6-inch thick cobble CONGLOMERATE</p> <p>@25.9' silty fine to coarse SAND</p> <p>@26.7' cobble CONGLOMERATE with discontinuous zones of silty fine to medium SAND; matrix supported</p> <p>@28.4' slightly irregular contact to silty fine to medium SAND; light green gray mottled light red brown, moist, very dense</p> <p>@29.1' silty fine SAND bed; light green gray and red brown</p> <p>@29.6' 4-inch thick cobble bed</p> <p>@30' silty fine to medium SAND with minor gravels; silty fine to medium SAND; light green gray mottled light red brown, moist, very dense; scattered siltstone clasts; minor iron-oxide staining</p> <p>@30.8' grades to silty fine to medium SAND with minor coarse sand and fine gravels; light green gray, moist, very dense</p> <p>@33.0' silty fine to medium sandy cobble CONGLOMERATE; cobble supported; white gneiss and granite cobbles with red brown siltstone clasts</p> <p>@35.4' irregular sharp contact to silty fine to medium SAND with minor gravels; light green gray mottled light orange brown, moist, very dense</p> <p>@35.6' silty fine to coarse gravelly SAND; light orange brown, moist, very dense</p> <p>@35.9' grades to a silty fine to coarse SAND bed</p> <p>@36.8' interbedded silty fine to medium SAND and silty fine to coarse SAND; 2- to 6-inch thick beds; occasional faintly bedded fine to medium sand beds</p> <p>@37.8' rare highly weathered cobbles and few orange brown siltstone clasts, 2-5 inches in size</p> <p>@39.2' cobble CONGLOMERATE; light yellow brown and light green gray, moist, very dense; cobble supported</p> <p>@41.0' silty fine to coarse SAND with minor gravels and cobbles; light yellow brown, moist, very dense; massive; cobbles moderately to highly weathered</p> <p>@43.9' grades to a silty fine to coarse sandy gravel CONGLOMERATE; light green gray mottled light orange brown, moist, very dense; few subrounded cobbles</p> <p>@45.2' cobble CONGLOMERATE with gravels; cobble supported</p> <p>@46.8' silty fine to coarse gravelly SAND; light brown, moist, very dense</p> <p>@48.8' gravelly cobble CONGLOMERATE; well-graded; cobble supported, cobbles up to 14-16 inches</p> <p>@53.2' becomes matrix supported; light brown mottled orange brown</p> <p>@55.8' becomes cobble supported</p> <p><u>Mint Canyon Formation (Tmc):</u> @57.8' silty fine to coarse sandy gravel CONGLOMERATE with cobbles; light green gray to light green brown, moist, very dense;</p>		
											GW
											SW
											GW
											SW
											GW
											SW
											GW
											SW
											GW

LGC	LGC VALLEY, INC. GEOTECHNICAL CONSULTING
-----	---

Geotechnical Boring Log B-LGC4

Date: January 22 & 25, 2016	Page: 3 of 3
Project Name: Skyline Ranch	Project Number: 1530305-01
Drilling Company: Tri-Valley Drilling	Type of Rig: Bucket Auger
Drive Weight: 0-26 3390#, 26-52 2230#, 52-80 1197#	Drop: 12" Hole Dia: 26"
Elevation of Top of Hole: 1725 feet [msl]	Hole Location: See Map

Elevation (ft)	Depth (ft)	Graphic Log	Attitudes	Sample Number	Blow Count	Dry Density (pcf)	Moisture (%)	USCS Symbol	DESCRIPTION
-60	60		B: N25W 8° SW	R4	31/5*			GW	Mint Canyon Formation (Tms) con't: silty fine to coarse sandy gravel CONGLOMERATE with cobbles; light green gray to light green brown, moist, very dense; @62.7' increasing amount of cobbles @67' becomes a cobble and gravel CONGLOMERATE @69.2' grades to a silty fine to coarse SANDSTONE; light green gray to light green brown, slightly moist, very dense; moderately cemented, few olivine sand grains @70.2' grades into silty fine to coarse sandy gravel CONGLOMERATE; few gravel sized siltstone clasts; scattered cobbles @73.1' sharp irregular contact to silty fine to medium SANDSTONE; light green brown, moist, very dense; slightly micaceous @73.8' grades into silty fine to coarse sandy gravel CONGLOMERATE @74.5' becomes a well-graded gravel and cobble CONGLOMERATE
-65	65							SW	
-70	70							GW	
-75	75							SW GW	
-80	80							TOTAL DEPTH = 79.5 FEET GEOLOGICALLY LOGGED TO 76 FEET NO GROUNDWATER SEEPAGE BACKFILLED WITH NATIVE SOIL ON JANUARY 25, 2016	
-85	85								
-90	90								

LGC	LGC VALLEY, INC. GEOTECHNICAL CONSULTING
-----	---

APPENDIX B

Excavation Logs By Others

Borings and Test Pits by Geolabs-Westlake Village, Inc.

Borings:

B1 through B92

B1-B12 (1995)

Test Pits:

TP-1 through TP-219

T1 through T23

Boring by Pacific Soils Engineering, Inc.

Boring:

B-115

SURFACE DATA

LOG OF BORING B1

CLIENT: Pardee Homes					PROJECT: Monosabian		W.O.: 8838
LOCATION: Santa Clarita					ELEVATION: 1910'		DATE: 7/18/02
RIG TYPE: 24" Bucket					HAMMER WEIGHTS: Kelly Bar Weights		DROP: 12"
N	U	B	M	DD	DESCRIPTION		ATTITUDES
0					<p>Saugus Formation: Very pale orange fine to coarse grained silty SAND with abundant gravel and cobbles to fine to coarse grained gravelly SANDSTONE with silt and abundant cobbles, slightly moist, dense to very dense, clasts consisting of granitics, gniesses, siltstone and mudstones, minor volcanics, slightly cemented matrix.</p>		
5							@6' B N81W/5SW
10	7	X	6.6	130.8	<p>Same as above, slightly cemented, slightly moist, dense.</p> <p>5% to 10% clay content in matrix.</p>		@10' B N87W/3SW
15					<p>Matrix clay content decreased to below 5%.</p>		@13' B N74E/3SE
20	10	X	8.0	123.1	<p>Matrix clay content increased to 5 to 10%, moist.</p>		@16' B Horizontal @17' B N88E/7SE @19' B N89W/5SW
25					<p>Clay content decreased to less than 5% silt content 10 to 15%, change to light yellowish gray in color.</p>		
30	11	X	6.2	128.1	<p>Pale yellow orange and yellowish gray gravelly SAND with abundant cobbles and boulders, slightly cemented.</p> <p>@32' - Gravel and cobble content increase, 12" diameter boulder, light olive gray matrix.</p> <p>@32-38', Boring belled out 6" to 9" from sidewall.</p>		@31' B Horizontal
35					<p>Yellowish gray to white fine to coarse grained silty SANDSTONE, minor gravel, slightly cemented, slightly moist, dense.</p>		@38' B N86W/4SW
40					<p>Light yellowish gray and gray clast supported CONGLOMERATE (gravel and cobbles with boulders with fine to coarse grained silty sandstone matrix), slightly cemented, very dense, slightly moist, coring, very slow progress.</p> <p>Refusal at 46' in cobble CONGLOMERATE.</p>		
45					<p>No groundwater, Total Depth - 46'</p>		
ADDITIONAL COMMENTS:					<p>California Split Spoon Sampler Kelly Bar Weights 0 - 25' - 3600 lbs. 25 - 47' 2600 lbs. 47 - 68', 1600 lbs.</p>		

SURFACE DATA

LOG OF BORING B2

CLIENT: Pardee Homes					PROJECT: Monosabian		W.O.: 8838	
LOCATION: Santa Clarita					ELEVATION: 2005'		DATE: 7/19/02	
RIG TYPE: 24" Bucket					HAMMER WEIGHTS: Kelly Bar Weights		DROP: 12"	
	N	U	B	M	DD	DESCRIPTION	ATTITUDES	
0						<p><u>Colluvium</u>: Dark yellowish brown silty CLAY with abundant fine grained SAND and minor gravel, dry and loose in upper 0.5', moist and stiff below 0.5'.</p> <p>@2.5' - Moderate brown, same as above, silt increase.</p> <p>@4' - <u>Saugus Formation</u>: Light brown fine grained silty SAND with clay and minor gravel, with lenses and layers of fine to coarse grained silty SAND and minor thin laminations of silt and clay.</p> <p>@4-8', Light brown silty fine grained SANDSTONE, damp and dense, overlying gravelly CONGLOMERATE, scoured contact.</p>		
5								
10	10/6" X			8.9	---	<p>Gravels and cobbles within matrix of fine to coarse grained silty SAND, slightly moist, dense.</p> <p>@10' - Becoming orangish brown pebbly to gravelly CONGLOMERATE, sandy clay matrix, very poorly sorted, damp and dense.</p> <p>@13-16', Cobble zone.</p>	@8' B N24W/28SW Approx. scoured contact	
15			X X X X			<p>Red to brown clayey SAND, discontinuous bed.</p> <p>Color change to grayish orange and very light yellowish brown.</p>	@16' B N10W/24SW	
20	9 X			9.4	129.7	<p>Gravelly sandy CONGLOMERATE, sparse cobbles, poorly sorted, damp and dense, slightly cemented, coring.</p> <p>@22' - Tan medium to coarse grained SANDSTONE, scoured top contact. Grayish orange gravelly clayey SAND with silt and cobbles, slightly moist, medium dense.</p>	@22' B N85W/13SW Approx.	
25						<p>Light orangish brown gravelly SANDSTONE to sandy CONGLOMERATE, poorly sorted, granitic and metamorphic clasts up to 8" diameter, dry and dense.</p>	@28' Nearly horizontal gravel stringer	
30	17 X			7.0	127.5	<p>Moist and dense.</p> <p>Grayish orange and very light yellow brown CONGLOMERATE (fine to coarse grained sandy gravel and cobbles with silt), slightly moist, very dense.</p> <p>@34' - Boulder 12" by 12" by 16".</p> <p>@36' - Light buff/gray fine to medium grained SANDSTONE, scoured upper and lower contacts bounded by conglomerate.</p> <p>@37' - Cobbly CONGLOMERATE, weathered orangish brown sandy silty clay matrix, massive, clay films (orange/rust stains around clasts).</p> <p>@39' - <u>Mint Canyon Formation</u>: Becomes white to light gray, less weathered, cleaner with less silt and no clay, contact with overlying Saugus gradational in conglomerate.</p>	@36' B N75W/26SW Approx. @37' B N51W/10SW @41' B N14W/12SW	
35								
40								
45								

ADDITIONAL COMMENTS:

California Split Spoon Sampler

Kelly Bar Weights: 0 - 25', 3600 lbs.
25 - 47', 2600 lbs.
47'+, 1600 lbs.

SURFACE DATA

LOG OF BORING B2

CLIENT: Pardee Homes					PROJECT: Monosabian		W.O.: 8838
LOCATION: Santa Clarita					ELEVATION: 2005'		DATE: 7/23/02
RIG TYPE: 24" Bucket					HAMMER WEIGHTS: Kelly Bar Weights		DROP: 12"
	N	U	B	M	DD	DESCRIPTION	ATTITUDES
40						Light gray medium grained SANDSTONE, slightly cemented, continuous around hole, dry and dense.	
45						@41' - Pebble and cobble CONGLOMERATE with poorly sorted sand and gravel matrix, massive. Very difficult drilling due to abundant cobbles. Increasing cobbles to 51', belling of hole from 46-51', massive cobble CONGLOMERATE, coring required.	
50	5/10" X			4.7	130.5	Light gray CONGLOMERATE, clasts of subrounded granitics up to 10" diameter, coring required.	@49' B N47E/30NW Approx.
55						Cobble-rich zone, up to 12" diameter, subrounded granitics and anorthosite, clast supported, matrix consisting of poorly sorted sand and gravel, poorly cemented, not friable, dry and very dense, no discernible bedding.	
60						Refusal at 60' within cobble and boulder conglomerate. No groundwater Total Depth - 60'	
65							
70							
75							
80							
85							

ADDITIONAL COMMENTS: California Split Spoon Sampler
 Kelly Bar Weights 0 - 25', 3600 lbs
 25 - 47', 2600 lbs.
 47'+, 1600 lbs.

SURFACE DATA

LOG OF BORING B3

CLIENT: Pardee Homes					PROJECT: Monosabian		W.O.: 8838
LOCATION: Santa Clarita					ELEVATION: 1920±		DATE: 7/23/02
RIG TYPE: 24" Bucket					HAMMER WEIGHTS: Kelly Bar Weights		DROP: 12"
	N	U	B	M	DD	DESCRIPTION	ATTITUDES
0						Colluvium: Light brown clayey SAND with gravel, dry and slightly loose. Saugus Formation: Tan yellowish brown gravelly SANDSTONE, poorly cemented.	@2.5' Horizontal bedding
5			X			@1.5' - Tan coarse to very coarse grained SANDSTONE with scattered gravel. @2.5' - Gravelly SANDSTONE, very poorly sorted.	@5' B N7W/13SW Approx.
10	6	X		9.5	121.8	@5' - CONGLOMERATE, very poorly sorted sand matrix, slightly scoured upper contact, gravel to pebble size clasts. @7.5' - Grades into yellowish to orangish brown sandy CONGLOMERATE with increasingly silty and clayey matrix, clasts are weathered and with clay film development at clasts, massively bedded.	@11.5' B N6E/16NW Approx.
15						@11.5' - Grades into mottled brownish, orange and black CONGLOMERATE, nearly clast supported clayey sand matrix with abundant iron oxide and manganese oxide staining clasts up to 12" diameter, generally 2-6" diameter, dry and dense.	
20	10/2"	0				@14' - Grades into orange, brown, gravelly clayey SANDSTONE, occasional pebbles and cobbles, uncemented, damp and dense. @17' - Grades into pebbly-cobble CONGLOMERATE, 20" diameter boulder cored through in sidewall, below is light brown micaceous silty CLAYSTONE ripup clast, 12" diameter with two other 4" and 6" diameter ripups, surrounded by sandy CONGLOMERATE.	@17' B N7E/20NW Approx.
25	5/7"	X		10.5	113.7	@21' - Discontinuous brown sandy SILTSTONE, upper contact scoured by CONGLOMERATE, overlying tan micaceous coarse grained SANDSTONE continuous around 2/3 of hole, maximum 6" thick.	@21.5' B N4W/7SW @23' B N65E/3SE
30	27/11"	X		12.1	118.4	@23' - Discontinuous (scarce, scoured out) light gray medium grained SANDSTONE, maximum 6" thick. @23' - Yellowish to orangish brown gravelly medium to very coarse grained SANDSTONE, slightly friable and dense, sparse pebbles. @27' - Cobble lense, nearly horizontal bedding.	@27' Horizontal bedding
35						@27' - Orange to yellowish brown sandy CONGLOMERATE, poorly cemented, damp and very dense. @31' - Orange brown sandy CONGLOMERATE, increasing clasts and clast diameter with depth, poorly sorted clay and sand matrix, some clasts weathered and friable, massive bedding, coring required.	@34' TQs/Tm contact NS/10W Approx.
40	21	X		5.4	129.0	@34' - <u>Mint Canyon Formation</u> : Light gray CONGLOMERATE, coarse sand and gravel matrix, becoming clast supported @38', belling of hole to 3' due to cobbles and coring, scoured contact with overlying Saugus, dips shallowly to the west.	
45						@41' Light gray gravelly SANDSTONE with pebbles, channelized, relatively flat-lying.	

ADDITIONAL COMMENTS:

California Split Spoon Sampler
 Kelly Bar Weights: 0 - 25', 3600 lbs.
 25 - 47', 2600 lbs.
 47'+, 1600 lbs.

SURFACE DATA

LOG OF BORING B3

CLIENT: Pardee Homes					PROJECT: Monosabian		W.O.: 8838
LOCATION: Santa Clarita					ELEVATION: 1920±		DATE: 7/25/02
RIG TYPE: 24" Bucket					HAMMER WEIGHTS: Kelly Bar Weights		DROP: 12"
	N	U	B	M	DD	DESCRIPTION	ATTITUDES
40						Light gray gravelly SANDSTONE with scattered pebbles, channelization and scours common, occasional clasts of purple basalt, subrounded.	
45						Grades into sandy CONGLOMERATE, clasts typically hard and less weathered, locally friable, damp and very dense.	
50	30	X		7.1	118.0	Light gray sandy CONGLOMERATE, clasts typically hard and unweathered, locally friable, typically poorly cemented, damp and very dense. @50' - Light gray medium grained SANDSTONE, nearly continuous around hole, locally scoured and absent, 3" thick (maximum), uncemented, damp and dense. @53' - Discontinuous light gray fine to medium grained SANDSTONE, surrounded by light gray sandy CONGLOMERATE. @55' - Gravelly sandstone lens. @55' - Light gray CONGLOMERATE, locally clast supported, up to 18" diameter subrounded clasts, poorly sorted gravelly sand matrix, poor to no cementation, damp and dense to very dense, coring required, very slow progress.	@50' B N24E/13NW
55							@53' B N40E/17NW @55' B N34W/10SW Approx.
60		X		4.7	116.8		
65						@64' - Light greenish gray fine grained SANDSTONE, upper surface slightly scoured, continuous around hole, damp and dense, slightly friable. @65' - Light gray sandy CONGLOMERATE, matrix supported, subrounded granitic clasts up to 18" diameter, damp and very dense. @67' - Light gray cobble and boulder CONGLOMERATE, locally clayey poorly sorted sand matrix, predominantly gravelly sand matrix, coring required. @70' - Light gray cemented sandy CONGLOMERATE, coring.	@64' Top BN40W/16SW Approx. @65' Bottom BN30W/12SW
70							
75						Refusal at 70', Total drilling time = 30 hours, extensive coring from 30 feet to 70 feet. No groundwater No caving	
80							
85							
ADDITIONAL COMMENTS:					California Split Spoon Sampler Kelly Bar Weights: 0 - 25', 3600 lbs. 25 - 47', 2600 lbs. 47'+, 1600 lbs.		

SURFACE DATA

LOG OF BORING B4

CLIENT: Pardee Homes					PROJECT: Monosabian			W.O.: 8838	
LOCATION: Santa Clarita					ELEVATION: 1690'±			DATE: 8/1/02	
RIG TYPE: 24" Bucket					HAMMER WEIGHTS: Kelly Bar Weights			DROP: 12"	
N	U	B	M	DD	DESCRIPTION			ATTITUDES	
0					<p>Saugus Formation: Tan to light yellowish brown gravelly SANDSTONE and sandy CONGLOMERATE, clasts typically subrounded granitics and gneiss, lesser volcanics, rare brown siltstone ripup clasts, matrix locally clayey and silty, predominantly poorly sorted sand matrix, massively bedded.</p>				
5					<p>@5.5' - Discontinuous orange and gray silty very fine grained SANDSTONE, scoured out.</p>				
					<p>@8' - Brown SILTSTONE ripup clasts, no discernible bedding up to 12" diameter.</p>				
10	9/8"	X			9.1	114.6	<p>@9' - Coring due to large cobble.</p>		
							<p>@12' - Relatively sharp but undulatory contact with yellow to gray medium to very coarse grained SANDSTONE, 12" thick.</p>		
							<p>@13' - Gravelly SANDSTONE, poorly sorted, poorly cemented, damp and dense.</p>		
15							<p>@14' - Orangish brown sandy CONGLOMERATE, silty clayey sand matrix.</p>		
							<p>@18.5' - Grading into gravelly SANDSTONE, sparse pebbles, damp and dense, slightly cemented, locally weathered and clayey matrix with gravel.</p>		
20	9	X			10.5	120.6	<p>@20' - Orangish brown sandy clayey CONGLOMERATE, increase in moisture, abundant rusty orange iron oxide staining.</p>		
							<p>@22' - Near horizontal bedding based on pebbly stringer.</p>		
							<p>@24' - Grades into sandy CONGLOMERATE, orangish brown clayey SAND matrix, coring, damp and dense.</p>		
25							<p>@27' - Faint gray sandstone stringer.</p>		
							<p>@24' B N52E/16NW Approx. @14' B N25W/14SW</p>		
30					7.9	128.5	<p>@32' - Sandy GRAVEL with orangish brown silty clay matrix, weathering, rusty orange staining and clay film development around gravel and subrounded pebble clasts, moist and dense, slightly cemented.</p>		
							<p>@35' - Slight seepage.</p>		
							<p>@35' - Grades into sandy CONGLOMERATE, very poorly sorted, massively bedded, slightly cemented, wet and very dense, coring.</p>		
40	22	X					<p>Becomes notably more clastic, clast-supported.</p>		
							<p>@45' - Seepage.</p>		
ADDITIONAL COMMENTS:					<p>California Split Spoon Sampler Kelly Bar Weights: 0 - 25', 3600 lbs. 25 - 47', 2600 lbs. 47'+, 1600 lbs.</p> <p>Blows per 12"</p>				

SURFACE DATA

LOG OF BORING B4

CLIENT: Pardee Homes					PROJECT: Monosabian			W.O.: 8838	
LOCATION: Santa Clarita					ELEVATION: 1690±			DATE: 8/1/02	
RIG TYPE: 24" Bucket					HAMMER WEIGHTS: Kelly Bar Weights			DROP: 12"	
	N	U	B	M	DD	DESCRIPTION			ATTITUDES
40						<p>@48' - Clast-supported CONGLOMERATE, subrounded to rounded clasts, pebbles to small cobbles, wet and very dense, coring</p> <p>@49' - <u>Mint Canyon Formation</u>: - Contact based on gradational color change in conglomerate, no orientation discernible, coring. Light gray sandy CONGLOMERATE, clasts predominantly 8" or less in diameter, poor cementation, wet and dense.</p> <p>@54' - Boulder CONGLOMERATE, light gray cobble CONGLOMERATE below, cemented at 58', wet and very dense, coring.</p> <p>@60' - Coring through boulder, refusal.</p> <p>Refusal at 60'</p> <p>Total Depth - 60'</p> <p>Groundwater at 59' upon downhole logging to the hole, slow seepage from 35 feet to 60 feet.</p> <p>No caving</p>			
45									
50									
55									
60									
65									
70									
75									
80									
85									

ADDITIONAL COMMENTS:

California Split Spoon Sampler
 Kelly Bar Weight: 0 - 25', 3600 lbs.
 25 - 47', 2600 lbs.
 47'+, 1600 lbs.

SURFACE DATA

LOG OF BORING B5

CLIENT: Pardee					PROJECT: Monosabian					W.O.: 8838		
LOCATION: Santa Clarita					ELEVATION: 1760'					DATE: 8/5/02		
RIG TYPE: 24" bucket					HAMMER WEIGHTS: Kelly Bar Weights					DROP: 12"		
N	U	B	M	DD	DESCRIPTION					ATTITUDES		
0					Saugus Formation: Grayish brown silty clayey SAND with gravel and subrounded pebbles, minor porosity, root hairs, dry and dense.							
5					Light brown silty clayey SANDSTONE, coarse grained, sparse gravel, dry and dense, uncemented.					@5' B		
					@6' - Mottled gray and orangish brown silty clayey SANDSTONE, fine to medium grained, scoured contacts with surrounding beds, dry and dense.					N67W/7SW		
					@8' - Mottled gray and reddish brown clayey sandy SILT to silty sandy CLAY, paleosol, sparse gravel, damp and dense, sparse carbonate veinlets.					Approx.		
10	6	X			9.9	129.2	@9' - Reddish brown clayey gravelly SANDSTONE, coarse grained, uncemented, damp and dense.					@6' B
							@10' - Mottled gray and reddish brown clayey fine to medium grained SANDSTONE, scoured, undulatory upper contact.					N20W/7SW
							@12' - Irregular scoured contact with mottled gray and reddish brown silty CLAY, micaceous, paleosol, damp and stiff.					Approx.
							@12.5' - Gravel=4.6%, sand=39%, silt=37%, clay(0.005)=19%; LL=36.9, PL=18.9, PI=18.					@8' B
							@13' - Grades into silty very fine grained SANDSTONE, uncemented.					N64E/8NW
							@13.5' - Gravel stringer with notable moisture.					Approx.
							@14' - Orangish brown clayey silty SANDSTONE, damp and dense.					@13.5' B
							@14.5' - Becomes light gray in color.					N38W/8SW
							@16' - Mottled orange and gray gravelly clayey SANDSTONE, uncemented, relatively horizontal, upper and lower contact scoured, moist and dense.					Approx.
							@18' - Light gray silty fine to medium grained SANDSTONE, moist and dense, uncemented, slightly friable.					
20	8/11"	X			8.1	131.8	@18.5' - Orangish brown clayey gravelly SANDSTONE, gradational contact, moist and dense.					@21.5' B
							@21.5' - Gray sandy SILTSTONE, grading into red-orange clayey gravelly SANDSTONE, paleosol at 22.5', slightly moist and dense.					N9E/17NW
							@23' - Reddish brown to orangish brown clayey SANDSTONE, uncemented, slightly moist and dense.					
							@33' - Grades into light grayish orange fine to medium grained SANDSTONE.					@33' B
							@35' - Mottled gray and orange sandy CONGLOMERATE, predominantly granitic clasts, occasional gray siltstone rip-up clasts, coring, damp and dense.					N49W/11SW
							@38' - Grades into yellowish gray to light gray CONGLOMERATE, subrounded cobble to 18" diameter boulders, locally clast supported, slightly dry and very dense, coring, matrix consists of poorly sorted silty sand.					Approx.
30	13	X			10.4	128.9						@35' B
												N30E/5NW
35												
40	23/9"	X			6.3	124.5						
45												
ADDITIONAL COMMENTS:					California Split Spoon Sampler							
					Kelly Bar Weights: 0 - 25', 3600 lbs.							
					25 - 47', 2600 lbs.							
					47'+, 1600 lbs.							
					Blows per 12"							

SURFACE DATA

LOG OF BORING B5

CLIENT: Pardee						PROJECT: Monosabian		W.O.: 8838	
LOCATION: Santa Clarita						ELEVATION: 1760'		DATE: 8/5/02	
RIG TYPE: 24" Bucket						HAMMER WEIGHTS: Kelly Bar Weights		DROP: 12"	
	N	U	B	M	DD	DESCRIPTION		ATTITUDES	
40									
45						Clast supported CONGLOMERATE, massive bedding. Mint Canyon Formation (?): Olive gray sandy SILTSTONE, hard and slightly cemented, continuous and relative sharp upper contact, no shearing observed. @ 47' - Light gray gravelly SANDSTONE with pebbles and cobbles.		@46' B N21E/12NW Approx.	
50						Discontinuous light gray fine grained SANDSTONE lens, biotite-rich, cross bedding. @ 50.5' - Light gray sandy CONGLOMERATE, massively bedded.		@50' B N42W/16SW Approx on x-bed	
55						Discontinuous light gray sandy SILTSTONE, scoured out by conglomerate, slightly dry and dense.			
60						Clast supported CONGLOMERATE, poorly sorted silty sandy matrix, damp and very dense, abundant clasts of subrounded granitics and purple/maroon porphyritic basalt, coring from 68-71', boulders up to 20" diameter, subrounded.			
65									
70					X	Grades into light gray gravelly SANDSTONE, poorly cemented, damp and dense. @ 72' - Sharp contact with olive gray clayey SILTSTONE, hard and stiff, no shearing, 10"± thick, gravel=0.7%, sand=55%, silt=35%, clay(0.005)=9%; LL=40.1, PL=20.7, PI=20. @ 73' - Light gray sandy CONGLOMERATE, cobbles of gneiss and granitics, damp and very dense. @ 75' - Light gray gravelly SANDSTONE, cemented, medium to coarse grained, occasional pebbles, damp and very dense, coring. @ 77' - Gray cobble CONGLOMERATE, poorly sorted gravelly sand matrix, cemented. Refusal on boulder, greater than 24" diameter, coring with 12", 18", and 24" buckets, no progress, progress interrupted by broken kelly bar and broken bucket.		@71' B N60W/3SW Approx. @72' B N32W/12SW Top of siltstone @75' B N11E/10NW	
75									
80						@ 77' - Gray cobble CONGLOMERATE, poorly sorted gravelly sand matrix, cemented. Refusal on boulder, greater than 24" diameter, coring with 12", 18", and 24" buckets, no progress, progress interrupted by broken kelly bar and broken bucket.			
85						Total Depth - 82', No groundwater, no caving			
ADDITIONAL COMMENTS:						California Split Spoon Sampler Kelly Bar Weights: 0 - 25', 3600 lbs. 25 - 47', 2600 lbs. 47'+, 1600 lbs. Blows per 12"			

SURFACE DATA

LOG OF BORING B6

CLIENT: Pardee						PROJECT: Monosabian		W.O.: 8838
LOCATION: Santa Clarita						ELEVATION: 1480' ±		DATE: 8/16/02
RIG TYPE: 24" Bucket						HAMMER WEIGHTS: Kelly Bar Weights		DROP: 12"
	N	U	B	M	DD	DESCRIPTION		ATTITUDES
0						<p><u>Saugus Formation</u>: Tan to light yellowish brown gravelly SANDSTONE with scattered pebbles, abundant channelling and scours, dry and dense. Yellow medium to coarse grained SANDSTONE, weakly cemented, scoured upper and lower contact, dry and dense.</p> <p>@3' - Yellow to yellowish tan gravelly SANDSTONE, grades into sandy gravelly CONGLOMERATE at 4.5', weakly cemented, dry and very dense.</p>		@2' B N51E/13NW Approx.
5						<p>Grades into orangish brown CONGLOMERATE, subrounded pebble and cobbles in orange brown clayey sand matrix, damp and dense, massively bedded.</p>		@3' Horizontal bedding
10								
15	7/10"	X		10.3	122.8	<p>@14.5' - Grades into brownish yellow gravelly clayey SANDSTONE, contact relatively flat and gradational, weak to no cementation, damp and dense.</p>		
20	6/9"	X		7.4	127.2	<p>Cobble and boulder CONGLOMERATE, cemented, clasts up to 20" diameter in sidewall, coring, scoured irregular upper contact, generally horizontal.</p>		@22' Horizontal Approx.
25						<p>Mottled grayish orange fine to coarse grained silty SANDSTONE, poorly sorted, moist and dense, occasional scattered gravels. Gravel stringer.</p>		@27' B N23E/7NW Approx.
30						<p>Grades into sandy CONGLOMERATE.</p>		@29' B N27E/6NW Approx.
35	16	X		8.8	126.7	<p>Tan sandy CONGLOMERATE, generally gravel to pebble size clasts, poorly sorted silty sand matrix.</p> <p>@35' - Light gray and orange stained fine to coarse grained SANDSTONE with gravel, abundant scouring to cross bedding.</p> <p>@37' - Discontinuous light gray SAND, scoured out, moist and dense.</p> <p>@38' - Cobbly CONGLOMERATE, poor to moderate cementation.</p>		@35' B N36W/16SW Approx. @37' B N43E/10NW Approx.
40						<p>Refusal on boulder, covers bottom of hole, no progress after coring 8 hours with 12", 18" and 24" buckets.</p> <p>Total Depth - 42'</p> <p>No groundwater</p>		
45								
ADDITIONAL COMMENTS:						<p>California Split Spoon Sampler</p> <p>Kelly Bar Weights: 0 - 25', 3600 lbs. 25 - 47', 2600 lbs. 47'+, 1600 lbs.</p> <p>Blows per 12"</p>		

SURFACE DATA

LOG OF BORING B7

CLIENT: Pardee Homes					PROJECT: Monasabian			W.O.: 8838
LOCATION: Santa Clarita					ELEVATION: 1960' ±			DATE: 9/5/02
RIG TYPE: Core Rig					HAMMER WEIGHTS: N/A HX-HQ coring			DROP: N/A
	N	B	R	DD	DESCRIPTION			ATTITUDES
0		T			<p>@0-4.5', <u>Colluvium</u>: Grayish brown gravelly silty SAND with clay and scattered pebbles, dry and slightly loose.</p>			
5		T			<p>@4.5' - <u>Saugus Formation</u>: Light orangish brown clayey SANDSTONE with gravel and sparse cobbles, poorly sorted.</p>			
10		T			<p>@6-14', Orangish tan poorly sorted gravelly SANDSTONE, minor silt and clay. Cobble at 10'. Cobble at 12'. @14-17', Tan silty clayey SANDSTONE, increasing gravel and cobbles, predominantly very fine to medium grained.</p>			
15		T			<p>Color change to white to light gray Cobble at 16.5' to 17'. @17-24', Yellowish tan buff medium to very coarse grained SANDSTONE with gravel, sparse fines.</p>			
20		T			<p>Cobble at 24-25'. @24-33.5', Yellowish tan conglomeratic SANDSTONE.</p>			
25		T			<p>Cobble zone at 31-33.5'. @33.5-38.5', Light brownish gray poorly sorted SANDSTONE with silt.</p>			@33.6' B N67E/10SE
30		T			<p>Boulder at 38'. @38.5-41', Light brownish gray conglomeratic SANDSTONE, sparse fines.</p>			@38.4' B N26E/14SE Approx.
35		T			<p>@41-42', Pebbly CONGLOMERATE, very poorly sorted, clast-supported, possible Saugus basal conglomerate, reworked Mint Canyon Formation. @42' - <u>Mint Canyon Formation</u>: Green to olive gray sandy CONGLOMERATE to conglomeratic SANDSTONE, matrix supported, predominantly gravel to pebble size clasts of granitics and weathered volcanics.</p>			
40		T						
45								
ADDITIONAL COMMENTS:					<p>T = Tricone drilling C = Core drilling R = Recovery</p>			

CLIENT: Pardee Homes		PROJECT: Monasabian		W.O.: 8838
LOCATION: Santa Clarita		ELEVATION: 1960' ±		DATE: 9/5/02
RIG TYPE: Core Rig		HAMMER WEIGHTS: N/A HX-HQ Coring		DROP: N/A
N	B	R	DESCRIPTION	ATTITUDES
40	T			
45	T	N/A	Cobble at 45'. Light gray sandy CONGLOMERATE, predominantly medium to very coarse grained, subangular to subrounded clasts, matrix supported. @47' - Olive gray in color.	
50	T		@50-52.5', Cobble zone, start coring at 53'.	@50.2' B N44W/27SW on gravel lens
	T		@52.5-53.5', Light gray fine to medium grained SANDSTONE with sparse gravel.	
	C		Poor recovery from 53-55.5' in light gray sandy CONGLOMERATE, poorly sorted fine to coarse matrix, subrounded gravel and pebbles, weak to no cementation.	
55	C		@55.5-56.75', Good recovery of white anorthosite boulder. @57-59', No recovery in conglomerate matrix. @59-60.4', Light gray medium to very coarse grained SANDSTONE.	
60	C		@60' - Cobble of gneiss, good recovery. @60.4-65.5, Medium gray cobble CONGLOMERATE, poorly cemented, poor recovery, poor to no cementation.	
65	C		No recovery, matrix consists of medium to very coarse grained SAND, occasional green clay films around clasts. @65.5' - Shear in CONGLOMERATE, moderate angle about 45°, grayish maroon clay film, 1-3mm thick. @65.5-68', Greenish gray sandy CONGLOMERATE, poor to no cementation, subangular to subround gravels and pebbles.	@65.4' B N89E/41SE Approx. channel @66.2' B N58W/35SW Approx. channel
70	C		@68-69', No recovery. @69' - Cobble of gray andesite and cobble of gneiss. @70-71', Mottled olive gray to gray pebbly CONGLOMERATE with clayey sandy gravel matrix, very poorly sorted, uncemented.	@66.4' B N51W/45SW Approx. channel @71.6' B N33W/43SW Approx. channel
75	C		@71-72', No recovery in cobble CONGLOMERATE, clast supported. @72' - 8" diameter gneiss cobble. @72-77', Greenish gray cobble CONGLOMERATE, weak to no cementation in olive green poorly sorted sand matrix. @77-78', Greenish gray gravelly SANDSTONE, medium to very coarse grained, poorly cemented.	@74.1' B N40W/35SW Approx. channel
80	C		@78-78.5', No recovery in conglomerate. @78.5-80', Core of granodiorite cobble. @80-81.5', Greenish gray pebble CONGLOMERATE with scattered gravel, micaceous, poorly cemented, nearly clast supported.	
85	C			

ADDITIONAL COMMENTS: T = Tricone drilling
C = Core drilling
R = Recovery

SURFACE DATA

LOG OF BORING B7

CLIENT: Pardee Homes					PROJECT: Monasabian			W.O.: 8838
LOCATION: Santa Clarita					ELEVATION: 1960' ±			DATE: 9/5/02
RIG TYPE: Core Rig					HAMMER WEIGHTS: N/A HX-HQ Coring			DROP: N/A
	N	B	R	DD	DESCRIPTION			ATTITUDES
80				C	<p>@82-82.5', White anorthosite cobble, poor recovery.</p> <p>@82.5-83.5', Greenish gray gravel CONGLOMERATE, good recovery, matrix of silty poorly sorted sand with poor cementation.</p>			
85				C	<p>@83.5-86', Pebbles of granite, anorthosite, and purple volcanics.</p> <p>@86-92.5', White, gray and greenish gray cobble CONGLOMERATE, clast-supported with fine to medium grained sand matrix, weak to moderate cementation, good recovery, clasts of diorite, gneiss, anorthosite, lesser black peroxinite, purple/maroon volcanics, shallow dip (10-30°) indicated on occasional thin poorly sorted sand interbeds.</p>			
90				C	<p>@92.5-93.8', Greenish gray silty very fine to medium grained SANDSTONE with scattered pebbles, weakly cemented.</p>			
95				C	<p>@93.8' - White, green, greenish gray cobble to boulder CONGLOMERATE, clast supported, poorly sorted clayey sand matrix, cores breaking along fractures in boulders and clast/matrix contacts, weakly cemented.</p>			
100				C	<p>@101-103', Sandy CONGLOMERATE, matrix-supported by poorly sorted clayey sand, weakly cemented.</p> <p>@103' - Boulder of light gray pyroxene-bearing anorthosite. No recovery.</p>			@103.74' B N8W/21SW
105				C	<p>@103-106' - Light gray gravelly CONGLOMERATE, no recovery.</p> <p>@106-107.5', Light gray fine to coarse grained SANDSTONE, grading into gravelly SANDSTONE below 107.5'.</p> <p>@108-109.25', Sandy CONGLOMERATE, gravel to pebble size clasts, weakly cemented clayey sand matrix, matrix supported.</p>			@106.12' B N31W/16SW
110				C	<p>@109.25' - Cobble of coarse grained granite.</p> <p>@109.25-114', Sandy CONGLOMERATE, poorly sorted sand matrix.</p>			
115				C	<p>@114-115', Greenish gray fine to medium grained SANDSTONE with scattered subrounded gravel and pebbles, weakly cemented, shallow dip (10-20°) based on black iron oxide laminations/grains.</p> <p>@115-124' - Greenish gray pebble to gravel CONGLOMERATE, matrix supported, silty poorly sorted sand matrix, weakly cemented, good recovery, bedding dip appears very shallow 5-15°.</p>			@114.09' B N80W/22SW
120				C	<p>12" diameter weathered granitic cobble.</p>			
125				C	<p>@124-125.25', Gray gravelly SANDSTONE.</p>			
ADDITIONAL COMMENTS:					<p>T = Tricone drilling C = Core drilling R = Recovery</p>			

SURFACE DATA

LOG OF BORING B7

CLIENT: Pardee Homes				PROJECT: Monasabian				W.O.: 8838	
LOCATION: Santa Clarita				ELEVATION: 1960' ±				DATE: 9/5/02	
RIG TYPE: Core Rig				HAMMER WEIGHTS: N/A HX-HQ Coring				DROP: N/A	
	N	B	R	DD	DESCRIPTION	ATTITUDES			
125	C				@125.25-131', Gray sandy CONGLOMERATE, generally matrix supported. Cobble of coarse grained gneiss, poorly cemented, poorly sorted sand and gravel matrix.				
130	C				@127-128', No recovery. @128.25' - Cobble of gray anorthosite. @129.25' - Cobble of white monzonite. @130.5-132', Light greenish gray very fine to fine grained SANDSTONE, well cemented, dips of 15-25°, well sorted, slightly laminated. @132-136.5', Mottled green and gray conglomeratic SANDSTONE, poorly cemented.				
135	C				@136.5-140', Conglomeratic SANDSTONE, poorly cemented.	@135.25' B N49W/13SW @136.88' B N70W/13SW Approx.			
140	C				@140-142', Light gray gravelly SANDSTONE, medium to very coarse grained, poorly cemented, subangular to subrounded clasts of felsic granitics, and lesser maroon volcanics. @142-144.25', Conglomeratic SANDSTONE, pebbles of monzonite. @143-143.5', No recovery.				
145	C				Light gray poorly sorted SANDSTONE, poorly cemented, sparse subround gravel. @146.5-147.5', Light gray pebbly SANDSTONE. @147.5-149', Light greenish gray fine to medium grained SANDSTONE, sparse subrounded gravel, poorly cemented.	@144.24' B N52W/24SW @145.75' B N51W/35SW Approx.			
150	C				@149-151', Sandy CONGLOMERATE, predominantly gravel to small pebble size clasts, poorly sorted sand matrix, locally well cemented zones. @151-153', Light gray gravelly SANDSTONE, poorly sorted, no cementation. @153-155', Conglomeratic SANDSTONE, weakly cemented, fine to coarse grained.				
155	C				Cobble of diorite. @156.5-165', Light gray sandy CONGLOMERATE, poorly sorted sand matrix, matrix supported, weak cementation. @158.75' - Cobble of purple/maroon welded ash tuff.				
160	C								
165	C				@165-168.7', Light gray tuffaceous SANDSTONE, fine to coarse grained, weak cementation, becoming increasingly coarse from 169-170'. @168-170', Gravelly SANDSTONE, very poorly sorted, weak cementation.	@165.58' B N50W/15SW			
170	C								
ADDITIONAL COMMENTS:					T = Tricone drilling C = Core drilling R = Recovery				

SURFACE DATA

LOG OF BORING B7

CLIENT: Pardee Homes					PROJECT: Monasabian			W.O.: 8838	
LOCATION: Santa Clarita					ELEVATION: 1960' ±			DATE: 9/8/02	
RIG TYPE: Core Rig					HAMMER WEIGHTS: N/A HX-HQ Coring			DROP: N/A	
	N		B	R	DD	DESCRIPTION			ATTITUDES
170		C				@170-173', CONGLOMERATE, clast supported. @171' - 9" diameter cobble of monzonite. @173-174', Light gray tuffaceous SANDSTONE, fine grained, weak to moderate cementation. @174' - Cobble of weathered porphyritic welded tuff. No recovery from 176-177'. Sandy CONGLOMERATE, very poorly sorted matrix, weak cementation.			
175		C							
180		C				Total Depth - 180 Minor caving at 175' No appreciable groundwater noted during drilling Groundwater at 169.5' October 1, 2002			
185									
190									
195									
200									
205									
210									
215									

ADDITIONAL COMMENTS: T = Tricone drilling
 C = Core drilling
 R = Recovery

Orientation Summary Table
BIPS Features
Santa Clarita Project, Boring: # 7
September 10, 2002

ATTITUDES CORRECTED +14 DEG. FOR MAGNETIC DECLINATION
 FEATURES IN **BOLD** CONSIDERED BEDDING-RELATED

FEATURE DESCRIPTION	Feature No.	Depth (meters)	Depth (feet)	Strike and Dip Angle (degrees)	Feature Rank (0 to 5)	CORRECTED ATTITUDE
Top of cobble	1	4.94	16.2	N 40W 47NE	0	N54W/ 47NE
Bottom of cobble	2	5.26	17.3	N 88W 29N	0	N78E/ 29NW
Gravel lense	3	7.63	25.0	N 80E 37N	1	N66E/ 37NW
Pebble bisected by core	4	7.74	25.4	N 27E 58E	0	N13E/ 58SE
Channel	5	10.04	32.9	N 40W 36SW	2	N54W/ 36SW
Top of sandstone	6	10.24	33.6	N 81E 10S	3	N67E/ 10SE
Appx bottom of sandstone	7	11.71	38.4	N 40E 14SE	0	N26E/ 14SE
Bottom of cobble	8	11.98	39.3	N 84E 39S	0	N70E/ 39SE
Pebbles	9	12.51	41.0	N 63W 29N	0	N77W/ 29NE
Pebbles	10	12.66	41.5	N 88W 27S	0	N78E/ 27SE
Pebbles	11	13.29	43.6	N 63W 24S	1	N77W/ 24SW
Pebbles	12	13.41	44.0	N 51E 30NW	0	N37E/ 30NW
Top of pebble	13	13.86	45.5	N 78W 18N	0	N88E/ 18NW
Bottom of pebble	14	13.95	45.8	N 74W 20N	0	N88W/ 20NW
Gravel lense	15	15.29	50.2	N 30W 27SW	0	N44W/ 27SW
Top of cobble	16	15.33	50.3	N 33E 17NW	0	N19E/ 17NW
Bottom of cobble	17	15.71	51.5	N 4W 45W	0	N18W/ 45SW
Bottom of pebble	18	16.51	54.2	N 36E 47NW	1	N42E/ 47NW
Top of cobble	19	16.95	55.6	N 29E 31E	0	N15E/ 31SE
Bottom of cobble	20	17.29	56.7	N 36E 18SE	0	N22E/ 18SE
Top of cobble	21	18.41	60.4	NS 44W	0	N14W/ 44SW
Bottom of cobble	22	18.59	61.0	N 11W 21E	0	N25W/ 21NE
Appx Channel	23	19.93	65.4	N 77W 41S	1	N89E/ 41SE
Appx Channel	24	20.17	66.2	N 44W 35SW	1	N58W/ 35 SW
Appx Channel	25	20.24	66.4	N 37W 45SW	1	N51W/ 45SW
Top of pebble	26	21.35	70.1	N 53E 23SE	1	N39E/ 23SE
Top of cobble	27	21.57	70.8	N 62W 51N	0	N76W/ 51NE
Appx Channel	28	21.83	71.6	N 19W 43W	0	N33W/ 43SW
Bottom of cobble	29	22.01	72.2	N 51W 28SW	0	N65W/ 28SW
Appx Channel	30	22.59	74.1	N 26W 35W	0	N40W/ 35SW
Bottom of pebble	31	24.85	81.5	N 2W 41W	1	N16W/ 41SW
Top of cobble	32	25.03	82.1	N 29E 23W	0	N15E/ 23NW
Bottom of cobble	33	25.16	82.5	N 46W 29NE	0	N60W/ 29NE
Bottom of cobble	34	26.35	86.4	N 87W 28N	0	N79E/ 28NW
Top of cobble	35	27.19	89.22	N 56W 46NE	0	N70W/ 46NE
Bottom of cobble	36	27.33	89.68	N 26E 19E	0	N12E/ 19SE
Top of cobble	37	29.06	95.34	N 9E 14W	0	N5W/ 14SW
Top of cobble	38	29.623	97.19	N 36E 48NW	0	N25E/ 48NW
Bottom of cobble	39	29.825	97.85	N 43E 7SE	0	N29E/ 7SE
Pebbles	40	30.357	99.60	N 14E 29E	0	NS/ 29E
Btm of Cobble/Top of SS	41	31.619	103.74	N 6E 21W	0	N8W/ 21SW
Scour/Channel	42	32.305	105.99	N 26W 28E	1	N40W/ 28NE
Top of sandstone	43	32.343	106.12	N 17W 16W	0	N31W/ 16SW

All directions are with respect to magnetic north.

Orientation Summary Table
RIPS Features
Santa Clarita Project, Boring: # 7
September 10, 2002

FEATURE DESCRIPTION	Feature No.	Depth (meters)	Depth (feet)	Strike and Dip Angle (degrees)	Feature Rank (0 to 5)	CORRECTED ATTITUDE
Channel ?	44	32.768	107.51	N 25W 31W	0	N39W/ 31SW
Top of cobble	45	34.4	112.86	N 85E 20N	0	N71E/ 20NW
Top of sandstone	46	34.774	114.09	N 66W 22S	1	N80W/ 22SW
unknown	47	34.992	114.81	N 72W 18N	0	N86W/ 18NE
unknown	48	35.017	114.89	N 66E 46S	0	N52E/ 46SE
Channel ?	49	36.298	119.09	N 78W 44N	2	N88E/ 44NW
Channel ?	50	37.616	123.42	N 23E 27E	0	N9E/ 27SE
Top of cobble	51	37.708	123.72	N 12E 29E	0	N2W/ 29NE
Top of cobble	52	38.517	126.37	N 42E 29SE	0	N28E/ 29SE
Top of cobble	53	38.893	127.61	N 42E 22NW	0	N28E/ 22NW
Gravelly Sandstone/Fine SS	54	41.221	135.24	N 35W 13SW	0	N49W/ 13SW
Pebble	55	41.641	136.62	N 32W 33NE	0	N46W/ 33NE
Appx. Top of Sandstone	56	41.72	136.88	N 56W 13SW	0	N70W/ 13SW
Top of Pebbles	57	42.143	138.27	N 69W 24N	0	N83W/ 24NE
Bottom of Cobble	58	43.626	143.13	N 40W 35NE	0	N54W/ 35NE
Top of sandstone	59	43.964	144.24	N 38W 24SW	0	N52W/ 24SW
Appx. Bottom of gravel lense	60	44.422	145.75	N 37W 35SW	0	N51W/ 35SW
unknown	61	46.059	151.12	N 70W 43N	0	N84W/ 43NE
Top of cobble	62	46.92	153.94	N 77E 42S	0	N63E/ 42SE
Bottom of cobble	63	47.026	154.29	EW 17S	0	N76E/ 17SE
Top of cobble	64	48.323	158.55	N 54W 14SW	0	N68W/ 14SW
Bottom of Cobble	65	48.517	159.18	N 88E 16S	0	N74E/ 16SE
Top of sandstone	66	50.466	165.58	N 36W 15SW	0	N50W/ 15SW
Top of cobble	67	53.126	174.30	N 39W 38SW	0	N53W/ 38SW



ATTITUDES CORRECTED +14 DEG. FOR MAGNETIC DECLINATION
 FEATURES IN BOLD CONSIDERED BEDDING-RELATED

SURFACE DATA

LOG OF BORING B8 (1 of 6)

CLIENT: Pardee						PROJECT: Monasabian Property			W.O.: 8838	
LOCATION: Santa Clarita						ELEVATION: 1554' ±			DATE: 9/11/02	
RIG TYPE: Boyles 37 Core						HAMMER WEIGHTS: N/A HX-HQ Coring			DROP: N/A	
	T/C	U	R	M	DD	DESCRIPTION			ATTITUDES	
0	T					Weathered Saugus Formation: Brownish gray silty fine to medium grained SAND, uncemented, minor clay content. Saugus Formation: Reddish brown clayey SANDSTONE to sandy CLAYSTONE, paleosol, massively bedded.				
5	T									
10	T					@ 10.5' - Tan clayey silty SANDSTONE, poorly sorted, uncemented.				
15	T					Sparse gravel.			@ 14.6' B N68W/34SW @ 15' B N89W/47SW Approx.	
20	T					Tan to light brown silty very fine to fine grained SANDSTONE, massively bedded.				
25	T					@ 24.5' - Pebble.				
30	T					@ 32' - Subrounded pebble. @ 33' - Buff medium to coarse grained SANDSTONE, sparse gravel, gradational contacts, massive bedding.				
35	T					@ 35' - Sandy CONGLOMERATE, abundant chatter from Tricone grinding, clayey silty sand matrix, poorly sorted.				
40	T					Decrease in cobbles. Clasts consist of weathered purple volcanics and white granitics. @ 42.5-52.5', Yellowish brown medium to coarse grained SANDSTONE with scattered gravel, iron oxide staining, massively bedded.				
45										

ADDITIONAL COMMENTS: T = Tricone
C = Coring
R = Recovery

CLIENT: Pardee						PROJECT: Monasabian Property		W.O.: 8838	
LOCATION: Santa Clarita						ELEVATION: 1554' ±		DATE: 9/11/02	
RIG TYPE: Boyles 37 Core						HAMMER WEIGHTS: N/A HQ Coring		DROP: N/A	
T/C	U	R	M	DD	DESCRIPTION				ATTITUDES
40	T								
45	T								
50	T								
55	T								
60	T								
	T								
65	C								
70									
75	C								
80									
85									
ADDITIONAL COMMENTS:						T = Tricone C = Coring R = Recovery			

@52.5-63', Reddish brown conglomeratic SANDSTONE, minor silt and clay, massively bedded.

Tricone to 63'.
 Coring begun at 63'.
 @63-67.5', Mottled yellow, rusty orange, and gray gravel CONGLOMERATE, poorly sorted, occasional pebbles, weakly cemented, abundant scours, iron oxide staining.

@64' - 3" thick light olive gray with light brown iron oxide stains fine grained silty SANDSTONE, cemented, hard.

@64-64.25', Yellow-tan very fine grained SANDSTONE, dip of 25-35°, moderate cementation.

@66-67', Pebble of monzonite.

@67.5-70', Light yellowish brown medium grained SANDSTONE, uncemented.

@69.75' - Granitic cobble or boulder with fracture.

@69.8' - 1" thick light olive gray and grayish orange fine to coarse grained SANDSTONE with very minor silt, slightly cemented, hard.

@72' - Paper thin moderate yellowish brown polished sheared clay with black manganese oxide stains, dip of 10°, pencil wide striations oriented 22° from true dip direction, on top of 1/2" to 1" thick moderate yellowish brown and light olive gray fine grained sandy SILTSTONE.

@72.2' - Granitic boulder, no recovery.

@72.5-73.5', Grayish orange and light olive gray fine to medium grained SANDSTONE with minor silt, black heavy mineral laminations 4-6°, very slight cementation.

@67.5' B
 N24W/25NE
 Approx.

@72' B
 N75W/16SW

@77.5' B
 N63W/13SW

CLIENT: Pardee					PROJECT: Monasabian Property		W.O.: 8838
LOCATION: Santa Clarita					ELEVATION: 1554' ±		DATE: 9/11/02
RIG TYPE: Boyles 37 Core					HAMMER WEIGHTS: HX-HQ Coring		DROP: N/A
	N	U	R	M	DD	DESCRIPTION	ATTITUDES
70	C					@ 73.5-74.5', Gravel CONGLOMERATE, slightly cemented, clasts to matrix supported, friable in places, rounded gravel, angular to rounded, sand grains and granules.	
75						@ 74.5-76.5', Tan gravelly SANDSTONE, poorly sorted, weakly cemented.	
						@ 76-77.5', No recovery.	
						@ 77.5' - Black manganese oxide stained bedding plane.	
80						@ 77.5-81.5', Tan fine to medium grained SANDSTONE with scattered gravel, weakly cemented.	
						@ 79-80.2' - No recovery in tan poorly sorted sandstone with gravel.	
						@ 80.2-85.5', Yellowish gray dusky yellow and light olive gray fine to medium grained SANDSTONE with coarse grains and rounded gravel.	
						@ 85-85.7', No recovery.	
85						@ 85.5-90.5', Mottled yellow and gray CONGLOMERATE, subrounded gravel to pebble-size clasts, predominantly matrix supported, locally clast supported, possibly reworked Mint Canyon sediments.	
						@ 90.5' - <u>Mint Canyon Formation</u> : Light bluish gray and light brownish gray CONGLOMERATE, clasts to 2" diameter.	
						@ 91' - Slightly more cemented, hard.	
						@ 92.25-93', Gray gravelly SANDSTONE.	
						@ 93-93.8', Increasingly coarse grained with pebbles and cobbles.	
95						@ 93.8-94.25', Brownish gray silty CLAYSTONE ripup clast(?), very stiff, no shears.	
						@ 94' - Steeply dipping fracture.	
						@ 94.25-94.5', Greenish gray CONGLOMERATE of granules and fine gravel with matrix of fine grained silty SAND with clay.	
100						@ 94.5-95', Greenish gray with wavy laminations of brownish gray fine to medium grained SANDSTONE with gravel, dips of 10°, fractured filled with brownish gray clay (weathering).	
						@ 95-95.3', Same as above.	
						@ 95.9-100', Greenish gray CONGLOMERATE, fine to medium grained sand matrix, cemented.	
105						@ 96.8' - Sheared high angled dark bluish green gravel.	
						@ 97-100', Shearing and clay film development around hard granitic gravel clasts.	
						@ 99' - Near vertical fracture/shear with 3mm thick olive green clay film.	
110						@ 100-101.5', Olive green to olive gray CONGLOMERATE, nearly clast-supported.	
						@ 101.5-102.3', Greenish gray fine to medium grained SANDSTONE, cemented with 20° dip, laminations.	
115						@ 102.3'-105.1', Olive gray CONGLOMERATE, abundant clasts of weathered volcanics, very poorly sorted, weakly cemented.	@ 113.4' B N81W/28SW Approx.
ADDITIONAL COMMENTS:					T = Tricone C = Coring R = Recovery		

SURFACE DATA

LOG OF BORING B8 (4 of 6)

CLIENT: Pardee						PROJECT: Monasabian Property		W.O.: 8838
LOCATION: Santa Clarita						ELEVATION: 1554' ±		DATE: 9/11/02
RIG TYPE: Boyles 37 Core						HAMMER WEIGHTS: N/A HX-HQ Coring		DROP: N/A
	N	U	R	M	DD	DESCRIPTION		ATTITUDES
105	C					@ 104-105.3', No recovery. @ 105-107', Mottled gray gravel CONGLOMERATE, clayey silty soft matrix washed away, left few inches. @ 107-108', No recovery. @ 107-108.25', Light gray fine to medium grained SANDSTONE, weakly cemented.		
110						@ 108.25-110.25' - CONGLOMERATE, fine to coarse grained silty SAND with minor clay matrix to gravel with cobbles, cemented to soft. @ 108.3' - Pebble of porphyritic basalt. @ 110' - Cobble.		
115						@ 110.25-114.3', Light gray fine to medium grained SANDSTONE, fining upward sequence. @ 111-114.3', No recovery. @ 114.3-121.4', Greenish gray gravel to pebble CONGLOMERATE, matrix supported, locally clast supported.		
120						@ 116-117', No recovery. @ 117' - Matrix supported with silty poorly sorted sand, gravel to pebble size clasts of granitics, weak cementation. @ 117.75-118', No recovery. @ 119.5-120.5', No recovery.		
125						@ 122.5-123', Cobble of anorthosite. @ 122.6-123', No recovery. @ 123-124.5', Light greenish gray medium to coarse grained SANDSTONE, well cemented.		
130						@ 124' - Steep dipping fracture. @ 124-125', No recovery. @ 125.5' - Cobble of anorthosite. @ 126-129.3', Greenish gray sandy CONGLOMERATE.		
135						@ 127' - Light gray fine to medium grained sand matrix, well cemented. @ 128.5-129', No recovery. @ 129-129.3', Light gray gravelly SANDSTONE, cemented. @ 129.3-130.5', Boulder of anorthosite.		
140						@ 130-131', No recovery. @ 131-132', Light greenish gray gravelly SANDSTONE, locally cemented. @ 132-137', No recovery, in gravelly SANDSTONE to conglomeratic SANDSTONE.		
145						@ 137-139.4', Mottled gray CONGLOMERATE, locally clast supported, poorly sorted sand matrix, weakly cemented. @ 139.4-141', Greenish gray poorly sorted SANDSTONE with scattered subrounded gravel, well cemented, crude bedding, shallow dips.		@ 143.2' B N57W/39SW Approx.
150						@ 141-143', CONGLOMERATE, subrounded to rounded gravel and small pebble size clasts, clast supported, poor recovery. @ 143-145.1', Light greenish gray very fine to medium grained SANDSTONE, well cemented, laminations with dark iron oxide mineral grains and biotite. @ 145.1-145.2', Olive green SILTSTONE bed.		@ 145.4', B N59W/20SW @ 146.4' B N40W/35SW
ADDITIONAL COMMENTS:						T = Tricone C = Coring R = Recovery		

CLIENT: Pardee					PROJECT: Monasabian Property		W.O.: 8838
LOCATION: Santa Clarita					ELEVATION: 1554' ±		DATE: 9/12/02
RIG TYPE: Boyles 37 Core					HAMMER WEIGHTS: N/A HX-HQ Coring		DROP: N/A
	N	U	R	M	DD	DESCRIPTION	ATTITUDES
145	C					@ 145.2-145.7', Grades to silty very fine grained SANDSTONE, well cemented.	
						@ 145.7-146.3', Light olive green sandy SILTSTONE, cemented, massive, internal bedding.	
150						@ 146.3-148', Pebble CONGLOMERATE, poorly cemented, poorly sorted sand matrix, matrix supported.	
						@ 148-150.2', Mottled gray gravelly SANDSTONE with scattered pebbles, weakly cemented.	
						@ 150.2-153.5', Conglomeratic SANDSTONE.	
155						@ 153.5-154', Light olive gray tuffaceous fine to medium grained SANDSTONE, minor silt, weakly cemented.	
						@ 154-159', Cobble CONGLOMERATE, poorly sorted sand matrix, clast to matrix supported.	
						@ 159-163', No recovery in cobble CONGLOMERATE to sandy CONGLOMERATE.	
						@ 163.5-165', Greenish gray silty very fine grained SANDSTONE, cemented.	
165						@ 165.0-166.2', Greenish gray gravelly SANDSTONE, poorly cemented.	@ 165.06' B
						@ 166.2-167', No recovery.	N72W/16SW
						@ 167-167.7', Pebble CONGLOMERATE.	
						@ 167.7-168', Dark brown CLAYSTONE ripup clast, brittle, possible weathered volcanic clast.	
170						@ 168-168.3', Greenish gray pebble CONGLOMERATE.	
						@ 168.3-171', No recovery.	
						@ 171-174', Pebble to cobble CONGLOMERATE, weathered clasts of granitics and maroon volcanics, slightly friable, weakly cemented.	
						@ 173.5-175', No recovery.	
175						@ 174-175.2', Light greenish gray gravelly SANDSTONE, weak to moderate cementation.	@ 175.23' B
						@ 175-176', No recovery.	N14W/18SW
						@ 175.2-177', Dark gray very silty very fine grained SANDSTONE to sandy SILTSTONE, poorly cemented.	@ 175.71' B
180						@ 178.5-179.5', No recovery in gravelly SANDSTONE.	N41W/21SW
						@ 179.5-183', Gravel to pebble CONGLOMERATE, clast supported, uncemented.	@ 176.23' B
						@ 180.5-183', No recovery,	N43W/21SW
						@ 183-189', Mottled gray pebble CONGLOMERATE, matrix to clast supported, abundant subrounded gravel, locally well cemented zones, local clay film development and clasts of volcanics.	@ 176.75', B
185							N38W/43SW
							@ 178.43' B
							N62E/22NW Approx
							@ 179.1 B
							N2E/16NW
190						@ 189-194.2', Light gray gravelly SANDSTONE, well cemented.	
ADDITIONAL COMMENTS:							T = Tricone
							C = Coring
							R = Recovery

SURFACE DATA

LOG OF BORING B8 (6 of 6)

CLIENT: Pardee						PROJECT: Monasabian Property		W.O.: 8838
LOCATION: Santa Clarita						ELEVATION: 1554' ±		DATE: 9/13/02
RIG TYPE: Boyles 37 Core						HAMMER WEIGHTS: N/A HX-HQ Coring		DROP:
	N	U	R	M	DD	DESCRIPTION		ATTITUDES
190	C							
195						@ 194.2' - 5" cobble of gneiss. @ 194.8-197.5', Mottled dark gray to olive gray gravelly SANDSTONE, well bedded, very poorly sorted, weakly cemented. @ 197.5-200', Mottled gray and olive gray pebble CONGLOMERATE, matrix supported, weakly cemented.		@ 194.84' B N25W/16SW
200						@ 200-201', No recovery.		
205						Total Depth - 201' Groundwater at 120' on 10/1/02		
210								
215								
220								
225								
230								
235								
ADDITIONAL COMMENTS:						T = Tricone C = Coring R = Recovery		

Orientation Summary Table
BIPS Features
Santa Clarita Project, Boring 8 *
September 17, 2002

ATTITUDES CORRECTED +14 DEG. FOR MAGNETIC DECLINATION
FEATURES IN BOLD CONSIDERED BEDDING-RELATED

FEATURE DESCRIPTION	Feature No.	Depth (meters)	Depth (feet)	Strike and Dip Angle (degrees)	Feature Rank (0 to 5)	CORRECTED ATTITUDE
Gravel stringer	1	4.44	14.6	N 54W 34SW	0	N68W/ 34SW
Approx. Bedding	2	4.57	15.0	N 75W 47S	0	N89W/ 47SW
Cross Bedding	3	5.19	17.0	N 11W 54W	0	N25W/ 54SW
Gravel Lense	4	6.06	19.9	N 76E 26S	0	N62E/ 26SE
Approx. Bedding	5	10.95	35.9	N 63W 33S	0	N77W/ 33SW
Unknown	6	13.77	45.2	N 41W 12NE	0	N55W/ 12NE
Bottom of Gravel	7	14.27	46.8	N 68E 37N	0	N54E/ 37NW
Top of Gravel Lense	8	15.87	52.1	N 28E 18E	0	N14E/ 18SE
Top of Gravel Lense	9	16.85	55.3	N 79W 37N	0	N87E/ 37NW
Top of Gravel Lense	10	19.53	64.1	N 5E 25E	0	N9W/ 25NE
Bottom of Pebble	11	19.60	64.3	N 3E 30E	0	N11W/ 30NE
Approx. Top of Sandstone	12	20.57	67.5	N 10W 25E	0	N24W/ 25NE
Top of Boulder	13	21.38	70.1	N 8E 67W	0	N6W/ 67NE
Btm of Boulder	14	21.69	71.2	N 24W 25W	0	N38W/ 25SW
Top of Sandstone	15	21.93	72.0	N 61W 16S	0	N75W/ 16SW
Bottom of Pebble	16	22.10	72.5	N 42W 21NE	0	N56W/ 21NE
Stained Sandstone Bed	17	23.63	77.5	N 49W 13SW	1	N63W/ 13SW
Fracture	18	28.74	94.3	N 43W 71SW	2	N57W/ 12SW
Cobble	19	30.24	99.2	N 27W 24W	0	N41W/ 24SW
Fracture	20	33.34	109.4	N 13W 37W	0	N27W/ 37SW
Unknown	21	33.47	109.8	N 14W 32W	0	N28W/ 32SW
Sandstone Lamination	22	34.07	111.8	N 42W 12SW	0	N56W/ 12SW
Approx. Sandstone Channel	23	34.56	113.4	N 67W 28S	0	N81W/ 28SW
Bottom of Cobble	24	36.95	121.2	N 48W 38SW	0	N62W/ 38SW
Bottom of Cobble	25	37.54	123.2	N 68E 22N	0	N54E/ 22NW
Top of Cobble	26	39.48	129.5	N 26E 16E	0	N12E/ 16SE
Bottom of Cobble	27	39.78	130.5	N 74E 7S	0	N60E/ 7SE
Bottom of Pebble	28	43.53	142.8	N 48W 5SW	0	N62W/ 5SW
Approx. Top of Sandstone	29	43.64	143.2	N 43W 39SW	0	N57W/ 39SW
Laminated Sandstone	30	44.31	145.4	N 45W 20SW	0	N59W/ 20SW
Bottom of Sandstone	31	44.61	146.4	N 26W 35W	0	N40W/ 35SW
Bottom of Pebble	32	45.16	148.2	N 15W 52W	0	N29W/ 52SW
Bottom of Pebble	33	48.52	159.2	N 86W 22N	0	N80E/ 22NW
Unknown	34	49.70	163.1	N 77E 32S	0	N63E/ 32SE
Bottom of Sandstone	35	50.31	165.06	N 58W 16SW	0	N72W/ 16SW
Top of Sandstone	36	53.41	175.23	NS 18W	0	N14W/ 18SW
Laminated Sandstone	37	53.555	175.71	N 27W 21W	0	N41W/ 21SW
Laminated Sandstone	38	53.713	176.23	N 29W 21W	0	N43W/ 21SW
Bottom of Sandstone	39	53.872	176.75	N 24W 43W	0	N38W/ 43SW
Apprx. Gravelly Sandst.	40	54.384	178.43	N 76E 22N	0	N62E/ 22NW
Bottom of Clayey Sandstone	41	54.616	179.19	N 16E 16W	0	N2E/ 16NW
Unknown	42	54.635	179.25	N 64E 51N	0	N50E/ 51NW
Laminated Sandstone	43	59.384	194.84	N 9W 16W	0	N25W/ 16SW

directions are with respect to magnetic north.

Orientation Summary Table
BIPS Features
Santa Clarita Project, Boring 8
September 17, 2002

FEATURE DESCRIPTION	Feature No.	Depth (meters)	Depth (feet)	Strike and Dip Angle (degrees)	Feature Rank (0 to 5)	CORRECTED ATTITUDE
Laminated Sandstone	44	59.764	196.08	N 9W 14W	0	N25W/ 14SW

ATTITUDES CORRECTED +14 DEG. FOR MAGNETIC DECLINATION
 FEATURES IN **BOLD** CONSIDERED BEDDING-RELATED



SURFACE DATA

LOG OF BORING B9

CLIENT: Pardee Homes						PROJECT: Skyline Ranch		W.O.: 8838
LOCATION: Santa Clarita						ELEVATION: 1775'±		DATE: 10/21/03
RIG TYPE: Bucket Auger						HAMMER WEIGHTS: Kelly Bar Weights		DROP: 12"
	N	U	B	M	DD	DESCRIPTION		ATTITUDES
0						Terrace Deposits: Medium reddish brown silty SAND with abundant random gravels and occasional cobbles, dry, firm, massive.		
5								
10						@10' - <u>Saugus Formation</u> : Grades to fine to coarse grained silty SANDSTONE. @13-15' - Frequent graded interbeds of fine to coarse grained SANDSTONE with subrounded gravels, crudely graded.		
15	16	X	X	10.5	107.1	@16' - Fine to coarse grained SANDSTONE lenses, friable, scoured.		@17' Horizontal
20						@19' - Gray fine to coarse grained SANDSTONE with subrounded to rounded gravels and cobbles, and boulders (basal unit), friable, coarsening downward, slightly moist.		@20' B Approx. ±NS/5W
25								
30						@28' - <u>Mint Canyon Formation</u> : Sharp but scoured contact on light gray to white fine to coarse grained SANDSTONE with gravels and cobbles, slightly moist, very dense, massive, occasional black graded mineral laminations, cemented.		@30' B Approx. ±N35W/3SW
35	27	X	X	9.2	126.4	@32' - Grayish brown gravelly CONGLOMERATE, cemented, hard, with infrequent 12" thick fine to coarse grained SANDSTONE interbeds.		
40								@39' B Approx. ±N20E/5NW
45								
ADDITIONAL COMMENTS:						Blows for 12" using California Split Barrel Sampler Kelly Bar Weights: 0 - 24', 2800 lbs. 25 - 47', 1800 lbs. 48 - 74', 800 lbs.		

SURFACE DATA

LOG OF BORING B9

CLIENT: Pardee Homes						PROJECT: Skyline Ranch		W.O.: 8838
LOCATION: Santa Clarita						ELEVATION: 1775'±		DATE: 10/12/03'
RIG TYPE: Bucket Auger						HAMMER WEIGHTS: Kelly Bar Weights		DROP: 12"
	N	U	B	M	DD	DESCRIPTION		ATTITUDES
40								
45		X		6.5	115.8			
50								
55								@54' B Approx. ±N45E/10NW
60	X			7.3	116.3			@57' - Light gray brown fine to coarse grained SANDSTONE with gravels, cemented, massive, crudely graded, slightly moist, infrequent graded black mineral laminations. @58' B Approx. ±N35E/3NW
65			X					@61' - Coarsening to gravelly CONGLOMERATE with cobbles and some boulders, massive, dense, cemented, slightly moist. @61' B Approx. ±N37E/5NW
70								@67' - Scoured contact on olive brown fine grained SANDSTONE, massive, cemented, very hard, slightly moist.
75								@72' - Conglomerate, very difficult drilling. Refusal at 73'. Total Depth - 73' No groundwater Backfilled
80								
85								

ADDITIONAL COMMENTS: Blows for 12" using California Split Barrel Sampler
 Kelly Bar Weights: 0 - 24', 2800 lbs.
 25 - 47', 1800 lbs.
 48 - 74', 800 lbs.

SURFACE DATA

LOG OF BORING B10

CLIENT: Pardee Homes						PROJECT: Skyline Ranch		W.O.: 8838
LOCATION: Santa Clarita						ELEVATION: 1785'±		DATE: 10/24/03
RIG TYPE: Bucket Auger						HAMMER WEIGHTS: Kelly Bar Weights		DROP: 12"
	N	U	B	M	DD	DESCRIPTION		ATTITUDES
0						Topsoil: Dark brown sandy CLAY with frequent coarse grains and small gravels, dry, dessication cracks.		
5						@3' - Terrace Deposits: Dark reddish brown clayey silty SAND with abundant coarse grains and gravels, frequent scattered cobbles, slightly moist to dry, firm, infrequent carbonate veinlets to 12'. Abundant cobbles from 6-8'.		
10								
15	13	X			10.0	128.8	@12' - Saugus Formation: Increasing medium reddish brown and medium brown fine to coarse grained slightly silty SANDSTONE with abundant gravels and cobbles, locally well graded, slightly moist, moderately friable.	@16' Contact ±N55E/7SE Approx.
20			X				@19' - Abundant cobbles and boulders with graded clayey fine to coarse sandy matrix, moist. @20' - Medium brown slightly clayey silty fine grained SANDSTONE to slightly clayey fine grained sandy SILTSTONE, moist, dense/stiff, frequent white carbonate veinlets.	@23' B ±N48E/22SE Approx.
25							@22' - Scoured and channeled contact on graded fine to coarse grained SANDSTONE and gravel with thin graded black mineral laminations, friable, coarsening to subround gravels and cobbles at 25'. @25' - Reddish brown fine to coarse grained SANDSTONE, graded with slightly silty matrix, gravelly lenses, moist, slightly friable.	@25' Horizontal
30	45	X			13.6	116.6	@28' - Irregular contact on olive gray slightly clayey fine grained SAND, gravelly CONGLOMERATE with abundant coarse grains and random scattered gravels, moist, massive, dense, coarsening to gravelly and cobbly CONGLOMERATE with depth. @33' - Brown graded fine to coarse grained SANDSTONE with gravels and cobbles, slightly moist to dry, friable.	@33' B ±N50W/6SW Approx.
35							@36' - Mint Canyon Formation: Light gray fine to coarse grained SANDSTONE and gravelly cobbly CONGLOMERATE, dry, massive, cemented, very hard.	@36' B ±N63E/17SE Approx.
40								@42' B ±N15W/6SW Approx.
45								
ADDITIONAL COMMENTS:						Blows for 12" using California Split Barrel Sampler Kelly Bar Weights: 0 - 24', 2800 lbs. 25 - 47', 1800 lbs. 48 - 74', 800 lbs.		

SURFACE DATA

LOG OF BORING B10

CLIENT: Pardee Homes					PROJECT: Skyline Ranch		W.O.: 8838
LOCATION: Santa Clarita					ELEVATION: 1785±		DATE: 10/24/03
RIG TYPE: Bucket Auger					HAMMER WEIGHTS: Kelly Bar Weights		DROP: 12"
	N	U	B	M	DD	DESCRIPTION	ATTITUDES
40							
45	35	X		15.2	112.1		
50							@47' B ±N15W/14SW Approx.
55			X			@51' - Scoured contact on light olive gray fine grained SANDSTONE, massive, cemented, slightly moist, very hard.	
55						@55' - Gray gravelly CONGLOMERATE with cobbles, with fine to coarse sand matrix, massive, slightly moist to dry, cemented, hard.	@55' Contact ±N15E/10NW Approx.
60	80	X				@58' - Light gray fine grained SANDSTONE with graded black mineral laminations, minor faulting (less than 1/2" reverse displacement of black laminations). @59-71' - Light gray gravelly/cobbly CONGLOMERATE, cemented, hard, massive, with sandstone interbeds.	@58.5' B ±N17W/8SW Approx.
65						@64.5-65.5' - Light gray medium grained SANDSTONE, slightly moist, massive, very dense, cemented.	@65.5' B ±NS/12W Approx.
70						@67-68' - Light gray medium grained SANDSTONE, slightly moist, massive, very dense, cemented. @69-70' - Light gray medium grained SANDSTONE, slightly moist, massive, very dense, cemented.	
75						Total Depth - 71' No groundwater Backfilled	
80							
85							

ADDITIONAL COMMENTS: Blows for 12" using California Split Barrel Sampler
 Kelly Bar Weights: 0 - 24', 2800 lbs.
 25 - 47', 1800 lbs.
 48 - 74', 800 lbs.

SURFACE DATA

LOG OF BORING B11

CLIENT: Pardee						PROJECT: Skyline Ranch						W.O.: 8838											
LOCATION: Santa Clarita						ELEVATION: 1910'						DATE: 10/30/03											
RIG TYPE: Bucket Auger						HAMMER WEIGHTS: Kelly Bar						DROP: 12"											
	N	U	B	M	DD	DESCRIPTION												ATTITUDES					
0						<p>Colluvium: Reddish brown silty clayey SAND with scattered coarse grains and infrequent gravels, firm, moist to 2.5', then becoming dry, increasing silt content with depth to slightly clayey silty SAND.</p> <p>@4.5-6.5' - Frequent white carbonate infills of veinlets.</p>																	
5						<p>Saugus Formation:</p> <p>@5.5' - Coarsening to reddish brown gravelly silty sandy CONGLOMERATE, dry, moderately cemented, very dense, poorly graded.</p> <p>@8' - Light orange brown silty fine to coarse grained SAND with infrequent small gravels, dry, dense, massive, with occasional poorly graded coarse grained lenses.</p> <p>@11' - Coarsening to include frequent gravels and occasional cobbles.</p> <p>@13' - Fining to dark yellowish olive brown slightly silty fine to coarse grained SANDSTONE with occasional cobbles and scattered gravels, slightly moist, massive, dense.</p>												@10' B Approx. N3E/17NW					
10																		@13' B Approx. N5E/10NW					
15	40	X	X	4.0	133.8	<p>@15' - Mint Canyon Formation (?): Coarsening to gravelly CONGLOMERATE, cemented, very hard.</p>																	
20																							
25																							
30	35	X		6.6	118.9	<p>@27' - Olive yellow brown gravelly SANDSTONE, with occasional black mineral laminations, moist.</p> <p>@30' - Coarsening to sandy gravelly CONGLOMERATE with frequent cobbles, cemented, massive, hard.</p> <p>@33' - Gravelly medium to coarse grained SANDSTONE, moist, cemented, hard, massive.</p> <p>@36' - Cobbles.</p> <p>@42' - Cobbles and boulders to 44'.</p>												@29.5' B Approx. N35W/16SW					
35																							
40																							
45																							

ADDITIONAL COMMENTS:

Blows for 12" using California Split Barrel Sampler
 Kelly Bar Weights: 0 - 24', 2800 lbs.
 25 - 47', 1800 lbs.
 48 - 70', 800 lbs.
 71 - 95', 500± lbs.

SURFACE DATA

LOG OF BORING B11

CLIENT: Pardee						PROJECT: Skyline Ranch		W.O.: 8838
LOCATION: Santa Clarita						ELEVATION: 1910'		DATE: 10/30/03
RIG TYPE: Bucket Auger						HAMMER WEIGHTS: Kelly Bar		DROP: 12"
	N	U	B	M	DD	DESCRIPTION		ATTITUDES
40								
45	50	X		8.0	118.5	@44' - Gravelly CONGLOMERATE. @46' - Abundant cobbles and boulders.		@45' B Approx. N8E/14NW
50						@49' - Fine to coarse grained SANDSTONE with small gravelly lenses. @51' - Abundant boulders. @52' - Dark yellowish brown gravelly CONGLOMERATE with frequent cobbles and boulders, abundant iron staining.		@50' Fault N35W/13SW
55						@56' - Gravelly SANDSTONE to gravelly CONGLOMERATE, slightly moist, cemented, dense.		
60	50	X		7.2	113.2	@60' - Gray gravelly CONGLOMERATE with frequent cobbles, slightly moist, massive, cemented, hard. @62' - Fault with ±2" reversal movement, abundant iron staining.		@63' B Approx. N40W/13SW
65						@67' - Gravelly CONGLOMERATE with frequent cobbles.		
70						@73' - Gray gravelly cobbly CONGLOMERATE with frequent cobbles and boulders.		
75	30	X		11.9	119.7	@77' - 6" gray fine to coarse grained SANDSTONE, moist.		@77' B Approx. N5W/12SW
80						@83' - Total Depth - 83' No groundwater Backfilled		
85						ADDITIONAL COMMENTS: Blows for 12" using California Split Barrel Sampler Kelly Bar Weights: 0 - 24', 2800 lbs. 25 - 47', 1800 lbs. 48 - 74', 800 lbs. 75 - 95', 500± lbs.		

SURFACE DATA

LOG OF BORING B12

CLIENT: Pardee						PROJECT: Skyline Ranch		W.O.: 8838
LOCATION: Santa Clarita						ELEVATION: 2005'		DATE: 11/13/03
RIG TYPE: Bucket Auger						HAMMER WEIGHTS: Kelly Bar		DROP: 12"
	N	U	B	M	DD	DESCRIPTION		ATTITUDES
0						@0-3' - Dozer fill for drilling pad, sand with scattered pebbles, cobbles and gravel. <u>Mint Canyon Formation</u> : Pebble-cobble CONGLOMERATE, massive, poorly sorted, channel deposits, subrounded to subangular clasts (commonly 6" diameter) consisting of quartz, granodiorite, metamorphics (derived from San Gabriel Mountains), moderately cemented, gray brown fine to medium sand matrix (matrix supported), very dense, slightly dry.		
5								
10						@10' - Clasts commonly 6"-24" diameter. @12' - Base of cobble bed (channel).		@8' - Approx. BN50E/25NW @12' - Approx. BN70W/20SW
15	15	X		3.0	121.3			
20	20	X		15.2	108.6			
25						@21' - Base of cobble channel.		@21' - Approx. BN10E/20E @22' - Approx. BdueE/18N
30						Total Depth - 27' No groundwater Backfilled		
35								
40								
45								

ADDITIONAL COMMENTS: Blows for 12" using California Split Barrel Sampler
 Kelly Bar Weights: 0 - 24', 2800 lbs.
 25 - 47', 1800 lbs

SURFACE DATA

LOG OF BORING B13

CLIENT: Pardee						PROJECT: Monasabian		W.O.: 8838
LOCATION: Santa Clarita						ELEVATION: 2160±		DATE: 11/19/03
RIG TYPE: Bucket Auger						HAMMER WEIGHTS: Kelly Bar		DROP: 12"
	N	U	B	M	DD	DESCRIPTION		ATTITUDES
0						<p>Colluvium: Medium dark olive brown silty sandy CLAY with abundant coarse sands and small gravels, upper 8" dessicated, stiff, slightly moist.</p> <p>@3' - Increasing sand content and gravels, some krotovina, medium dense to medium soft.</p>		
5						<p>@5-8' - Large soft calcium carbonate nodules/pods, horizontal veins and veinlets.</p>		
10						<p>@6' - <u>Weathered Mint Canyon Formation</u>: Olive brown silty SAND to sandy SILT with frequent subrounded gravels and occasional cobbles.</p> <p>@9' - Light gray well graded slightly crossbedded fine to coarse grained SAND and subrounded to rounded gravels and cobbles, increasing cobbles and boulders to 12', slightly moist to dry, tightly packed but friable, prone to caving, abundant white carbonate coatings on gravels and cobbles to 15' depth.</p>		
15		20	X			<p>@12-14' - <u>Mint Canyon Formation</u>: Olive gray silty fine grained SANDSTONE, massive, speckled with white carbonates, frequently scattered coarse sands.</p> <p>@15' - 4" silty SAND interbed with white carbonate staining.</p>		<p>@15' B Approx. N45W/7SW</p> <p>@17' B Approx. N5E/11SE</p>
20						<p>@19' - Coarsening to include rounded cobbles and boulders with infrequent wavy, scoured silty lenses.</p>		
25						<p>@27' - 12" scoured red brown sandy clayey SILT, wavy, discontinuous bed, massive, slightly moist.</p>		@23' B Approx. N15E/7SE
30		60	X			<p>@28' - Yellowish to orangish brown fine to medium grained SANDSTONE with coarse and small gravels, moderately well graded, dense, moderately well cemented.</p> <p>@29' - Coarsening to rounded cobbles and boulders - CONGLOMERATE</p>		
35								
40						<p>Total Depth - 33' (Refusal on boulders/cobbles) Backfilled</p>		
45								
ADDITIONAL COMMENTS:						<p>Blows for 12" using California Split Barrel Sampler</p> <p>Kelly Bar Weights: 0 - 24', 2800 lbs.</p> <p>25 - 47', 1800 lbs</p>		

SURFACE DATA

LOG OF BORING B14

CLIENT: Pardee					PROJECT: Skyline Ranch		W.O.: 8838
LOCATION: Santa Clarita					ELEVATION: 2000'		DATE: 11/25/03
RIG TYPE: Bucket Auger					HAMMER WEIGHTS: Kelly Bar		DROP: 12"
	N	U	B	M	DD	DESCRIPTION	ATTITUDES
0						Mint Canyon Formation: Olive brown to dark gray CONGLOMERATE, gravelly and cobbly with occasional boulders with slightly clayey fine to coarse sand matrix, cemented, very hard, dry, massive.	
5						@4-5' - Fine to medium grained SANDSTONE with scattered gravels, massive, cemented, very hard, dry. @5' - Boulders.	@5' B N5W/25SW
10						@9' - Boulders.	
15	16	X	X	7.1	121.9	@15' - Sharp, scoured (south side) contact on olive brown micaceous fine grained SANDSTONE to silty SANDSTONE, massive, very dense, slightly moist. @17' - Coarsening to olive gray to gray gravelly, cobbly CONGLOMERATE with fine to coarse sand matrix.	@15' B N25W/25SW
20						@18' - Boulders. @20' - Heavy black (manganese) staining on gravels and within matrix. @22' - Boulders.	@20' B Approx. N55E/30SE
25						@26' - Abundant boulders with weathering rinds/coatings of olive gray CLAY matrix with minor black staining.	
30	55	X	X	11.1	120.4	@29' - Olive gray medium to coarse grained SANDSTONE with infrequent scattered gravels, massive, slightly moist, cemented, very dense to hard. @32' - Boulders.	@29' B Approx. N50W/22SW
35						Total Depth - 33' (refusal on boulders) No groundwater Backfilled	
40							
45							

ADDITIONAL COMMENTS: Blows for 12" using California Split Barrel Sampler
 Kelly Bar Weights: 0 - 24', 2800 lbs.
 25 - 47', 1800 lbs

SURFACE DATA

LOG OF BORING B15

CLIENT: Pardee Homes						PROJECT: Skyline Ranch		W.O.: 8838	
LOCATION: Santa Clarita						ELEVATION: 1990'±		DATE: 12/2/03	
RIG TYPE: Bucket Auger						HAMMER WEIGHTS: Kelly Bar		DROP: 12"	
	N	U	B	M	DD	DESCRIPTION		ATTITUDES	
0						<p><u>Saugus Formation</u>: Reddish slightly clayey SANDSTONE, occasional roothairs, some carbonate staining, very dense, hard, dry, massive.</p> <p>@1' - Coarsening to light orangish brown fine to coarse grained SANDSTONE and gravels with occasional cobbles, subrounded to subangular, dry, moderately well graded, dense, massive.</p>			
5						<p>@2.5' - Gravels mixed at contact on reddish brown sandy clayey MUDSTONE with frequent scattered coarse sands with occasional gravelly lens, very hard, massive, dry.</p> <p>@7.5' - Olive brown fine to coarse grained silty SANDSTONE, poorly graded to crudely graded, dry, slightly friable, very dense, cross-channeled.</p>		@4' B Approx. N52E/25SE	
10						<p>@10' - Medium brown slightly clayey sandy MUDSTONE with frequent coarse grains and occasional sandy lenses, slightly moist, very dense to hard, massive.</p>		@10' B Approx. N13W/30SW	
15	22	X		8.5	131.6	<p>@15' - Medium to reddish brown slightly clayey silty SANDSTONE to silty clayey SANDSTONE with abundant coarse grains, subangular to angular gravels increasing in size to cobbles with depth.</p> <p>@18' - Mixed contact on red brown slightly sandy CLAYSTONE to clayey SANDSTONE, occasional coarse grains and small gravels, moist.</p>		@14' B Approx. N25E/20NW	
20						<p>@20' - Grades to yellow brown fine to coarse grained gravelly SANDSTONE, poorly graded, slightly moist, dense, massive.</p> <p>@23' - Grades to yellow brown fine to coarse grained SANDSTONE, massive.</p>		@18' B Approx. N37E/13NW	
25						<p>@25' - Grades to fine to coarse grained gravelly SANDSTONE, massive, poorly to crudely graded lenses, massive, dense.</p> <p>@27' - Coarsening to fine to coarse grained gravelly CONGLOMERATE, massive, coarsening with depth.</p>		@25' B Approx. N15W/28SW	
30	45	X		6.6	128.9	<p>@29' - Yellow brown fine to coarse grained SANDSTONE with frequent small gravels.</p> <p>@31' - Coarsening to yellow brown fine to coarse grained gravelly CONGLOMERATE with cobbles and boulders at base of sequence, poorly graded, dense, massive.</p>		@29' B Approx. N18W/13SW	
35						<p>@33' - <u>Mint Canyon Formation</u>: Fining to yellow brown fine to medium grained SANDSTONE, dense, massive.</p> <p>@34' - Gravel and cobble lens.</p>		@34' B Approx. N15W/18SW	
40						<p>@36' - Coarsening to fine to coarse grained gravelly SANDSTONE, massive, dense.</p> <p>@37' - Coarsening to yellow fine to coarse grained gravelly CONGLOMERATE with cobble lenses, very hard, massive, poorly graded.</p> <p>@40' - Coarsening to gravelly/cobbly CONGLOMERATE.</p>			
45						<p>@43' - Coarse sandy gravelly CONGLOMERATE with black manganese staining.</p>		@43' B Approx. N13W/7SW	
ADDITIONAL COMMENTS:						Blows for 12" using California Split Barrel Sampler Kelly Bar Weights: 0 - 24', 2800 lbs. 25 - 47', 1800 lbs. 48 - 74', 800 lbs.			

SURFACE DATA

LOG OF BORING B15

CLIENT: Pardee Homes					PROJECT: Skyline Ranch		W.O.: 8838
LOCATION: Santa Clarita					ELEVATION: 1990±		DATE: 12/2/03
RIG TYPE: Bucket Auger					HAMMER WEIGHTS: Kelly Bar		DROP: 12"
	N	U	B	M	DD	DESCRIPTION	ATTITUDES
40							
45	45	X		4.9	125.3	@45' - Pale yellow brown fine grained SANDSTONE with gravels coarsening to fine to coarse grained SANDSTONE with gravels, massive, very hard, poorly graded. @49-55' - Frequent scattered subrounded to subangular cobbles.	@48' B Approx. N15W/6SW
50							
55						@55' - Graded to gravelly CONGLOMERATE, very dense, massive, crudely graded coarse sands. @56' - Black manganese staining. @58' - Coarsening to cobbly CONGLOMERATE.	@57' B Approx. N28W/13SW
60	80	X		8.6	121.1	@60' - Boulders. @63' - Gravelly CONGLOMERATE. @64' - Pale yellow brown fine grained SANDSTONE with scattered coarse grains. @65' - Orange brown gravelly CONGLOMERATE.	@65' B Approx. N8E/26NW
65							
70						@69' - Boulders.	
75						Total Depth - 70' (Refusal on boulders) No groundwater Backfilled	
80							
85							

ADDITIONAL COMMENTS: Blows for 12" using California Sampler
 Kelly Bar Weights: 0 - 24', 2800 lbs.
 25 - 47', 1800 lbs.
 48 - 74', 800 lbs.

SURFACE DATA

LOG OF BORING B16

CLIENT: Pardee Homes						PROJECT: Skyline Ranch		W.O.: 8838	
LOCATION: Santa Clarita						ELEVATION: 2045'±		DATE: 12/4/03	
RIG TYPE: Bucket Auger						HAMMER WEIGHTS: Kelly Bar		DROP: 12"	
	N	U	B	M	DD	DESCRIPTION		ATTITUDES	
0						<p>Saugus Formation: Light reddish brown clayey SANDSTONE, massive, dry, fractured in upper 12".</p> <p>@3' to 4' - Gray fine to coarse grained SANDSTONE lens.</p> <p>@4' - Dark red sandy CLAYSTONE with frequent coarse grains and small gravels, cemented, fractured, massive, slightly moist, very dense, randomly oriented fractures and internal shearing, no slickensides, some black manganese staining.</p> <p>@5' to 6' - Abundant white carbonate fracture infills.</p>		<p>@3' Joint N25W/62SW</p>	
5									
10						<p>@11' - Grading to medium brown silty clayey SANDSTONE with frequent coarse grains, very dense, massive.</p> <p>@13' - Grades to gray silty to fine to coarse grained SANDSTONE coarsening to gravels and occasional cobbles at base of sequence, dense, weakly cemented.</p>		<p>@9' B N50E/34SE @11' Joint N65W/80NE</p>	
15	7	X		17.6	110.2	<p>@15' - Slightly scoured, sharp contact on reddish brown CLAYSTONE.</p> <p>@15.5 to 16' - Dark red CLAYSTONE, randomly sheared, moist, medium stiff.</p> <p>@16' - Dark red CLAYSTONE grading to clayey SANDSTONE, some fractures, dense, massive, slightly moist.</p> <p>@18' - Pale red brown slightly clayey silty SANDSTONE, massive, occasional coarse sand pockets, grading to fine to coarse grained gravelly SANDSTONE near base of sequence, dry, dense.</p>		<p>@15' B N53W/13SW @16' B N50W/27SW</p>	
20						<p>@21' - Medium red brown clayey SANDSTONE and sandy CLAYSTONE interbeds, abundant fine to medium sands with frequent coarse grains and infrequent gravels, dry, poorly to moderately bedded.</p> <p>@24' - Coarsening to include sandy gravelly sequences interbedded with sandy CLAYSTONE to clayey SILTSTONE interbeds.</p>		<p>@23' B Approx. N20E/16SE</p>	
25						<p>@26' - Dark red clayey SANDSTONE with abundant coarse grains, fractured on scoured contact.</p> <p>@27' - Light reddish brown slightly clayey silty SANDSTONE, massive, dense.</p>		<p>@26' B Approx. N45E/6NW</p>	
30	15	X		14.4	119.5	<p>@30' - Reddish brown clayey SANDSTONE with frequent coarse grains becoming coarser grained from 32-33'.</p> <p>@31.5' - Thin (less than 1/8") dark red clay seam, wavy, flat-lying, moist.</p> <p>@33' - Light orange brown silty SANDSTONE, massive, slightly moist, coarsening to fine to coarse grained silty SANDSTONE at base of sequence.</p>		<p>@35' B N15W/7SW</p>	
35						<p>@35' - Light orange brown silty SANDSTONE with frequent coarse grained, small gravelly lenses, dry to slightly moist.</p> <p>@37' - 3" dark red brown wavy clay bed, flat-lying, moist, random internal shears, moderately soft over dark red sandy CLAYSTONE with abundant coarse grains.</p>		<p>@40' B N12W/6SW</p>	
40						<p>@38' - Grades to pale red brown clayey SANDSTONE with abundant coarse grains and small gravels with infrequent tan clayey or silty interbeds.</p>			
45									
ADDITIONAL COMMENTS:						<p>Blows for 12" using California Split Barrel Sampler Kelly Bar Weights: 0 - 24', 2800 lbs. 25 - 47', 1800 lbs. 48 - 70', 800 lbs. 71 - 95', 500 lbs.</p>			

SURFACE DATA

LOG OF BORING B16

CLIENT: Pardee Homes		PROJECT: Skyline Ranch					W.O.: 8838
LOCATION: Santa Clarita		ELEVATION: 2045±					DATE: 12/4/03
RIG TYPE: Bucket Auger		HAMMER WEIGHTS: Kelly Bar					DROP: 12"
	N	U	B	M	DD	DESCRIPTION	ATTITUDES
40							
						@ 42' - Grading to interbedded pale red fine to coarse grained silty SANDSTONE and fine grained silty SANDSTONE, slightly moist, dense.	@ 43' B
						@ 44' - Reddish gray fine to coarse grained SANDSTONE and gravels on scoured contact.	N43W/9SW
45	20	X		6.4	125.5	@ 46' - Reddish brown sandy CLAYSTONE to clayey SANDSTONE with frequent coarse grains, moist, dense, massive.	
						@ 47.5' - Dark red CLAYSTONE with frequent coarse grains underlain by reddish gray fine to coarse grained gravelly SANDSTONE with dark red claystone interbeds.	@ 48.5' B
			X			@ 48' - Dark red clay bed, wavy, soft, moist.	N55W/10SW
						@ 49' - Dark red sandy CLAYSTONE with frequent coarse grains, moist, massive, stiff-hard.	
						@ 53' - Coarsening to clayey fine to coarse grained slightly clayey SANDSTONE with gravels.	
50						@ 55' - Gradational sequences of reddish clayey sandy micaceous SILTSTONE, massive, moist.	
						@ 56' - Grades to silty slightly sandy CLAYSTONE, some random internal slicks, frequent coarse grains and coarse grained gravelly lenses, moist, massive.	@ 60' B
						@ 60' - Thin (less than 1/8") dark red clay seam, moist, soft.	N30W/13SW
						@ 64' - Coarsens to reddish clayey fine to coarse grained SANDSTONE with gravels and red sandy CLAYSTONE interbeds, frequent coarse grains, moist, dense.	
55						@ 66' - Grades to gray fine to coarse grained gravelly SANDSTONE, crudely to poorly graded, slightly moist to dry, weakly cemented.	
						@ 71.5' - Sharp contact on reddish brown slightly clayey silty SANDSTONE, moist, massive.	@ 71.5' B
						@ 74' - Grayish orange coarse grained gravelly SANDSTONE to sandy CONGLOMERATE, fine grained sand matrix, dry, moderately cemented, dense.	N10W/15SW
						@ 77' - Scoured/channeled dark red silty CLAYSTONE with random shears, no slickensides on less than 1/8" clay surfaces, moist.	@ 76' B
	23	X	X	14.4	119.4	@ 80' - 4" dark red sheared CLAYSTONE bed, moist.	N61W/10NE
						@ 80' - Grayish gravelly CONGLOMERATE with fine grained SANDSTONE interbeds, dry, hard.	@ 80' B
			X			@ 82' to 83' - Boulders.	N58W/21SW
						@ 83' - Coarsening to cobbly CONGLOMERATE.	
80							
85							
ADDITIONAL COMMENTS:		Blows for 12" using California Split Barrel Sampler Kelly Bar Weights: 0 - 24', 2800 lbs. 25 - 47', 1800 lbs. 48 - 70', 800 lbs. 71 - 95', 500 lbs.					

SURFACE DATA

LOG OF BORING B16

CLIENT: Pardee Homes						PROJECT: Skyline Ranch		W.O.:8838
LOCATION: Santa Clarita						ELEVATION: 2045'±		DATE: 12/4/03
RIG TYPE: Bucket Auger						HAMMER WEIGHTS: Kelly Bar		DROP:12"
	N	U	B	M	DD	DESCRIPTION		ATTITUDES
80								
85								
90	40	X	X	15.2	121.3	@89' - Olive gray fine grained SANDSTONE, very well cemented, very hard, sharp flat underlying contact. @93' - Gray cobbly CONGLOMERATE.		
95						Total Depth - 97' No groundwater Backfilled		
100								
105								
110								
115								
120								
125								

ADDITIONAL COMMENTS: Blows for 12" using California Split Barrel Sampler
 Kelly Bar Weights: 0 - 24', 2800 lbs.
 25 - 47', 1800 lbs.
 48 - 70', 800 lbs.
 71 - 95', 500 lbs.

CLIENT: Pardee Homes					PROJECT: Skyline Ranch			W.O.: 8838
LOCATION: Santa Clarita					ELEVATION: 2120'±			DATE: 11/25/03
RIG TYPE: Core HQ-NQ2					HAMMER WEIGHTS: N/A			DROP: N/A
R	U	B	RQD	Graphics	DESCRIPTION			ATTITUDES
0					<p><u>Saugus Formation</u>: Weathered light reddish brown fine to coarse grained SANDSTONE and pebble-cobble CONGLOMERATE weathered to sandy CLAY, slightly stiff, moist.</p> <p>@2' - Light red brown pebble-cobble CONGLOMERATE, dense, moist, weakly cemented, light red brown clayey fine to coarse sandy matrix, poorly sorted, subround to subangular clasts from 1" to 6" diameter.</p> <p>@3' - Red brown gravelly clayey fine to medium grained SANDSTONE, dense, moist, weakly cemented, well sorted fine gravel.</p> <p>@9' - Tan light brown fine to coarse grained SANDSTONE and pebble-cobble boulder CONGLOMERATE, dense, slightly moist, weakly cemented to friable, near vertical black mineral precipitation from 9-10' through sandstone.</p> <p>@15' - Interbedded light brown fine to coarse grained SANDSTONE and pebble-cobble CONGLOMERATE.</p> <p>@20' - Interbedded light red brown fine to coarse grained SANDSTONE and pebble-cobble-boulder CONGLOMERATE, dense, slightly moist, friable to weakly cemented,</p> <p>@25' - Pebble CONGLOMERATE, probably very friable (no fines, only clasts without any matrix, matrix washed out by rig).</p> <p>@28.5' - Grades to red brown clayey fine grained SANDSTONE, very dense, slightly moist, moderately cemented.</p> <p>@30' - Pebble CONGLOMERATE, moderately well sorted, moderately cemented, relatively "sparse" (80% matrix supported) in a red brown very fine sandy matrix, very dense, slightly moist.</p> <p>@33' - Interbedded red brown fine grained sandy CLAYSTONE (thinly bedded), hard, slightly moist, and red brown clayey fine grained SANDSTONE with minor pebble beds, thinly bedded, moderately well cemented, very dense, slightly moist.</p> <p>@36.5' and 37' - 1" thick CLAYSTONE, sheared, hard, slickensides oriented oblique to pebble beds (commonly 1" thick) in clayey fine grained SANDSTONE.</p> <p>@40.5' - Interbedded pebble CONGLOMERATE, up to 6" thick, poorly sorted, moderately well cemented, and red brown fine grained SANDSTONE with gravelly beds, moderately well cemented, very dense, slightly moist.</p>			
5	100%		85%					
10								
15	10%		10%					
20								
25	75%		30%					
30								
35	100%		78%					
40								
45								

@16.9' Fracture
N53E/66NW
@18.5' Fracture
N79E/46NW

@23.8' Fracture
N34E/86SE

@45.1' ANX
BN 79W/43SW

ADDITIONAL COMMENTS:

R = Recovery
RQD = Rock Quality Designation
Attitudes from downhole camera optical logging

SURFACE DATA

LOG OF BORING B17

CLIENT: Pardee Homes					PROJECT: Skyline Ranch			W.O.: 8838	
LOCATION: Santa Clarita					ELEVATION: 2120±			DATE: 11/25/03	
RIG TYPE: Core HQ-NQ2					HAMMER WEIGHTS: N/A			DROP: N/A	
	R	U	B	RQD	Graphics	DESCRIPTION			ATTITUDES
40									
45	80%			46%					@45.8' Approx. Channel N79W/38NE
50							@48' - Light brown silty fine to coarse grained SANDSTONE, friable, loose, moist, underlain by pebble-cobble-boulder CONGLOMERATE.		@48.7' Approx. B N54E/37NW
55	100%			91%			@50' - Brown silty very fine grained SANDSTONE, dense, moist, weakly indurated.		@50.6' B N71W/27NE
60							@51' - Grades to pebble CONGLOMERATE, poorly sorted, poorly bedded, moderately well cemented, in a brown fine to coarse sandy matrix, very dense, slightly moist.		
65	90%			85%			@53' - Grades to red brown fine grained SANDSTONE with minor pebble beds, moderately well cemented, very dense, slightly moist.		
70							@55.5' - Grades to pebble CONGLOMERATE, moderately well cemented, well sorted, in a red brown fine sandy matrix, very dense, slightly moist.		
75	60%			49%			@57' - 6" thick cobble bed.		
80							@57.5' - Grades to red brown clayey very fine grained SANDSTONE, moderately well cemented, very dense, slightly moist.		
85							@60.5' - 6" thick fine grained cobble bed.		
							@60' to 65' - Interbedded fine to coarse grained SANDSTONE and fine grained pebble CONGLOMERATE, moderately well sorted, moderately well cemented, very dense, slightly moist.		
							@61.5' - 6" thick interbed of tan light brown gravelly coarse grained SANDSTONE, friable, loose, moist.		@67.7' Fracture N44E/54NW
							@65' to 69' - Red brown coarse grained gravelly CONGLOMERATE grading into red brown clayey fine grained SANDSTONE at 66.5'.		@68.1' Approx. Channel N74E/39SE
							@70' - Pebble CONGLOMERATE in a gravelly coarse sandy matrix, friable, loose (saturated by drilling fluid).		@72' B N19W/19NE
							@71' - Matrix becomes fine to coarse grained, weakly cemented, dense, slightly moist.		
							@71.5' - Matrix likely gravel and coarse sand (0-5% recovery to 75').		@75.3' B N88E/30NW
							@76.5' - Pebble CONGLOMERATE in a red brown gravelly coarse sandy matrix, weakly cemented, very dense, slightly moist.		
							@77.5' - Grades to red brown clayey fine grained SANDSTONE with gravel and very clayey fine grained SANDSTONE interbeds, very thin, very dense, moist.		
							@81.5' - 1-3cm thick red brown CLAYSTONE, soft.		@81.1' Approx. B N23W/14SW
							@82' - 1-2" thick fine grained gravel interbeds bounded by very thin claystone, hard.		@84.6' Approx. B N36W/21SW
ADDITIONAL COMMENTS:						R = Recovery RQD = Rock Quality Designation Attitudes from downhole camera optical logging			

SURFACE DATA

LOG OF BORING B17

CLIENT: Pardee Homes					PROJECT: Skyline Ranch		W.O.:8838
LOCATION: Santa Clarita					ELEVATION: 2120'±		DATE: 11/25/03
RIG TYPE: Core HQ-NQ2					HAMMER WEIGHTS: N/A		DROP:N/A
	R	U	B	RQD	Graphics	DESCRIPTION	ATTITUDES
80						@83' - Grades to red brown clayey fine grained SANDSTONE with gravel at 83.5'	
85	90%			76%		@85' to 90' - Red brown clayey fine grained SANDSTONE with poorly bedded fine gravel and occasional pebble interbeds, very dense, slightly moist, moderately well cemented.	@89' Approx. B N15E/13NW
90						@90' to 95' - Grades to pebbly clayey fine grained SANDSTONE, poorly bedded, moderately well cemented, very dense, slightly moist.	
95	100%			100%		@94.5' - 2" thick pebble bed, grading to red brown clayey fine grained SANDSTONE, very dense, slightly moist, moderately well cemented. @95' - 1"-2" thick CLAYSTONE, shear plane, stiff, dip of shear plane parallel to dip of bedding, grades to red brown clayey fine grained SANDSTONE with poorly developed pebble-gravel beds, occasionally thinly bedded, very clayey, very fine grained SANDSTONE, moderately well cemented, very dense, slightly moist, sharp, wavy contact. @97.5' - 6" thick CLAYSTONE, hard, slightly moist. @98' - Softer, sheared. @100' - Grades to pebble CONGLOMERATE, subangular to subrounded clasts, massive, weakly cemented to friable, tan light brown fine to coarse sandy matrix, dense to very dense, slightly moist.	@94.4' B N74W/11NE
100						@105' - 0.5-1.0" thick red brown CLAYSTONE. @105.5' - Pebble CONGLOMERATE interbedded by light brown clayey silty fine grained SANDSTONE, moderately well cemented, very dense, slightly moist.	@100' B N68W/9NE
105	100%			100%		@107' - Grades to red brown very clayey very fine grained SANDSTONE with thin beds of pebble and gravel, very dense, slightly moist, moderately well cemented. @109' - 1" thick red brown CLAYSTONE, slightly stiff, moist.	@104.7' Fracture N34W/54SW @106.4' B N71W/23SW @108.3' B N52E/28SE
110						@110' to 115' - Red brown slightly clayey to clayey fine grained SANDSTONE with gravel beds, occasional pebble bed, poorly bedded, moderately well cemented, very dense, slightly moist. @115' - 6" thick red brown CLAYSTONE, hard, slightly moist, moderately well cemented.	@113' B N39W/19NE @113.6' Bedding Horizontal @114.2' Approx. B N88W/28NE @116.8' Approx. B N23E/6SE
115	100%			97%		@115.5' - Grades to red brown clayey fine grained SANDSTONE with poorly bedded gravel. @116.5' - Grades to pebble CONGLOMERATE, poorly bedded, weakly cemented, red brown gravelly fine to coarse sandy matrix, dense, slightly moist.	@119.8' B N87E/2SE @120.6' B N71E/16NW
120							
125							

ADDITIONAL COMMENTS: R = Recovery
RQD = Rock Quality Designation
Attitudes from downhole camera optical logging

SURFACE DATA

LOG OF BORING B17

CLIENT: Pardee Homes					PROJECT: Skyline Ranch		W.O.: 8838
LOCATION: Santa Clarita					ELEVATION: 2120'		DATE: 11/25/03
RIG TYPE: Core HQ-NQ2					HAMMER WEIGHTS: N/A		DROP: N/A
	R	U	B	RQD	Graphics	DESCRIPTION	ATTITUDES
120						@ 112' - Grades to light brown poorly bedded medium to coarse grained SANDSTONE with occasional gravel and sparse poorly bedded pebbles, slightly friable to weakly indurated, dense to medium dense (saturated with drilling fluid).	@ 124' B
125	50%			32%		@ 122.5' to 127' - No recovery.	N32W/14SW
						@ 127' - Interbeds (up to 1" thick) of red brown very fine grained sandy CLAYSTONE, very stiff.	@ 126.6' B
						@ 128.5' - Pebble beds (up to 2" thick).	N41E/20NW
130						@ 129.5' - Grading to red brown very fine grained sandy CLAYSTONE, 2' thick, moderately well indurated.	@ 129' B
						@ 130' to 131' - Soft, sheared zone, becoming stiff to slightly stiff.	N75W/45SW
						@ 131.5' - Grades to clayey very fine grained SANDSTONE, very dense.	@ 129.7' B
135	90%			67%		@ 132' - <u>Mint Canyon Formation</u> : Sharp contact with olive gray green brown clayey fine grained SANDSTONE, massive, very dense, moderately well cemented, slightly moist, abundant orange brown and black staining (2-3cm diameter).	N68E/20NW
						@ 133' - Sharp contact with 6" thick olive brown CLAYSTONE, hard, slightly moist, moderately well indurated.	@ 132.8' Approx. B
						@ 134' - Sharp contact with green brown pebble CONGLOMERATE to clayey fine grained SANDSTONE interbed, weakly to moderately well cemented.	N54W/3NE
						@ 134.5' - Sharp contact with 6" thick olive brown CLAYSTONE, hard, slightly moist, moderately well indurated.	@ 134' Approx. B
140						@ 135' to 136' - No recovery.	N70E/9NW
						@ 136.5' - Sharp contact, red brown CLAYSTONE, grading to clayey very fine grained SANDSTONE at 137', massive, very dense, slightly moist, moderately well cemented.	
145	100%			76%		@ 138.5' - 2" thick pebble CONGLOMERATE interbed, weakly cemented.	@ 146.3' Approx. B
						@ 139.5' - Grades to olive brown very fine grained sandy CLAYSTONE,	N6W/10NE
						@ 140' - Slickensides oriented at 30° oblique to 23° true dip.	
150						@ 141' - Hard, slickensides oriented parallel to 45° true dip.	
						@ 142' - Hard, slickensides oriented parallel to 45° true dip.	
						@ 142.3' - Hard, slickensides oriented parallel to 33° dip.	
						@ 142.5' - Pebble.	@ 153.4' Channel
						@ 143' - Pebble bed.	N88W/38SW
155	100%			85%		@ 143' - Grades to olive brown very clayey fine grained SANDSTONE to very fine grained sandy CLAYSTONE with poorly bedded gravel, very dense and very hard, moderately well indurated.	
						@ 146' - Becoming red brown, internally sheared.	
						@ 148' - Slickensides present to 148.5', mottled to olive brown fine grained SANDSTONE, very dense.	
160						@ 149' - Grades to pebble-cobble CONGLOMERATE, poorly sorted, in an olive gray green gravelly fine to medium sandy matrix, weakly cemented (50% greater than 4" diameter, 35% at 2-3" diameter, 15% less than 2" diameter subrounded to subangular clasts), clasts predominantly boulders below 153', very dense.	
165							
ADDITIONAL COMMENTS:					R = Recovery		
					RQD = Rock Quality Designation		
					Attitudes from downhole camera optical logging		

SURFACE DATA

LOG OF BORING B17

CLIENT: Pardee Homes					PROJECT: Skyline Ranch			W.O.: 8838	
LOCATION: Santa Clarita					ELEVATION: 2120'±			DATE: 11/25/03	
RIG TYPE: Core HQ-NQ2					HAMMER WEIGHTS: N/A			DROP: N/A	
	R	U	B	RQD	Graphics	DESCRIPTION			ATTITUDES
160						@ 161' - Clasts predominantly pebble-cobble, poorly sorted, very dense, weakly cemented. @ 163' to 165' - No recovery.			
165	70%			30%					
170						@ 169' to 170' - No recovery. @ 170' to 175' - Clasts commonly subrounded to well rounded pebbles to cobbles, occasionally moderately well sorted and moderately well bedded, weakly cemented, very dense in a gray green medium to coarse sandy matrix.			
175	100%			59%					
180						@ 181' to 183' - Matrix becomes fine grained, slightly better cemented. @ 183.5' - Matrix becomes gravelly medium to coarse grained sand, weakly cemented to slightly friable.			@ 178.1' Channel N45E/43NW @ 180.6' B N88W/45NE
185	100%			61%					
190						@ 193.5' - Sharp contact with gray green fine to medium grained SANDSTONE, thinly bedded, weakly to moderately indurated, very dense, slightly dry. @ 195' - Cobble-boulder CONGLOMERATE, slightly well sorted, weakly cemented, gray green gravelly medium to coarse sandy matrix, very dense.			
195	100%			95%					
200						Groundwater Depth Date Total Depth - 200' 143.5' 12/8/03 145' 12/8/03 148' 12/9/03 149.5' 12/9/03 158' 12/11/03 170' 12/15/03			
205						Dry to T.D. 12/18/03			

ADDITIONAL COMMENTS:

R = Recovery
 RQD = Rock Quality Designation
 Attitudes from downhole camera optical logging

BORING 17
 SKYLINE RANCH, VTTM 060922

DEPTH (ft)	DIP DIRECTION AZIMUTH (MAGNETIC)	DIP DIRECTION AZIMUTH CORRECTED TO TRUE NORTH ₁	STRIKE AZIMUTH ₂	STRIKE AND DIP OF FEATURE	TYPE OF FEATURE
16.9	337	323	233	N53E/66NW	FRACTURE
18.5	3	-11	-101	N79E/46NW	FRACTURE
23.8	138	124	34	N34E/86SE	FRACTURE
45.1	205	191	101	N79W/43SW	APPX. BEDDING
45.8	25	11	-79	N79W/38NE	APPX. CHANNEL
48.7	338	324	234	N54E/37NW	APPX. BEDDING
50.6	33	19	-71	N71W/27NE	BEDDING
56.7	178	164	74	N74E/34SE	CLASTS
58.5	180	166	76	N76E/50SE	TOP OF CLAST
60.3	301	287	197	N17E/42NW	BOTTOM OF CLAST
65.7	186	172	82	N82E/17SE	TOP OF CLAST
67.7	308	294	204	N44E/54NW	FRACTURE
68.1	178	164	74	N74E/39SE	APPX. CHANNEL
72	85	71	-19	N19W/19NE	BEDDING
75.3	12	-2	-92	N88E/30NW	APPX. BEDDING
81.1	261	247	157	N23W/14SW	APPX. BEDDING
84.6	248	234	144	N36W/21SW	APPX. BEDDING
89	299	285	195	N15E/13NW	APPX. BEDDING
94.2	231	217	127	N53W/48SW	MUD ON SIDEWALLS?
94.4	30	16	-74	N74W/11NE	BEDDING
100	36	22	-68	N68W/9NE	BEDDING
104.7	250	236	146	N34W/54SW	FRACTURE
106.4	213	199	109	N71W/23SW	BEDDING
108.3	156	142	52	N52E/28SE	BEDDING
113	65	51	-39	N39W/19NE	BEDDING
113.6	0	0	0	HORIZONTAL	BEDDING
114.2	16	2	-88	N88W/28NE	APPX BEDDING
116.8	127	113	23	N23E/6SE	APPX BEDDING
119.8	191	177	87	N87E/2SE	BEDDING
120.6	355	341	251	N71E/16NW	BEDDING
124	252	238	148	N32W/14SW	BEDDING
126.6	325	311	221	N41E/20NW	BEDDING
129	209	195	105	N75W/4SW	BEDDING

BORING 17
 SKYLINE RANCH, VT TM 060922

129.7	352	338	248	N68E/20NW	BEDDING
132.8	50	36	-54	N54W/3NE	APPX BEDDING
134	354	340	250	N70E/9NW	APPX. BEDDING
142.7	232	218	128	N52W/59SW	SCOUR
145.3	233	219	129	N51W/37SW	CLAST
146	256	242	152	N28W/62SW	CLAST
146.3	98	84	-6	N6W/10NE	APPX. BEDDING
153.4	196	182	92	N88W/38SW	CHANNEL
158.7	94	80	-10	N10W/7NE	BTM OF CLAST
164.2	104	90	0	DUE N/26E	BTM OF CLAST
166.1	187	173	83	N83E/23SE	TOP OF CLAST
166.4	174	160	70	N70E/12SE	BTM OF CLAST
178.1	329	315	225	N45E/43NW	CHANNEL
180.6	12	-2	-92	N88W/45NE	CHANNEL
186.2	98	84	-6	N6W/17NE	TOP OF CLAST
188	102	88	-2	N2W/19NE	BTM OF CLAST

1. MAGNETIC DIP AZIMUTH CORRECTED 14 DEGREES TO TRUE NORTH
2. STRIKE AZIMUTH OF FEATURE OBTAINED FROM CORRECTED DIP AZIMUTH
3. OPTICAL LOG REVIEWED TO DETERMINE FEATURE TYPE
4. FEATURES IN BOLD CONSIDERED PERTINENT FOR PLOTTING ON GEOLOGIC MAP

SURFACE DATA

LOG OF BORING B18

CLIENT: Pardee					PROJECT: Skyline Ranch					W.O.: 8838	
LOCATION: Santa Clarita					ELEVATION: 2250±					DATE: 12/3/03	
RIG TYPE: Core HQ-NQ2					HAMMER WEIGHTS: N/A					DROP: N/A	
	R	U	B	RQD	Graphics	DESCRIPTION					ATTITUDES
0						Soil/Colluvium: Dark brown sandy CLAY with occasional gravel, hard, slightly moist.					
5	80%			20%		@0.5' - <u>Weathered Mint Canyon Formation</u> : Grades to pebble-cobble CONGLOMERATE, highly weathered, poorly bedded, poorly sorted, subangular to well rounded granitic, quartzic clasts from 0.5"-3" diameter, olive brown, clayey gravelly medium to coarse sandy matrix, medium dense, saturated with drilling fluid, roots to 3' depth. @5' - <u>Mint Canyon Formation</u> : 30% recovery, faint remnant of olive brown silty gravelly fine to medium sandy matrix, mostly subangular to well rounded 1"-6" diameter clasts.					@ 6' B N24W/23SW
10						@10' - Light olive gray brown gravelly medium to coarse sandy matrix, medium dense, weakly cemented, slightly sorted. @12' to 13' - 30% recovery. @13.5' - Becomes dense, moderately coherent matrix, slightly moist.					
15	90%			73%		@15' - Interbedded pebble-cobble CONGLOMERATE, fairly well sorted, olive gray gravelly fine to medium sand matrix, weakly cemented, dense, slightly moist.					
20						@20' - Becomes poorly sorted, poorly bedded.					
25	95%			80%		@23' - Sharp contact with olive gray fine to coarse grained SANDSTONE with occasional gravel, poorly bedded, weakly indurated, very dense, slightly dry. @24.5' - Olive gray brown very thinly bedded pebble CONGLOMERATE, slightly sorted, moderately indurated. @25' to 30' - 90% recovery. @26' - Grades to cobble-boulder CONGLOMERATE, weakly cemented, gravelly fine to coarse sand matrix, very dense.					@ 22.8' B N81W/16SW @ 24.3' B N85W/14NE
30						@24.5' - Olive gray brown very thinly bedded pebble CONGLOMERATE, slightly sorted, moderately indurated. @25' to 30' - 90% recovery. @26' - Grades to cobble-boulder CONGLOMERATE, weakly cemented, gravelly fine to coarse sand matrix, very dense. @30' to 35' - 90% recovery. @30' - 3' thick interbed of pebble-cobble CONGLOMERATE.					@ 27.5' Fracture N85W/31NE @ 29.6' Approx. B N20E/20SE
35	75%			71%		@35' - 2.5' thick interbed of light olive gray brown pebble CONGLOMERATE, weakly cemented to slightly friable, very dense.					
40						@40' - Interbedded pebble-cobble-boulder CONGLOMERATE, fairly well sorted.					
45											
ADDITIONAL COMMENTS:						R = Recovery RQD = Rock Quality Designation Attitudes from downhole camera optical logging					

SURFACE DATA

LOG OF BORING B18

CLIENT: Pardee Homes					PROJECT: Skyline Ranch		W.O.: 8838
LOCATION: Santa Clarita					ELEVATION: 2250'±		DATE: 12/3/03
RIG TYPE: Core HQ-NQ2					HAMMER WEIGHTS: N/A		DROP: N/A
	R	U	B	RQD	Graphics	DESCRIPTION	ATTITUDES
40							
45	80%			58%		@45' to 50' - 60% recovery, predominantly boulder CONGLOMERATE.	
50						@53' - Grades to pebble CONGLOMERATE, fairly well sorted, thinly bedded, olive gray brown gravelly coarse sandy matrix, weakly cemented, very dense, slightly dry (saturated with drilling fluid).	@51.6' B N18W/25NE
55	85%			78%		@56' - Grades to pebble-cobble CONGLOMERATE.	
60						@63' - Matrix becomes moderately well cemented.	@60.4' B N65E/20SE @60.9' B N64E/5SE
65	85%			72%		@65' - Increase in cobbles, boulders (about 40% of clasts up to 12" diameter).	@65.7' Approx B/Channel N56W/35SW
70						@70' - Matrix becomes very weakly cemented. @72' - Matrix color becomes olive brown.	
75	85%			61%		@75' - Matrix color grades to light olive gray.	@74.1' Approx. Channel N54E/51SE
80						@80' - Greater than 18" boulder clast.	
85							@83.6' B N58E/27SE
ADDITIONAL COMMENTS:					R = Recovery RQD = Rock Quality Designation Attitudes from downhole camera optical logging		

SURFACE DATA

LOG OF BORING B18

CLIENT: Pardee Homes					PROJECT: Skyline Ranch			W.O.:8838
LOCATION: Santa Clarita					ELEVATION: 2250'±			DATE: 12/3/03
RIG TYPE: Core HQ-NQ2					HAMMER WEIGHTS: N/A			DROP:N/A
	R	U	B	RQD	Graphics	DESCRIPTION		ATTITUDES
80								
85	100%			81%		@85' - Continued pebble-cobble-boulder CONGLOMERATE, moderately to well sorted, slightly bedded, rounded to subangular clasts, 60% cobble-boulder, light olive gray gravelly medium to coarse sandy matrix, very weakly cemented, very dense, slightly dry.		
90								
95	100%			60%		@95' - Grades to 70% pebble-cobble clasts.		
100						@100' - Grades to pebble CONGLOMERATE, minor sandy pebble CONGLOMERATE, 80% fine pebble, 15% coarse pebble to fine cobble, 5% cobble-boulder clasts, moderately sorted. @100' to 110' - 100% recovery.		
105	100%			65%				
110						@110' to 120' - 85% recovery.		
115	85%			55%		@116' - Grades to fine pebble-gravel CONGLOMERATE to light olive gray sandy CONGLOMERATE.		@117.6' Approx. B N70E/32NW
120						@119.5' - 5mm thick olive gray MUDSTONE, slickensides, hard, slightly dry, underlain by light olive gray fine to medium grained SANDSTONE, weak to moderately indurated, very dense, 12" thick. @120.5' - Grades to pebble cobble CONGLOMERATE, moderately sorted, very weakly cemented, 80% fine pebbles, 10% fine cobbles, light olive gray gravelly fine to coarse sandy matrix, very dense.		
125								
ADDITIONAL COMMENTS:					R = Recovery RQD = Rock Quality Designation Attitude from downhole camera optical logging			

SURFACE DATA

LOG OF BORING B18

CLIENT: Pardee Homes					PROJECT: Skyline Ranch		W.O.: 8838
LOCATION: Santa Clarita					ELEVATION: 2250'±		DATE: 12/3/03
RIG TYPE: Core HQ-NQ2					HAMMER WEIGHTS: N/A		DROP: N/A
	R	U	B	RQD	Graphics	DESCRIPTION	ATTITUDES
120							
125	80%			78%		<p>@127' - 12" thick light olive gray fine to coarse grained SANDSTONE interbed, weak to moderately indurated, very dense, slightly dry.</p> <p>@127.25' - 2mm thick very dusky medium CLAYSTONE, slickensides oriented 25° oblique to sandstone bedding, soft.</p> <p>@128' to 130' - no recovery.</p>	<p>@131.1' B N83W/25SW</p>
130						<p>@133' - 12" thick light olive gray fine to coarse grained SANDSTONE with thinly bedded 1-2mm bands of dark minerals, weakly indurated, very dense, slightly dry.</p>	<p>@133.4' B .idueE/26S</p>
135	100%			71%		<p>@134' - Grading to pebble-cobble-boulder CONGLOMERATE, bedded, moderately sorted, rounded to subangular, 8% fine pebbles, light olive gray gravelly medium to coarse sandy matrix, very weakly cemented, dense.</p>	<p>@136.5' B N73E/17SE</p>
140						<p>@138' - Dark reddish gray sheared zone, 1mm thick, very hard.</p> <p>@139' - Grades to olive gray fine grained SANDSTONE, moderately indurated, very dense, slightly dry, internally sheared, randomly oriented.</p>	
145	100%			71%		<p>@140' - Random pervasive shearing, steep, oriented oblique to fracture.</p> <p>@140.5' - Grades to pebble-cobble-boulder CONGLOMERATE, poorly to moderately sorted, very weakly cemented, matrix supported, rounded to subangular, 80% fine pebble clasts.</p>	
150						<p>@143' - Matrix becomes moderately to well cemented, moderately to well sorted, fine to coarse grained sand, trace gravel.</p> <p>@143' to 165' - Pebble-cobble-boulder CONGLOMERATE, moderately to well sorted, light olive gray gravelly fine to coarse sandy matrix, moderately cemented, round to subangular, 80% fine pebble clasts.</p>	<p>@152.3' B N62E/29SE</p>
155	100%			98%			
160							
165							
ADDITIONAL COMMENTS:					<p>R = Recovery RQD = Rock Quality Designation Attitudes from downhole camera optical logging</p>		

SURFACE DATA

LOG OF BORING B18

CLIENT: Pardee Homes					PROJECT: Skyline Ranch			W.O.: 8838															
LOCATION: Santa Clarita					ELEVATION: 2250'±			DATE: 12/3/03															
RIG TYPE: Core HQ-NQ2					HAMMER WEIGHTS: N/A			DROP: N/A															
	R	U	B	RQD	Graphics	DESCRIPTION			ATTITUDES														
160																							
165	100%			100%		@ 165' - Matrix becomes weakly cemented.																	
170						@ 171.5' - Grades to light olive gray fine to coarse grained SANDSTONE with dispersed gravel and minor thin fine pebble beds, 6" thick pebble-cobble bed.			@ 171.2' B N66E/34SE														
175	100%			100%		@ 173.5' - Thinly bedded dark mineral laminations (1-2mm thick) from 172-173', moderately indurated, very dense, slightly dry.																	
180						Total Depth - 175'																	
						<table border="1"> <thead> <tr> <th>Groundwater Depth</th> <th>Date</th> </tr> </thead> <tbody> <tr> <td>43.5'</td> <td>12/9/03</td> </tr> <tr> <td>127'</td> <td>12/11/03</td> </tr> <tr> <td>151'</td> <td>12/15/03</td> </tr> <tr> <td>157'</td> <td>12/18/03</td> </tr> <tr> <td>165'</td> <td>12/26/03</td> </tr> <tr> <td>Dry to T.D.</td> <td>1/8/04</td> </tr> </tbody> </table>			Groundwater Depth	Date	43.5'	12/9/03	127'	12/11/03	151'	12/15/03	157'	12/18/03	165'	12/26/03	Dry to T.D.	1/8/04	
Groundwater Depth	Date																						
43.5'	12/9/03																						
127'	12/11/03																						
151'	12/15/03																						
157'	12/18/03																						
165'	12/26/03																						
Dry to T.D.	1/8/04																						
185																							
190						Backfilled 1/8/04																	
195																							
200																							
205																							

ADDITIONAL COMMENTS:

R = Recovery
 RQD = Rock Quality Designation
 Attitudes from downhole camera optical logging

BORING 18
 SKYLINE RANCH, VTTM 060922

DEPTH (ft)	DIP DIRECTION AZIMUTH (MAGNETIC)	DIP DIRECTION AZIMUTH CORRECTED TO TRUE NORTH ₁	STRIKE AZIMUTH ₂	STRIKE AND DIP OF FEATURE	TYPE OF FEATURE
6	260	246	156	N24W/23SW	BEDDING
22.8	203	189	99	N81W/16SW	BEDDING
24.3	23	9	-81	N81W/14NE	BEDDING
24.8	19	5	-85	N85W/13NE	BEDDING
25.9	192	178	88	N88E/34SE	BTM OF CLAST
27.2	19	5	-85	N85W/31NE	FRACTURE
29.6	124	110	20	N20E/20SE	APPX. BEDDING
32.7	88	74	-16	N16W/40NE	TOP OF CLAST
33.4	12	358	268	N88E/25NW	BTM OF CLAST
38.3	79	65	-25	N25W/32NE	BTM OF CLAST
44	105	91	1	N1E/34SE	CLASTS
51.6	86	72	-18	N18W/25NE	BEDDING
60.4	169	155	65	N65E/20SE	BEDDING
60.9	168	154	64	N64E/5SE	BEDDING
65.7	250	236	146	N56W/35SW	APPX. BEDDING/CHANNEL
66.8	340	326	236	N56E/24NW	TOP OF CLAST
67.4	358	344	254	N75E/37NW	BTM OF CLAST
74.1	158	144	54	N54E/51SE	APPX. CHANNEL
83.6	162	148	58	N58E/27SE	BEDDING
117.6	354	340	250	N70E/32NW	APPX. BEDDING
131.1	201	187	97	N83W/25SW	BEDDING
133.4	194	180	90	EW/26S	BEDDING
136.5	177	163	73	N73E/17SE	BEDDING
152.3	166	152	62	N62E/29SE	APPX. BEDDING
171.2	170	156	66	N66E/34SE	BEDDING

1. MAGNETIC DIP AZIMUTH CORRECTED 14 DEGREES TO TRUE NORTH
2. STRIKE AZIMUTH OF FEATURE OBTAINED FROM CORRECTED DIP AZIMUTH
3. OPTICAL LOG REVIEWED TO DETERMINE FEATURE TYPE
4. FEATURES IN BOLD CONSIDERED PERTINENT FOR PLOTTING ON GEOLOGIC MAP

SURFACE DATA

LOG OF BORING B19

CLIENT: Pardee Homes					PROJECT: Skyline Ranch		W.O.: 8838
LOCATION: Santa Clarita					ELEVATION: 1905'±		DATE: 12/8/03
RIG TYPE: Bucket Auger					HAMMER WEIGHTS: Kelly Bar		DROP: 12"
	N	U	B	M	DD	DESCRIPTION	ATTITUDES
0						<u>Saugus Formation</u> : Orange brown coarse grained SANDSTONE with small gravels and occasional cobbles, massive, dry, hard.	
5						@3' - Cobble lens, abundant black manganese staining at base of cobbles. @6' - Olive brown fine grained SANDSTONE, massive, hard. @7' - Olive gray brown gravelly/cobbly CONGLOMERATE, massively bedded, hard, cemented, dry.	@6' Channel BN65E/10SE Approx.
10							
15		X	X	8.0	125.5	@16-20' - Large cobbles/boulders, clast-supported zone.	
20						@20' - Scoured, irregular contact on dark olive brown fine to very fine grained SANDSTONE, massive, moist, dense, with occasional siltstone rip-up clasts/pods. @23' - Wavy, nearly horizontal contact on medium to coarse grained sandy gravelly CONGLOMERATE with frequent cobbles, massive, cemented, hard.	@20' Channel BEW/20S Approx. @22' Channel BN75E/20NW Approx. @23' Approx. Horizontal bedding
25							
30		X	X	9.1	127.2	@32' - Abundant black manganese staining.	
35						@36' - Coarsening to cobbly CONGLOMERATE with frequent boulders, difficult drilling, coring required. @37-39' - Heavy black manganese staining on cobbles, boulders.	
40							@41' Channel BN60E/22SE Approx.
45							

ADDITIONAL COMMENTS: Blows for 12" using California Split Barrel Sampler
 Kelly Bar Weights: 0 - 24', 2800 lbs.
 25 - 47', 1800 lbs.
 48 - 70', 800 lbs.

SURFACE DATA

LOG OF BORING B19

CLIENT: Pardee Homes					PROJECT: Monasabian		W.O.: 8838
LOCATION: Santa Clarita					ELEVATION: 1905'±		DATE: 12/8/03
RIG TYPE: Bucket Auger					HAMMER WEIGHTS: Kelly Bar		DROP: 12"
	N	U	B	M	DD	DESCRIPTION	ATTITUDES
40						Massively bedded, no discernible bedding.	
45		X	X	8.1	107.4	@46-48' - Boulders, coring required.	
50						@50' - Boulders, coring required.	
55						@54' - Boulders, coring required, refusal at 55 feet in boulders.	
60						Total Depth - 55' due to refusal in boulder zone No groundwater, minor caving of loose cobbles Backfilled	
65							
70							
75							
80							
85							
ADDITIONAL COMMENTS:					Blows for 12" using California Split Barrel Sampler Kelly Bar Weights: 0 - 24', 2800 lbs. 25 - 47', 1800 lbs. 48 - 70', 800 lbs.		

SURFACE DATA

LOG OF BORING B20

CLIENT: Pardee Homes					PROJECT: Skyline Ranch		W.O.: 8838
LOCATION: Santa Clarita					ELEVATION: 1970'		DATE: 12/10/03
RIG TYPE: Core HQ-NQ2					HAMMER WEIGHTS: N/A		DROP: N/A
R	U	B	RQD	Graphics	DESCRIPTION	ATTITUDES	
0							
5	55%		38%		<p>Saugus Formation: Brown clayey fine to medium grained SAND with dispersed gravel, medium dense, slightly moist.</p> <p>@ 1' - Cobble clasts.</p> <p>@ 5' - Pebble-cobble-boulder CONGLOMERATE, poorly to moderately sorted, rounded to subangular clasts commonly fine to coarse pebble. Light olive gray gravelly medium to coarse sandy matrix, very weakly cemented, dense, slightly.</p> <p>@ 10' - Becomes moderately to well sorted.</p>		
10						@ 12' Dip of Bedding 10-15°	
15	90%		86%		<p>@ 18' - 6-12" diameter boulders, clasts commonly cobble-boulder, rounded to subrounded, poorly to moderately sorted.</p>		
20							
25	100%		72%		<p>@ 28.5' - Zone of shearing in olive gray fine grained sandy CLAYSTONE, slickensides randomly oriented relative to fractures.</p> <p>@ 29.5' - Cobble-boulder CONGLOMERATE, poorly sorted, minor pebble CONGLOMERATE.</p>	@ 28' Dip of Shearing 20-40°	
30							
35	100%		83%		<p>@ 35' - Grades to pebble-cobble CONGLOMERATE, moderately sorted, rounded to subangular commonly fine pebble and medium cobble clast. Light olive gray gravelly medium to coarse grained sand matrix, very weakly cemented, dense to very dense, slightly dry.</p>		
40							
45							

ADDITIONAL COMMENTS:

R = Recovery
 RQD = Rock Quality Designation
 Dip angles from core examination

CLIENT: Pardee Homes					PROJECT: Skyline Ranch		W.O.: 8838
LOCATION: Santa Clarita					ELEVATION: 1970'		DATE: 12/10/03
RIG TYPE: Core HQ-NQ2					HAMMER WEIGHTS: N/A		DROP: N/A
R	U	B	RQD	Graphics	DESCRIPTION		ATTITUDES
40							
45	100%		95%				
50					← CONTACT @ 50'		
55	100%		100%		<u>Mint Canyon Formation:</u> @54' - Light olive gray fine to medium grained SANDSTONE, bedded with thin beds (5mm thick) of coarse grained SANDSTONE and dark mineral banding, moderately indurated, very dense, slightly dry. @57' - 3-5" thick pebble-cobble interbed. @57.5' - Boulders to 59', grading to pebble-cobble-boulder CONGLOMERATE, poorly to moderately sorted, rounded to subangular, commonly pebble-cobble clasts. @63' - 12" diameter boulder.	@55' Dip of Bedding 20°±	
60							
65	100%		95%				
70							
75	100%		91%		@74' - Contact with olive gray fine to medium grained SANDSTONE with occasional very thin gravel to fine pebble beds, moderately indurated, very dense, slightly dry. @75' - Grades to pebble-cobble-boulder CONGLOMERATE to sandy CONGLOMERATE.		
80							
85							

ADDITIONAL COMMENTS:

R = Recovery
 RQD = Rock Quality Designation
 Dip angles from core examination

SURFACE DATA

LOG OF BORING B20

CLIENT: Pardee Homes					PROJECT: Skyline Ranch		W.O.:8838
LOCATION: Santa Clarita					ELEVATION: 1970'		DATE: 12/11/03
RIG TYPE: Core HQ-NQ2					HAMMER WEIGHTS: N/A		DROP:N/A
	R	U	B	RQD	Graphics	DESCRIPTION	ATTITUDES
80							
85	100%			76%			
90						<p>@89.5' - 6" thick bed of olive gray CLAYSTONE, internally sheared, stiff.</p> <p>@90' - Grades to light gray fine grained SANDSTONE, moderately indurated, very dense, with 1" thick interbeds of olive gray CLAYSTONE at 90.8' and 91' (some 1mm thick), parallel to contact at 92.5'.</p>	<p>@90' Dip of Shear 20-25°</p>
95	100%			100%		<p>@92.5' - Contact with pebble-cobble-boulder CONGLOMERATE, very dense, very weakly cemented.</p> <p>@95' - 12" thick light olive gray coarse grained SANDSTONE with gravel and pebble beds, very dense, moderately indurated, grading to conglomeratic coarse grained SANDSTONE, fine pebbles, coarse cobbles common, poorly to moderately sorted, weakly cemented.</p>	<p>@91' Dip of Bedding 20-25°</p>
100							
105	100%			80%		<p>@101' - Grades to pebble-cobble-boulder CONGLOMERATE, commonly fine pebbles and coarse cobbles, very weakly cemented, poorly to moderately sorted, very dense, light olive gray gravelly medium to coarse sandy matrix.</p>	
110							
115	100%			65%		<p>@115' - Contact with light gray to gray fine grained SANDSTONE, very dense, slightly dry, with 4" thick interbed of olive gray CLAYSTONE at 115.2', hard, internally sheared, slickensides oriented oblique to claystone/sandstone contact (stained orange).</p>	<p>@115' Dip of Contact 20-25°</p>
120						<p>@116' - Contact with sandy pebble-cobble-boulder CONGLOMERATE, poorly to moderately sorted, rounded to subangular clasts commonly fine to coarse pebbles, some coarse cobbles and fine boulders, light olive gray fine to coarse sandy matrix, weakly cemented, very dense, minor fine to coarse grained sandstone.</p>	<p>@115.5' Dip of Fracture 30-35°</p>
125							

ADDITIONAL COMMENTS:

R = Recovery
 RQD = Rock Quality Designation
 Dip angles from core examination

CLIENT: Pardee Homes					PROJECT: Skyline Ranch		W.O.: 8838
LOCATION: Santa Clarita					ELEVATION: 1970'		DATE: 12/12/03
RIG TYPE: Core HQ-NQ2					HAMMER WEIGHTS: N/A		DROP: N/A
	R	U	B	RQD	Graphics	DESCRIPTION	ATTITUDES
120							
125	100%			76%		@125' - Grades to conglomeratic fine to coarse grained SANDSTONE, weakly to moderately indurated, clasts commonly fine to coarse pebbles and 6-12" diameter boulders, rounded to subangular, poorly to moderately sorted, very dense, slightly dry.	
130						@131.5' - 7" thick fine to coarse grained SANDSTONE, moderately indurated, very dense, slightly dry. @132.5' - Boulders to 134.5' (10" thick).	
135	100%			82%			
140						@139' - Contact with light olive gray fine grained SANDSTONE, moderately indurated, very dense, internally sheared, dark greenish gray CLAYSTONE, slickensides at 139.5'. @140' - Pebble-cobble-boulder CONGLOMERATE to conglomeratic SANDSTONE, light olive gray fine to coarse sandy matrix, weakly cemented, clasts commonly fine to coarse pebbles, some boulders.	@139.5' Dip of Shear 60-65°
145	90%			74%		@146' - 12" thick light olive gray fine to coarse grained SANDSTONE, moderately indurated, very dense. @148-149' - No recovery.	
150							
155						Total Depth - 150' Backfilled 12/12/03 No groundwater noted while drilling, steady but slow loss of drilling fluid	
160							
165							

ADDITIONAL COMMENTS:

R = Recovery
 RQD = Rock Quality Designation
 Dip angles from core examination

SURFACE DATA

LOG OF BORING B21

CLIENT: Pardee Homes					PROJECT: Skyline Ranch		W.O.: 8838
LOCATION: Santa Clarita					ELEVATION: 1950'		DATE: 12/12/03
RIG TYPE: Bucket Auger					HAMMER WEIGHTS: Kelly Bar		DROP: 12"
	N	U	B	M	DD	DESCRIPTION	ATTITUDES
0						<u>Saugus Formation</u> : Reddish brown silty very fine grained SANDSTONE with frequent coarse grains and occasional gravels, dry, massive, dense.	
						@ 1' - Reddish brown slightly clayey medium to coarse grained SANDSTONE with abundant small gravels, massive, dry, hard.	
						@ 3' - Dark red brown sandy CLAYSTONE with frequent coarse grains and occasional gravels, moist, stiff, gradational silty lens sequences and occasional cobble pockets.	
5						@ 8' - Grades to medium brown silty fine grained SANDSTONE with occasional coarse grains.	
						@ 12' - Grades to medium red brown slightly clayey SILTSTONE to silty CLAYSTONE with frequent coarse grains and small gravels, slightly moist, very dense, massive.	@ 14.5' Approx. BN70E/24NW
15	7	X		12.1	118.4	@ 14' - Grades to medium brown silty SAND with abundant scattered coarse grains coarsening to well graded fine to coarse grained sand pockets and lenses, friable, dry.	
						@ 14.5' - 1" discontinuous carbonate-rich layer.	@ 18' Approx. BN17E/15NW
						@ 15' - Irregular scoured contact on medium brown clayey SILTSTONE to silty CLAYSTONE with frequent coarse grains, moist, stiff, massive.	
20						@ 18' - Reddish brown clayey coarse grained SANDSTONE, dry, massive, very hard.	
						@ 20-21' - Calcium carbonate stained, cemented, gravel pocket.	
						@ 20' - Crudely graded medium gray brown fine to coarse grained SANDSTONE with frequent gravels, friable, dry, dense.	@ 25' Approx. N60E/14NW
25						@ 24' - Flat, wavy contact on medium brown sandy clayey SILTSTONE to sandy silty CLAYSTONE with frequent coarse grains and small gravels, moist, dense, massive.	
						@ 25' - Dark reddish brown CLAYSTONE with frequent coarse grains, moist, stiff, massive.	
30	25	X		3.1	127.1	@ 26' - Grades to medium red/orange brown clayey SANDSTONE, coarsening downward.	@ 32.5' Approx. BN80W/6SW
						@ 28' - Infrequent coarse grains and small gravels, moderately friable.	
						@ 30' - Coarsening to coarse gravel within slightly silty fine grained SANDSTONE matrix, moderately friable, dense.	@ 35' Approx. BN80E/9SE
35						@ 31' - Moderately well graded very fine to coarse grained SANDSTONE, friable, dry, dense.	@ 37' Approx. BN87E/17NW
						@ 32' - Coarsening to medium to coarse grains and gravels, friable.	
						@ 34' - Fining to moderately well graded fine to coarse grained SANDSTONE, friable, dry, dense.	
40						@ 37' - Medium brown SILTSTONE with thin red CLAYSTONE interbeds, moist, stiff.	
						@ 38' - 1/8" thick clay bed, very moist, soft.	
						@ 39' - Grades to orange/reddish brown clayey SANDSTONE with frequent coarse grains and infrequent gravels, moist, moderately dense, massive.	
45							
ADDITIONAL COMMENTS:							Blows for 12" interval using California Split Barrel Sampler Kelly Weights: 0 - 24', 2800 lbs. 25 - 47', 1800 lbs. 48 - 70', 800 lbs. 71 - 95', 500 lbs.

SURFACE DATA

LOG OF BORING B21

CLIENT: Pardee Homes					PROJECT: Skyline Ranch		W.O.: 8838
LOCATION: Santa Clarita					ELEVATION: 1950'		DATE: 12/12/03
RIG TYPE: Bucket Auger					HAMMER WEIGHTS: Kelly Bar		DROP: 12"
	N	U	B	M	DD	DESCRIPTION	ATTITUDES
40						@41' - Decreasing CLAY content, increasing gravels.	
						@43.5' - Grades to orange brown slightly clayey silty fine grained SANDSTONE, moist, massive.	@44' Approx. BN10E/10NW
45	17	X		13.3	122.9	@45.5' - Gray fine grained SANDSTONE with infrequent coarse grains, friable, dry.	
						@46' - Medium brown sandy SILTSTONE, moist, massive, stiff.	@48.5' BN40W/8SW
						@47' - Grades to fine grained SANDSTONE with medium grained friable lens.	@48.5' BN20W/12SW
50						@48.5' - Medium brown SILTSTONE with thin (1/4"-1") CLAYSTONE interbeds, moist, soft.	
						@49' - Grades to clayey SANDSTONE with frequent coarse grains and gravels. moist. massive, dense.	
						@52' - Olive gray fine grained SANDSTONE.	
55						@53' - Gray moderately well graded coarse grained SANDSTONE and gravels, dry, moderately friable.	
						@54' - Fine to coarse grained gravelly moderately well graded sequences, slightly friable, dense, dry.	
60	50	X		4.7	117.1	@61.5' - Medium brown CLAYSTONE, massive, moist, dense.	@61.5' BN25W/9SW
						@62' - Grades to medium brown SILTSTONE, fine SANDSTONE, and CLAYSTONE.	@63.5' BN15E/7NW
						@63.5' - Thin clay bed.	
65						@64' - Reddish brown clayey SANDSTONE with frequent coarse grains and small gravels.	
						@66' - Becoming sandier with depth, less clays.	@68' BN20W/10SW
						@67' - Gray coarse grained SANDSTONE with gravels.	
						@68' - Fines to fine grained SANDSTONE.	
70						@69' - Coarsening to coarse grained gravelly SANDSTONE.	@71' Approx. BN5W/11NE
						@70' - Fines to silty fine grained SANDSTONE with infrequent coarse grains and small gravels, moist, dense.	
75	18	X		13.8	116.2	@74' - Grades to reddish brown CLAYSTONE/MUDSTONE with occasional sandier sequences, moist, dense, frequent coarse grains.	
80							
85						@83-84' - Gravelly.	

ADDITIONAL COMMENTS: Blows for 12" interval using California Split Barrel Sampler
 Kelly Weights: 0 - 24', 2800 lbs.
 25 - 47', 1800 lbs.
 48 - 70', 800 lbs.
 71 - 95', 500 lbs.

SURFACE DATA

LOG OF BORING B21

CLIENT: Pardee Homes					PROJECT: Skyline Ranch			W.O.:8838	
LOCATION: Santa Clarita					ELEVATION: 1950'			DATE: 12/12/03	
RIG TYPE: Bucket Auger					HAMMER WEIGHTS: Kelly Bar			DROP:12"	
	N	U	B	M	DD	DESCRIPTION			ATTITUDES
80									
85						@87' - Grades to orangish coarse grained gravelly SANDSTONE. @89' - Grades to olive brown fine to medium grained SANDSTONE with coarse grains, moist, very dense, massive. @91' - Olive gray sandy CLAYSTONE to MUDSTONE with frequent coarse grains, massive, dense.			@91' Approx. BN85W/8SW
90	18	X		16.4	115.9				
95						@97' - Olive gray gravelly CONGLOMERATE with abundant cobbles, dry, hard, cemented.			
100						@102' - Olive brown MUDSTONE with frequent coarse grains and small gravels, massive, hard, slightly moist. @103' - Gray gravelly cobbly CONGLOMERATE.			
105									
110						Total Depth - 107' No groundwater Backfilled			
115									
120									
125									

ADDITIONAL COMMENTS: Blows for 12" interval using California Split Barrel Sampler
 Kelly Weights: 0 - 24', 2800 lbs.
 25 - 47', 1800 lbs.
 48 - 70', 800 lbs.
 71 - 95', 500 lbs.

SURFACE DATA

LOG OF BORING B22

CLIENT: Pardee Homes					PROJECT: Skyline Ranch			W.O.: 8838	
LOCATION: Santa Clarita					ELEVATION: 2265±			DATE: 12/15/03	
RIG TYPE: Core HQ-NQ2					HAMMER WEIGHTS: N/A			DROP: N/A	
	R	U	B	RQD	Graphics	DESCRIPTION			ATTITUDES
0						<p>Mint Canyon Formation: Olive yellow clayey fine to medium grained SAND with pebbles and cobbles, medium dense to dense, highly weathered, slightly moist.</p> <p>@1-2.5' - No recovery.</p> <p>@4-5' - No recovery.</p>			@3.4' Fracture N8E/55NW
5	75%			57%		<p>@5' - Sandy pebble-cobble CONGLOMERATE, poorly to moderately sorted, rounded to subangular clasts commonly fine pebble with some medium cobble, light olive gray fine to coarse sandy matrix, very weakly cemented, very dense, slightly dry to slightly moist.</p>			@6' B N69W/26SW @8.9' Fracture N50E/10NW @9.5' B N58E/31SE
10						<p>@12.5' - Grades to moderately sorted weakly cemented.</p>			
15	90%			30%		<p>@14.5' - Contact with light olive gray fine to medium grained SANDSTONE, moderately indurated, very dense, slightly dry.</p> <p>@15-16' - No recovery, grades to very weakly cemented.</p>			
20						<p>@18.5' - Increase in % cobbles, poorly sorted, 20% recovery.</p> <p>@20-22.5' - 30% recovery.</p>			
25	80%			28%		<p>@22' - 6" thick interbed of olive gray fine to medium grained SANDSTONE, weak to moderately indurated, very dense, slightly dry.</p>			@25.5' B N39W/10NE
30						<p>@28' - 6" interbed of olive gray fine to coarse grained SANDSTONE, moderately indurated, very dense, slightly dry.</p>			@29.3' Approx. BN63W/23SW
35	100%			54%		<p>@32' - Grades to moderately to well sorted, clasts predominantly fine pebble, very weak to weakly cemented, very dense.</p>			
40						<p>@39' - Grades to light olive gray conglomeratic fine to coarse grained SANDSTONE, weak to moderately indurated, occasional pebble interbeds (up to 3-6" thick), moderately to well sorted, very dense, slightly dry.</p> <p>@40' - Contact with sandy pebble-cobble-boulder CONGLOMERATE, poorly sorted, rounded to subangular pebble to boulder, olive gray fine to coarse sandy matrix, very weakly cemented, very dense, slightly dry.</p>			
45									
ADDITIONAL COMMENTS:					<p>R = Recovery RQD = Rock Quality Designation Attitudes from downhole camera optical logging</p>				

SURFACE DATA

LOG OF BORING B22

CLIENT: Pardee Homes					PROJECT: Skyline Ranch		W.O.: 8838
LOCATION: Santa Clarita					ELEVATION: 2265'±		DATE: 12/15/03
RIG TYPE: Core HQ-NQ2					HAMMER WEIGHTS: N/A		DROP: N/A
	R	U	B	RQD	Graphics	DESCRIPTION	ATTITUDES
40							
45	100%			78%		@48' - 2" thick gray to bluish gray CLAYSTONE, very hard, slightly dry, slickensides.	
50						@49' - 2" thick gray to bluish gray CLAYSTONE, very hard, slightly dry.	
55	100%			87%		@55' - Grades to moderately well cemented, poorly to moderately sorted.	
60							
65	100%			97%		@65' - 12" thick light olive gray fine to coarse grained SANDSTONE, thinly bedded, dark mineral laminations (1-2mm thick), moderately indurated, very dense, slightly dry.	
70						@66' - Grades to sandy pebble-cobble-boulder CONGLOMERATE, poorly to moderately sorted, rounded to subangular clasts commonly fine to coarse pebble, olive gray fine to coarse sandy matrix, moderately to well cemented, very dense, slightly dry. @69' - 6" thick olive gray fine grained SANDSTONE, moderately indurated, very dense, slightly dry.	@69.8' B N30E/29SE @70.3' Approx. BN34E/25NW
75	90%			80%		@70' - Grades to very weakly cemented sandy pebble-cobble-boulder CONGLOMERATE, moderately sorted, very dense. @73-74' - No recovery. @74.5' - Grades to gravel CONGLOMERATE, very dense, moderately well cemented.	@75.8' B N69E/10SE
80						@75' - Grades to pebble-cobble-fine boulder CONGLOMERATE, moderately sorted, weak to moderately cemented, light olive gray fine to coarse sandy matrix, very dense, slightly dry. @82' - Contact with 12" thick light olive gray fine to medium grained SANDSTONE, moderately indurated, very dense, slightly dry.	@82.4' Bedding/Channel N31E/41SE
85							
ADDITIONAL COMMENTS:					R = Recovery RQD = Rock Quality Designation Attitudes from downhole camera optical logging		

CLIENT: Pardee Homes					PROJECT: Skyline Ranch			W.O.: 8838
LOCATION: Santa Clarita					ELEVATION: 2265'±			DATE: 12/16/03
RIG TYPE: Core HQ-NQ2					HAMMER WEIGHTS: N/A			DROP: N/A
	R	U	B	RQD	Graphics	DESCRIPTION		ATTITUDES
80								
85	100%			77%		<p>@86' - Grades to 12" thick light olive gray fine to coarse grained SANDSTONE, moderately indurated, very dense, slightly dry.</p> <p>@88' - Sheared contact with 4" thick light olive gray fine grained SANDSTONE, moderately indurated, very dense, cut by 1-2mm olive gray shears, stiff, grooved.</p>		
90								
95	100%			79%		<p>@96.5' - 6" thick light olive gray fine to coarse grained SANDSTONE, moderately indurated, very dense, slightly dry.</p> <p>@97' - Sandy pebble-cobble-boulder CONGLOMERATE, poorly sorted, weak to moderately cemented, very dense, slightly dry.</p>		
100						<p>@99' - Diagenetic clay at grain contact (typically around larger clasts).</p> <p>@100' - 2" thick light olive gray very fine grained SANDSTONE, moderately indurated, very dense, slightly dry.</p>		
105	100%			78%		<p>@101.5' - Grades to fine to coarse grained SANDSTONE to gravel CONGLOMERATE.</p> <p>@103' - Grades to pebble-cobble-boulder CONGLOMERATE.</p> <p>@103.5' - 1mm thick slickenside oriented 60° oblique to fracture, soft to slightly stiff.</p> <p>@103.5-104' - Zone of shearing, reddish gray and light greenish gray randomly oriented shears (slickensides).</p>		
110						<p>@104-104.5' - Brown slickensides oriented 60° oblique to fracture.</p> <p>@105' - Sandy pebble-cobble-boulder CONGLOMERATE, weak to moderately cemented (finer clast better cemented), very dense, poorly to moderately sorted, slightly dry.</p>		
115	100%			94%		<p>@111-114' - 6-12" diameter boulders, poorly sorted.</p> <p>@114' - Predominantly pebbles and cobbles, weak to moderately cemented, very dense, slightly dry.</p>		
120						<p>@119' - Grades to light olive gray conglomeratic medium to coarse grained SANDSTONE, rounded to subangular clasts commonly gravel, occasional pebble-cobble, moderately sorted, weak to moderately indurated, very dense, slightly dry.</p>		
125								

ADDITIONAL COMMENTS:

R = Recovery
 RQD = Rock Quality Designation
 Attitudes from downhole camera optical logging

CLIENT: Pardee Homes					PROJECT: Skyline Ranch		W.O.: 8838
LOCATION: Santa Clarita					ELEVATION: 2265'±		DATE: 12/16/03
RIG TYPE: Core HQ-NQ2					HAMMER WEIGHTS: N/A		DROP: N/A
R	U	B	RQD	Graphics	DESCRIPTION	ATTITUDES	
120							
125	100%		100%		@125' - Grades to sandy CONGLOMERATE, round to subangular clasts commonly pebble to fine boulder, poor to moderately sorted, moderately cemented, very dense, slightly dry.		
130							
135	100%		77%		@135' - Light olive gray very fine grained SANDSTONE, moderately indurated, very dense, slightly dry with thin (1mm thick) steeply dipping joints of olive gray clay. @136' - Contact with sandy pebble-cobble-boulder CONGLOMERATE, poorly sorted, very weakly cemented, very dense, slightly dry. @138' - Grades to moderately sorted, moderately cemented, clasts commonly gravel to fine pebble, very dense, slightly dry. @140' - Occasional cobble-boulder.	@139.1' Approx. Channel N62W/45SW	
140					@143' - Increase in %cobbles.		
145	100%		77%		@146' - Moderately sorted pebbles-cobbles-boulders, greenish gray diagenetic clay at contact with rounded cobble, olive gray fine to coarse sandy matrix, moderately cemented.		
150							
155	100%		80%		@159' - Greenish gray thin diagenetic CLAY, surrounding rounded cobble-boulder clasts. @160' - CONGLOMERATE, grades finer to rounded to subangular clasts, commonly fine to coarse pebble, occasional fine to coarse cobble, moderately cemented, very dense, slightly dry. @162' - 6" thick olive gray fine grained SANDSTONE, moderately indurated.		
160							
165							
ADDITIONAL COMMENTS:					R = Recovery RQD = Rock Quality Designation Attitudes from downhole camera optical logging		

SURFACE DATA

LOG OF BORING B22

CLIENT: Pardee Homes					PROJECT: Skyline Ranch		W.O.: 8838
LOCATION: Santa Clarita					ELEVATION: 2265'±		DATE: 12/16/03
RIG TYPE: Core HQ-NQ2					HAMMER WEIGHTS: N/A		DROP: N/A
R	U	B	RQD	Graphics	DESCRIPTION	ATTITUDES	
160							
					@163' - Increase in %cobble-boulders, poorly sorted.		
165	100%		78%				
170					@170' - 12" thick olive gray fine grained SANDSTONE, moderately indurated.	@ 169.5' Approx. Channel	
					@173' - Olive gray fine grained SANDSTONE, moderately indurated with very thin to thin pebble-cobble interbeds, well sorted, very dense, slightly dry.	N79W/60SW	
175	100%		70%		@175' - Grading to poorly sorted pebble-cobble-boulder CONGLOMERATE, moderately cemented.	@ 171.1' B	
						N85W/21SW	
					@179' - Contact with conglomeratic SANDSTONE, dispersed pebbles and gravels.		
180					@181' - Grades to pebble-cobble-boulder CONGLOMERATE, poor to moderately sorted, olive gray fine to coarse grained sandy matrix, weak to moderately cemented, very dense, slightly dry.		
185	100%		75%		Total Depth - 185'		
190							
					<u>Groundwater Depth</u> <u>Date</u>		
					121' 12/22/03		
					167' 1/8/04		
195							
200					Backfilled 1/8/04		
205							

ADDITIONAL COMMENTS:

R = Recovery
 RQD = Rock Quality Designation
 Attitudes from downhole camera optical logging

BORING 22
 SKYLINE RANCH, VTMM 060922

DEPTH (ft)	DIP DIRECTION AZIMUTH (MAGNETIC)	DIP DIRECTION AZIMUTH CORRECTED TO TRUE NORTH ₁	STRIKE AZIMUTH ₂	STRIKE AND DIP OF FEATURE	TYPE OF FEATURE
2.2	320	306	216	N36E/58NW	TOP OF COBBLE
3.4	292	278	188	N8E/55NW	FRACTURE
6	215	201	111	N69W/26SW	BEDDING
8.9	334	320	230	N50E/10NW	FRACTURE
9.5	162	148	58	N58E/31SE	BEDDING
11.2	103	89	-1	N1W/56NE	CLASTS
14.6	162	148	58	N58E/42SE	CLASTS
16.3	246	232	142	N38W/40SW	CLASTS
16.7	8	-6	-96	N84E/33NW	CLASTS
17.5	110	96	6	N6E/33SE	BOTTOM OF CLAST
25.2	65	51	-39	N39W/10NE	BEDDING
26.5	346	332	242	N62E/55NW	CLASTS
26.8	30	16	-74	N74W/55NE	CLASTS
27.6	129	115	25	N25E/13SE	TOP OF CLAST
28.1	117	103	13	N13E/36SE	BOTTOM OF CLAST
29.3	221	207	117	N63W/23SW	APPX BEDDING
33.8	2	-12	-102	N78E/35NW	BOTTOM OF CLAST
43.1	8	-6	-96	N84E/47NW	TOP OF CLASTS
69.8	134	120	30	N30E/29SE	BEDDING
70.3	318	304	214	N34E/25NW	APPX BEDDING
73.7	28	14	-76	N76W/59NE	MUD ON SIDEWALL
75.8	173	159	69	N69E/10SE	BEDDING
82.4	135	121	31	N31E/41SE	BEDDING/CHANNEL
137.2	87	73	-17	N17W/40NE	BOTTOM OF CLAST
139.1	222	208	118	N62W/45SW	APPX CHANNEL
142.6	71	57	-33	N33W/28NE	TOP OF CLAST
143.1	184	170	80	N80E/34SE	BOTTOM OF CLAST
154.8	88	74	-16	N16W/52NE	TOP OF CLAST
169.5	205	191	101	N79W/60SW	APPX. CHANNEL
171.1	199	185	95	N85W/21SW	BEDDING

1. MAGNETIC DIP AZIMUTH CORRECTED 14 DEGREES TO TRUE NORTH

2. STRIKE AZIMUTH OF FEATURE OBTAINED FROM CORRECTED DIP AZIMUTH

3. OPTICAL LOG REVIEWED TO DETERMINE FEATURE TYPE

4. FEATURES IN BOLD CONSIDERED PERTINENT FOR PLOTTING ON GEOLOGIC MAP

SURFACE DATA

LOG OF BORING B23

CLIENT: Pardee Homes					PROJECT: Skyline Ranch		W.O.: 8838
LOCATION: Santa Clarita					ELEVATION: 2100±		DATE: 12/16/03
RIG TYPE: Bucket Auger					HAMMER WEIGHTS: Kelly Bar		DROP: 12"
	N	U	B	M	DD	DESCRIPTION	ATTITUDES
0						Saugus Formation: Medium brown silty SANDSTONE to very fine grained sandy SILTSTONE with frequent coarse grains and occasional gravels, dry, dense, occasional krotovina to 3' depth.	
5						@5' - Gray fine to coarse grained SANDSTONE with frequent gravels, dry, friable, dense, irregular scoured contact at bottom of unit. @7' - Medium brown clayey SANDSTONE to sandy CLAYSTONE with frequent coarse grains and infrequent gravels, moist, stiff. @8.5' - Gray fine to coarse grained silty SANDSTONE with frequent gravels, dry, slightly friable, dense.	@9.5' Approx. BN85E/15NW
10						@9.5' - Medium brown CLAYSTONE with occasional soft clay partings, moist, very stiff, massive. @12' - Grades to medium brown clayey SANDSTONE with frequent coarse grains and occasional gravels, slightly moist, dense.	@14.5' - Approx. BNS/7W
15	12	X			10.9 121.6	@14.5' - Medium brown CLAYSTONE with frequent coarse grains, moist, dense, massive. @15.5' - Grades to medium brown silty SANDSTONE with frequent coarse grains and small gravels, dry, dense. @19' - Grades to grayish brown fine to medium grained SANDSTONE with frequent coarse grains and small gravels, slightly friable, dry, dense. @21' - Olive gray brown silty fine grained SANDSTONE to sandy SILTSTONE, massive, moist, dense. @23' - Grades to medium brown clayey SILTSTONE with frequent coarse grains, moist, stiff. @25' - Grades to medium brown silty fine grained SANDSTONE, moist, dense.	@29' - Approx. BN35W/9NE @29.5' - Approx. BN28W/21NE @32.5' Approx. BN18E/20NW
20							
25							
30						@29' - 3" thick medium to coarse grained SAND lens. @29.5' - Medium brown fine to coarse grained SANDSTONE with gravels, slightly moist, dense. @32' - Medium brown clayey SILTSTONE to silty CLAYSTONE. @32.5' - 4" "corn flakey" sheared reddish brown CLAYSTONE, moist, grading to slightly clayey SANDSTONE to silty SANDSTONE with frequent coarse grains, moist, massive, dense.	
35	13	X			16.3 112.8		
40						@40' - Gray fine to coarse grained SANDSTONE with occasional gravels, dry, friable. @40.5' - Scoured/channeled dark medium silty CLAYSTONE to clayey silty SANDSTONE with frequent coarse grains, moist, massive.	
45							
ADDITIONAL COMMENTS:					Blows for 12" interval using California Split-Barrel Sampler Kelly Bar Weights: 0 - 24', 2800 lbs. 25 - 47', 1800 lbs. 48 - 70', 800 lbs.		

SURFACE DATA

LOG OF BORING B23

CLIENT: Pardee Homes					PROJECT: Skyline Ranch		W.O.: 8838
LOCATION: Santa Clarita					ELEVATION: 2100±		DATE: 12/16/03
RIG TYPE: Bucket Auger					HAMMER WEIGHTS: Kelly Bar		DROP: 12"
	N	U	B	M	DD	DESCRIPTION	ATTITUDES
40							
45		X		5.8	112.4	@44' - Grades to red brown silty fine grained SANDSTONE, slightly moist, dense, massive. @46' - Gray brown fine to coarse grained SANDSTONE with gravels and infrequent cobbles. @48' - Irregular, scoured contact on red sandy CLAYSTONE, moist, dense.	@47' - Approx. BNS/4E
50						@51' - Grades to medium brown fine grained silty SANDSTONE with gradational interbeds of SILTSTONE, massive, moist. @53' - Gray fine to medium grained SANDSTONE with coarse grains, friable, dry to slightly moist.	
55						@53.5' - Irregular, scoured contact on clayey sandy SILTSTONE to silty SANDSTONE with frequent coarse grains and occasional small gravels, moist, massive. @55' - 1" "corn flakey" sheared CLAYSTONE bed, moist.	@55' - Approx. BN5W/3SW
60	37	X		11.5	124.8	@56.5' - Grades to friable fine to coarse grained SANDSTONE lens. @57' - Dark red CLAYSTONE, moist, stiff. @58' - Grades to red brown slightly clayey silty SANDSTONE with frequent coarse grains, moist, dense, massive. @60' - 6" red CLAYSTONE bed.	
65						@61' - Olive brown silty fine to coarse grained SANDSTONE with infrequent gravels, slightly moist, massive, dense. @62' - Fining downward to medium brown silty SANDSTONE, moist.	@67.5' - Approx. BN35W/6SW
70						@63.5' - Grades to medium olive brown clayey SILTSTONE, moist, massive, dense. @64.5' - Increasing gravels and coarse grains. @66' - Reddish brown clayey sandy SILTSTONE to clayey silty SANDSTONE.	@69' - Approx. BN35W/8SW
75						@67.5' - Dark red silty CLAYSTONE, moist, massive, dense. @68.5' - Red brown fine to coarse grained SANDSTONE with silty interbeds, moist, dense. @69.5' - CLAYSTONE bed, moist.	@69.5' - Approx. BN15W/9SW
80						@70.5' - Grades to red clayey SANDSTONE with coarse grains and infrequent gravels, massive, slightly moist. @74' - Grades to olive brown sandy CLAYSTONE with frequent coarse grains and occasional gravels, massive, slightly moist, dense.	
85						@76' - Red brown clayey SANDSTONE with frequent coarse grains and small gravels, dense, dry to slightly moist. @81' - Mixed contact with olive gray fine to medium grained SANDSTONE with frequent coarse grains and infrequent gravels, tightly packed, cemented, crudely to poorly graded, dry, hard.	@82' - Approx. BN15W/20SW
ADDITIONAL COMMENTS:						Blows for 12" interval using California Split-Barrel Sampler Kelly Bar Weights: 0 - 24', 2800 lbs. 25 - 47', 1800 lbs. 48 - 70', 800 lbs.	





SURFACE DATA



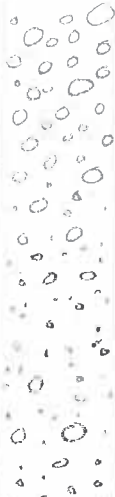

LOG OF BORING B23

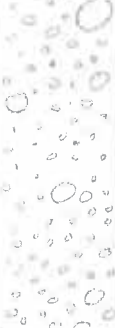
CLIENT: Pardee Homes					PROJECT: Skyline Ranch			W.O.:8838	
LOCATION: Santa Clarita					ELEVATION: 2100'±			DATE: 12/16/03	
RIG TYPE: Bucket Auger					HAMMER WEIGHTS: Kelly Bar			DROP:12"	
	N	U	B	M	DD	DESCRIPTION			ATTITUDES
80						@83' - Increase in gravel. @86' - Coarsening to include cobble lenses. @88' - Gray gravelly CONGLOMERATE with cobbles within fine to medium sand matrix, well cemented, very dense and hard, dry. Total Depth - 95' No groundwater Backfilled			@84' - Approx. BN5W/16SW @87' - Approx. BN5E/14SE
85									
90									
95									
100									
105									
110									
115									
120									
125									
ADDITIONAL COMMENTS: Blows for 12" interval using California Split-Barrel Sampler Kelly Bar Weights: 0 - 24', 2800 lbs. 25 - 47', 1800 lbs. 48 - 70', 800 lbs.									

CLIENT: Pardee Homes		PROJECT: Skyline Ranch		W.O.: 8838		
LOCATION: Santa Clarita		ELEVATION: 1830'		DATE: 12/19/03		
RIG TYPE: Core HQ-NQ2		HAMMER WEIGHTS: N/A		DROP: N/A		
R	U	B	RQD	Graphics	DESCRIPTION	ATTITUDES
0					Saugus Formation: Weathered, no recovery.	
5	40%		35%		Light brown medium to coarse grained SANDSTONE with gravels, moist to dry, moderately cemented, dense, iron oxide stains. @8.5' - Light brown conglomerate with granitic clasts, subangular to subrounded, moderately cemented, moist to dry, dense, moderately friable, iron oxide stains.	
10					Light gray slightly clayey medium grained SANDSTONE with gravels up to 1" diameter, subangular, moist, dense, moderately friable. @12' - Light brown to gray sandy CONGLOMERATE, dry to moist, dense, slightly friable to moderately cemented, clasts up to 3" diameter, some 1"-2" thick interbeds of light gray medium grained SANDSTONE with sparse pebbles.	@ 11' Dip of Bedrock Approx. 10°
15	65%		57%		@18'3" - Medium to dark reddish brown sandy CLAY, very firm, dry, no porosity observed.	@ 19' Dip of Bedrock 15-20°
20					@18'6" - Medium brown to light brown sandy CONGLOMERATE, matrix supported, slightly friable, moderately cemented, dry, dense. @22.5' - Light gray to grayish brown medium grained SANDSTONE with scattered pebbles, moderately to well sorted, slightly friable, moist, dense, massive.	
25	80%		70%		@23' - <u>Mint Canyon Formation</u> @24' - Light gray CONGLOMERATE to SANDSTONE with abundant gravels, granitic clasts, moist, dense, moderately cemented.	@ 26' Dip of Bedrock Approx. 15-20°
30					@32.5' - Light gray medium to coarse grained SANDSTONE with sparse pebbles, moist, moderately to well sorted, dense, massive.	
35	65%		63%		@37.5' - Light gray to light brown interbedded coarse grained SANDSTONE with gravels and CONGLOMERATE (lesser amounts of sandstone up to 8" thick), moist, dense.	@ 38' Dip of Bedrock Approx. 20°
40					Light gray sandy coarse grained CONGLOMERATE, dense, moist, moderately cemented.	
45						

ADDITIONAL COMMENTS: R = Recovery
 RQD = Rock Quality Designation
 Dip inclinations from core examination

CLIENT: Pardee Homes					PROJECT: Skyline Ranch		W.O.: 8838
LOCATION: Santa Clarita					ELEVATION: 1830'		DATE: 12/19/03
RIG TYPE: Core HQ-NQ2					HAMMER WEIGHTS: N/A		DROP: N/A
R	U	B	RQD	Graphics	DESCRIPTION		ATTITUDES
40							
45	75%		55%		Light gray medium to coarse grained CONGLOMERATE, dense, moist, moderately cemented.		
50					Sandy pebble-cobble-boulder CONGLOMERATE, moderately sorted, rounded to subangular clasts commonly pebble-gravel, occasional	@50'	Dip of Bedrock Approx. 15-20°
55	100%		64%		Sandy CONGLOMERATE to clayey sandy CONGLOMERATE with occasional cobbles, slightly moist, dense, thin film of clay between outer surface of clasts and matrix, weathering of feldspars.		
60					@62' - Thin 2" thick black sandy CLAY to clayey SAND, abundant mafic minerals, moist, dense.		
65	100%		77%		Very coarse grained CONGLOMERATE, poorly sorted, round to subangular clasts commonly gravel to very friable with significant cobbles. Light olive gray fine to coarse grained sandy matrix, weakly cemented, very dense, slightly dry.	@70'	Dip of Bedding 15°
70							
75	100%		44%				
80					@81-81.5' - No recovery. 6" thick coarse grained SANDSTONE interbed with thin bedded pebble channel, weak to moderately indurated, very dense, slightly dry.	@83'	Dip of Bedding 10°
85							
ADDITIONAL COMMENTS:					R = Recovery RQD = Rock Quality Designation Dip inclinations from core examination		

CLIENT: Pardee Homes					PROJECT: Skyline Ranch		W.O.:8838
LOCATION: Santa Clarita					ELEVATION: 18 5'		DATE: 12/19/03
RIG TYPE: Core HQ-NQ2					HAMMER WEIGHTS: N/A		DROP:N/A
	R	U	B	RQD	Graphics	DESCRIPTION	ATTITUDES
80							
85	100%			74%		Light olive brown to light gray pebble-cobble CONGLOMERATE, very dense, moist, clasts up to 6" diameter, subangular to subrounded, moderately cemented.	@85' Dip of Bedding 10°
90							
95	100%			95%		Light gray to olive brown coarse grained SANDSTONE with abundant angular gravels, clasts up to 1" diameter (typically 1-2cm), very dense, moderately cemented. @95' - Light olive brown pebble CONGLOMERATE with occasional cobbles, fine to coarse grained sand matrix, slightly moist, very dense. @97' - Light olive brown clayey SANDSTONE with abundant angular to subangular gravels (occasional clasts up to 2" diameter), moist, very dense.	
100							
105	65%			59%		@97.5' - Light olive brown pebble CONGLOMERATE with occasional cobbles, fine to coarse grained clayey sandy matrix, moist, very dense. @100' - Light brown pebble-gravel CONGLOMERATE with fine to coarse grained clayey sand matrix, very dense, moist, very poorly sorted, massively bedded.	
110							
115	100%			77%		@107.5' - Light olive brown clayey fine to coarse grained SANDSTONE with gravels, moderately to poorly sorted, moist, very dense, sparse cobbles. Light brown pebble-gravel CONGLOMERATE, very dense, slightly moist, driller hit 1' diameter boulder (in bottom of sampler). @111' - Olive gray conglomeratic coarse grained SANDSTONE, clasts commonly gravel, moderately indurated, moderately sorted, very dense. @112' - Increase in pebble-cobble, poorly and moderately sorted, moderately cemented. @113' - Interbedded (up to 12" thick) pebble-cobble-boulder CONGLOMERATE, moderately cemented. @117' - 6" thick light olive gray medium to coarse grained SANDSTONE, moderately indurated, very dense, slightly dry.	@111.5' Dip of Bedding 10-15°
120							
125						Total Depth - 120' Backfilled	

ADDITIONAL COMMENTS:

R = Recovery
 RQD = Rock Quality Designation
 Dip inclinations from core examination

SURFACE DATA

LOG OF BORING B25

CLIENT: Pardee Homes					PROJECT: Skyline Ranch		W.O.: 8838
LOCATION: Santa Clarita					ELEVATION: 2005'		DATE: 12/18/03
RIG TYPE: 24" Bucket					HAMMER WEIGHTS: Kelly Bar Weights		DROP: 12"
	N	U	B	M	DD	DESCRIPTION	ATTITUDES
0						<u>Saugus Formation</u> : Light yellow brown clayey fine grained SAND, medium dense, 1-2mm diameter pores, rootlets to 2'. Red brown clayey SAND to sandy CLAY, blocky structure. Red brown clayey fine grained SANDSTONE, blocky structure, calcium carbonate veins.	@3' Fracture NdueE/35S
5						Grades downward to brown to reddish brown conglomeratic fine to coarse grained SANDSTONE, subrounded to subangular clasts commonly pebble-gravel, occasional cobble. @8' - Pebble channel bed, moderately to poorly sorted, very dense, weak to moderately indurated.	@8' B N45E/18NW
10						@9.5' - Grades downward to conglomeratic coarse grained SANDSTONE. @11' - Sharp contact with red brown clayey fine grained SANDSTONE, very dense, moderately indurated.	@11' B N10E/2SE
15	15	X				Grades downward to gray to light olive gray conglomeratic very coarse grained SANDSTONE, clasts commonly gravel, poorly bedded, weak to moderately indurated. @17' - Increase in % pebble-cobble clasts, grading to conglomeratic SANDSTONE, commonly pebble-cobble. @18.5' - Grades downward to red brown fine to medium grained SANDSTONE, very dense, weak to moderately indurated.	
20						@20' - Interbed of gravelly coarse grained SANDSTONE. @20.5' - Grading to sandy CONGLOMERATE, highly channelized, clasts commonly pebble-cobble, occasional boulder, poorly sorted, weak to moderately cemented, very dense. Grades to gravelly CONGLOMERATE with occasional pebble-cobble, weakly cemented.	
30	20	X				@30.5' - Scoured contact with red brown clayey fine grained SANDSTONE, very dense, weakly indurated, slightly dry.	
35						Grades downward to red brown fine to coarse grained SANDSTONE and conglomeratic SANDSTONE, commonly pebble-cobble. Coarse grained SANDSTONE interbed.	@39' B N50E/10SE
40							
45	23	C					
ADDITIONAL COMMENTS:							Kelly Bar Weights: 0 - 24', 2800 lbs. 25 - 47', 1800 lbs. ≥48', 800 lbs. Blows per 12" using California Split Barrel Sampler

SURFACE DATA

LOG OF BORING B25

CLIENT: Pardee Homes					PROJECT: Skyline Ranch		W.O.: 8838
LOCATION: Santa Clarita					ELEVATION: 2005'		DATE: 12/18/03
RIG TYPE: 24" Bucket					HAMMER WEIGHTS: Kelly Bar Weights		DROP:
N	U	B	M	DD	DESCRIPTION	ATTITUDES	
40							
45					Continued conglomeratic SANDSTONE, clasts commonly pebble size. @46.5' - Sharp contact with red brown clayey fine grained SANDSTONE, very dense, slightly dry. Minor CLAYSTONE, hard, grooved. Grades downward to interbedded coarse grained SANDSTONE and pebble-cobble CONGLOMERATE (2"-6" thick), weakly indurated, very dense, slightly dry.	@46.5' Contact N5W/10SW	
50					Contact with red brown CLAYSTONE.	@51' B N20W/10SW	
55					Grades downward to red brown coarse grained SANDSTONE and conglomeratic SANDSTONE, clasts commonly pebble-gravel, massive, slightly friable to weakly cemented, very dense, slightly dry.		
60	43	X					
65							
70					Contact with red brown fine to coarse grained SANDSTONE, weakly to moderately indurated, very dense, slightly dry. Contact with red brown CLAYSTONE, hard.	@69' Contact N45E/5SE @71' Contact N20W/10SW	
75					Contact with pebble-cobble CONGLOMERATE, weakly to moderately cemented, poorly bedded, very dense, slightly dry.	@74' Contact N10E/5W	
80					Total Depth - 80' No groundwater No caving Backfilled		
85							
ADDITIONAL COMMENTS:					Kelly Bar Weights: 0 - 24', 2800 lbs. 25 - 47', 1800 lbs. ≥48', 800 lbs. Blows per 12" using California Split Barrel Sampler		

SURFACE DATA

LOG OF BORING B26

CLIENT: Pardee Homes					PROJECT: Skyline Ranch		W.O.: 8838
LOCATION: Santa Clarita					ELEVATION: 1893'		DATE: 12/19/03
RIG TYPE: 24" Bucket					HAMMER WEIGHTS: Kelly Bar Weights		DROP: 12"
N	U	B	M	DD	DESCRIPTION	ATTITUDES	
0					Landslide Debris: Brown silty fine to medium grained SANDSTONE with dispersed gravel-pebble, very dense, slightly dry.		
5							
10					Scoured contact with gray brown medium to coarse grained SANDSTONE and gravelly SANDSTONE, massive, dispersed pebble-gravel, weakly indurated, very dense, slightly dry, grading downward to poorly bedded, massive pebble conglomerate.	@9' Contact BdueE/60N BN70E/22NW	
15	8	X			Contact with red to light brown silty fine grained SANDSTONE, weakly indurated, very dense, slightly dry. @13.5' - 1mm thick carbonate fracture. @14' - Scoured contact with gray brown pebble-gravel CONGLOMERATE, weakly indurated, very dense. @17' - Grades downward to interbedded coarse grained SANDSTONE and pebble gravel CONGLOMERATE.	@13' Contact BN70W/15SW @13.5' Fracture N50E/55NW @17' B N85W/22SW	
20						@21' B N50E/24SE	
25						@24' B N50E/25SE	
30	26	X			Scoured contact with 6"-12" thick red brown clayey fine grained SANDSTONE, very dense, slightly moist to slightly dry, sharp lower contact with red brown pebble-cobble conglomerate.	@30' Lower contact BN75W/11SW @31' slide plane N70E/25SE	
35					@31' - <u>Landslide Plane</u> : Sharp contact (possible slide plane) with red brown CLAY, on top of clayey fine grained SANDSTONE, weakly indurated, very dense, slightly moist.	@34' B N50E/24NW	
40					@34' - <u>Saugus Formation</u> : SANDSTONE stringer, discontinuous across boring. @37' - Grades downward to gray brown coarse grained SANDSTONE and interbedded pebble-gravel CONGLOMERATE.	@38' B N70E/24SE	
45	35	X				@42' B N40E/25SE	

ADDITIONAL COMMENTS: Kelly Bar Weights: 0 - 24', 2800 lbs.
25 - 47', 1800 lbs.
≥48', 800 lbs.
Blows per 12" using California Split Barrel Sampler

SURFACE DATA

LOG OF BORING B26

CLIENT: Pardee Homes					PROJECT: Skyline Ranch		W.O.: 8838
LOCATION: Santa Clarita					ELEVATION: 1893'		DATE: 12/19/03
RIG TYPE: 24" Bucket					HAMMER WEIGHTS: Kelly Bar Weights		DROP: 12"
	N	U	B	M	DD	DESCRIPTION	ATTITUDES
40							
45						12" thick red brown clayey fine grained SANDSTONE, moderately indurated, very dense, moist. @47' - Contact with gray brown coarse grained SANDSTONE and interbedded pebble-gravel, well sorted, thinly bedded.	@47' Contact BN70E/24SE
50						@52.5' - Sharp contact with red brown sandy CLAYSTONE, hard, moist. @53.5' - Shear plane (1mm thick), slightly stiff to stiff, moderately developed slickensides, to clayey SILTSTONE, hard, moist.	@51.5' B N65E/23SE @52.5' Contact BN65E/18SE @53.5' Shear N40W/37NE
55			X			Grading to pebble-gravel CONGLOMERATE in a moist red brown clayey fine sandstone matrix, weakly cemented.	@57' B N65E/25SE
60						Soft red brown CLAY (1/2" thick), sheared, very moist, underlain by red brown very clayey very fine grained SANDSTONE, very dense, very moist.	@61' Shear N45E/46NW
65							
70						Total Depth - 68' No groundwater No caving	
75							
80							
85							

ADDITIONAL COMMENTS: Kelly Bar Weights: 0 - 24', 2800 lbs.
25 - 47', 1800 lbs.
≥48', 800 lbs.
Blows per 12" using California Split Barrel Sampler

SURFACE DATA

LOG OF BORING B27

CLIENT: Pardee Homes					PROJECT: Skyline Ranch			W.O.: 8838	
LOCATION: Santa Clarita					ELEVATION: 1930'			DATE: 12/22/03	
RIG TYPE: 24" Bucket					HAMMER WEIGHTS: Kelly Bar Weights			DROP: 12"	
	N	U	B	M	DD	DESCRIPTION			ATTITUDES
0						Landslide Debris: Weathered to 5', Olive brown sandy CLAY, medium dense to dense, slightly moist.			
5						Grades downward to orange brown clayey fine to medium grained SANDSTONE with dispersed sparse pebble-gravel, medium dense to dense, moist, slightly friable, massive.			
10						Thinly bedded (1" thick) hard red brown CLAY.			
15	6	C				Grades downward to yellow brown fine to coarse grained SANDSTONE with dispersed abundant pebble-gravel, slightly friable, dense, slightly moist.			@18.5' contact BN45W/25SW
20						@18.5' - Scoured contact with red brown very clayey fine grained SANDSTONE, weakly indurated, dense, moist. @21.5' - <u>Landslide Plane</u> : Red brown sheared CLAY (1"-2" thick), with scattered schist cobbles.			@21.5' Shear N45W/24SW
25						<u>Saugus Formation</u> : Red brown clayey fine grained SANDSTONE with coarse gravel channels, weakly indurated, very dense, slightly moist, overlying conglomeratic SANDSTONE, scoured contact.			
30	40	C				@29.5' - 1"-2" thick red brown CLAY, slightly stiff to soft, over red brown clayey fine grained SANDSTONE, massive, weakly indurated, very dense, slightly moist. Red brown to brown coarse grained SANDSTONE and conglomeratic SANDSTONE, friable, very dense, slightly moist.			@29.5' B N70W/7SW @32' B N45W/8SW
35									
40						1" thick red brown CLAY, stiff to hard, over red brown clayey fine to medium grained SANDSTONE with dispersed gravel, weakly indurated, very dense, moist.			@39' B N60W/6NE
45	40	C							
ADDITIONAL COMMENTS: Kelly Bar Weights: 0 - 24', 2800 lbs. 25 - 47', 1800 lbs. ≥48', 800 lbs. Blows per 12" using California Split Barrel Sampler									

SURFACE DATA

LOG OF BORING B27

CLIENT: Pardee Homes					PROJECT: Skyline Ranch		W.O.: 8838	
LOCATION: Santa Clarita					ELEVATION: 1930'		DATE: 12/22/03	
RIG TYPE: 24" Bucket					HAMMER WEIGHTS: Kelly Bar Weights		DROP: 12"	
	N	U	B	M	DD	DESCRIPTION	ATTITUDES	
40						Gravelly coarse grained SANDSTONE, slightly friable, wet. Groundwater seepage at 46'. Total Depth - 52' Seepage at 46' No caving		
45								
50								
55								
60								
65								
70								
75								
80								
85								

ADDITIONAL COMMENTS: Kelly Bar Weights: 0 - 24', 2800 lbs.
 25 - 47', 1800 lbs.
 ≥48', 800 lbs.
 Blows per 12" using California Split Barrel Sampler

SUBSURFACE DATA

LOG OF BORING B28

CLIENT: Pardee Homes					PROJECT: Skyline Ranch			W.O.: 8838	
LOCATION: Santa Clarita					ELEVATION: 1770±			DATE: 7/16/04	
RIG TYPE: 24" Bucket					HAMMER WEIGHTS: Kelly Bar Weights			DROP: 12"	
	N	U	B	M	DD	DESCRIPTION			ATTITUDES
0						Terrace Deposits: Dark red clayey SANDSTONE to sandy CLAYSTONE with frequent coarse grains and small gravels, damp, dense, dessication cracks to 4'. @1.5' - Medium brown silty MUDSTONE with occasional coarse grains and occasional gravels, dry, dense, massive, abundant rootlets and root hairs. @2.5' - Coarsening to silty fine to coarse grained SANDSTONE with subround to subangular gravels and occasional cobbles, dry, dense. @4' - Fining to fine to coarse grained SANDSTONE with occasional gravels, poorly graded, coarsening downward.			
5									@5' approx on graded lens N57W/15NE
10	9			2.8	113.7	@7.5' - Saugus Formation: Scoured contact on medium brown fine silty SANDSTONE to SILTSTONE with frequent coarse grains and occasional subangular gravels and cobbles, damp. @10' - Gradational coarsening to fine to coarse grained SANDSTONE with occasional subround to subangular gravels and cobbles, coarsening downward, damp, friable, dense. @12' - Light grayish medium to coarse grained SANDSTONE with occasional subround gravels, weakly graded sequences, damp, friable. @14' - Scoured wedge of light brown fine grained SANDSTONE, damp. @15' - Weakly graded (well sorted) fine to coarse grained SANDSTONE with occasional subround gravels, damp, friable, coarsening downward. @16.5' - Light brown fine grained SANDSTONE, massive, damp. @18' - Coarsening to fine to coarse grained SANDSTONE with frequent subround gravels, crudely graded sequences, coarsening downward. @19' - Light brown fine to medium grained SANDSTONE underlain by cobbles, damp, friable, weakly cross bedded. @20.5' - Light brown fine grained SANDSTONE coarsening downward to fine to coarse grained SANDSTONE with frequent subround gravels, with coarse graded lenses, damp, friable, cross bedded sequences.			@7.5' contact, approx. N86E/10NW
15									@13' graded lens N25W/6NE approx
20	10			3.2	123.3	@22' fine to med. sand lens, approx N62E/10NW @24' gravelly lens N38W/11SW approx. @27' gravelly lens N10E/6NW approx @30' fine lens N65W/5SW approx.			
25									
30	30			4.0	119.6	@30' - Alternating fine to coarse grained SANDSTONE and medium to coarse grained gravelly SANDSTONE sequences, damp, friable. @33' - 6" cobble zone. @35' - Finer grained, well graded sequences, mineral laminations to coarse sands, damp, dense, friable. @38-39.5' - Clayey SILT to SILT lens 3.5" thick, moist.			
35									@37' gravelly lens N35W/6SW approx.
40	40			3.5	111.4	@40' - Coarsening to medium to coarse grained gravelly SANDSTONE, crudely graded, friable, damp. @41' - Fine grained SANDSTONE with mineral laminations.			@38' B N30E/8NW approx @38.5' B N25E/8NW approx @41.5' B N60E/8NW approx
45									
ADDITIONAL COMMENTS:					Blows per 12" Kelly Bar Weights: 0 - 24', 3800 lbs. 24 - 47', 2800 lbs. 48 - 74', 1800 lbs. 75 - 93', 1100 lbs.				

SURFACE DATA

LOG OF BORING B28

CLIENT: Pardee Homes					PROJECT: Skyline Ranch			W.O.: 8838
LOCATION: Santa Clarita					ELEVATION: 1770'±			DATE: 7/16/04
RIG TYPE: 24" Bucket					HAMMER WEIGHTS: Kelly Bar Weights			DROP: 12"
	N	U	B	M	DD	DESCRIPTION		ATTITUDES
40						@42' - Coarsening to medium to coarse grained gravelly SANDSTONE with occasional cobbles, damp, friable, cross bedded/channeled sequences.		
45								
50	60			3.7	111.6			@48' B approx. ± horizontal
55						Coring from 57-59'.		@51' B approx. N85E/5NW
60						Total Depth - 59', refusal at 59' No groundwater		
65								
70								
75								
80								
85								

ADDITIONAL COMMENTS: Blows per 12"
 Kelly Bar Weights: 0 - 24', 3800 lbs.
 24 - 47', 2800 lbs.
 48 - 74', 1800 lbs.
 75 - 93', 1100 lbs.

CLIENT: Pardee Homes					PROJECT: Skyline Ranch		W.O.: 8838
LOCATION: Santa Clarita					ELEVATION: 1685'±		DATE: 7/22/04
RIG TYPE: 24" Bucket					HAMMER WEIGHTS: Kelly Bar Weights		DROP: 12"
	N	U	B	M	DD	DESCRIPTION	ATTITUDES
0						<u>Saugus Formation</u> : Medium brown silty SANDSTONE, dry, medium dense, frequent scattered gravels.	
5						Medium brown silty SANDSTONE, dry, crudely graded, friable, scattered subrounded gravels.	
10	5	X			9.6	110.1	@10-12' - Irregular contact on medium brown slightly clayey silty SANDSTONE to silty slightly clayey SANDSTONE with frequent coarse grains, moist. @12' - 4" lens of pinkish brown clayey SAND with frequent coarse grains, grades to medium brown silty SANDSTONE with frequent scattered coarse grains and subangular gravels, damp, massive, local friable sandy pockets, possibly krotovina. @14-18' - Medium brown sandy SILTSTONE, mottled with white calcium carbonates, damp, abundant scattered subrounded to subangular gravels coated with white calcium carbonates. @18' approx. B N30W/5NE
15							
20	6	X			3.0	---	@19' - Abundant cobbles. @20' approx. B N15W/15NE @20' approx. B N5W/16NE
25							@25' approx. B NS/8E gravelly bed
30	10	X			3.6	120.3	@26-28' - Grades to include cobbles, subrounded. @28-30' - Medium brown sandy SILTSTONE to silty fine grained SANDSTONE, damp, frequent coarse grains, massive. @30' - Gravelly fine to coarse grained friable SANDSTONE, coarsening downward sequence to include gravels and occasional cobbles. @31-36' - Medium brown silty fine to medium grained SANDSTONE with occasional subrounded gravels and cobbles, damp, massive, medium dense, grades to gray fine to coarse grained SANDSTONE lenses, surfaces are irregular and scoured. @36' - Grades to irregular contact on gray fine to coarse grained gravelly SANDSTONE, moderately well graded, coarsening downward sequences, friable, damp.
35							
40	8	X			4.6	115.1	@41' - Red sandy CLAYSTONE pocket/discontinuous bed, moist, sheared, possibly a fault, grading down to gray clayey SAND. @41' fault? N45E/46NW @43' - 6" bed of red CLAYSTONE, sheared, randomly oriented, shears with dark brown manganese staining, becoming sandy CLAYSTONE, moist. @43' BN15E/60NW BN3W/47NW
45			X				
ADDITIONAL COMMENTS:							Kelly Bar Weights: 0 - 24', 3800 lbs. 25 - 48', 2800 lbs. 48 - 69', 1800 lbs. 70 - 93', 1100 lbs. > 94', 2000 lbs.

SURFACE DATA

LOG OF BORING B29

CLIENT: Pardee Homes					PROJECT: Skyline Ranch		W.O.: 8838
LOCATION: Santa Clarita					ELEVATION: 1685'±		DATE: 7/22/04
RIG TYPE: 24" Bucket					HAMMER WEIGHTS: Kelly Bar Weights		DROP: 12"
	N	U	B	M	DD	DESCRIPTION	ATTITUDES
40							
45						@44.5' - Grades to gray fine to coarse grained SANDSTONE with occasional gravel. @46.5' - Irregular contact on clayey silty fine grained SANDSTONE, moist, faulted with 4" offset. @48.5' - 1"-1.5" seam of red grayish brown CLAY, moist, soft, overlying gray CLAYSTONE, massive, sheared with abundant white calcium carbonate staining and nodules at upper contact. @50' - Grades to gray fine gfained SANDSTONE, lightly mottled with light brown, damp, massive. @52' - Grades to medium brown SILTSTONE. @53' - Dark brown to olive brown CLAYSTONE, sheared on upper 6", shiny discontinuous surfaces, abundant hard carbonate nodules, damp, firm, cemented beneath 6" zone. @54.5' - Coarsening downwards to medium brown clayey SANDSTONE with abundant coarse grains, subrounded to subangular, weakly cemented, massive, hard.	@48.5' soft clay seam BN5E/12W
50	45	X			17.1	115.2	
55							@53.5' approx. B N55W/20SW
60	50	X			15.9	117.8	
65							@63' approx. B N18E/24SE
70	45	X			4.9	113.8	
75							@68' approx. B N33W/3SW @69' approx. B N13W/5SW
80	30	X			9.3	124.3	
85							@71-73' - Coarsening to include cobbles and boulders. @78-79' - Coarsening to include cobbles and boulders. @79' - Medium gray brown fine grained SANDSTONE with thinly graded sequences, moderately well graded coarsening downward. @81' - Coarsening to include coarse grained sandy graded sequences. @82-84' - Faulted brown SILTSTONE and gray medium to coarse grained SANDSTONE, damp, hard.
ADDITIONAL COMMENTS: Kelly Bar Weights: 0 - 24', 3800 lbs. 25 - 48', 2800 lbs. 48 - 69', 1800 lbs. 70 - 93', 1100 lbs. > 94', 2000 lbs.							

SURFACE DATA

LOG OF BORING B29

CLIENT: Pardee Homes						PROJECT: Skyline Ranch						W.O.: 8838	
LOCATION: Santa Clarita						ELEVATION: 1685'±						DATE: 7/22/04	
RIG TYPE: 24" Bucket						HAMMER WEIGHTS: Kelly Bar Weights						DROP: 12"	
	N	U	B	M	DD	DESCRIPTION						ATTITUDES	
80						@84' - Gray SANDSTONE coarsening to gravelly SANDSTONE grading downward to CONGLOMERATE, cemented, hard, irregular, scoured surface.							
85													
90	30	X		7.5	113.2	@93.5' - Gray CLAYSTONE, damp, massive, hard. @95.5-100' - Gray CONGLOMERATE, massive, hard and cemented.						@94' approx. B N40W/27SW	
95													
100	20	X		5.9	127.8	Total Depth - 100', refusal on cemented conglomerate No groundwater No caving							
105													
110													
115													
120													
125													

ADDITIONAL COMMENTS: Kelly Bar Weights: 0 - 24', 3800 lbs.
 25 - 48', 2800 lbs.
 48 - 69', 1800 lbs.
 70 - 93', 1100 lbs.
 > 94', 2000 lbs.

SUBSURFACE DATA

LOG OF BORING B30

CLIENT: Pardee Homes					PROJECT: Skyline Ranch		W.O.: 8838
LOCATION: Santa Clarita					ELEVATION: 1518'		DATE: 3/24/06
RIG TYPE: 6" HSA					HAMMER WEIGHTS: 140 lbs.		DROP: 30"
	N	U	B	M	DD	DESCRIPTION	ATTITUDES
0			X			Alluvium: Brown silty fine to coarse grained SAND with gravel and cobbles, abundant root hairs, loose, moist.	
			X				
			X				
			X				
5	17/22/19	C		2.2	125.0	Light gray gravelly SAND, medium dense, dry.	
10	15/50-6"	C				Tan to light gray sandy GRAVEL, friable, dry (no sample recovered).	
15	50-3"	C				Tan to light gray sandy GRAVEL, friable, dry (no sample recovered).	
20	50-5"	C				Tan to light gray sandy GRAVEL, friable, dry (no sample recovered).	
25	8/13/26	C		5.6	121.9	Olive to tan gravelly fine to coarse grained SAND, friable, medium dense, moist.	
30						Refusal on boulder Total Depth - 30' No groundwater No caving	
35							
40							
45							
ADDITIONAL COMMENTS:						Blows per 6" unless otherwise noted C = California Sampler	

SUBSURFACE DATA

LOG OF BORING B31

CLIENT: Pardee Homes					PROJECT: Skyline Ranch		W.O.: 8838
LOCATION: Santa Clarita					ELEVATION: 1518'		DATE: 3/24/06
RIG TYPE: 6" HSA					HAMMER WEIGHTS: 140 lbs.		DROP: 30"
	N	U	B	M	DD	DESCRIPTION	ATTITUDES
0						<u>Alluvium</u> : Brown silty fine to coarse grained SAND with gravel and cobbles, very dense at surface, but loose at 6" below surface, moist.	
5	12/21/32	C		3.2	116.7	Tan silty gravelly fine to coarse grained SAND, friable, loose, moist. @7' - Drilling through cobbles.	
10	50-5"	C		--	--	Tan gravelly fine to coarse grained SAND, friable, dry (no sample recovered).	
15	21/35/33	C		3.0	132.8	Tan gravelly fine to coarse grained SAND with cobbles, friable, dense, dry to moist.	
20	50-4"	C				Tan gravelly fine to coarse grained SAND with small cobbles, friable, dry (no sample recovered).	
25	50-0"		S			Refusal on cobble/boulder. Total Depth - 25' No groundwater No caving	
30							
35							
40							
45							

ADDITIONAL COMMENTS: Blows per 6" unless otherwise noted
 C = California Sampler
 S = Standard Penetration Test

SUBSURFACE DATA

LOG OF BORING B32

CLIENT: Pardee Homes					PROJECT: Skyline Ranch		W.O.: 8838
LOCATION: Santa Clarita					ELEVATION: 1518'		DATE: 3/24/06
RIG TYPE: 6" HSA					HAMMER WEIGHTS: 140 lbs.		DROP: 30"
N	U	B	M	DD	DESCRIPTION	ATTITUDES	
0					<u>Alluvium</u> : Brownish tan gravelly SAND with cobbles, loose, dry.		
5					Refusal on boulder/cobble		
					Total Depth - 3'		
					No groundwater		
					No caving		
10							
15							
20							
25							
30							
35							
40							
45							

ADDITIONAL COMMENTS:

SUBSURFACE DATA

LOG OF BORING B33

CLIENT: Pardee Homes					PROJECT: Skyline Ranch		W.O.: 8838
LOCATION: Santa Clarita					ELEVATION: 1518'		DATE: 3/24/06
RIG TYPE: 6" HSA					HAMMER WEIGHTS: 140 lbs.		DROP: 30"
N	U	B	M	DD	DESCRIPTION	ATTITUDES	
0					<u>Alluvium</u> : Brownish tan gravelly SAND with cobbles, loose, dry.		
5					Refusal on boulder/cobble		
					Total Depth - 3'		
					No groundwater		
					No caving		
10							
15							
20							
25							
30							
35							
40							
45							

ADDITIONAL COMMENTS:

SUBSURFACE DATA

LOG OF BORING B34

CLIENT: Pardee Homes					PROJECT: Skyline Ranch			W.O.: 8838	
LOCATION: Santa Clarita					ELEVATION: 1518'			DATE: 3/24/06	
RIG TYPE: 6" HSA					HAMMER WEIGHTS: 140 lbs.			DROP: 30"	
	N	U	B	M	DD	DESCRIPTION			ATTITUDES
0						Alluvium: Grayish tan fine to coarse grained SAND with gravel, loose, friable, dry.			
5									
10									
15						Increasing cobbles and gravels with depth, difficult drilling.			
20						@20' - Drill teeth broke on cobbles. Refusal. Total Depth - 20' No groundwater No caving			
25									
30									
35									
40									
45									

ADDITIONAL COMMENTS:

SUBSURFACE DATA

LOG OF BORING B35

CLIENT: Pardee Homes					PROJECT: Skyline Ranch		W.O.: 8838
LOCATION: Santa Clarita					ELEVATION: 1518'		DATE: 3/24/06
RIG TYPE: 6" HSA					HAMMER WEIGHTS: 140 lbs.		DROP: 30"
N	U	B	M	DD	DESCRIPTION		ATTITUDES
0		X			Alluvium: Brownish tan fine to coarse grained SAND with gravel and cobbles, root hairs, loose, moist.		
		X					
		X					
		X					
		X					
5					Drilling on cobble/boulder, no sample taken.		
	38/50-3" C		6.2	119.5	Brownish tan silty fine to coarse grained SAND with gravel, medium dense, moist.		
10	38/50-4" C		9.8	111.2	<u>Mint Canyon Formation</u> : Gray gravelly fine to coarse grained SANDSTONE, friable, dense, moist.		
15	50-3" S				Gray gravelly fine to coarse grained SANDSTONE, friable, moist (no sample recovered).		
20	50-6" S				Gray fine to medium grained SANDSTONE with gravel, friable, very hard, moist.		
25	50-6" S				Gray fine to medium grained SANDSTONE with gravel, hard, moist.		
30					Total Depth - 25' No groundwater No caving		
35							
40							
45							
ADDITIONAL COMMENTS:					Blows per 6" C = California Sampler S = Standard Penetration Test		

SUBSURFACE DATA

LOG OF BORING B36

CLIENT: Pardee Homes					PROJECT: Skyline Ranch		W.O.: 8838
LOCATION: Santa Clarita					ELEVATION: 1518'		DATE: 3/24/06
RIG TYPE: 6" HSA					HAMMER WEIGHTS: 140 lbs.		DROP: 30"
	N	U	B	M	DD	DESCRIPTION	ATTITUDES
0			X			<u>Alluvium</u> : Brown silty fine to coarse grained SAND with gravel and cobbles, root hairs, loose, moist.	
			X				
			X				
			X				
5	8/21/26	C		--	--	Tan gravelly fine to coarse grained SAND, loose, dry.	
						Refusal on cobble/boulder.	
						Total Depth - 8'	
10						No groundwater	
						No caving	
15							
20							
25							
30							
35							
40							
45							
ADDITIONAL COMMENTS:						Blows per 6"	
						C = California Sampler	

SUBSURFACE DATA

LOG OF BORING B37

CLIENT: Pardee Homes					PROJECT: Skyline Ranch		W.O.: 8838	
LOCATION: Santa Clarita					ELEVATION: 1518'		DATE: 3/24/06	
RIG TYPE: 6" HSA					HAMMER WEIGHTS: 140 lbs.		DROP: 30"	
	N	U	B	M	DD	DESCRIPTION	ATTITUDES	
0						<p>Alluvium: Brown/tan silty fine to coarse grained SAND with gravel and cobbles, root hairs, loose, moist.</p> <p>@8' Cobble zone.</p> <p>Refusal on cobble/boulder. Total Depth - 8' No groundwater No caving</p>		
1								
2								
3								
4								
5								
6								
7								
8								
9								
10								
11								
12								
13								
14								
15								
16								
17								
18								
19								
20								
21								
22								
23								
24								
25								
26								
27								
28								
29								
30								
31								
32								
33								
34								
35								
36								
37								
38								
39								
40								
41								
42								
43								
44								
45								

ADDITIONAL COMMENTS:

SUBSURFACE DATA

LOG OF BORING B38

CLIENT: Pardee Homes					PROJECT: Skyline Ranch		W.O.: 8838.002
LOCATION: Santa Clarita					ELEVATION: 1787'±		DATE: 4/21/06
RIG TYPE: 24" Bucket					HAMMER WEIGHTS: Kelly Bar Weights		DROP: 12"
	N	U	B	M	DD	DESCRIPTION	ATTITUDES
0			X			<u>Colluvium</u> : Medium brown silty SAND and abundant scattered gravel and cobbles, subrounded, occasional rootlets, damp, medium dense.	
			X				
			X				
			X				
			X				
5			X			<u>Weathered Saugus Formation</u> : Tan to light brown silty SANDSTONE with abundant gravel and cobbles, well graded, friable, weathered, damp, dense.	@7' Approx. BN90/17W
10	5-12"	C		9.5	115.0	Highly channelized friable SANDSTONE with gravel to weakly cemented sandy CONGLOMERATE, well graded, very dense, moist.	@10' Approx. Horizontal bedding
15						<u>Saugus Formation</u> : Undulatory, scoured contact with cobble to boulder CONGLOMERATE with occasional zones of gravelly SANDSTONE, interbedded.	@13' Approx. Horizontal bedding
						Gravel CONGLOMERATE.	@17' Approx. BN25W/5SW
20	5-12"	C		10.4	115.9	Tan medium to coarse grained SANDSTONE, slightly friable to friable, dense, moist. @20' - Cobble CONGLOMERATE. @22' - Medium to coarse grained SANDSTONE with abundant gravel, friable, well graded.	@20' Approx. BN23W/8SW
25						@25.5' - Gravelly SANDSTONE with occasional subrounded cobbles, well graded.	@23' Approx. Horizontal bedding
							@27' Approx. Channel N68E/6NW
30	14-12"	C	X	4.3	111.5	Tan coarse grained SANDSTONE with scattered gravels, moist, friable. @31.5' - Fine to coarse gravel CONGLOMERATE, matrix supported, slightly friable to friable, matrix is well graded silty SAND.	
			X				
			X				
			X				
			X				
35						Tan coarse gravel CONGLOMERATE, matrix supported, slightly friable to friable with occasional interbeds of well graded SANDSTONE, massive, very dense, moist.	
40	12-12"	C		10.3	104.5	Discontinuous sand lens. Silty very fine to medium grained SANDSTONE, friable. Slightly undulatory contact. Light brown silty very well graded SANDSTONE with scattered fine to coarse gravel.	@39' Approx. BN3E/55SE
							@42' Approx. Horizontal bedding
45							
ADDITIONAL COMMENTS:						Blows per 6" C = Modified California Sampler Kelly Bar Weights: 0 - 30', 5,619 lbs. 31 - 60', 3,745 lbs. 61 - 90', 2,280 lbs.	

SUBSURFACE DATA

LOG OF BORING B38

CLIENT: Pardee Homes					PROJECT: Skyline Ranch		W.O.: 8838.002
LOCATION: Santa Clarita					ELEVATION: 1787'±		DATE: 4/21/06
RIG TYPE: 24" Bucket					HAMMER WEIGHTS: Kelly Bar Weights		DROP: 12"
	N	U	B	M	DD	DESCRIPTION	ATTITUDES
40							
45							
50	15-12"	C		2.9	122.3	<p>@47.5' - Tan fine to coarse grained SANDSTONE with scattered gravel, friable, very dense.</p> <p>Buff fine to very coarse grained SANDSTONE with scattered gravel, well graded. Cobble to boulder CONGLOMERATE, matrix supported, well graded, sand and gravel matrix.</p> <p>@56.5' - Medium to coarse grained SANDSTONE with gravel interbeds.</p>	<p>@48' Approx. BN26E/4NW</p> <p>@52' Approx. BN26E/5NW</p>
55							
60	20-10"	C	X	5.7	122.2	<p>Tan to light brown to orangish brown sandy CONGLOMERATE with gravel to cobble clasts, matrix supported, friable, moist, very dense.</p> <p><u>Mint Canyon Formation</u>: Highly scoured undulatory contact, light gray gravel CONGLOMERATE, moderately cemented, hard, moist.</p> <p>@66.5' - Base of CONGLOMERATE, cemented zone (approx. 6" thick) with scattered cobbles.</p> <p>@67' - Light gray fine to medium grained SANDSTONE, poorly graded, moderately cemented, hard, moist.</p>	<p>@57' B N26E/8NW</p> <p>@64' Approx. Contact Horizontal</p> <p>@66.5' Approx. Contact N20E/24NW</p>
65							
70	11-5" 18-8"	C C		6.2	115.3	<p>Light gray gravelly SANDSTONE with occasional brown siltstone ripup clasts (clasts up to 12" diameter), friable, moist, very dense.</p> <p>@74.5' - Massively bedded light gray fine to medium grained SANDSTONE, poorly graded, moderately cemented, hard, moist.</p>	<p>@74.5' Approx. BN14W/18SW</p>
75							
80	15-12"	C	X	15.5	116.8	<p>Well graded fine to coarse gravel CONGLOMERATE. Black silty very fine grained SANDSTONE (3-4" thick), continuous around boring.</p> <p>@80.5' - Light gray silty very fine to fine grained SANDSTONE, moist, very dense.</p> <p>@83' - Light gray gravelly CONGLOMERATE.</p>	<p>@80' B N28W/17SW</p>
85							
ADDITIONAL COMMENTS:						<p>Total Depth - 90' No groundwater Minor caving at 7' Backfilled</p> <p>C = Modified California Sampler Kelly Bar Weight) - 30', 5,619 lbs. 31 - 60', 3,745 lbs. 61 - 90', 2,280 lbs.</p>	

SUBSURFACE DATA

LOG OF BORING B39

CLIENT: Pardee Homes					PROJECT: Skyline Ranch		W.O.: 8838.002
LOCATION: Santa Clarita					ELEVATION: 1780±		DATE: 4/25/06
RIG TYPE: 24" Bucket					HAMMER WEIGHTS: Kelly Bar Weights		DROP: 12"
	N	U	B	M	DD	DESCRIPTION	ATTITUDES
0			X			<u>Artificial Fill</u> : Reddish brown clayey silty fine to coarse grained SAND with gravel, moist, medium dense, trash.	
			X			@1' - <u>Terrace Deposit</u> : Orangish brown fine to coarse grained SAND with gravel and cobbles, dry to slightly damp.	
5						<u>Saugus Formation</u> : Undulatory contact to brown silty medium to coarse grained SANDSTONE with gravel, very dense, moist.	@6' Approx. Horizontal bedding
						@7' - Brown fine grained SANDSTONE with occasional gravel, massive, very dense, moist.	
10	5-12" C			12.1	112.0	@9' - Brown fine to coarse grained SANDSTONE with occasional cobbles, friable, very dense, fining upwards, moist.	@12' Approx. BN37E/23SE
						Brown fine to medium grained SANDSTONE with occasional gravel, thickly bedded, moist, weakly cemented, very dense, moist.	
15						Brown medium to coarse grained SANDSTONE with fine gravel and occasional cobbles, subrounded, highly channelized, friable, very dense, moist.	@17' Approx. BN45W/9NE
20	8-11" C			1.3	121.6	@19.5' - Coarse sand stringer (approx. 4" thick).	@19.5' Approx. BN14W/6SW
						Brown fine to coarse grained sandy gravel and cobble CONGLOMERATE, friable, very dense, moist.	
25						3" thick fine to medium grained SANDSTONE lens with subangular fine gravel.	@28' Approx. Horizontal bedding
30	11-10" C	X		1.5	117.7	@29' - Brown fine to medium grained SANDSTONE, friable, well graded, very dense, moist.	@33.5' Approx. BN51E/19NW
						@30.5' - Channelized interbedded medium to coarse grained SANDSTONE with fine gravel to occasional cobbles, interbeds 2-4" zones of fine to medium grained SANDSTONE.	
35						@33.5' - Undulatory channelized contact between medium to coarse grained gravelly SANDSTONE and fine to medium grained SANDSTONE, contact is discontinuous around boring.	
40	19-12" C			4.1	116.8	Undulatory contact with brown fine grained SANDSTONE, friable, very dense with occasional cobbles and occasional zones of discontinuous silty fine grained SANDSTONE, fining upwards, moist.	@40' Approx. Horizontal contact
45							
ADDITIONAL COMMENTS:						C = Modified California Sampler Kelly Bar Weights: 0 - 30', 5,619 lbs. 31 - 60', 3,745 lbs. 61 - 90', 2,280 lbs. 91 - 120', 1,223 lbs.	

CLIENT: Pardee Homes					PROJECT: Skyline Ranch		W.O.: 8838.002
LOCATION: Santa Clarita					ELEVATION: 1780±		DATE: 4/25/06
RIG TYPE: 24" Bucket					HAMMER WEIGHTS: Kelly Bar Weights		DROP: 12"
	N	U	B	M	DD	DESCRIPTION	ATTITUDES
40						Brown cobble CONGLOMERATE with silty sand matrix, matrix supported. @44.5' - Brown medium to coarse grained SANDSTONE and CONGLOMERATE, interbedded, undulatory, pinched contact. Massively bedded fine to medium grained SANDSTONE, poorly graded, friable.	
45							
50	15-10"	C	X	9.1	109.7	Undulatory contact to brown cobble CONGLOMERATE, fine to medium sand matrix with occasional discontinuous pockets of clayey SANDSTONE, highly channelized, friable. @51' - 3" thick clayey discontinuous SANDSTONE, grading into fine to medium grained SANDSTONE with occasional cobble and boulder CONGLOMERATE.	@50' Approx. Contact N88E/14SE @51' B N50W/21SW
55						@58.5' - Slightly irregular contact to brown fine grained SANDSTONE, friable. @60.5' - Channeled fine grained gravel to cobble CONGLOMERATE, subrounded to subangular (fine clasts are more angular) friable fine to coarse sand matrix, beds are 2-4" thick.	@58.5' Approx. BN24W/17SW
60							@62' Approx. Channel contact N34W/20-33SW
65	20-9"	C	X X X	8.0	111.7	@64.5' - Cobble CONGLOMERATE, well graded, matrix supported to fine gravel to cobble CONGLOMERATE, occasional thick clast supported beds, well graded, friable channels dipping to NW and NE.	@64.5' B N60E/17NW
70	21-6"	C		1.9	113.8	@71' Thin bedded fine gravel CONGLOMERATE, friable, sand matrix and thinly bedded fine gravel to cobble CONGLOMERATE, well graded, friable, sand matrix. @73' - Occasional cobble to boulder CONGLOMERATE. @74' - Fine grained gravel to cobble CONGLOMERATE with occasional subrounded boulders.	@71' B N30E/11NW
75						@78' Fine gravel CONGLOMERATE to fine grained gravelly coarse grained SANDSTONE, friable. Channelized interbedded medium to coarse grained SANDSTONE, friable, damp. Occasional boulders, boring is tighter below, fine grained to cobble CONGLOMERATE, 2-4" thick, fine gravelly medium to coarse grained SANDSTONE.	@75' B N80E/19NW
80	20-5"	C		2.4	113.2		@80' Approx. Channel N40E/6NW
85							

ADDITIONAL COMMENTS:

C = Modified California Sampler
 Kelly Bar Weights:) - 30', 5,619 lbs.
 31 - 60', 3,745 lbs.
 61 - 90', 2,280 lbs.
 91 - 120', 1,223 lbs.

SUBSURFACE DATA

LOG OF BORING B39

CLIENT: Pardee Homes					PROJECT: Skyline Ranch		W.O.: 8838.002
LOCATION: Santa Clarita					ELEVATION: 1780'±		DATE: 4/25/06
RIG TYPE: 24" Bucket					HAMMER WEIGHTS: Kelly Bar Weights		DROP: 12"
	N	U	B	M	DD	DESCRIPTION	ATTITUDES
80							
85							
90	14-12"	C	X X	27.7	95.2	Clayey fine grained SANDSTONE, 2" thick scoured into CONGLOMERATE above, non-plastic. @87' - Thin fine gravel to cobble CONGLOMERATE. 1/4" thick clayey SILTSTONE. @89.5' - 1/4" thick clayey SILTSTONE. @90' - Friable coarse grained SANDSTONE, moist. @91' - Fine gravel to cobble to boulder CONGLOMERATE, well graded, coarse sand matrix supported. @92' - Fine gravel to cobble CONGLOMERATE, well graded, coarse sand matrix supported. @95' - Occasional boulder.	@86' B N40E/6NW @89' B N48W/11NE
95							@95' Approx. Horizontal bedding
100	20-6"	C		2.6	111.4	Brown gravelly fine to coarse grained SANDSTONE, slightly damp, friable.	@102' Approx. Horizontal bedding
105						Brown gravel and cobble CONGLOMERATE, fine to coarse grained sandy matrix, damp, friable, well graded.	
110						Total Depth - 108' No groundwater No caving Backfilled	
115							
120							
125							

ADDITIONAL COMMENTS:

C = Modified California Sampler
 Kelly Bar Weights:) - 30', 5,619 lbs.
 31 - 60', 3,745 lbs.
 61 - 90', 2,280 lbs.
 91 - 120', 1,223 lbs.

SUBSURFACE DATA

LOG OF BORING B40

CLIENT: Pardee Homes					PROJECT: Skyline Ranch		W.O.: 8838.001
LOCATION: Santa Clarita					ELEVATION: 1651'±		DATE: 5-8-06
RIG TYPE: 24" Bucket					HAMMER WEIGHTS: Kelly Bar Weights		DROP: 12"
N	U	B	M	DD	DESCRIPTION		ATTITUDES
0					Alluvium: Dark grayish brown fine to medium grained SAND with 40% subangular fine to coarse gravel clasts and 5-10% subrounded cobble to boulder clasts, medium dense, moist, roots (1/4" diameter) to brown fine to medium grained SAND, medium dense, moist.		
5					Brown fine to coarse grained SAND with 40% subangular fine to coarse gravel clasts and 5-10% subrounded cobble to boulder clasts, medium dense, moist, roots (1/4" diameter).		
10	18/C			10.9	117.8	Mint Canyon Formation: Scoured contact to subrounded coarse gravel CONGLOMERATE, clasts commonly fine to coarse gravel (granitic), moderately cemented, greenish gray silty fine to medium sandstone matrix, channeled, hard, moist. @12' - Sharp contact to greenish gray silty fine to coarse grained SANDSTONE (12" thick), grading to coarse grained SANDSTONE, occasionally subrounded fine to coarse gravel, fining upward, hard, moist, moderately indurated. @17' - Grading to subrounded coarse gravel to cobble (granitics) CONGLOMERATE, moderately cemented greenish gray silty fine to coarse grained sandstone matrix, massive, channeled, hard, moist.	@10' Contact N49W/13NE to 34NE @12' Contact N74E/36NW
15							
20	13/25	C		9.5	126.1	Subrounded coarse gravel to cobble CONGLOMERATE, moderately cemented greenish gray silty fine to coarse sandstone matrix, channeled, massive, hard, moist.	@20' Channel N21E/40-60NW
25							
30	15/30	C		5.0	112.8	Bedded coarse gravel to cobble CONGLOMERATE to fine grained SANDSTONE to channeled, scoured fine gravel to cobble CONGLOMERATE. Increase in subrounded coarse cobble clasts, massive.	@28' B N33E/21NW
35						Subrounded gravel to cobble CONGLOMERATE, moderately cemented greenish gray fine to coarse sandstone matrix, massive, hard, moist.	
40	30/30	C		11.5	127.3	4-8" diameter greenish gray SILTSTONE ripup clasts in gravel to cobble CONGLOMERATE. Grades to greenish gray silty clayey fine grained SANDSTONE with undulatory near vertical, striated shears, hard, moist, to fine grained gravel to cobble CONGLOMERATE with siltstone ripup clasts in moderately cemented greenish gray fine to coarse sandstone matrix, hard, moist.	@39.5' Contact N84E/24NW @41' Shear N20E/Vertical @41.5' B N18E/27NW
45							
ADDITIONAL COMMENTS:					Blows per 6" C = Modified California Sampler Kelly Bar Weights: 0 - 50', 2,280 lbs. 50 - 75', 1,220 lbs.		

CLIENT: Pardee Homes					PROJECT: Skyline Ranch		W.O.: 8838.001
LOCATION: Santa Clarita					ELEVATION: 1651'±		DATE: 5-8-06
RIG TYPE: 24" Bucket					HAMMER WEIGHTS: Kelly Bar Weights		DROP: 12"
N	U	B	M	DD	DESCRIPTION	ATTITUDES	
40					Grading to fining upward sequences of greenish gray clayey fine grained SANDSTONE to fine grained SANDSTONE (with depth), hard, moist.	@42.5' Contact N64E/13NW	
45				@44.5' - Light seep in west wall above greenish gray clayey fine grained SANDSTONE (1mm thick brown clayey fine grained SANDSTONE at contact, hard, moist, massive, grading to fine grained SANDSTONE, abundant white calcium carbonate nodules 4-8" diameter), hard, moist, massive.		@44.5' Contact N24W/26NE	
50	15/30	C		11.0	121.7	Grades to greenish gray CLAYSTONE, hard, moist, massive, steeply dipping shears.	
55			X			Grades to clayey silty fine grained SANDSTONE, hard, moist, massive.	@52' Shear N10E/70-85NW
60	50-6"	C		12.0	112.9	Continued fining upward sequences of greenish gray fine grained SANDSTONE to clayey fine grained SANDSTONE (typically 2 feet thick), hard, moist, massive.	
65						Grades to fine to coarse grained SANDSTONE, occasional subrounded boulder, hard, moist, massive, to fine to coarse grained gravel CONGLOMERATE, moderately cemented greenish gray fine to coarse sandstone matrix, hard, moist.	
70						Total Depth - 70' Light seep in W wall at 44.5' and seep below 70' No caving Backfilled	
75							
80							
85							
ADDITIONAL COMMENTS:					Blows per 6" C = Modified California Sampler Kelly Bar Weights:) - 50', 2,280 lbs. 50 - 75', 1,220 lbs.		

CLIENT: Pardee Homes					PROJECT: Skyline Ranch		W.O.: 8838
LOCATION: Santa Clarita					ELEVATION: 1754'±		DATE: 5/10/06
RIG TYPE: 24" Bucket					HAMMER WEIGHTS: Kelly Bar Weights		DROP: 12"
N	U	B	M	DD	DESCRIPTION	ATTITUDES	
0					<u>Colluvium</u> : Light brown fine to coarse grained SAND with gravel and cobbles, subrounded clasts, friable, loose, dry.		
5					<u>Saugus Formation</u> : Light brown fine to coarse grained SANDSTONE with gravel, interbedded with gravel stringers, beds approximately 1/4" to 1/2" thick, friable, cross-bedded, highly channelized.		
10	15/16		2.1	126.0	@7.5' - Medium to coarse grained SANDSTONE with gravel, dense, moist. Fine sand lens approximately 2" thick. @11' - Light brown fine to coarse grained SANDSTONE with gravel, interbedded gravel stringers, highly channelized, friable, moist, very dense.	@11' Channel BN49W/9NE	
15					Light brown cobble and boulder CONGLOMERATE, matrix supported, sand matrix.		
20					Light brown interbedded fine to coarse grained SANDSTONE and gravel CONGLOMERATE, 1" and 12" thick beds, highly channelized, slightly friable to weakly cemented, moist, hard.	@21' Channel BN39E/9SE	
25						@27' Channel BN38W/25NE	
30					Light brown boulder and cobble CONGLOMERATE, matrix supported, boring belled to approximately 5' diameter, corkscrewing down.		
35							
40							
45					No downlogging below 43' because boring is excessively wide and unsafe to log.		
ADDITIONAL COMMENTS:					Blows per 6" C = Modified California Sampler Kelly Bar Weights: 0 - 50', 2,280 lbs. 50 - 75', 1,200 lbs.		

SUBSURFACE DATA

LOG OF BORING B41

CLIENT: Pardee Homes					PROJECT: Skyline Ranch		W.O.: 8838
LOCATION: Santa Clarita					ELEVATION: 1754'±		DATE: 5/10/06
RIG TYPE: 24" Bucket					HAMMER WEIGHTS: Kelly Bar Weights		DROP: 12"
	N	U	B	M	DD	DESCRIPTION	ATTITUDES
40							
45						Light brown fine to coarse grained SANDSTONE with subangular gravel and subrounded cobbles, friable, moist, hard.	
50							
55						Light brown fine to coarse grained SANDSTONE with subangular gravel subrounded cobbles, friable, moist, hard.	
60							
65						Refusal on boulder.	
70						Total Depth - 63' No groundwater No caving Backfilled	
75							
80							
85							

ADDITIONAL COMMENTS:

SUBSURFACE DATA

LOG OF BORING B42

CLIENT: Pardee Homes					PROJECT: Skyline Ranch		W.O.: 8838
LOCATION: Santa Clarita					ELEVATION: 2160'±		DATE: 5/15/06
RIG TYPE: 24" Bucket					HAMMER WEIGHTS: Kelly Bar Weights		DROP: 12"
N	U	B	M	DD	DESCRIPTION	ATTITUDES	
0					<p><u>Colluvium</u>: Brown clayey silty SAND with gravel, cobbles, and boulders, medium dense, moist.</p> <p><u>Mint Canyon Formation</u>: Tan SANDSTONE with gravel, cobbles, and boulders, moist.</p>		
5							
10	15-6"	C	3.2	132.8	Tan fine to medium grained SANDSTONE with fine to coarse gravel, friable, dry (30-40% coarse gravel).		
15							
20					Refusal on boulder at 17'		
25							
30							
35							
40							
45							
ADDITIONAL COMMENTS:					Blows per 6" C = Modified California Sampler Kelly Bar Weights: 0 - 50', 2,280 lbs. 50 - 75', 1,200 lbs.		

SUBSURFACE DATA

LOG OF BORING B42a

CLIENT: Pardee Homes					PROJECT: Skyline Ranch		W.O.: 8838
LOCATION: Santa Clarita					ELEVATION: 2160'±		DATE: 5/15/06
RIG TYPE: 24" Bucket					HAMMER WEIGHTS: Kelly Bar Weights		DROP: 12"
N	U	B	M	DD	DESCRIPTION	ATTITUDES	
0					<p><u>Colluvium</u>: Brown clayey silty SAND with gravel, cobbles, and boulders, medium dense, moist.</p> <p><u>Mint Canyon Formation</u>: Tan CONGLOMERATE, friable sandstone matrix, dry.</p>		
5					<p>Subrounded to subangular coarse gravel to boulder CONGLOMERATE well graded, weakly cemented fine to coarse grained SANDSTONE matrix, bedded, hard, moist, clasts are granitic, quartzitic, volcanic (5-10% boulder size).</p> <p>@10' - Slightly friable matrix.</p>	<p>@7' B N55W/22NE</p>	
10					<p>Occasional 2-12" thick subangular fine to coarse grained gravel CONGLOMERATE in fine to coarse grained sandstone matrix, slightly friable, hard, moist.</p> <p>@24' - 18-30" boulder in hard, moist, slightly friable fine to coarse grained SANDSTONE, bedding to 3' diameter, SW-SE dipping channels (20-30°), unsafe to downhole below 25'.</p>	<p>@11' B N20W/20NE</p>	
15						<p>@15' B N85E/18SE</p>	
20	4/10	C	4.9	110.4		<p>@19' Channel BN-S/26SE to N30W/25SW @21' B N30W/19NE</p>	
25							
30	6/13	C	6.3	116.0	<p>Tan SANDSTONE with fine cobbles and angular gravel (approximately 60% coarse clasts), cobbles are subangular, finer clasts are more angular, well graded, friable, moist.</p>		
35							
40	6/15	C			<p>Cobble in shoe, no sample recovered, tan SANDSTONE with gravel to cobble clasts, clasts are subrounded, smaller clasts are subangular, moist, friable.</p>		
45							
ADDITIONAL COMMENTS:					<p>Blows per 6" C = Modified California Sampler Kelly Bar Weights: 0 - 50', 2,280 lbs. 50 - 75', 1,200 lbs.</p>		

SUBSURFACE DATA

LOG OF BORING B42a

CLIENT: Pardee Homes					PROJECT: Skyline Ranch		W.O.: 8838
LOCATION: Santa Clarita					ELEVATION: 2160'±		DATE: 5/15/06
RIG TYPE: 24" Bucket					HAMMER WEIGHTS: Kelly Bar Weights		DROP: 12"
N	U	B	M	DD	DESCRIPTION	ATTITUDES	
40							
45							
50	6/17	C	5.9	126.5	Tan gravelly fine to coarse grained SANDSTONE, gravel is subrounded (approximately 25% gravel), moist, friable.		
55							
60	18/26	C	6.6	110.8	Tan gravelly fine to coarse grained SANDSTONE, subangular clasts (approximately 20% gravel), moist, friable. Frequent boulders.		
65					Refusal on boulders.		
70							
75					Total Depth - 68' No groundwater No caving Backfilled		
80							
85							
ADDITIONAL COMMENTS:					Blows per 6" C = Modified California Sampler Kelly Bar Weights:) - 50', 2,280 lbs. 50 - 75', 1,200 lbs.		

CLIENT: Pardee Homes					PROJECT: Skyline Ranch		W.O.: 8838
LOCATION: Santa Clarita					ELEVATION: 2115'±		DATE: 5/18/06
RIG TYPE: 24" Bucket					HAMMER WEIGHTS: Kelly Bar Weights		DROP: 12"
N	U	B	M	DD	DESCRIPTION	ATTITUDES	
0					Colluvium: Brown silty clayey gravelly SAND with cobbles, moist, medium dense.		
5					@1' - <u>Mint Canyon Formation</u> : Tan cobble CONGLOMERATE, gravel and sand matrix, matrix supported, friable, moist (approximately 15% cobbles, 45% sand, 40% gravel), cobbles are subrounded, coarse sands and gravel are subangular		
10	3/5	C	8.0	105.0	Drilling on cobbles and boulders, drilling is very difficult. @8' - Boulder to cobble CONGLOMERATE, clasts mostly grano-diorite, approximately 10% boulders, clast supported.	@8' Approx. BN17E/15NW	
15					Subangular boulder CONGLOMERATE, boulders up to 2' diameter, clast supported, approximately 60% boulders, gravel and fine to medium sand matrix.		
20					Boulder to cobble CONGLOMERATE (10% boulders, 40% cobbles, 25% sand, 25% gravel), subangular to subrounded clasts, fine to medium sand and gravel matrix.		
25	23-10"	C	11.6	--	@22.5' - Moderately cemented fine to medium grained SANDSTONE, discontinuous around hole, hard, dry. @23' - Cobble CONGLOMERATE with occasional boulder (less than 5%), subrounded to subangular cobbles, clast supported.	@23' Approx. BN36W/11SW	
30	6/10	C	7.3	93.9	Boulder and cobble CONGLOMERATE, boulders up to 2' diameter, clast supported (40% boulders, 20% cobbles).		
35					Refusal at 34' on boulders No groundwater No caving Backfilled		
40							
45							
ADDITIONAL COMMENTS:					Blows per 6" C = Modified California Sampler Kelly Bar Weights: 0 - 50', 2,280 lbs. 50 - 75', 1,200 lbs.		

SUBSURFACE DATA

LOG OF BORING B44

CLIENT: Pardee Homes					PROJECT: Skyline Ranch		W.O.: 8838
LOCATION: Santa Clarita					ELEVATION: 2060'±		DATE: 5/26/06
RIG TYPE: 24" Bucket					HAMMER WEIGHTS: Kelly Bar Weights		DROP:
	N	U	B	M	DD	DESCRIPTION	ATTITUDES
0						Mint Canyon Formation: Dark brown clayey fine grained SAND with subrounded coarse gravel to cobble, very stiff, moist, to well graded subrounded coarse gravel to boulder CONGLOMERATE with weakly cemented greenish gray fine to medium grained sandstone matrix, hard, moist.	
5							
10		C		7.0	126.4	@10' - Well graded subrounded coarse gravel to cobble CONGLOMERATE with weakly cemented greenish gray fine to medium sandstone matrix, hard, moist, to conglomeratic fine to coarse grained SANDSTONE with subrounded fine gravel to cobble, weakly cemented to slightly friable, hard, moist.	@11' B N38W/29SW
15						@13' - Crudely bedded fine gravel to subrounded cobble to boulder CONGLOMERATE, well graded, weakly cemented to slightly friable, to greenish gray fine to medium grained SANDSTONE, well graded, hard, moist (20-30% gravel/cobble, 5% boulder).	@17' B N34W/25SW
20	8/10	C		12.4	119.1	@20.5' - Scoured contact with green gray fine grained SANDSTONE, massive, moderately indurated, very hard, moist. @22.5' - Contact to coarse gravel to cobble CONGLOMERATE (subrounded), in weakly cemented green gray fine to medium grained sandstone matrix, well graded, hard, moist, crudely bedded.	@20' J N76W/38SW @22.5' Contact N39W/19SW
25							
30	14/25	C		9.2	107.4	@28' - Occasional subrounded boulders (5-10%). @32' - Subrounded coarse gravel to cobble CONGLOMERATE with occasional boulder in weakly cemented green gray fine to medium grained sandstone matrix, well graded, hard, moist.	@27' B N47W/20SW
35						Green gray fine to coarse grained SANDSTONE (12" thick) with occasional subangular fine gravel, weakly indurated, hard, moist.	@35' Contact N40W/18SW
40	10/20	C		10.7	107.6	@36' - Subrounded coarse gravel to cobble CONGLOMERATE, weakly cemented, green gray fine to medium grained sandstone matrix, very hard, moist, crudely bedded, occasional boulder (≤5%). @40' - Subrounded coarse gravel to cobble CONGLOMERATE, weakly cemented, green gray fine to medium grained sandstone matrix, very hard, moist, crudely bedded, occasional boulder (≤5%).	@38.5' B N47W/23SW
45							
ADDITIONAL COMMENTS:						Blows per 6" C = Modified California Sampler Kelly Bar Weights: 0 - 50', 2,280 lbs. 50 - 75', 1,200 lbs.	

CLIENT: Pardee Homes					PROJECT: Skyline Ranch		W.O.: 8838
LOCATION: Santa Clarita					ELEVATION: 2060'±		DATE: 5/26/06
RIG TYPE: 24" Bucket					HAMMER WEIGHTS: Kelly Bar Weights		DROP:
N	U	B	M	DD	DESCRIPTION	ATTITUDES	
40							
45							
50	15/20	C	9.2	115.4	@50' - Interbedded fine grained SANDSTONE, laminated to thinly bedded, and gravel to cobble CONGLOMERATE in weakly to moderately cemented green gray fine to medium grained sandstone matrix, hard, moist.		
55							
60	25/45	C	8.0	109.4	@60' - Fine gravel to cobble CONGLOMERATE, slightly friable to weakly cemented, greenish gray fine to medium grained sandstone matrix, hard, moist.		
65					Total Depth - 60' No groundwater No caving Backfilled		
70							
75							
80							
85							
ADDITIONAL COMMENTS:					Blows per 6" C = Modified California Sampler Kelly Bar Weights:) - 50', 2,280 lbs. 50 - 75', 1,200 lbs.		

SUBSURFACE DATA

LOG OF BORING B45

CLIENT: Pardee Homes					PROJECT: Skyline Ranch			W.O.: 8838
LOCATION: Santa Clarita					ELEVATION: 2105'±			DATE: 5/30/06
RIG TYPE: 24" Bucket					HAMMER WEIGHTS: Kelly Bar Weights			DROP: 12"
	N	U	B	M	DD	DESCRIPTION		ATTITUDES
0						Colluvium: Brown cobbly and gravelly SAND, cobbles are subrounded, occasional boulders, roots, dry.		
5						@4' - <u>Mint Canyon Formation</u> : Tan cobble to boulder CONGLOMERATE, sand and gravel matrix, matrix supported, boulders up to 2' diameter (approximately 35% boulders), well graded, dry, very dense.		
10	12/18	C			13.1	116.4	@11' - Tan cobble to boulder CONGLOMERATE, friable sand and gravel matrix, clast supported, massive, moist, very dense.	
15							@14' - Fine to medium grained SANDSTONE, friable, moist. @15' - Tan cobble to gravel CONGLOMERATE, fine to medium sand matrix, matrix supported, massive.	@14' B N39W/21SW @15' B N42W/22SW
20	8/12	C			11.5	105.3	@19' - Channelized tan fine to medium grained SANDSTONE with occasional coarse cobbles, well graded, moist, friable.	@19' B N15W/22SW
25							@23' - Boulder to cobble CONGLOMERATE, approximately 2' diameter boulder, clast supported, massive. @24' - Tan subangular gravel and cobble CONGLOMERATE with friable fine to medium sand matrix, matrix supported, well graded, massive, hard, moist.	
30	15/20	C			6.7	127.6	@30' - Tan subangular gravel and cobble CONGLOMERATE with friable fine to medium sand matrix, matrix supported, well graded, massive, hard, moist.	
35								
40	15/25	C			5.9	124.5	@39' - 2' diameter boulder, horizontally elongated. @39.5' - Gravel and cobble CONGLOMERATE with friable fine to medium sand matrix, matrix supported, well graded, hard, moist.	
45								
ADDITIONAL COMMENTS:						Blows per 6" C = Modified California Sampler Kelly Bar Weights: 0 - 50', 2,280 lbs. 50 - 75', 1,200 lbs.		

SUBSURFACE DATA

LOG OF BORING B45

CLIENT: Pardee Homes					PROJECT: Skyline Ranch		W.O.: 8838
LOCATION: Santa Clarita					ELEVATION: 2105±		DATE: 5/30/06
RIG TYPE: 24" Bucket					HAMMER WEIGHTS: Kelly Bar Weights		DROP: 12"
N	U	B	M	DD	DESCRIPTION		ATTITUDES
40							
45					@43' - Switch to 18" diameter digging bucket (from 24" diameter), unable to downhole log below 43', subrounded gravel to cobble CONGLOMERATE, well graded, friable sandstone matrix.		
50	140-6"	C	10.7	110.0	@50' - Subrounded gravel to cobble CONGLOMERATE, friable sandstone matrix.		
55					@55' - Boulders up to 1.5' diameter in gravel to cobble CONGLOMERATE, friable sandstone matrix.		
60	50-5"	C			@60' - No sample recovered, too rocky. @61' - 1.5' diameter boulder.		
65					Total Depth - 63' refusal on boulder No groundwater No caving Backfilled		
70							
75							
80							
85							
ADDITIONAL COMMENTS:					Blows per 6" C = Modified California Sampler Kelly Bar Weights:) - 50', 2,280 lbs. 50 - 75', 1,200 lbs.		

SUBSURFACE DATA

LOG OF BORING B46

CLIENT: Pardee Homes					PROJECT: Skyline Ranch		W.O.: 8838.002
LOCATION: Santa Clarita					ELEVATION: 2005±		DATE: 6/1/06
RIG TYPE: 24" Bucket					HAMMER WEIGHTS: Kelly Bar Weights		DROP: 12"
N	U	B	M	DD	DESCRIPTION	ATTITUDES	
0					<u>Saugus Formation</u> : Silty fine grained SANDSTONE with clay and subrounded to subangular cobbles, root hairs to 3'.		
5					@5' - Massive silty fine grained SANDSTONE, weakly indurated, hard, moist. @6' - White calcite precipitate along joint. @8' - Brown silty fine grained SANDSTONE with sparse fine gravel, discontinuous carbonate veins, massive, weakly indurated, hard, moist.	@6' Joint N18E/74SE	
10	7-12"	C		12.1 112.6	@10' - Brown to light brown silty fine to medium grained SANDSTONE with abundant coarse sand to fine gravel, weakly indurated, massive, hard, moist.		
15					@16.5' - Contact with light brown fine grained SANDSTONE and subrounded to subangular gravel CONGLOMERATE, well graded, weakly cemented, hard, moist. @18' - Thinly bedded to channelized, channels dip to west approximately 20°.	@16.5' Contact N20W/11SW @18' B N14W/19SW	
20	7-12"	C		16.3 111.1	@21' - Sharp contact to light brown fine grained sandy SILTSTONE with trace clay, massive, hard, multidirectional shears.	@21' Contact N39W/17SW @21.5' Shear N85E/40SE @22' Shears N56W/38SW N33W/29SW Slicks: S40W	
25					@25' - Gradational contact to tan medium to coarse grained SANDSTONE with gravel and occasional cobbles. @27' - Approximately 6" thick light brown medium to coarse grained SAND, slightly friable, interbedded with gravel to cobble CONGLOMERATE, hard, moist.		
30	15-13"	C		2.9 118.6	@30' - Light brown fine to coarse grained SANDSTONE with occasional gravel, friable, hard, moist. @31' - Channelized conglomerate. @33' - Contact to tan fine to coarse grained SANDSTONE, massive, hard, moist.	@31' Channel N40W/16SW @33' Contact N45W/14SW	
35					@34.5' - Gradational contact to gravel CONGLOMERATE with sand matrix, angular to subrounded clasts, undulating channels dipping approximately 17-24 SW to SE. @37' - Appearance of fine cobbles.	@38' B N75E/20SE	
40	18-12"	C		7.0 117.3	@40' - Gradational contact to fine to coarse grained SANDSTONE with occasional gravel, friable, hard, moist.		
45							

ADDITIONAL COMMENTS:

C = Modified California Sampler
 Kelly Bar Weights: 0 - 30', 5,619 lbs.
 31 - 60', 3,745 lbs.
 61 - 90', 2,280 lbs.
 91 - 120', 1,223 lbs.

SUBSURFACE DATA

LOG OF BORING B46

CLIENT: Pardee Homes					PROJECT: Skyline Ranch		W.O.: 8838.002
LOCATION: Santa Clarita					ELEVATION: 2005'±		DATE: 6/1/06
RIG TYPE: 24" Bucket					HAMMER WEIGHTS: Kelly Bar Weights		DROP: 12"
	N	U	B	M	DD	DESCRIPTION	ATTITUDES
40							
45						@44' - Sharp, slightly scoured contact with yellow brown fine grained SANDSTONE, massive, slightly friable, hard, moist. @45' - Fine grained SANDSTONE with gravel, grading to gravel CONGLOMERATE with slightly friable medium to coarse sand matrix, moist. @49' - Thinly bedded CONGLOMERATE.	@44' B N27E/22SE
50	18-12"	C		5.6	125.3	@50' - Channel, scoured into yellow brown medium to coarse grained SANDSTONE with gravel and small cobbles, slightly friable, hard, moist.	@50' Channel N35E/24SE
55			X				
60	15-12"	C		15.6	119.6	@57' - Scoured contact with clayey fine grained SANDSTONE, hard, massive. Near vertical, pervasive shears. @59.5' - Brown fine to coarse grained SANDSTONE with gravel. @60.5' - Contact with brown fine grained sandy SILTSTONE with approximately 1/4" diameter concretions, cemented, hard, moist, discontinuous, undulatory, shallow, west dipping clay-lined shears.	@57' Channel N68E/6SE @59.5' Approx. BN52W/11SW
65			X				@63' Shear N45W/26SW
70	14-12"	C		7.2	118.4	@67' - Gravel cobble CONGLOMERATE with slightly friable fine to medium grained sandstone matrix. @70' - Light brown gravelly SANDSTONE with occasional fine cobbles, friable, hard, moist.	@70' B N30W/12SW
75						@75' - Grading to fine gravel CONGLOMERATE, slightly friable, hard, moist.	@74' B N46W/13SW
80	15-12"	C		7.3	115.4	@78' - Contact to sandy SILTSTONE with occasional gravels, hard, moist. @81' - Scoured contact to well graded subrounded gravel to cobble CONGLOMERATE, friable yellow fine to coarse sandstone matrix, very dense, moist.	@78' Contact N66W/11SW @81' Contact N80E/37SE
85							

ADDITIONAL COMMENTS:

C = Modified California Sampler
 Kelly Bar Weights:) - 30', 5,619 lbs.
 31 - 60', 3,745 lbs.
 61 - 90', 2,280 lbs.
 91 - 120', 1,223 lbs.

SUBSURFACE DATA

LOG OF BORING B46

CLIENT: Pardee Homes					PROJECT: Skyline Ranch		W.O.: 8838.002	
LOCATION: Santa Clarita					ELEVATION: 2005'±		DATE: 6/1/06	
RIG TYPE: 24" Bucket					HAMMER WEIGHTS: Kelly Bar Weights		DROP: 12"	
N	U	B	M	DD	DESCRIPTION		ATTITUDES	
80								
85						@84' - Grading to gravel CONGLOMERATE with friable yellow brown fine to coarse sandstone matrix, highly channelized beds.	@84' B N25W/17SW	
90	30-10"	C	5.0	108.3		@90' - Boulder approximately 1' diameter, elongated horizontally in well graded, gravel to cobble CONGLOMERATE with slightly friable yellow brown sandstone matrix, massive, hard, moist.	@90' Channel N90E/14S	
95						@94' - Contact with friable light brown fine grained SANDSTONE, moist, hard. @95.5' - Gradational contact to subrounded gravel to cobble CONGLOMERATE, slightly friable light brown fine to coarse sandstone matrix, highly channelized.	@94' Channel N4W/16SW @95' B N36W/18SW	
100	20-12"	C	7.2	116.1		@100' - Light brown fine to coarse grained SANDSTONE with gravel, hard, moist, friable. @101' - Subrounded gravel to cobble CONGLOMERATE, slightly friable, fine to coarse sandstone matrix.	@101' B N32W/19SW	
105								
110	8-12"	C	8.5	99.9		@109' - Abundant gravel to cobble quartz clasts, granitic clasts and schist, channelized. @110' - Light brown fine to coarse grained SANDSTONE with gravel, friable, hard, moist. @111' - Channelized bedding.	@111' B N75E/15SE	
115						@115' - Light brown fine to coarse grained SANDSTONE with gravel, friable, hard, moist.		
120						Total Depth - 115' No groundwater No caving Backfilled		
125								

ADDITIONAL COMMENTS:

C = Modified California Sampler
 Kelly Bar Weights:) - 30', 5,619 lbs.
 31 - 60', 3,745 lbs.
 61 - 90', 2,280 lbs.
 91 - 120', 1,223 lbs.

SUBSURFACE DATA

LOG OF BORING B47

CLIENT: Pardee Homes					PROJECT: Skyline Ranch			W.O.: 8838
LOCATION: Santa Clarita					ELEVATION: 2021'			DATE: 6/5/06
RIG TYPE: 24" Bucket					HAMMER WEIGHTS: Kelly Bar Weights			DROP: 12"
	N	U	B	M	DD	DESCRIPTION		ATTITUDES
0						Colluvium: Brown silty SAND, dry, medium dense, rootlets.		
5						@3' - <u>Saugus Formation</u> : Light brown gravelly fine to coarse grained SANDSTONE, subangular gravel, slightly friable, rootlets to 5' depth, moist, hard. @6' - Scoured contact to light brown fine grained SANDSTONE with subangular gravel, friable, moist, hard. @8' - Discontinuous light brown SILTSTONE bed, moist, hard, within light brown fine grained SANDSTONE with subangular gravel, friable, hard, moist.		
10	4-12"	C			8.2	115.4		
15								
20	9-12"	C	X		17.5	113.9	@18.5' - Slightly scoured contact with light brown silty fine grained SANDSTONE with occasional subangular gravel, moist, hard. @20' - 12" thick sheared brown CLAYSTONE, waxy surface on shears, multidirectional shears, carbonate veins, moist, hard. @21' - Light brown fine grained sandy SILTSTONE, moist, hard.	
25							@25' - Light brown fine grained sandy SILTSTONE with carbonate nodules, moderately cemented, carbonate nodules are 2" maximum diameter, moist, hard. @26.5' - Brown CLAYSTONE, discontinuous, multidirectional shears, moist, hard.	
30	11-12"	C			19.0	111.9	@27' - Light brown fine grained sandy SILTSTONE to silty fine grained SANDSTONE, massive, moist, hard. @30' - Grading into light brown fine grained SANDSTONE, massive, moist, hard. @34.5' - Grading into brown CLAYSTONE, massive, moist, hard.	
35								
40	12-12"	C			16.0	113.5	@40' - Grading into light brown silty fine to medium grained SANDSTONE with subangular gravel, massive, moist, hard.	
45								
ADDITIONAL COMMENTS:						C = Modified California Sampler Kelly Bar Weights: 0 - 30', 5,619 lbs. 31 - 60', 3,745 lbs. 61 - 90', 2,280 lbs. 91 - 120', 1,200 lbs.		

CLIENT: Pardee Homes					PROJECT: Skyline Ranch		W.O.: 8838
LOCATION: Santa Clarita					ELEVATION: 2021'		DATE: 6/5/06
RIG TYPE: 24" Bucket					HAMMER WEIGHTS: Kelly Bar Weights		DROP: 12"
	N	U	B	M	DD	DESCRIPTION	ATTITUDES
40							
45						@44' - Grading into subangular gravel CONGLOMERATE with friable, light brown coarse sand matrix, matrix supported, channelized, moist, hard.	
50	15-12"	C		14.5	118.5	@51' - Scoured contact with light brown clayey fine grained SANDSTONE, massive, with occasional gradational stringers of siltstone.	@51' Scoured Contact N46W/18NE
55						@56' - Grading into light brown fine to coarse grained SANDSTONE with sparse subangular gravel, friable, moist. @57' - Grading into light brown gravel CONGLOMERATE with occasional cobbles, subangular gravel and cobbles, sand matrix, matrix supported, moist, hard, channelized.	
60	14-12"	C		6.5	113.7	@59' - Sharp contact with light brown silty fine grained SANDSTONE, scoured, massive, moist, hard. @61.5' - Grading into light brown gravel and cobble CONGLOMERATE, subangular clasts are weathered and fractured, sand matrix, matrix supported, well graded, moist, hard.	@59' Approx. Contact N5E/4NW @62.5' B N25W/17SW
65							
70	20-12"	C		10.7	116.5	@71' - Scoured contact into light brown fine to coarse grained SANDSTONE, friable, moist, hard. @72' - Light brown gravelly fine to coarse grained SANDSTONE, subangular gravel, moist, hard. @74' - Light brown cobble and gravel CONGLOMERATE, slightly friable, fine to coarse sand matrix, matrix supported, well graded, moist, hard. @76.5' - Scoured contact with brown CLAYSTONE, pervasively sheared, claystone shears have waxy surfaces, conglomerate above scoured down to 79' on NW wall.	@68' B N60W/14SW @71' Scoured Contact N15E/19NW
75							
80	17-12"	C		13.5	118.7	@78' - Grading into light brown silty fine grained SANDSTONE with sparse gravel, massive, moist, hard.	
85							

ADDITIONAL COMMENTS: C = Modified California Sampler
 Kelly Bar Weights:) - 30', 5,619 lbs.
 31 - 60', 3,745 lbs.
 61 - 90', 2,280 lbs.
 91 - 120', 1,200 lbs.

CLIENT: Pardee Homes					PROJECT: Skyline Ranch			W.O.: 8838
LOCATION: Santa Clarita					ELEVATION: 2021'			DATE: 6/5/06
RIG TYPE: 24" Bucket					HAMMER WEIGHTS: Kelly Bar Weights			DROP: 12"
N	U	B	M	DD	DESCRIPTION	ATTITUDES		
80								
85								
90	22-10"	C		11.7	122.6	@87' - Highly plastic brown CLAY seam, no noticable shears (approximately 2" thick). @88' - Light brown clayey fine grained SANDSTONE with subangular gravel, massive, hard, moist, with 1-2" thick brown clay seams at 88.5' and 90', clay seams are very stiff, moist, no shear surfaces.	@87' Contact N58W/7SW @88.5' clay seam N55W/10SW @90' clay seam N60W/20SW	
95								
100	25-10"	C		11.6	121.3	@99' - Brown discontinuous clay seam. @100' - Brown clay seam. @100.5' - Grading into light brown silty fine to medium grained SANDSTONE, hard, moist. @103' - Grading into light brown fine to medium grained SANDSTONE, moist, hard. @104' - Grading into light brown gravel CONGLOMERATE with fine to coarse sand matrix, matrix supported, subangular gravel, massive, hard, moist to very moist.	@100' Clay seam N27W/12SW	
105								
110	25-8"	C		6.4	116.1	@110' - Brown gravelly fine to coarse grained SANDSTONE, subangular gravel, friable, moist, hard. @113' - Fine grained gravel CONGLOMERATE with sheared olive clay (not observed downhole), only in surface cuttings.	@106' Approx. BN85E/15SE	
115								
120								
125								

ADDITIONAL COMMENTS: C = Modified California Sampler
 Kelly Bar Weights:) - 30', 5,619 lbs.
 31 - 60', 3,745 lbs.
 61 - 90', 2,280 lbs.
 91 - 120', 1,200 lbs.

CLIENT: Pardee Homes					PROJECT: Skyline Ranch		W.O.: 8838.002
LOCATION: Santa Clarita					ELEVATION: 1987'±		DATE: 6/7/06
RIG TYPE: 24" Bucket					HAMMER WEIGHTS: Kelly Bar Weights		DROP: 12"
	N	U	B	M	DD	DESCRIPTION	ATTITUDES
0						Colluvium: Brown clayey fine grained SAND, moist.	
						@1' - Saugus Formation: Light brown fine to coarse grained SANDSTONE, with subangular cobble and gravel, moist.	
						@3' - Light brown silty fine to medium grained SANDSTONE, hard, moist, rootlets.	
5						@4' - Gravel to cobble CONGLOMERATE with light brown fine to coarse sandstone matrix, matrix supported, subangular clasts.	@4' Contact E-W/7S
						@5' - Gravel to boulder CONGLOMERATE with light brown fine to coarse sandstone matrix, matrix supported.	@7' B N72W/19SW
10	9-12" C			3.7	124.8	@6' - Gravel to cobble CONGLOMERATE with light brown fine to medium sand matrix, matrix supported, clasts are fractured and subangular.	@8.5' Approx. scoured contact N30W/28SW
						@8.5' - Scoured irregular contact with CLAYSTONE.	@12.5' B N48W/29SW
						@10' - Subangular gravel to cobble CONGLOMERATE, slightly friable light brown medium to coarse sandstone matrix, hard, moist.	
15						@16' - Scoured contact with light brown silty fine grained SANDSTONE with occasional medium to coarse sand, hard, massive.	@16' Contact N2W/8NE
20	6-12" C					@20' - Undulatory contact with subangular gravel CONGLOMERATE, occasional cobble, slightly friable light brown fine to coarse sandstone matrix, well graded, occasional silt, channelized, moist, hard.	@20' B N32W/16SW
						@25.5' - Scoured contact to fine to coarse grained SANDSTONE with gravel, moist.	@23' Channel N70E/9SE
25						@27' - Grading to subangular gravel CONGLOMERATE with slightly friable light brown fine to coarse sandstone matrix, occasional cobbles, hard, moist.	@25.5' B N37W/19SW
30	20-12" C			5.8	127.6	@28.5' - Scoured contact with silty fine to medium grained SANDSTONE with occasional subangular gravel, hard, moist.	@28.5' Contact N48E/8SE
						@31' - Grading to subangular gravel to cobble CONGLOMERATE with light brown fine to coarse sandstone matrix, hard, moist.	
35						@36' - Irregular, scoured contact to brown clayey fine grained SANDSTONE, moist, hard, massive.	@34.5' B N26E/22SE
						@37.5' - Grading to light brown fine grained SANDSTONE, slightly friable, hard, moist, massive.	@36' Contact N47E/8SE
40	23-12" C			6.7	122.1	@40' - Grading to gravel to cobble CONGLOMERATE, light brown fine to coarse sandstone matrix, hard, moist.	
45							

ADDITIONAL COMMENTS: C = Modified California Sampler
 Kelly Bar Weights: 0 - 30', 5619 lbs. 136 - 155', 2223 lbs.
 31 - 60', 3745 lbs.
 61 - 90', 2280 lbs.
 91 - 120', 1223 lbs.
 121 - 135', 1723 lbs.

CLIENT: Pardee Homes					PROJECT: Skyline Ranch		W.O.: 8838.002
LOCATION: Santa Clarita					ELEVATION: 1987'±		DATE: 6/7/06
RIG TYPE: 24" Bucket					HAMMER WEIGHTS: Kelly Bar Weights		DROP: 12"
N	U	B	M	DD	DESCRIPTION		ATTITUDES
40							
45						@45' - Gravel to cobble CONGLOMERATE, channels dipping SE and NE. @46.5' - Irregular, scoured contact to brown clayey fine to medium grained SANDSTONE with slightly friable fine to coarse gravel, hard, moist.	
50			6.3	120.5		@47' - Grading to light brown gravelly SANDSTONE to gravel CONGLOMERATE, light brown fine to coarse sandstone matrix. @51' - Grading to gravel to cobble CONGLOMERATE with fine to coarse sand matrix supported, highly channelized. @54.5' - Grading to light brown fine to coarse grained SANDSTONE with gravel, friable, hard, moist. @56' - Grading to subangular gravel to cobble CONGLOMERATE with light brown fine to coarse sandstone matrix. @57' - Clast supported, highly channelized, gravel to cobble CONGLOMERATE.	@52' Channel N22W/14SW
60	15-12" C		10.7	121.9		@60.5' - Sharp scoured contact with brown sandy CLAYSTONE, slightly undulatory, paper thin shear at contact. @61' - Grading to gravelly SANDSTONE to subangular gravel CONGLOMERATE with slightly friable light brown fine to coarse sandstone matrix, channelized, well graded.	@60.5' Shear N46W/10SW @60.5' Contact N84W/13SW
65						@67' - Interbedded brown fine grained SANDSTONE and gravel CONGLOMERATE, slightly friable. @69' - Subangular gravel to cobble CONGLOMERATE, friable brown fine to coarse sandstone matrix, hard, very moist, well graded, crudely bedded with occasional 2"-6" thick fine to medium sandstone beds.	
70	26-12" C		7.1	123.4		@75' - Subangular gravel to cobble CONGLOMERATE, friable brown fine to coarse sandstone matrix, hard, very moist, well graded, crudely bedded.	
75						@80' - Subangular gravel to cobble CONGLOMERATE, friable brown fine to coarse sandstone matrix, hard, very moist, well graded, crudely bedded.	
80	2-12" C						
85							

ADDITIONAL COMMENTS:

C = Modified California Sampler
 Kelly Bar Weights: 0 - 30', 5619 lbs. 136 - 155', 2223 lbs.
 31 - 60', 3745 lbs.
 61 - 90', 2280 lbs.
 91 - 120', 1223 lbs.
 121 - 135', 1723 lbs.

SUBSURFACE DATA

LOG OF BORING B48

CLIENT: Pardee Homes					PROJECT: Skyline Ranch		W.O.: 8838.002
LOCATION: Santa Clarita					ELEVATION: 1987±		DATE: 6/7/06
RIG TYPE: 24" Bucket					HAMMER WEIGHTS: Kelly Bar Weights		DROP: 12"
N	U	B	M	DD	DESCRIPTION	ATTITUDES	
80							
85					@85' - Moisture increasing in gravel CONGLOMERATE with slightly friable brown fine to coarse sandstone matrix, hard, moist. @87' - Wet. @88' - Gravel CONGLOMERATE with friable brown fine to coarse sand matrix, hard, wet.		
90	29-12"	C			@90' - Slow seepage in brown fine to coarse grained SANDSTONE to gravel CONGLOMERATE, sand matrix supported. @91' - Grades to fine grained sandy SILTSTONE with occasional coarse gravel clasts.		
95	24-12"	C	X				
100					@97' - Pervasively sheared CLAYSTONE, waxy surface, nearly horizontal, undulatory upper contact, shears cutting through silty fine grained SANDSTONE. @98' - 4" thick undulatory shear. @98'3" - Contact with silty fine grained SANDSTONE, hard, moist, massive. @100' - 4" CONGLOMERATE bed with subangular gravel and cobbles, fine to coarse sand matrix supported, wet. @100.5' - Silty very fine grained SANDSTONE, massive. @103' - 12" thick subrounded gravel CONGLOMERATE, slightly friable, fine to medium sand matrix, hard, wet. @104' - Sharp, scoured contact with brown clayey fine grained SANDSTONE, hard, moist, massive. @107' - Conglomeratic fine to medium grained SANDSTONE, poorly bedded. @108' - Brown silty fine grained SANDSTONE, hard, moist. @109' - 4" thick conglomeratic fine to medium grained SANDSTONE interbed. @110' - 6" thick conglomeratic fine to medium grained SANDSTONE to clayey fine grained SANDSTONE, poorly defined bedding. @110.5' - Brown clayey fine grained SANDSTONE with occasional subangular fine gravels, very dense, moist. @115' - 6" thick conglomeratic fine to medium grained SANDSTONE. @116.5' - 6" thick CONGLOMERATE. @117' - Sharp contact with CLAYSTONE, hard. @118.5' - 1' thick CONGLOMERATE. @119' - Sharp contact with sheared clayey SANDSTONE, 6" thick, undulatory imbricated shears. @120' - Strong brown CLAYSTONE, stiff, highly plastic, undulatory upper contact, sheared and waxy surface, pervasively sheared throughout.	@97' Shear N43E/23SE @97.5' Shear N72W/31NE @98' Approx. shear N5E/5SE @103.5' Approx. B N50W/18SW	
105	30-10"	C					
110							
115						@115.5' Approx. B N75E/9SE @117' Approx. contact N65W/6SW @119' B N50W/50NE @120' Approx. contact N45W/16SW	
120			X				
125							
ADDITIONAL COMMENTS:					C = Modified California Sampler Kelly Bar Weights: 0 - 30', 5619 lbs. 136 - 155', 2223 lbs. 31 - 60', 3745 lbs. 61 - 90', 2280 lbs. 91 - 120', 1223 lbs. 121 - 135', 1723 lbs.		

CLIENT: Pardee Homes					PROJECT: Skyline Ranch			W.O.: 8838.002
LOCATION: Santa Clarita					ELEVATION: 1987'±			DATE: 6/7/06
RIG TYPE: 24" Bucket					HAMMER WEIGHTS: Kelly Bar Weights			DROP: 12"
	N	U	B	M	DD	DESCRIPTION		ATTITUDES
120						@122.2' - Sharp contact with silty fine grained SANDSTONE, hard, moist, contact is not sheared.		@123'
125						@125' - 1-2" thick clay seam truncates higher angle shear. @125' - 4" CONGLOMERATE just above clay seam. @125' - High angle clay shear through CONGLOMERATE, slickensides indicate horizontal motion along strike. @125.5' - Brown silty fine to medium grained SANDSTONE, hard, moist.		Contact N57W/32SW @125' Clay seam N65W/13SW
130						@131' - Subangular fine to coarse grained gravel CONGLOMERATE, slightly friable, brown medium to coarse sand matrix, moderately graded, hard, moist, crudely bedded. @132' - Gravel CONGLOMERATE.		@125' Shear N86E/66NW
135						@134' - Thinly bedded. @137' - Contact with approximately 6" thick brown fine grained sandy SILTSTONE, hard, wet. @138' - Discontinuous seepage.		@134' B N66W/9SW
140						@138.5' - Brown silty fine grained SANDSTONE, wet, hard, massive. @141' - Approximately 6" thick discontinuous SILTSTONE.		
145	25-12"	C				@145' - Brown silty fine grained SANDSTONE, hard, wet, massive. @147' - Lower limit of zone of seepage. @148' - Brown silty fine grained SANDSTONE with some clay, massive.		
150						@153' - Seepage from NE quadrant of boring in 12" thick gravel CONGLOMERATE.		
155	36-10"	C				Total Depth - 155' Seepage at 90', 138-147', and 153' No caving Backfilled		
160								
165								

ADDITIONAL COMMENTS: C = Modified California Sampler
 Kelly Bar Weights: 0 - 30', 5619 lbs. 136 - 155', 2223 lbs.
 31 - 60', 3745 lbs.
 61 - 90', 2280 lbs.
 91 - 120', 1223 lbs.
 121 - 135', 1723 lbs.

SUBSURFACE DATA

LOG OF BORING B49

CLIENT: Pardee Homes					PROJECT: Skyline Ranch		W.O.: 8838.002
LOCATION: Santa Clarita					ELEVATION: 2091'		DATE: 6/12/06
RIG TYPE: 24" Bucket					HAMMER WEIGHTS: Kelly Bar Weights		DROP: 12"
	N	U	B	M	DD	DESCRIPTION	ATTITUDES
0						<u>Saugus Formation</u> : Dark brown clayey fine to coarse grained SAND with subangular gravel, moist, very dense, weathered.	
5						@4' - Gradational contact with yellowish brown silty fine to coarse grained SANDSTONE with occasional gravel, hard, moist. @6' - Yellowish brown fine to coarse grained SANDSTONE with occasional subangular gravel, clasts include quartz, shist, and granitics, friable, moist, hard.	@6' Approx. contact N10E/8NW
10	4-12" C			5.4	115.1	@8' - Discontinuous SILTSTONE (approx. 6" thick) on eastern quadrant of boring, massive, moist, hard. @9' - Highly channelized fine to medium grained SANDSTONE to subangular gravel CONGLOMERATE, matrix supported, friable, hard, moist.	@13' Approx. BN16W/19SW
15						@11' - Brown subangular gravel to cobble CONGLOMERATE, matrix supported, highly channelized, friable, hard, moist. @13' - Conglomeratic fine to coarse grained SANDSTONE, subangular to subrounded fine gravel to cobble clasts, moist, hard.	@16' Approx. BN70E/24NW
20	5-12" C			5.7	120.2	@16 - Gravel to occasional boulder (<5%) CONGLOMERATE, channeled, crudely bedded, slightly friable, brown fine to coarse sand matrix, moist, hard. @20' - Channeled CONGLOMERATE.	@20' Scoured channels dipping N & S
25						@23' - Channelized contact with fine to medium grained SANDSTONE with coarse sand, friable. @24' - Grading to subangular gravel CONGLOMERATE, sand matrix, matrix supported.	@23' Contact N15E/21NW @25' Approx. BN45W/21NE
30	18-12" C			13.4	119.9	@26' - Sharp, scoured contact with silty fine grained SANDSTONE with clay, massive. @27.5' - Irregular, discontinuous paper thin shear, waxy, clay lined.	@26' Contact N31W/25NE
35						@31' - Brown silty very fine grained SANDSTONE with very sparse coarse sand and fine gravel, moist, hard. @32' - Grades to brown fine grained SANDSTONE with very sparse coarse sand and fine gravel, massive, moist, hard.	
40	11-12" C			17.4	111.4	@36.5' - Brown angular fine gravel CONGLOMERATE with clayey sand matrix, gradational upper contact (approximately 4" thick bed), moist, hard. @37' - Brown fine grained sandy SILTSTONE, moist, hard. @40' - Slightly waxy clayey SANDSTONE with carbonate nodules, poorly defined shears.	@37' Approx. contact N55E/25SE @40' Approx. attitude of carb. nodules N5E/25SE
45							
ADDITIONAL COMMENTS:					C = Modified California Sampler Kelly Bar Weights: 0 - 30', 5619 lbs. 136 - 155', 2223 lbs. 31 - 60', 3745 lbs. 61 - 90', 2280 lbs. 91 - 120', 1223 lbs. 121 - 135', 1723 lbs.		

CLIENT: Pardee Homes					PROJECT: Skyline Ranch		W.O.: 8838.002
LOCATION: Santa Clarita					ELEVATION: 2091'		DATE: 6/12/06
RIG TYPE: 24" Bucket					HAMMER WEIGHTS: Kelly Bar Weights		DROP: 12"
	N	U	B	M	DD	DESCRIPTION	ATTITUDES
40							
						@43' - Grades to brown clayey fine grained SANDSTONE with occasional coarse sands and fine gravel, thickly bedded, hard, moist.	
45						@46.5' - Sandy CLAYSTONE (approx. 6" thick). @47.5' - Subrounded fine gravel CONGLOMERATE (approx. 6" thick). @48' - Brown clayey fine grained SANDSTONE with occasional coarse sands and fine gravel, massive, hard, moist.	@46' Approx. contact E-W/12N @47.5' Approx. BN75W/17NE
50	17-12" C			10.6	104.4	@52' - Grades to conglomeratic fine to medium grained SANDSTONE, subangular fine to coarse gravel clasts, moist, hard (approx. 3" thick), lower contact is highly scoured and irregular.	
						@55' - Sheared contact to brown fine grained sandy CLAYSTONE with poorly defined shears. @56' - Grades to brown silty fine grained SANDSTONE with occasional subangular fine gravel, moist, hard. @59' - Grades to brown medium to coarse grained SANDSTONE, moist, hard.	@55' Sheared contact N12W/60SW
60	13-12" C			14.9	117.9	@60' - Contact with gravel and cobble CONGLOMERATE, brown silty fine to coarse sand matrix, matrix supported, increase in moisture to very moist.	@60' Contact N36W/16SW
65						@65' - Grading to gravel and cobble CONGLOMERATE with brown fine to coarse sand matrix, higher % of gravel and cobble clasts. @67' - Interbedded gravel CONGLOMERATE with fine to coarse sand matrix and fine gravelly medium to coarse sandstone interbeds between 2" and 8" thick, sand is friable, both beds exhibit occasional coarse gravel.	@67' B N52W/34NE N75W/22NE N35W/31NE
70	20-12" C			9.9	118.6	@69'8" - Sharp contact with 1" thick clayey fine grained SANDSTONE, grading to fine to coarse grained SANDSTONE. @70' - Brown fine to coarse grained SANDSTONE with occasional cobbles. @70.5' - Silty fine grained SANDSTONE, wet, hard. @71' - Silty gravelly fine grained SANDSTONE. @71.5' - Brown CLAYSTONE, pervasively sheared, very stiff, waxy. @72' - Very slow seepage in NW quadrant above 4" thick sheared claystone, grading to clayey fine grained SANDSTONE, waxy shear surfaces in claystone.	@67.5' B N49W/39NE @69.5' Contact N30W/57NE @69'8" Contact N44W/21NE @70.5' Contact N59W/15NE @72' Shear N42E/20NE
75						@72.5' - Massive brown silty very fine grained SANDSTONE to very fine grained sandy SILTSTONE, occasional seepage. @75.5' - Gravel CONGLOMERATE with fine to coarse sand matrix, wet. @79.5' - Sheared CLAYSTONE, seepage around entire hole. @80' - 4" thick clay shear (across bedding).	@75.5' Contact N30E/13NW @79.5' Shear N10W/35SW slicks bear S85W
80	30-12" C		X	13.4	122.1		
85							
ADDITIONAL COMMENTS:						C = Modified California Sampler Kelly Bar Weights: 0 - 30', 5619 lbs. 136 - 155', 2223 lbs. 31 - 60', 3745 lbs. 61 - 90', 2280 lbs. 91 - 120', 1223 lbs. 121 - 135', 1723 lbs.	

SUBSURFACE DATA

LOG OF BORING B49

CLIENT: Pardee Homes						PROJECT: Skyline Ranch		W.O.: 8838.002
LOCATION: Santa Clarita						ELEVATION: 2091'		DATE: 6/12/06
RIG TYPE: 24" Bucket						HAMMER WEIGHTS: Kelly Bar Weights		DROP: 12"
	N	U	B	M	DD	DESCRIPTION		ATTITUDES
80						@80.5' - Brown fine grained SANDSTONE, hard, wet.		@79.5' Shear
						@82' - Grading to fine to coarse grained SANDSTONE, hard, wet.		N14E/56SE
						@84' - Grading to gravelly fine to coarse grained SANDSTONE, hard, wet.		slicks bear
85						@85' - Grading to gravel cobble CONGLOMERATE with weakly cemented to slightly friable brown fine to coarse sandstone matrix.		N84E
						@87' - Grades to brown clayey fine grained SANDSTONE, hard, wet.		@80' Shear
						@90' - No sample recovered.		N5E/14NW
90	26-8" C					@91' - Grades to fine gravel CONGLOMERATE (approx. 12" thick) interbed.		@86' Approx.
						@92' - Grades to brown clayey fine grained SANDSTONE.		BN45E/18NW
						@93.5' - Fine to coarse grained SANDSTONE with occasional subround fine gravel.		
95						@95' - Sharp contact to 1" thick CLAYSTONE, pervasive shears throughout fine to coarse grained SANDSTONE with occasional subrounded fine gravel to coarse sand.		@95' Shear
						@95.5' - Parallel shears (across bedding).		N61W/7SW
100	24-9" C		5.7	112.8		@98' - Grades to subrounded to subangular fine to coarse grained gravel CONGLOMERATE, weakly cemented to slightly friable, brown fine to coarse sand matrix, hard, wet.		@95.5' Shear
						@102' - Heavy seepage.		N31W/32NE
						@103' - Grades to fine to coarse grained SANDSTONE.		@100' B
105						@104.5' - Sharp contact to clayey fine grained SANDSTONE.		N34W/20SW
						@106' - Grading to sandy CLAYSTONE, pervasive shearing, very stiff, wet.		@102' B
						@106-108.5' - Brecciated sandy CLAYSTONE.		N77W/20NE
110	30-8" C		15.3	110.7		@108.5' - Clayey fine grained SANDSTONE, hard, wet.		@104.5' Approx.
						@113' - Sharp contact to fine gravel CONGLOMERATE, weakly cemented brown fine to coarse sandstone matrix, hard, wet.		contact
115						@115' - Fine gravel CONGLOMERATE, crudely bedded, weakly cemented brown fine to coarse sandstone matrix, hard, wet.		N35W/11SW
120	28-10" C		14.9	113.1		@122' - Contact to brown fine grained SANDSTONE.		@113' Approx.
								contact
125								N50W/27SW
								@118' Approx.
								BN35E/25NW

ADDITIONAL COMMENTS: C = Modified California Sampler
 Kelly Bar Weights: 0 - 30', 5619 lbs. 136 - 155', 2223 lbs.
 31 - 60', 3745 lbs.
 61 - 90', 2280 lbs.
 91 - 120', 1223 lbs.
 121 - 135', 1723 lbs.

CLIENT: Pardee Homes					PROJECT: Skyline Ranch		W.O.: 8838.002
LOCATION: Santa Clarita					ELEVATION: 2091'		DATE: 6/12/06
RIG TYPE: 24" Bucket					HAMMER WEIGHTS: Kelly Bar Weights		DROP: 12"
	N	U	B	M	DD	DESCRIPTION	ATTITUDES
120							
						@123' - Standing water in boring (after 24 hours), unable to downhole log below.	
125							
130	30-10"	C		12.1	123.1	@130' - Brown fine to coarse grained SANDSTONE, friable, wet, free water in sampler, hard.	
135							
						@137' - Brown pervasively sheared CLAYSTONE, highly plastic, wet.	
140	15-12"	C		16.7	108.0	@140' - Brown pervasively sheared CLAYSTONE, grading to brown fine grained SANDSTONE, wet, hard.	
145							
150							
155						Total Depth - 140' No caving Seepage below 70', standing water at 123' (24 hours after drilling completed) Backfilled	
160							
165							

ADDITIONAL COMMENTS: C = Modified California Sampler
 Kelly Bar Weights: 0 - 30', 5619 lbs. 136 - 155', 2223 lbs.
 31 - 60', 3745 lbs.
 61 - 90', 2280 lbs.
 91 - 120', 1223 lbs.
 121 - 135', 1723 lbs.

SUBSURFACE DATA

LOG OF BORING B50

CLIENT: Pardee Homes					PROJECT: Skyline Ranch		W.O.: 8838.002
LOCATION: Santa Clarita					ELEVATION: 2245'±		DATE: 6/13/06
RIG TYPE: 24" Bucket					HAMMER WEIGHTS: Kelly Bar Weights		DROP: 12"
N	U	B	M	DD	DESCRIPTION	ATTITUDES	
0					<u>Topsoil</u> : Dark gray brown clayey fine to coarse grained SAND with subangular to subrounded gravel to boulder clasts, weathered, dense, moist.		
5					@2.5' - <u>Mint Canyon Formation</u> : Subangular to subrounded gravel to boulder CONGLOMERATE, weakly cemented olive brown fine to coarse sandstone matrix, well graded, moist, hard.		
10	15/20	C		3.2	--	@6' - Subangular to subrounded gravel to boulder CONGLOMERATE, weakly cemented olive gray fine to coarse sandstone matrix, moist, massive, hard, well graded clasts predominantly granitic with some meta volcanics, channelized, crudely bedded (less than 5% 12" diameter boulders). @10' - Subangular to subrounded gravel, cobble, boulder CONGLOMERATE, weakly cemented olive gray fine to coarse sandstone matrix, hard, moist. @13' - Bedded zone of boulders.	@10' B N56W/13SW
15						@15' - Subangular to subrounded gravel to boulder CONGLOMERATE, weakly cemented olive brown fine to coarse sandstone matrix, well graded, hard, moist, increase in boulders to 5-10%.	@15' Approx. BN60W/35SW
20	19/21	C	X	--	--	@20' - Subangular to subrounded gravel to boulder CONGLOMERATE, weakly cemented olive brown fine to coarse sandstone matrix, well graded, hard, moist. @21' - Percentage of boulders less than 5%.	@19' B N54W/23SW
25						@27' - Subangular to subrounded gravel to boulder CONGLOMERATE, weakly cemented olive brown fine to coarse sandstone matrix, well graded, hard, moist, occasional poorly graded fine coarse grained gravel approximately 12" thick.	@27' B N34E/17SE
30			X	--		@30' - Subangular to subrounded gravel to cobble (occasional boulder) CONGLOMERATE, weakly cemented olive brown fine to coarse sandstone matrix, hard, moist.	@33' B N61E/21SE
35						@36' - Sharp contact to olive gray fine grained SANDSTONE, moderately indurated, very hard, moist, massive.	@35' B N77W/23SW
40	11/23	C	X	8.2	120.1	@38' - Occasional thin beds of weakly cemented fine to medium grained SANDSTONE and thin beds of slightly friable conglomeratic medium to coarse grained SANDSTONE, clasts are subangular, fine to coarse gravel (up to 4" diameter), moist, very hard. @39.5' - Sharp sheared contact to clayey fine grained SANDSTONE (approx. 1" thick), moist, very hard, grading to weakly indurated medium to coarse grained SANDSTONE, very hard.	@36' Contact N62W/22SW @38' B N36W/18SW @39.5' Sheared contact N43W/26SW
45							
ADDITIONAL COMMENTS:					Blows per 6" C = Modified California Sampler Kelly Bar Weights: 0 - 50', 2280 lbs. 50- 75', 1200 lbs.		

CLIENT: Pardee Homes					PROJECT: Skyline Ranch		W.O.: 8838.002
LOCATION: Santa Clarita					ELEVATION: 2245'±		DATE: 6/13/06
RIG TYPE: 24" Bucket					HAMMER WEIGHTS: Kelly Bar Weights		DROP: 12"
	N	U	B	M	DD	DESCRIPTION	ATTITUDES
40						@40' - Light gray brown fine to coarse grained SANDSTONE with subangular to subrounded fine gravel, slightly friable, hard, moist.	
						@41' - Occasional thin beds of fine grained GRAVEL.	@42.5' B
						@43' - Subangular gravel cobble CONGLOMERATE, occasional boulders, well graded, slightly friable, olive gray fine to coarse sandstone matrix, hard, moist.	N34W/16SW
45							
						@47' - Sharp contact to fine to medium grained SANDSTONE, weakly indurated, very hard, moist.	@47' Contact
						@48' - Grades to subangular to subrounded fine gravel to cobble CONGLOMERATE, weakly cemented, olive gray fine to coarse sandstone matrix, hard, moist.	N34W/17SW
50	10/15	C		17.8	110.3		
						@50' - Light gray brown fine to coarse grained SANDSTONE with subangular to subrounded gravels, occasional cobbles, moist, hard.	@51' B
			X			@52.5' - Sharp contact to light olive gray fine to medium grained SANDSTONE, weakly indurated, moist, hard.	N16W/26SW
55						@54' - Grades to subangular to subrounded fine gravel to cobble CONGLOMERATE, weakly cemented.	@54.75' Shear
						@54.5' - Approximately 12" thick clayey fine grained SANDSTONE, pervasively sheared, slightly plastic, stiff, moist, grading to subangular to subrounded fine grained gravel to cobble CONGLOMERATE, massive, hard, moist.	N17W/16SW
60	20/30	C		3.5	13.6		
						@60' - Light gray brown fine to coarse grained SANDSTONE with subangular to subrounded coarse gravel to cobble clasts, hard, moist, friable, massive.	
65							
			X			@67' - Olive brown fine to coarse grained SANDSTONE with subangular to subrounded gravel, moderately indurated, moist, hard, occasional cobbles.	
70							
75						Total Depth - 67' No groundwater No caving Backfilled	
80							
85							

ADDITIONAL COMMENTS: Blows per 6"
 C = Modified California Sampler
 Kelly Bar Weights: 0 - 50', 2280 lbs.
 50- 75', 1200 lbs.

SUBSURFACE DATA

LOG OF BORING B51

CLIENT: Pardee Homes					PROJECT: Skyline Ranch		W.O.: 8838.002
LOCATION: Santa Clarita					ELEVATION: 1765'±		DATE: 6/15/06
RIG TYPE: 24" Bucket					HAMMER WEIGHTS: Kelly Bar Weights		DROP: 12"
	N	U	B	M	DD	DESCRIPTION	ATTITUDES
0						Topsoil: Medium brown fine grained SAND with fine gravel, moist.	
5						@3' - <u>Landslide Deposit</u> : Near vertical carbonate veinlets/nodules approximately 8" diameter. @4.5' - Medium to coarse grained SANDSTONE with subangular to subrounded fine to coarse gravel, friable, rootlets, very dense, moist. @7' - Grades to fine grained SANDSTONE, sparse fine gravel, slightly friable, very dense, moist, occasional rootlets, massive.	
10	6/10	C		12.2	113.4	@10' - Light orange to grayish brown silty fine to coarse grained SANDSTONE with fine to coarse gravels, occasional boulders (less than 5%), very dense, moist.	@13' Contact N15W/46SW
15							@17.5' B N87E/27SE
20	7/15	C	X	15.1	116.0	@20' - Light orange brown fine to coarse grained SANDSTONE with clay, subangular to subrounded gravel, layers of highly plastic clay, moist, very dense, moderately to well graded. @21' - Clay shear (1-2" thick), waxy, internally sheared, plastic, no distinct slicks.	@21' Shear N52W/9SW
25							@25' Shear N78W/21SW
30	6/18	C	X	10.0	121.5	@28' - Grades to olive fine to medium grained SANDSTONE with fine gravel. @28.5' - Contact with shear, updip side of undulatory upper contact with multiple shears, to 12" thick zone of shearing in clayey fine grained sand. @29.4' - Basal shear surface (undulatory). @30' - <u>Saugus Formation</u> : Olive silty fine grained SANDSTONE with clay, oxidized, grading to greenish gray fine grained sandy SILTSTONE, hard, moist, massive.	@26' Shear N79E/29NW
35							@28.5' Approx. Shear N20E/15NW
40	15/30	C		5.4	108.7	@32.5' - Contact to olive silty fine to medium grained SANDSTONE with occasional fine gravel, hard, moist, slightly friable, massive. @34' - Contact to 4" thick SILTSTONE, grades to olive fine to medium grained SANDSTONE, slightly friable, moist, hard. @40' - Light to medium yellow brown medium to coarse grained SANDSTONE, subangular to subrounded fine gravels, occasional cobbles, very dense, moist, moderately graded.	@29.4' Basal Shear N22W/6SW
45							N53W/6SW
							@34' Approx. BN5W/7SW
							@36.5' B N34W/8SW
ADDITIONAL COMMENTS:						Blows per 6"	
						C = Modified California Sampler	
						Kelly Bar Weights: 0 - 50', 2280 lbs.	
						50- 75', 1200 lbs.	

SUBSURFACE DATA

LOG OF BORING B51

CLIENT: Pardee Homes					PROJECT: Skyline Ranch		W.O.: 8838.002
LOCATION: Santa Clarita					ELEVATION: 1765±		DATE: 6/15/06
RIG TYPE: 24" Bucket					HAMMER WEIGHTS: Kelly Bar Weights		DROP: 12"
	N	U	B	M	DD	DESCRIPTION	ATTITUDES
40						@41' - Fine to coarse grained gravel CONGLOMERATE with cobbles, well graded, channels dip north and south, slightly friable olive coarse grained sandstone matrix.	
45						@44' - Medium to coarse grained SANDSTONE with occasional fine gravel and cobble CONGLOMERATE. @46' - Siltstone ripup clasts.	@46' B N30E/11NW
50	10/30	C		6.2	126.0	@50' - Light yellow brown medium to coarse grained SANDSTONE with well graded fine gravel to boulder (10% boulder clasts) CONGLOMERATE, moist, very weathered clasts.	@50' Approx. BN20W/21SW
55			X			@58' - Fine gravel to cobble CONGLOMERATE with occasional boulder clasts, well graded, crudely bedded, slightly friable, yellow brown fine to coarse grained sandstone matrix, hard, moist, crudely bedded.	@57' Approx. BN10W/29SW
60	20/30	C		8.5	117.6		
65							
70	20/25	C		9.6	111.7	@70' - Subangular to subrounded fine to coarse gravel and occasional cobble CONGLOMERATE with yellow brown medium to coarse grained sandstone matrix, well graded, hard, moist.	
75						Total Depth - 72' No groundwater No caving Backfilled	
80							
85							

ADDITIONAL COMMENTS:

Blows per 6"
 C = Modified California Sampler
 Kelly Bar Weights: 0 - 50', 2280 lbs.
 50- 75', 1200 lbs.

CLIENT: Pardee Homes					PROJECT: Skyline Ranch		W.O.: 8838.002
LOCATION: Santa Clarita					ELEVATION: 2245'±		DATE: 6/19/06
RIG TYPE: 24" Bucket					HAMMER WEIGHTS: Kelly Bar Weights		DROP: 12"
N	U	B	M	DD	DESCRIPTION	ATTITUDES	
0					Mint Canyon Formation: Tan subrounded gravel to cobble CONGLOMERATE with fine to medium sand matrix, clasts are fractured in upper 1', moist.		
5					@2.5' - Subrounded to rounded cobble to boulder CONGLOMERATE with fine to medium sand matrix, hard, rootlets, matrix supported, channelized.		
10	10-8" C		1.8	133.7	@7' - Scoured contact with yellowish brown fine to medium grained SANDSTONE, hard, channelized, moist. @8' - Undulatory contact with yellowish brown cobble to gravel CONGLOMERATE, coarse sand matrix, matrix supported, moist, hard.	@7' Channel N66W/24SW @8' Contact N60W/28SW	
15					@9.5' - Yellowish brown gravel-cobble-boulder CONGLOMERATE, fine to coarse sand matrix, matrix supported, channelized, approximately 15% boulders, moist. @11' - Boulder approx. 2' diameter. @12' - Tan to gray cobble to boulder CONGLOMERATE, fine to coarse sand matrix, matrix supported, channelized.		
20	9-12" C		10.7	122.0	@17' - Tan to gray cobble to boulder CONGLOMERATE, fine to coarse sand matrix, matrix supported, channelized.		
25					@23' - Light olive brown gravel-cobble-boulder CONGLOMERATE, fine to coarse sand matrix, matrix supported, channelized, decrease in % boulders, cobbles and gravel, moist, hard. @25' - Light olive brown gravel-cobble-boulder CONGLOMERATE, fine to coarse grained sand matrix, matrix supported, channelized, increase in frequency of coarse clasts, moist.		
30	26-12" C		7.6	124.3	@30' - Light olive brown gravel to cobble CONGLOMERATE, friable fine to coarse sand matrix, matrix supported, hard, moist.		
35					@36.5' - Channelized, scoured contact to light olive brown fine grained gravelly fine to coarse grained SANDSTONE, hard, moist. @38' - Contact to light yellow brown subangular to subrounded gravel to cobble CONGLOMERATE, hard, moist.	@36.5' Channel N34W/17SW @38' Contact N50W/24SW	
40							
45							
ADDITIONAL COMMENTS:					C = Modified California Sampler Kelly Bar Weights: 0 - 30', 5619 lbs. 31 - 60', 3745 lbs. 61 - 90', 2280 lbs. 91 - 120', 1223 lbs.		

CLIENT: Pardee Homes					PROJECT: Skyline Ranch		W.O.: 8838.002
LOCATION: Santa Clarita					ELEVATION: 2245±		DATE: 6/19/06
RIG TYPE: 24" Bucket					HAMMER WEIGHTS: Kelly Bar Weights		DROP: 12"
	N	U	B	M	DD	DESCRIPTION	ATTITUDES
40						@41' - Light yellow brown subangular to subrounded gravel to cobble CONGLOMERATE, moist.	
	20-12" C			4.8	128.3		
45						@45.5' - Scoured, channelized contact to light olive brown fine to coarse grained SANDSTONE, occasional gravel, moist.	@45.5' Scoured contact
						@46' - Contact to fine to medium grained SANDSTONE with occasional coarse sand, moist.	N69W/19SW
						@47' - Irregular contact to light olive brown gravel to cobble CONGLOMERATE with occasional boulders (approximately 5%), weakly cemented olive gray fine to coarse sand matrix, matrix supported, moist, hard.	@46' B N50W/19SW
50	15-10" C			6.3	114.0		@47' Contact N36W/20SW
						@49.5' - Contact to light olive brown fine to coarse grained SANDSTONE with fine gravel, friable, moist.	@49.5' Contact N45W/21SW
55						@50.5' - Contact to light olive brown gravel to cobble with occasional boulder CONGLOMERATE, fine to medium sand matrix, matrix supported, moist.	@50.5' Contact N57W/16SW
						@51' - Approximately 18" diameter boulders.	
						@57' - Light olive brown gravel to cobble with occasional boulder CONGLOMERATE, fine to medium sand matrix, matrix supported, moist, hard.	
60	17-12" C			5.5	122.8		
						@65' - Cobble to boulder CONGLOMERATE, clast supported to matrix supported, weakly cemented olive gray fine to medium sand matrix with occasional gravel, moist, hard.	@64' B N20E/26NW
65							
70						@70' - Cobble to boulder CONGLOMERATE, clast supported to matrix supported, weakly cemented olive gray fine to medium sand matrix with occasional gravel, moist, hard.	
	25-12" C			4.2	142.0		
75						@77.5' - Scoured contact to light olive brown fine to coarse grained SANDSTONE with fine gravel, moist, hard.	@77.5' Contact N44W/29SW
						@78.5' - Contact to light olive brown gravel to cobble CONGLOMERATE, weakly cemented olive gray fine to coarse sand matrix, matrix supported, moist, hard.	@78.5' B N28W/22SW
80							
85							

ADDITIONAL COMMENTS:

C = Modified California Sampler
 Kelly Bar Weights: 0 - 30', 5619 lbs.
 31 - 60', 3745 lbs.
 61 - 90', 2280 lbs.
 91 - 120', 1223 lbs.

SUBSURFACE DATA

LOG OF BORING B52

CLIENT: Pardee Homes					PROJECT: Skyline Ranch		W.O.: 8838.002
LOCATION: Santa Clarita					ELEVATION: 2245±		DATE: 6/19/06
RIG TYPE: 24" Bucket					HAMMER WEIGHTS: Kelly Bar Weights		DROP: 12"
N	U	B	M	DD	DESCRIPTION	ATTITUDES	
80					@81' - Grading to light olive brown cobble to boulder CONGLOMERATE, weakly cemented olive gray fine to coarse sandstone matrix.		
85					@85.5' - Grading to light olive brown fine to coarse grained SANDSTONE. @86.5' - Subrounded gravel to boulder CONGLOMERATE, well graded, crudely bedded, weakly cemented olive gray fine to coarse sand matrix, hard, moist.	@86' B N34W/22SW	
	24-12" C		5.9	107.9		@89± B N10E/23NW	
90					@90' - Subrounded fine gravel to cobble CONGLOMERATE, well graded, crudely bedded, weakly cemented olive gray fine to coarse sandstone matrix, hard, moist.	@92' B N10W/19SW	
95					@95' - Subrounded fine gravel to cobble CONGLOMERATE, well graded, crudely bedded, weakly cemented olive gray fine to coarse sandstone matrix, hard, moist.	@98± B N40W/20SW	
100					@100' - Subrounded fine gravel to cobble CONGLOMERATE, well graded, crudely bedded, weakly cemented olive gray fine to coarse sandstone matrix, hard, moist.		
105					@105' - Subrounded fine gravel to cobble CONGLOMERATE, well graded, crudely bedded, weakly cemented olive gray fine to coarse sandstone matrix, hard, channeled, moist.	@106' B N47W/19SW	
110					@109' - Subrounded fine gravel to cobble CONGLOMERATE, well graded, crudely bedded, weakly cemented olive gray fine to coarse sandstone matrix, hard, channeled, moist.		
115					@113' - Subrounded fine gravel to cobble CONGLOMERATE, well graded, crudely bedded, weakly cemented olive gray fine to coarse sandstone matrix, hard, channeled, moist.	@113± B N30W/24SW	
120					@118' - Subrounded fine gravel to cobble CONGLOMERATE, well graded, crudely bedded, weakly cemented olive gray fine to coarse sandstone matrix, hard, channeled, moist.		
125					@122' - 12" thick olive gray fine to medium grained SANDSTONE to subrounded gravel to boulder CONGLOMERATE, well graded, weakly cemented olive gray fine to coarse sandstone matrix, moist. Total Depth - 123', No groundwater, No caving, Backfilled		
ADDITIONAL COMMENTS:					C = Modified California Sampler Kelly Bar Weights: 0 - 30', 5619 lbs. 31 - 60', 3745 lbs. 61 - 90', 2280 lbs. 91 - 120', 1223 lbs.		

SUBSURFACE DATA

LOG OF BORING B53

CLIENT: Pardee Homes					PROJECT: Skyline Ranch		W.O.: 8838.002
LOCATION: Santa Clarita					ELEVATION: 1770±		DATE: 6/16/06
RIG TYPE: 24" Bucket					HAMMER WEIGHTS: Kelly Bar Weights		DROP: 12"
	N	U	B	M	DD	DESCRIPTION	ATTITUDES
0						<u>Saugus Formation</u> : Dark grayish brown clayey fine grained SANDSTONE with abundant subangular fine gravel, very dense, moist.	
5						@4' - Grades to dark yellowish brown fine grained SANDSTONE with subangular fine gravel, very dense, moist, crudely bedded.	
10	6/12	C		11.2	122.5	@10.5' - Sheared clay at contact to strong brown silty fine grained SANDSTONE, very dense, moist. @12' - 2"-6" thick sheared clay, stiff, highly plastic, to dark yellow brown fine to medium grained SANDSTONE with fine gravel and clay, very dense, moist, massive.	@10.5' Shear N44W/17SW @12' Approx. shear N12W/8SW @14' B N25W/25SW
15			X			@17' - Brown SILTSTONE, very stiff, moist, to clayey fine grained SANDSTONE, hard, moist, massive. @19' - Grades to slightly friable medium to coarse grained SANDSTONE with fine gravel, hard, moist, crudely bedded.	
20	10/15	C		12.0	124.6	@20' - Scoured contact to fine grained SANDSTONE, hard, moist. @22' - 12" thick gravel CONGLOMERATE channel, to slightly friable yellow brown fine to medium grained SANDSTONE, massive, hard, moist, grading to channelized medium to coarse grained SANDSTONE and gravel CONGLOMERATE. @27' - Scoured contact (E dipping) to dark yellow brown fine grained SANDSTONE, massive, hard, moist.	@20' Contact N65W/16NE @22' Channel N34E/17NW @23' Contact N28W/13SW @26' Channel N-S/13E
25							
30	12/28	C		16.0	114.5	@32' - 1"-3" thick strong brown CLAY shear, highly plastic, to 12" CLAYSTONE, grading to yellow brown fine grained SANDSTONE, massive, hard, moist.	@32' Shear N6E/7NW
35			X			@36' - Pinhole seep on NW wall. @37' - Nearly horizontal, undulatory 1" thick CLAY seam, highly plastic, sheared.	@37' Shear Horizontal
40	12/22	C		10.1	127.9	@40' - Undulatory, nearly horizontal, highly plastic 1" thick CLAY shear, to yellow brown fine grained SANDSTONE with subangular gravel, massive.	@40' Shear Horizontal
45							
ADDITIONAL COMMENTS:					Blows per 6" C = Modified California Sampler Kelly Bar Weights: 0 - 50', 2280 lbs. 50- 75', 1200 lbs.		

SUBSURFACE DATA

LOG OF BORING B53

CLIENT: Pardee Homes					PROJECT: Skyline Ranch		W.O.: 8838.002
LOCATION: Santa Clarita					ELEVATION: 1770'±		DATE: 6/16/06
RIG TYPE: 24" Bucket					HAMMER WEIGHTS: Kelly Bar Weights		DROP: 12"
	N	U	B	M	DD	DESCRIPTION	ATTITUDES
40							
						@42' - Grading to subangular fine to coarse grained gravel CONGLOMERATE, well graded, crudely bedded, slightly friable yellow brown fine to coarse grained sandstone matrix, hard, moist.	@44' Approx. contact N40E/44NW
45						@44' - Sharp, slightly scoured contact to yellow brown clayey fine grained SANDSTONE, massive, hard, moist.	
						@47' - Grading to slightly friable medium to coarse grained SANDSTONE with abundant subangular fine gravel, hard, moist.	
50	10/20	C		13.8	122.7	@49' - Sharp, slightly scoured contact to clayey fine grained SANDSTONE, hard, moist, massive, with occasional subangular fine gravel.	@49' Approx. contact N-S/5W
						@52' - Grading to slightly friable subangular fine gravel CONGLOMERATE.	
						@53' - Irregular sharp contact to clayey fine grained SANDSTONE with occasional carbonate nodules and fine gravel, massive, hard, moist.	
55							
60	15/20	C		12.4	119.2	@60' - Brown clayey SILTSTONE, massive, hard, moist.	
						@63' - Grades to massive dark yellow brown fine grained SANDSTONE with subangular fine gravel, hard, moist.	
65							
70	15/25	C		10.6	120.9	@68' - Grades to massive dark yellow brown fine grained SANDSTONE with subangular fine gravel, hard, moist.	@68' Approx. BN70W/14NE
75						Total Depth - 75' Light seepage at 36' No caving Backfilled	
80							
85							

ADDITIONAL COMMENTS: Blows per 6"
 C = Modified California Sampler
 Kelly Bar Weights: 0 - 50', 2280 lbs.
 50- 75', 1200 lbs.

CLIENT: Pardee Homes					PROJECT: Skyline Ranch		W.O.: 8838
LOCATION: Santa Clarita					ELEVATION: 1845'±		DATE: 6/19/06
RIG TYPE: 24" Bucket					HAMMER WEIGHTS: Kelly Bar Weights		DROP: 12"
	N	U	B	M	DD	DESCRIPTION	ATTITUDES
0						Landslide Deposit: Dark grayish brown medium to coarse grained SAND with gravels, subangular to subrounded, clayey, moist, very dense, occasional rootlets.	
5						@7.5' - Grades to light orange brown medium to coarse grained SANDSTONE, increasing coarse gravels with depth, moist, dense, occasional rootlets.	
10	6/10	C		12.2	113.5	@10' - Light orange brown fine to coarse grained SANDSTONE with traces of sandy clay, subangular to subrounded fine to coarse gravels, occasional small cobbles, well graded, moist, very dense. @10.8' - Medium brown CLAY, stiff, occasional rootlets, downdip side approx. 1/4" to 1/2" thick, updip side approx. 12" thick.	@10.8' Contact N32E/32NW @12' Approx. BN30E/29NW
15						@11' - Grades to slightly friable medium to coarse grained SANDSTONE with coarse gravels, moist, dense. @13' - Severely weathered granite boulder in gravel cobble CONGLOMERATE with slightly friable light orange brown medium to coarse grained sandstone matrix, moist, dense, gravels and cobbles increase with depth.	@18' Contact N46E/16NW
20	6/12	C		5.9	119.7	@18' - Scoured contact to orange brown clayey SILTSTONE with gravels, grading to SILTSTONE with sand. @22' - Interbeds of gravel to cobble CONGLOMERATE with medium to coarse grained sandstone matrix and SILTSTONE, moist, dense.	
25						@26.3' - Highly scoured contact to fine to coarse grained silty SANDSTONE, occasional gravels, moist, slightly friable, massive.	@26.3' Contact N50E/50SE
30	8/12	C		8.9	122.3	@30' - Yellowish orange brown fine to medium grained SANDSTONE with subrounded to subangular fine to coarse gravel channels, moist, dense, moderately graded.	
35						@34' - Subangular to subrounded gravel cobble CONGLOMERATE, slightly friable fine to coarse grained sand matrix, very dense, moist.	@34' Approx. BN50W/29SW
40	10/13	C		11.4	120.9	@38' - Interbeds of gravel cobble CONGLOMERATE with medium to coarse grained sandstone matrix and fine grained silty sandstone (2 6" thick interbeds). @40' - Yellowish brown medium to coarse grained SANDSTONE with subangular to subrounded fine to coarse gravels, occasional cobbles, well graded, moist, dense.	@39' Approx. BN66W/19SW
45							

ADDITIONAL COMMENTS: Blows per 6"
 C = Modified California Sampler
 Kelly Bar Weights: 0 - 50', 2280 lbs.
 50- 75', 1200 lbs.

SUBSURFACE DATA

LOG OF BORING B54

CLIENT: Pardee Homes					PROJECT: Skyline Ranch		W.O.: 8838
LOCATION: Santa Clarita					ELEVATION: 1845'±		DATE: 6/19/06
RIG TYPE: 24" Bucket					HAMMER WEIGHTS: Kelly Bar Weights		DROP: 12"
	N	U	B	M	DD	DESCRIPTION	ATTITUDES
40						@42' - Scoured, irregular contact to fine grained sandy SILTSTONE, hard, moist.	
						@43' - Grades to fine to medium grained SANDSTONE with occasional gravels.	
45						@45' - Grades to fine grained SANDSTONE with occasional clay.	
						@49' - Interbedded fine grained sandy SILTSTONE and gravel cobble CONGLOMERATE, friable, moist.	@50' Approx. BN80E/12SE
50	10/18	C		7.0	124.2	@50' - Yellowish orange brown medium to coarse grained SANDSTONE with fine to coarse gravels, subangular to subrounded, well graded, dense, moist.	@53' B N87E/14SE
						@52' - Interbedded gravel cobble CONGLOMERATE and medium to coarse grained SANDSTONE. Conglomerate is wet.	
55			X			@56' - Sharp contact to CLAY, water seepage stops at top of contact, imbricated, sheared (not sheared at contact), low plasticity.	@56' Contact N84E/21SE
						@56.5' - Upper shear, highly plastic, mullion surface, very stiff, 1-2" thick.	@56.5' Shear N80E/6SE
60	10/20	C		10.9	103.3	@56.9' - Lower shear, no slicks, mullioned surface just below shear.	@56.9' Shear N69W/4SW
						@57' - Saugus Formation: Yellowish red brown silty fine grained SANDSTONE with occasional subangular to subrounded gravels, moist, dense.	@62' Approx. contact N70W/6SW
						@60.5' - Contact to approx. 3" thick SILTSTONE, scoured and irregular interbeds.	@64' Channel N40E/23SE
65						@62.3' - Discontinuous gravel bed.	
						@63' - Grades to gravel cobble CONGLOMERATE with medium to coarse grained sand matrix, hard, moist, channelized.	
70	13/20	C		9.6	114.9	Total Depth - 70' Seepage from 55-56' No caving Backfilled	
75							
80							
85							
ADDITIONAL COMMENTS:						Blows per 6" C = Modified California Sampler Kelly Bar Weights: 0 - 50', 2280 lbs. 50- 75', 1200 lbs.	

SUBSURFACE DATA

LOG OF BORING B55

CLIENT: Pardee Homes					PROJECT: Skyline Ranch			W.O.: 8838.002
LOCATION: Santa Clarita					ELEVATION: 2145±			DATE: 6/20/06
RIG TYPE: 24" Bucket					HAMMER WEIGHTS: Kelly Bar Weights			DROP: 12"
N	U	B	M	DD	DESCRIPTION			ATTITUDES
0					Colluvium: Brown clayey gravelly SAND, dry, hard.			
5					@1' - <u>Mint Canyon Formation</u> : Gravel cobble CONGLOMERATE with occasional boulders, fine to medium grained sandstone matrix, subangular to subrounded, moist, dense.			
10					@10' - Light olive brown gravel cobble CONGLOMERATE with occasional boulders, fine to medium grained sand matrix, moist, very dense.			@7' Approx. BN65W/21SW
15					@13' - Boulder (approximately 24" diameter) metavolcanic, granitic, schist, occasional volcanic clasts.			@7.5' Approx. Channel N65E/21SE
20	10/15	C	9.5	106.7	@15' - Light olive brown gravel cobble CONGLOMERATE with occasional boulders, fine to medium sand grained sand matrix, moist, hard.			@10' Approx. BN15W/22SW
25					@21' - Subangular to subrounded fine gravel cobble CONGLOMERATE, well graded, weakly cemented, olive gray fine to coarse grained sandstone matrix, hard, moist, crudely bedded.			@13' Approx. BN45W/21SW
30	10/20	C	4.7	---	@23' - Scoured contact to light olive brown fine to coarse grained SANDSTONE, weakly indurated, moist, massive.			@17' Approx. BN45W/21SW
35					@27' - Thin (1-2' thick) SILTSTONE interbedded (3" apart) with subangular to subrounded fine gravel cobble CONGLOMERATE, olive gray fine to coarse grained sandstone matrix.			@26.5' B N38W/22SW
40	10/25	C	4.9	127.4	@29' - Seepage in NW quadrant, then wet all around with depth.			@29' B N8W/22SW
45					@30' - Fine gravel cobble CONGLOMERATE with light olive brown fine to coarse grained sandstone matrix, weakly to moderately cemented, well graded, hard, moist, crudely bedded, occasional boulders.			
					@35' - Subangular to subrounded coarse gravel cobble CONGLOMERATE with medium to coarse grained sandy clay matrix, wet, hard.			@36' Channel N80E/25NW
					@38' - Fine gravel cobble CONGLOMERATE with light olive brown fine to coarse grained sandstone matrix, weakly to moderately cemented, well graded, hard, moist, crudely bedded.			
					@40' - Approximately 12" thick conglomeratic fine to medium grained SANDSTONE, scoured contact.			
ADDITIONAL COMMENTS:					Blows per 6" C = Modified California Sampler Kelly Bar Weights: 0 - 50', 2280 lbs. 50- 75', 1200 lbs.			

CLIENT: Pardee Homes					PROJECT: Skyline Ranch		W.O.: 8838.002
LOCATION: Santa Clarita					ELEVATION: 2145'±		DATE: 6/20/06
RIG TYPE: 24" Bucket					HAMMER WEIGHTS: Kelly Bar Weights		DROP: 12"
	N	U	B	M	DD	DESCRIPTION	ATTITUDES
40						@41' - Boulder clasts, moderately cemented.	
45						@46' - Fine to medium grained SANDSTONE bed, scoured contact (approximately 6" thick), very hard, moist, massive.	@45' Approx. BN5W/23SW
			X				@47' B N29W/24SW
50						@50' - Gravel cobble CONGLOMERATE with occasional boulders with olive brown fine to coarse grained sandy clay matrix, moist, hard.	@49' Approx. BN34W/28SW
							@51' Approx. BN34W/28SW
55							
60	30/B	C		13.8	116.2	@60' - Subangular to subrounded gravel cobble CONGLOMERATE, weakly cemented olive brown sandy clay matrix, hard, moist.	
			X				
65						@64' - Subangular to subrounded gravel cobble CONGLOMERATE with moderately cemented olive gray fine to medium grained sandstone matrix, well graded, very hard, moist.	
70						Refusal at 65' Seepage at 29-30' No caving Backfilled	
75							
80							
85							
ADDITIONAL COMMENTS:						Blows per 6" C = Modified California Sampler Kelly Bar Weights: 0 - 50', 2280 lbs. 50- 75', 1200 lbs.	

CLIENT: Pardee Homes					PROJECT: Skyline Ranch		W.O.: 8838.002
LOCATION: Santa Clarita					ELEVATION: 2066'±		DATE: 6/26/06
RIG TYPE: 24" Bucket					HAMMER WEIGHTS: Kelly Bar Weights		DROP: 12"
N	U	B	M	DD	DESCRIPTION	ATTITUDES	
0		X			Colluvium: Brown fine to coarse grained SAND with clay and subangular to subrounded fine gravel, moist, hard, rootlets.		
5					<u>Saugus Formation</u> : Yellowish brown conglomeratic medium to coarse grained SANDSTONE with fine to coarse gravel, occasional fine boulder, well graded, moist, very dense, crudely bedded.	@8' Approx. BN30W/20SW	
10	8/12	C	3.6	122.7	@10' - Yellowish brown conglomeratic medium to coarse grained SANDSTONE with fine to coarse gravel, occasional fine boulder, well graded, moist, very dense, crudely bedded.	@10' Approx. BN85W/22SW	
15					@15' - (6-12" thick) SILTSTONE interbed, irregular, scoured by conglomeratic SANDSTONE, irregular lower contact.	@15' Approx. contact N10W/45-60SW	
20	10/14	C	8.0	126.0	@18' - Fine gravel CONGLOMERATE, coarsening upwards. @20' - Yellowish brown medium to coarse grained SANDSTONE with silt, fine to coarse gravel, occasional cobble, subangular to subrounded granitic clasts, moist, hard.	@17' Approx. BN15W/26SW	
25					@21' - Discontinuous medium brown CLAY, pervasively sheared. @22.5' - Highly irregular contact to CLAY, grades to sandy CLAY, pervasively sheared (approximately 1" thick). @23.5' - Downdip side of contact, pervasively sheared CLAY, grades to sandy CLAY, moist, hard, massive.	@20.5' Approx. BN8E/28NW	
30	5/8	C			@24.5' - Approximately 1/8" thick CLAY shear (no slicks), plastic, stiff, grades to blocky clayey SILTSTONE to clayey fine grained SANDSTONE, hard, moist.	@22.5' Approx. shear N20E/23NW	
35					@26.5' - Interbeds of highly scoured coarse grained SANDSTONE with gravel, clayey fine grained SANDSTONE with occasional gravels, fine and coarsening sequences. @29' - Yellow brown fine to coarse grained SANDSTONE with gravel, grades to clayey fine to coarse grained SANDSTONE.	@24.5' Approx. shear N60W/5SW	
40	10/13	C	9.9	125.4	@33' - Silty fine grained SANDSTONE, grading to yellow brown silty fine to medium grained SANDSTONE, moist, hard. @36' - Sharp contact to brown medium to coarse grained SANDSTONE with some gravels at contact, moist, hard.	@36' Approx. contact N60E/35SE	
45					@37' - Gravel channels in medium to coarse grained SANDSTONE, slightly friable, moist, hard. @37.5' - Sharp contact to clayey SILTSTONE to scoured, irregular, rough horizontal contact with 1" thick CLAYSTONE within irregular gravel lens, discontinuous.	@37' Approx. channel N55E/58SE	
ADDITIONAL COMMENTS:					Blows per 6" C = Modified California Sampler Kelly Bar Weights: 0 - 50', 2280 lbs. 50- 75', 1200 lbs.		

CLIENT: Pardee Homes					PROJECT: Skyline Ranch		W.O.: 8838.002
LOCATION: Santa Clarita					ELEVATION: 2066'±		DATE: 6/26/06
RIG TYPE: 24" Bucket					HAMMER WEIGHTS: Kelly Bar Weights		DROP: 12"
N	U	B	M	DD	DESCRIPTION	ATTITUDES	
40							
					@42' - Dark yellow brown clayey fine grained SANDSTONE, occasional fine gravel, moist, hard.	@43.5' Approx. contact	
45					@43.5' - Sharp contact to brown clayey fine grained SANDSTONE, moist, hard.	N45W/12SW	
					@45' - Pervasively sheared CLAYSTONE, sheared zone (approximately 12" thick) grades to clayey fine grained SANDSTONE with pervasive shearing.		
50	12/18	C		10.0	126.0	@48' - Fine to medium grained SANDSTONE with fine gravels, moist, massive.	
					@50' - Medium brown fine to coarse grained clayey SANDSTONE with occasional fine gravels, moist, hard.		
					@53' - Increase in subangular coarse gravel clasts in medium brown medium to coarse grained SANDSTONE, moist, subangular clasts.		
55							
					@56' - Sharp contact, brown clayey fine grained SANDSTONE, moist.	@56' Approx. BN55W/10SW	
60	15/20	C		12.1	119.6	@60' - Medium brown clayey fine to coarse grained SANDSTONE with subangular fine gravel, moist, hard.	
						@56.5' Approx. contact N20W/10SW	
65							
					@67' - Strong brown medium to coarse grained clayey SANDSTONE, fine gravels, moist, hard.		
70	15/15	C		10.6	120.0	@70' - Gray light brown fine to coarse grained silty SANDSTONE with clay, fine gravels, subangular clasts, well graded, moist, hard.	
						@72' - Coarse cobble and gravel clasts in medium to coarse grained SANDSTONE, moist, hard, well graded.	
75							
					Total Depth - 72'		
					No groundwater		
					No caving		
					Backfilled		
80							
85							

ADDITIONAL COMMENTS: Blows per 6"
 C = Modified California Sampler
 Kelly Bar Weights: 0 - 50', 2280 lbs.
 50- 75', 1200 lbs.

SUBSURFACE DATA

LOG OF BORING B57

CLIENT: Pardee Homes					PROJECT: Skyline Ranch		W.O.: 8838.002
LOCATION: Santa Clarita					ELEVATION: 2105'		DATE: 6/27/06
RIG TYPE: 24" Bucket					HAMMER WEIGHTS: Kelly Bar Weights		DROP: 12"
N	U	B	M	DD	DESCRIPTION	ATTITUDES	
0					<u>Saugus Formation</u> : Fine to coarse grained SANDSTONE with silt and fine gravel, graded, very dense, brown, moist, weakly indurated, rootlets, veins of light yellowish brown fine gravelly silty fine grained SAND, dry, and patches of very dark brown clayey SANDSTONE to CLAYSTONE.		
5					@6'7" - Grades to 1'7" thick coarse grained gravel CONGLOMERATE with fine to coarse grained sandy matrix, slightly friable to friable with depth, reddish brown, roots, metamorphic (schist and gneiss) clasts.	@8'2" C N61E/42NW	
10	6/12	C	8.2	124.9	@8'2" - Sharp, irregular contact with fine grained SANDSTONE with fine gravel, clay, and silt, poorly graded, dense, brown to light brown, moist, rootlets. @8'7" - Grades to fine to medium grained SANDSTONE with clay, silt, and fine gravel, graded to well graded.	@11.5' C N61E/35NW	
15					@9'9" - Fine grained sandy silty CLAYSTONE, non-plastic, grades to fine grained gravelly silty clayey fine grained SANDSTONE, poorly graded to graded, dense, dark brown, moist, rootlets. @11.5' - Sharp contact with 6" thick coarse grained gravel CONGLOMERATE with silty fine to coarse grained sand matrix, well graded, dense, brown, moist, friable, no continuous thickness around hole, channeled.	@12' C N55E/34NW	
20	7/10	C	9.2	111.6	@12' - Sharp contact with fine grained sandy silty CLAYSTONE, graded, very stiff, dark brown, moist, plastic, grades to fine grained SANDSTONE at 14' and coarse grained gravel CONGLOMERATE at 15', slightly friable to friable. @15.5' - Clayey silty fine grained SANDSTONE, very dense, brown, grades to 2" thick coarse grained gravel CONGLOMERATE.	@22'5" Shear N46E/21NW	
25					@16.5' - Silty fine to coarse grained sand matrix, graded, slightly friable, lesser gravel than material above. @16'8" - Sharp contact with CLAYSTONE with sand and silt, poorly graded, very stiff, brown, moist, grades to silty fine to medium grained SANDSTONE.	@26.5' Shear N64E/13NW	
30	10/12	C	5.3	124.7	@17'7" - Grades to coarse grained gravel CONGLOMERATE. @19'3" - Slightly friable, small percentage of gravel. @20' - Sharp contact with CLAYSTONE. @22'5" - Sheared CLAYSTONE with upper and lower bounding shears, no slickensides, grades to coarse grained gravel CONGLOMERATE, slightly friable to friable.	@27' C N70E/36NW @30'8" C N73E/16NW	
35					@24'9" - Sharp, irregular, contact with CLAYSTONE, grading to fine grained SANDSTONE. @25'10" - CLAYSTONE, sharp contact with 12" thick coarse grained gravel CONGLOMERATE with friable fine to coarse sand matrix.		
40	9/11	C	17.0	110.7	@26.5' - 1mm thick sheared CLAY with well defined shear, no slickensides, highly plastic, moist. @28' - Contact between CONGLOMERATE above and CLAYSTONE, brown, grading to 2" thick coarse grained gravel CONGLOMERATE at 30'8", yellowish brown. @30'10" - Fine grained gravelly silty fine grained SANDSTONE, graded, light brown, moist, slightly friable.		
45							
ADDITIONAL COMMENTS:					Blows per 6" C = Modified California Sampler Kelly Bar Weights: 0 - 50', 2280 lbs. 50 - 75', 1200 lbs.		

SUBSURFACE DATA

LOG OF BORING B57

CLIENT: Pardee Homes						PROJECT: Skyline Ranch		W.O.: 8838.002
LOCATION: Santa Clarita						ELEVATION: 2105'		DATE: 6/27/06
RIG TYPE: 24" Bucket						HAMMER WEIGHTS: Kelly Bar Weights		DROP: 12"
	N	U	B	M	DD	DESCRIPTION		ATTITUDES
40						@34' - Coarse grained gravel CONGLOMERATE with fine to coarse sand matrix. @34'5" - Fine grained sandy SILTSTONE, yellowish brown, grading to fine grained sandy clayey SILTSTONE with trace gravel, brown. @37'2" - Silty CLAYSTONE streaks white, dry. @38'10" - SILTSTONE, grades to silty fine grained SANDSTONE, then to coarse grained gravel CONGLOMERATE beds, approximately 6" thick, with light brown silty fine grained SANDSTONE between 39' and 40'4". @40'9" - Sharp contact with CLAYSTONE, poorly graded, very stiff, brown, moist, waxy (suggesting shear), but no shear plane visible. @42' - Grades to silty fine to medium grained SANDSTONE with trace fine gravel, graded, hard, light brown, moist, friable to slightly friable. @44'3" - Grades to clayey fine grained sandy SILTSTONE, poorly graded, very stiff to hard, moist, brown. @46'9" - Grades to coarse grained gravel CONGLOMERATE, moist, friable, irregular contact with claystone below, contact dips roughly NNE. @48'3" - Silty CLAYSTONE, poorly graded, very stiff, dark brown, moist, highly plastic, roughly horizontal. @48'8" - Clayey SILTSTONE with fine sand, poorly graded, hard, light brown, moist. @53'4" - Grades to clayey silty fine grained SANDSTONE with trace gravel, graded, hard, dark brown, moist. @60' - Grades to fine grained gravel CONGLOMERATE with clayey fine to coarse grained sand matrix, well graded, hard, dark brown, moist.		
45								
50	10/14	C		20.8	106.5			
55								
60	15/20	C		16.8	113.7			
65						Total Depth - 60' No groundwater No caving Backfilled		
70								
75								
80								
85								
ADDITIONAL COMMENTS:						Blows per 6" C = Modified California Sampler Kelly Bar Weights: 0 - 50', 2280 lbs. 50- 75', 1200 lbs.		

CLIENT: Pardee Homes					PROJECT: Skyline Ranch		W.O.: 8838.002
LOCATION: Santa Clarita					ELEVATION: 1696'		DATE: 6/27/06
RIG TYPE: 24" Bucket					HAMMER WEIGHTS: Kelly Bar Weights		DROP: 12"
N	U	B	M	DD	DESCRIPTION	ATTITUDES	
0					Colluvium: Tan fine to coarse grained SAND with subangular cobbles and gravel, dry.		
5					@3' - <u>Saugus Formation</u> : Light brown silty fine to medium grained SANDSTONE with gravel, moist, dense, poorly graded, rootlets, occasional streaks of white fine grained dry material oriented subvertical and subhorizontal.	@3'3" B N17W/11SW	
10					@8' - Yellow fine grained SANDSTONE, 1" thick gray green fine subrounded gravel CONGLOMERATE with fine to medium grained sand matrix, weakly cemented, well graded, dense, moist. @10' - No sample recovered. @10'2" - Abrupt, irregular contact with gravel cobble CONGLOMERATE with slightly friable to friable fine to coarse grained sand matrix, well graded, dense to very dense, pale brown, moist to wet, subangular to subrounded metamorphic clasts.	@7' C N54W/7SW @10'2" C N67W/12SW	
15	6-10" C		11.7	116.0	@12' - Yellowish brown friable fine to coarse grained SANDSTONE with gravel to occasional cobbles, moist. @14'1" - Sharp irregular scoured contact with yellowish brown silty fine grained SANDSTONE, poorly graded to graded, very dense, moist. @15' - Olive fine grained SANDSTONE with silt, moist, hard. @16'7" - 4" thick fine to coarse grained subangular gravel CONGLOMERATE with pale brown slightly friable to friable fine to coarse grained sand matrix, well graded, hard, very moist. @20'11" - Silty fine grained SANDSTONE, poorly graded, hard, interbedded light brown, orange brown, and gray brown, moist, shallow, subhorizontal bedding, cross bedding, only exposed in SE wall, channel shaped.	@14'1" Approx. CN56E/15SE	
20					@21' - Tan fine to coarse grained SANDSTONE with subangular gravel to cobble clasts, moist. @24'5" - CONGLOMERATE, extremely friable. @27' - Pale olive friable medium grained SAND with occasional coarse gravel, moist, hard, @33' - Light brown subangular to subrounded gravel to cobble CONGLOMERATE, friable, fine to coarse grained sand matrix, moist.		
25	10-10" C		6.0	117.5	@36' - Brown SANDSTONE with subrounded to subangular gravel and cobbles, friable, moist. @37'4" - Matrix fining to clayey, fine to medium grained SANDSTONE, wet. @37'10" - Matrix resumes coarseness. @39'8" - Transition to fine gravelly fine to coarse grained SANDSTONE with occasional subrounded cobbles, graded, very dense, light brown, moist. @40' - Light yellowish brown fine to coarse grained SANDSTONE with occasional gravel.		
30							
35							
40	21-10" C		11.9	99.3			
45							
ADDITIONAL COMMENTS:					Blows per 12" C = Modified California Sampler Kelly Bar Weights: 0 - 30', 5619 lbs. 31 - 60', 3745 lbs. 61 - 90', 2280 lbs. 91 - 120', 1223 lbs.		

SUBSURFACE DATA

LOG OF BORING B58

CLIENT: Pardee Homes					PROJECT: Skyline Ranch		W.O.: 8838.002
LOCATION: Santa Clarita					ELEVATION: 1696'		DATE: 6/27/06
RIG TYPE: 24" Bucket					HAMMER WEIGHTS: Kelly Bar Weights		DROP: 12"
	N	U	B	M	DD	DESCRIPTION	ATTITUDES
40						@41'5" - Grades subrounded to subangular to fine gravel CONGLOMERATE to coarse gravel CONGLOMERATE with light brown fine to coarse grained sand matrix, well graded, hard, moist.	
45							
50	7-5"	C				@50' - No sample recovered, subangular gravel to cobble CONGLOMERATE, fine to coarse grained sand matrix, moist, possible minor seep at 50-52', coarsens to boulder CONGLOMERATE, matrix is wet, possibly from seep above.	
55							
60	15-5"	C		5.4	100.5	@59'3" - Clast decreasing in coarseness to cobbles (up to 6"), iron staining in matrix and clasts. @60' - Light brown subangular gravel CONGLOMERATE with friable fine to coarse grained sand matrix, moist.	
65							
70	22-12"	C		8.5	109.9	@70' - Dark yellowish brown subangular fine gravel CONGLOMERATE with fine to coarse grained sand matrix, moist, friable, poorly graded, hard. @71' - Light brownish gray subrounded coarse gravel CONGLOMERATE with fine to coarse grained sand matrix, well graded, hard, moist, metamorphic clasts.	
75	16-5"	C				@72' - Seeping. @74' - Greenish gray fine to medium grained SANDSTONE with trace fine gravel, graded, hard, moist. @74'11" - <u>Mint Canyon Formation</u> : Sharp, scoured, irregular contact with subrounded cobble CONGLOMERATE, gray brown fine to coarse grained sand matrix, weakly to moderately cemented, very moist, hard, well graded. @75' - Greenish gray silty fine grained SANDSTONE, poorly graded, hard, moist. @76'8" - Abrupt transition to subrounded cobble CONGLOMERATE with greenish gray fine to coarse sand matrix, very dense, moist, well graded.	@76'8" Approx. contact N35E/8SE
80							
85							
ADDITIONAL COMMENTS:						Blows per 12" C = Modified California Sampler Kelly Bar Weights: 0 - 30', 5619 lbs. 31 - 60', 3745 lbs. 61 - 90', 2280 lbs. 91 - 120', 1223 lbs.	

CLIENT: Pardee Homes					PROJECT: Skyline Ranch		W.O.: 8838.002
LOCATION: Santa Clarita					ELEVATION: 1696'		DATE: 6/27/06
RIG TYPE: 24" Bucket					HAMMER WEIGHTS: Kelly Bar Weights		DROP: 12"
N	U	B	M	DD	DESCRIPTION		ATTITUDES
80					@80' - Greenish gray subrounded cobble CONGLOMERATE with silty fine to coarse grained sand matrix, well graded, hard, moist, metamorphic clasts. @83' - Greenish brown subrounded cobble CONGLOMERATE with silty fine to coarse grained sand matrix, well graded, hard, moist, metamorphic clasts.		
85					@87'4" - Fine grained gravelly fine to coarse grained SANDSTONE, graded, hard, gray, moist to very moist.		@87'4" B
	30-10" C		14.0	104.3	@88' - Light brownish gray silty fine to medium grained SAND with trace subangular fine gravel, graded to well graded, hard, dense, moist, metamorphic clasts. @88'4" - Scoured contact between subrounded coarse gravel CONGLOMERATE, slightly friable, and silty fine grained SANDSTONE below, poorly graded to graded, hard, gray, moist. @89' - Gray very silty fine to medium grained SANDSTONE, poorly graded to graded, hard, moist. @92' - Grades to silty fine to coarse grained SAND over fine gravel CONGLOMERATE, over cobble CONGLOMERATE, friable, gray fine to coarse grained sand matrix, hard, wet.		N23W/8SW
90							
95							
100							
105	30-5" C		5.3	87.1	@103' - Brown to dark brown cobble CONGLOMERATE with subrounded gravelly fine to coarse grained sand matrix, well graded, hard, moist, metamorphic clasts. @105' - Gray subrounded to subangular coarse gravel to cobble CONGLOMERATE with friable fine to coarse grained sand matrix, well graded, hard, moist, metamorphic clasts, in SE wall weakly cemented fine to coarse grained SANDSTONE, graded, hard, gray, moist, truncated by CONGLOMERATE.		
110							
115					@115' - Cobbles coarsening to boulder size.		
120					Total Depth - 116' Minor seep at 50' Seep causing sand to run at 72' Backfilled		
125							
ADDITIONAL COMMENTS:					Blows per 12" C = Modified California Sampler Kelly Bar Weights: 0 - 30', 5619 lbs. 31 - 60', 3745 lbs. 61 - 90', 2280 lbs. 91 - 120', 1223 lbs.		

SUBSURFACE DATA

LOG OF BORING B59

CLIENT: Pardee Homes					PROJECT: Skyline Ranch		W.O.: 8838.002
LOCATION: Santa Clarita					ELEVATION: 1678'±		DATE: 6/30/06
RIG TYPE: 24" Bucket					HAMMER WEIGHTS: Kelly Bar Weights		DROP: 12"
	N	U	B	M	DD	DESCRIPTION	ATTITUDES
0						Saugus Formation: Brown coarse grained gravel to cobble CONGLOMERATE with fine to coarse grained sand matrix, well graded, dense, moist, clasts metamorphic and subrounded to subangular, metamorphic clasts, slightly friable, rootlets.	@3.5' C N80W/9NE
5						@2' - Pale brown coarse grained gravel CONGLOMERATE with fine to coarse grained sand matrix, well graded, dense, moist, subrounded metamorphic clasts. @5' - Mottled light yellowish brown, pale brown, and gray green silty fine grained SAND, poorly graded, medium dense, moist, with trace iron staining, to fine grained gravelly silty fine to medium grained SAND,	
10	8	C		12.1	118.0	poorly graded, dense, moist. @7'4" - Grades to very silty fine grained SANDSTONE, poorly graded, very dense, brown, moist. @9' - Dark brown fine to coarse grained sandy clayey SILT, poorly graded, very stiff, moist, bedded with gray green beds from above.	@10'3" B N64W/8SW
15						@10' - Light yellow brown fine grained gravel CONGLOMERATE with fine to medium grained sand matrix, graded to well graded, dense, moist, subrounded, over interbedded gray green silty fine to coarse grained SAND, graded, dense, moist, and dark brown silty fine to coarse grained SAND, graded, dense, moist.	@14.6" B N41W/12SW
20	10-8"	C		4.0	117.6	@17' - Gray green interbeds, color change to olive and very moist. @18'10" - Subrounded to subangular cobble CONGLOMERATE, well graded, slightly friable, olive silty fine to coarse grained sand matrix, very dense, moist. @20' - Yellowish brown fine grained gravel CONGLOMERATE with fine to coarse grained sand matrix, well graded, hard, moist, subrounded metamorphic clasts.	@18'10" B N86W/11SW
25						@21' - Coarsens to cobble CONGLOMERATE. @21.5' - Yellow brown fine to coarse grained SANDSTONE, graded, hard, friable, irregular thickness.	
30	15-10"	C		4.6	116.6	@22.5' - Subangular coarse grained gravel CONGLOMERATE, friable. @23' - Yellow brown fine to coarse grained SANDSTONE, graded, hard, moist, friable, irregular thickness. @23.5' - Yellow brown fine to coarse grained gravel CONGLOMERATE with friable fine to coarse grained sand matrix, well graded, hard, moist, subangular metamorphic clasts, occasional cobbles.	@29'4" C N51E/12SE
35						@29'4" - Yellow brown fine to coarse grained SANDSTONE, graded, hard, moist, friable, contact with above is irregular and scoured. @32' - Yellowish brown fine grained gravel CONGLOMERATE with fine to coarse grained sand matrix, well graded, hard, moist, subangular metamorphic clasts.	
40	14-6"	C		6.3	103.0	@33' - Dark yellowish brown coarse grained gravel CONGLOMERATE with fine to coarse grained sand matrix, well graded, very dense, moist, subrounded metamorphic clasts, also boulder sized pocket of silty fine grained SANDSTONE, poorly graded, dense, brown to yellowish brown, moist, weakly indurated, only in N wall (ripup clast?).	
45							
ADDITIONAL COMMENTS:						Blows per 12" C = Modified California Sampler Kelly Bar Weights: 0 - 30', 5619 lbs. 31 - 60', 3745 lbs. 61 - 90', 2280 lbs. 91 - 120', 1223 lbs.	

CLIENT: Pardee Homes					PROJECT: Skyline Ranch		W.O.: 8838.002
LOCATION: Santa Clarita					ELEVATION: 1678±		DATE: 6/30/06
RIG TYPE: 24" Bucket					HAMMER WEIGHTS: Kelly Bar Weights		DROP: 12"
N	U	B	M	DD	DESCRIPTION	ATTITUDES	
40					@34'5" - Grades to fine grained gravelly fine to coarse grained SANDSTONE, graded, slightly friable.		
					@35'2" - Dark yellowish brown fine to coarse grained gravel CONGLOMERATE with fine to coarse grained sand matrix and occasional cobbles, subrounded metamorphic clasts.		
45					@40' - Yellowish brown to dark yellowish brown coarse grained gravel CONGLOMERATE with fine to coarse sand matrix, well graded, very dense, moist, subrounded metamorphic clasts, also discontinuous lens of brown CLAYSTONE, very stiff, wet, waxy, non-slightly plastic, boulder sized and only in SW wall.		
					@44' - Several cobbles approach boulder size.		
					@46' - Grades to pale brown fine to coarse grained SANDSTONE with coarse gravel, graded, hard, moist, slightly friable, subangular metamorphic clasts.		
					@47'3" - Pale brown fine to coarse grained gravel to cobble CONGLOMERATE, well graded, hard, moist, subangular metamorphic clasts.		
55	20-6" C		8.2	113.5	@49' - Yellowish brown to dark yellowish brown cobble CONGLOMERATE with fine to coarse sand matrix, well graded, very dense, moist, subangular to subrounded metamorphic clasts, also boulder sized ripup clast of clayey SILTSTONE in SE wall, poorly graded, very stiff, dark brown, moist, slightly plastic.	@56'4" C N89W/15NE @57'5" B N20E/16NW	
					@55' - Occasional boulder sized clasts in CONGLOMERATE.		
					@56'4" - Sharp, erosional contact with pale brown fine to coarse grained SANDSTONE, poorly graded to graded, hard, moist, thinly bedded.		
					@57'8" - Sharp, irregular, erosional contact with coarse grained gravel to cobble CONGLOMERATE, well graded, pale brown, weakly cemented to cemented fine to coarse grained sand matrix, hard, moist, subangular metamorphic clasts.		
70					@61'7" - Pocket of gravelly fine to coarse grained SANDSTONE, graded, hard, moist, pale brown, slightly friable, only in E wall.		
					@70' - Boulder sized clast.		
					@71'5" - Orange CLAY rind around clasts, soft, moist to wet, highly plastic, approximately 1/2mm thick but same matrix from 57'8" exists, mostly clast supported, very little matrix.		
85							
ADDITIONAL COMMENTS:					Blows per 12" C = Modified California Sampler Kelly Bar Weights: 0 - 30', 5619 lbs. 31 - 60', 3745 lbs. 61 - 90', 2280 lbs. 91 - 120', 1223 lbs.		

CLIENT: Pardee Homes					PROJECT: Skyline Ranch		W.O.: 8838.002
LOCATION: Santa Clarita					ELEVATION: 1678±		DATE: 6/30/06
RIG TYPE: 24" Bucket					HAMMER WEIGHTS: Kelly Bar Weights		DROP: 12"
	N	U	B	M	DD	DESCRIPTION	ATTITUDES
80	21-8"	C		7.4	---	Light yellowish brown coarse grained gravel CONGLOMERATE with silty fine to coarse grained sand matrix, well graded, very dense, moist, subrounded metamorphic clasts.	
85							
90							
95						Total Depth - 92' No groundwater No caving Backfilled	
100							
105							
110							
115							
120							
125							
ADDITIONAL COMMENTS:					Blows per 12" C = Modified California Sampler Kelly Bar Weights: 0 - 30', 5619 lbs. 31 - 60', 3745 lbs. 61 - 90', 2280 lbs. 91 - 120', 1223 lbs.		

CLIENT: Pardee Homes					PROJECT: Skyline Ranch		W.O.: 8838.002
LOCATION: Santa Clarita					ELEVATION: 1664'		DATE: 7/7/06
RIG TYPE: 24" Bucket					HAMMER WEIGHTS: Kelly Bar Weights		DROP: 12"
	N	U	B	M	DD	DESCRIPTION	ATTITUDES
0						Saugus Formation:	
						@3' - Mottled gray green, rusty orange, brown fine to coarse grained gravelly fine to coarse grained SANDSTONE, graded, weakly indurated, very dense, moist, massive, subangular metamorphic clasts, rootlets to 5'.	
5						@5'4" - Grades to fine grained gravel CONGLOMERATE with weakly cemented to slightly friable fine to coarse sand matrix, graded to well graded, very dense, moist.	@6'11" B N48W/85SW
						@5.5' - Dark brown CLAYSTONE, highly plastic, moist.	
10	10	C		14.0	115.2	@6'7" - Grades to fine grained gravel CONGLOMERATE with weakly cemented fine to coarse grained sand matrix, graded to well graded, very dense, moist.	@9'4" B N7W/7SW
						@9'4" - Grades to yellow brown fine to coarse grained gravel CONGLOMERATE, subangular metamorphic clasts, friable in west wall.	@12' B N32W/8SW
						@10' - Brown silty fine to medium grained SANDSTONE, poorly graded, weakly indurated, very dense, moist, subangular metamorphic fine gravels.	
15						@12' - Grades to light yellowish brown fine grained gravel CONGLOMERATE with friable fine to coarse sand matrix, well graded, hard, moist, subangular metamorphic clasts.	@16' B N22W/7SW
						@12'5" - Grades to yellowish brown silty fine grained SANDSTONE, poorly graded graded, weakly indurated, hard, moist, massive.	
20						@13'8" - Grades to pale brown fine to coarse grained SANDSTONE, slightly friable, massive.	@20'3" B N66W/8SW
						@15' - Grades to pale brown fine grained gravel CONGLOMERATE, well graded, friable, hard, moist, subangular metamorphic clasts.	
						@15.5' - Grades to yellowish brown silty fine grained SANDSTONE, poorly graded to graded, weakly indurated, hard, moist.	
25						@16' - Grades to cobble CONGLOMERATE with friable light yellowish brown fine to coarse sand matrix, well graded, hard, moist, subrounded metamorphic clasts.	@26'8" B N9W/8SW
						@18'4" - Grades to yellowish brown silty fine grained SANDSTONE, poorly graded to graded, weakly indurated, hard, moist.	
30						@20'3" - Grades to coarse grained gravel CONGLOMERATE with friable yellow brown fine to coarse sand matrix, well graded, hard, moist, subrounded metamorphic clasts.	
						@22'4" - Grades to yellowish brown silty fine to coarse grained SANDSTONE, graded, weakly indurated to slightly friable, hard, moist.	
35						@23'4" - Grades to yellowish brown fine grained gravel CONGLOMERATE with friable fine to coarse sand matrix, well graded, hard, moist, subrounded metamorphic clasts.	
						@26'8" - Coarsens to coarse grained gravel CONGLOMERATE.	@38'9" B N17W/20SW
40						@26'10" - Grades to yellowish brown fine to coarse grained SANDSTONE, graded, friable, hard, moist.	
						@28'2" - Grades to subrounded fine to coarse grained gravel to cobble CONGLOMERATE, friable.	
						@30' - Yellow brown coarse grained gravel to cobble CONGLOMERATE with fine to coarse sand matrix, well graded, hard, moist, subrounded metamorphic clasts.	
45							
ADDITIONAL COMMENTS:						Blows per 12" C = Modified California Sampler Kelly Bar Weights: 0 - 50', 2280 lbs. 50- 75', 1200 lbs.	

CLIENT: Pardee Homes					PROJECT: Skyline Ranch			W.O.: 8838.002
LOCATION: Santa Clarita					ELEVATION: 1664'			DATE: 7/7/06
RIG TYPE: 24" Bucket					HAMMER WEIGHTS: Kelly Bar Weights			DROP: 12"
N	U	B	M	DD	DESCRIPTION			ATTITUDES
40					@35' - Brown coarse grained gravel to cobble CONGLOMERATE with fine to coarse sand matrix, well graded, hard, moist, subangular metamorphic clasts. @37'9" - Sharp, irregular, scoured contact with yellowish brown fine to coarse grained SANDSTONE, graded, friable, hard, moist. @38'9" - Grades to coarse grained subangular gravel CONGLOMERATE, friable. @38'11" - Sharp, irregular, scoured contact with yellowish brown fine to coarse grained SANDSTONE, graded, hard, moist, friable. @40' - Grades to cobble CONGLOMERATE with friable yellowish brown fine to coarse sand matrix, graded, hard, moist, subangular metamorphic clasts. @41' - Pale yellowish brown fine grained subangular gravelly fine to coarse grained SANDSTONE, graded, hard, moist. @42' - Fines to fine to coarse grained gravel CONGLOMERATE. @45' - Yellow brown coarse grained gravel to cobble CONGLOMERATE with fine to coarse sand matrix, well graded, hard, moist, clasts subangular to subrounded metamorphics.			@52' B N63W/12SW
45					@45.5' - Matrix color grades to very pale brown, approx. 50% of conglomerate is matrix material, most clasts subangular fine gravel, occasional cobbles, hard, moist, friable to slightly friable. @47' - Moisture increases to very moist, subangular cobble clasts. @53' - Grades to brown coarse grained gravel to cobble CONGLOMERATE with fine to coarse sand matrix, well graded, hard, very moist, clasts subangular to subrounded metamorphics.			
50					@55'2" - Matrix color grades to very pale brown, approx. 50% of conglomerate is matrix material, most clasts subangular fine gravel size, occasional cobbles, hard, moist, friable to slightly friable, massive. @59' - Orange highly plastic CLAYSTONE, appears in matrix surrounding clasts. @61' - Brownish yellow fine grained gravelly slightly plastic clayey fine to medium grained SANDSTONE, poorly graded, very dense, moist, gravels subrounded to subangular metamorphics, overlying mottled brownish yellow and gray silty fine grained SANDSTONE, poorly graded to graded, dense, moist.			@62'1" C N2E/11NW @64'11" C N2E/14NW @65'8" B N11W/16SW
55					@62'1" - Sharp, irregular contact along a 1mm thick highly plastic CLAYSTONE bed, soft, moist, light brown to brown, overlying dark yellowish brown silty fine grained SANDSTONE, poorly graded, weakly indurated, hard, moist, thinly bedded. @63' - Light gray silty fine grained SANDSTONE, poorly graded, weakly to moderately indurated, hard, moist. @64'11" - Contact between dark yellowish brown and gray silty fine grained SANDSTONE. @65'3" - Grades back to dark yellowish brown. @67.5' - Contact with gray silty fine grained SANDSTONE. @68' - Color change to mottled gray and dark yellowish brown. @69' - Mottled gray and yellowish brown to dark yellowish brown silty fine grained SANDSTONE, poorly graded, hard, moist.			@71' B N34W/4SW
60	22-10" C		16.1	113.2	@69' - Mottled gray and yellowish brown to dark yellowish brown silty fine grained SANDSTONE, poorly graded, hard, moist. Total Depth - 76', Seep from 56-58', No caving, Backfilled			
65								
70								
75								
80								
85								
ADDITIONAL COMMENTS:					Blows per 12" C = Modified California Sampler Kelly Bar Weights: 0 - 50', 2280 lbs. 50- 75', 1200 lbs.			

CLIENT: Pardee Homes					PROJECT: Skyline Ranch			W.O.: 8838.002
LOCATION: Santa Clarita					ELEVATION: 1684'			DATE: 7/11/06
RIG TYPE: 24" Bucket					HAMMER WEIGHTS: Kelly Bar Weights			DROP: 12"
N	U	B	M	DD	DESCRIPTION			ATTITUDES
0					<p><u>Saugus Formation</u>: Very pale brown silty fine to coarse grained gravelly fine to coarse grained SANDSTONE, graded, hard, dry, gravel clasts are subangular, @2' - 4" thick fine grained gravel CONGLOMERATE with slightly friable silty fine to coarse sand matrix, well graded, hard, moist, rootlets, clasts are subangular and metamorphic.</p>			@2' B N52W/14SW
5					<p>@2'4" - Mottled yellowish brown and gray green fine grained gravelly silty fine to coarse grained SANDSTONE, graded, hard, moist, gravels are subangular, end of rootlets, massive.</p> <p>@3'3" - Absence of gray green color.</p> <p>@5' - Dark yellowish brown and mottled olive gray clayey silty fine to medium</p>			@6' B N48W/6SW
10	7 C		12.7	121.7	<p>grained SANDSTONE, graded, hard, moist.</p> <p>@6' - Grades to yellowish brown fine to coarse grained gravel CONGLOMERATE with friable fine to coarse sand matrix, well graded, hard, moist, clasts are subrounded and metamorphic.</p> <p>@9' - Sharp, scoured contact with 12" thick section of interbedded yellowish brown and gray green fine grained sandy SILTSTONE, poorly graded, hard, moist, interbeds approximately 1.5" thick.</p> <p>@10' - Yellowish brown thinly bedded SILTSTONE.</p> <p>@11'10" - Grades to reddish brown clayey silty fine to coarse grained SANDSTONE with fine gravel, graded, hard, moist.</p>			@11'10" B N25W/5NW
15					<p>@12'5" - Grades to coarse grained gravel to cobble CONGLOMERATE with friable yellow brown fine to coarse sand matrix, well graded, hard, moist, clasts are subrounded and metamorphic.</p> <p>@13'5" - Matrix color changes to pale brown.</p> <p>@14.5' - Matrix occasionally turns reddish brown for 2", then back to pale brown.</p> <p>@17'10" - Sharp, irregular scoured contact with dark yellowish brown fine grained gravelly silty fine to medium grained SANDSTONE, graded, weakly indurated, hard, moist, massive.</p>			
20	11-10" C		8.6	115.2	<p>@20' - Grades to yellowish brown coarse grained gravel to cobble CONGLOMERATE with slightly friable fine to coarse sand matrix, well graded, hard, moist, occasional cobbles, clasts are subrounded and metamorphic.</p> <p>@22' - Scoured contact with dark yellowish brown silty fine to coarse grained SANDSTONE, graded, hard, moist, thickly bedded.</p> <p>@23'7" - Grades to yellowish brown fine to coarse grained gravel CONGLOMERATE.</p> <p>@23'11" - Yellow brown silty fine grained gravelly fine to coarse grained SANDSTONE, slightly friable, graded, hard, moist, massive.</p>			@20' B N37W/6SW
25					<p>@25'1" - Grades to yellow brown coarse grained gravel to cobble CONGLOMERATE, friable to slightly friable, well graded, hard, moist, clasts are subrounded and metamorphic.</p> <p>@30' - Grades to yellowish brown coarse grained gravel to cobble CONGLOMERATE with fine to coarse sand matrix, well graded, slightly friable to friable, hard, moist, occasional cobbles, clasts are subrounded and metamorphic.</p> <p>@31' - 1" thick discontinuous brown clayey silty SAND, poorly graded, stiff, moist, 90° around hole in SE quadrant.</p> <p>@31'5" - Occasional boulders begin appearing in conglomerate for remainder of boring.</p> <p>@35' - Matrix coarsens and becomes friable.</p>			@35' B N52W/7SW
30	19-8" C		8.7	120.9				
35								
40								
45								
ADDITIONAL COMMENTS:					<p>Blows per 12" C = Modified California Sampler Kelly Bar Weights: 0 - 30', 5619 lbs, 31 - 60', 3745 lbs, 61 - 90', 2280 lbs.</p>			

CLIENT: Pardee Homes					PROJECT: Skyline Ranch			W.O.: 8838.002	
LOCATION: Santa Clarita					ELEVATION: 1684'			DATE: 7/11/06	
RIG TYPE: 24" Bucket					HAMMER WEIGHTS: Kelly Bar Weights			DROP: 12"	
N	U	B	M	DD	DESCRIPTION			ATTITUDES	
40					@42' - Grades to fine grained gravel CONGLOMERATE. @44' - Grades to coarse grained gravel to cobble CONGLOMERATE. @44'5" - Boulder sized pocket of brown silty fine grained SANDSTONE, poorly graded, dense, moist, thinly bedded, occurs in south wall. @47' - Yellowish brown fine grained gravelly fine to coarse grained SANDSTONE, graded, slightly friable, hard, moist, massive. @49' - Very pale brown fine grained gravelly fine to coarse grained SANDSTONE, friable, graded, hard, very moist. @51' - Grades to yellowish brown fine grained gravel CONGLOMERATE with slightly friable fine to coarse sand matrix, well graded, hard, moist, subangular metamorphic clasts.				
45					@55' - Grades to cobble CONGLOMERATE. @56'5" - Grades to subrounded fine grained gravel CONGLOMERATE.				
50					@60' - Yellowish brown fine to coarse grained gravel CONGLOMERATE with fine to coarse sand matrix, well graded, hard, moist, subangular metamorphic clasts, orange highly plastic clay in matrix around clasts. @60.5' - Matrix color changes to very dark brownish black. @64' - Matrix color changes back to pale yellowish brown.				
55									
60	22-10" C		8.5	99.3	@70' - Yellow brown subangular fine to coarse grained gravel CONGLOMERATE with fine to coarse sand matrix, well graded, hard, moist. @75' - Yellow brown subangular fine to coarse grained gravel CONGLOMERATE with fine to coarse sand matrix, well graded, hard, moist. @80' - Yellow brown subangular fine to coarse grained gravel CONGLOMERATE with fine to coarse sand matrix, well graded, hard, moist.			@77' B N20W/12NW	
65									
70									
75									
80									
85					Total Depth - 80' No groundwater, No caving Backfilled				
ADDITIONAL COMMENTS:					Blows per 12" C = Modified California Sampler Kelly Bar Weights: 0 - 30', 5619 lbs. 31 - 60', 3745 lbs. 61 - 90', 2280 lbs.				

CLIENT: Pardee Homes					PROJECT: Skyline Ranch			W.O.: 8838.002
LOCATION: Santa Clarita					ELEVATION: 1998'			DATE: 7/12/06
RIG TYPE: 24" Bucket					HAMMER WEIGHTS: Kelly Bar Weights			DROP: 12"
	N	U	B	M	DD	DESCRIPTION		ATTITUDES
0						<p>Saugus Formation: Brown fine grained gravelly fine to coarse grained SANDSTONE, graded, slightly friable, dense, moist.</p>		
						<p>@3' - Color change to yellow brown fine to coarse grained gravel to cobble CONGLOMERATE with fine to coarse sand matrix, well graded, hard, moist, clasts are subrounded and metamorphic.</p>		@3' B N58E/24NW
5						<p>@5' - Reddish yellow silty fine to medium grained sandy SILTSTONE, weakly indurated, poorly graded, very stiff, moist.</p>		
						<p>@9'9" - Grades to channelled gravels, 2" thick, rootlets.</p>		@9'9" B N69E/14NW
10	7	C		12.6	118.3	<p>@10' - Dark yellowish brown clayey silty fine to medium grained SANDSTONE, weakly indurated, hard, moist, occasional white streaks.</p>		@11.5' B N79E/26NW
						<p>@11.5' - Grades to fine to coarse grained gravel CONGLOMERATE with slightly friable coarse sand matrix, well graded, hard, moist, clasts are subrounded and metamorphic.</p>		
15						<p>@13' - Yellowish brown fine grained gravelly fine to coarse grained SANDSTONE with occasional coarse gravel, graded, slightly friable, hard, moist, massive, occasional gravel beds.</p>		@16' B N49E/23NW
						<p>@16' - Coarse gravel bed.</p>		
20	4	C		10.4	116.7	<p>@20' - Grades to fine grained gravel CONGLOMERATE with pale brown fine to coarse sand matrix, well graded, hard, moist.</p>		@21'3" C N31E/27NW
						<p>@21'3" - Sharp, scoured contact along bedding, yellow brown clayey silty fine grained SANDSTONE, poorly graded, hard, moist, slightly plastic.</p>		@21'9" B N38E/22NW
						<p>@21'9" - 1/4" thick clay bed.</p>		
25						<p>@23' - Yellowish brown clayey fine to coarse grained SANDSTONE, occasional coarse gravel, graded, hard, moist.</p>		
						<p>@24'4" - 6" thick discontinuous yellow brown clayey silty fine grained SANDSTONE, poorly graded, slightly plastic, hard, moist.</p>		
30	9	C		12.2	114.9	<p>@25' - Grades to coarse grained gravel to cobble CONGLOMERATE, slightly friable.</p>		@31'7" B N65E/31NW
						<p>@30' - Light yellowish brown coarse grained gravel to cobble CONGLOMERATE with fine to coarse sand matrix, well graded, hard, moist.</p>		
						<p>@31'7" - Yellowish brown fine to coarse grained SANDSTONE, graded, slightly friable, hard, moist, poorly bedded.</p>		
35						<p>@34'4" - Grades to subrounded fine grained gravel to cobble CONGLOMERATE, slightly friable.</p>		
						<p>@39' - Yellowish brown coarse grained gravel to cobble CONGLOMERATE with fine to coarse sand matrix, well graded, hard, very moist, clasts are subrounded and metamorphic.</p>		@41'10" B N29E/24NW
40	15	C		13.9	119.9	<p>@40' - Matrix becomes slightly plastic clayey fine grained SAND.</p>		
45								

ADDITIONAL COMMENTS: Blows per 12"
 C = Modified California Sampler
 Kelly Bar Weights: 0 - 30', 5619 lbs.
 31 - 60', 3745 lbs.
 61 - 90', 2280 lbs.

CLIENT: Pardee Homes					PROJECT: Skyline Ranch			W.O.: 8838.002
LOCATION: Santa Clarita					ELEVATION: 1998'			DATE: 7/12/06
RIG TYPE: 24" Bucket					HAMMER WEIGHTS: Kelly Bar Weights			DROP: 12"
	N	U	B	M	DD	DESCRIPTION		ATTITUDES
40								
						@43' - Moisture increases to wet.		
						@44' - Seep within cobble CONGLOMERATE.		
45								
						@47' Sharp, irregular, nonsheared contact with brown CLAYSTONE, very stiff, wet, pervasively sheared, corn flaky texture.		@47' C
	13		C	12.1	119.8	@47.5' - 6" thick conglomeratic SANDSTONE interbed truncated by shear below.		N49E/26NW
50						@48' - Brown CLAYSTONE, very stiff, wet, pervasively sheared, corn flaky texture, medium plastic.		@47'3" S
						@49' - Brown fine grained sandy clayey SILTSTONE, poorly graded, stiff, moist, with sheared, waxy slickensided clay bed, overlying yellow brown subangular fine grained gravel CONGLOMERATE with clayey fine to coarse grained sand matrix, well graded, hard, very moist to wet.		N49E/29NW
						@50' - Brown to dark brown fine to medium grained sandy silty CLAYSTONE, poorly graded, hard, moist.		@48' S
55						@51' - Shear in claystone with slickensides (34°, N54W), NW dipping shears are dominant as they truncate SW dipping shear at 48'.		N50W/43SW
	14		C	10.4	119.1	@54' - Highly plastic CLAYSTONE, brown to dark brown, moist, very stiff.		@51' S
						@57' - Brown to dark brown very clayey fine to medium grained SANDSTONE, graded, hard, moist, slightly to medium plastic.		N43E/37NW
						@59' - Dark yellowish brown clayey silty fine to medium grained SANDSTONE, graded, hard, moist.		
60						@60' - Yellowish brown fine grained gravel CONGLOMERATE with fine to coarse sand matrix, well graded, hard, wet, clasts are subrounded and metamorphic.		
						@63' - Dark yellowish brown clayey fine to medium grained SANDSTONE, graded, hard, moist, slightly plastic.		
65								
	21		C	12.1	125.0	@70' - Brown silty fine to medium grained SANDSTONE, graded, hard, moist.		
70								
						@75' - Yellowish brown fine grained gravelly fine to coarse grained SANDSTONE, graded, hard, moist.		
75								
	22-10"		C	14.5	117.7	@80' - Grades to yellowish brown subrounded to rounded fine grained gravel CONGLOMERATE with clayey fine to coarse grained sand matrix, well graded, hard, to contact with brown clayey silty fine to medium grained SANDSTONE, graded, hard, moist.		
80								
85								

ADDITIONAL COMMENTS:

Blows per 12"
 C = Modified California Sampler
 Kelly Bar Weights: 0 - 30', 5619 lbs.
 31 - 60', 3745 lbs.
 61 - 90', 2280 lbs.

CLIENT: Pardee Homes					PROJECT: Skyline Ranch		W.O.: 8838.002
LOCATION: Santa Clarita					ELEVATION: 1998'		DATE: 7/12/06
RIG TYPE: 24" Bucket					HAMMER WEIGHTS: Kelly Bar Weights		DROP: 12"
N	U	B	M	DD	DESCRIPTION		ATTITUDES
80							
							@82' Brown clayey fine to medium grained SANDSTONE, graded, hard, wet, medium to highly plastic.
85							
							@87' - Brown to yellowish brown fine to coarse grained gravel CONGLOMERATE with fine to coarse sand matrix, well graded, hard, moist, subrounded metamorphic clasts.
90	26-10" C			16.7	106.7		@90' - Dark yellow brown fine grained sandy clayey SILTSTONE, poorly graded, hard, moist. @92' - Dark yellowish brown clayey silty fine to medium grained SANDSTONE, graded, hard, moist.
95							
							@98' - Dark yellowish brown clayey silty fine grained subrounded to subangular gravelly fine to coarse grained SANDSTONE, well graded, hard, moist, clasts are subrounded and metamorphic.
100	30-10" C			4.9	106.9		@100' - Light yellowish brown fine to coarse grained gravel CONGLOMERATE with friable fine to coarse sand matrix, well graded, hard, moist, clasts are subrounded and metamorphic. @101' - Color change to dark yellowish brown. @104' - Abundant cobbles. @105' - Moisture increase to very moist, matrix coarsens to fine to coarse grained sandy fine grained gravel. @106' - Seep. @109' - Yellowish red subrounded cobble CONGLOMERATE with weakly cemented clayey fine to coarse sand matrix, well graded, hard, moist, clasts are subrounded. @110' - Yellowish brown fine grained gravel CONGLOMERATE with weakly cemented clayey fine to coarse sand matrix, well graded, hard, moist, low to medium plastic matrix, clasts are subrounded and metamorphic.
105							
110							
115							
120							Total Depth - 115' Seeps at 44'-54' and 106' Caving at 51'-53' Backfilled
125							
ADDITIONAL COMMENTS:					Blows per 12" C = Modified California Sampler Kelly Bar Weights: 0 - 30', 5619 lbs. 31 - 60', 3745 lbs. 61 - 90', 2280 lbs.		

CLIENT: Pardee Homes						PROJECT: Skyline Ranch			W.O.: 8838.002	
LOCATION: Santa Clarita						ELEVATION: 2165'			DATE: 7/14/06	
RIG TYPE: 24" Bucket						HAMMER WEIGHTS: Kelly Bar Weights			DROP: 12"	
	N	U	B	M	DD	DESCRIPTION			ATTITUDES	
0						<p><u>Saugus Formation</u>: Dark brown clayey silty fine to coarse grained SANDSTONE, graded, dense, moist, rootlets.</p> <p>@2' - Light yellowish brown fine to coarse grained gravelly silty fine grained SANDSTONE, poorly graded, dense, moist, weakly cemented, clasts are subangular.</p>				
5						<p>@5'5" - Grades to fine to coarse grained gravel CONGLOMERATE with friable fine to coarse sand matrix, well graded, dense, moist, abundant rootlets.</p> <p>@7.5' - Irregular, scoured contact with brown clayey silty fine to medium grained SANDSTONE, graded, dense, moist, weakly indurated.</p> <p>@8' - Color change to yellowish brown.</p>			@5'5" Approx. BN79E/10NW	
10	4	C		13.0	110.8	<p>@11' - Grades to yellowish brown fine grained gravel CONGLOMERATE with slightly friable clayey silty fine to coarse sand matrix, well graded, hard, moist.</p> <p>@11.5' - Irregular, scoured contact with brown clayey silty fine to medium grained SANDSTONE, graded, dense, moist, weakly indurated.</p>			@12'2" Approx. BN58E/11NW	
15						<p>@12'2" - Grades to yellowish brown fine to coarse grained gravel CONGLOMERATE with slightly friable clayey silty fine to coarse sand matrix, well graded, hard, moist.</p> <p>@15'11" - 2" thick brown claystone bed, stiff, moist, medium to highly plastic, waxy, corn flaky texture, internally sheared.</p>			@15'11" B + S Horizontal	
20	4	C		9.8	117.2	<p>@19' - Very pale brown fine grained gravelly fine to coarse grained SANDSTONE, poorly graded to graded, hard, moist, friable.</p> <p>@20'7" - Dark yellowish brown fine grained gravelly clayey silty fine grained SANDSTONE, graded, hard, moist, subrounded gravels, massive, weakly indurated, occasional discontinuous fine to coarse sandstone channels.</p>			@19' Approx. BN55E/14NW @20'7" C N84E/13SE	
25										
30	13	C		4.4	110.8	<p>@29' - Yellowish brown fine grained gravelly fine to coarse grained SANDSTONE, graded, hard, moist, gravels are subangular.</p> <p>@29'8" - Grades to yellowish brown subrounded fine to coarse grained gravel CONGLOMERATE with with slightly friable fine to coarse sand matrix, well graded, moist.</p> <p>@30'10" - Material becomes thinly bedded with cross bedding.</p> <p>@31'7" - Matrix becomes clayey.</p> <p>@33'4" - Clayey silty fine grained SANDSTONE, poorly graded.</p> <p>@34'3" - Grades to fine grained gravel CONGLOMERATE.</p> <p>@35'2" - Sharp, scoured contact with 8" thick brown CLAYSTONE, stiff, moist, highly plastic, internally sheared, corn flaky texture, waxy.</p>			@29'8" Approx. BN69W/12SW @30'10" B N56W/5SW	
35						<p>@35'2" - Sharp, scoured contact with 8" thick brown CLAYSTONE, stiff, moist, highly plastic, internally sheared, corn flaky texture, waxy.</p>			@35'2" Approx. CN37W/2SW @35'3" S N37W/2SW	
40	20	C		9.1	120.4	<p>@35'10" - Clayey silty fine to medium grained SANDSTONE, massive, weakly indurated, slightly plastic, occasional subangular fine gravel.</p> <p>@38' - Loose clay in matrix.</p> <p>@40' - Dark yellowish brown fine grained gravelly clayey silty fine to coarse grained SANDSTONE, graded, hard, moist.</p>				
45										

ADDITIONAL COMMENTS: Blows per 12"
 C = Modified California Sampler
 Kelly Bar Weights: 0 - 30', 5619 lbs,
 31 - 60', 3745 lbs,
 61 - 90', 2280 lbs.

CLIENT: Pardee Homes					PROJECT: Skyline Ranch		W.O.: 8838.002
LOCATION: Santa Clarita					ELEVATION: 2165'		DATE: 7/14/06
RIG TYPE: 24" Bucket					HAMMER WEIGHTS: Kelly Bar Weights		DROP: 12"
N	U	B	M	DD	DESCRIPTION	ATTITUDES	
40					@43' - Discontinuous fine grained gravel channel deposit.		
45					@46' - Grades to subrounded coarse grained gravel to cobble CONGLOMERATE, weakly cemented, hard, moist.	@46' Approx. BN9W/8SW	
50	20	C	2.7	118.6	@48.5' - Pale yellowish brown subrounded fine to coarse grained gravel CONGLOMERATE with weakly cemented fine to coarse sand matrix, well graded, hard, moist.	@48.5' Approx. BN2W/7SW	
55					@50' - Light gray subangular fine to coarse grained gravel CONGLOMERATE with fine to coarse sand matrix, well graded, hard, moist, thinly bedded with cross bedding.	@50'4" B N56W/10SW	
60					@51' - 1' thick dark grayish brown to grayish brown subangular fine to coarse grained gravelly fine to coarse grained SANDSTONE, graded, hard, moist.	@52' B N56W/9SW	
65					@54' - Yellowish brown fine grained subangular to angular gravelly fine to coarse grained SANDSTONE, graded, hard, moist.		
70					@55.5' - Grades to coarse grained gravel CONGLOMERATE.		
75					@56'1" - Reddish brown to yellowish red fine grained gravelly clayey fine to coarse grained SANDSTONE, well graded, hard, moist, slightly plastic, clasts are subrounded.	@59' Approx. C Horizontal	
80	19	C	9.2	121.7	@59' - Sharp, irregular scoured contact with fine to coarse grained sandy CLAYSTONE, graded, very stiff, moist, slightly plastic.		
85					@60'4" - Grades to yellowish brown subrounded fine grained gravel to cobble CONGLOMERATE with fine to coarse sand matrix, graded, hard, moist.		
					@63'9" - Brownish yellow clayey fine to coarse grained SANDSTONE, graded, hard, very moist, slightly plastic, weakly indurated.		
					@65.5' - Grades to light brownish gray subrounded to subangular coarse grained gravel to cobble CONGLOMERATE with weakly cemented fine to coarse sand matrix, graded, hard, moist.		
					@66'7" - Matrix color changes to pale brown.		
					@68' - Yellowish brown subrounded to subangular coarse grained gravel to cobble CONGLOMERATE with fine to coarse sand matrix, well graded, hard, moist, slightly plastic.		
	25-10"	C	8.3	105.6	@69' - Grades to light brownish subrounded to subangular gray coarse grained gravel to cobble CONGLOMERATE with weakly cemented fine to coarse silty sand matrix, graded, hard, moist.		
					@70' - Pale brown subrounded fine grained gravel to cobble CONGLOMERATE with fine to coarse sand matrix, graded, hard, moist.		
					@72' - Color change to pale yellow.		
					Total Depth - 72'		
					No groundwater		
					No caving		
					Backfilled		
ADDITIONAL COMMENTS:					Blows per 12" C = Modified California Sampler Kelly Bar Weights: 0 - 30', 5619 lbs. 31 - 60', 3745 lbs. 61 - 90', 2280 lbs.		

CLIENT: Pardee Homes					PROJECT: Skyline Ranch		W.O.: 8838.002
LOCATION: Santa Clarita					ELEVATION: 1978'		DATE: 7/17/06
RIG TYPE: 24" Bucket					HAMMER WEIGHTS: Kelly Bar Weights		DROP: 12"
N	U	B	M	DD	DESCRIPTION	ATTITUDES	
0					Artificial Fill: Brown silty fine to medium grained SAND, poorly graded, medium dense, dry, pieces of grass.		
					@1' - Saugus Formation: Brown fine grained gravelly clayey silty fine to coarse grained SANDSTONE, well graded, very dense, moist, subangular gravels, weakly cemented, rootlets.		
5					@3.5' - Yellowish brown fine grained gravelly clayey silty fine to medium grained SANDSTONE, graded, dense, moist, slightly friable, rootlets.		
					@3'10" - 6" thick blue gray cementation, pervasive white carbonate veins.		
					@6' - Some coarse gravels.	@8' Approx. B	
10	5 C		16.7	111.7	@8' - 1-6" thick dark yellowish brown channel deposit: fine to coarse grained gravel CONGLOMERATE with slightly friable fine to coarse grained sandstone matrix, well graded, dense, moist, subrounded to subangular clasts.	N4E/17NW	
		X			@8'1" - Brown fine grained gravelly silty fine grained SANDSTONE to fine grained sandy SILTSTONE, poorly graded, hard, moist.	@10'7" B	
					@10' - Grades to subrounded fine grained gravel CONGLOMERATE with weakly cemented sand matrix, well graded, hard, moist.	N24E/15NW	
15					@10'7" - abrupt, irregular contact to 3" thick brown silty CLAYSTONE, very stiff, moist, corn flaky texture, waxy, grades to fine grained sandy clayey SILTSTONE.		
20	9-9" C		7.8	115.3	@12'7" - Yellowish brown fine to medium grained sandy silty CLAYSTONE, poorly graded, slightly to medium plastic, moist, very stiff, white carbonate cemented veins at random orientations.	@19' Approx. B	
					@13'4" - Grades to brown silty SANDSTONE to sandy SILTSTONE.	BN4W/11SW	
					@14'7" - Grades to yellowish brown subrounded cobble CONGLOMERATE with clayey silty fine to coarse sand matrix, well graded, moist, slightly friable to weakly cemented.		
25					@19' - Fine grained gravel CONGLOMERATE bed with slightly friable to friable fine to coarse sand matrix, graded, hard, scoured.		
					@20' - Clasts coarsen to coarse grained gravel.		
					@25' - Grades to cobble CONGLOMERATE.		
30					@29' - Grades to cobble to boulder CONGLOMERATE.		
					@30' - Color change to dark yellowish brown.		
					@31' - Yellowish brown cobble to boulder CONGLOMERATE, slightly friable fine to coarse sand matrix, graded, hard, moist.		
35					@35' - Fine grained gravel interbed.	@35' Approx. B	
						BN12E/13NW	
40	9-6" C		7.1	89.1	@40' - Yellowish brown subrounded cobble CONGLOMERATE with fine to coarse sand matrix, well graded, hard, moist, black carbonate cemented gravels.	@40' Approx. B	
						BN38E/2NW	
45							
ADDITIONAL COMMENTS:					Blows per 12" C = Modified California Sampler Kelly Bar Weights: 0 - 30', 5619 lbs. 31 - 60', 3745 lbs. 61 - 90', 2280 lbs.		

CLIENT: Pardee Homes					PROJECT: Skyline Ranch			W.O.: 8838.002	
LOCATION: Santa Clarita					ELEVATION: 1978'			DATE: 7/17/06	
RIG TYPE: 24" Bucket					HAMMER WEIGHTS: Kelly Bar Weights			DROP: 12"	
	N	U	B	M	DD	DESCRIPTION		ATTITUDES	
40									
45							@45' - Yellowish brown fine grained gravelly silty fine to coarse grained SANDSTONE, graded to well graded, hard, moist, slightly friable, clasts are subangular.	@45' Approx. BN50E/9NW	
50	21-10" C			8.3	119.1		@48'8" - Abrupt contact with very pale brown silty fine to coarse grained SANDSTONE with clay and subangular to subrounded fine gravel clasts, well graded, weakly indurated, hard, moist.	@48'8" C N9E/27NW	
55							@49' - Very pale brown fine grained gravelly fine to coarse grained SANDSTONE, graded, hard, moist, clasts are subrounded. @50' - Very pale brown subangular fine grained gravel CONGLOMERATE with clayey silty fine to coarse sandstone matrix, well graded, hard, moist.		
60	17-9" C						@51' - Grades to very pale brown subangular to subrounded coarse grained gravel to cobble CONGLOMERATE, well graded, hard, moist, weakly cemented. @54' - Color change to dark yellowish brown, moisture to very moist. @56' - Color change to light yellowish brown, moist.		
65							@61' - Color change to light olive brown.		
70							@65' - <u>Mint Canyon Formation</u> : Sharp, irregular, scoured contact with gray silty fine grained SANDSTONE, poorly graded, hard, moist, moderately indurated. @67'10" - Irregular contact with subangular to subrounded coarse grained gravel to cobble CONGLOMERATE with slightly friable to weakly cemented clayey silty fine to coarse sand matrix, well graded, hard, moist.	@65' Approx. CN24W/6SW @67'4" B N2W/14SW @67'10" C N60W/15NE	
75							Total Depth - 72' No groundwater No caving Backfilled		
80									
85									
ADDITIONAL COMMENTS:						Blows per 12" C = Modified California Sampler Kelly Bar Weights: 0 - 30', 5619 lbs. 31 - 60', 3745 lbs. 61 - 90', 2280 lbs.			

CLIENT: Pardee					PROJECT: Skyline Ranch					W.O.: 8838									
LOCATION: Santa Clarita					ELEVATION: 1806'					DATE: 7/18/06									
RIG TYPE: HQ Core					HAMMER WEIGHTS: N/A					DROP: N/A									
										DESCRIPTION					ATTITUDES				
0										Saugus Formation; 0 - 30 feet, advanced with Tricone-bit. See log of Boring B6 (1995) for lithology from 0-30 feet.									
5																			
10																			
15																			
20																			
25																			
30	@30'	12/30	40	0/30	0														
	@32.5'	9/30	30	0/30	0														
35	@35'	12/30	40	4/30	13														
	@37.5'	8/30	26	7/30	23														
40	@40'	24/30	80	0/30	0														
45																			

ADDITIONAL COMMENTS: True dip inclinations determined by core measurement with protractor

CLIENT: Pardee		PROJECT: Skyline Ranch				W.O.: 8838
LOCATION: Santa Clarita		ELEVATION: 1806'				DATE: 7/18/06
RIG TYPE: HQ Core		HAMMER WEIGHTS: N/A				DROP: N/A
DESCRIPTION						ATTITUDES
40						@42.5' - Subangular to subrounded fine gravel to cobble CONGLOMERATE, with light brown medium to coarse grained sand matrix.
						@45' - <u>Mint Canyon Formation</u> : Subrounded gravel to cobble CONGLOMERATE clasts commonly andesite and granodiorite. Matrix is friable light greenish gray medium to coarse grained sand, moist.
45						@47.5' - Light brown silty SANDSTONE, poorly graded, hard, moist grading to fine to coarse gravel to cobble CONGLOMERATE, hard, moist
						@50' - Fine to coarse gravel CONGLOMERATE approx. 3" thick, light gray.
50						@53.5' - Sharp contact to cobble CONGLOMERATE
						@54' - Sharp contact to friable medium grained SANDSTONE with fine to coarse gravel (clasts commonly andesite and diorite), hard, moist.
						@55' - Occasional cobble clast. Sharp contact to CONGLOMERATE below.
55						@55.5' - Fine to coarse gravel CONGLOMERATE, well graded, friable greenish gray medium to coarse grained sand matrix, hard, moist.
						@57' - Dark reddish brown silty CLAYSTONE, medium plastic, in tip of core barrel (less than 1/4" thick).
60						@57'4" - Tan medium to coarse grained SANDSTONE, well graded, hard, moist hard, moist.
						@57'8" - Gabbro cobble, dark gray to black, sharp basal contact.
						@59'4" - Subangular to subrounded gravel CONGLOMERATE (approximately 30% gravel clasts). Matrix is fine to coarse sand.
65						@60' - Medium grained SANDSTONE with approximately 15% subangular to subrounded fine gravel clasts, hard, moist.
						@62' - Grades to fine grained SANDSTONE, hard, moist.
						@62'2" - Greenish gray silty CLAYSTONE, medium plastic, stiff, moist.
70						Slickensides.
						@62'10" - Fine grained SANDSTONE with occassional subrounded gravel, friable, hard, moist.
						@65' - Fine to coarse grained gravel CONGLOMERATE, weakly cemented olive brown medium to coarse grained sand matrix, hard, moist.
75						@70' - Fine grained gravel to cobble CONGLOMERATE with friable olive brown fine to coarse grained sand matrix, hard, moist.
						@75' - Subangular to subrounded fine to coarse gravel CONGLOMERATE, slightly friable dark brown (mottled tan) medium grained sand matrix, hard, moist. Overlying coarse grained SANDSTONE.
80						
85						

@49.5'
True dip =45°

@67.5'
True Dip = 10°

ADDITIONAL COMMENTS:

CLIENT: Pardee			PROJECT: Skyline Ranch			W.O.: 8838		
LOCATION: Santa Clarita			ELEVATION: 1806'			DATE: 7/19/06		
RIG TYPE:			HAMMER WEIGHTS: N/A			DROP: N/A		
						DESCRIPTION		ATTITUDES
80						@79.5' - Light olive gray fine grained SANDSTONE with fine gravel, hard, moist. @82' - Granodiorite cobble, porphyritic. @82'8" - Light gray medium to coarse grained SANDSTONE, with occasional fine to coarse gravel clasts of gabbro and diorite, slightly friable, hard, moist. @85' - Light gray fine to coarse grained SANDSTONE with fine gravel, poorly graded, slightly friable, hard, moist. Occasional granodiorite cobble clast. @87.5' - Sharp contact with fine to coarse grained SANDSTONE with fine gravel clasts of rhyolite and diorite, poorly graded, slightly friable, hard, moist. @89.5' - Granodiorite cobble, porphyritic, light gray, 4" diameter.		
	@79.5'	30/30	100	15/30	50	@90' - Brown medium to coarse grained SANDSTONE with subrounded coarse gravel, poorly graded, slightly friable, hard, moist. @92' - Light gray medium to coarse grained SANDSTONE with subangular to subrounded fine to coarse gravel, well graded, slightly friable, hard, moist. @95' - Fine gravel to cobble CONGLOMERATE, weakly cemented light greenish gray fine to coarse sand matrix, well graded, hard, moist. @97' - Light gray fine to coarse grained SANDSTONE with fine gravel to cobble clasts, well graded, slightly friable, hard, moist. @100' - Granodiorite gravel (2.5" diameter), gravel clasts are subangular. @103' - Medium to coarse grained SANDSTONE with subangular fine gravel clasts, well graded, friable, hard, moist. @105' - Light gray fine to medium grained SANDSTONE, well graded, weakly indurated, hard, moist. @105'4" - Light gray fine to coarse gravel CONGLOMERATE, slightly friable light gray fine to coarse sand matrix, well graded, hard, moist. To fining upward sequences of gravel CG to coarse SS. @107' - 1/8" diameter clay ripup clasts, slightly plastic, medium stiff, @109.5' - Occasional granitic cobble clast within fine to coarse SANDSTONE to gravel CONGLOMERATE.		@90.5' True dip = 15° @91' True dip = 10°
	@82'	29/36	81	10/30	33			
85								
	@85'	28/30	93	15/30	50			
	@87.5'	26/30	87	6/30	20			
90								
	@90'	50/60	83	25/60	42			
	@95'	24/24	100	12/24	50			
	@97'	27/36	75	24/36	67			@103' True dip = 20°
95								@104' True dip = 14°
	@100'	19/24	58	8/24	33			@105' True dip = 15°
	@102'	36/36	100	29/36	81			
100								
	@105'	46/54	85	14/54	26			
	@109.5'	26/36	72	11/36	31			
	@112.5'	14/30	46	0/30	0			
105								
	@115'	24/30	80	0/30	0			@119.4' True dip = 11°
								@121' True dip = 15°
110								@123' True dip = 18°
115								
120								
125								

ADDITIONAL COMMENTS:

CLIENT: Pardee						PROJECT: Skyline Ranch		W.O.: 8838
LOCATION: Santa Clarita						ELEVATION: 1806'		DATE: 7/19/06
RIG TYPE: HQ Core						HAMMER WEIGHTS: N/A		DROP: N/A
N	U	B	M	DD	DESCRIPTION		ATTITUDES	
120					@117.5' - Cobble CONGLOMERATE, weakly indurated greenish gray fine to coarse grained sand matrix, well graded, hard, moist. Grades to medium to coarse grained SANDSTONE with fine gravel, poorly graded, hard, moist.			
					@120' - Light gray fine to coarse grained SANDSTONE with fine gravel, poorly graded, mod indurated, hard, moist. To light olive brown fine to coarse grained SANDSTONE with subrounded fine gravel, poorly graded, weakly indurated, hard, moist. 1/8 inch thick CLAY, slightly plastic, stiff, moist.			
125					@125' - Fine to coarse gravel CONGLOMERATE, weakly cemented light gray fine to coarse sand matrix, well graded, hard, moist.		@128.5' True dip = 18°	
					@127' - Light gray fine to coarse grained SANDSTONE, well graded, weakly indurated, hard, moist.			
130								
	Depth (for Recovery/RQD)	Recovery/Core Barrel (inches)	% Recovery	Length Rx > 4" (inches)	RQD % Total 4"/Core			
	@117.5'	29/30	97	4/30	13			
	@120'	52/60	87	39/60	65			
135						@135' - Fine gravel to cobble CONGLOMERATE, poorly graded, weakly cemented light gray fine to coarse sand matrix, hard, moist.		
	@125'	24/24	100	17/24	71			
	@127'	24/36	67	13/36	36			
140						@140' - Fine to coarse gravel CONGLOMERATE, weakly cemented light gray fine to coarse sand matrix, poorly graded, hard, moist. Sharp contact with light gray fine to coarse grained SANDSTONE with gravel, poorly graded, moderately indurated, hard moist.	@139' True dip = 16°	
	@130'	18/44	41	19/44	42			
	@133.5'	14/18	78	0/18	0			
	@135'	39/42	93	22/42	52			
145						@145' - Light gray medium to coarse grained SANDSTONE, hard, moist. 12 inch thick interbed of weakly cemented gravel to cobble CONGLOMERATE. To olive gray medium to coarse grained SANDSTONE, hard, moist.		
	@138.5'	14/18	78	0/18	0			
	@140'	58/60	97	40/60	67	@148' - Fine to coarse gravel CONGLOMERATE, weakly cemented light greenish gray sand matrix, hard, moist.		
150						@150' - Light greenish gray medium grained SANDSTONE, poorly graded, hard, moist. 12 inch thick fine to coarse gravel CONGLOMERATE, moderately cemented medium grained sand matrix.	@150.5' True dip = 9°	
	@145'	53/60	88	38/60	63			
	@150'	58/60	97	36/60	60			
	@155'	31/36	86	12/36	33	@152' - Sharp contact with light gray fine to medium grained SANDSTONE, poorly graded, hard, moist, massive.	@153' True dip = 13°	
155						@155' - Light gray medium to coarse grained SANDSTONE to coarse gravel CONGLOMERATE, weakly cemented sand matrix, hard, moist.		
	@158'	22/24	92	22/24	92			
160						@158' - Fine to coarse grained gravel CONGLOMERATE with moderately cemented light greenish gray sand matrix, well graded, hard, moist.		
165								

ADDITIONAL COMMENTS:

CLIENT: Pardee						PROJECT: Skyline Ranch		W.O.: 8838
LOCATION: Santa Clarita						ELEVATION: 1806'		DATE: 7/19/06
RIG TYPE: HQ Core						HAMMER WEIGHTS: N/A		DROP: N/A
	N	U	B	M	DD	DESCRIPTION		ATTITUDES
160						@160' - Fine gravel to cobble CONGLOMERATE, moderately cemented light greenish gray fine to coarse sand matrix, well graded, hard, moist.		
165						@165' - Fine gravel to cobble CONGLOMERATE, weakly cemented light greenish gray fine to coarse sand matrix, well graded, hard, moist.		
170						@170' - Olive gray fine to coarse grained SANDSTONE with gravel, well graded, hard, moist. To olive brown CLAY with silt and fine gravel, slightly plastic, very stiff, moist.		@170.8' Horizontal bedding
	@160'	18/24	75	10/24	41			
	@162'	29/36	81	20/36	55	@173.5' - Olive brown clayey SILTSTONE, medium plastic, very stiff, moist.		
175	@165'	47/60	78	29/60	48	@175' - Olive brown silty CLAYSTONE, medium plastic, very stiff, moist.		
	@170	9/12	75	0/12	0			
	@179'					@179' - Gray medium to coarse grained Sandstone with fine gravel, moderately indurated, hard, moist.		
180	@173.	18/18	100	18/18	100			
	@175'	60/60	100	46/60	76			
	@180'							
185						Total Depth - 180'		
190								
195								
200								
205								

ADDITIONAL COMMENTS:

CLIENT: Pardee Homes						PROJECT: Skyline Ranch		W.O.: 8838.002	
LOCATION: Santa Clarita						ELEVATION: 1964'±		DATE: 7/19/06	
RIG TYPE: 24" Bucket						HAMMER WEIGHTS: Kelly Bar Weights		DROP: 12"	
	N	U	B	M	DD	DESCRIPTION		ATTITUDES	
0						Saugus Formation: Yellowish brown coarse grained gravel to cobble CONGLOMERATE with clayey silty fine to coarse sandstone matrix, well graded, dense, moist, rootlets, clasts consist of subangular to subrounded schist, granodiorite and quartzite.			
5						@2.5' - Pale brown subrounded fine to coarse grained gravel CONGLOMERATE with weakly cemented fine to coarse sand matrix, well graded, hard, moist, rootlets.		@6' B	
10	5	C			11.2	109.4	@6' - Highly scoured contact with dark yellowish brown silty fine grained SANDSTONE, poorly graded, hard, moist, weakly indurated, material blocky and fractured in sets every few inches, grades downward to fine grained SANDSTONE with gravel.	@6-7.5' fracture set	N82E/40SE
15							@10' - Grades to pale brown fine grained SANDSTONE with fine gravel, silt, and clay, well graded, dense, moist, slightly friable, pervasive subvertical dry white carbonate veins, grading to fine to medium grained sandy clayey SILTSTONE, dark yellowish brown, weakly indurated.	@14'8" Approx.	BN24W/18SW
							@15'5" - Contact to pale brown fine to medium grained SANDSTONE, graded, hard, moist.	@15'5" Fault	N76E/70SE
							@16' - Discontinuous one foot thick zone on SW wall, pervasive subvertical carbonate fractures.		
20	7	C			10.7	116.3	@19' - Grades to yellowish brown fine grained gravel to cobble CONGLOMERATE with slightly friable fine to coarse sandstone matrix, well graded, hard, moist.	@19' Approx.	BN4W/11SW
							@21' - Channeled.		
							@22'5" - Fine grained gravel CONGLOMERATE with fine to coarse sand matrix, well graded, hard, moist.		
25							@24' - Pocket of fine grained sandy clayey SILTSTONE in south wall.		
							@24'8" - Reddish brown fine to medium grained sandy clayey SILTSTONE with occasional fine gravel, poorly graded, hard, moist, weakly indurated, confined to NNE portion of boring with steep, sharp contact with sandstone from 22'5".	@28' Fault	N75E/80NW
30	12	C			7.1	125.4	@30' - Grades to yellowish brown fine grained gravel to cobble CONGLOMERATE with slightly friable silty fine to coarse sand matrix, well graded, hard, moist, subangular to subrounded.		
							@33'8" - Reddish brown clayey SILTSTONE exits boring.	@33'8" C	N84W/65NW
35			X					@33'9" Approx.	BN57W/14SW
40	20-10"	C			8.9	121.4	@40' - Three 1/4" thick bedding parallel orange weathering surfaces.	@40' B	N30W/7SW
							@43' - Yellowish brown clayey silty fine grained gravelly SANDSTONE, graded, hard, moist.		

ADDITIONAL COMMENTS: Kelly Bar Weights: 0 - 30', 5619 lbs.
 31 - 60', 3745 lbs.
 61 - 90', 2280 lbs.
 91 - 120', 1223 lbs.
 121 - 140', 1620 lbs.
 161 - 160', 2020 lbs.

Blows per 12"
 C = Modified California Sampler

CLIENT: Pardee Homes					PROJECT: Skyline Ranch		W.O.: 8838.002
LOCATION: Santa Clarita					ELEVATION: 1964'±		DATE: 7/19/06
RIG TYPE: 24" Bucket					HAMMER WEIGHTS: Kelly Bar Weights		DROP: 12"
	N	U	B	M	DD	DESCRIPTION	ATTITUDES
40							
45			X			@44'7" - Grades to coarse grained gravel to cobble CONGLOMERATE with fine to coarse sand matrix. @46'3" - Slightly irregular and scoured contact to dark yellowish brown clayey SILTSTONE with fine to medium sand, poorly graded, hard, moist, weakly indurated. @46'10" - Grades to fine to medium grained SANDSTONE.	@44' Approx. BN55W/17SW @46'3" C N65W/10SW @48' B N43W/11SW
50	24	C		7.6	121.8	@47'8" - Grades to fine to coarse grained gravel CONGLOMERATE. @48.5' - Contact with dark yellow brown clayey SILTSTONE. @49.5' - Grades to yellowish brown fine grained gravel CONGLOMERATE with silty fine to coarse sand matrix, well graded, hard, moist, subangular, slightly friable.	@53' C N60E/10SE
55						@53' - Slightly irregular, scoured contact to dark yellow brown clayey SILTSTONE, hard, moist. @54' - Grades to fine to medium grained SANDSTONE. @55' - Grades to grayish brown clayey silty fine to coarse grained gravelly SANDSTONE, well graded, slightly friable, hard, moist, clasts are subrounded.	@57' Approx. CN20W/8SW
60	21	C		6.3	122.3	@56' - Grades to fine to coarse grained gravel CONGLOMERATE. @57' - Slightly irregular to scoured contact with dark yellow brown clayey SILTSTONE. @59' - Grades to grayish brown to dark yellowish brown subrounded fine grained gravel CONGLOMERATE with slightly friable fine to coarse sand matrix, well graded, hard, moist.	@64' B N32W/16SW @66.5' B N47W/15SW
65						@62' - 6" thick fine grained SANDSTONE bed, discontinuous. @67' - 6" thick dark yellow brown SILTSTONE. @69'5" - Grades to dark yellowish brown subangular to subrounded fine to coarse grained gravel CONGLOMERATE with slightly friable fine to coarse sand matrix, well graded, hard, moist, occasional cobbles.	@67' C N47W/15SW @69.5' B N42W/16SW
70	24	C		4.5	126.9	@74' - Discontinuous 3" thick clayey SANDSTONE, matrix grades to weakly cemented. @77' - Matrix grades to brown clayey fine to coarse grained SANDSTONE; channel deposit.	@77' Approx. Channel N30E/25SE @80' B N40W/16SW
75							
80	25	C		12.9	120.6	@81.5' - Discontinuous claystone, 8" diameter pocket on west side of boring, within dark yellow brown fine to coarse grained gravel CONGLOMERATE, slightly friable fine to coarse sand matrix, well graded, hard, moist.	
85							

ADDITIONAL COMMENTS: Kelly Bar Weights: 0 - 30', 5619 lbs.
 31 - 60', 3745 lbs.
 61 - 90', 2280 lbs.
 91 - 120', 1223 lbs.
 121 - 140', 1620 lbs.
 161 - 160', 2020 lbs.

Blows per 12"
 C = Modified California Sampler

CLIENT: Pardee Homes						PROJECT: Skyline Ranch		W.O.: 8838.002	
LOCATION: Santa Clarita						ELEVATION: 1964'±		DATE: 7/19/06	
RIG TYPE: 24" Bucket						HAMMER WEIGHTS: Kelly Bar Weights		DROP: 12"	
	N	U	B	M	DD	DESCRIPTION		ATTITUDES	
80									
85							@86' - Dark yellow brown clayey fine to medium grained sandy SILTSTONE, discontinuous, poorly graded, hard, moist, weakly indurated. @88.5' - Sharp, slightly scoured contact with medium grained SANDSTONE.	@87' B N56W/17SW	
90	30-7" C			13.1	110.5		@90.5' - Grades to dark yellowish brown angular to subrounded coarse grained gravel to cobble CONGLOMERATE with slightly friable silty fine to coarse sand matrix, well graded, hard, moist. @92.5' - Slightly scoured contact with 1' thick SILTSTONE. @93.5' - Grades to dark yellowish brown subangular to subrounded gravel to cobble CONGLOMERATE with weakly cemented fine to coarse sand matrix, well graded, hard, moist. @95' - Color change to yellowish brown. @96' - Bedding becoming slightly crude.	@92.5' C N85E/14SE	
95								@96' B N80W/18SW	
100	30-10" C			6.8	114.5		@103' - Color change to dark yellowish brown and clayey matrix.	@101' B N65E/14SE	
105							@107' - 2" thick bed of dark yellow brown clayey SILTSTONE with fine to medium sand, hard, moist.	@106' Approx. BN50E/10SE @108' C N73W/16SW	
110	30-10" C			5.3	112.0		@110' - Grades to dark yellowish brown subangular to subrounded fine grained gravel to cobble CONGLOMERATE with slightly friable fine to coarse sand matrix, well graded, hard, moist. @114'7" - Dark yellowish brown fine to coarse grained SANDSTONE, graded, hard, moist, slightly friable, thinly bedded. @115' - Grades to fine grained gravel to cobble CONGLOMERATE with fine to coarse sand matrix, subangular to subrounded clasts. @118' - Moisture change to wet. @119'4" - Minor seep along contact with dark yellowish brown fine grained sandy SILTSTONE, poorly graded, hard, moderately indurated, moist. @121' - 12" thick clayey SILTSTONE.	@111' Approx. BN79E/9SE	
115								@114'7" B N48W/6SW	
120								@119'4" C N22W/10SW	
			X						
			X				@124.5' - 1/2" thick dark yellowish brown CLAYSTONE, poorly graded, very stiff, moist, highly plastic, corn flaky texture.	@124.5' S N35W/12SW	
125									

ADDITIONAL COMMENTS: Kelly Bar Weights: 0 - 30', 5619 lbs.
31 - 60', 3745 lbs.
Blows per 12" 61 - 90', 2280 lbs.
C = Modified California Sampler 91 - 120', 1223 lbs.
121 - 140', 1620 lbs.
161 - 160', 2020 lbs.

CLIENT: Pardee Homes					PROJECT: Skyline Ranch			W.O.: 8838.002	
LOCATION: Santa Clarita					ELEVATION: 1964'±			DATE: 7/19/06	
RIG TYPE: 24" Bucket					HAMMER WEIGHTS: Kelly Bar Weights			DROP: 12"	
	N	U	B	M	DD	DESCRIPTION			ATTITUDES
120									
125						@125.5' - Grades to dark yellowish brown silty fine to coarse grained SANDSTONE with subangular to subrounded fine to coarse gravel, graded, hard, moist. @127' - 4" thick fine to coarse grained gravel bed. @128' - Sharp, slightly irregular, scoured contact with dark yellowish brown fine to medium grained sandy clayey SILTSTONE, weakly indurated, sheared.			@127' Approx. BN74W/8SW
130						@128.5' - Grades to fine to medium sandy SILTSTONE, not sheared. @129' - Dark yellowish brown silty fine grained SANDSTONE to fine grained sandy SILTSTONE with occasional subangular fine gravel, poorly graded, hard, moist. @131' - Grades to dark yellowish brown fine grained gravelly silty fine to medium grained SANDSTONE, graded, hard, moist, subangular clasts.			@128' SN70W/78NE Slicks Plunge 11°, S82E
135						@132' - Yellowish brown silty fine to medium grained SANDSTONE to fine to medium grained sandy SILTSTONE. @133.5' - 6" thick clayey SANDSTONE. @135.5' - 12" thick dark yellowish brown fine grained gravelly clayey fine to coarse grained SANDSTONE, graded, hard, very moist, slightly to medium plastic, subangular clasts.			
140	22	C		11.0	122.8	@138' - Dark yellowish brown fine grained gravelly silty fine to coarse grained SANDSTONE, well graded, hard, moist, 1/2mm thick discontinuous clay bed. @141.5' - Shear zone, dark yellowish brown CLAYSTONE, highly plastic where sheared, very stiff, poorly graded, moist. Shear at 141.5' truncates others and is dominant. @142.5' - Dark yellowish brown to yellowish brown subangular to subrounded fine grained gravel CONGLOMERATE with slightly friable fine to coarse sand matrix, well graded, hard, moist, occasional rounded cobbles.			@141.5' S N20W/16SW
145						@143' - Color change to yellowish brown. @144' - Dark yellowish brown fine gravel CONGLOMERATE, weakly cemented. @145' - Matrix becomes clayey for 3". @146' - Dark yellowish brown clayey SILTSTONE to silty CLAYSTONE, poorly graded, stiff, moist.			@142.5' S N82E/27SE
150						@147.5' - Clayey SILTSTONE, pervasively sheared, shear at 148' is dominant. @148.5' - Grades to clayey silty fine to coarse grained SANDSTONE with slightly friable channel deposit in E wall of fine grained gravel to cobble CONGLOMERATE, fine to coarse sand matrix. @150' - Dark yellowish brown fine grained sandy clayey SILTSTONE, poorly graded to graded, hard, moist.			@143.5' B N49W/22SW
155	24	C		12.6	117.0	@151' - Shear, truncated above by shear at 148'. @154' - Dark yellowish brown silty fine to coarse grained SANDSTONE, graded, hard, moist.			@146' C N56W/16SW
160									@148' S N78E/14SE
165									@151' S N81W/56SW

ADDITIONAL COMMENTS: Kelly Bar Weights: 0 - 30', 5619 lbs.
 31 - 60', 3745 lbs.
 Blows per 12" 61 - 90', 2280 lbs.
 C = Modified California Sampler 91 - 120', 1223 lbs.
 121 - 140', 1620 lbs.
 161 - 160', 2020 lbs.

CLIENT: Pardee Homes					PROJECT: Skyline Ranch			W.O.: 8838.002	
LOCATION: Santa Clarita					ELEVATION: 2325'			DATE: 8/28/06	
RIG TYPE: 24" Bucket					HAMMER WEIGHTS: Kelly Bar Weights			DROP: 12"	
	N	U	B	M	DD	DESCRIPTION			ATTITUDES
0						Mint Canyon Formation: Brown to dark grayish brown cobble CONGLOMERATE with slightly friable silty fine to medium sand matrix, well graded, hard, moist, clasts are subangular to subrounded.			
5						@6.5' - 5%-10% boulders. @7.5' - Discontinuous pale brown fine to coarse grained SANDSTONE with subangular fine gravel, moderately graded, hard, moist, cross bedded, slightly friable. @10' - End roots.			@5' Approx. BN45E/9SE
10						@12' - Light yellowish brown subangular to subrounded cobble CONGLOMERATE with slightly friable silty fine to coarse sand matrix, well graded, hard, moist, 20% boulders, increasing with depth, occasional subangular to subrounded gravel CONGLOMERATE interbeds.			@12' Approx. BN5W/20SW
15						@17' - Sharp scoured contact to discontinuous pale brown to light gray silty fine to medium grained SANDSTONE, poorly graded, hard, moist, weakly indurated.			@17' C N25W/23SW
20						@19' - Abruptly grades to pale brown to light gray subangular to subrounded cobble CONGLOMERATE with slightly friable silty fine to coarse sand matrix, well graded, hard, moist. @20' - Sharp scoured contact to discontinuous pale brown to light gray silty fine to medium grained SANDSTONE, poorly graded, hard, moist, weakly indurated.			@19' B N75W/15SW @20' C N12W/22SW
25						@23' - Abruptly grades to pale brown to light gray subangular to subrounded fine grained gravel CONGLOMERATE with slightly friable silty fine to coarse sand matrix, well graded, hard, moist.			@24' B N25W/19SW
30						@24' - Grades to pale brown to light gray subangular to subrounded cobble CONGLOMERATE with slightly friable clayey silty fine to coarse sand matrix, well graded, hard, moist.			@31' B N42W/16SW
35						@26.5' - Light gray to pale brown scoured-out discontinuous pocket of fine to coarse grained SANDSTONE with subangular fine gravel, poorly graded, very dense, moist, slightly friable to weakly cemented. @27' - Olive brown subangular to subrounded fine cobble CONGLOMERATE with slightly friable clayey fine to medium sand matrix, well graded, hard, moist, with occasional fine gravel CONGLOMERATE interbeds.			@32.5' B N41W/19SW
40						@28' - Occasional boulders (10%) to 30' depth. @32.5' - 3" thick discontinuous light gray silty fine to medium grained SANDSTONE.			@38' Approx. BN43W/20SW
45						@36' - Olive brown to light gray subangular to subrounded cobble CONGLOMERATE with slightly friable silty fine to coarse sand matrix with lean clay, well graded, hard, moist, with occasional fine gravel CONGLOMERATE interbeds. @38' - Matrix grades to slightly plastic and clayey.			

ADDITIONAL COMMENTS:

CLIENT: Pardee Homes					PROJECT: Skyline Ranch			W.O.: 8838.002
LOCATION: Santa Clarita					ELEVATION: 2325'			DATE: 8/28/06
RIG TYPE: 24" Bucket					HAMMER WEIGHTS: Kelly Bar Weights			DROP: 12"
	N	U	B	M	DD	DESCRIPTION		ATTITUDES
40						@41' - Occasional boulders (10%) in olive brown to light gray subangular to subrounded cobble CONGLOMERATE with slightly friable, slightly plastic silty fine to coarse sand matrix with CLAY, well graded, hard, moist.		
45								@45' B N40W/12SW
50						@49' - Lean clay in matrix, non-plastic.		
55						@52' - End boulders to light gray subangular to subrounded cobble CONGLOMERATE with slightly friable silty fine to coarse sand matrix, well graded, hard, moist, with occasional poorly graded conglomerate.		@55.5' Appox. BN28W/20SW @57.5' B N38W/19SW
60								
65						@62.5' - Light gray cobble boulder CONGLOMERATE,,		
70						@66' - Refusal on boulder.		
75						Total Depth - 66' No groundwater No caving Backfilled		
80								
85								

ADDITIONAL COMMENTS:

SUBSURFACE DATA

LOG OF BORING B68

CLIENT: Pardee Homes					PROJECT: Skyline Ranch			W.O.: 8838.002	
LOCATION: Santa Clarita					ELEVATION: 2014'			DATE: 9/1/06	
RIG TYPE: 24" Bucket					HAMMER WEIGHTS: Kelly Bar Weights			DROP: 12"	
	N	U	B	M	DD	DESCRIPTION			ATTITUDES
0						<p><u>Saugus Formation</u>: Dark brown to grayish brown silty fine to medium grained SANDSTONE with trace angular to subangular fine gravel, poorly graded, dense, dry, rootlets.</p>			
2.5						<p>@2' - Pale brown silty fine to medium grained SANDSTONE with subangular to subrounded fine gravel, poorly graded, dense, dry, subhorizontal calcium carbonate veins spaced 3-4" apart.</p>			
5						<p>@4' - Moist.</p>			
7.5			X			<p>@6' - Yellowish brown silty fine to medium grained SANDSTONE, poorly graded, dense, moist.</p> <p>@7' - Grades to yellowish brown clayey SILTSTONE, poorly graded, dense, moist, slightly friable, subhorizontal calcium carbonate veins.</p> <p>@8' - Grades to silty fine grained SANDSTONE to fine grained sandy SILTSTONE.</p>			
10						<p>@10.5' carbonate vein N35E/21NW</p>			
12.5						<p>@11' - 2' thick discontinuous channel deposit in S quadrant, fine to coarse gravel CONGLOMERATE with slightly friable clayey fine to coarse sand matrix, well graded, dense, moist.</p> <p>@11.5' - Silty fine grained SANDSTONE to fine grained sandy SILTSTONE, coarsens to yellowish brown subangular fine gravel CONGLOMERATE with slightly friable fine to coarse sand matrix, well graded, hard, moist.</p> <p>@12' - Sharp, slightly scoured contact with discontinuous silty fine grained SANDSTONE to fine grained sandy SILTSTONE, poorly graded, hard, moist, slightly friable, scoured out by gravels from 11'.</p>			@12' Approx. contact N86W/18SW
15	4/10-5" C			8.9	122.0	<p>@13' - Slightly irregular contact to yellowish brown clayey SILTSTONE, poorly graded, hard, moist, slightly friable with mottled 1/2" claystone veins.</p> <p>@14' - Reddish brown clayey SILTSTONE with olive green streaks, poorly graded, dense, moist.</p> <p>@15' - Grades to dark yellowish brown subangular fine gravel CONGLOMERATE with fine to medium sandy silty clay matrix, well graded, very dense, moist, slightly friable, matrix is slightly plastic.</p> <p>@15.5' - Grades to silty clayey SANDSTONE to clayey SILTSTONE with coarse sand and fine gravel, poorly graded, dense, moist, slightly friable, wavy.</p> <p>@17' - Grades to yellowish brown gravel to cobble CONGLOMERATE with friable to slightly friable fine to coarse sand matrix with trace silt, well graded, hard, moist.</p> <p>@18' - Matrix changes to reddish brown, clayey silty fine to coarse sand.</p> <p>@20' - Trace clay in matrix, coarse gravel CONGLOMERATE.</p> <p>@22' - Boulders.</p>			@17' Approx. contact horizontal
17.5			X						
20									
22.5									
ADDITIONAL COMMENTS:						<p>Blows per 6" C = Modified California Sampler Kelly Bar Weights: 0 - 24', 2854 lbs. 25 - 47', 1802 lbs. 48 - 70', 1091 lbs.</p>			

CLIENT: Pardee Homes					PROJECT: Skyline Ranch			W.O.: 8838.002
LOCATION: Santa Clarita					ELEVATION: 2014'			DATE: 9/1/06
RIG TYPE: 24" Bucket					HAMMER WEIGHTS: Kelly Bar Weights			DROP: 12"
N	U	B	M	DD	DESCRIPTION			ATTITUDES
20								
22.5								
25								
			X					
27.5								
			X					
30	5/10-5" C				14.5	109.3		
32.5								
35								
37.5								
40								
42.5								
ADDITIONAL COMMENTS:					Blows per 6"			
					C = Modified California Sampler			
					Kelly Bar Weights: 0 - 24', 2854 lbs.			
					25 - 47', 1802 lbs.			
					48 - 70', 1091 lbs.			

SUBSURFACE DATA

LOG OF BORING B68

CLIENT: Pardee Homes					PROJECT: Skyline Ranch			W.O.: 8838.002
LOCATION: Santa Clarita					ELEVATION: 2014'			DATE: 9/1/06
RIG TYPE: 24" Bucket					HAMMER WEIGHTS: Kelly Bar Weights			DROP: 12"
	N	U	B	M	DD	DESCRIPTION		ATTITUDES
40						@41' - Yellowish brown fine to coarse grained SANDSTONE, poorly graded, hard, moist.		
42.5						@44' - Yellowish brown clayey fine to coarse grained SANDSTONE with subrounded fine gravel, moderately graded, hard, moist.		
45	12-6" C			10.9	98.6	@45' - Grades to yellowish brown subangular to subrounded fine to coarse grained gravel CONGLOMERATE with trace clayey fine to coarse sand matrix, well graded, hard, moist.		
47.5						Total Depth - 45' No groundwater No caving Backfilled		
50								
52.5								
55								
57.5								
60								
62.5								
ADDITIONAL COMMENTS:					Blows per 6" C = Modified California Sampler Kelly Bar Weights: 0 - 24', 2854 lbs. 25 - 47', 1802 lbs. 48 - 70', 1091 lbs.			

SUBSURFACE DATA

LOG OF BORING B69

CLIENT: Pardee Homes						PROJECT: Skyline Ranch		W.O.: 8838.002
LOCATION: Santa Clarita						ELEVATION: 2080'		DATE: 9/5/06
RIG TYPE: 24" Bucket						HAMMER WEIGHTS: Kelly Bar Weights		DROP: 12"
N	U	B	M	DD	DESCRIPTION		ATTITUDES	
0					Landslide Debris?: Yellowish brown gravel to cobble CONGLOMERATE with silty fine to medium sand matrix, well graded, medium dense, dry, rootlets, blocky and fractured in upper 8", slightly friable.			
2.5					@2' - Moist.		@2' B N78E/24NW	
				X	@3' - Sharp, scoured contact with dark yellowish brown CLAYSTONE, stiff, moist, massive.		@3' C N86E/19NW	
5					@6' - End roots.			
7.5				X	@7.5' - 3" of medium plasticity within claystone.			
					@9' - Grades to dark yellowish brown fine to coarse grained sandy clayey SILTSTONE with trace subangular fine gravel, poorly graded, stiff, moist.			
10					@11' - Grades to dark yellowish brown clayey silty fine to medium grained SANDSTONE with 15% subangular fine gravel, moderately graded, medium dense, moist, slightly friable.			
12.5				X	@12.5' - Slightly scoured contact to dark yellowish brown clayey fine grained sandy SILTSTONE, poorly graded, stiff, moist, slightly plastic, slightly friable.		@12.5' C N24E/16NW	
					@13.5' - 1-3" thick CLAYSTONE, stiff, moist, highly plastic, corn flaky texture, internally sheared, bounded below by clayey silty fine grained SANDSTONE, poorly graded, medium dense, moist, slightly plastic.		@13.5' S N8E/19NW	
15	2/2	C		15.5	---	@15' - Dark yellowish brown silty fine to coarse grained sandy CLAYSTONE, stiff, moist, medium plastic.	@15.5' Approx. CN72W/4NE	
						@15.5' - Scoured contact to fine grained sandy SILTSTONE, poorly graded, stiff, moist, slightly plastic, slightly friable.		
17.5						@16' - Discontinuous 1" thick CLAYSTONE, sheared, highly plastic.		
						@18' - Grades to fine gravel fine to coarse grained sandy SILTSTONE.		
20				X	@19.5' - Grades to yellowish brown subangular fine grained gravel CONGLOMERATE, well graded, medium dense, moist, slightly friable.			
					@20' - Grades to dark yellowish brown clayey silty fine to coarse grained SANDSTONE with subangular fine gravel, poorly graded, medium dense, moist.		@21' Approx. BN19W/10NE	
					@21' - Sharp contact to 2" thick dark yellowish brown silty CLAYSTONE, poorly graded, stiff, moist, internally sheared, shear cuts bedding in sands above.			
22.5								
ADDITIONAL COMMENTS:						Blows per 6" C = Modified California Sampler Kelly Bar Weights: 0 - 24', 2854 lbs. 25 - 47', 1802 lbs. 48 - 70', 1091 lbs.		

SUBSURFACE DATA

LOG OF BORING B69

CLIENT: Pardee Homes					PROJECT: Skyline Ranch		W.O.: 8838.002
LOCATION: Santa Clarita					ELEVATION: 2080'		DATE: 9/5/06
RIG TYPE: 24" Bucket					HAMMER WEIGHTS: Kelly Bar Weights		DROP: 12"
N	U	B	M	DD	DESCRIPTION		ATTITUDES
20							@21.1" S N60E/45SE
						@21.5' - Grades to clayey fine grained sandy SILTSTONE with trace subangular fine gravel, poorly graded, stiff, moist, slightly friable.	
22.5						@24' - Increase in clay, material becomes slightly plastic.	
25							
						@26.5' - Abruptly grades to yellowish brown subangular to subrounded fine grained gravel CONGLOMERATE with slightly friable clayey silty fine to coarse sand matrix, moderately graded, medium dense, moist, 3-12" thick.	@27' Approx. CN6W/27NE
27.5			C			@27' - Sharp, irregular contact to 3" thick dark yellowish brown CLAYSTONE, stiff, moist, highly plastic, grades to clayey fine grained sandy SILTSTONE, poorly graded, stiff, moist, slightly friable.	
						@29' - Grades to yellowish brown silty fine grained SANDSTONE, poorly graded, medium dense, moist, slightly friable.	
30	2/4	C	X	20.2	105.2	@29.5' - Sharp contact with discontinuous fine to coarse grained SANDSTONE with fine gravel.	@30' S N63W/8SW
						@30' - Contact with 1-10" thick dark yellowish brown silty CLAYSTONE, poorly graded, stiff, moist, highly plastic, pervasively sheared, sheared lower contact.	
32.5						@31' - <u>Saugus Formation</u> : Dark yellowish brown SILTSTONE, weakly indurated, very stiff, moist.	
						@32.5' - Grades to dark yellowish brown silty fine to medium grained SANDSTONE with trace subangular to subrounded fine gravel, poorly graded, dense, moist, massive, slightly friable.	
35							
						@36.5' - 4" thick subangular fine grained gravel CONGLOMERATE with slightly friable fine to coarse sand matrix, moderately graded, dense, moist.	@37' B N35E/11SE
37.5						@37' - 3" thick subangular fine grained gravel CONGLOMERATE.	
						@38' - Grades to yellowish brown fine to coarse grained SANDSTONE with trace subangular to subrounded fine gravel, poorly graded, dense, moist, slightly friable.	@38.5' C N57E/8SE
						@38.5' - Sharp contact to dark yellowish brown clayey SILTSTONE, poorly graded, very stiff, moist, slightly friable.	
40						@40' - Dark yellowish brown fine to medium grained sandy clayey SILTSTONE, poorly graded, very stiff, moist, slightly plastic, slightly friable.	
42.5							
ADDITIONAL COMMENTS:					Blows per 6" C = Modified California Sampler Kelly Bar Weights: 0 - 24', 2854 lbs. 25 - 47', 1802 lbs. 48 - 70', 1091 lbs.		

SUBSURFACE DATA

LOG OF BORING B69

CLIENT: Pardee Homes					PROJECT: Skyline Ranch		W.O.: 8838.002
LOCATION: Santa Clarita					ELEVATION: 2080'		DATE: 9/5/06
RIG TYPE: 24" Bucket					HAMMER WEIGHTS: Kelly Bar Weights		DROP: 12"
N	U	B	M	DD	DESCRIPTION		ATTITUDES
40							
						@42' - Grades to fine grained sandy clayey SILTSTONE, medium plastic.	
42.5						@43' - Grades to dark yellowish brown clayey silty fine to medium grained SANDSTONE, poorly graded, dense, moist, slightly plastic, slightly friable.	
45	3/7	C			19.9	107.7	@45' - Dark yellowish brown fine to medium grained sandy clayey SILTSTONE, poorly graded, very stiff, moist, medium plastic, slightly friable.
47.5							
							@49' - Grades to dark yellowish brown very clayey silty fine grained SANDSTONE, poorly graded, dense, moist, slightly plastic, slightly friable.
50							
52.5							
55							@55.5' - 5" thick dark yellowish brown fine grained gravel CONGLOMERATE with slightly friable clayey silty fine to coarse sand matrix, well graded, dense, very moist. @56' - Dark yellowish brown clayey silty fine to coarse grained SANDSTONE, poorly graded, dense, moist, slightly friable.
							@55.5' B N74E/9SE
57.5							
60	15-8"	C			13.3	---	@60' - Yellowish brown silty fine grained SANDSTONE with mottled iron staining and olive green veins, poorly graded, dense, moist, slightly plastic, slightly friable.
62.5							
ADDITIONAL COMMENTS:					Blows per 6" C = Modified California Sampler Kelly Bar Weights: 0 - 24', 2854 lbs. 25 - 47', 1802 lbs. 48 - 70', 1091 lbs.		

SUBSURFACE DATA

LOG OF BORING B69

CLIENT: Pardee Homes					PROJECT: Skyline Ranch			W.O.: 8838.002
LOCATION: Santa Clarita					ELEVATION: 2080'			DATE: 9/5/06
RIG TYPE: 24" Bucket					HAMMER WEIGHTS: Kelly Bar Weights			DROP: 12"
N	U	B	M	DD	DESCRIPTION			ATTITUDES
60								
62.5								
65								
67.5								
70								
72.5								
75								
77.5								
80								
82.5								
ADDITIONAL COMMENTS:					Blows per 6"			
					C = Modified California Sampler			
					Kelly Bar Weights: 0 - 24', 2854 lbs.			
					25 - 47', 1802 lbs.			
					48 - 70', 1091 lbs.			

SUBSURFACE DATA

LOG OF BORING B70

CLIENT: Pardee Homes					PROJECT: Skyline Ranch			W.O.: 8838.002		
LOCATION: Santa Clarita					ELEVATION: 1966'			DATE: 9/7/06		
RIG TYPE: 24" Bucket					HAMMER WEIGHTS: Kelly Bar Weights			DROP: 12"		
N	U	B	M	DD	DESCRIPTION			ATTITUDES		
0					Saugus Formation: Yellowish brown silty fine grained SANDSTONE with subangular to subrounded fine to coarse gravel, poorly graded, medium dense, moist, blocky and fractured in upper 6", rootlets to 3'.					
2.5					@2.5' - Dark yellowish brown clayey fine to medium grained sandy SILTSTONE with trace subangular fine gravel, poorly graded, stiff, moist, slightly friable. @3.5' - Grades to yellowish brown silty fine to medium grained SANDSTONE, poorly graded, medium dense, moist, slightly friable.					
5					X	@4.5' - Grades to yellowish brown subangular fine grained gravel CONGLOMERATE with slightly friable fine to medium sand matrix, moderately graded, medium dense, moist. @5' - Sharp contact with yellowish brown clayey fine to medium grained sandy SILTSTONE, poorly graded, stiff, moist, slightly friable.			@5' C N29W/12SW	
7.5					X	@5.5' - Grades to yellowish brown subangular fine grained gravel CONGLOMERATE with slightly friable fine to medium sand matrix, moderately graded, medium dense, moist. @5'9" - Sharp contact with yellowish brown clayey fine to medium grained sandy SILTSTONE, poorly graded, stiff, moist, slightly friable. @6.2' - Grades to yellowish brown subangular fine grained gravel CONGLOMERATE with slightly friable fine to medium sand matrix, moderately graded, medium dense, moist.			@6.5' B N29W/16SW	
10						@8' - Slightly scoured contact with dark yellowish brown clayey very silty fine to medium grained SANDSTONE with trace subangular fine gravel, poorly graded, medium dense, moist, slightly plastic, massive.			@8' C N56W/22SW	
12.5										
15	2/4	C			5.4	119.5	@14.5' - Grades to clayey silty fine to medium grained SANDSTONE with 15% subangular to subrounded fine gravel, moderately graded, medium dense, moist, slightly friable. @15' - Grades to yellowish brown subangular to subrounded gravel CONGLOMERATE with slightly friable fine to coarse sand (trace silt) matrix, well graded, medium dense, moist.			@16' B N6W/16SW
17.5							@18.5' - Sharp highly scoured (2.5' in SE quadrant) contact with dark yellowish brown fine to medium grained sandy very clayey SILTSTONE, poorly graded, stiff, moist, waxy, corn flaky texture, medium plastic.			@18.5' Approx. CN47E/47SE @19.5' Approx. BN65E/10SE
20										
22.5										
ADDITIONAL COMMENTS:					Blows per 6" C = Modified California Sampler Kelly Bar Weights: 0 - 24', 2854 lbs. 25 - 47', 1802 lbs. 48 - 70', 1091 lbs.					

SUBSURFACE DATA

LOG OF BORING B70

CLIENT: Pardee Homes					PROJECT: Skyline Ranch			W.O.: 8838.002
LOCATION: Santa Clarita					ELEVATION: 1966'			DATE: 9/7/06
RIG TYPE: 24" Bucket					HAMMER WEIGHTS: Kelly Bar Weights			DROP: 12"
N	U	B	M	DD	DESCRIPTION			ATTITUDES
20								
22.5								
25								
27.5								
30	3/8	C	10.3	123.9				
32.5								
35								
37.5								
40								
42.5								
ADDITIONAL COMMENTS:					Blows per 6"			
					C = Modified California Sampler			
					Kelly Bar Weights: 0 - 24', 2854 lbs.			
					25 - 47', 1802 lbs.			
					48 - 70', 1091 lbs.			

CLIENT: Pardee Homes					PROJECT: Skyline Ranch					W.O.: 8838.002	
LOCATION: Santa Clarita					ELEVATION: 1966'					DATE: 9/7/06	
RIG TYPE: 24" Bucket					HAMMER WEIGHTS: Kelly Bar Weights					DROP: 12"	
	N	U	B	M	DD	DESCRIPTION				ATTITUDES	
40											
42.5			X								@42' Sheared contact N53W/12SW
45	4/10	C		12.9	123.5						@45' - Grades to dark yellowish brown clayey silty fine to medium grained SANDSTONE, poorly graded, very dense, moist.
47.5											@47' B N66W/24SW
50											
52.5											@51.5' - 4" thick dark yellowish brown CLAYSTONE, highly plastic, discontinuous shear. @53' - 1-2" thick dark yellowish brown CLAYSTONE, stiff, moist, waxy, corn flaky texture, highly plastic where sheared, medium plastic otherwise.
55											@55.5' B N55W/16SW
57.5											@56.5' - Dark yellowish brown fine grained sandy SILTSTONE, poorly graded, hard, moist, slightly friable. @58' - Grades to dark yellowish brown clayey silty fine to medium grained SANDSTONE, poorly graded, dense, moist, slightly friable.
60	16-6"	C		10.4	108.3						@60' - Yellowish brown fine to medium grained sandy SILTSTONE, poorly graded, very stiff, moist, with dark yellowish brown trace fine to coarse grained sandy CLAYSTONE, highly plastic.
62.5											
ADDITIONAL COMMENTS:						Blows per 6" C = Modified California Sampler Kelly Bar Weights: 0 - 24', 2854 lbs. 25 - 47', 1802 lbs. 48 - 70', 1091 lbs.					

CLIENT: Pardee Homes					PROJECT: Skyline Ranch					W.O.: 8838.002					
LOCATION: Santa Clarita					ELEVATION: 1966'					DATE: 9/7/06					
RIG TYPE: 24" Bucket					HAMMER WEIGHTS: Kelly Bar Weights					DROP: 12"					
N	U	B	M	DD	DESCRIPTION					ATTITUDES					
60					@61.5' - Brown subangular cobble CONGLOMERATE with slightly friable silty fine to coarse sand matrix, well graded, dense, moist, thickly bedded. @65' - Brown subangular cobble CONGLOMERATE with slightly friable silty fine to coarse sand matrix, well graded, dense, moist, thickly bedded. @70' - Brown subangular cobble CONGLOMERATE with slightly friable silty fine to coarse sand matrix, well graded, dense, moist, thickly bedded. Total Depth - 74' No groundwater No caving Backfilled										
62.5															
65										@65' Approx. BN71W/18SW					
67.5															
70															
72.5															
75															
77.5															
80															
82.5															
ADDITIONAL COMMENTS:										Blows per 6" C = Modified California Sampler Kelly Bar Weights: 0 - 24', 2854 lbs. 25 - 47', 1802 lbs. 48 - 70', 1091 lbs.					

CLIENT: Pardee Homes					PROJECT: Skyline Ranch			W.O.: 8838.002	
LOCATION: Santa Clarita					ELEVATION: 1815'			DATE: 9/11/06	
RIG TYPE: 24" Bucket					HAMMER WEIGHTS: Kelly Bar Weights			DROP: 12"	
	N	U	B	M	DD	DESCRIPTION		ATTITUDES	
0						Landslide Debris: Dark grayish brown to dark yellowish brown fine to coarse grained SAND with 10% subangular to subrounded fine to coarse gravel, graded, medium dense, dry.			
						@1' - Grades to dark yellowish brown fine to coarse grained SAND with 20% subangular to subrounded fine to coarse gravel, well graded, dense, moist.			@4' Approx.
5						@4' - Color change to yellowish brown and fine gravel to cobble sized clasts,			BN65E/16SE
			X			@6' - Absence of clasts, yellowish brown clayey fine to medium grained SAND, poorly graded, dense, moist, subvertical 1/4" thick carbonate stringers.			
						@8' - Dark yellowish brown fine to coarse grained SAND with 20% subangular to subrounded fine to coarse gravel, well graded, dense, moist.			
10						@12' - Clay lens.			@11' Approx.
									BE-W/17S
15	1/1	C		19.3	108.9	@15' - Yellowish brown fine to coarse grained SAND with angular to subangular fine gravel, moderately graded, dense, moist, contact with strong brown clayey fine grained SANDSTONE in tip, poorly graded, dense, moist, medium plastic.			
						@17' - Grades to yellowish brown fine to coarse grained SAND with angular to subangular fine gravel and clayey fine sand interbeds.			
20			X			@20' - Sharp contact with 6" thick strong brown clayey fine grained SAND, very moist to wet.			@20' Approx.
						@20.5' - Contact with yellowish brown 6" thick fine to coarse grained SAND with gravel.			CN55E/15SE
						@22.5' - 1/8" thick strong brown CLAY, exits boring, medium plastic, sheared.			@22.5' S
						@23' - Less than 1/8" thick lower bound shear (continuous) within discontinuous 1-6" thick CLAY to clayey fine grained SAND, slickensides bear N71W.			N26E/17SE
25						Saugus Formation: Dark yellowish brown to olive brown fine to coarse grained SANDSTONE grading to boulder CONGLOMERATE with weakly cemented fine to coarse sand matrix, well graded, hard, moist.			@23' S
			X			@25' - Mint Canyon Formation: Slightly irregular, undulatory, scoured contact with gray fine to coarse grained SANDSTONE, poorly graded, very dense, moist, weakly indurated.			N74E/4NW
						@26' - Grades to gray subangular to subrounded fine gravel to cobble CONGLOMERATE with moderately cemented fine to coarse sand matrix, well graded, hard, moist.			@25' Approx.
						@30' - Grades to coarse gravel CONGLOMERATE, poorly graded, hard, moist.			CN55E/17SE
						@31' - Crude bedding.			@31' B
						@33' - Scoured contact to light gray fine to coarse grained SANDSTONE, weakly indurated.			N18W/22SW
35						@35' - Thin coarse gravel to boulder CONGLOMERATE within sandstone.			@32' B
						@36' - Grades to conglomeratic fine to coarse grained SANDSTONE with fine gravel clasts and occasional boulders, very dense, moist, weakly cemented.			N50W/16SW
						@39' - Grades to boulder CONGLOMERATE.			@33' C
									N55E/29NW
40									@35' Approx.
									BN5E/18NW
45									

ADDITIONAL COMMENTS: Total Depth 42'
 No groundwater, No caving, backfilled.
 Blows per 6"
 C = Modified California Sampler
 Kelly Bar Weights: 0 - 25', 2854 lbs.
 25 - 49', 1802 lbs.

CLIENT: Pardee Homes					PROJECT: Skyline Ranch		W.O.: 8838.002
LOCATION: Santa Clarita					ELEVATION: 1846'		DATE: 9/13/06
RIG TYPE: 24" Bucket					HAMMER WEIGHTS: Kelly Bar Weights		DROP: 12"
	N	U	B	M	DD	DESCRIPTION	ATTITUDES
0						<u>Saugus Formation</u> : Yellowish brown subangular fine grained gravel CONGLOMERATE with slightly friable silty fine to coarse sand matrix, well graded, dry in upper 6", moist below, blocky and fractured in upper 8", roots to 3'. @2' - Discontinuous dark brown CLAY pocket in N wall. @2'3" - Slightly scoured contact with silty fine grained SANDSTONE, poorly graded, hard, moist.	@1' B N58W/17NE
5			X			@2.5' - Grades to dark brown very clayey fine to medium grained SANDSTONE with coarse sand sized dry white carbonate nodules, hard, moist. @4.5' - Grades to yellowish brown subangular to subrounded fine gravel to cobble CONGLOMERATE with silty fine to medium sand matrix, well graded, hard, moist.	@8' Approx. BN30W/16SW
10						@9.5' - Absence of clasts in yellowish brown fine to coarse grained SANDSTONE. @11' - Grades to subangular to subrounded fine grained gravel CONGLOMERATE with fine to coarse sand matrix, well graded, hard, moist, slightly friable. @11.5' - Sharp scoured contact to strong brown very silty fine grained SANDSTONE.	@11' B N52W/13SE @11.5' Approx. CN57E/11NW
15	2/4	C		14.4	120.6	@12' - 6" thick fine to coarse grained SANDSTONE with subangular to subrounded fine gravel. @14.5' - Undulatory sharp upper contact with strong brown CLAYSTONE, sheared, highly plastic, waxy, corn flaky texture, moist. @15' - Brown clayey silty fine to coarse grained SANDSTONE with subangular fine gravel, poorly graded, hard, moist.	@14.5' Approx. SN22W/1SW
20						@19' - Abruptly grades to yellowish brown subangular to subrounded gravel CONGLOMERATE with fine to coarse sand matrix, well graded, hard, moist. @19.5' - Slightly scoured contact to dark yellowish brown 4" thick very silty fine grained SANDSTONE, overlying strong brown clayey SILTSTONE. @21.3' - Becomes waxy for 3".	@19' B N50W/12SW
25						@23' - Grades to dark yellowish brown clayey silty fine grained SANDSTONE with sparse medium to coarse sand, poorly graded, hard, moist. @27.5' - 3" thick section of subrounded fine gravel in silty fine to medium grained SANDSTONE.	
30	4/8	C		14.8	118.7	@30' - Brown to dark yellowish brown silty fine to medium grained SANDSTONE, poorly graded, hard, moist. @33.5' - 1' thick section of subrounded fine gravel within silty fine to medium grained SANDSTONE.	
35						@35.5' - Abruptly grades to subangular to subrounded gravel CONGLOMERATE with slightly friable fine to coarse sand matrix, well graded, hard, moist. @38' - Slightly scoured sharp contact to strong brown clayey fine grained sandy SILTSTONE, poorly graded, hard, moist.	@36' B N46W/15SW @38' C N21W/22NE
40						@39.5' - Two 6" thick channel deposits, yellowish brown subangular to subrounded fine grained gravel CONGLOMERATE with fine to coarse sand matrix, well graded, very dense, moist, exits in N and W walls.	
45							
ADDITIONAL COMMENTS:						Blows per 6" C = Modified California Sampler Kelly Bar Weights: 0 - 25', 2854 lbs. 25 - 48', 1802 lbs. 48 - 70', 1019 lbs.	

SUBSURFACE DATA

LOG OF BORING B72

CLIENT: Pardee Homes					PROJECT: Skyline Ranch			W.O.: 8838.002
LOCATION: Santa Clarita					ELEVATION: 1846'			DATE: 9/13/06
RIG TYPE: 24" Bucket					HAMMER WEIGHTS: Kelly Bar Weights			DROP: 12"
	N	U	B	M	DD	DESCRIPTION		ATTITUDES
40								
						@43' - Grades to dark yellowish brown silty fine grained SANDSTONE, poorly graded, hard, moist.		
45	5/12	C		12.4	121.8	@44' - 2" thick zone of fine gravel sized dry white carbonate nodules.		
						@45' - Yellowish brown silty fine grained SANDSTONE, poorly graded, hard, moist.		
						@47' - Grades to yellowish brown fine to coarse grained SANDSTONE which grades to 2" thick subangular to subrounded fine grained gravel CONGLOMERATE at base.		@47' B N26W/11SW
						@48' - Sharp, slightly scoured contact with dark yellowish brown silty fine grained SANDSTONE, poorly graded, hard, moist.		@48' C N31W/10SW
50						@50.5' - Grades to yellowish brown fine to coarse grained SANDSTONE, poorly graded, hard, moist, slightly friable.		@52.5' B N49E/10SE
						@51.5' - Grades to yellowish brown subangular to subrounded gravel CONGLOMERATE with slightly friable fine to coarse sand matrix, well graded, hard, moist.		@54' B N22E/14NW
55						@52.5' - Crudely bedded.		@55' C N60W/17SW
						@55' - Sharp, scoured contact to yellowish brown silty fine grained SANDSTONE, poorly graded, hard, moist.		
60	7/16-2"	C		16.7	110.5	@60' - Brown to yellowish brown silty fine grained SANDSTONE with sparse medium sand and trace subrounded fine gravel, poorly graded, hard, moist.		
						@60.5' - 6" thick section of subangular to subrounded gravel clasts in clayey silty fine grained SANDSTONE.		
						@62' - Strong brown trace fine to medium grained sandy SILTSTONE, weakly indurated, poorly graded, hard.		
65						@63' - Grades to yellowish brown fine grained gravel CONGLOMERATE with clayey fine to coarse sand matrix and trace subrounded cobbles, well graded, hard, moist.		
						@68' - Yellowish brown silty fine to coarse grained SANDSTONE with subangular fine gravel, moderately graded, hard, moist.		
70								
75						Total Depth - 72'		
						No groundwater		
						No caving		
						Backfilled		
80								
85								

ADDITIONAL COMMENTS: Blows per 6"
 C = Modified California Sampler
 Kelly Bar Weights: 0 - 25', 2854 lbs.
 25 - 48', 1802 lbs.
 48 - 70', 1019 lbs.

CLIENT: Pardee Homes					PROJECT: Skyline Ranch			W.O.: 8838.002	
LOCATION: Santa Clarita					ELEVATION: 1836'			DATE: 9/14/06	
RIG TYPE: 24" Bucket					HAMMER WEIGHTS: Kelly Bar Weights			DROP: 12"	
N	U	B	M	DD	DESCRIPTION			ATTITUDES	
0					Landslide Debris: Brown to dark brown fine grained sandy silty CLAY, poorly graded, hard, moist, slightly plastic, upper 1' is dry.				
5		X			@3' - Yellowish brown subangular to subrounded coarse grained gravel CONGLOMERATE with slightly friable silty fine to coarse sand matrix, well graded, dense, dry.			@3' Approx. BN54E/20SE	
10					@7.5' - Sharp, irregular, scoured contact with yellowish brown silty fine grained SAND with angular to subangular fine gravel and sparse medium to coarse sand, poorly graded, very dense, moist, occasional dry white carbonate stringers, subvertical to subhorizontal.			@7.5' Approx. CN87W/12SW	
15					@11' - 3" thick light yellowish brown silty fine to medium grained SAND layer. @11.5' - Discontinuous 3" thick clayey SILT to silty CLAY, irregular upper and lower contacts, medium plastic. @13.5' - Abruptly grades to cobble to boulder CONGLOMERATE with fine to coarse sand matrix, well graded, very dense, moist, predominantly massive.			@13.5' Approx. BN65E/17NW	
20									
25	2/5	C		14.4	118.4		@22' - Sheared contact to 1/2" to 1" thick dark yellowish brown CLAY, highly plastic, waxy, corn flaky texture, grades to dark yellowish brown clayey SILT, poorly graded, hard, moist. @24' - Dark yellowish brown clayey SILT, poorly graded, hard, moist.	@22' Sheared contact N63W/11SW	
30	3/11	C		16.3	114.4		@27' - Grades to clayey silty fine to coarse grained SAND with subrounded fine gravel. @28' - Irregular, slightly scoured contact to fine to coarse grained sandy clayey SILT, poorly graded, hard, moist. @29' - Sheared upper contact to strong brown 1/4" to 1" thick CLAYSTONE, highly plastic, waxy, corn flaky texture. @30' - Yellowish brown silty fine to medium grained SANDSTONE, poorly graded, very dense, moist. @30.5' - Grades to clayey silty fine to medium grained SAND, poorly graded, very dense, moist, slightly plastic. @34' - Grades to yellowish brown subrounded fine grained gravel CONGLOMERATE with clayey silty fine to coarse sand matrix, well graded, very dense, moist to very moist, highly channelized. @35.5' - Sharp, irregular slightly scoured contact to dark yellowish brown clayey silty fine grained SAND, poorly graded, very dense, moist, slightly plastic. @39.8' - 2-5" thick olive brown fine to coarse grained SAND with subrounded fine gravel in clayey silty fine grained SAND from 35.5'.	@28' C N52W/20SW @29' S N39W/8SW @35.5' C N42W/13SW @39.8' B N41W/13SW	
35									
40									
45									

ADDITIONAL COMMENTS: Blows per 6"
 C = Modified California Sampler
 Kelly Bar Weights: 0 - 25', 2854 lbs.
 25 - 48', 1802 lbs.
 48 - 70', 1019 lbs.

CLIENT: Pardee Homes					PROJECT: Skyline Ranch			W.O.: 8838.002
LOCATION: Santa Clarita					ELEVATION: 1836'			DATE: 9/14/06
RIG TYPE: 24" Bucket					HAMMER WEIGHTS: Kelly Bar Weights			DROP: 12"
N	U	B	M	DD	DESCRIPTION			ATTITUDES
40							@41.5' - Abruptly grades to olive brown subangular to subrounded gravel CONGLOMERATE with slightly friable clayey silty fine to coarse sand matrix, well graded, very dense, moist.	@42' B N34W/15SW
45	12-6"	C	X	10.9	116.0		@43' - Slightly scoured, sharp contact to dark yellowish brown fine grained sandy clayey SILT, poorly graded, hard, moist, slightly plastic. @44' - 1/4" thick strong brown CLAY, highly plastic, sheared on upper contact, waxy, corn flaky, bedding below this point is well defined. @44.5' - <u>Saugus Formation</u> : Olive brown silty fine grained SANDSTONE, poorly graded, very dense, moist, weakly cemented between many discontinuous lenses of this material and dark yellowish brown fine grained sandy clayey SILTSTONE. @45' - Olive brown clayey fine grained sandy SILTSTONE to silty fine grained SANDSTONE, poorly graded, very dense, moist, grades to subangular to subrounded gravel CONGLOMERATE with olive silty fine sand matrix. @45.8' - Grades to olive brown gravel to cobble CONGLOMERATE with silty fine to coarse sand matrix, well graded, hard, moist. @46.8' - Slightly scoured contact to olive fine to coarse grained SANDSTONE, hard, moist, slightly friable to friable. @48.5' - Grades to olive fine to coarse grained SANDSTONE with 20% subrounded fine gravel. @53.5' - Grades to olive fine grained gravel CONGLOMERATE with fine to coarse sand matrix, well graded, hard, moist. @55' - Olive cobble CONGLOMERATE with fine to coarse sand matrix, well graded, hard, moist. @56' - Olive brown gravel to cobble CONGLOMERATE with fine to coarse sand matrix, well graded, hard, moist.	@43' C N33W/12SW @46' B N41W/15SW @49.5' B N14W/8SW @53' B N55W/18SW
50								
55								
60								
65								
70							Total Depth - 60' No groundwater No caving Backfilled	
75								
80								
85								
ADDITIONAL COMMENTS:					Blows per 6" C = Modified California Sampler Kelly Bar Weights: 0 - 25', 2854 lbs. 25 - 48', 1802 lbs. 48 - 70', 1019 lbs.			

CLIENT: Pardee Homes					PROJECT: Skyline Ranch			W.O.: 8838.002	
LOCATION: Santa Clarita					ELEVATION: 1713'			DATE: 9/20/06	
RIG TYPE: 24" Bucket					HAMMER WEIGHTS: Kelly Bar Weights			DROP: 12"	
	N	U	B	M	DD	DESCRIPTION			ATTITUDES
0						Landslide Debris?: Soil formation, dark brown, blocky and fractured, dry, roots to 3'.			@1.5' B N31W/9SW
						@1' - Olive green silty fine grained SAND with 2" thick gravel CONGLOMERATE layer at base, poorly graded, very dense, moist.			@3.5' B N40W/10SW
5						@1.5' - Yellowish brown silty fine grained SAND with pervasive carbonate stringers, poorly graded, moist, pervasively fractured.			
						@3.5' - Yellowish brown silty fine grained SAND mottled with material from 1'.			
			X			@5' - Yellowish brown fine grained sandy SILT with sparse medium to coarse sand, poorly graded, very dense, moist, slightly friable, slightly plastic.			
						@8' - Grades to olive yellow silty fine grained SAND, poorly graded, very dense, moist.			
10						@9.5' - 10% subangular fine to coarse grained GRAVEL with trace subangular small cobbles.			@11' B N13W/12SW
						@11' - Grades to olive yellow gravel to cobble CONGLOMERATE with fine to coarse sand matrix, well graded, very dense, moist, slightly friable.			@13.5' B N70E/16NW
15	8-6"			5.0	115.8	@12' - Pale yellow silty fine to medium grained SAND, poorly graded, very dense, moist, slightly friable.			@16' B N22E/9NW
						@13' - Grades to fine to coarse grained SAND.			
						@14' - Grades to fine to coarse grained SAND with abundant fine to coarse gravel.			
20						@14.5' - 3-4" thick gravel CONGLOMERATE interbed.			
						@15' - Light yellowish brown fine to coarse grained SAND with 30% angular to subangular fine gravel and trace subangular cobbles, very dense, moist.			@22.5' B N36W/8SW
						@18.5' - Grades to yellowish brown subangular to subrounded gravel to cobble CONGLOMERATE with fine to coarse sand matrix, well graded, very dense, moist, slightly friable.			
25						@20-22' - Boulders. Refusal on boulder.			
30						Total Depth - 27.5' No groundwater No caving Backfilled			
35									
40									
45									
ADDITIONAL COMMENTS:					Blows per 6" C = Modified California Sampler Kelly Bar Weights: 0 - 25', 2854 lbs. 25 - 48', 1802 lbs.				

CLIENT: Pardee Homes					PROJECT: Skyline Ranch		W.O.: 8838.002
LOCATION: Santa Clarita					ELEVATION: 1752'		DATE: 9/19/06
RIG TYPE: 24" Bucket					HAMMER WEIGHTS: Kelly Bar Weights		DROP: 12"
	N	U	B	M	DD	DESCRIPTION	ATTITUDES
0						Landslide Debris?: Strong brown silty fine to medium grained SAND, poorly graded, loose, moist, dry in upper 6", roots to 4', slightly friable.	
						@2' - Grades to irregular contact with yellowish brown angular to subrounded fine gravel CONGLOMERATE with slightly friable fine to coarse sand matrix, well graded, loose, moist, thickness irregular and bedding interrupted by jumbled pockets of silty sandy material from above and below.	@3' C
5						@3' - Slightly scoured contact to strong brown silty fine to medium grained SAND, poorly graded, loose, moist, slightly friable.	N8W/26SW
						@3.5' - 3" thick dark brown silty CLAY, poorly graded, very stiff, moist, grades to strong brown silty fine to medium grained SAND with subangular fine gravel and sparse sand, poorly graded, dense, moist, slightly friable.	@3.5' Approx.
						@6.5' - Grades to strong brown subangular to subrounded gravel CONGLOMERATE with clayey sand matrix.	BN10W/25SW
10			X			@7' - Pale brown loose clay in matrix.	@7' B
						@9' - Slightly scoured contact with brown fine grained sandy clayey SILTSTONE, poorly graded, stiff, moist.	N2E/19SW
15						@10' - Dark yellowish brown CLAY, poorly graded, very moist, highly plastic, upper inch is sheared, corn flaky texture, waxy, laminated.	@9' C
	2/7-5" C			16.7	114.3	@10.5' - Grades to dark grayish brown fine to coarse grained sandy CLAY with trace subangular to subrounded fine gravel, poorly graded, stiff, moist.	N19W/12SW
20						@12' - Yellowish brown very clayey fine to coarse grained SAND with 20% to 30% subangular gravel, moderately graded, medium dense to dense, moist.	@10' S
						@14' - Gravel to cobble (angular to subangular) in clay, disturbed (mottled appearance).	N32W/17SW
						@15' - Pale brown clayey silty fine to coarse grained SAND with angular to subangular fine gravel, moderately graded, moist, dense to very dense, slightly friable.	
25						@16.5' - Olive green silty fine to medium grained SAND, poorly graded, very dense, moist, slightly friable.	@17' B
						@17' - Grades to subrounded fine gravel CONGLOMERATE with fine to coarse sand matrix, well graded, very dense, moist, slightly friable.	N17W/6SW
						@17.5' - Slightly scoured contact with strong brown fine grained sandy clayey SILTSTONE, poorly graded, hard, moist, weakly indurated.	@17.5' C
30						@18.5' - Mottled strong brown and pale brown fine grained sandy SILTSTONE, poorly graded, moist, overlying olive green clayey silty fine to coarse grained SAND with channeled pockets of subangular to subrounded fine gravel CONGLOMERATE.	N35W/10SW
						@21' - Strong brown clayey silty fine grained SAND, poorly graded, very dense, moist.	@19' C
35						@23' - Olive green clayey silty fine to coarse grained SAND.	N35W/12SW
						@24' - Strong brown clayey silty fine grained SAND, poorly graded, very dense, moist.	@21' C
						@26' - Olive green very silty fine grained SAND, poorly graded, very dense, moist.	N44W/10SW
						@27' - Grades to olive green silty fine to medium grained SAND with subangular fine gravel and sparse coarse sand;.	@23' C/B
40						@27.5' - Cobbles.	N48W/9SW
						Total Depth - 28', refusal on boulder	@24' C
						No groundwater. No caving	N84W/8SW
45						Backfilled	
ADDITIONAL COMMENTS:						Blows per 6"	
						C = Modified California Sampler	
						Kelly Bar Weights: 0 - 25', 2854 lbs.	
						25 - 48', 1802 lbs.	

CLIENT: Pardee Homes					PROJECT: Skyline Ranch			W.O.: 8838.002	
LOCATION: Santa Clarita					ELEVATION: 1804'			DATE: 9/20/06	
RIG TYPE: 24" Bucket					HAMMER WEIGHTS: Kelly Bar Weights			DROP: 12"	
N	U	B	M	DD	DESCRIPTION			ATTITUDES	
0					<p><u>Saugus Formation</u>: Dark brown soil formation, moist.</p> <p>@1.5' - Yellowish brown subangular to subrounded cobble CONGLOMERATE with slightly friable silty fine sand matrix with sparse coarse sand, well graded, moist, medium dense, roots to 4'.</p>				
5								@7' B N19E/7NW	
10									
15	4/8	C	7.8	123.7	<p>@15' - Yellowish brown subangular to subrounded gravel CONGLOMERATE with slightly friable silty fine to coarse sand matrix, well graded, hard, moist.</p>			@17.5' Approx. BN75W/15SW	
20					<p>@20' - Yellowish brown subangular to subrounded gravel CONGLOMERATE with slightly friable silty fine to coarse sand matrix, well graded, hard, moist.</p>				
25									
30	4/18	C	6.7	117.2	<p>@28' - Grayish brown subangular to subrounded cobble CONGLOMERATE with slightly friable clayey silty fine to coarse sand matrix, well graded, hard, moist.</p> <p>@31' - Pale brown to yellowish brown subangular to subrounded cobble CONGLOMERATE with slightly friable clayey silty fine to coarse sand matrix, well graded, hard, moist.</p>				
35					<p>@35' - <u>Mint Canyon Formation</u>: Sharp scoured contact with yellowish brown fine grained sandy SILTSTONE, poorly graded, hard, moist, weakly indurated, sheared upper contact and shear in upper inch making material soft and slightly friable.</p>			@35' CN6E/17NW SN22E/32NW	
40					<p>@37' - Grades to olive brown subangular to subrounded cobble CONGLOMERATE, slightly friable clayey silty fine to coarse sand matrix, hard, moist, well graded.</p>			@39' Approx. BN2W/11W	
45									
ADDITIONAL COMMENTS:					<p>Blows per 6"</p> <p>C = Modified California Sampler</p> <p>Kelly Bar Weights: 0 - 25', 2854 lbs.</p> <p> 25 - 48', 1802 lbs.</p> <p> 48 - 70', 1019 lbs.</p> <p> 70 - 95', 1491 lbs.</p>				

CLIENT: Pardee Homes					PROJECT: Skyline Ranch		W.O.: 8838.002
LOCATION: Santa Clarita					ELEVATION: 1804'		DATE: 9/20/06
RIG TYPE: 24" Bucket					HAMMER WEIGHTS: Kelly Bar Weights		DROP: 12"
	N	U	B	M	DD	DESCRIPTION	ATTITUDES
40							
45	5/15	C		7.3	119.9	@45' - Olive brown subangular to subrounded cobble CONGLOMERATE with slightly friable clayey silty fine to coarse sand matrix, hard, moist, well graded, overlying light gray fine grained sandy SILTSTONE, poorly graded, weakly indurated, hard, moist.	
50						@50' - Sharp scoured contact with gray very silty fine grained SANDSTONE, poorly graded, very dense, moist, weakly indurated. @50.5' - Clay healed fracture, 1/2mm thick, highly plastic, moist. @52' - Grades to CONGLOMERATE. @54' - 8-10" thick interbed of silty fine to medium grained SANDSTONE, poorly graded, weakly indurated, cross-bedded, roughly horizontal, very dense, moist, to olive brown subangular to subrounded cobble CONGLOMERATE with slightly friable clayey silty fine to coarse sand matrix, well graded, hard, moist.	@50' C N80W/15SW @50.5' FR N31E/14SE
55							
60							
65						@63' - Olive brown subangular to subrounded cobble CONGLOMERATE with slightly friable clayey silty fine to coarse sand matrix, well graded, hard, moist.	
70	15-6"	C		11.6	105.1	@70' - Brown clayey SILTSTONE, poorly graded, hard, moist, weakly indurated. @73' - Olive brown subangular to subrounded cobble CONGLOMERATE with slightly friable silty fine to coarse sand matrix, well graded, hard, moist. @77' - Matrix grades to clayey silty fine to medium sand with sparse coarse sand.	@68' B N10E/17NW @70.5' C N2E/12NW
75							
80						Total Depth - 78' No groundwater Minor caving from 17-22' Backfilled	
85							
ADDITIONAL COMMENTS:							Blows per 6" C = Modified California Sampler Kelly Bar Weights: 0 - 25', 2854 lbs. 25 - 48', 1802 lbs. 48 - 70', 1019 lbs. 70 - 95', 1491 lbs.

SUBSURFACE DATA

LOG OF BORING B77

CLIENT: Pardee Homes						PROJECT: Skyline Ranch		W.O.: 8838
LOCATION: Santa Clarita						ELEVATION: 1933'		DATE: 4/9/07
RIG TYPE: 24" Bucket						HAMMER WEIGHTS: Kelly Bar Weights		DROP: 12"
	N	U	B	M	DD	DESCRIPTION		ATTITUDES
0						Saugus Formation: Topsoil.		
						@1' - Yellowish subrounded gravel to cobble CONGLOMERATE with silty fine to coarse sandstone matrix with clay, well graded, moist.		@3' B
						@2' - Pale brown subrounded cobble CONGLOMERATE with fine to coarse sandstone matrix, graded, moist, very dense, slightly friable.		N37W/16SW
5								@6' B
						@8' - Yellowish brown subrounded gravel to cobble CONGLOMERATE with silty fine to coarse sandstone matrix with clay, well graded, very dense, moist.		N25E/25NW
10	4/4	X		6.6	115.6			@13.5' B
								N14W/16SW
15						@16' - Pale brown subrounded gravel to cobble CONGLOMERATE with silty fine to coarse sandstone matrix, graded, moist, very dense, slightly friable.		@18' Approx.
								BN7W/15SW
20	5/6	X		9.3	120.3	@20' - Yellowish brown subrounded gravel to cobble CONGLOMERATE with silty fine to coarse sandstone matrix with clay, well graded, very dense, moist, slightly friable.		@22.5' Channel
						@22.5' - Sharp, slightly scoured contact to yellowish brown clayey fine to coarse grained SANDSTONE, poorly graded, dense, moist, slightly plastic, massive, slightly friable.		N72W/13SW
25						@24' - Grades to pale brown silty fine to coarse grained SANDSTONE with subrounded gravels and cobbles, well graded, very dense, moist, slightly friable.		@25' Approx.
						@29.5' - Irregular, gradational, bedding parallel contact to fine to coarse grained SANDSTONE with gravel, graded, very dense, moist, slightly friable.		BN21E/14SE
30						@31' - Scoured contact to yellowish brown silty fine to medium grained SANDSTONE, poorly graded, very dense, moist, slightly friable.		@30' Approx.
						@33.5' - 1-3" thick fine gravel bed.		BN24E/8SE
35						@34.5' - Gradational contact to dark yellowish brown fine to medium grained sandy SILTSTONE, poorly graded, hard, moist, massive, weakly indurated.		@33.5' Approx.
						@37.5' - Pale brown subrounded gravel CONGLOMERATE with silty fine to coarse sandstone matrix, well graded, moist, massive, slightly friable.		B Horizontal
40	8/13	X		6.8	123.8			@34.5' Approx.
								Channel
								N45W/10SW
45								@37.5' C
								N20E/10NW
								@39.5' B
								N17E/8NW

ADDITIONAL COMMENTS: Kelly Bar Weights: 0 - 30', 5916 lbs.
 31 - 60', 3745 lbs.
 61 - 90', 2280 lbs.
 91 - 120', 1223 lbs.
 Blows per 12" unless otherwise noted

SUBSURFACE DATA

LOG OF BORING B77

CLIENT: Pardee Homes					PROJECT: Skyline Ranch			W.O.: 8838
LOCATION: Santa Clarita					ELEVATION: 1933'			DATE: 4/9/07
RIG TYPE: 24" Bucket					HAMMER WEIGHTS: Kelly Bar Weights			DROP: 12"
	N	U	B	M	DD	DESCRIPTION		ATTITUDES
40								
						@42.5' - Grades to silty SANDSTONE with fine gravel, graded, very dense, moist, massive, slightly friable.		
45						@44' - Grades to yellowish brown subrounded gravel to cobble CONGLOMERATE with silty fine to coarse sandstone matrix with clay, well graded, moist, 10% greater than 8" diameter cobbles.		@45' - Channel N72W/9NE
						@45' - Slightly scoured contact to 1' thick SANDSTONE bed, then grades back to CONGLOMERATE.		
50	7/12	X			13.5	118.1	@50' - Sharp, slightly scoured contact to reddish brown clayey SILTSTONE with fine to medium sand, poorly graded, hard, moist, slightly plastic, massive.	@49' B N22E/11NW @50' Approx. Channel Horizontal
							@55' - Grades to silty SANDSTONE with clay, poorly graded, very dense, moist, slightly friable, slightly plastic.	@56' B N2E/17NW
55							@55.5' - Grades to yellowish brown gravel CONGLOMERATE with trace cobbles.	
							@57.5' - Slightly scoured contact to pale brown to yellowish brown SANDSTONE with gravel, massive, with occasional orange weathering stains along bedding.	@61' B N18E/11NW
60	9/15	X			7.4	121.7	@59' - Grades to pale brown subrounded gravel to cobble CONGLOMERATE with silty fine to coarse sandstone matrix, well graded, dense, moist.	@62' Channel N44W/11NE
							@62' - Scoured contact to dark yellowish brown fine grained sandy SILTSTONE, poorly graded, moist, massive, slightly friable, contact scoured 1' in east quadrant, 1-2" thick sand lenses at 62.5'.	
65							@64' - 10" thick lenticular channel sand in SE quadrant.	
							@65.5' - 4" thick channel sand in SW quadrant.	
70							@68.5' - Grades to dark yellowish brown gravel to cobble CONGLOMERATE with fine to coarse sandstone matrix, graded, very dense, moist, slightly friable.	@70' B N15W/12SW
							@69.5' - Slightly scoured contact to pale brown SANDSTONE with interbedded gravel CONGLOMERATE.	@71.5' Channel N11W/8SW
75							@71.5' - Scoured contact to yellowish brown clayey SANDSTONE, poorly graded, very dense, moist, slightly plastic, contact scoured 1' in west half of boring.	@75' B N16E/12NW
							@73.5' - Grades to 15" thick gravel CONGLOMERATE, then irregular scoured contact to thinly bedded to laminated SANDSTONE with 2-3" thick gravel interbeds.	@78.5' B N18E/10NW
80	15-6"	X			8.0	112.1		
85								
ADDITIONAL COMMENTS:					Kelly Bar Weights: 0 - 30', 5916 lbs. 31 - 60', 3745 lbs. 61 - 90', 2280 lbs. 91 - 120', 1223 lbs. Blows per 12" unless otherwise noted			

CLIENT: Pardee Homes						PROJECT: Skyline Ranch			W.O.: 8838		
LOCATION: Santa Clarita						ELEVATION: 1933'			DATE: 4/9/07		
RIG TYPE: 24" Bucket						HAMMER WEIGHTS: Kelly Bar Weights			DROP: 12"		
	N	U	B	M	DD	DESCRIPTION			ATTITUDES		
80						<p>@82' - Sharp, slightly scoured contact to clayey SILTSTONE with fine sand and gravel, poorly graded, hard, moist, medium plastic. @84' - Grades to yellowish brown subrounded gravel to cobble CONGLOMERATE with silty fine to coarse sandstone matrix, well graded, moist.</p> <p>@88' - Slightly scoured contact to silty CLAYSTONE with fine sand, poorly graded, very stiff, moist, medium plastic, massive. @89.5' - Grades to clayey SANDSTONE with gravel and silt. @90' - Grades to dark yellowish brown clayey SILTSTONE with fine sand, poorly graded, moist. @92' - Grades to 6" thick clayey SANDSTONE with gravel and silt.</p> <p>@95' - Dark yellowish brown fine to medium grained sandy SILTSTONE with clay, poorly graded, moist, slightly plastic. @96' - Dark yellowish brown silty fine to coarse grained SANDSTONE with clay, poorly graded, moist. @96'4" - 1/2" to 2" thick dark yellowish brown CLAYSTONE, sheared, waxy, fractured, highly plastic, seep along top of clay bed from the south quadrant causing surrounding clayey sandstone to run. @96.5' - Dark yellowish brown clayey fine to coarse grained SANDSTONE with silt, poorly graded, very dense, moist. @101' - Pale brown fine to coarse grained SANDSTONE with subrounded gravel, poorly graded, moist. @103' - Pale brown and yellowish brown subrounded gravel to cobble CONGLOMERATE with silty fine to coarse sandstone matrix, well graded, moist.</p> <p>Total Depth - 105' Seep at 96.5' No caving</p>			<p>@82' Channel N4W/15SW @84' Approx. Channel N53W/10NE @88' Channel N16W/10SW @96'4" Shear N6W/9SW</p>		
85											
90											
95											
100											
105											
110											
115											
120											
125											

ADDITIONAL COMMENTS: Kelly Bar Weights: 0 - 30', 5916 lbs.
 31 - 60', 3745 lbs.
 61 - 90', 2280 lbs.
 91 - 120', 1223 lbs.
 Blows per 12" unless otherwise noted

SUBSURFACE DATA

LOG OF BORING B78

CLIENT: Pardee Homes					PROJECT: Skyline Ranch		W.O.: 8838
LOCATION: Santa Clarita					ELEVATION: 1963'		DATE: 4/10/07
RIG TYPE: 24" Bucket					HAMMER WEIGHTS: Kelly Bar Weights		DROP: 12"
N	U	B	M	DD	DESCRIPTION		ATTITUDES
0					Saugus Formation: Topsoil.		
					@1' - Yellowish brown subangular to subrounded gravel CONGLOMERATE with fine to coarse sandstone matrix and occasional cobbles, graded, very dense, moist.		
5					@2.5' - Dark yellowish brown fine to coarse grained sandy CLAYSTONE with angular to subangular gravel, poorly graded, hard, moist, weakly cemented.		
					@6' - Grades to yellowish brown fine grained sandy SILTSTONE with gravel, poorly graded, very stiff, moist, massive, slightly friable, caliche.		
10					@9' - Gradational contact to pale brown gravel to cobble CONGLOMERATE with fine to coarse sandstone matrix, graded, very dense, moist, slightly friable, upper 2 feet has cobble-boulder sized siltstone inclusions from above with caliche.		@9' Approx. Contact N58W/9SW
15							
							@17' Approx. BN26W/13SW
20	6/9-3" X		7.5	121.0	@20' - Yellowish brown subangular to subrounded gravel CONGLOMERATE with silty fine to coarse sandstone matrix with clay, well graded, very dense, moist, slightly friable.		@19' B N18W/12SW
					@23.5' - 1' thick silty fine grained SANDSTONE bed, poorly graded, very dense, moist, slightly friable, massive.		
25							@26.5' Channel N68E/8SE
							@28.5' B N23W/7SW
30					@31.5' - Sharp slightly scoured contact to yellowish brown silty fine grained SANDSTONE, poorly graded, very dense, moist, massive, slightly friable.		@31.5' Channel N5E/9NW
					@33.5' - Grades to pale brown gravel CONGLOMERATE with cobbles and cobble-sized sandstone pockets.		
35							@36' B N19W/12SW
40	5/12-5" X		12.5	117.5	@41' - Slightly scoured contact to dark yellowish brown clayey fine to coarse grained SANDSTONE with silt and gravel, graded, very dense, moist, slightly plastic, massive.		@41' Channel N28W/9SW
45							
ADDITIONAL COMMENTS:					Kelly Bar Weights: 0 - 30', 5916 lbs. 31 - 60', 3745 lbs. 61 - 90', 2280 lbs. 91 - 120', 1223 lbs. Blows per 12" unless otherwise noted		

SUBSURFACE DATA

LOG OF BORING B78

CLIENT: Pardee Homes					PROJECT: Skyline Ranch			W.O.: 8838
LOCATION: Santa Clarita					ELEVATION: 1963'			DATE: 4/10/07
RIG TYPE: 24" Bucket					HAMMER WEIGHTS: Kelly Bar Weights			DROP: 12"
N	U	B	M	DD	DESCRIPTION			ATTITUDES
40					<p>@42.5' - Grades to brown subangular to subrounded gravel to cobble CONGLOMERATE with fine to coarse sandstone matrix, graded, very dense, moist, slightly friable.</p>			
45					<p>@45' - 1' thick brown fine to coarse grained SANDSTONE with subangular to subrounded fine gravel, poorly graded, moist.</p>			@45.5' B N34E/10NW
50					<p>@52' - Brown fine to coarse grained SANDSTONE with gravel, poorly graded, moist.</p>			@51' B N22W/9SW
55					<p>@55' - Grades to yellowish brown gravel to cobble CONGLOMERATE with fine to coarse sandstone matrix, graded, very dense, moist.</p>			
60	20-6"	X			7.4	99.5		@60' B N7W/4SW
65								@64.5' Approx. BN60E/11NW
70								@70' Approx. BN54W/7SW
75								@76' B N2E/5NW
80	22-6"	X			8.3	106.2		
85								
ADDITIONAL COMMENTS:					<p>Kelly Bar Weights: 0 - 30', 5916 lbs. 31 - 60', 3745 lbs. 61 - 90', 2280 lbs. 91 - 120', 1223 lbs.</p> <p>Blows per 12" unless otherwise noted</p>			

CLIENT: Pardee Homes					PROJECT: Skyline Ranch		W.O.: 8838
LOCATION: Santa Clarita					ELEVATION: 1963'		DATE: 4/10/07
RIG TYPE: 24" Bucket					HAMMER WEIGHTS: Kelly Bar Weights		DROP: 12"
N	U	B	M	DD	DESCRIPTION	ATTITUDES	
80					@81' - Yellowish brown subangular to subrounded gravel to cobble CONGLOMERATE with clayey fine to coarse sandstone matrix, well graded, moist, slightly plastic, massive, occasional channels.		
85							
90					@90' - 3" thick light orange tan fine to medium grained SANDSTONE, poorly graded, very dense, moist, lenticular, discontinuous, uncemented. @90'3" - Light brown gravelly SANDSTONE with occasional pebbles and cobbles, poorly cemented.	@90' Approx BN43W/7SW @93'9" Channel Horizontal	
95					@90.5' - Pale brown medium grained SANDSTONE with sparse gravel, slightly friable. @93'9" - Sharp undulatory contact to dark yellowish brown fine grained sandy SILTSTONE with clay, poorly graded, hard, moist, massive, weakly indurated.		
100	30-6" X		11.7	111.3	@100.5' - Dark yellowish brown silty fine to coarse grained SANDSTONE to fine to coarse grained sandy SILTSTONE, graded, very dense to hard, moist, weakly indurated, massive, occasional gravel stringers.	@100.5' B N9W/13SW	
105					@105' - 1-2" thick dark yellowish brown CLAYSTONE, highly plastic, medium stiff, seep out of N quadrant above bed. @105'2" - Brown clayey SILTSTONE, poorly graded, stiff, moist, massive.	@105' B N3W/9SW	
110							
115					Total Depth - 109' Seep at 105' No caving		
120							
125							
ADDITIONAL COMMENTS:					Kelly Bar Weights: 0 - 30', 5916 lbs. 31 - 60', 3745 lbs. 61 - 90', 2280 lbs. 91 - 120', 1223 lbs. Blows per 12" unless otherwise noted		

CLIENT: Pardee Homes					PROJECT: Skyline Ranch			W.O.: 8838
LOCATION: Santa Clarita					ELEVATION: 2055'			DATE: 4/12/07
RIG TYPE: 24" Bucket					HAMMER WEIGHTS: Kelly Bar Weights			DROP: 12"
	N	U	B	M	DD	DESCRIPTION		ATTITUDES
0						Saugus Formation: Dark yellowish brown fine to medium grained sandy CLAYSTONE with angular to subrounded gravel and trace cobbles, graded, moist, medium plastic, caliche.		
						@2' - Yellowish brown silty fine to coarse grained SANDSTONE with clay and subangular fine gravel, graded, dense, moist, slightly friable, subvertical caliche.		
5						@4'3" - Grades to dark yellowish brown silty CLAYSTONE, poorly graded, hard, moist, weakly cemented, nonplastic, waxy, subhorizontal caliche.		
						@5.5' - Grades to yellowish brown fine grained sandy SILTSTONE, poorly graded, very stiff, moist, slightly friable, subvertical caliche.		@8' Channel
						@6'9" - Grades to pale brown fine to coarse grained SANDSTONE with subangular to subrounded gravel, graded, very dense, moist, slightly friable to friable, inconsistent bed thicknesses.		Horizontal
10						@8' - Slightly scoured contact to yellowish brown clayey SILTSTONE with fine sand, poorly graded, very stiff, moist, slightly plastic, subvertical caliche.		@10'4" Approx Channel
						@9'3" - Grades to yellowish brown silty fine SANDSTONE with clay and subangular to subrounded fine gravel, graded, very dense, moist, slightly friable, subvertical caliche.		Horizontal
15						@9'9" - Grades to subangular to subrounded fine gravel CONGLOMERATE with clayey fine sandstone matrix, well graded, very dense, moist, slightly friable.		
						@10'4" - Slightly scoured contact to yellowish brown fine grained sandy SILTSTONE, poorly graded, hard, moist, massive, subvertical caliche, randomly grades to silty CLAYSTONE with fine sand and clayey fine to medium grained SANDSTONE with silt, all beds irregular and massive with gradational contacts.		@18.5' Approx Channel
20	13-6"	X		5.6	125.8	@17.5' - Grades to dark yellowish brown clayey fine to medium grained SANDSTONE with silt, poorly graded, very dense, moist, slightly friable.		N1W/7SW
						@18.5' - Grades to yellowish brown fine to coarse grained SANDSTONE, poorly graded, very dense, slightly friable to friable, moist, 6-12" thick lenticular subrounded to subangular fine gravel CONGLOMERATE channels & 1-2" thick lenticular discontinuous fine grained sandy SILTSTONE inclusions with remnant very thinly laminated bedding.		@21'3" Channel
25						@21'3" - Slightly scoured contact to yellowish brown fine grained sandy SILTSTONE with clay, poorly graded, medium stiff, moist, slightly friable.		N29W/10SW
						@22.5' - Sharp irregular scoured contact to dark yellowish brown fine grained sandy CLAYSTONE, poorly graded, medium stiff, moist, medium plastic.		
						@24.5' - Grades to dark yellowish brown clayey fine to medium grained SANDSTONE with silt and subangular to subrounded fine gravel, graded, very dense, moist, slightly plastic.		@29' Channel
30						@28' - Grades to yellowish brown subangular to subrounded fine gravel CONGLOMERATE with fine to coarse sandstone matrix, abundant coarse sand, graded, very dense, moist, slightly friable to friable, massive.		N44W/8SW
						@29' - Sharp, slightly scoured contact to yellowish brown fine grained sandy SILTSTONE with trace subangular to subrounded fine gravel, poorly graded, medium stiff, moist.		@33' Approx. Channel
						@29.5' - Grades to dark yellowish brown fine to medium grained sandy CLAYSTONE with trace subangular fine gravel, poorly graded, medium stiff, moist, medium plastic.		N29W/3SW
35						@31.5' - Grades to yellowish brown clayey fine grained SANDSTONE with silt and trace subangular fine gravel.		
40	5/13"	X		11.6	123.9			
45								
ADDITIONAL COMMENTS:						Kelly Bar Weights: 0 - 30', 5916 lbs. 31 - 60', 3745 lbs. 61 - 90', 2280 lbs. 91 - 120', 1223 lbs. Blows per 12" unless otherwise noted		

CLIENT: Pardee Homes					PROJECT: Skyline Ranch			W.O.: 8838
LOCATION: Santa Clarita					ELEVATION: 2055'			DATE: 4/12/07
RIG TYPE: 24" Bucket					HAMMER WEIGHTS: Kelly Bar Weights			DROP: 12"
	N	U	B	M	DD	DESCRIPTION		ATTITUDES
40						@32.5' - Grades to yellowish brown subangular to subrounded gravel CONGLOMERATE with clayey fine sandstone matrix with silt, well graded, very dense, moist, slightly friable. @33' - Sharp, slightly scoured contact to yellowish brown clayey SILTSTONE with fine sand.		@41.5' Shear N24W/9SW
45						@34' - Grades to dark yellowish brown fine to medium grained sandy CLAYSTONE with trace subangular fine gravel, poorly graded, medium stiff, moist, medium plastic. @34.5' - Grades to yellowish brown silty fine grained SANDSTONE with clay, dense, moist, slightly friable. @40' - Grades abruptly to pale brown fine to coarse grained SANDSTONE with 1-2" of subangular fine gravel CONGLOMERATE at base, massive, slightly friable to friable, inconsistent thickness around boring. @40.5' - Slightly scoured contact to yellowish brown fine grained SILTSTONE, very stiff, moist, slightly friable. @41' - Grades to dark yellowish brown silty CLAYSTONE with fine sand, medium stiff, medium plastic, sheared lower contact, shear planes are less than 1mm thick, discontinuous, highly plastic and waxy.		@42.5' Channel N33W/5SW
50						@41.5' - Sheared contact to yellowish brown clayey fine to medium grained SANDSTONE with trace subangular fine gravel, graded, dense, moist, slightly plastic. @41'8" - Grades to dark yellowish brown silty CLAYSTONE with fine sand, medium stiff, medium plastic. @42' - Grades to yellowish brown fine to coarse grained SANDSTONE with subangular to subrounded fine gravel, gravel concentration increases towards bottom of bed. @42.5' - Slightly scoured contact to fine to medium grained sandy CLAYSTONE with silt, medium stiff, moist, slightly plastic. @43' - Grades to clayey fine to medium grained SANDSTONE with silt. @43.5' - Grades to dark yellowish brown CLAYSTONE, medium stiff, medium plastic. @45' - Grades to dark yellowish brown fine grained sandy CLAYSTONE, medium stiff, medium plastic.		@48' Approx. Channel Horizontal @49' Approx. BN40W/9SW
55						@47' - Grades to subangular to subrounded fine gravel CONGLOMERATE with trace cobbles and silty fine to coarse sandstone matrix, well graded, very dense, moist, slightly friable, massive, more coarse at base. @48' - Slightly scoured contact to yellowish brown silty fine to medium grained SANDSTONE, dense, moist, slightly friable. @49' - 6" thick pale brown silty fine grained SANDSTONE bed with subrounded fine gravel at base. @49.5' - Grades to yellowish brown fine grained sandy SILTSTONE, poorly graded, medium stiff, moist, massive.		@55' B N40W/8SW @55'3" Channel N40W/13SW
60		X		10.0	115.6	@55' - Grades abruptly to lenticular pale brown fine to coarse grained SANDSTONE with subangular fine gravel, slightly friable to friable. @55'3" - Slightly scoured contact to fine to medium grained sandy CLAYSTONE with silt, very stiff, moist, medium plastic. @56' - Grades to yellowish brown clayey fine to medium grained SANDSTONE. @57'2" - Grades to yellowish brown fine grained sandy SILTSTONE.		@57'8" B N30W/4SW @63' B N2W/4SW @63.5' Channel N32W/9SW
65								
70								
75								
80	15-5"	X		9.3	107.0			
85								
ADDITIONAL COMMENTS:						Kelly Bar Weights: 0 - 30', 5916 lbs. 31 - 60', 3745 lbs. 61 - 90', 2280 lbs. 91 - 120', 1223 lbs. Blows per 12" unless otherwise noted		

CLIENT: Pardee Homes					PROJECT: Skyline Ranch					W.O.: 8838
LOCATION: Santa Clarita					ELEVATION: 2055'					DATE: 4/12/07
RIG TYPE: 24" Bucket					HAMMER WEIGHTS: Kelly Bar Weights					DROP: 12"
N	U	B	M	DD	DESCRIPTION					ATTITUDES
80					@57'8" - 2" thick dark yellowish brown CLAYSTONE, highly plastic, waxy, non-sheared, soft. @57'10" - Sharp contact to dark yellowish brown fine to medium grained sandy CLAYSTONE with trace subangular gravel. @60' - Grades abruptly to yellowish brown gravel to cobble CONGLOMERATE with clayey fine to coarse sandstone matrix, well graded, very dense, moist, slightly friable to weakly cemented. @62' - Yellowish brown fine to coarse grained SANDSTONE with gravel interbeds. @63.5' - Slightly scoured contact to yellowish brown clayey SILTSTONE with fine sand and trace gravels to cobbles, medium stiff, moist. @67' - Abruptly grades to pale brown angular to subrounded gravel to cobble CONGLOMERATE with boulders and clayey siltstone matrix with fine sand, well graded, very dense, moist, slightly friable. @75.5' - Slightly scoured contact to pale brown silty fine to medium grained SANDSTONE, poorly graded, very dense, moist, massive, slightly friable. @77' - Grades back to pale brown angular to subrounded gravel to cobble CONGLOMERATE with boulders and clayey siltstone matrix with fine sand, well graded, very dense, moist, slightly friable.					
85										
90										
95										
100					Total Depth - 90' No groundwater No caving					
105										
110										
115										
120										
125										
ADDITIONAL COMMENTS:					Kelly Bar Weights: 0 - 30', 5916 lbs. 31 - 60', 3745 lbs. 61 - 90', 2280 lbs. 91 - 120', 1223 lbs. Blows per 12" unless otherwise noted					

SUBSURFACE DATA

LOG OF BORING B80

CLIENT: Pardee Homes					PROJECT: Skyline Ranch			W.O.: 8838	
LOCATION: Santa Clarita					ELEVATION: 1814'±			DATE: 7/31/07	
RIG TYPE: 24" Bucket					HAMMER WEIGHTS: Kelly Bar Weights			DROP: 12"	
	N	U	B	M	DD	DESCRIPTION		ATTITUDES	
0						Topsoil: Dark brown fine to coarse grained sandy CLAY, graded, hard (sun baked), dry, roots, blocky peds.			
5						@1' - <u>Landslide Debris</u> : Brown, yellowish brown, and dark brown clayey fine to coarse grained SAND to fine to coarse grained sandy CLAY with subangular to subrounded fine gravel, well graded, medium dense to dense (with depth), moist, nonplastic to slightly plastic, mottled appearance.			
	4/4	C		17.0	111.4	@5' - Yellowish brown clayey fine to coarse grained SAND with subangular to subrounded gravel, and trace cobbles, well graded, medium dense, moist, pockets of orangish brown fine grained sandy CLAY with silt.			
10						@9.3' - Abrupt, slightly wavy contact to dark yellowish brown fine to coarse grained sandy CLAY with subangular to subrounded fine gravel, moderately well graded, very stiff, moist, medium plastic.		@9.3' C	
						@12.5' - Mottled with pockets of yellowish brown clayey fine to medium grained SAND.		N20W/21SW	
	5/7	C		11.9	125.9	@13.7' - Yellowish brown clayey fine to coarse grained SAND with silt and gravel, well graded, dense, moist, slightly plastic, with subvertical veins of disseminated organics surrounded by olive brown fine grained sandy silt.			
15						@15' - Very dense, end olive brown silt veins.			
20						@22' - Dark brown fine to coarse grained sandy SILT, graded, hard, moist, massive, weakly cemented, appears undisturbed (no mottled appearance, cementation without fractures).			
	4/6	C		14.3	120.6	@24' - Silty fine to coarse grained SAND with gravel, well graded, very dense, moist, slightly friable, iron staining, looks disturbed.			
25						@27' - Mottled with olive green clayey SILT, abundant gravel.			
						@28' - Mottled yellowish brown and olive brown silty GRAVEL with sand, well graded, very dense, moist, clasts subangular to subrounded.			
30	6/9-3"	C		16.8	115.5	@30' - <u>Saugus Formation</u> : Gradational contact to olive brown subangular to subrounded cobble CONGLOMERATE with silty fine to coarse grained sandstone matrix, well graded, very dense, moist, slightly friable, clasts to 11" in largest dimension, occasionally interbedded with silty SANDSTONE, weakly cemented, beds approximately 8" thick.		@33' Approx. Channel N80E/15SE	
35									
40						Total Depth - 35', refusal on boulder No groundwater No caving Backfilled			
45									

ADDITIONAL COMMENTS: C = Modified California Sampler
 Kelly Bar Weights: 0 - 30', 5,619 lbs.
 31 - 60', 3,745 lbs.
 61 - 90', 2,280 lbs.
 91 - 120', 1,223 lbs.

SUBSURFACE DATA

LOG OF BORING B81

CLIENT: Pardee Homes					PROJECT: Skyline Ranch			W.O.: 8838
LOCATION: Santa Clarita					ELEVATION: 1882'±			DATE: 8/1/07
RIG TYPE: 24" Bucket					HAMMER WEIGHTS: Kelly Bar Weights			DROP: 12"
	N	U	B	M	DD	DESCRIPTION		ATTITUDES
0						<p><u>Topsoil</u>: Dark brown fine to coarse grained sandy SILT with gravel and cobbles, well graded, hard (sun baked), dry, roots, weakly cemented.</p> <p>@1.5' - <u>Landslide Debris</u>: Dark brown fine to coarse grained sandy GRAVEL with cobbles and clay, well graded, very dense, moist, clasts angular to subrounded.</p>		
5						<p>@3.5' - Pale brown silty fine to medium grained SAND with gravel and cobbles, well graded, very dense, moist, massive, slightly friable, clasts angular to subrounded.</p> <p>@5' - Grades to yellowish brown fine to coarse grained sandy GRAVEL with cobbles and silt, well graded, dense, moist, clasts angular to subrounded.</p>		
10	4/5	C		7.6	113.4	<p>@10' - Scoured contact to 6" thick dark yellowish brown fine grained sandy SILT, graded, stiff, moist, medium plastic, scoured out in places, with sparse coarse sand sized carbonate nodules.</p> <p>@10.5' - Sharp, wavy contact to yellowish brown fine to coarse grained SAND with angular to subangular gravel, well graded, dense, moist, slightly friable.</p>		@10.5' C N1W/27SW
15	3/5	C		9.5	119.9	<p>@12' - Grades to fine to coarse grained sandy GRAVEL with cobbles, massive.</p> <p>@18' - Scoured contact to dark yellowish brown fine to coarse grained sandy CLAY, graded, stiff, moist, medium plastic, some mud ripups entrained in lower 2-3" of overlying sand bed, massive, mm thick caliche veins.</p> <p>@20' - Multiple waxy shear surfaces in a 1/2-2" thick highly plastic clay zone around boring, scoured out in places, shear surfaces laterally discontinuous, caliche veins thicken to 3/8" thick just above zone.</p>		@15' Approx. BN61E/19NW
20	2/2	C		17.8	108.1	<p>@21' - Abrupt contact to dark yellowish brown clayey fine to coarse grained SAND with gravel.</p> <p>@22' - Dark yellowish brown fine to coarse grained sandy CLAY, graded, stiff, moist, medium plastic.</p> <p>@22'8" - Caliche veins to 1/2" thick.</p> <p>@23' - Dark yellowish brown silty CLAY with sparse fine to coarse sand, graded, very stiff to hard, moist, weakly indurated, pervasively fractured.</p>		@18' C N42E/14NW
25						<p>@24' - End caliche.</p> <p>@25' - <u>Saugus Formation</u>: Contact to silty fine grained SANDSTONE, somewhat poorly graded, very dense, moist, weakly indurated, massive.</p> <p>@27'-28' - Gravel to cobble sized pockets of caliche.</p>		@28' C N18W/15SW
30	5/6	C		4.4	119.7	<p>@28' - Grades to yellowish brown fine to coarse grained SANDSTONE with subangular to subrounded gravel, well graded, very dense, moist, slightly friable to friable, massive.</p> <p>@30.5' - Scoured contact to clayey SILTSTONE with sparse fine to coarse sand, somewhat poorly graded, very stiff to hard, moist, weakly indurated, massive.</p>		@30.5' Ch N41W/13SW
35	12-6"	C		7.8	114.2	<p>@34' - Grades to clayey fine to coarse grained SANDSTONE with silt and gravel, well graded, very dense, moist, massive.</p> <p>@38' - 3-6" thick gravel bed, scoured contact to dark yellowish brown fine grained sandy SILTSTONE, weakly indurated.</p> <p>@38'9" - Grades to clayey fine to medium grained SANDSTONE with silt.</p> <p>@39'3" - Grades to clayey fine to medium grained SANDSTONE with silt and gravel.</p>		@38' B N24W/9SW
40								
45								
ADDITIONAL COMMENTS:						<p>C = Modified California Sampler</p> <p>Kelly Bar Weights: 0 - 30', 5,619 lbs. 31 - 60', 3,745 lbs. 61 - 90', 2,280 lbs. 91 - 120', 1,223 lbs.</p>		

SUBSURFACE DATA

LOG OF BORING B81

CLIENT: Pardee Homes					PROJECT: Skyline Ranch		W.O.: 8838
LOCATION: Santa Clarita					ELEVATION: 1882'±		DATE: 8/1/07
RIG TYPE: 24" Bucket					HAMMER WEIGHTS: Kelly Bar Weights		DROP: 12"
	N	U	B	M	DD	DESCRIPTION	ATTITUDES
40						@41.5' - 6" thick gravel bed, channel deposit, wet. @42' - Grades to clayey fine to medium grained SANDSTONE with silt. @43' - Grades to clayey fine to medium grained SANDSTONE with silt and gravel. @44'9" - Grades to yellowish brown subangular to subrounded gravel to cobble CONGLOMERATE with fine to coarse sandstone matrix, well graded, very dense, wet, slightly friable. @46.5' - Grades to yellowish brown fine to coarse grained SANDSTONE with gravel, moist.	@41.5' Ch N39E/6SE @44'9" Approx. ChN11W/6SW
	10-6"	C		8.7	126.1		
45							
	10-6"	C		9.4	111.1		
50							
55						Total Depth - 50' No groundwater No caving Backfilled	
60							
65							
70							
75							
80							
85							
ADDITIONAL COMMENTS: C = Modified California Sampler Kelly Bar Weights: 0 - 30', 5,619 lbs. 31 - 60', 3,745 lbs. 61 - 90', 2,280 lbs. 91 - 120', 1,223 lbs.							

SUBSURFACE DATA

LOG OF BORING B82

CLIENT: Pardee Homes					PROJECT: Skyline Ranch		W.O.: 8838
LOCATION: Santa Clarita					ELEVATION: 1910'±		DATE: 8/1/07
RIG TYPE: 24" Bucket					HAMMER WEIGHTS: Kelly Bar Weights		DROP: 12"
N	U	B	M	DD	DESCRIPTION		ATTITUDES
0					<p>Topsoil: Dark brown fine to coarse grained sandy SILT with gravel, graded, hard (sun baked), dry, roots, weakly cemented.</p> <p>@1' - Landslide Debris: Dark yellowish brown silty fine to coarse grained SAND with gravel and cobbles to 5" in maximum dimension, well graded, very dense, moist, weakly cemented.</p> <p>@3.5' - Yellowish brown cobbly GRAVEL with sand and clay, well graded, medium dense, dry, friable, roots, clasts to 9" in maximum dimension, average 3-6", massive.</p>		
5							
10	3/5	C	8.8	119.3	<p>@11'8" - Yellowish brown silty fine to medium grained SAND with sparse coarse sand and fine gravel, graded, very dense, moist, massive.</p>		@11'8" C N49W/13SW
15					<p>@14' - 6" thick lenticular, discontinuous channel sand in south quadrant: pale brown fine to coarse grained SAND with trace gravel at base.</p> <p>@16.5' - Abrupt, irregular, contact to pale brown fine to coarse grained SAND with subangular gravel, well graded, very dense, moist, slightly friable, weathered orange after 5", discontinuous reddish brown lenses of clayey fine to coarse grained SAND, channel slump offsets contact.</p>		@16.5' Approx. ChN41W/30NE
20	2/5	C	14.8	116.1	<p>@17' - Channel slump, 4-8" normal displacement, cannot trace failure in silty sand above or through sand at 16.5' (no fractures), minor carbonate traces along channel in west wall.</p> <p>@22' - Scoured contact to 1-6" thick (average 4-5" thick) dark yellowish brown very silty fine to medium grained SAND with sparse coarse sand and fine gravel, graded, medium dense, moist, slightly plastic, 8" offset in southeast wall.</p>		@17' Ch N44W/66SW
25					<p>@24' - Scoured irregular contact to reddish brown clayey fine to coarse grained SAND.</p>		@27' S Horizontal
30	4/4	C	12.1	122.3	<p>@24'9" - Grades to pale brown trace clayey fine to coarse grained SAND.</p> <p>@27' - 1/2"-1" thick dark yellowish brown CLAY, sheared, slightly cornflaky, highly plastic, wavy contacts, no slickenlines.</p>		
35					<p>@27'1" - Saugus Formation: Dark yellowish brown clayey SILSTONE with fine sand, somewhat poorly graded, hard, moist, weakly indurated.</p> <p>@31' - Grades to silty fine to coarse grained SANDSTONE.</p>		@32.5' B N44E/7NW
40	5/8	C	19.5	111.3	<p>@32' - Grades to yellowish brown fine to coarse grained SANDSTONE with subangular to subrounded fine gravel, moderately well graded, very dense, moist, slightly friable, poorly bedded.</p> <p>@32'8" - 2" thick SILTSTONE bed.</p> <p>@33'2" - Slightly scoured contact to clayey SILTSTONE, poorly graded, hard, moist, weakly indurated, massive.</p>		
45	5/8	C	13.0	118.6	<p>@40' - Dark yellowish brown fine grained sandy SILTSTONE with clay, somewhat poorly graded, hard, moist, weakly indurated, over silty fine to coarse grained SANDSTONE with clay and subangular fine gravel, graded, very dense, moist.</p>		
ADDITIONAL COMMENTS:					<p>C = Modified California Sampler</p> <p>Kelly Bar Weights: 0 - 30', 5,619 lbs. 31 - 60', 3,745 lbs. 61 - 90', 2,280 lbs. 91 - 120', 1,223 lbs.</p>		

SUBSURFACE DATA

LOG OF BORING B82

CLIENT: Pardee Homes						PROJECT: Skyline Ranch			W.O.: 8838			
LOCATION: Santa Clarita						ELEVATION: 1910'±			DATE: 8/1/07			
RIG TYPE: 24" Bucket						HAMMER WEIGHTS: Kelly Bar Weights			DROP: 12"			
	N	U	B	M	DD	DESCRIPTION			ATTITUDES			
40						@43' - Abundant fine gravel. @44' - Grades to pale brown gravel CONGLOMERATE with fine to coarse sandstone matrix, well graded, very dense, moist, slightly friable. @46' - Slight scoured contact to clayey SILTSTONE, poorly graded, hard, moist, massive, weakly indurated. @50' - Dark yellowish brown silty fine to coarse grained SANDSTONE with gravel, well graded, very dense, moist to wet, massive. Total Depth - 50' No groundwater No caving Backfilled						
45												
50	5/11	C		7.8	125.4							
55												
60												
65												
70												
75												
80												
85												
ADDITIONAL COMMENTS:									C = Modified California Sampler Kelly Bar Weights: 0 - 30', 5,619 lbs. 31 - 60', 3,745 lbs. 61 - 90', 2,280 lbs. 91 - 120', 1,223 lbs.			

SUBSURFACE DATA

LOG OF BORING B83

CLIENT: Pardee Homes					PROJECT: Skyline Ranch			W.O.: 8838	
LOCATION: Santa Clarita					ELEVATION: 1783'±			DATE: 8/2/07	
RIG TYPE: 24" Bucket					HAMMER WEIGHTS: Kelly Bar Weights			DROP: 12"	
	N	U	B	M	DD	DESCRIPTION		ATTITUDES	
0						<p>Topsoil: Dark brown fine to coarse grained sandy SILT with gravel, well graded, soft, dry, slightly friable.</p> <p>@1' - <u>Landslide Debris</u>: Yellowish brown fine to coarse grained sandy GRAVEL with silt, well graded, very dense, moist, subangular to subrounded clasts to 2", weakly cemented.</p>			
5						<p>@5' - Slightly friable, clasts to 5", occasional 1/4" thick caliche veins.</p>		@4' B N13W/8SW	
	4/7	C		11.0	118.2	<p>@8' - Scoured sharp contact to brown silty fine grained SAND, poorly graded, very dense, moist, weakly indurated, pervasive subvertical caliche filled fractures.</p>		@8' C N18E/14NW	
10						<p>@9' - Grades to pale brown to yellowish brown fine to coarse grained sandy GRAVEL with trace cobbles, well graded, very dense, moist, slightly friable, poorly bedded-massive, clasts subangular to subrounded to 5", occasional boulder sized silty fine grained SAND pockets.</p>		@9.5' B N48E/13NW	
15	3/7	C		4.5	127.1				
						<p>@18' - Abrupt, scoured contact to mottled olive gray silty CLAY with fine to coarse sand, and yellowish brown silty fine to coarse grained SAND with clay, very stiff to dense, moist, massive.</p>			
20						<p>@21.5' - In south quadrant discontinuous shear on 1/4" thick olive gray clay, highly plastic, corn flaky, waxy, material below shear even more mottled, poorly graded to graded, hard, moist, massive.</p>			
	3/5	C		17.1	112.6	<p>@23.5'-25' - Nested gravels to 3" in maximum dimension.</p>			
25						<p>@26.5'-28' - Iron staining.</p>			
	3/6	C		10.4	116.9	<p>@28' - Olive gray fine to coarse grained sandy GRAVEL with clay, well graded, very dense, moist, slightly plastic, clasts subangular to subrounded to 4" in maximum dimension.</p>			
30						<p>@30' - Highly scoured contact to yellowish brown silty fine grained SAND, poorly graded, very dense, moist, massive, weakly indurated.</p>		@30'1" Approx. SN15E/14SE	
						<p>@30'1" - Shear on 1/4" thick olive gray CLAY, highly plastic, slight corn flaky texture, follows trace of scouring but 1-2" below contact.</p>		@31'9" S N10E/5NW	
35						<p>@31'9" - <u>Saugus Formation</u>: Sheared contact on 1/16" to 1" thick dark yellowish brown CLAY, highly plastic, corn flaky, below shear dark yellowish brown silty CLAYSTONE with fine sand, somewhat poorly graded, hard, moist, massive.</p>		@32'8" C N32W/11SW	
	11-6"	C		12.4	111.2	<p>@32'8" - Sharp contact to gray silty fine grained SANDSTONE, poorly graded, very dense, moist, massive.</p>			
40						<p>@36' - Grades to yellowish brown silty fine to coarse grained SANDSTONE with fine gravel, well graded, very dense, moist, slightly friable.</p>			
						<p>@36.5' - Grades to yellow silty fine to medium grained SANDSTONE, slightly friable.</p>			
45						<p>@38.5' - Trace gravel.</p>			

ADDITIONAL COMMENTS: C = Modified California Sampler
 Kelly Bar Weights: 0 - 30', 5,619 lbs.
 31 - 60', 3,745 lbs.
 61 - 90', 2,280 lbs.
 91 - 120', 1,223 lbs.

SUBSURFACE DATA

LOG OF BORING B83

CLIENT: Pardee Homes					PROJECT: Skyline Ranch		W.O.: 8838
LOCATION: Santa Clarita					ELEVATION: 1783'±		DATE: 8/2/07
RIG TYPE: 24" Bucket					HAMMER WEIGHTS: Kelly Bar Weights		DROP: 12"
	N	U	B	M	DD	DESCRIPTION	ATTITUDES
40						@39.5' - Grades to yellowish brown fine to coarse grained SANDSTONE with abundant gravel, well graded, very dense, moist, massive, slightly friable. Total Depth - 50' No groundwater No caving Backfilled	
	8-6"	C		17.2	---		
45							
50							
55							
60							
65							
70							
75							
80							
85							

ADDITIONAL COMMENTS: C = Modified California Sampler
 Kelly Bar Weights: 0 - 30', 5,619 lbs.
 31 - 60', 3,745 lbs.
 61 - 90', 2,280 lbs.
 91 - 120', 1,223 lbs.

SUBSURFACE DATA

LOG OF BORING B84

CLIENT: Pardee Homes					PROJECT: Skyline Ranch			W.O.: 8838
LOCATION: Santa Clarita					ELEVATION: 1714'±			DATE: 8/3/07
RIG TYPE: 24" Bucket					HAMMER WEIGHTS: Kelly Bar Weights			DROP: 12"
	N	U	B	M	DD	DESCRIPTION		ATTITUDES
0						Topsoil: Dark brown fine to coarse grained sandy SILT with gravel and cobbles to 5" in maximum dimension, well graded, hard, dry-moist (with depth), weakly cemented, roots, blocky peds.		
5						@3' - Saugus Formation: Pale brown fine to coarse grained SANDSTONE with abundant subangular to subrounded fine gravel and trace cobbles to 10" (average 3-5") with gravel interbeds, well graded, dense, moist, slightly friable, poorly bedded-massive, weathered slightly.		@4' B N23W/13SW
	6-8"	C		6.4	113.3	@7' - Unweathered.		@8' B N69W/15SW
10						@9' - Trace fine gravel sized nodules of disseminated organics.		
	9-6"	C		6.2	110.6			@13' B N47W/14SW
15						@17.5' - 12" thick gravel CONGLOMERATE with fine to coarse sandstone matrix.		
	6-6"	C		5.6	117.2	@18.5' - Slightly scoured contact to fine to coarse grained SANDSTONE with gravel, black silt bedding traces.		@19.5' B N39W/6SW
20						@20' - Grades to yellowish brown gravel to cobble CONGLOMERATE with fine to coarse sandstone matrix, well graded, very dense, moist, massive, subangular to subrounded clasts to 6".		
						@24' - 12-14" boulder.		
25								
30								
35								
40						@40' - Matrix orangish brown fine to coarse sandstone with clay.		
45								

ADDITIONAL COMMENTS: C = Modified California Sampler
 Kelly Bar Weights: 0 - 30', 5,619 lbs.
 31 - 60', 3,745 lbs.
 61 - 90', 2,280 lbs.
 91 - 120', 1,223 lbs.

SUBSURFACE DATA

LOG OF BORING B84

CLIENT: Pardee Homes					PROJECT: Skyline Ranch			W.O.: 8838
LOCATION: Santa Clarita					ELEVATION: 1714'±			DATE: 8/3/07
RIG TYPE: 24" Bucket					HAMMER WEIGHTS: Kelly Bar Weights			DROP: 12"
	N	U	B	M	DD	DESCRIPTION		ATTITUDES
40						@42.5' - Slightly scoured contact to 3-5" thick gray silty fine to medium grained SANDSTONE bed, poorly graded, very dense, moist. @43' - Grades to yellowish brown gravel to cobble CONGLOMERATE with fine to coarse sandstone matrix, well graded, very dense, moist, massive, subangular to subrounded clasts. @44' - 2' thick boulder around circumference of boring. Total Depth - 53' No groundwater No caving Backfilled		@42.5' B N24W/15SW
45								
50								
55								
60								
65								
70								
75								
80								
85								

ADDITIONAL COMMENTS: C = Modified California Sampler
 Kelly Bar Weights: 0 - 30', 5,619 lbs.
 31 - 60', 3,745 lbs.
 61 - 90', 2,280 lbs.
 91 - 120', 1,223 lbs.

SUBSURFACE DATA

LOG OF BORING B85

CLIENT: Pardee Homes					PROJECT: Skyline Ranch		W.O.: 8838
LOCATION: Santa Clarita					ELEVATION: 1978'±		DATE: 8/6/07
RIG TYPE: 24" Bucket					HAMMER WEIGHTS: Kelly Bar Weights		DROP: 12"
	N	U	B	M	DD	DESCRIPTION	ATTITUDES
0						Topsoil: Very dark brown silty SAND with subangular to subrounded gravel and clay, well graded, dense, dry to moist with depth, porous to 2mm in upper foot.	
5						@5' - <u>Landslide Debris</u> : Brown clayey fine to coarse grained SAND with abundant gravel and cobbles, well graded, medium dense to dense, moist, massive, clasts subangular to subrounded to 7" in maximum dimension.	
6/6	C			20.8	107.8		
10						@11' - Yellowish brown gravelly fine to coarse grained SAND with cobbles and clay, well graded, loose to medium dense, moist, massive, slightly friable, clasts subangular to subrounded to 5" in maximum dimension.	@13' C
15	4/5	C		15.5	118.3	@13' - Extremely scoured contact to dark yellowish brown silty fine to coarse grained SAND with clay, graded, loose to medium dense, moist, massive, slightly plastic, mottled with pale brown fine to coarse grained SAND with gravel and dark yellowish brown silty CLAY, soft to indurated.	N65W/47SW
20						@17'9" - Wavy, sheared contact to pale brown fine to coarse grained sandy GRAVEL with silt, well graded, very dense, moist, massive, slightly friable, shear on dark yellowish brown CLAY, 1-5" thick, highly plastic, waxy, cornflaky.	@17'9" S
8-6"	C			3.2	117.7	@18.5' - <u>Saugus Formation</u> : Sheared contact to dark yellowish brown silty fine to medium grained SANDSTONE, poorly graded, very dense, moist, weakly indurated in places, shear on 1/16-1" thick CLAY, highly plastic, waxy, cornflaky.	N20W/11SW
25						@20' - 1-2" thick pale brown gravelly SANDSTONE interbed.	@18.5' S
4/6	C			5.8	123.8	@21' - Grades to pale brown gravelly SANDSTONE, moderately well graded, very dense, moist, slightly friable to friable, poorly bedded to massive.	N27W/7SW
30						@24' - Grades to pale brown gravel CONGLOMERATE with fine to coarse sandstone matrix.	@20' B
10-6"	C			8.6	121.3	@27' - Matrix orange clayey fine to coarse grained sandstone.	N51W/8SW
35						@30.5' - Grades back to gravelly fine to coarse grained SANDSTONE.	@21' C
10-6"	C			11.1	117.1	@31' - Wet.	N66W/7SW
40						@32.5' - Sharp, slightly scoured contact to dark yellowish brown silty CLAYSTONE, poorly graded, hard, moist, slightly plastic, weakly indurated.	@22' B
45						@33'8" - Shear on 1/16-3/8" thick dark yellowish brown CLAYSTONE, soft, highly plastic, slight cornflaky texture.	N42W/19SW
						@34' - Grades to dark yellowish brown silty fine to coarse grained SANDSTONE with gravel, well graded, very dense, wet, massive.	@25.5' B
						Total Depth - 41.5'	N13W/21SW
						No groundwater	
						No caving	
						Backfilled	

ADDITIONAL COMMENTS:

C = Modified California Sampler
 Kelly Bar Weights: 0 - 30', 5,619 lbs.
 31 - 60', 3,745 lbs.
 61 - 90', 2,280 lbs.
 91 - 120', 1,223 lbs.

SUBSURFACE DATA

LOG OF BORING B86

CLIENT: Pardee Homes					PROJECT: Skyline Ranch		W.O.: 8838
LOCATION: Santa Clarita					ELEVATION: 1915'±		DATE: 8/8/07
RIG TYPE: 24" Bucket					HAMMER WEIGHTS: Kelly Bar Weights		DROP: 12"
	N	U	B	M	DD	DESCRIPTION	ATTITUDES
0						Topsoil: Dark brown silty fine to coarse grained SAND with subangular to subrounded fine gravel, moderately well graded, very dense (sun baked), dry, roots	
5						@2.5' - <u>Landslide Debris</u> : Dark brown silty fine to coarse grained SAND with subangular to subrounded fine gravel, moderately well graded, dense, moist, massive, weakly cemented.	
	3/5	C		9.9	121.6	@5' - Dark brown clayey fine to coarse grained SAND with subangular to subrounded fine gravel and trace cobbles to 8", slightly plastic.	
						@8' - Brown silty fine to coarse grained SAND with gravel and trace cobbles, well graded, medium dense, moist, slightly friable.	
10						@9' - Yellowish brown.	
						@12.5' - Mottled with orangish brown fine grained sandy SILT, poorly graded, medium stiff, moist.	
	4/8	C		10.4	121.2	@14' - Yellowish brown silty fine to coarse grained SAND with gravel and trace cobbles, well graded, medium dense, moist, slightly friable.	
15						@17' - Yellowish brown silty fine to coarse grained SAND with gravel and orange clay.	
						@21' - Mottled with dark yellowish brown silty CLAY with fine sand, poorly graded, soft, wet, highly plastic.	
	3/3	C		15.1	118.5	@23' - Dark yellowish brown silty CLAY with fine sand, poorly graded, medium stiff, moist, massive, medium to highly plastic, internally sheared, shears discontinuous and multidirectional.	
25						@27' - 1/8" to 1/2" thick dark yellowish brown CLAY, highly plastic, slightly cornflaky, shear truncates several other shears oriented approximately N15W/21NE; sheared contact to yellowish brown silty fine grained SAND, poorly graded, very dense, moist, weakly indurated, cross-bedded, multiple cross-cutting sheared contacts to pale brown fine to coarse grained SAND with trace fine gravel, graded, very dense, moist, slightly friable.	@27' S N84E/16NW
	2/3	C		22.2	103.9	@32' - Lowest laterally continuous shear on 1/4" to 1/2" thick clay, slight cornflaky texture.	@28' Approx. SN15W/26NE
30						@33' - Slightly scoured contact to 3" to 4" thick very dark brown silty CLAY with sparse fine to coarse sand, somewhat poorly graded, hard, moist, indurated, pervasively fractured with mm scale discontinuous internal shears on highly plastic clay.	@32' Approx. SN24E/5SE
	4/9	C		13.9	120.5	@33'3" - <u>Saugus Formation</u> : Gradational contact to yellowish brown clayey fine to coarse grained SANDSTONE with trace fine gravel and dark yellowish brown silty CLAYSTONE with fine sand, graded, very dense to hard, moist, slightly friable to weakly indurated, massive.	@33' Approx. BN14E/9SE
40	10-6"	C		14.7	120.1	@40' - Dark yellowish brown silty fine grained SANDSTONE to fine grained sandy SILTSTONE, somewhat poorly graded, very dense to hard, moist, weakly indurated.	
45							
ADDITIONAL COMMENTS:							Total Depth - 40', No groundwater, No caving, Backfilled
							C = Modified California Sampler
							Kelly Bar Weights: 0 - 30', 5,619 lbs.
							31 - 60', 3,745 lbs.
							61 - 90', 2,280 lbs.
							91 - 120', 1,223 lbs.

CLIENT: Pardee Homes					PROJECT: Skyline Ranch			W.O.: 8838
LOCATION: Santa Clarita					ELEVATION: 1835'±			DATE: 8/8/07
RIG TYPE: 24" Bucket					HAMMER WEIGHTS: Kelly Bar Weights			DROP: 12"
N	U	B	M	DD	DESCRIPTION			ATTITUDES
0					Topsoil: Very dark brown fine to coarse grained sandy CLAY with silt, graded, hard (sun baked), dry to moist (with depth), weakly cemented, roots, fractured and blocky in upper foot.			
5					@2.5' - <u>Terrace Deposits</u> : Gradational contact to yellowish brown silty fine to coarse grained SAND with fine subangular to subrounded gravel, graded to well graded, dense, moist, massive.			
					@4' - Extremely irregular and scoured contact to dark yellowish brown silty CLAY with sparse fine to coarse sand and trace fine gravel, graded, very stiff, moist, pervasively fractured, pervasive carbonate stringers.			@7' C N28E/28NW
10					@5'5' - Grades to yellowish brown silty fine to coarse grained SAND with abundant gravel, well graded, very dense, moist, with mottled pockets of dark yellowish brown silty CLAY.			
					@7' - Sharp, slightly scoured contact to dark brown silty CLAY, poorly graded, very stiff, moist, pervasively fractured, internally sheared, carbonate stringers and gravel-sized pockets, mottled with fine to medium sand from 8-9', slightly to medium plastic.			@12'3" C N25W/8SW
15					@12'3" - <u>Weathered Saugus Formation</u> : Sheared contact to mottled yellowish brown silty fine to coarse grained SANDSTONE with gravel and dark yellowish brown silty CLAYSTONE with fine sand, graded to well graded, very dense to hard, moist, massive.			@13.5' C Horizontal
					@12'3" - <u>Weathered Saugus Formation</u> : Sheared contact to mottled yellowish brown silty fine to coarse grained SANDSTONE with gravel and dark yellowish brown silty CLAYSTONE with fine sand, graded to well graded, very dense to hard, moist, massive.			@15' B N42W/5SW
20					@13.5' - Gradational contact to pale brown gravel CONGLOMERATE with silty fine to coarse sandstone matrix, well graded, very dense, moist, poorly bedded to massive, mottled with discontinuous and scoured out gray and orange silty fine to medium grained SANDSTONE beds.			@20'3" Approx BN11E/5SE
					@15' - Boulders.			
25					@16.5' - Reddish orange gravel to boulder CONGLOMERATE with fine to coarse sandstone matrix, well graded, very dense, dry, friable, massive.			
					@18.5' - Boulder (1.5' thick).			
					@20' - <u>Saugus Formation</u> : Pale brown gravel to cobble CONGLOMERATE with silty fine to coarse sandstone matrix with clay, well graded, very dense, moist, massive to poorly bedded.			
30								
35					Total Depth - 27', Refusal on boulder			
					No groundwater			
					No caving			
					Backfilled			
40								
45								
ADDITIONAL COMMENTS:					C = Modified California Sampler Kelly Bar Weights: 0 - 30', 5,619 lbs. 31 - 60', 3,745 lbs. 61 - 90', 2,280 lbs. 91 - 120', 1,223 lbs.			

SUBSURFACE DATA

LOG OF BORING B88

CLIENT: Pardee Homes					PROJECT: Skyline Ranch					W.O.: 8838		
LOCATION: Santa Clarita					ELEVATION: 1955'±					DATE: 8/9/07		
RIG TYPE: 24" Bucket					HAMMER WEIGHTS: Kelly Bar Weights					DROP: 12"		
	N	U	B	M	DD	DESCRIPTION					ATTITUDES	
0						Topsoil: Very dark brown silty fine to coarse grained SAND with subangular fine gravel, well graded, very dense (sun baked), dry to moist with depth, weakly cemented, roots, pinhole-1mm porosity in upper foot.						
5						@2.5' - Grades to clayey fine to coarse grained SAND with 10% subangular fine gravel, well graded, dense, moist, slightly plastic.						
						@6.5' - <u>Landslide Debris</u> : Grades to yellowish brown clayey fine to coarse grained SAND with trace fine gravel, medium dense to dense, graded, moist, slightly plastic, massive, slightly friable.						
10						@8' - Abundant subangular to subrounded gravel and trace cobbles to 8".						
						@12' - Grades to yellowish brown clayey fine to coarse grained SAND with gravel.						
15						@15'2" - Discontinuous relict bedding structures (orange along-bedding weathering surfaces) but too steeply dipping to be in place (45-60°).						
20	6/7	C			13.0	118.8	@19' - Yellowish brown clayey fine to coarse grained SAND with gravel and silt, well graded, dense, moist, slightly plastic, interfingered with discontinuous relict channel deposits (medium to coarse SAND with abundant fine gravel) and subparallel, steeply dipping, orange, relict along-bedding weathering stains.					@22' B N53W/66NE
							@24' - Pale brown clayey fine to coarse grained SAND with gravel.					
25							@26.5' - Boulder sized pocket of orange very clayey SILTSTONE with fine to coarse sand, somewhat poorly graded, slight to medium plastic, moist.					@27' S N42W/65NE
							@27' - Shear along 1-3" thick bed of same material, surrounded by sand from @24'.					Slicks S85E/60
30							@29' - Sheared contact to reddish brown sandy CLAY to clayey SAND, graded, stiff to medium dense, moist, medium plastic, contact truncated by shear at 27'.					@29' S N76W/25NE
							@31.5' - Grades to yellowish brown clayey fine to coarse grained SAND with gravel.					@34.5' B N12W/16NE
35							@32.5' - Grades to dark yellowish brown fine to coarse grained sandy SILT.					@36.5' Approx CN42W/31NE
							@33.5' - Grades to pale brown sandy GRAVEL with cobbles and clay, well graded, dense, moist, massive, slightly friable.					@39' Approx CN80E/11SE
							@36.5' - Scoured contact to reddish brown fine to coarse grained sandy CLAY with silt, graded, stiff to very stiff, moist, medium plastic.					
40	4/6	C			11.4	119.9	@39' - Grades to interbedded yellowish brown silty fine to coarse grained SAND with gravel and fine to coarse grained sandy GRAVEL with silt, well graded, dense, moist, slightly plastic, slightly friable.					
45												
ADDITIONAL COMMENTS:						C = Modified California Sampler Kelly Bar Weights: 0 - 30', 5,619 lbs. 31 - 60', 3,745 lbs. 61 - 90', 2,280 lbs. 91 - 120', 1,223 lbs.						

SUBSURFACE DATA

LOG OF BORING B88

CLIENT: Pardee Homes					PROJECT: Skyline Ranch		W.O.: 8838
LOCATION: Santa Clarita					ELEVATION: 1955'±		DATE: 8/9/07
RIG TYPE: 24" Bucket					HAMMER WEIGHTS: Kelly Bar Weights		DROP: 12"
	N	U	B	M	DD	DESCRIPTION	ATTITUDES
40							
						@43' - Slightly scoured contact to dark yellowish brown fine to coarse grained sandy SILT, graded, very stiff, moist.	@43' C N25E/10SE
45						@44' - Slightly scoured contact to reddish brown silty CLAY with fine to coarse sand, graded, medium stiff, moist, medium plastic, small scale discontinuous internal shears.	@44' C N82W/5SW
50						@51' - Abruptly grades to pale brown cobbly GRAVEL with fine to coarse sand, well graded, dense, wet, friable, heavy caving to 54' (boring belled out to 5' wide).	@51' Approx. CN7E/33SE
55						@58' - Same material, heavy caving to 59' (boring belled out to 10' wide), running water.	
60	6/12-4" C			11.9	124.9	@59' - Medium to highly plastic claystone shear. @60' - <u>Saugus Formation</u> : Pale brown fine to coarse grained SANDSTONE over dark yellowish brown silty CLAYSTONE, wet.	
65						@65' - Yellowish brown clayey fine to coarse grained SANDSTONE.	
70							
75	15-4" C			15.5	---	@75' - Mottled pale brown, orange, and reddish brown silty fine to medium grained SANDSTONE, somewhat poorly graded, very dense.	
80						Total Depth - 75' Seepage at 51', groundwater at 58' Heaving caving from 51-54' and 58-59' Backfilled	
85							
ADDITIONAL COMMENTS:							C = Modified California Sampler Kelly Bar Weights: 0 - 30', 5,619 lbs. 31 - 60', 3,745 lbs. 61 - 90', 2,280 lbs. 91 - 120', 1,223 lbs.

SUBSURFACE DATA

LOG OF BORING B89

CLIENT: Pardee Homes					PROJECT: Skyline Ranch		W.O.: 8838
LOCATION: Santa Clarita					ELEVATION: 1980'±		DATE: 8/10/07
RIG TYPE: 24" Bucket					HAMMER WEIGHTS: Kelly Bar Weights		DROP: 12"
	N	U	B	M	DD	DESCRIPTION	ATTITUDES
0						Topsoil: Very dark brown silty fine to coarse grained SAND with subangular to subrounded gravel, well graded, loose to dense with depth, dry to moist with depth, porous in upper 2' (pinhole), roots in upper foot.	
5							
10	3/5	C		6.5	120.2	@9' - <u>Landslide Debris</u> : Grades to yellowish brown clayey fine to coarse grained SAND with abundant subangular to subrounded gravel and cobbles, well graded, medium dense, moist, slightly plastic, massive. @12' - No clay, slightly friable, poorly bedded to massive, discontinuous relict bedding planes defined by aligned gravels and clean sand channels.	
15							
20	4/5	C		5.8	122.9	@17' - 10" cobble.	@18' Approx. BN54W/19NE
25							
30	5/12	C		3.8	122.2	@29' - Yellowish brown clayey fine to coarse grained SAND with abundant gravel to cobbles, mottled with orange clayey SILT with fine to medium sand, well graded, medium dense to medium stiff, moist, slightly to medium plastic.	
35							
40	5/10	C		13.6	123.3	@38.5' - Scoured contact to mottled gray and orangish brown clayey fine to coarse grained SAND with gravel, well graded, medium dense, moist, slightly to medium plastic, traces of relict bedding.	@38.5' Approx CN74W/34NE
45							

ADDITIONAL COMMENTS: C = Modified California Sampler
 Kelly Bar Weights: 0 - 30', 5,619 lbs.
 31 - 60', 3,745 lbs.
 61 - 90', 2,280 lbs.
 91 - 120', 1,223 lbs.

SUBSURFACE DATA

LOG OF BORING B89

CLIENT: Pardee Homes					PROJECT: Skyline Ranch			W.O.: 8838	
LOCATION: Santa Clarita					ELEVATION: 1980'±			DATE: 8/10/07	
RIG TYPE: 24" Bucket					HAMMER WEIGHTS: Kelly Bar Weights			DROP: 12"	
	N	U	B	M	DD	DESCRIPTION		ATTITUDES	
40						@41.5' - Grades to yellowish brown clayey fine to coarse grained SAND with subangular to subrounded gravel to cobbles, well graded, medium dense, moist, slightly friable, slightly plastic.			
45						@46' - Wet. @47.5' - Caving to 3' in diameter, running sands from seep.			
50	6/12-5"	C		17.8	116.1	@50.5' - Yellowish brown clayey fine to coarse grained SAND with gravel, well graded, very dense, wet, over 1/2" thick sheared highly plastic CLAY. @51' - <u>Saugus Formation</u> : Sheared contact to reddish brown fine to coarse grained sandy CLAYSTONE, graded, hard, moist, weakly indurated, massive.		@50.5' Shear N24E/6NW	
55									
60	15-5"	C		12.5	119.6	@60' - Grades to fine to coarse grained SANDSTONE with gravel, graded, very dense, wet.			
65						Total Depth- 62' Seep at 48-50.5', groundwater at 60' Caving from 47.5-50.5' Backfilled			
70									
75									
80									
85									
ADDITIONAL COMMENTS:						C = Modified California Sampler Kelly Bar Weights: 0 - 30', 5,619 lbs. 31 - 60', 3,745 lbs. 61 - 90', 2,280 lbs. 91 - 120', 1,223 lbs.			

SUBSURFACE DATA

LOG OF BORING B90

CLIENT: Pardee Homes					PROJECT: Skyline Ranch			W.O.: 8838
LOCATION: Santa Clarita					ELEVATION: 1899'±			DATE: 8/13/07
RIG TYPE: 24" Bucket					HAMMER WEIGHTS: Kelly Bar Weights			DROP: 12"
	N	U	B	M	DD	DESCRIPTION		ATTITUDES
0						<p><u>Topsoil</u>: Dark brown clayey fine to coarse grained SAND with subangular to subrounded gravel, well graded, very dense, dry to moist with depth, weakly cemented, porous (pinhole) in upper 2', roots to 2'.</p>		
5						<p>@5' - <u>Landslide Debris</u>: Grades to yellowish brown fine to coarse grained sandy GRAVEL with silt, well graded, dense, moist, clasts subangular to subrounded.</p>		
						<p>@6' - Slightly scoured contact to dark yellowish brown silty CLAY with fine to coarse sand and trace gravel, graded, hard, moist, slightly plastic, waxy, pervasively fractured and internally sheared, caliche.</p>		@6' C N86W/17NE
10	5/8	C			12.9	119.8	<p>@8' - Grades to yellowish brown silty fine to medium grained SAND with clay and sparse coarse sand, graded, very dense, moist, weakly indurated, caliche.</p>	
							<p>@10' - Interfingering discontinuous channel lenses of fine to coarse SAND with fine gravel, slightly friable.</p>	@11.5' Approx. CN34W/4NE
							<p>@11.5' - Slightly scoured contact to dark yellowish brown silty CLAY with fine sand and nested medium to coarse grained SAND, somewhat poorly graded, hard, moist, weakly indurated, pervasively fractured.</p>	@13' F N70W/70SW
15							<p>@12' - Grades to yellowish brown silty fine to medium grained SAND, weakly indurated to slightly friable.</p>	@17' S
							<p>@12'4" - Faulted contact to dark yellowish brown CLAY, parallel to fault at 13'.</p>	N34E/18NW
20	3/4	C			8.5	123.1	<p>@13' - Faulted contact to yellowish brown fine to coarse grained sandy GRAVEL with silt, well graded, very dense, moist, slightly friable, 10" normal displacement on fault.</p>	
							<p>@15' - Scoured contact to yellowish brown silty fine to medium grained SAND, weakly indurated.</p>	
							<p>@16' - Abrupt contact to dark yellowish brown CLAY, very stiff, moist, medium plastic, waxy, sheared.</p>	@23'3" C N34W/13SW
25							<p>@17' - Shear on 1/4" to 1/2" thick highly plastic CLAY, offset by fault at 17'4".</p>	@24' S
							<p>@18.5' - Grades to dark yellowish brown clayey fine to coarse grained SAND with subangular to subrounded fine gravel, weakly indurated.</p>	N46W/13SW
							<p>@22.5' - Grades to fine to coarse grained sandy GRAVEL with silt, slightly friable.</p>	@25' S
							<p>@23'3" - Slightly scoured contact to orangish brown very silty fine to medium grained SAND.</p>	N7W/49SW
30	6/12	C			9.6	126.3	<p>@24' - Sheared contact on 1/4" to 2" thick CLAY, very stiff, moist, highly plastic, to dark yellowish brown clayey SILT with fine sand, weakly indurated.</p>	@26'8" S N13W/22SW
							<p>@25' - Shear on mm thick CLAY, stiff, moist, medium plastic, wavy.</p>	@31'2" S N1E/25NW
							<p>@26'8" - Sheared contact on 1/4" to 1" thick dark yellowish brown CLAY to pervasively sheared CLAY, medium plastic, highly plastic where sheared.</p>	
35							<p>@27'7" - Grades to yellowish brown silty fine grained SAND with clay, weakly indurated.</p>	
							<p>@28'3" - Multiple 3" thick discontinuous lenses of silty fine to coarse grained SAND, slightly friable.</p>	
40	3/6	C			17.0	113.6	<p>@30'2" - Abrupt contact to dark yellowish brown CLAY, stiff to very stiff, moist, pervasively sheared, medium plastic, highly plastic where sheared.</p>	
							<p>@31'2" - Shear on 5-7" thick dark yellowish brown highly plastic CLAY.</p>	
							<p>@31'8" - Contact to yellowish brown clayey fine grained SAND with silt and sparse medium to coarse sand and fine gravel, moderately well graded, dense, moist, slightly plastic, mottled with orange and olive brown.</p>	
45							<p>@35.5' - Abundant subangular to subrounded gravel and cobbles to 6", slightly friable.</p>	

ADDITIONAL COMMENTS:

C = Modified California Sampler
 Kelly Bar Weights: 0 - 30', 5,619 lbs.
 31 - 60', 3,745 lbs.
 61 - 90', 2,280 lbs.
 91 - 120', 1,223 lbs.

SUBSURFACE DATA

LOG OF BORING B90

CLIENT: Pardee Homes					PROJECT: Skyline Ranch					W.O.: 8838		
LOCATION: Santa Clarita					ELEVATION: 1899'±					DATE: 8/13/07		
RIG TYPE: 24" Bucket					HAMMER WEIGHTS: Kelly Bar Weights					DROP: 12"		
	N	U	B	M	DD	DESCRIPTION					ATTITUDES	
40						@39.5' - Scoured contact to mottled orangish brown and olive brown very clayey fine grained SAND with silt, medium plastic. @41' - Abundant gravel for one foot. @43' - Weakly indurated.					@39.5' Approx. CN2E/9SW	
45						@47' - Minor seep out of east quadrant to 49' through weakly indurated material.						
50	12-6"	C			13.5	123.6	@50' - Brown silty SAND to sandy SILT, poorly graded, very dense to hard, moist, weakly indurated.					
55							@54.5' - Contact to interlayered olive green and orangish brown fine to coarse grained sandy GRAVEL with silt, well graded, very dense, moist to wet where seeping, slightly friable, seep out of north quadrant to 56'.					@54.5' C N62W/9SW
60	12-4"	C			---	---	@58.5' - Subhorizontal slightly scoured contact to silty fine grained SAND with abundant medium to coarse grained SAND and subangular to subrounded fine gravel, well graded, very dense, moist, weakly indurated.					@58.5' Approx. C Horizontal
	12-6"	C			12.4	113.1	@60' - No recovery. @61.5' - Grades to fine to coarse grained sandy GRAVEL with silt, slightly friable.					@61.5' Approx. CN8W/7SW
65							@63.5' - Slightly scoured contact to gray and brown silty fine to coarse grained SAND with trace fine gravel.					@63.5' Approx. CN7W/11SW
70							@67.5' - <u>Mint Canyon Formation</u> : Gray subangular to subrounded gravel to cobble CONGLOMERATE with silty fine to coarse sandstone matrix and boulders, well graded, very dense, moist, slightly friable.					@67.5' C N10E/13NW
75							Total Depth - 73' Minor seep at 47-49' and 54.5-56' No caving Backfilled					@71' Approx. BN28E/10NW
80												
85												

ADDITIONAL COMMENTS: C = Modified California Sampler
 Kelly Bar Weights: 0 - 30', 5,619 lbs.
 31 - 60', 3,745 lbs.
 61 - 90', 2,280 lbs.
 91 - 120', 1,223 lbs.

SUBSURFACE DATA

LOG OF BORING B91

CLIENT: Pardee Homes						PROJECT: Skyline Ranch		W.O.: 8838
LOCATION: Santa Clarita						ELEVATION: 1825'±		DATE: 2/15/13
RIG TYPE: 24" Lo Drill						HAMMER WEIGHTS: Kelly Bar Weights		DROP: 18"
	N	U	B	M	DD	DESCRIPTION		ATTITUDES
0						<p>@0' - <u>Landslide Debris</u>: Orangish brown silty fine to coarse SAND with 10-20% gravel, well graded, medium dense, moist, massive, uncemented, slightly friable, no clay rinds on clasts</p>		
5								
10						<p>@9' - 1" thick discontinuous broken brown fine sandy SILT layer</p>		
15						<p>@13' - Color change to yellowish brown</p>		
20	18-18"	C	X			<p>@19.4' - Sharp contact to dark yellowish brown fine to medium sandy SILT, graded, stiff, moist, nonplastic, massive; upper one inch of layer is soft and highly plastic, no slickensides observed</p>		@19.4C (N55W/20SW)
						<p>@19.9' - 4" thick dark yellowish brown CLAY, soft, moist, highly plastic, somewhat flaky, no slickensides observed</p>		@24.2 Approx. C (N88E/7N)
25						<p>@21' - <u>Saugus Formation</u>: sharp, wavy, irregular, subhorizontal, sheared upper contact to reddish brown clayey SANDSTONE with fine gravel, well graded, hard, weakly to moderately cemented, massive</p>		
	34-18"	C				<p>@24.2' - Sharp slightly scoured contact to fine to medium sandy SILTSTONE, somewhat poorly graded, hard, moist, massive, weakly to moderately cemented, contact is very approximate and near horizontal</p>		
						<p>@24.4' - Grades down to silty fine to medium SANDSTONE</p>		
30						<p>@25.1' - Dark yellowish brown silty CLAYSTONE, poorly graded, hard, moist, nonplastic, massive, weakly to moderately cemented, some internal shearing defined by multidirectional paper thin discontinuous cross-cutting polished surfaces</p>		
	30-18"	C	X			<p>@26.4' - Claystone becomes sandy, no shearing</p>		
						<p>@27.6' - Grades to reddish brown silty fine to coarse SANDSTONE with fine gravel, well graded, hard, moist, massive, weakly to moderately cemented</p>		
35						<p>@29.4' - Abrupt gradational contact to silty fine SANDSTONE with sparse medium to coarse sand, poorly graded, hard, moist, massive, weakly to moderately cemented</p>		
	35-18"	C				<p>@31.4' - Grades to silty fine to medium SANDSTONE with sparse coarse sand, graded, hard, moist, slightly friable</p>		
40						<p>@32.7' - 35.4' - Abrupt irregular gradational upper contact to dark yellowish brown clayey SILTSTONE with fine sand, poorly graded, hard, moderately cemented, nonplastic, massive</p>		@33.1' S (N7E/8W)
45						<p>@33.1 - 2" thick CLAY, soft, highly plastic, flaky, pervasively sheared, no slickensides observed</p>		
ADDITIONAL COMMENTS:						<p>C= California Split-Barrel Sampler Kelly Bar Weights: 0-21 = 1200 lbs. 21-42 = 800 lbs. 42-70 = 600 lbs.</p>		

SUBSURFACE DATA

LOG OF BORING B91

CLIENT: Pardee Homes					PROJECT: Skyline Ranch			W.O.: 8838	
LOCATION: Santa Clarita					ELEVATION: 1825±			DATE: 2/15/13	
RIG TYPE: 24" Lo Drill					HAMMER WEIGHTS: Kelly Bar Weights			DROP: 12"	
	N	U	B	M	DD	DESCRIPTION		ATTITUDES	
40						@35.4' - Grades to sandy SILTSTONE @37.8' - Abruptly grades to silty fine to coarse SANDSTONE with gravel, well graded, hard, moist, massive, weakly cemented @38.9'-47.4' - Yellowish brown gravel CONGLOMERATE, graded, hard, moist, slightly friable, faint discontinuous black mineral laminations; 1" thick discontinuous SILTSTONE at upper contact			
45						@39.4' - 3"-6" thick dark yellowish brown clayey SILTSTONE, poorly graded, hard, weakly cemented, slightly plastic, no polished surfaces observed, upper contact slightly scoured @40.6' - 1"-3" thick clayey SILTSTONE with fine sand, poorly graded, hard, weakly cemented, nonplastic		@39.8'B (N9W/3W)	
50	38-18"	C			X	@47.4' - 50.5' - Dark yellowish brown fine sandy SILTSTONE, hard, weakly cemented, nonplastic, scoured upper contact @47.8' - 1" thick gravel interbed @48.3' - ¼" - ½" thick sheared dark yellowish brown CLAY, soft, highly plastic, moist, flaky; for 2" below clay rock has low hardness		@40.8'B (N17E/8W) @47.4' Approx. C (N12W/9W) @47.8B (N29W/9W)	
55	35-18"	C			X	@50.5' - Grades to yellowish brown clayey fine to coarse SANDSTONE with sparse fine gravel, well graded, hard, moist, weakly cemented @51.8' - Grading to coarser sand fraction with more gravel, slightly friable @52.5' - Fining; sparse gravel, weakly cemented		@48.3'S (N12W/13W) @53.2 Approx. S Horizontal	
60	35-18"	C				@53.2' - 54.7' - Shear zone: core of zone is dark yellowish brown sandy CLAYSTONE, graded, hard, moist, massive, slightly plastic, weakly cemented, internally sheared with multiple moderately dipping paper thin clay surfaces that are truncated by upper and lower contacts of zone; rock around shears is very stiff and uncemented; upper contact is a wavy, near horizontal ¼" - ½" thick dark yellowish brown CLAY, soft, moist, highly plastic, flaky; lower contact is a planar 2"-3" thick dark yellowish brown CLAY, soft, moist, highly plastic, flaky with steeper dipping internal slickensides		@54.5'S (N14W/7W) @60.5' Approx. C (N36E/10SE) @61' fracture zone (N10E/82E)	
65	37-18"	C				@54.7' - Dark yellowish brown silty CLAYSTONE with fine to coarse sand, graded, hard, moist, moderately cemented, slightly plastic @56' - Grades to reddish brown clayey fine to coarse SANDSTONE, well graded, hard, very moist, massive @58' - Grades to yellowish brown fine to coarse SANDSTONE, graded, hard, wet, uncemented, sands are running from seep on lower contact to claystone @60.5' - Sharp contact to reddish brown silty CLAYSTONE, poorly graded, hard, moist, moderately cemented, massive; running sands above; minor caving from small wedge failures for 3" along either side of steeply dipping fracture zone			
70						@67' - Orangish brown clayey fine to coarse SANDSTONE with sparse gravel, well graded, hard, very moist			
75						TD=67' Seep @60.5' Minor Caving @60.5'-67'			
80									
85									
ADDITIONAL COMMENTS:						C= California Split-Barrel Sampler Kelly Bar Weights: 0-21 - 1200 lbs. 21-42 = 800 lbs. 42-70 = 600 lbs.			

SUBSURFACE DATA

LOG OF BORING B92

CLIENT: Pardee Homes						PROJECT: Skyline Ranch		W.O.: 8838
LOCATION: Santa Clarita						ELEVATION: 1862±		DATE: 2/18/13
RIG TYPE: 24" Lo Drill						HAMMER WEIGHTS: Kelly Bar Weights		DROP: 18"
	N	U	B	M	DD	DESCRIPTION		ATTITUDES
0						<p>@0' - <u>Colluvium</u>: Dark brown very clayey fine to coarse SAND with 10-20% gravel, well graded, dense, moist, pinhole pores down to two feet, poorly developed blocky angular peds</p> <p>@2' - Strong brown sandy CLAY with 5-10% gravel, graded, stiff, moist, slightly plastic, no peds</p>		
5						<p>@5.5' - 7.5' - Dark yellowish brown silty CLAY with sand and gravel, well graded, medium stiff, crumbly, abundant carbonate</p> <p>@5.7' - ¼" thick CLAY, soft, sheared, highly plastic</p>		@5.7'S (N70E/35SE)
10			X			<p>@7.5' - Contact to chaotically mottled blocks of yellowish brown and strong brown silty SAND with 20-30% gravel, well graded, loose, dry, uncemented, friable, root hairs</p> <p>@9.5' - 10.7' - Sandy GRAVEL</p>		@10.7'S (N31W/17SW)
16-18"	C					<p>@10.7' - ½" - 2" thick dark yellowish brown CLAY, soft to stiff, moist, highly plastic, flaky, carbonate stained</p>		
			X			<p>@10.9' - <u>Sauqus Formation</u>: Sheared upper contact to strong brown very clayey fine to coarse SANDSTONE, graded, hard, moist, massive, weakly cemented</p>		@13'Ch (N57W/17SW)
15						<p>@13' - 2"-4" thick channel deposit: yellowish brown sandy fine gravel CONGLOMERATE, friable, gradational upper contact, sharp lower contact</p>		@13.5'S (N45W/20SW)
18-18"	C					<p>@13.2' - 15.5' - Dark yellowish brown silty CLAYSTONE with fine sand, poorly graded, very stiff, moist, massive, nonplastic, weakly to moderately cemented, sharp scoured upper contact, upper 6" of bed is disturbed exhibiting inconsistent cementation and blocky fractures</p>		
20			X			<p>@13.5' - ½" - 3" thick dark yellowish brown CLAY, soft, moist, highly plastic, flaky, wavy, sheared, sparse carbonate staining</p>		
25						<p>@15.5' - Grades to silty fine to medium SANDSTONE, hard, weakly cemented</p> <p>@17' - 18.5' - Channelized gradational contact to yellowish brown silty fine to coarse SANDSTONE with gravel, well graded, hard, moist, uncemented, slightly friable; grades down to clast supported fine gravel CONGLOMERATE in lower 3" of bed, scoured lower contact with mud ripups</p>		@18'B Approx. (N59W/5SW)
30						<p>@18" - 3" thick discontinuous fine to medium SANDSTONE interbed with black mineral laminations</p>		@18.5'C Approx. (N82E/18N)
35						<p>@18.5' - Sharp very scoured contact to dark yellowish brown silty CLAYSTONE with individual medium to coarse sand grains, poorly graded, hard, moist, moderately cemented, nonplastic, pervasive multidirectional internal shears, none through-going</p> <p>@19.4' - Sharp and gradational contacts to yellowish brown silty fine to medium SANDSTONE with gravel, well graded, hard, moist, irregular thickness, upper 2" weakly cemented, lower 3" uncemented, sparse discontinuous black mineral laminations</p>		@19.5'B (N20W/10SW)
40						<p>@19.8' - Scoured irregular contact to dark yellowish brown silty CLAYSTONE, poorly graded, hard, moist, moderately cemented, sparse internal discontinuous polished shear surfaces</p> <p>@20.8' - Sharp and gradational contacts to yellowish brown silty fine to medium SANDSTONE, hard, moist, uncemented, slightly friable</p>		
45								
ADDITIONAL COMMENTS:						<p>C= California Split-Barrel Sampler</p> <p>Kelly Bar Weights:</p> <p>0-21 - 1200 lbs.</p> <p>21-42 = 800 lbs.</p> <p>42-70 = 600 lbs.</p>		

SUBSURFACE DATA

LOG OF BORING B92

CLIENT: Pardee Homes					PROJECT: Skyline Ranch			W.O.: 8838
LOCATION: Santa Clarita					ELEVATION: 1862'±			DATE: 2/18/13
RIG TYPE: 24" Lo Drill					HAMMER WEIGHTS: Kelly Bar Weights			DROP: 12"
	N	U	B	M	DD	DESCRIPTION		ATTITUDES
40						@21.2' - 29.7' - Dark yellowish brown silty CLAYSTONE with fine sand, poorly graded, hard, moist, moderately cemented, nonplastic, slightly scoured upper contact @21.5' - Paper thin shear, wavy, merges with shear @22.3' @22.3' - 1" thick sheared dark yellowish brown CLAY, soft, moist, highly plastic, abundant well cemented fine gravel sized carbonate nodules		@20' Approx. B (N11W/7W)
45						@23.5' - 18" thick very silty fine to medium SANDSTONE, weakly to moderately cemented, gradational contacts @25.6' - 5" thick interbed of yellowish brown silty fine to medium SANDSTONE, uncemented @28' - 4" thick SANDSTONE channel in north wall, lenticular, uncemented, discontinuous		@22.3'S (N12W/8SW)
50						@29.7' - Grades to yellowish brown silty fine to medium SANDSTONE, hard, moist, weakly cemented, massive @30.5' - Coarsens to silty fine to coarse SANDSTONE with gravel, uncemented, massive @32' - Scoured and irregular contact to grayish brown silty CLAYSTONE to clayey SILTSTONE, poorly graded, hard, moist, massive, moderately cemented, non plastic @34.5' - Becoming sandy @35.5' - Grades to yellowish brown silty fine to coarse SANDSTONE with gravel, well graded, hard, moist, weakly cemented in upper 6", uncemented below @37' - Sharp contact to dark brown clayey SILTSTONE, hard, moist, slightly plastic, moderately cemented @37.5' - 41.5' - Red silty CLAYSTONE, very stiff, moist, medium plastic, weakly cemented, polished ped-like surfaces common, paleosol? @38' - Individual medium to coarse sand grains common in claystone @38.5' - Single layer of individual 1"-3" thick well cemented carbonate nodules @41.5' - 57' - Yellowish brown gravel to cobble CONGLOMERATE, well graded, very hard, moist, moderately cemented, massive @50' = 18" boulder		@25.6'B (N32W/9SW)
55								
60								
65								
70						TD = 57' refusal No groundwater No caving		
75								
80								
85								
ADDITIONAL COMMENTS:					Kelly Bar Weights: 0-21 = 1200 lbs. 21-42 = 800 lbs. 42-70 = 600 lbs.			

SUBSURFACE DATA

LOG OF BORING B1 (1995)

CLIENT: Pardec Construction	PROJECT: Monarch Hills	W.O. No: 8386
LOCATION: SEC	ELEVATION: 1626	DATE: 8/15/95
RIF TYPE: 24" Bucket Auger	HAMMER WEIGHTS: See Remarks	DROP: 12"

N	U	B	M	DD	C	DESCRIPTION	ATTITUDES
0						Mint Formation: White to light gray very fine-grained Silty SANDSTONE, very weathered with poorly sorted coarse sand and gravel lenses, occasional cobbles, subrounded to subangular, slightly open fractures, moderately indurated, some iron staining on coarse sands, occasional rootlets in fractures.	@4 FNS/73E
5		X				@5-6" Layer of greenish to brown CLAY, sheared bedding, polished surfaces, poorly bedded, moist, moderately soft, sharp contact with 1/8" carbonate line and iron stains, contact undisturbed.	BN65E/30N @5' BN45E/30N @6' SN22E/16N @6.5' BN55E/23N @8' BN82W/36N
10	4/6"	X				@5.5' Light gray, fine to coarse grained SANDSTONE, poorly sorted, dense, thin interbeds of dark gray (<1/4") claybeds	@13' BN27E/15N
15		X				@8.5' Light gray fine grained SANDSTONE, some dark mineral laminations, occasional gravel lenses with cobbles and coarse sand lenses, weakly cemented.	@14 BN35E/15N
20	8/5"	X				@13.5' Light gray CONGLOMERATE, poorly sorted coarse sand matrix, subrounded to subangular gravels and cobbles, minor iron staining on gravel surfaces, interbedded with medium grained sandy beds, coarse sand lenses and gravel beds and very fine dark mineral laminations.	
25	7/6"	X					
30	15/6"	X					
35		X					@33' BN25E/25N
40	18/6"	X				Gravel and cobbles polished surfaces.	@38' BN45E/17N
45							

ADDITIONAL COMMENTS: 0 - 29' 3450 lbs.
29 - 56' 2050 lbs.
56 - 85' 1140 lbs.

CLIENT: Pardee Construction	PROJECT: Monarch Hills	W.O. No: 8386
LOCATION: SEC	ELEVATION: 1626	DATE: 8/15/95
RIG TYPE: 24" Bucket Auger	HAMMER WEIGHTS: See Remarks	DROP: 12"

N	U	B	M	DD	C	DESCRIPTION	ATTITUDES
						Conglomerates with occasional sand lenses.	
20							
5"							
							@58'
							BN30E/20N
						@62-63' Large cobble zone.	
							@68'
							BN55E/26N
						@71' Water seeping through fine to medium SAND and fractures of siltstone, irregular, but sharp contact, iron on contact between sand and dark gray SILTSTONE, closed fractures, very dense.	@72'
						@73' Gradational contact to olive brown Silty very fine SANDSTONE, very dense, well-cemented, some dark mineral laminations.	FN45W/86N
							@74'
							BN43E/17N
						Total depth 83'	
						Water seepage @71'	
						No caving	
						Refusal @83' on very dense sandstone.	

ADDITIONAL COMMENTS:	0 - 29' 3450 lbs.
	29 - 56' 2050 lbs.
	56 - 85' 1140 lbs.

CLIENT: Pardee Construction		PROJECT: Monarch Hills		W.O. No: 8386			
LOCATION: SE		ELEVATION: 1555		DATE: 8/15/95			
RIG TYPE: 24" Bucket Auger		HAMMER WEIGHTS: See Remarks		DROP: 12"			
N	U	B	M	DD	C	DESCRIPTION	ATTITUDES
0						<u>Alluvium:</u> Medium brown Silty SAND with gravels and cobbles, slightly moist, very loose, difficult drilling be cause of loose cobbles, unconsolidated.	
5		X					
10	1/6"	X				Medium brown Silty SAND and gravels, slightly moist, moderately loose. @13.5' Seepage	
15							
20	7/12"	X	X			<u>Mint Formation:</u> Light gray very fine SANDSTONE, moist, dense, well-cemented, occasional olive brown clay stringers.	
25	7/6"	X					
30	10/12"	X					
35						Total depth 30' Ground water seepage @13.5' Cave 0 - 10.5'	
40							
45							
ADDITIONAL COMMENTS:		0 - 29' 3450 lbs.		29 - 56' 2050 lbs.		56 - 85' 1140 lbs.	

CLIENT: Pardee Construction	PROJECT: Monarch Hills	W.O. No: 8386
LOCATION: Southeast	ELEVATION: 1512	DATE: 8/15/95
RIG TYPE: 24" Bucket Auger	HAMMER WEIGHTS: See Remarks	DROP: 12"

N	U	B	M	DD	C	DESCRIPTION	ATTITUDES
						<p>0</p> <p><u>Alluvium</u>: Medium brown Silty SAND with gravels and cobbles, slightly moist to dry, loose, subangular to subrounded clasts, caving, difficult drilling because of loose cobbles, unconsolidated.</p> <p>5</p> <p>10</p> <p>15</p> <p>4/12" X</p> <p>20</p> <p>Large cobble/boulder.</p> <p>25</p> <p>10/12" X</p> <p>30</p> <p>Cobbles</p> <p>35</p> <p>Total depth 30' Caving 8-10' No ground water</p> <p>40</p> <p>45</p>	

ADDITIONAL COMMENTS:

0 - 29' 3450 lbs.

29 - 56' 2050 lbs.

56 - 85' 1140 lbs.

CLIENT: Pardee Construction		PROJECT: Monarch Hills		W.O. No: 8386			
LOCATION:		ELEVATION: 1795		DATE: 8/16/95			
RIG TYPE: 24" Bucket Auger		HAMMER WEIGHTS: See Remarks		DROP: 12"			
N	U	B	M	DD	C	DESCRIPTION	ATTITUDES
0						Terrace Deposits: Reddish brown Silty to Clayey SAND with gravels, occasional cobbles, subangular to subrounded, slightly moist to dry, moderately loose to moderately dense, moderately sorted, weathered to 3', desiccation cracks, rootlets to 3'.	@6' BN25E/20N
5							
10	4 1/2	X				Saugus Formation: Reddish brown moderate to well-graded slightly Silty SAND and gravels with occasional cobbles, subangular to subrounded, moderately indurated, slightly moist, moderately dense.	@12' BN45W/8S
15						@12' Orange brown Sandy SILT with occasional subangular gravels and coarse sand lenses, moist, dense, massive. @16' Grading to light brown very fine SAND, some carbonate veins at lithology change.	
20	14	X				@18' Light brown to light gray well-graded SANDS, gravels and cobbles, subrounded, cross-bedded, some carbonate pockets in gravel beds and coarse sand beds, poorly indurated, some carbonates on silt beds.	
25			X			@23' Well-graded gravel and cobble beds, caving 23'-26', loose, no cementation.	@26' BN60E/4N
30	23	X					@32' BN35E/4N
35							
40						@41' Carbonate banding on fine sand beds.	@41' BN21E/5N
45							
ADDITIONAL COMMENTS:		0 - 29' 3450 lbs. 29 - 56' 2050 lbs. 56 - 85' 1140 lbs.					

CLIENT: Pardee Construction	PROJECT: Monarch Hills	W.O. No: 8386
LOCATION:	ELEVATION: 1795	DATE: 8/16/95
RIG TYPE: 24" Bucket Auger	HAMMER WEIGHTS: See Remarks	DROP: 12"

N	U	B	M	DD	C	DESCRIPTION	ATTITUDES
45							
50						@51'-52.5' Cobbles, subrounded, moderately indurated.	
55						@53.5' Slightly reddish gray sands and gravels, well-graded, slight to moderately indurated, cross-bedded, flat lying lenses.	
60							
65							
70						Total depth 70'	
75						No ground water	
						Caving @23' - 26'	
						68' - 70'	
						Refusal @70' on cobbles.	
80							
85							
90							

ADDITIONAL COMMENTS:

0 - 29'	3450 lbs.
29 - 56'	2050 lbs.
56 - 85'	1140 lbs.

CLIENT: Pardee Construction		PROJECT: Monarch Hills		W.O. No: 8386			
LOCATION:		ELEVATION: 1785		DATE: 8/18/95			
RIG TYPE: 24" Bucket Auger		HAMMER WEIGHTS: See Remarks		DROP: 12"			
N	U	B	M	DD	C	DESCRIPTION	ATTITUDES
0						<u>Colluvium:</u> Reddish brown Clayey SAND and gravels, slightly moist, moderately dense, carbonate nodules, cobbles, rootlets and some desiccation cracks to 3'.	
5						<u>Saugus Formation:</u> Reddish brown Silty SAND beds and gravel beds, lenses, subrounded, moist, moderately loose, slightly indurated, poorly consolidated.	
10	9/12"	x	x			@6' 2"-4" Paleo Soil zone, brown, SILT, rootlets, unconsolidated. @6.5' Large subrounded/subangular cobbles and moderately coarse sand beds and dark mineral laminations .	@10' BN80W/20S
15						@9-10' Silty SAND to Clayey SAND with some coarse sands and fine gravels, dark mineral lineations. @11-13' Cobbles and gravels in silty matrix, loose, moist.	@13' BN20E/20N
20	1/6"	x				@13-16' Well-graded coarse sands and gravels, no fines, loose, moisture on gravel surfaces. @16' Light brown SILT with some coarse sands and fine gravels, moist, moderately dense.	
25						@22' Grades into Silty very fine SAND. @24' Grades to SILT. @26' Grades to very fine SAND.	@22' BN5E/5N
30	10/12"	x				Total depth 30' No ground water No caving	
35							
40							
45							
ADDITIONAL COMMENTS:							0 - 29' 3450 lbs.
							29 - 56' 2050 lbs.
							56 - 85' 1140 lbs.

CLIENT: Pardee Construction		PROJECT: Monarch Hills		W.O. No: 8386			
LOCATION:		ELEVATION: 1805		DATE: 8/21/95			
RIG TYPE: 24" Bucket Auger		HAMMER WEIGHTS: See Remarks		DROP: 12"			
N	U	B	M	DD	C	DESCRIPTION	ATTITUDES
						<p>0</p> <p><u>Terrace Deposits:</u> Reddish Clayey SAND and gravels, dry, moderately dense, some rootlets to 4'.</p>	
						<p>5</p> <p><u>Saugus Formation:</u> Medium brown Sandy SILT, some coarse sands, dry, moderately dense.</p> <p>Slight moist, some carbonate veins.</p>	
	8/8"	x				<p>10</p> <p>Dark brown Silty SAND with coarse sand and gravels, slightly moist, moderately loose, slightly porous. Becomes more Sandy, carbonate veins, moderately dense.</p>	
	7/12"	x				<p>20</p> <p>Grayish brown CONGLOMERATES and SAND, slightly moist, moderately loose to loose, prone to cave, dark mineral laminations, moderate to well-graded.</p>	
	14/12"	x				<p>30</p> <p>Reddish brown slightly Clayey SILT and SAND, coarse sands and occasional gravels.</p> <p>@29.5' Gray brown fine SAND with 1.25" - 3" well-bedded gravel and cobble beds, loose, slightly moist, prone to caving.</p>	<p>@28' BN70E/4N</p> <p>@30' BN60E/7N</p>
	10/4"	x				<p>35</p> <p>Used core bucket from 32'-42', very difficult drilling.</p> <p>@42' <u>Mint Formation:</u> White to light gray fine to coarse SAND and GRAVELS, iron staining at contact.</p> <p>@43' Fine gray SAND, occasional gravels, dark mineral laminations, moist, dense. @44-45': Mottled SILT and SAND, loose, moist, poorly sorted, poorly consolidated.</p>	<p>@42' CN70W/7N</p> <p>@43' BN30E/38N</p>
						<p>45</p>	
ADDITIONAL COMMENTS:		<p>0 - 29' 3450 lbs.</p> <p>29 - 56' 2050 lbs.</p> <p>56 - 85' 1140 lbs.</p>					

CLIENT: Pardee Construction		PROJECT: Monarch Hills		W.O. No: 8386			
LOCATION:		ELEVATION: 1805		DATE: 8/21/95			
RIG TYPE: 24" Bucket Auger		HAMMER WEIGHTS: See Remarks		DROP: 12"			
N	U	B	M	DD	C	DESCRIPTION	ATTITUDES
						@46'-48' Olive brown CLAY, slickensides on bedding planes, very moist, grading to clayey SANDSTONE, blocky fracture pattern, wet on fracture faces, very dense fine-grained, occasional coarse sand lenses and thin clay stringers.	@46' SN18E/48NW @46' FN32W/68S @46.5' SN53E/30N @48' BN50E/27N @49' BN82E/22N
						Conglomerate with sand matrix, with occasional 12" sand lenses, moist to wet, dense (difficult drilling, used core bucket, 55-77')	
						Water seepage	
						Caving conglomerates.	
						Total depth 77' Water seepage 64' Caving @22'-28' 30'-41' 75'-77'	

ADDITIONAL COMMENTS: 0 - 29' 3450 lbs.
 29 - 56' 2050 lbs.
 56 - 85' 1140 lbs.

CLIENT: Pardee Construction		PROJECT: Monarch Hills		W.O. No: 8386			
LOCATION:		ELEVATION: 1736		DATE: 8/22/95			
RIG TYPE: 24" Bucket Auger		HAMMER WEIGHTS: See Remarks		DROP: 12"			
N	U	B	M	DD	C	DESCRIPTION	ATTITUDES
0						<u>Terrace Deposits:</u> Reddish brown Clayey SAND with gravels, slightly moist, moderately loose to moderately dense, rootlets upper 12".	@8' BN50E/8S
5						<u>Saugus Formation:</u> Reddish brown SANDS with gravels and cobbles, slightly moist, moderately loose to loose, moderately well-graded, caving 3-6'.	
10							
15							
20	15"	x					
	16"						
25						Caving SANDS and COBBLES.	
30							
35							
40	16"	x				Gray brown fine to coarse SANDS and gravels, slightly moist, subrounded to subangular, weakly indurated.	
	12"						
45							
ADDITIONAL COMMENTS:		0 - 24' 2600 lbs.					
		24 - 49' 1644 lbs.					
		50 - 72' 800 lbs.					

CLIENT: Pardee Construction	PROJECT: Monarch Hills	W.O. No: 8386
LOCATION:	ELEVATION: 1736	DATE: 8/22/95
RIG TYPE: 24" Bucket Auger	HAMMER WEIGHTS: See Remarks	DROP: 12"

N	U	B	M	DD	C	DESCRIPTION	ATTITUDES
						Caving sands and cobbles @47 - 50'	
						Total depth 51' No ground water Caving 3-6', 24-37', 47-50' Refusal @51' on cobbles.	

ADDITIONAL COMMENTS: 0 - 24' 2600 lbs.
 24 - 49' 1644 lbs.
 50 - 72' 800 lbs.

CLIENT: Pardee Construction		PROJECT: Monarch Hills		W.O. No: 8386			
LOCATION:		ELEVATION: 1707		DATE: 8/25/95			
RIG TYPE: 24" Bucket Auger		HAMMER WEIGHTS: See Remarks		DROP: 12"			
N	U	B	M	DD	C	DESCRIPTION	ATTITUDES
						<p>Slope Wash: 0-2' Dark brown Clayey SAND with some gravels, dry, moderately dense, slightly desiccated.</p> <p>Saugus Formation: Reddish brown Clayey SAND and Silty SAND with gravels, occasional cobbles, dry, moderately dense, slightly porous, some rootlets to 5'.</p>	
	5/12" x					<p>Reddish brown Silty SAND, fine to coarse grained sands, gravel pockets, occasional fine gravel and coarse sand lenses, slightly moist, moderately loose, poorly consolidated.</p> <p>@11-12.5' Grey well-graded sands, interbedded, dry, loose.</p> <p>@12.5' Light reddish SILTS and SAND, gravels and cobbles, well-graded, slightly moist, loose (prone to caving).</p> <p>@18-22' Some channel cutting of silts and sand beds.</p>	<p>@15' BN15E/15S</p> <p>@17' BN30E/22S</p> <p>@20' BN15E/26S</p>
	3/12" x					<p>Mottled red and gray Clayey SAND to Sandy CLAY, moist, moderately soft, coarse sandstone gravels.</p> <p>Poorly consolidated.</p>	<p>@28' BN24E/34S</p> <p>@40.5' SN55E/42N</p>
	12/12" x					<p>Mint Formation: Olive gray CLAY, moist, moderately stiff to stiff, some slicken sides, dark staining in surfaces, carbonate nodules.</p> <p>@43' Gray fine SANDSTONE, moist, well-indurated.</p>	<p>@41' SN57E/67N</p> <p>@44 BN33W/11N</p>
ADDITIONAL COMMENTS:						<p>0 - 29' 3450 lbs.</p> <p>29 - 56' 2050 lbs.</p> <p>56 - 85' 1140 lbs.</p>	

CLIENT: Pardee Construction	PROJECT: Monarch Hills	W.O. No: 8386
LOCATION:	ELEVATION: 1707	DATE: 8/25/95
RIG TYPE: 24" Bucket Auger	HAMMER WEIGHTS: See Remarks	DROP: 12"

N	U	B	M	DD	C	DESCRIPTION	ATTITUDES
						@44' Carbontes layer 1/4" thick. Olive brown Sandy CLAYSTONE with occasional gravel lenses.	
	13	X					
	12"					Total depth 50' No ground water Caving 12-18'	

ADDITIONAL COMMENTS: 0 - 29' 3450 lbs.
 29 - 56' 2050 lbs.

CLIENT: Pardee Construction		PROJECT: Monarch Hills		W.O. No: 8386			
LOCATION:		ELEVATION: 1792		DATE: 8/28/95			
RIG TYPE: 24" Bucket Auger		HAMMER WEIGHTS: See Remarks		DROP: 12"			
N	U	B	M	DD	C	DESCRIPTION	ATTITUDES
0						<u>Terrace Deposits:</u> 0-5' Reddish brown Clayey SAND with gravels, moist, moderately dense, slightly porous, some rootlets upper 12".	
5						5-6.5' Light red to light brown Sandy SILT with some coarse SANDS, moist, moderately stiff.	
6.5						6.5'-8' Reddish brown SAND, poorly sorted, poorly consolidated, fine to coarse grained with subangular gravels, moist, moderately loose.	
10						<u>Saugus Formation:</u> Reddish fine to coarse SANDS, moist, moderately loose to moderately dense, moderately well-graded sands and gravel beds, occasional cobble beds, interbedded with thin silt beds, occasional dark mineral laminations, some interbedding. No dominant bedding or bedding direction.	
20	8/12" x						@22' BN58W/10S
25							@28' BN80W/20S
30							@29' BN65W/4S
35							@34' BN45E/10S
40	14/12" x					Total depth 40' No ground water No caving	
45							
ADDITIONAL COMMENTS:		0 - 29' 3450 lbs.		29 - 56' 2050 lbs.			

CLIENT: Pardee Construction		PROJECT: Monarch Hills		W.O. No: 8386			
LOCATION:		ELEVATION: 1787		DATE: 8/28/95			
RIG TYPE: 24" Bucket Auger		HAMMER WEIGHTS: See Remarks		DROP: 12"			
N	U	B	M	DD	C	DESCRIPTION	ATTITUDES
0						<u>Terrace Deposits:</u> Red brown Clayey SAND and subangular gravels, slightly moist, moderately dense.	
5						<u>Saugus Formaton:</u> Dark reddish brown Clayey SILT, slightly moist, dense, well-indurated, occasional carbonate veins, occasional rootlets to 8'.	
10						Gradational contact to light brown fine Clayey SANDS and Silty SANDS with occasional subangular gravels, grading to brown silty sand with some carbonate veins and increase in gravels, slightly moist, dense.	
15						Grayish brown to light red brown well-graded SANDS and gravels and silt lenses, carbonates on gravel beds, moderately cross bedded, slightly moist, moderately loose, prone to caving.	@18' BN75E/9N
20	9	x				Cobbles and boulders in fine sand matrix.	@22' BN5E/8N
25	12"					Reddish brown sandy CONGLOMERATE, slightly moist, dense, moderately well-bedded.	
30						Light brown very fine SAND and well-graded fine to medium SANDS, gravels and silt beds, carbonates on red silt beds, moist, poorly indurated, slightly crossbedded.	@35.5' BN42E/8N
35							@40' BN7E/5N
40	20	x					
45	12"						
ADDITIONAL COMMENTS:						0 - 29' 3450 lbs.	
						29 - 56' 2050 lbs.	
						56 - 85' 1140 lbs.	

CLIENT: Pardee Construction		PROJECT: Monarch Hills		W.O. No: 8386			
LOCATION:		ELEVATION: 1787		DATE: 8/28/95			
RIG TYPE: 24" Bucket Auger		HAMMER WEIGHTS: See Remarks		DROP: 12"			
N	U	B	M	DD	C	DESCRIPTION	ATTITUDES
45						Sandy CONGLOMERATES, subrounded to subangular, moderately well-graded, poorly indurated.	
50							
55						Light brown fine to medium, well-graded sands and reddish fine to coarse moderately graded sands and gravels.	@55' BN53E/7N
60	20 9" X					Total depth 60' No ground water Caving 17-24'	
ADDITIONAL COMMENTS: 0 - 29' 3450 lbs. 29 - 56' 2050 lbs. 56 - 85' 1140 lbs.							

CLIENT: Pardee Construction		PROJECT: Monarch Hills		W.O. No: 8386				
LOCATION:		ELEVATION: 1867		DATE: 8/28/95				
RIG TYPE: 24" Bucket Auger		HAMMER WEIGHTS: See Remarks		DROP: 12"				
	N	U	B	M	DD	C	DESCRIPTION	ATTITUDES
0							<u>Saugus Formation:</u> Upper 4' weathered, light yellowish brown, dry, dense, conglomerate, rocks consist of volcanics and metamorphics within slightly clayey sand matrix.	
5								
10							Becoming moist, color changes to grayish brown, dense.	
15							Moist, subrounded to rounded gravels and cobble CONGLOMERATE, polished surfaces with light clay film on exterior surfaces, some iron staining on gravel surfaces and adjacent matrix, massive-no bedding.	
20							21'-22' Boulders	
25							16' x 12" x	
30								
35							34'-38' Large cobbles and boulders.	
40							x	
45							35' x 9" x	
							@44' Boulder	
ADDITIONAL COMMENTS:		0 - 24' 2600 lbs.		Total depth 45' (Refusal on boulder)				
		24 - 48' 1644 lbs.		No ground water				
		49 - 71' 800 lbs.		No caving				
				Used core entire boring bucket				

CLIENT: Pardee Construction		PROJECT: Monarch Hills		W.O. No: 8386			
LOCATION: SEC		ELEVATION: 1718'		DATE: 9/18/95			
RIG TYPE: 24" Bucket Auger		HAMMER WEIGHTS: See Remarks		DROP: 12"			
N	U	B	M	DD	C	DESCRIPTION	ATTITUDES
0						<u>Mint Formation:</u> Silty fine SAND, tan, dry, loose, trace gravel.	
5		x				@5' Silt bed, 3" thick.	@5' BN55E/17W
10						Silty fine SAND, tan, dry, loose, trace gravel, some cobbles, boulders up to 8".	
15						@12' Fine silt bed, 1" thick, discontinuous, all around hole, scoured out.	@12' BN48E/11NW
20	12	x				Silty fine to medium SAND, tan, moist, loose, some gravel, cobble, boulders up to 18".	
25						@24' Difficult drilling, caving 21'-25'.	
30		x				Difficulty @29', 18" boulder encountered. Hole caving @27'-31'.	
35						@34', 26" boulder encountered. Caving, hole diameter 5'	
40						Total depth 38' Caving No ground water	
45							
ADDITIONAL COMMENTS:							0 - 24' 2600 lbs. 24' - 49' 1644 lbs.

PACIFIC SOILS ENGINEERING, INC.

Boring Log

PROJECT: WESTON - WHITES CANYON

W.O. 11143-A

Boring B-115

Sheet 1 OF 3

Date 11-16-88

By: M.M./W.J.
24" Bucket Auger
2700# to 23'
1600# to 45'
800# below 45'

Sample Method:

Depth (ft.)	Bulk	Undisturbed	Blows/ft.	USCS Symbol	Dry Unit Wt. (pcf)	Moisture (%)	Description
0				SM			<u>SOIL:</u> silty sand, tan, dry, loose.
5			4				<u>BEDROCK, SAUGUS FORMATION (TOs):</u> Silty Clayey Sandstone, red-brown, medium coarse grained, damp, dense, 10% cobbles and pebbles. Cobble bed: attitude: N80E, 35NW.
10			7		116.8	12.1	Clayey Sandstone, tan, coarse grained, pebbles and cobbles, slightly moist, dense. Fault: attitude: N70W, 60SW; SW side of hole up.
15							Claystone bed, red, 6 inch thick, sheared and discontinuous around the hole. At the bottom of the bed; attitude: N35E, 15NW. Cobble bed, attitude: N55E, 26NW.
20			8				Claystone bed, red-brown, randomly sheared, occasional caliche, about 1 inch thick, at the base; attitude: N50E, 30NW. Cobbly Sandstone, very coarse-grained, occasional boulders.
25			16		114.0	14.7	Sandstone, medium coarse grained with cobbles and pebbles. Claystone, red to red-brown, moist, dense, randomly sheared, irregular contact.
30			17				Sandstone, very fine-grained, approximate attitude: N60E, 11NW.

PACIFIC SOILS ENGINEERING, INC.

Boring Log

PROJECT: WESTON - WHITES CANYON

W.O. 11143-A

Boring B-115

Sheet 2 OF 3

Date 11-16-88

By: M.M./W.J.
24" Bucket Auger

Sample Method:

2700# to 23'
1600# to 45'
800# below 45'

Depth (ft.)	Bulk	Undisturbed	Blows/ft.	USCS Symbol	Dry Unit Wt. (pcf)	Moisture (%)	Description
30							Sandstone bed, medium-grained. Northwest side of boring; attitude: N55E, 17NW.
35							Sandstone, medium to coarse grained, occasional pebbles, very pebbly at 35 feet.
40			26				Claystone, red to red-brown, attitude is very good and consistent around the boring: N10E, 16NW. This bed is approximately 3 feet thick. Claystone bed, 2 feet thick, attitude: N45E, 22NW.
45							Claystone contact very pebbly and coarse above, red clay below; attitude N50E, 18NW.
50			66				Sandstone, coarse-grained, pebbly, moist, well cemented. Gravelly Claystone, dark brown, moist, dense.
55							Clayey Sandstone, red-brown, moist, sheared. Cobble bed, attitude: N20E, 5NW.
60							Rocks, switched to 24 inch coring bucket. Clayey Sandstone, tan, moist. Clayey Sandstone, tan with light grey streaks, dense with rocks 4 inch to 8 inch in diameter.

PACIFIC SOILS ENGINEERING, INC.

Boring Log

PROJECT: WESTON - WHITES CANYON

W.O. 11143-A

Boring B-115

Sheet 3 OF 3

Date 11-16-88

By: M.M./W.J.

Sample Method:

24" Bucket Auger
2700# to 23'
1600# to 45'
800# below 45'

Depth (ft.)	Bulk	Undisturbed	Blows/ft.	USCS Symbol	Dry Unit Wt. (pcf)	Moisture (%)	Description
60			38		123.3	10.6	Boulders at 60 feet. Total Depth at 60 feet. No water; no caving. Hole backfilled.

LOG OF EXCAVATION		Logged By: SBS	Date Excavated: 11/18/03	Client: Pardee Homes	
Trench No. TP1					
Depth (ft)	Description				
0 - 3	Soil/Colluvium: Dark brown sandy CLAY with abundant 2" -3" diameter subangular to subrounded clasts, hard, dry, sharp contact with underlying bedrock.				
3 - 6	Saugus Formation: Orange brown gravelly SANDSTONE with pebble channels, massive, very dense, slightly dry.				
Total Depth - 6' No groundwater No caving					
Graphic Log		<p>The graphic log is a hand-drawn cross-section of an excavation. It shows a 'SOUTH WALL' on the left. A '2' WIDE OHWM' (Ordinary High Water Mark) is indicated by a horizontal line. Below this, a cross-section of soil layers is shown, with a 'Kc' label. The layers are depicted with various patterns: a top layer with small circles, a middle layer with horizontal dashes, and a bottom layer with larger circles and dots. The layers are contained within a roughly triangular shape that tapers to the right.</p>			
scale 1" = 5'		GEOLABS-WESTLAKE VILLAGE	W.O. 8838	PLATE	TP1

LOG OF EXCAVATION		Logged By: SBS	Date Excavated: 11/18/03	Client: Pardee Homes	
Trench No. TP2					
Depth (ft)	Description				
0 - 3	Soil/Colluvium: Dark brown gravelly SAND, abundant subangular to subround 6"-12" diameter (up to 48" diameter) clasts, dense, dry, abundant roots to 6" depth, sharp contact with underlying bedrock.				
3 - 7	Mint Canyon Formation: Gray brown fine to medium grained SANDSTONE and pebble-cobble CONGLOMERATE, subangular to subrounded clasts commonly up to 6" diameter, massive and interbedded, poorly sorted, moderately indurated, very dense, dry.				
Total Depth - 7' No groundwater No caving					
Graphic Log					
scale 1" = 5'		GEOLABS-WESTLAKE VILLAGE		W.O. 8838	
		PLATE		TP2	

Comments
OHWM - ordinary high water mark
Approx. BN30E/12NW channel?

AS

LOG OF EXCAVATION		Logged By: SBS	Date Excavated: 11/18/03	Client: Pardee Homes	
Trench No. TP3	Depth (ft)	Description			Comments
0 - 2	<p>Soil/Colluvium: Dark brown clayey SAND and gravel, very dense, dry, abundant root hairs to 6" depth, sharp contact with underlying bedrock.</p>			<p>OHWM - ordinary high water mark</p>	
2 - 7	<p>Saugus Formation: Gray yellow brown SANDSTONE and CONGLOMERATE, massive, poorly sorted, moderately indurated, fine to coarse grained sand and gravel matrix, very dense, dry.</p>				
<p>Total Depth - 7' No groundwater No caving</p>					
Graphic Log					
scale 1" = 5'		GEOLABS-WESTLAKE VILLAGE		W.O. 8838	PLATE TP3

LOG OF EXCAVATION		Logged By: SBS	Date Excavated: 11/18/03	Client: Pardee Homes	Comments		
Trench No. TP4							
Depth (ft)	Description						
0 - 3	<u>Soil/Colluvium</u> : Clayey gravelly fine to medium grained SAND, sparse cobbles, very dense, slightly dry, abundant rootlets to 6" depth, sharp contact with underlying bedrock.				OHWM - ordinary high water mark		
3 - 5	<u>Saugus Formation</u> : Light red brown pebble-cobble CONGLOMERATE, massive, poorly sorted, moderately indurated, subangular to subround clasts commonly 1" to 6" diameter, channel deposits, very dense, slightly dry, carbonate precipitation from 3'-4', gradational contact at 4.5' with light red brown clayey fine grained SANDSTONE, poorly indurated, very dense, slightly moist.						
Total Depth - 5' No groundwater No caving							
Graphic Log							
scale 1" = 5'		GEOLABS-WESTLAKE VILLAGE	W.O. 8838	PLATE	TP4		

LOG OF EXCAVATION		Logged By: SBS	Date Excavated: 11/19/03	Client: Pardee Homes
Trench No. TP5				
Depth (ft)	Description			
0 - 2.5	Soil/Colluvium: Dark brown clayey gravelly fine to coarse grained SAND, abundant subrounded pebbles, very dense, slightly dry, abundant root hairs.			
2.5 - 6	Saugus Formation: Tan brown interbedded channelized CONGLOMERATE and gravelly coarse grained SANDSTONE with minor fine grained SANDSTONE, bedded, poorly sorted, very dense, slightly dry.			
Total Depth - 6' No groundwater No caving				
Graphic Log				
Comments: OHWM - ordinary high water mark				
scale 1" = 5'			W.O. 8838	PLATE TP5

LOG OF EXCAVATION		Logged By: SBS	Date Excavated: 11/19/03	Client: Pardee Homes
Trench No. TP6				
Depth (ft)	Description			
0 - 1.5	Soil/Colluvium: Dark brown clayey gravelly fine to coarse grained SAND, abundant rounded cobbles and pebbles, very dense, dry, abundant rootlets to 6", gradational contact.			
1.5 - 10	Slide Debris: Tan to light brown gravelly coarse grained SANDSTONE and CONGLOMERATE, poorly bedded, poorly sorted, channelized, very dense, dry.			
Total Depth - 10' No groundwater No caving				
Graphic Log				
scale 1" = 5'				
GEOLABS-WESTLAKE VILLAGE			W.O. 8838	PLATE TP6

Comments
 OHWM - ordinary high water mark
 Shears: N55W/35NE
 N30W/20NE

LOG OF EXCAVATION		Logged By: SBS	Date Excavated: 11/19/03	Client: Pardee Homes
Trench No. TP7				
Depth (ft)	Description			
0 - 2	Soil/Colluvium: Brown fine to medium grained SAND with trace clay, occasional 2"-18" diameter, subangular to subrounded cobbles and boulders, sparse boulders up to 48" diameter, dense, slightly dry, abundant root hairs to 6" depth, pinhole pores.			
2 - 5	Saugus Formation: Light red brown fine to coarse grained SANDSTONE and pebble-cobble-boulder CONGLOMERATE, poorly bedded, channel deposits, poorly sorted, moderately well cemented, tan brown fine to medium grained sandy matrix, very dense, slightly dry.			
	Total Depth - 5' No groundwater No caving			
Graphical Log				
scale 1" = 5'				
GEOLABS-WESTLAKE VILLAGE			W.O. 8838	PLATE TP7

LOG OF EXCAVATION		Logged By: SBS	Date Excavated: 11/19/03	Client: Pardee Homes	
Trench No. TP8					
Depth (ft)	Description				
0 - 3	<p><u>Soil/Colluvium:</u> Upper 12" soil slip, tan to light brown fine to coarse grained SAND with abundant rounded pebbles, medium dense, dry, underlain by 1" thick organic paelosol with root hairs, to medium to dark brown clayey fine to coarse grained SAND with abundant pebbles, cobbles, and boulders, dense, slightly dry, sharp, wavy contact with underlying bedrock.</p>	Comments OHWM - ordinary high water mark			
3 - 6	<p><u>Saugus Formation:</u> Pebble-cobble CONGLOMERATE, massive, poorly bedded, poorly sorted, subangular to subrounded clasts commonly 2"-24" diameter, tan brown fine to coarse grained sand matrix, very dense, slightly dry.</p> <p>Total Depth - 6' No groundwater No caving</p>				
<p>Graphic Log</p>					
scale 1" = 5'		GEOLABS-WESTLAKE VILLAGE	W.O. 8838	PLATE	TP8

LOG OF EXCAVATION		Logged By: SBS	Date Excavated: 11/20/03	Client: Pardee Homes
Trench No. TP9				
Depth (ft)	Description			
0 - 1.5	Soil/Colluvium: Red brown clayey gravelly fine to coarse grained SAND, abundant subrounded cobbles, very dense, slightly dry, porous.			
1.5 - 6	Slide Debris: Red brown fine to coarse grained SANDSTONE and pebble-cobble CONGLOMERATE mottled olive gray brown poorly bedded, weakly cemented, subrounded clasts commonly 6" diameter, very dense, slightly dry.			
Total Depth - 6' No groundwater No caving				
Graphic Log				
Comments		OHWM - ordinary high water mark		
scale 1" = 5'		GEOLABS-WESTLAKE VILLAGE	W.O. 8838	PLATE TP9

LOG OF EXCAVATION		Logged By: SBS	Date Excavated: 11/20/03	Client: Pardee Homes
Trench No. TP10				
Depth (ft)	Description			
0 - 2	Soil/Colluvium: Red brown gravelly fine to coarse grained SAND with abundant subrounded 3"-12" diameter cobbles, dense, slightly dry, gradational contact with underlying bedrock.			
2 - 6	Saugus Formation: Pebble-cobble-boulder CONGLOMERATE, up to 24" diameter clasts, poorly bedded, poorly sorted, tan light brown fine to coarse grained sand matrix, weakly cemented, very dense, slightly dry.			
Total Depth - 6' No groundwater No caving				
Graphic Log				
Comments: OHWM - ordinary high water mark				
scale 1" = 5'		GEO LABS-WESTLAKE VILLAGE		W.O. 8838
		PLATE		TP10

LOG OF EXCAVATION		Logged By: SBS	Date Excavated: 11/20/03	Client: Pardee Homes
Trench No. TP11				
Depth (ft)	Description			
0 - 2.5	Soil/Colluvium: Red brown clayey gravelly fine to coarse grained SAND with abundant subrounded commonly 6" diameter cobbles, dense, slightly dry.			
2.5 - 7	Saugus Formation: Tan light brown coarse grained SANDSTONE, poorly bedded with thinly bedded channelized pebble conglomerate, weakly cemented, very dense, slightly dry.			
Total Depth - 7' No groundwater No caving				
Graphic Log				
scale 1" = 5'		GEOLABS-WESTLAKE VILLAGE	W.O. 8838	PLATE TP11

LOG OF EXCAVATION		Logged By: SBS	Date Excavated: 11/20/03	Client: Pardee Homes
Trench No. TP12				
Depth (ft)	Description			
0 - 4.5	Soil/Colluvium: Red brown clayey fine to coarse grained SAND with pockets of very clayey sand (3'-4' depth), abundant subrounded boulders (up to 12" diameter), dense, slightly moist, sharp contact with underlying bedrock.			
4.5 - 7	Saugus Formation: Tan to light brown interbedded poorly bedded silty fine grained SANDSTONE and pebble CONGLOMERATE, poorly sorted, weakly indurated, very dense, slightly dry.			
Total Depth - 7'				
No groundwater				
No caving				
Graphic Log				
<p>The graphic log is a hand-drawn cross-section of an excavation. It shows a profile with a peak labeled 'OHWM' (Ordinary High Water Mark) and a vertical line labeled 'South Wall'. The profile is drawn on a grid. The soil is depicted with various textures: a top layer with small dots, a middle layer with larger circles representing boulders, and a bottom layer with a stippled pattern representing sandstone and conglomerate.</p>				
scale 1" = 5'				
			PLATE	TP12
			W.O. 8838	
GEOLABS-WESTLAKE VILLAGE				

Comments
OHWM - ordinary high water mark

LOG OF EXCAVATION		Logged By: SBS	Date Excavated: 11/21/03	Client: Pardee Homes
Trench No. TP13				
Depth (ft)	Description	Comments		
0 - 4.5	<u>Colluvium/Alluvium</u> : Light brown fine to medium grained SAND with abundant rounded to subangular cobbles and boulders (3"-18" diameter), and occasional pebble-gravel channels, loose, dry, abundant 1-2mm pores, sharp contact with underlying bedrock.	OHWM - ordinary high water mark		
4.5 - 6	<u>Mint Canyon Formation</u> : Gray gravelly fine to coarse grained SANDSTONE, poorly bedded, moderately indurated, orange staining, pebble channel at about 4.5-5', very dense, dry.			
	Total Depth - 6' No groundwater No caving			
Graphic Log				
<p>The graphic log is a hand-drawn cross-section of an excavation. It shows a profile of the ground surface and subsurface layers. The top layer is labeled 'OHWM' (Ordinary High Water Mark) with a horizontal line and arrows indicating its extent. Below this is a layer of sand with cobbles and boulders. A sharp boundary is shown at approximately 4.5 feet depth, labeled 'WEST WALL', which marks the contact with the Mint Canyon Formation. The formation is depicted with a stippled texture and contains a pebble channel. The total depth of the excavation is 6 feet.</p>				
scale 1" = 5'		GEOLABS-WESTLAKE VILLAGE	W.O. 8838	PLATE TP13

LOG OF EXCAVATION		Logged By: SBS	Date Excavated: 11/21/03	Client: Pardee Homes
Trench No. TP14				
Depth (ft)	Description	Comments		
0 - 2	Soil/Colluvium: Red to dark brown clayey fine to coarse grained SAND with abundant rounded to subangular cobbles (2"-6" diameter), dense, slightly dry, abundant pinhole pores, gradational contact into underlying material.	OHWM - ordinary high water mark		
2 - 7.5	Saugus Formation: Light red brown fine grained SANDSTONE with minor clayey sandstone, massive, moderately indurated, very dense, slightly dry. @ 4.5' - Grades to tan to light brown medium to coarse grained SANDSTONE, bedded with thin bedded pebble channels, poorly sorted, very dense, dry.			
Total Depth - 7.5' No groundwater No caving				
Graphic Log				
scale 1" = 5'		GEOLABS-WESTLAKE VILLAGE	W.O. 8838	PLATE TP14

LOG OF EXCAVATION		Logged By:	Date Excavated:	Client:
Trench No. TP15		CW	12/12/03	Pardee Homes
Depth (ft)	Description	Comments		
0 - 1	<u>Colluvium</u> : Dark brown silty SAND with scattered cobbles and boulders, dry and loose.			
1 - 2	<u>Saugus Formation</u> : Olive gray gravelly/cobbly CONGLOMERATE with poorly sorted sand matrix, cemented, dense to hard, dry. Total Depth - 2' No groundwater No caving, difficult excavation below 2'.			
Graphic Log				
				
scale 1" = 5'		GEOLABS-WESTLAKE VILLAGE W.O. 8838 PLATE TP15		

LOG OF EXCAVATION		Logged By: CW	Date Excavated: 12/12/03	Client: Pardee Homes
Trench No. TP16	Comments			
Depth (ft)	Description			
0 - 2	<p>Saugus Formation: Olive gray gravelly/cobbly CONGLOMERATE with scattered boulders, up to 24" diameter, upper 12" weathered, very hard, cemented, dry.</p> <p>Total Depth - 2' No groundwater No caving, difficult excavation below 2'</p>			
Graphic Log				
scale 1" = 5'	GEOLABS-WESTLAKE VILLAGE	W.O. 8838	PLATE	TP16

LOG OF EXCAVATION		Logged By: NM	Date Excavated: 7/12/04	Client: Pardee Homes
Trench No. TP17				
Depth (ft)	Description	Comments		
0 - 6	Alluvium: Medium to dark brown sandy clayey SILT with gravels, cobbles, and boulders (boulders typically in upper 2' and up to 3' diameter), rounded to subrounded clasts typically a few inches to 1.5' diameter, mostly granitic and very dense, abundant rootlets, porous, dry to slightly moist with depth, medium dense.			
6 - 10	Weathered Mint Canyon Formation: Light brown silty sandy gravel CONGLOMERATE with cobbles and boulders, abundant poorly sorted subrounded to rounded clasts typically a few inches to 10" diameter up to 2.5' diameter, matrix is slightly friable, slightly moist, dense to very dense.			
Graphic Log				
scale 1" = 5'		GEOLABS-WESTLAKE VILLAGE	W.O. 8838	PLATE TP17

LOG OF EXCAVATION		Logged By: NM	Date Excavated: 7/22/04	Pardee Homes
Trench No. Tp18				
Depth (ft)	Description	Comments		
0 - 5.5	<u>Alluvium</u> : Medium to dark brown clayey sandy SILT with gravels, cobbles, and occasional boulders up to 2.5' diameter, subrounded to rounded clasts typically a few inches to 8" diameter, porous, abundant roots/rootlets, poorly sorted, dry, medium dense to dense.			
5.5 - 7	<u>Weathered Mint Canyon Formation</u> : Medium brown silty fine to coarse grained SANDSTONE with abundant gravels, cobbles, and occasional boulders up to 2' diameter, clasts typically a few inches to 1' diameter, poorly sorted, slightly friable, dry, very dense.			
7 - 7.5	<u>Mint Canyon Formation</u> : Greenish gray sandy CONGLOMERATE, subrounded to rounded clasts typically a few inches to 10" diameter, poorly sorted, moderately cemented, dry, very dense.			
Graphic Log				
scale 1" = 5'		GEOLABS-WESTLAKE VILLAGE	W.O. 8838	PLATE TP18

LOG OF EXCAVATION		Logged By: NM	Date Excavated: 7/22/04	Client: Pardee Homes
Trench No. TP19				
Depth (ft)	Description	Comments		
0 - 5.5	<u>Alluvium</u> : Dark brown sandy clayey SILT with gravels, cobbles, and occasional boulders up to 2' diameter, subrounded to rounded granitic clasts typically 1-2" up to 8" diameter, abundant roots/rootlets, porous, poorly sorted, dry, medium dense to dense.			
5.5 - 7.5	<u>Weathered Mint Canyon Formation</u> : Medium brown silty SANDSTONE with abundant gravels, cobbles, and occasional boulders up to 1.5" diameter, subrounded to rounded clasts typically a few inches to 8" diameter, poorly sorted, occasional rootlets, slightly friable, dry, dense.			
7.5 - 8.5	<u>Mint Canyon Formation</u> : Greenish gray sandy CONGLOMERATE, subrounded to rounded clasts typically a few inches to 1' diameter, poorly sorted, moderately cemented, dry, very dense.			
Graphic Log				
scale 1" = 5'		GEOLABS-WESTLAKE VILLAGE	W.O. 8838	PLATE TP19

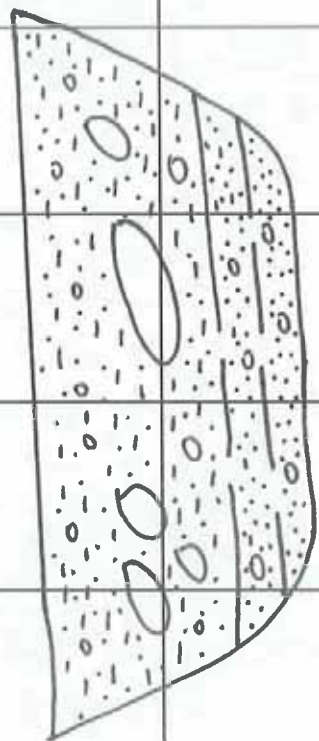
LOG OF EXCAVATION		Logged By: NM	Date Excavated: 7/22/04	Client: Pardee Homes
Trench No. TP20				
Depth (ft)	Description	Comments		
0 - 5	<u>Alluvium</u> : Medium to dark brown sandy clayey SILT with gravels, cobbles, and boulders up to 4' diameter, subrounded to rounded clasts typically 1-2" to 1.5' diameter, abundant roots/rootlets, porous, dry, medium dense to dense.			
5 - 6	<u>Weathered Mint Canyon Formation</u> : Medium brown silty fine to coarse grained SANDSTONE with occasional fine gravels, moderately sorted, slightly friable, dry, dense.			
6 - 7	<u>Mint Canyon Formation</u> : Light gray fine to coarse grained SANDSTONE with occasional gravel and cobble clasts typically a few mm to 3" diameter, moderately sorted, massive, moderately cemented, dry, very dense.			
A-38 Graphic Log				
				
scale 1" = 5'	GEOLABS-WESTLAKE VILLAGE	W.O. 8838	PLATE	TP20

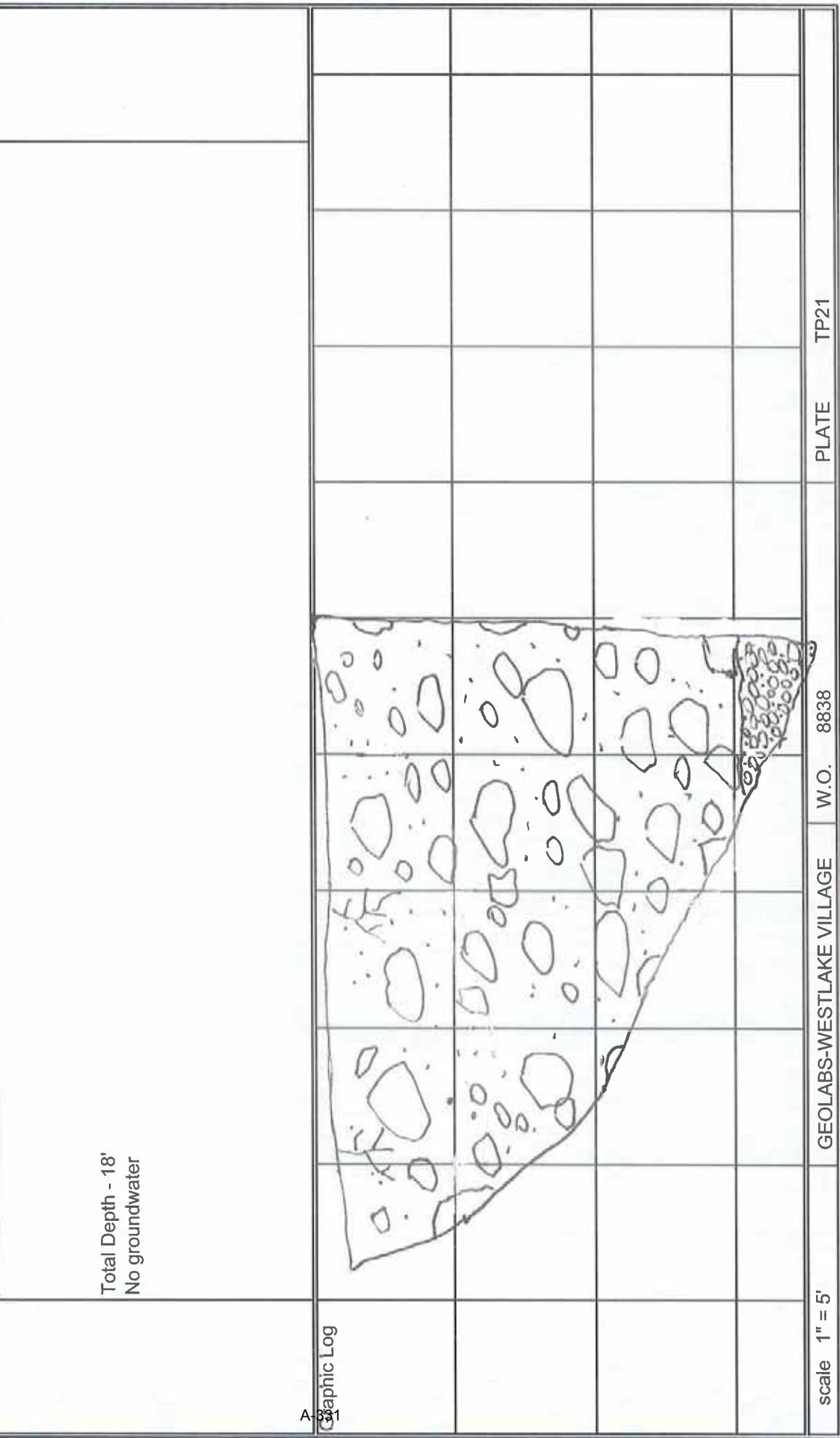
LOG OF EXCAVATION Trench No. TP21	Logged By: CW	Date Excavated: 7/23/04	Client: Pardee Homes
Depth (ft)	Description		
0 - 15	Alluvium: Dark clayey silty SAND to silty sandy CLAY with abundant subrounded cobbles and boulders, porous, abundant roots to 4', dry and loose.		
15 - 18	Mint Canyon Formation: Yellowish olive brown cobbly CONGLOMERATE, cemented, dry, very hard, massive.		
Total Depth - 18' No groundwater			
Graphic Log			
scale 1" = 5' GEOLABS-WESTLAKE VILLAGE W.O. 8838 PLATE TP21			

LOG OF EXCAVATION		Logged By: CW	Date Excavated: 7/23/04	Client: Pardee Homes
Trench No. TP22				
Depth (ft)	Description	Comments		
0 - 8	<p>Alluvium: Dark brown clayey SAND with abundant subrounded gravels, cobbles, and boulders, dry to damp with depth, loose, porous, rootlets to 2' depth.</p> <p>Mint Canyon Formation: Yellowish olive brown gravelly cobbly CONGLOMERATE, cemented, dry, very hard, massive.</p>			
8 - 9	Total Depth - 9' No groundwater			
Graphic Log				
scale 1" = 5'		GEOLABS-WESTLAKE VILLAGE	W.O. 8838	PLATE TP22

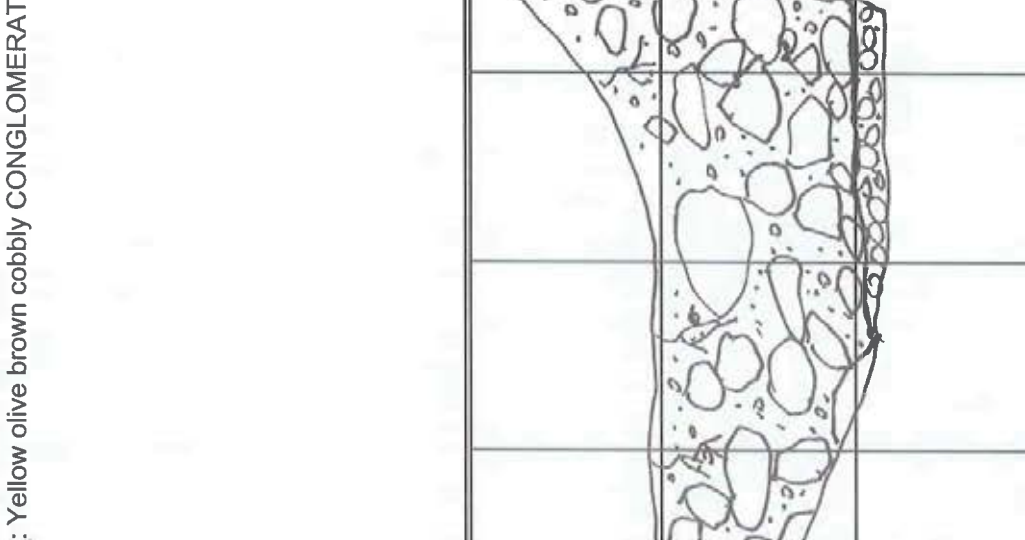
LOG OF EXCAVATION Trench No. TP23	Logged By: CW	Date Excavated: 7/23/04	Client: Pardee Homes
Depth (ft)	Description		
0 - 8	Alluvium: Dark brown clayey silty SAND to sandy CLAY with abundant subrounded gravels, cobbles, and boulders, dry to damp, loose, rootlets to 3'.		
8 - 10	Mint Canyon Formation: Yellow olive brown cobbly CONGLOMERATE, dry, hard, cemented, massive.		
Total Depth - 10' No groundwater			
Graphic Log			
scale 1" = 5'			
GEOLABS-WESTLAKE VILLAGE		W.O. 8838	PLATE TP23

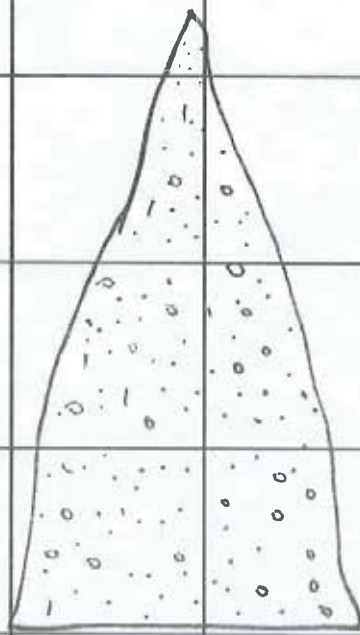
LOG OF EXCAVATION		Logged By: AH	Date Excavated: 3/27/06	Client: Pardee Homes
Trench No. TP24				
Depth (ft)	Description	Comments		
0 - 2	<p><u>Colluvium</u>: Brown silty SAND with gravel and cobbles, abundant roots, loose, moist.</p>			
2 - 7.5	<p><u>Saugus Formation</u>: Brown gravelly cobbly SANDSTONE, cobbles are rounded, gravels are subrounded, weakly cemented, moist, very dense, abundant rootlets, massive.</p> <p>Total Depth - 7.5' No groundwater No caving Backfilled</p>			
				
A-3 Graphic Log				
scale 1" = 5'		GEOLABS-WESTLAKE VILLAGE W.O. 8838.002 PLATE TP24		

LOG OF EXCAVATION		Logged By: AH	Date Excavated: 3/27/06	Client: Pardee Homes
Trench No. TP25				
Depth (ft)	Description	Comments		
0 - 3	<u>Colluvium</u> : Brown silty SAND with gravel, roots, very moist.			
3 - 8.5	<u>Saugus Formation</u> : Orangish brown SANDSTONE with subrounded gravel and cobbles, moist, very dense, massive.			
Total Depth - 8.5' No groundwater No caving Backfilled				
Graphic Log				
scale 1" = 5'		GEOLABS-WESTLAKE VILLAGE	W.O. 8838.002	PLATE TP25

LOG OF EXCAVATION		Logged By: AH	Date Excavated: 3/27/06	Client: Pardee Homes
Trench No. TP26				
Depth (ft)	Description	Comments		
0 - 1	<u>Colluvium</u> : Dark brown silty SAND with gravel and organics, roots, very moist.			
1 - 8	<u>Saugus Formation</u> : Orangish brown silty fine to medium grained SANDSTONE, moist, very dense, massive. Total Depth - 8' No groundwater No caving Backfilled			
Graphic Log				
scale 1" = 5'		GEOLABS-WESTLAKE VILLAGE	W.O. 8838.002	PLATE TP26

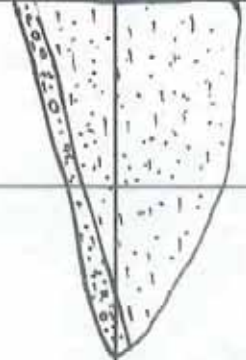

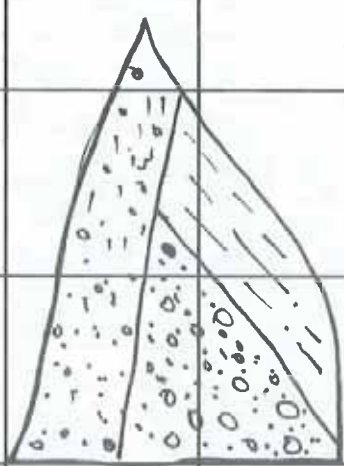
LOG OF EXCAVATION		Logged By: AH	Date Excavated: 3/27/06	Client: Pardee Homes
Trench No. TP27				
Depth (ft)	Description	Comments		
0 - 2	<u>Alluvium</u> : Brown silty SAND with gravel and cobbles, abundant roots and root hairs, loose.			
2 - 3	Cobbles, gravel and sand, wet, loose.			
3 - 8	<u>Saugus Formation</u> : Orange, white, and tan CONGLOMERATE with contact to brown clayey SILTSTONE, moist, very stiff, massive.	@5' Contact N88W/5SW		
Total Depth - 8' Wet from 2-3' No caving Backfilled				
Graphic Log				
scale 1" = 5'		GEOLABS-WESTLAKE VILLAGE	W.O. 8838.002	PLATE TP27

LOG OF EXCAVATION
 Trench No. TP28
 Logged By: AH
 Date Excavated: 3/27/06
 Client: Pardee Homes

Depth (ft)	Description	Comments
0 - 2	<u>Alluvium</u> : Brown clayey fine to coarse grained SAND with gravel and (5-10%) boulders, pockets of friable medium to coarse SAND with gravel and boulders, wet, medium dense, roots.	
2 - 6	<u>Saugus Formation</u> : Gravel CONGLOMERATE with orangish tan medium to coarse sand matrix, very moist, very dense, massive.	
Total Depth - 6' Wet to 2' No caving Backfilled		

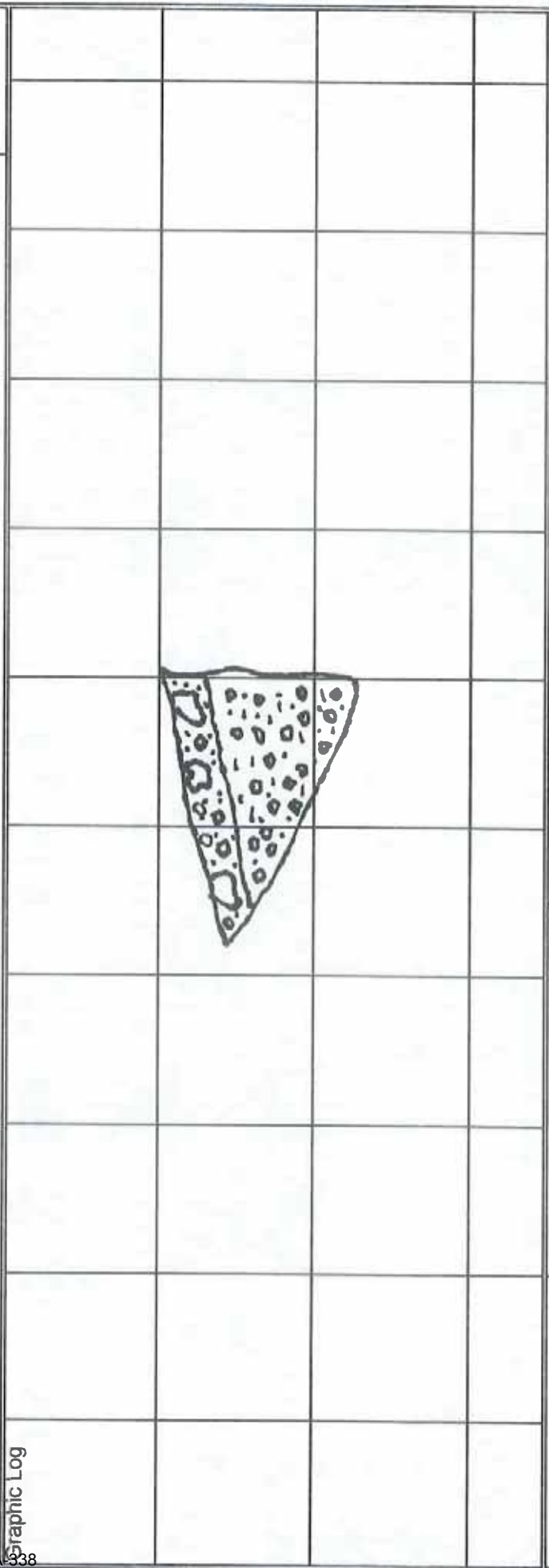

scale 1" = 5'
 GEOLABS-WESTLAKE VILLAGE
 W.O. 8838.002
 PLATE
 TP28

LOG OF EXCAVATION		Logged By: AH	Date Excavated: 3/27/06	Client: Pardee Homes
Trench No. TP29				
Depth (ft)	Description	Comments		
0 - 1	<u>Alluvium</u> : Brown silty SAND with gravel and cobbles, moist, loose, roots and root hairs.			
1 - 4.5	<u>Saugus Formation</u> : Orangish brown CONGLOMERATE, moist, dense, weathered, root hairs. Total Depth - 4.5' No groundwater No caving Backfilled			
Graphic Log				
scale 1" = 5'	GEOLABS-WESTLAKE VILLAGE	W.O. 8838.002	PLATE	TP29

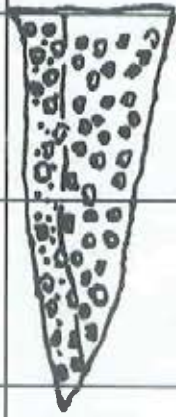

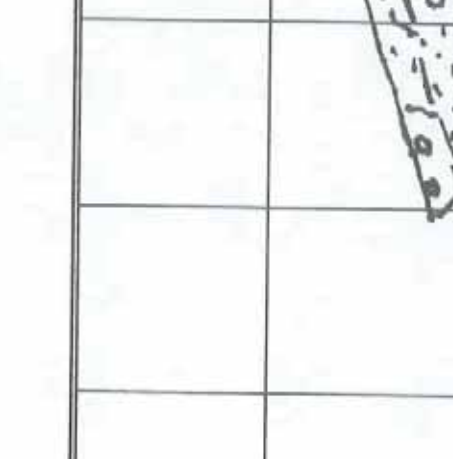
LOG OF EXCAVATION		Logged By: AH	Date Excavated: 3/27/06	Client: Pardee Homes
Trench No. TP30				
Depth (ft)	Description	<p>Comments</p>		
0 - 1	Colluvium: Brown silty SAND with gravel, roots, very moist.			
1 - 8.5	<p>Saugus Formation: Orangish brown medium to coarse grained SANDSTONE with gravel and cobbles, friable, moist, dense, massive.</p> <p>Total Depth - 8.5' No groundwater No caving Backfilled</p>			
Graphic Log				
				
scale 1" = 5'		GEOLABS-WESTLAKE VILLAGE	W.O. 8838.002	PLATE TP30

LOG OF EXCAVATION		Logged By: AH	Date Excavated: 3/27/06	Client: Pardee Homes
Trench No. TP31				
Depth (ft)	Description	Comments		
0 - 1	<u>Colluvium</u> : Dark brown silty SAND with gravel, moist, loose, roots.			
1 - 2	Light brown sandy SILT, wet, roots and root hairs.			
2 - 4	<u>Saugus Formation</u> : Light brown sandy SILTSTONE, hard, weathered, moist to very moist, very stiff, massive.			
4 - 6.5	Brown fine to coarse grained SANDSTONE with gravel and cobbles, moist, dense, friable, massive.			
Total Depth - 6.5' Wet from 1-2' No caving Backfilled				
Graphic Log				
scale 1" = 5'		GEOLABS-WESTLAKE VILLAGE	W.O. 8838.002	PLATE TP31

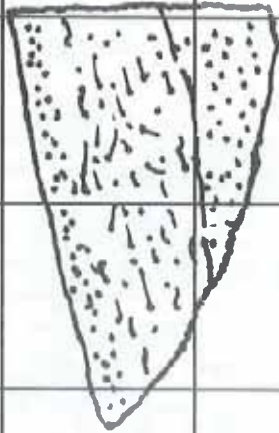

LOG OF EXCAVATION		Logged By: AH	Date Excavated: 3/27/06	Client: Pardee Homes
Trench No. TP32				
Depth (ft)	Description	Comments		
0 - 4	<u>Colluvium</u> : Brown silty SAND with gravel and cobbles, loose, very moist.			
4 - 8	Brown silty SAND with gravel, cobbles, and boulders (approximately 20% up to 3' diameter), very moist, loose.			
8 - 11	<u>Mint Canyon Formation</u> : Tan gravelly SANDSTONE with cobbles, massive, weathered, friable, moist, dense.			
11 - 13	Tan gravelly SANDSTONE with cobbles, massive, friable, moist, dense.			
Total Depth - 13' No groundwater No caving Backfilled				
Graphic Log				
scale 1" = 5'		GEOLABS-WESTLAKE VILLAGE W.O. 8838.002 PLATE TP32		

LOG OF EXCAVATION		Logged By: AH	Date Excavated: 3/27/06	Client: Pardee Homes
Trench No. TP33				
Depth (ft)	Description	Comments		
0 - 2	<u>Colluvium</u> : Brown sandy SILT with gravel and cobbles (less than 5% boulders), very moist, stiff.			
2 - 7	<u>Mint Canyon Formation</u> : Gray fine grained SANDSTONE; moist, very dense, weakly cemented, massive, occasional subrounded cobbles.			
	Total Depth - 7' No groundwater No caving Backfilled			
Geographic Log				
scale 1" = 5'	GEOLABS-WESTLAKE VILLAGE	W.O. 8838.002	PLATE	TP33

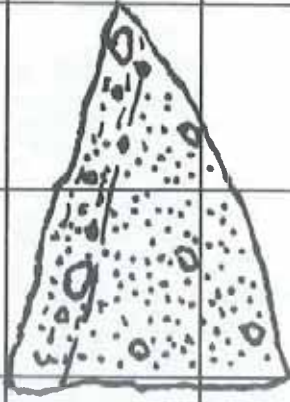

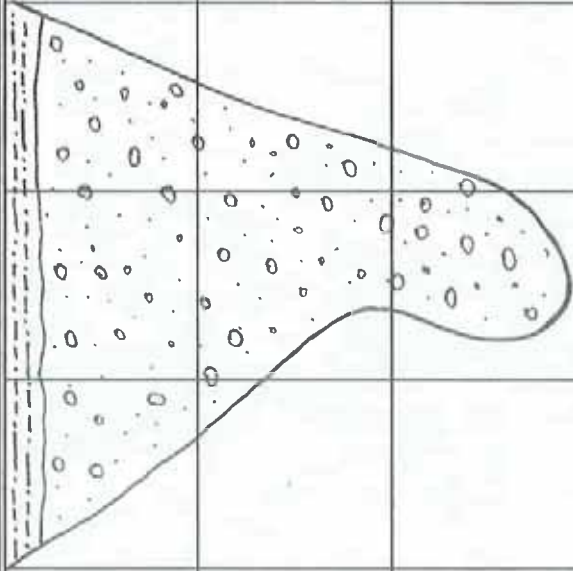
LOG OF EXCAVATION Trench No. TP34	Logged By: RMP	Date Excavated: 4/19/06	Client: Pardee Homes
Depth (ft)	Description	Comments	
0 - 1	<p><u>Topsoil</u>: Very dark brown fine to medium grained sandy clayey SILT, graded, soft, very moist, roots.</p>		
1 - 14.5	<p><u>Saugus Formation</u>: Tan cobble CONGLOMERATE, rounded to subrounded clasts commonly granitoid, gneiss, and quartzite, well graded, massive, slightly friable, very dense, moist.</p> <p>Total Depth - 14.5' No groundwater No caving Backfilled</p>		
Graphic Log			
scale 1" = 5'	GEOLABS-WESTLAKE VILLAGE	W.O. 8838.002	PLATE TP34

LOG OF EXCAVATION		Logged By: RMP	Date Excavated: 4/19/06	Client: Pardee Homes
Trench No. TP35				
Depth (ft)	Description	Comments		
0 - 2	<u>Topsoil</u> : Very dark brown fine to medium grained sandy clayey SILT, moderately graded, soft, very moist, roots.			
2 - 9	<u>Saugus Formation</u> : Tan cobble CONGLOMERATE, rounded to subrounded clasts commonly granitoid and quartzite, well graded, poorly bedded, slightly friable, dense, moist, roots to 6', gravel lens at 6', largest cobble is 10" in diameter.			
	Total Depth - 9' No groundwater No caving Backfilled			
Graphic Log				
scale 1" = 5'	GEOLABS-WESTLAKE VILLAGE	W.O. 8838	PLATE	TP35

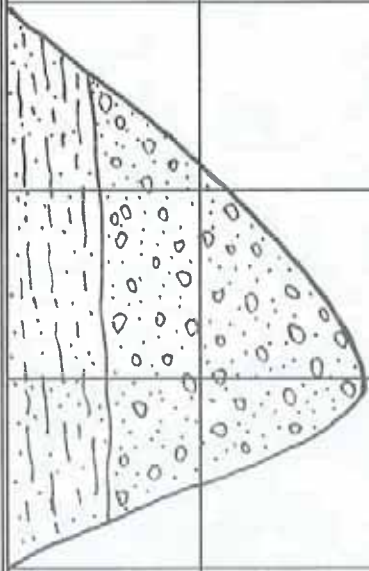
LOG OF EXCAVATION		Logged By: RMP	Date Excavated: 4/19/06	Client: Pardee Homes
Trench No. TP36				
Depth (ft)	Description			
0 - 2.5	<u>Topsoil:</u> Very dark brown sandy, silty CLAY, with subrounded fine to coarse grained gravel, well graded, soft, moist, roots.			
2.5 - 9	<u>Terrace Deposit:</u> Orange to tan cobble GRAVEL with sand, subrounded to rounded clasts commonly gneiss, volcanic and granitoid, well graded, massive, slightly friable, dense, dry to very moist (inconsistent moisture).			
Total Depth - 9' No groundwater No caving Backfilled				
Graphic Log 				
scale 1" = 5'		GEOLABS-WESTLAKE VILLAGE	W.O. 8838.002	PLATE TP36
Comments				

LOG OF EXCAVATION Trench No. TP37		Logged By: RMP	Date Excavated: 4/19/06	Client: Pardee Homes
Depth (ft)	Description	Comments		
0 - 1	<u>Topsoil</u> : Very dark brown fine to medium grained sandy clayey SILT, graded, soft, moist, roots.			
1 - 3	<u>Saugus Formation</u> : Orange to tan gravel CONGLOMERATE, subrounded clasts, well graded, massive, weakly cemented, very dense, moist, roots throughout.			
	Total Depth - 3' No groundwater No caving Refusal at 3' Backfilled			
Graphic Log				
scale 1" = 5'		GEOLABS-WESTLAKE VILLAGE	W.O. 8838.002	PLATE TP37

LOG OF EXCAVATION		Logged By: RMP	Date Excavated: 4/19/06	Client: Pardee Homes
Trench No. TP38				
Depth (ft)	Description	Comments		
0 - 1	<u>Topsoil</u> : Very dark brown to black fine to coarse grained sandy clayey SILT, graded, soft, moist, abundant roots.			
1 - 7	<u>Saugus Formation</u> : Orange to tan fine to coarse grained sandy cobble GRAVEL, subrounded clasts, well graded, massive, friable, highly weathered, very moist, disturbed by roots.			
7 - 7.5	Interbed of brown fine grained sandy SILTSTONE, moderately graded, stiff, moist, discontinuous.			
7.5 - 9	Orange to tan gravel cobble CONGLOMERATE, subrounded clasts commonly granitoid and quartzite, moderately graded, massive, slightly friable, dense, moist.			
Total Depth - 9' No groundwater No caving Backfilled				
Graphic Log				
scale 1" = 5'		GEOLABS-WESTLAKE VILLAGE	W.O. 8838.002	PLATE TP38

LOG OF EXCAVATION		Logged By: RMP	Date Excavated: 4/19/06	Client: Pardee Homes
Trench No. TP39				
Depth (ft)	Description			
0 - 0.5	Topsoil: Very dark brown to black fine to medium grained sandy clayey SILT, moderately graded, soft, moist, abundant roots.			
0.5 - 3	Terrace Deposit: Tan fine to coarse grained SAND, moderately graded, massive, slightly friable, loose, moist, subrounded clasts commonly quartzite, metaigneous, granitoid, well graded, poorly bedded, friable.			
3 - 9.5	Saugus Formation: Orange to tan interbedded fine to coarse grained SANDSTONE and gravel to cobble CONGLOMERATE, subrounded clasts commonly quartzite, metaigneous, granitoid, well graded, bedded, slightly friable, dense, moist, interbeds occur in fining upwards sequences.			
Total Depth - 9.5' No groundwater No caving Backfilled				
Graphic Log				
Comments				
@7.5' N62E/19NW				
scale 1" = 5'		GEOLABS-WESTLAKE VILLAGE		W.O. 8838.002
		PLATE		TP39

LOG OF EXCAVATION		Logged By: NM	Date Excavated: 5/23/06	Client: Pardee Homes
Trench No. TP40				
Depth (ft)	Description	Comments		
0 - 3	<u>Alluvium</u> : Dark brown clayey silty SAND with scattered gravels and cobbles, abundant roots, moist, medium dense.			
3 - 7	<u>Mint Canyon Formation</u> : Light brown to grayish brown CONGLOMERATE with medium grained sand matrix, clasts are typically rounded to subrounded gravels and cobbles (approximately 10-15% greater than 12" diameter), some clasts are weathered and fracture with a hammer strike, well graded, moist, very dense.			
Total Depth - 7' No groundwater No caving Backfilled				
Graphic Log				
scale 1" = 5'		GEOLABS-WESTLAKE VILLAGE	W.O. 8838	PLATE TP40

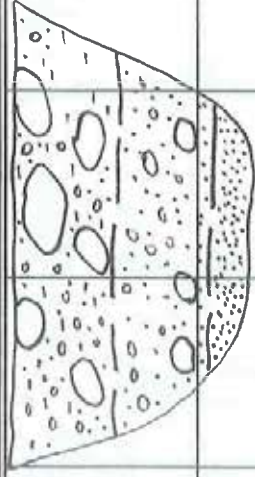
LOG OF EXCAVATION		Logged By: NM	Date Excavated: 5/23/06	Client: Pardee Homes
Trench No. TP41				
Depth (ft)	Description	Comments		
0 - 2.5	Alluvium: Dark brown silty sandy CLAY with abundant rounded to subrounded granitic boulders (mostly on surface and upper 2') up to 3' diameter, approximately 25% are boulders, moist, medium stiff, abundant roots, porous.			
3 - 5	Mint Canyon Formation: Light grayish brown CONGLOMERATE with abundant fractured granitic clasts (mostly less than 1' diameter), well graded, moist, very dense.			
5 - 6	Gradational contact with light brown fine to medium grained SANDSTONE with disseminated organic stains, massive, poorly graded, moist, very dense.			
	Total Depth - 6' No groundwater No caving Backfilled			
Graphic Log				
scale 1" = 5'		GEOLABS-WESTLAKE VILLAGE	W.O. 8838	PLATE TP41

LOG OF EXCAVATION		Logged By: NM	Date Excavated: 5/23/06	Client: Pardee Homes
Trench No. TP42				
Depth (ft)	Description	Comments		
0 - 4	Alluvium: Dark brown sandy silty CLAY with dispersed rounded and subrounded granitic boulders up to 3' diameter (approximately 25% are greater than 12" diameter), very moist, medium stiff, rootlets.			
4 - 6	Dark brown clayey fine to coarse grained SAND with gravels, cobbles, and lesser boulders (less than 10%), well graded, moist, dense.			
6 - 7	<u>Mint Canyon Formation</u> : Sharp undulating contact with light grayish to yellowish brown medium grained SANDSTONE with occasional coarse sand lenses, moderately graded, moist, very dense.			
Total Depth - 7' No groundwater No caving Backfilled				
Graphic Log				
scale 1" = 5'		GEOLABS-WESTLAKE VILLAGE	W.O. 8838	PLATE TP42

LOG OF EXCAVATION		Logged By: NM	Date Excavated: 5/23/06	Client: Pardee Homes
Trench No. TP43				
Depth (ft)	Description	Comments		
0 - 3	<p><u>Colluvium</u>: Dark brown sandy silty CLAY with occasional boulders up to 18" diameter (approximately 10% boulders), rootlets, moist, medium stiff, pinhole porosity.</p>			
3 - 7	<p><u>Mint Canyon Formation</u>: Light brown to yellowish brown sandy gravel cobble CONGLOMERATE with sparse boulders up to 13" diameter, well graded, subrounded to rounded clasts (mostly granitic with abundant fractures in clasts, moist, very dense.</p>			
	<p>Total Depth - 7' No groundwater No caving Backfilled</p>			
A-353 Graphic Log				
scale 1" = 5'	GEOLABS-WESTLAKE VILLAGE	W.O. 8838	PLATE	TP43

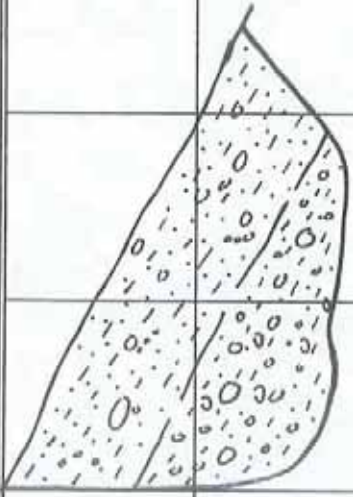
LOG OF EXCAVATION		Logged By: NM	Date Excavated: 5/23/06	Client: Pardee Homes
Trench No. TP44				
Depth (ft)	Description	Comments		
0 - 3.5	<u>Topsoil</u> : Dark brown silty sandy CLAY with occasional cobbles, roots/rootlets, pinhole porosity, moist, medium stiff.			
3.5 - 7	<u>Mint Canyon Formation</u> : Light orangish brown sandy gravel cobble CONGLOMERATE, subangular to rounded clasts, massive, well graded, moist, very dense.			
	Total Depth - 7' No groundwater No caving Backfilled			
Graphic Log				
				
scale 1" = 5'		GEOLABS-WESTLAKE VILLAGE	W.O. 8838	PLATE TP44

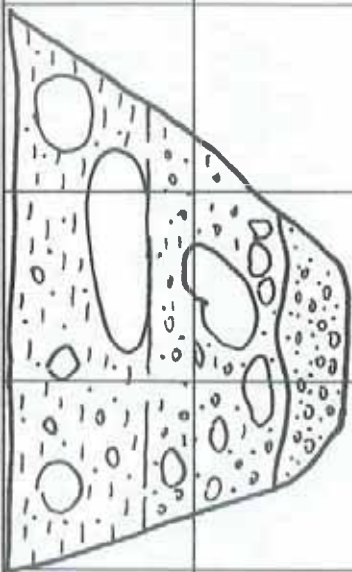
LOG OF EXCAVATION		Logged By: NM	Date Excavated: 5/23/06	Client: Pardee Homes
Trench No. TP45				
Depth (ft)	Description	Comments		
0 - 3.5	<u>Topsoil/Alluvium</u> : Dark brown sandy silty CLAY with sparse boulders and cobbles, typically 1-2' diameter, one 4' diameter boulder at 3-4' depth, moist, medium stiff.			
3.5 - 7	<u>Alluvium</u> : Medium to dark brown silty clayey SAND with dispersed cobbles and boulders (approximately 25-30%), granitic clasts typically 8" to 18" in diameter up to 2', poorly graded at base (higher concentration of boulders).			
7 - 8.5	<u>Mint Canyon Formation</u> : Irregular contact (undulating amplitude approximately 8") with light brown sandy CONGLOMERATE with boulders up to 12" diameter, well graded, moist, very dense.			
Total Depth - 8.5'				
No groundwater				
No caving				
Backfilled				
A-365 Graphic Log				
scale 1" = 5'	GEOLABS-WESTLAKE VILLAGE	W.O.	8838	PLATE TP45

LOG OF EXCAVATION Trench No. TP46	Logged By: NM	Date Excavated: 5/23/06	Client: Pardee Homes
Depth (ft)	Description		Comments
0 - 3.5	Topsoil: Medium to dark brown silty clayey SAND with gravels and lesser cobbles.		
3.5 - 8	Landslide Deposit: Light brown to yellowish brown sandy gravel cobble CONGLOMERATE, approximately 30% sandstone matrix, well graded, massive, moist, very dense, no clasts greater than 12" observed.		
	Total Depth - 8' No groundwater No caving Backfilled		
Graphic Log			
scale 1" = 5'	GEOLABS-WESTLAKE VILLAGE	W.O. 8838	PLATE TP46

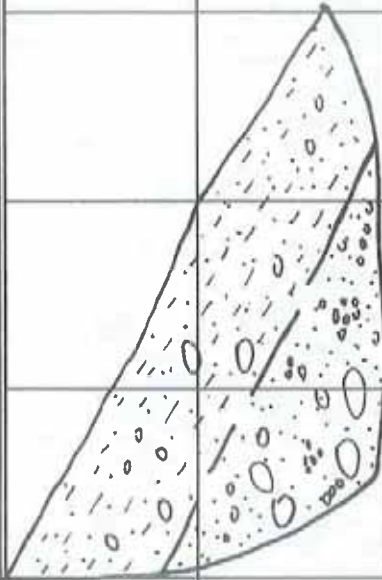

LOG OF EXCAVATION		Logged By: NM	Date Excavated: 5/23/06	Client: Pardee Homes
Trench No. TP47				
Depth (ft)	Description	Comments		
0 - 4	<u>Alluvium</u> : Dark brown silty sandy CLAY with dispersed angular to rounded gravels, cobbles and lesser boulders, typically up to 16" diameter (approximately 10% greater than 12" diameter clasts), single approximately 5' by 3' rounded granitic boulder at surface down to approximately 3.5', moist, medium stiff.			
4 - 7	<u>Landslide Deposit</u> : Light brown to grayish brown sandy gravel cobble CONGLOMERATE with sparse boulders up to 16" diameter (approximately 2-4' apart), well graded, moist, very dense.			
7 - 8	Gradational contact with light brown to light grayish brown fine to medium grained SANDSTONE with gravels and lesser cobbles, moderately graded, massive, moist, very dense.			
	Total Depth - 8' No groundwater No caving Backfilled			
Graphic Log				
scale 1" = 5'		GEOLABS-WESTLAKE VILLAGE	W.O. 8838	PLATE TP47

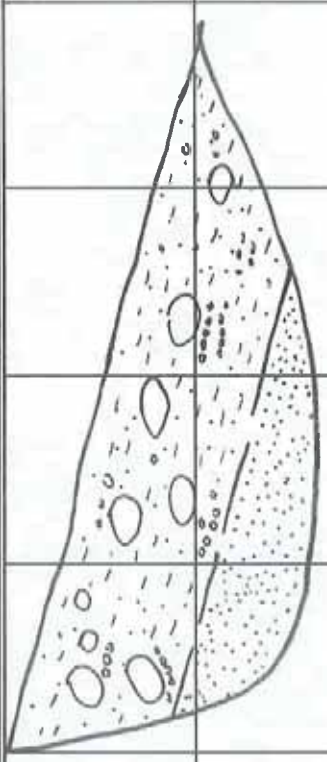
LOG OF EXCAVATION		Logged By: NM	Date Excavated: 5/23/06	Client: Pardee Homes
Trench No. TP48				
Depth (ft)	Description	Comments		
0 - 4	<u>Alluvium</u> : Dark brown clayey fine to coarse grained SAND and gravelly SAND with abundant cobbles and boulders up to 3' diameter, clasts are mostly granitic and subrounded, approximately 50% greater than 12", moist, medium stiff.			
4 - 6.5	<u>Mint Canyon Formation</u> : Light gray fine grained SANDSTONE, poorly graded, massive, discontinuous disseminated organic stringers 1-2cm thick, slightly moist, very dense.			
	Total Depth - 6.5' No groundwater No caving Backfilled			
A-358 Graphic Log				
scale 1" = 5'		GEOLABS-WESTLAKE VILLAGE	W.O. 8838	PLATE TP48

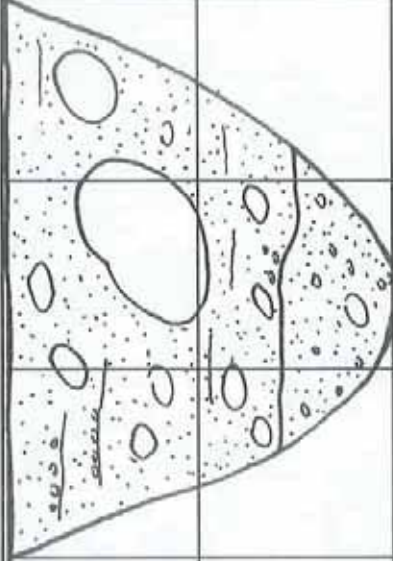
LOG OF EXCAVATION		Logged By: NM	Date Excavated: 5/24/06	Client: Pardee Homes
Trench No. TP49				
Depth (ft)	Description	Comments		
0 - 7	Alluvium: Medium and light brown clayey silty fine to coarse grained SAND with cobbles and boulders (one up to 4' diameter), crudely bedded, slightly friable at base, moist, medium dense, approximately 35-40% is greater than 12" diameter, typically 12-24".			
7 - 10	Mint Canyon Formation: Light brown sandy CONGLOMERATE with occasional boulders up to approximately 12" diameter, well graded, moist, very dense.			
Total Depth - 10' No groundwater No caving Backfilled				
A-359 Graphic Log				
scale 1" = 5'		GEOLABS-WESTLAKE VILLAGE	W.O. 8838	PLATE TP49

LOG OF EXCAVATION
 Trench No. TP50

Logged By: NM

Date Excavated: 5/24/06

Client: Pardee Homes

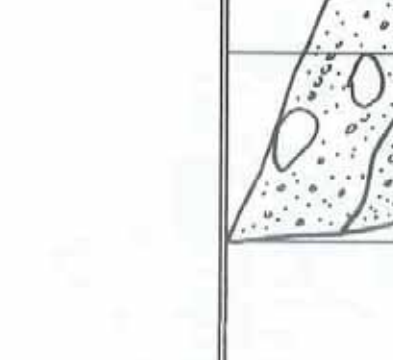
Depth (ft)	Description	Comments
0 - 3	<p>Alluvium: Dark brown clayey silty fine to coarse grained gravelly SAND with cobbles and boulders up to 2' diameter, approximately 25% greater than 12" diameter, well graded, slightly moist, slightly friable, dense.</p>	
3 - 4.5	<p>Mint Canyon Formation: Light gray fine to coarse grained gravelly SANDSTONE to sandy gravel CONGLOMERATE with cobbles up to 10" diameter, massive, slightly moist, very dense.</p>	
	<p>Total Depth - 4.5' No groundwater No caving Backfilled</p>	
A		
360		
scale 1" = 5'	<p>GEOLABS-WESTLAKE VILLAGE</p>	<p>W.O. 8838</p>
	<p>PLATE</p>	<p>TP50</p>

scale 1" = 5'

GEOLABS-WESTLAKE VILLAGE

W.O. 8838

PLATE TP50

LOG OF EXCAVATION Trench No. TP51		Logged By: NM	Date Excavated: 5/24/06	Client: Pardee Homes	Comments
Depth (ft)	Description				
0 - 8.5	<p>Alluvium: Dark brown fine to coarse grained sandy CLAY and clayey SAND with gravels, cobbles, and lesser boulders (approximately 25% greater than 12" diameter), well graded, moist, medium stiff/medium dense to dense with depth.</p> <p>Mint Canyon Formation: Light gray fine to coarse grained gravel cobble CONGLOMERATE with occasional boulders up to 16" diameter, approximately 5% greater than 12" diameter, moist, very dense.</p> <p>Total Depth - 9.5' No groundwater No caving Backfilled</p>				
Graphic Log					
scale 1" = 5'	GEOLABS-WESTLAKE VILLAGE	W.O.	8838	PLATE	TP51

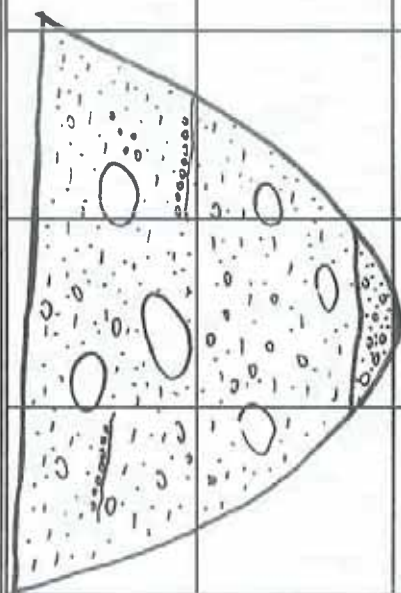

LOG OF EXCAVATION		Logged By: NM	Date Excavated: 5/24/06	Client: Pardee Homes
Trench No. TP52				
Depth (ft)	Description	Comments		
0 - 13.5	<p>Colluvium: Medium brown clayey silty fine to coarse grained SAND with abundant subangular to rounded gravels, cobbles, and lesser boulders up to 3' diameter (approximately 10-15% greater than 12" diameter), well graded, coarsening with depth, moist, medium dense to dense with depth.</p> <p>Mint Canyon Formation: Light gray sandy CONGLOMERATE, well graded, moist, very dense.</p> <p>Total Depth - 14' No groundwater No caving Backfilled</p>			
Graphic Log				
scale 1" = 5'		GEOLABS-WESTLAKE VILLAGE	W.O. 8838	PLATE TP52

LOG OF EXCAVATION		Logged By: NM	Date Excavated: 5/24/06	Client: Pardee Homes
Trench No. TP53				
Depth (ft)	Description	Comments		
0 - 7.5	<p><u>Colluvium</u>: Medium brown silty sandy CLAY and clayey SAND with abundant subangular to rounded gravels and cobbles (no boulders observed), well graded, massive, moist, very stiff.</p> <p><u>Mint Canyon Formation</u>: Light gray sandy gravel CONGLOMERATE, slightly moist, very dense.</p> <p>Total Depth - 9' No groundwater No caving Backfilled</p>			
Graphic Log				
scale 1" = 5'		GEOLABS-WESTLAKE VILLAGE	W.O. 8838	PLATE TP53

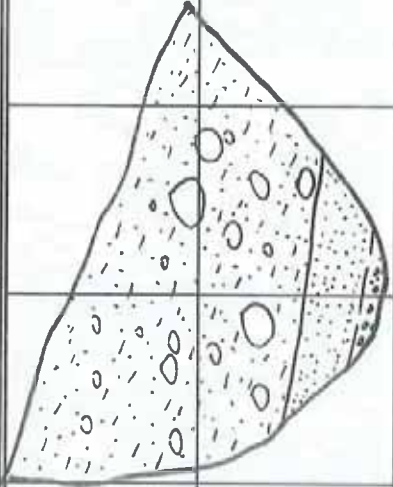
LOG OF EXCAVATION		Logged By: NM	Date Excavated: 5/24/06	Client: Pardee Homes
Trench No. TP54				
Depth (ft)	Description	Comments		
0 - 6.5	Colluvium: Medium brown silty clayey SAND with gravels and scattered cobbles and boulders up to 14" diameter (approximately 5% greater than 12"), well graded, massive, occasional pinhole porosity, moist, medium dense.			
6.5 - 8.5	Mint Canyon Formation: Light gray fine to medium grained SANDSTONE, poorly graded, massive, moist, very dense.			
@8'	Approximate horizontal contact with gravel CONGLOMERATE.			
	Total Depth - 8.5' No groundwater No caving Backfilled			
Graphic Log				
scale 1" = 5'	GEOLABS-WESTLAKE VILLAGE	W.O. 8838	PLATE	TP54

LOG OF EXCAVATION		Logged By: NM	Date Excavated: 5/24/06	Client: Pardee Homes
Trench No. TP55				
Depth (ft)	Description	Comments		
0 - 4	<u>Topsoil:</u> Dark brown sandy CLAY to clayey SAND with gravels and lesser cobbles, massive, pinhole porosity, moist, medium stiff to medium dense.			
4 - 11.5	<u>Alluvium:</u> Medium brown silty clayey gravelly SAND with abundant cobbles and boulders, typically 1-2' diameter up to 3', subangular to rounded clasts, well graded, approximately 35% greater than 12" diameter.			
11.5 - 13.5	Light brown medium to coarse grained SAND with gravels, cobbles, and lesser boulders (approximately 10% up to 1' diameter, low amount of fines, slightly friable, moist, dense to very dense.			
13.5 - 14	<u>Mint Canyon Formation:</u> Light gray sandy CONGLOMERATE, massive, moist, very dense.			
Total Depth - 14' No groundwater No caving Backfilled				
Graphic Log				
scale 1" = 5'		GEOLABS-WESTLAKE VILLAGE	W.O. 8838	PLATE TP55

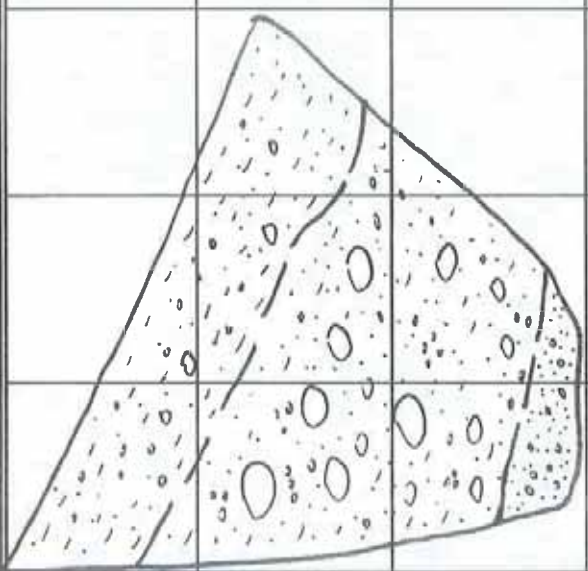
LOG OF EXCAVATION		Logged By: NM	Date Excavated: 5/24/06	Client: Pardee Homes
Trench No. TP56				
Depth (ft)	Description	Comments		
0 - 3	<u>Topsoil</u> : Dark brown silty clayey SAND with gravels and occasional cobbles, porous, rootlets, moist, medium dense.			
3 - 12	<u>Alluvium</u> : Light brown clayey silty SAND with subrounded to rounded gravels, cobbles, and lesser boulders up to 2' diameter (approximately 20% greater than 12" diameter), well graded, moist, dense.			
12 - 13.5	<u>Mint Canyon Formation</u> : Light gray brown sandy gravel cobble CONGLOMERATE, moist, very dense, occasional oxidation stains.			
	Total Depth - 13.5' No groundwater No caving Backfilled			
	Graphic Log			
	scale 1" = 5'	GEOLABS-WESTLAKE VILLAGE	W.O. 8838	PLATE TP56

LOG OF EXCAVATION		Logged By: NM	Date Excavated: 5/25/06	Client: Pardee Homes
Trench No. TP57				
Depth (ft)	Description	Comments		
0 - 5	<p><u>Colluvium</u>: Dark brown silty clayey SAND with gravels and occasional cobbles and boulders (approximately 5% greater than 12" diameter and one clast up to 2' diameter), moist, medium dense.</p>			
5 - 12.5	<p><u>Mint Canyon Formation</u>: Light gray fine to medium grained gravelly SANDSTONE with dispersed cobbles, well graded, massive, moist to very moist, very dense.</p> <p>Total Depth - 12.5' No groundwater No caving Backfilled</p>			
Graphic Log				
scale 1" = 5'		GEOLABS-WESTLAKE VILLAGE	W.O. 8838	PLATE TP57

LOG OF EXCAVATION		Logged By: NM	Date Excavated: 5/25/06	Client: Pardee Homes
Trench No. TP58				
Depth (ft)	Description			
0 - 8	<u>Alluvium</u> : Dark brown fine to coarse grained sandy CLAY with abundant gravels, cobbles and lesser boulders (approximately 30% greater than 12" diameter), well graded, moist to very moist, medium stiff.			
8 - 10	<u>Mint Canyon Formation</u> : Light gray fine to coarse grained gravel cobble CONGLOMERATE with occasional boulders approximately 12" diameter, well graded, moist, very dense.			
	Total Depth - 10' No groundwater No caving Backfilled			
Graphic Log				
scale 1" = 5'		GEOLABS-WESTLAKE VILLAGE	W.O. 8838	PLATE TP58
Comments				

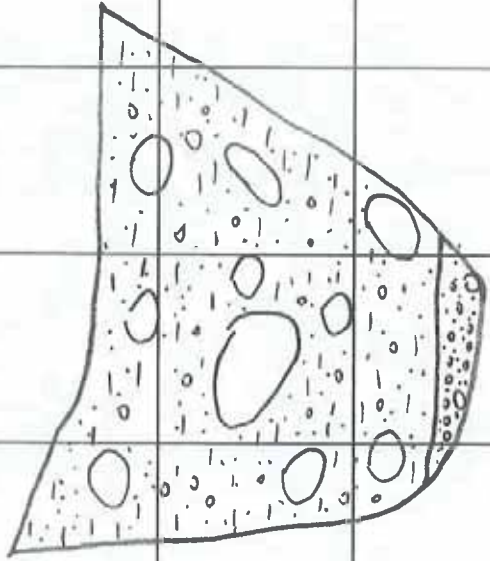

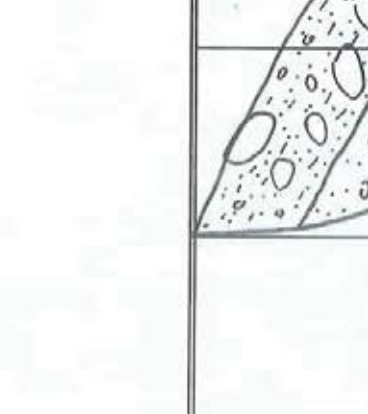

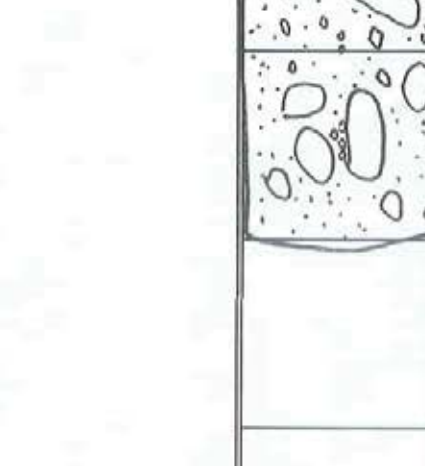
LOG OF EXCAVATION Trench No. TP59	Logged By: NM	Date Excavated: 5/25/06	Client: Pardee Homes
Depth (ft)	Description	Comments	
0 - 3	<p><u>Colluvium</u>: Medium brown silty SAND with gravels and abundant cobbles and boulders (approximately 35% greater than 12" diameter), clasts are subangular to rounded, typically 12"-18" diameter up to 2', well graded, moist, medium dense.</p>		
3 - 6	<p><u>Mint Canyon Formation</u>: Light gray sandy gravel cobble CONGLOMERATE, well graded, massive, slightly moist, very dense.</p> <p>Total Depth - 6' No groundwater No caving Backfilled</p>		
A	Graphic Log		
<p>scale 1" = 5'</p>			
GEOLABS-WESTLAKE VILLAGE		W.O. 8838	PLATE TP59

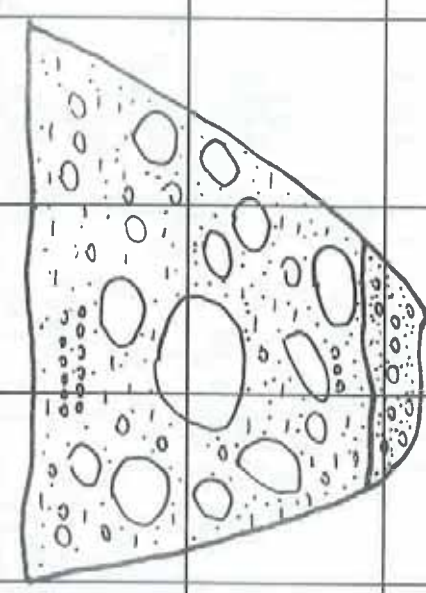
LOG OF EXCAVATION Trench No. TP60	Logged By: NM	Date Excavated: 5/25/06	Client: Pardee Homes
Depth (ft)	Description	<p>Comments</p>	
0 - 7.5	<p><u>Alluvium:</u> Medium brown silty SAND with abundant gravels, cobbles, and boulders (30% greater than 12" diameter), well graded, slightly moist, medium dense, several clasts up to 3' diameter.</p>		
7.5 - 9	<p><u>Mint Canyon Formation:</u> Light gray gravel cobble CONGLOMERATE, well graded, slightly moist, very dense.</p>		
<p>Total Depth - 9' No groundwater No caving Backfilled</p>			
<p>Graphic Log</p>			
<p>scale 1" = 5'</p>		<p>W.O. 8838</p>	<p>PLATE TP60</p>

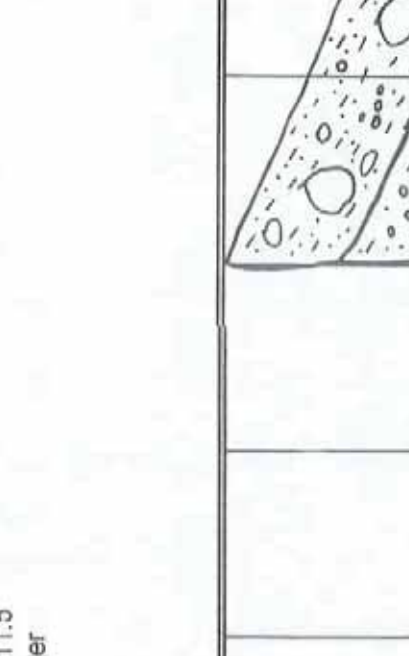
LOG OF EXCAVATION		Logged By: NM	Date Excavated: 5/25/06	Client: Pardee Homes
Trench No. TP61				
Depth (ft)	Description	Comments		
0 - 8.5	<p><u>Alluvium</u>: Medium brown silty SAND and fine to coarse grained SAND with abundant gravels, cobbles, and lesser boulders (approximately 35% greater than 12" diameter), subangular to rounded clasts typically 18" to 24" diameter, well graded, moist to very moist at depth, slightly friable, medium dense.</p>			
8.5 - 10	<p><u>Mint Canyon Formation</u>: Light gray sandy gravel cobble CONGLOMERATE with occasional boulders (typically 12" to 16" diameter), well graded, moist to very moist, very dense.</p>			
	<p>Total Depth - 10' No groundwater No caving Backfilled</p>			
A371 Graphic Log				
scale 1" = 5'		GEOLABS-WESTLAKE VILLAGE	W.O. 8838	PLATE TP61

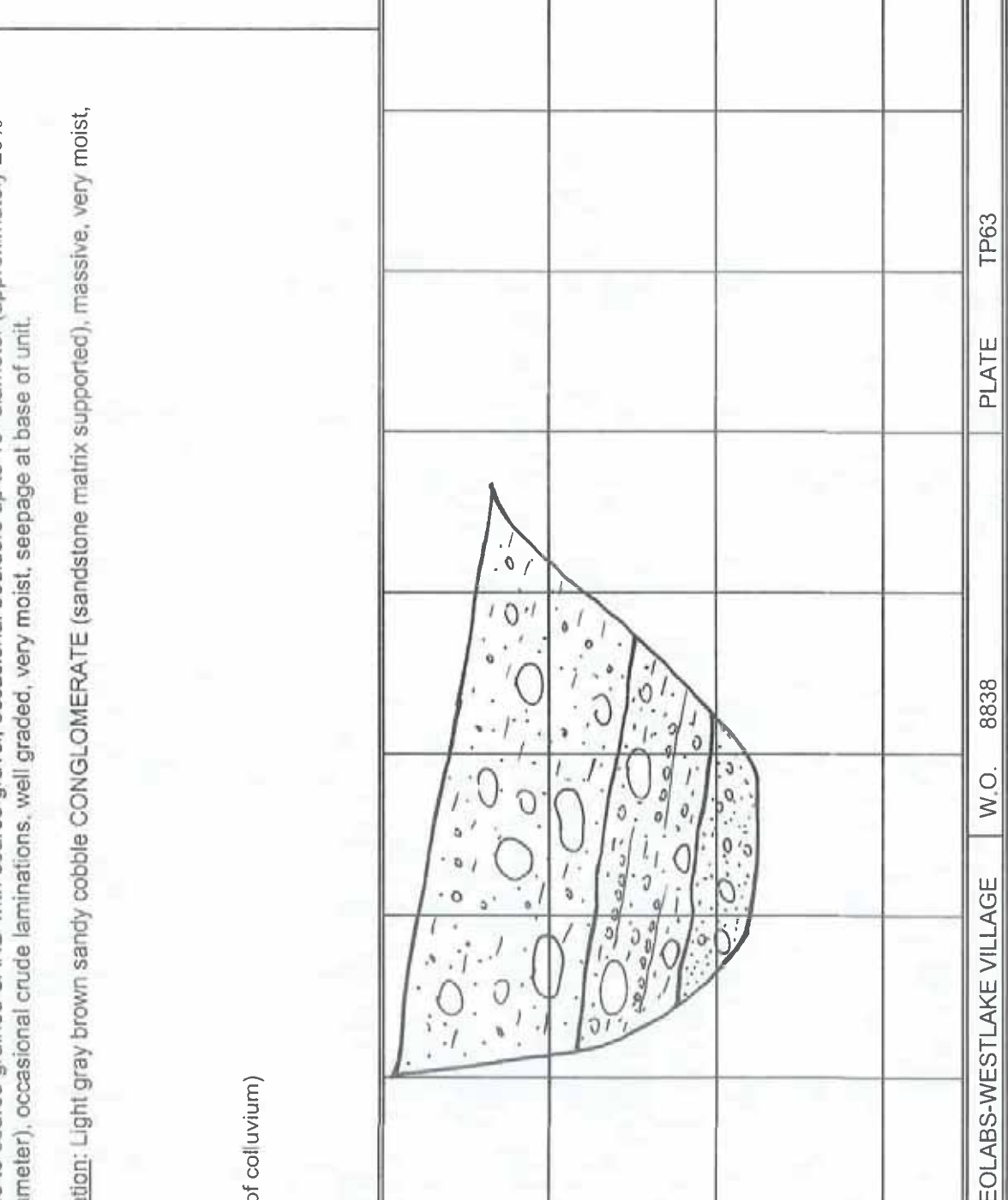
LOG OF EXCAVATION Trench No. TP62	Logged By: NM	Date Excavated: 5/25/06	Client: Pardee Homes
Depth (ft)	Description	Comments	
0 - 3	Topsoil: Dark brown silty clayey SAND with gravels and occasional boulders up to 2' diameter (approximately 10% greater than 12" diameter), porous, abundant roots, slightly moist, medium dense.		
3 - 9	Colluvium: Medium brown clayey SAND with abundant gravels, cobbles, and boulders (approximately 35% greater than 12" diameter, up to 3' diameter), subrounded to rounded clasts typically 12" to 18" diameter, well graded, moist, medium dense.		
9 - 11.5	Mint Canyon Formation: Light gray brown sandy gravel cobble CONGLOMERATE, moist, very dense.		
	Total Depth - 11.5' No groundwater No caving Backfilled		
Graphic Log			
scale 1" = 5'	GEOLABS-WESTLAKE VILLAGE	W.O. 8838	PLATE TP62

LOG OF EXCAVATION Trench No. TP63	Logged By: NM	Date Excavated: 5/25/06	Client: Pardee Homes
Depth (ft)	Description	Comments	
0 - 5	Colluvium: Medium brown clayey SAND with gravels and lesser cobbles and boulders (approximately 15% greater than 12" diameter), angular to rounded clasts typically 6" to 12" diameter, poorly sorted, moist, medium dense.		
5 - 8	Light gray brown fine to coarse grained SAND with coarse gravel, occasional boulders up to 18" diameter (approximately 20% greater than 12" diameter), occasional crude laminations, well graded, very moist, seepage at base of unit.		
8 - 10	<u>Mint Canyon Formation</u> : Light gray brown sandy cobble CONGLOMERATE (sandstone matrix supported), massive, very moist, very dense.		
Total Depth - 10' Seep at 8' (bottom of colluvium) No caving Backfilled			
Graphic Log			
scale 1" = 5'	GEOLABS-WESTLAKE VILLAGE	W.O. 8838	PLATE TP63

LOG OF EXCAVATION Trench No. TP64	Logged By: NM	Date Excavated: 5/25/06	Client: Pardee Homes
Depth (ft)	Description	Comments	
0 - 6.5	<p><u>Alluvium</u>: Medium brown silty clayey SAND with abundant gravels, cobbles, and boulders (approximately 50% greater than 12" diameter), boulders are typically 2' to 2.5' diameter (closely spaced), well graded, very moist to wet at base (seepage in bottom ±6" to 12"), loose to medium dense, bottom 2' is coarse grained.</p>		
6.5 - 8	<p><u>Mint Canyon Formation</u>: Light gray brown fine to coarse grained sandy gravel CONGLOMERATE to fine grained SANDSTONE, very moist, very dense.</p>		
<p>Total Depth - 8' Seep at 6.5' (bottom of alluvium) No caving Backfilled</p>			
Graphic Log			
<p>scale 1" = 5' GEOLABS-WESTLAKE VILLAGE W.O. 8838 PLATE TP64</p>			

LOG OF EXCAVATION		Logged By: NM	Date Excavated: 5/25/06	Client: Pardee Homes
Trench No. TP65				
Depth (ft)	Description	Comments		
0 - 6	Alluvium: Medium brown silty clayey SAND with abundant gravels, cobbles, and boulders (occasionally up to 3.5' diameter, approximately 55% greater than 12" diameter), bottom 12" is coarse grained SAND with seepage at base.			
6 - 8	Mint Canyon Formation: Light gray brown sandy gravel cobble CONGLOMERATE, very moist, very dense.			
Total Depth - 8' Seep at 6' (bottom of alluvium) No caving Backfilled				
Graphic Log				
scale 1" = 5'		GEOLABS-WESTLAKE VILLAGE	W.O. 8838	PLATE TP65

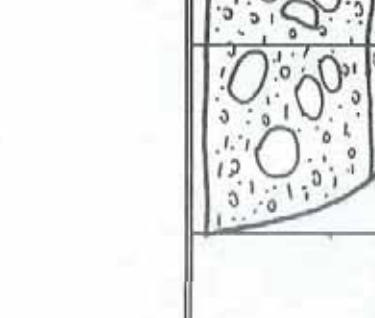
LOG OF EXCAVATION Trench No. TP66	Logged By: NM	Date Excavated: 5/25/06	Client: Pardee Homes
Depth (ft)	Description	Comments	
0 - 4	<p><u>Alluvium</u>: Medium brown silty SAND with abundant gravels, cobbles, and boulders (approximately 20% greater than 12" diameter), occasional clasts up to 3' diameter, well graded, loose to medium dense, wet in bottom 12". continuous slow seepage at base (bottom 12" is coarse grained).</p>		
4 - 5.5	<p><u>Mint Canyon Formation</u>: Light gray brown sandy gravel cobble CONGLOMERATE, very moist, very dense.</p>		
<p>Total Depth - 5.5' Seep at 4' (bottom of alluvium) No caving Backfilled</p>			
Graphic Log			
scale 1" = 5'		GEOLABS-WESTLAKE VILLAGE	W.O. 8838
		PLATE	TP66

LOG OF EXCAVATION Trench No. TP67	Logged By: NM	Date Excavated: 5/26/06	Client: Pardee Homes
Depth (ft)	Description	Comments	
0 - 6	<p><u>Alluvium</u>: Medium brown silty SAND with abundant gravels, cobbles, and boulders (approximately 35% greater than 12" diameter), subrounded to rounded clasts up to 3' diameter, well graded, moist to very moist at base, medium dense, minor seepage at base (bedrock contact).</p>		
6 - 7.5	<p><u>Mint Canyon Formation</u>: Light gray coarse grained CONGLOMERATE, very moist, very dense.</p>		
<p>Total Depth - 7.5' Seep at 6' (bottom of alluvium) No caving Backfilled</p>			
Graphic Log			
		GEOLABS-WESTLAKE VILLAGE	W.O. 8838
		PLATE	TP67

LOG OF EXCAVATION		Logged By: NM	Date Excavated: 5/26/06	Client: Pardee Homes
Trench No. TP68				
Depth (ft)	Description	Comments		
0 - 4	Alluvium: Medium brown silty SAND with abundant gravels, cobbles, and boulders (approximately 35% greater than 12" diameter), subangular to rounded clasts typically 1-2" diameter up to 3', well graded, moist, medium dense.			
4 - 6	Mint Canyon Formation: Light gray sandy gravel cobble CONGLOMERATE (sandstone matrix supported), moist, very dense.			
Total Depth - 6' No groundwater No caving Backfilled				
Graphic Log				
scale 1" = 5'		GEOLABS-WESTLAKE VILLAGE	W.O. 8838	PLATE TP68

LOG OF EXCAVATION		Logged By: NM	Date Excavated: 5/26/06	Client: Pardee Homes
Trench No. TP69				
Depth (ft)	Description	Comments		
0 - 3	<u>Topsoil:</u> Medium brown silty SAND with gravels and occasional cobbles and boulders (approximately 15% greater than 12" diameter), slightly moist, medium dense.			
3 - 9	<u>Alluvium:</u> Medium brown coarse grained gravelly SAND with abundant cobbles and boulders (approximately 25% greater than 12" diameter), well graded, subangular to rounded clasts typically 6" to 18" diameter (up to 3'), moist to wet at 8', medium dense.			
9 - 10.5	<u>Mint Canyon Formation:</u> Light gray gravel cobble CONGLOMERATE with sandstone supported matrix, very moist, very dense.			
Total Depth - 10.5' Seep at 9' (bottom of alluvium) No caving Backfilled				
Graphic Log				
scale 1" = 5'		GEOLABS-WESTLAKE VILLAGE	W.O. 8838	PLATE TP69

LOG OF EXCAVATION Trench No. TP70	Logged By: NM	Date Excavated: 5/26/06	Client: Pardee Homes
Depth (ft)	Description		
0 - 8	Alluvium: Medium brown silty clayey fine to coarse grained gravelly SAND with cobbles and lesser boulders (approximately 15% greater than 12" diameter), well graded, at 6' becoming very moist to wet, medium dense.		
8 - 9.5	Mint Canyon Formation: Light gray gravel cobble CONGLOMERATE with occasional boulders (approximately 12" diameter), moist very dense.		
Total Depth - 9.5' Wet from 6'-8' No caving Backfilled			
Graphic Log			
scale 1" = 5'			
GEOLABS-WESTLAKE VILLAGE		W.O. 8838	PLATE TP70

LOG OF EXCAVATION		Logged By: NM	Date Excavated: 5/26/06	Client: Pardee Homes
Trench No. TP71				
Depth (ft)	Description	Comments		
0 - 3	Alluvium: Light grayish brown sandy GRAVEL with abundant cobbles and boulders up to 3' diameter, typically 6" to 18" (approximately 25% greater than 12" diameter), medium dense to loose, slightly moist.			
3- 6.5	Medium brown clayey coarse grained gravelly SAND with abundant cobbles and boulders (approximately 35% greater than 12" diameter), clasts typically 8" to 18" diameter up to 3' (observed 5 at this size), well graded, very moist to wet at base (slow seepage at base).			
6.5 - 8	Mint Canyon Formation: Light gray sandy gravel cobble CONGLOMERATE, fine to medium sandstone matrix, very moist, very dense.			
Total Depth - 8' Seep at 6.5' (bottom of alluvium) No caving Backfilled				
Graphic Log				
scale 1" = 5'		GEOLABS-WESTLAKE VILLAGE	W.O. 8838	PLATE TP71

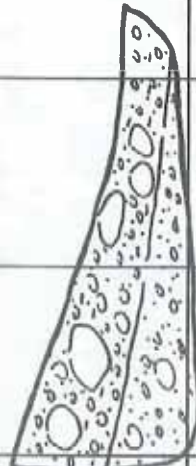
LOG OF EXCAVATION		Logged By: NM	Date Excavated: 5/26/06	Client: Pardee Homes
Trench No. TP72				
Depth (ft)	Description	Comments		
0 - 3	<p><u>Alluvium</u>: Medium brown silty fine grained SAND with abundant gravels, cobbles and lesser boulders (approximately 10% greater than 12" diameter) up to 24", matrix supported, well graded, wet, medium dense, continuous seepage at base.</p> <p><u>Mint Canyon Formation</u>: Light gray to greenish gray sandy gravel cobble CONGLOMERATE, very moist, very dense.</p> <p>Total Depth - 4' Seep at 3' (bottom of alluvium) No caving Backfilled</p>			
	<p>Graphic Log</p> 			
scale 1" = 5'		GEOLABS-WESTLAKE VILLAGE	W.O. 8838	PLATE TP72

LOG OF EXCAVATION		Logged By: NM	Date Excavated: 5/26/06	Client: Pardee Homes
Trench No. TP73				
Depth (ft)	Description	Comments		
0 - 3	<u>Topsoil</u> : Dark brown silty fine grained SAND with occasional gravels and cobbles, porous, abundant roots, moist, medium dense.			
3 - 8	<u>Alluvium</u> : Medium brown silty fine to coarse grained SAND with abundant gravels, cobbles, and boulders (approximately 35% greater than 12" diameter), subangular to rounded clasts up to 3' diameter, poorly sorted, slightly friable, moist, medium dense.			
8 - 10	Medium brown coarse grained SAND with gravels and cobbles (low amount of fines), well graded, friable, wet, dense, minor seepage at base.			
10 - 11	<u>Mint Canyon Formation</u> : Light greenish gray to light gray sandy gravel CONGLOMERATE, very moist, very dense.			
Total Depth - 11' Seep at 10' (bottom of alluvium) No caving Backfilled				
Graphic Log				
scale 1" = 5'		GEOLABS-WESTLAKE VILLAGE	W.O. 8838	PLATE TP73

LOG OF EXCAVATION		Logged By: NM	Date Excavated: 5/26/06	Client: Pardee Homes
Trench No. TP74				
Depth (ft)	Description	Comments		
0 - 4.5	Alluvium: Medium brown silty fine to coarse grained SAND with abundant gravels, cobbles, and boulders approximately 40% greater 12" diameter), several large rounded boulders up to 3.5' diameter, well graded, moist, medium dense to dense.			
4.5 - 5.5	Medium brown coarse grained gravelly SAND with occasional cobbles and boulders approximately 12" diameter, friable, water seeping at base, wet, dense.			
5.5 - 6.5	<u>Mint Canyon Formation</u> : Light greenish gray sandy gravel cobble CONGLOMERATE, very moist to wet, very dense, orange oxidation stains.			
Total Depth - 6.5' Seep at 5.5' (bottom of alluvium) No caving Backfilled				
Graphic Log				
scale 1" = 5'		GEOLABS-WESTLAKE VILLAGE	W.O. 8838	PLATE TP74

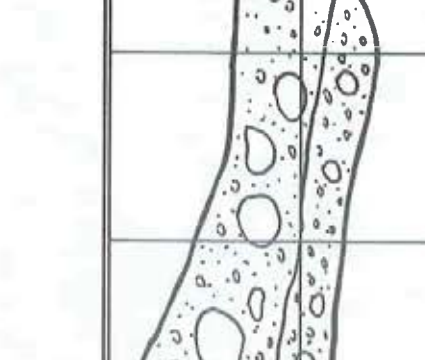
LOG OF EXCAVATION Trench No. TP75	Logged By: NM	Date Excavated: 5/26/06	Client: Pardee Homes
Depth (ft)	Description		
0 - 3.5	<p><u>Alluvium</u>: Medium brown silty fine to coarse grained SAND with abundant gravels, cobbles, and lesser boulders (approximately 20% greater than 12" diameter), well graded, very moist to wet at base, bottom 12" is silty coarse grained gravelly SAND, seepage at base, clasts typically 1' diameter and as coarse as 2' diameter.</p>		
3.5 - 5	<p><u>Mint Canyon Formation</u>: Light gray sandy gravel cobble CONGLOMERATE, very moist to wet, very dense.</p>		
<p>Total Depth - 5' Seep at 3.5' (bottom of alluvium) No caving Backfilled</p>			
Graphic Log			
scale 1" = 5'			
GEOLABS-WESTLAKE VILLAGE		W.O. 8838	PLATE TP75

Comments

LOG OF EXCAVATION		Logged By: NM	Date Excavated: 5/26/06	Client: Pardee Homes
Trench No. TP76				
Depth (ft)	Description	Comments		
0 - 11	<p><u>Colluvium</u>: Light medium brown fine to medium grained silty SAND with gravels and cobbles (approximately 20%), moderately graded, massive, rootlets down to 8', moist, medium dense (no boulders observed).</p> <p><u>Mint Canyon Formation</u>: Light greenish gray fine grained SANDSTONE with occasional cobbles and gravels, poorly graded, moist, very dense.</p> <p>Total Depth - 13' No groundwater No caving Backfilled</p>			
Graphic Log				
scale 1" = 5'		GEOLABS-WESTLAKE VILLAGE	W.O. 8838	PLATE TP76

LOG OF EXCAVATION		Logged By: NM	Date Excavated: 5/26/06	Client: Pardee Homes
Trench No. TP77				
Depth (ft)	Description	Comments		
0 - 1	<u>Topsoil</u> : Dark brown sandy CLAY, rootlets, occasional gravels, porous, slightly moist, medium stiff.			
1 - 4	<u>Colluvium</u> : Medium brown silty fine to medium grained SAND with gravels and cobbles up to 12" diameter (approximately 25% is coarse grained cobble), massive, slightly moist, medium dense.			
4 - 5.5	<u>Mint Canyon Formation</u> : Light greenish gray fine to medium grained SANDSTONE with occasional gravels, cobbles, moderately graded, moist, very dense.			
Total Depth - 5.5'				
No groundwater				
No caving				
Backfilled				
Graphic Log				
scale 1" = 5'		GEOLABS-WESTLAKE VILLAGE	W.O. 8838	PLATE TP77

LOG OF EXCAVATION
 Trench No. TP78
 Logged By: NM
 Date Excavated: 5/26/06
 Client: Pardee Homes

Comments

Description

0 - 4.5
 Alluvium: Medium brown silty SAND with abundant subangular to rounded gravels, cobbles and boulders (approximately 50% greater than 12" diameter), up to 3' diameter, boulders typically 1-2' diameter, well graded, moist, medium dense.

4.5 - 5.5
 Medium brown clayey coarse grained gravelly SAND with cobbles and lesser boulders up to 1' diameter, clasts are angular to rounded, low % of fines, well graded, very moist, dense.

5.5 - 7
 Mint Canyon Formation: Light greenish gray fine to very fine grained SANDSTONE, poorly graded, massive, moist, very dense.

Total Depth - 7'
 No groundwater
 No caving
 Backfilled

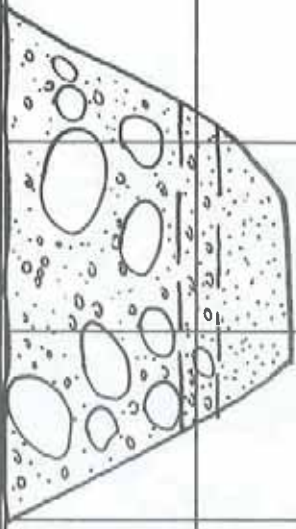

Graphic Log

scale 1" = 5'

GEOLABS-WESTLAKE VILLAGE W.O. 8838 PLATE TP78

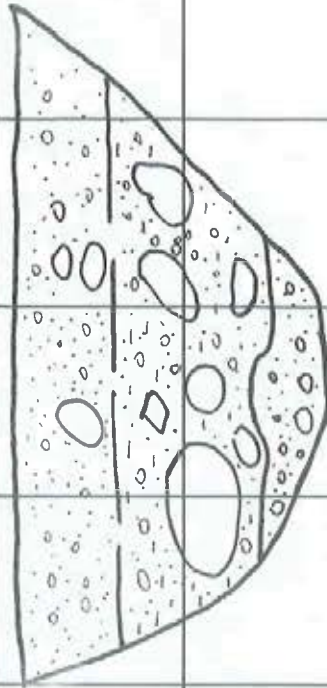
LOG OF EXCAVATION Trench No. TP79	Logged By: NM	Date Excavated: 6/1/06	Client: Pardee Homes
<p>Depth (ft)</p> <p>0 - 2.5</p> <p>2.5 - 6</p> <p>6 - 8</p>	<p>Description</p> <p>Alluvium: Light brown fine to coarse grained gravelly SAND with abundant cobbles and boulders (approximately 5% greater than 1' diameter), well graded, clasts are typically 3" to 1' diameter, friable, moist, medium dense.</p> <p>Medium brown silty fine to medium grained gravelly SAND with abundant cobbles and boulders (approx. 15% greater than 1' diameter) up to approximately 3' diameter, clasts are typically 6" to 1' diameter and are subrounded to rounded (mostly granitic), well graded, moist, medium dense.</p> <p>Mint Canyon Formation: Light greenish gray conglomeratic SANDSTONE with occasional cobbles, well graded, massive, moist, very dense.</p> <p>Total Depth - 8' No groundwater No caving Backfilled</p>	<p>Comments</p>	
<p>Graphic Log</p>			
<p>scale 1" = 5'</p>	<p>GEOLABS-WESTLAKE VILLAGE</p>	<p>W.O. 8838</p>	<p>PLATE TP79</p>

LOG OF EXCAVATION		Logged By: NM	Date Excavated: 6/1/06	Client: Pardee Homes
Trench No. TP80				
Depth (ft)	Description	Comments		
0 - 5	<p><u>Alluvium</u>: Medium brown silty fine to coarse grained gravelly SAND with abundant subangular to rounded cobbles and boulders (approximately 15% greater than 1' diameter), occasional pockets of clean gravelly SAND, well graded, clasts typically a few inches to 1' diameter and up to 2.5' diameter, friable, moist, medium dense.</p>			
5 - 7	<p><u>Mint Canyon Formation</u>: Grayish green to greenish gray fine to medium grained SANDSTONE with occasional white calcium carbonate stringers, poorly graded, occasional blocky planar randomly oriented fractures, moist to very moist, very dense.</p> <p>Total Depth - 7' No groundwater No caving Backfilled</p>			
Graphic Log				
scale 1" = 5'		GEOLABS-WESTLAKE VILLAGE	W.O. 8838	PLATE TP80

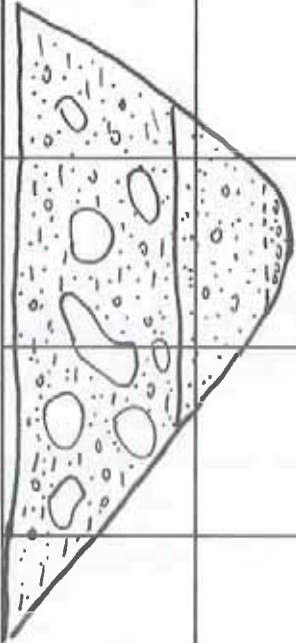
LOG OF EXCAVATION		Logged By: NM	Date Excavated: 6/1/06	Client: Pardee Homes
Trench No. TP81				
Depth (ft)	Description	Comments		
0 - 4	<p><u>Colluvium</u>: Medium brown silty fine grained SAND with subangular to rounded gravels, cobbles and boulders (approximately 10% greater than 1' diameter), clasts typically 1-2' diameter, well graded, moist, medium dense.</p> <p><u>Mint Canyon Formation</u>: Light greenish gray fine to medium grained SANDSTONE with dispersed gravels and cobbles, moderately graded, faint gradational contact at 7" to sandy CONGLOMERATE, calcium carbonate stringers, moist, very dense.</p>			
4 - 7.5	<p>Total Depth - 7.5'</p> <p>No groundwater</p> <p>No caving</p> <p>Backfilled</p>			
A Graphic Log				
scale 1" = 5'		GEOLABS-WESTLAKE VILLAGE	W.O. 8838	PLATE TP81

LOG OF EXCAVATION		Logged By: NM	Date Excavated: 6/1/06	Client: Pardee Homes
Trench No. TP82				
Depth (ft)	Description	Comments		
0 - 3	<u>Alluvium</u> : Medium brown silty fine to coarse grained SAND with gravels, cobbles, and boulders (approximately 10% greater than 1' diameter), clasts up to 2' diameter, well graded, very moist to wet with depth, continuous seepage at base, medium dense.			
3 - 6	<u>Mint Canyon Formation</u> : Light gray sandy gravel CONGLOMERATE with lesser cobbles and boulders (one or two up to approximately 14" diameter), very moist to wet, very dense. Total Depth - 6' Seep at 3' (bottom of alluvium) No caving Backfilled			
Graphic Log				
scale 1" = 5'		GEOLABS-WESTLAKE VILLAGE	W.O. 8838	PLATE TP82

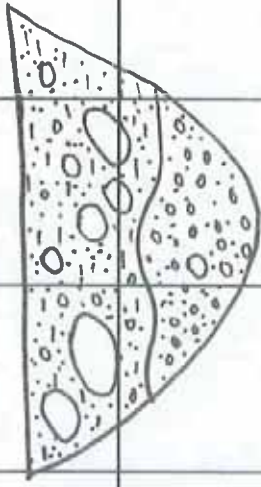

LOG OF EXCAVATION Trench No. TP83	Logged By: NM	Date Excavated: 6/1/06	Client: Pardee Homes
Depth (ft)	Description	Comments	
0 - 7	Alluvium: Medium to light brown silty fine to coarse grained gravelly SAND with abundant subangular to rounded cobbles and boulders (20% greater than 1' diameter), well graded, slightly friable, moist to very moist with depth, medium dense.		
7 - 9	Mint Canyon Formation: Light green gray sandy gravel CONGLOMERATE, very moist, very dense, sandstone matrix supported.		
Total Depth - 9' No groundwater No caving Backfilled			
Graphic Log			
scale 1" = 5'	GEOLABS-WESTLAKE VILLAGE	W.O. 8838	PLATE TP83

Depth (ft)	Description	Comments
0 - 1.5	<p><u>Topsoil</u>: Dark brown clayey sandy SILT with dispersed gravels, cobbles and boulders (2 clasts up to 2' diameter), abundant rootlets, porous, slightly moist, medium stiff (approx. 35% greater than 1' diameter).</p>	
1.5 - 4	<p><u>Alluvium</u>: Medium brown silty fine to medium grained SAND and gravelly SAND with abundant cobbles and boulders (approximately 35% greater than 1' diameter, 3 boulders as coarse as approximately 3' diameter), well graded, slightly friable, moist, medium dense.</p>	
4 - 5.5	<p><u>Mint Canyon Formation</u>: Light greenish gray gravel cobble CONGLOMERATE with fine to medium grained sandstone matrix, well graded, slightly moist, very dense.</p>	
<p>Total Depth - 5.5' No groundwater No caving Backfilled</p>		

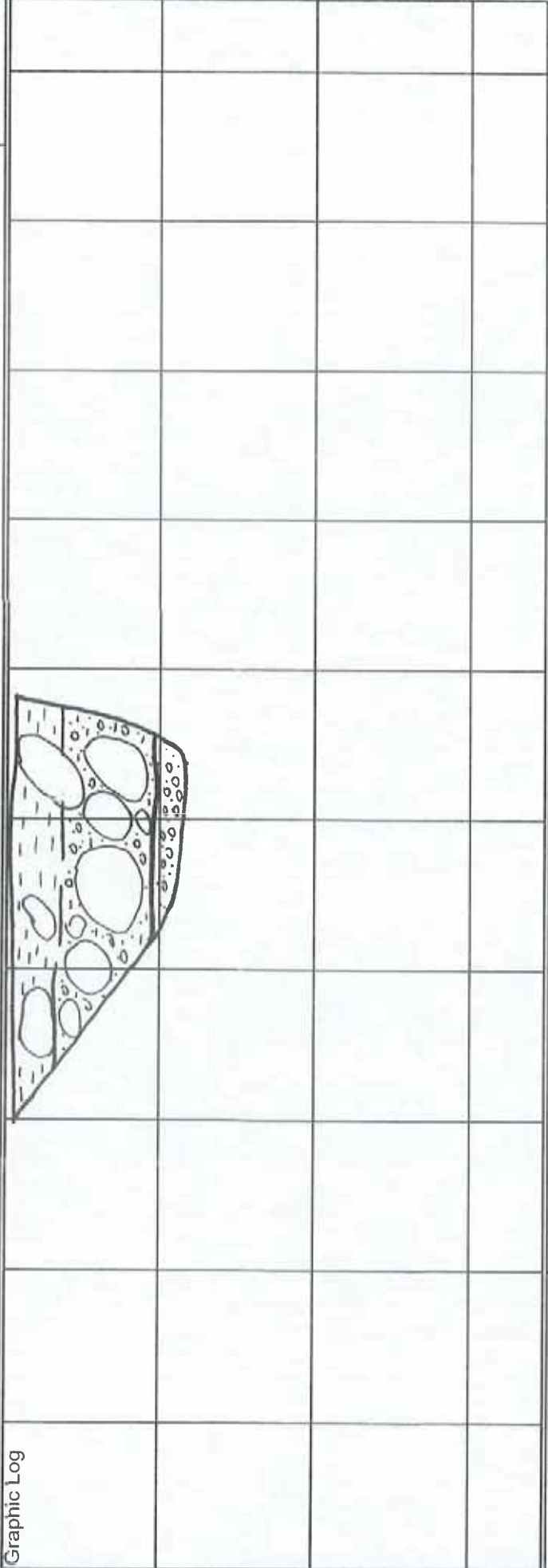

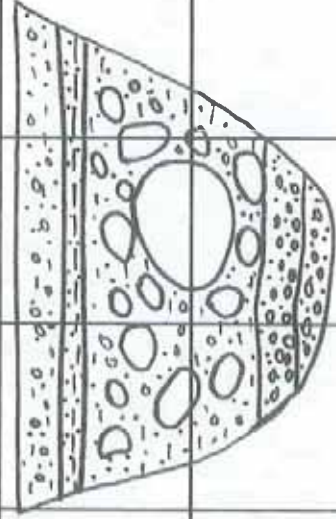
LOG OF EXCAVATION		Logged By: NM	Date Excavated: 6/1/06	Client: Pardee Homes
Trench No. TP85				
Depth (ft)	Description	Comments		
0 - 1	<u>Topsoil</u> : Medium brown silty fine to medium grained SAND with gravels and cobbles, well graded, rootlets, dry, medium dense.			
1 - 1.5	<u>Burn Horizon?</u> : Black silty fine grained SAND to sandy SILT with coarse sand and gravels, organic rich, abundant rootlets, porous, dry, medium dense to medium stiff.			
1.5 - 6	<u>Alluvium</u> : Medium brown silty fine to coarse grained gravelly SAND to sandy GRAVEL with abundant cobbles and boulders (approximately 20% greater than 1' diameter), well graded, angular to rounded clasts typically a few inches to approximately 1' diameter, slightly friable, slightly moist, medium dense.			
6 - 7	Light brown coarse grained sandy GRAVEL, well graded, friable, slightly moist, dense.			
7 - 8	<u>Mint Canyon Formation</u> : Light greenish gray sandy CONGLOMERATE, sandstone matrix supported, slightly moist, very dense.			
Total Depth - 8' No groundwater No caving Backfilled				
Graphic Log				
scale 1" = 5'		GEOLABS-WESTLAKE VILLAGE	W.O. 8838	PLATE TP85

LOG OF EXCAVATION		Logged By: NM	Date Excavated: 6/2/06	Client: Pardee Homes
Trench No. TP86				
Depth (ft)	Description	Comments		
0 - 5	<p><u>Alluvium</u>: Medium brown silty sandy GRAVEL with abundant cobbles and boulders (approximately 30% greater than 1' diameter), subangular to rounded granitic clasts typically a few inches to approx. 1' diameter up to approx. 2' diameter, predominantly cobbles and boulders (clast supported), well graded, moist to very moist with depth, medium dense.</p> <p>Medium brown coarse grained sandy GRAVEL with occasional cobbles, well graded, low % of fines, wet, continuous seepage at base.</p> <p><u>Mint Canyon Formation</u>: Light greenish gray coarse grained sandy gravel CONGLOMERATE, very moist to wet, very dense, difficult to excavate.</p>			
	<p>Total Depth - 7' Seep at 5.5' (bottom of alluvium) No caving Backfilled</p>			
Graphic Log				
scale 1" = 5'		GEOLABS-WESTLAKE VILLAGE	W.O. 8838	PLATE TP86

LOG OF EXCAVATION		Logged By: NM	Date Excavated: 6/2/06	Client: Pardee Homes
Trench No. TP87				
Depth (ft)	Description	Comments		
0 - 2	Alluvium: Medium brown silty fine to coarse grained SAND with gravels, cobbles, and boulders (approx. 15% greater than 1' diameter), subangular to rounded clasts typically a few inches to 1' diameter up to approx. 1.5' diameter, well graded, slightly moist to very moist at base, medium dense.			
2 - 5	Mint Canyon Formation: Light grayish green fine to medium grained SANDSTONE, poorly graded, massive, very moist, very dense, sparse cobbles in bottom 6".			
Total Depth - 5'				
No groundwater				
No caving				
Backfilled				
Graphic Log				
scale 1" = 5'		GEOLABS-WESTLAKE VILLAGE	W.O. 8838	PLATE TP87

LOG OF EXCAVATION		Logged By: NM	Date Excavated: 6/2/06	Client: Pardee Homes
Trench No. TP88				
Depth (ft)	Description	Comments		
0 - 6	<u>Colluvium</u> : Medium brown silty fine to medium grained SAND with scattered coarse sand, gravels, and lesser cobbles, matrix supported, crudely bedded, dipping gently toward canyon, moist, medium dense, porous, abundant rootlets.			
6 - 9	<u>Alluvium</u> : Medium brown silty fine to coarse grained gravelly SAND with abundant cobbles and boulders (approx. 10% greater than 1' diameter), subangular to rounded clasts typically a few inches to 1' diameter up to approx. 1.5' diameter, occasional pockets of friable medium to coarse sand, well graded, moist, medium dense.			
9 - 10.5	<u>Mint Canyon Formation</u> : Light greenish gray gravel to cobble CONGLOMERATE, massive, moist, very dense.			
Total Depth - 10.5'				
No groundwater				
No caving				
Backfilled				
Graphic Log				
scale 1" = 5'		GEOLABS-WESTLAKE VILLAGE	W.O. 8838	PLATE TP88

LOG OF EXCAVATION		Logged By: NM	Date Excavated: 6/2/06	Client: Pardee Homes
Trench No. TP89				
Depth (ft)	Description	Comments		
0 - 2.5	<p><u>Alluvium</u>: Medium brown silty fine to coarse grained SAND with subangular to rounded gravels, cobbles and boulders (approx. 30% greater than 1' diameter), clasts up to 2' diameter, typically a few inches to 1' diameter, well graded, moist, medium dense.</p> <p><u>Mint Canyon Formation</u>: Light greenish gray conglomeratic SANDSTONE, clasts predominantly gravel to cobble size, moist, dense.</p>			
2.5 - 4	<p>Total Depth - 4' No groundwater No caving Backfilled</p>			
Graphic Log				
scale 1" = 5'		GEOLABS-WESTLAKE VILLAGE	W.O. 8838	PLATE TP89

LOG OF EXCAVATION		Logged By: NM	Date Excavated: 6/2/06	Client: Pardee Homes
Trench No. TP90				
Depth (ft)	Description	Comments		
0 - 8	<u>Alluvium</u> : Medium brown clayey silty fine to coarse grained gravelly SAND with dispersed cobbles and boulders (approx. 10% greater than 1' diameter), clasts up to 2' diameter but typically a few inches to 12" diameter, occasional crude bedding, increasing moisture with depth, medium dense.			
8 - 9	Gradational irregular contact to medium brown gravelly SAND, well graded with occasional cobbles to boulders up to 14" diameter (approximately 5% greater than 1' diameter), very moist, dense.			
9 - 10.5	<u>Mint Canyon Formation</u> : Light green gray sandy CONGLOMERATE, moist, very dense.			
Total Depth - 10.5' No groundwater No caving Backfilled				
Graphic Log				
scale 1" = 5'		GEOLABS-WESTLAKE VILLAGE W.O. 8838 PLATE TP90		

LOG OF EXCAVATION		Logged By: NM	Date Excavated: 6/2/06	Client: Pardee Homes
Trench No. TP92				
Depth (ft)	Description	Comments		
0 - 4.5	<u>Colluvium</u> : Medium brown silty sandy CLAY to clayey SAND with gravels and lesser cobbles, porous, abundant rootlets, moist, medium dense.			
4.5 - 8.5	<u>Alluvium</u> : Medium brown silty fine to coarse grained gravelly SAND to sandy GRAVEL with abundant gravels and cobbles and lesser boulders (approximately 10% greater than 1'), boulders as coarse as approximately 2" diameter, well graded, moist, medium dense.			
8.5 - 11	Medium to light brown fine to coarse grained gravelly SAND with cobbles and boulders (approximately 15% greater than 1' diameter), well graded, low % of fines, moist to very moist, dense, boulders up to 2.5' diameter.			
11 - 12.5	<u>Mint Canyon Formation</u> : Light greenish gray sandy gravel CONGLOMERATE, moist, very dense.			
Total Depth - 12.5' No groundwater No caving Backfilled				
scale 1" = 5' A-41				
		GEOLABS-WESTLAKE VILLAGE	W.O. 8838	PLATE TP92

LOG OF EXCAVATION		Logged By: NM	Date Excavated: 6/2/06	Client: Pardee Homes
Trench No. TP93				
Depth (ft)	Description	Comments		
0 - 2.5	<u>Colluvium</u> : Medium brown clayey silty SAND with gravels and lesser cobbles and boulders (less than 15% is boulders), pinhole porosity, medium dense, moist.			
2.5 - 12	<u>Alluvium</u> : Light grayish brown fine to coarse grained gravelly SAND with abundant cobbles and occasional boulders (approx. 5% greater than 1' diameter), angular to rounded clasts (mostly subrounded), with very faint imbrication dipping gently (1°-3°) downslope, massive, slightly friable, rootlets, moist, medium dense to dense with depth.			
12 - 13.5	Faint contact to light brown fine to coarse grained gravelly SAND with cobbles and boulders (30% greater than 1' diameter), subangular to rounded clasts typically 6" to 14" up to 2.5' diameter, some boulders supported by fine to medium sand matrix, friable, slight caving, moist, dense, 14' maximum depth for backhoe, boulder on bottom won't break free enough to reach 13.5'			
Total Depth - 13.5'				
No groundwater				
No caving				
Backfilled				
Graphic Log				
scale 1" = 5'	GEOLABS-WESTLAKE VILLAGE	W.O.	8838	PLATE TP93

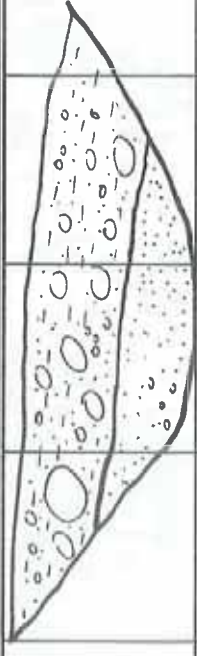
LOG OF EXCAVATION Trench No. TP94		Logged By: NM	Date Excavated: 6/5/06	Client: Pardee Homes
Depth (ft)	Description	Comments		
0 - 2.5	<p>Alluvium: Medium brown clayey silty SAND with dispersed gravels and cobbles, occasional boulders up to approx. 1.5' diameter (approx. 35% greater than 1' diameter), well graded, porous, rootlets, moist, medium dense.</p> <p>Mint Canyon Formation?: Light brown fine to medium grained SANDSTONE with occasional gravels and cobbles, moderately graded, moist, very dense, oxidation stains.</p> <p>Total Depth - 4' No groundwater No caving Backfilled</p>			
A403 Graphic Log				
				
scale 1" = 5'			W.O. 8838	PLATE TP94
GEO LABS-WESTLAKE VILLAGE				

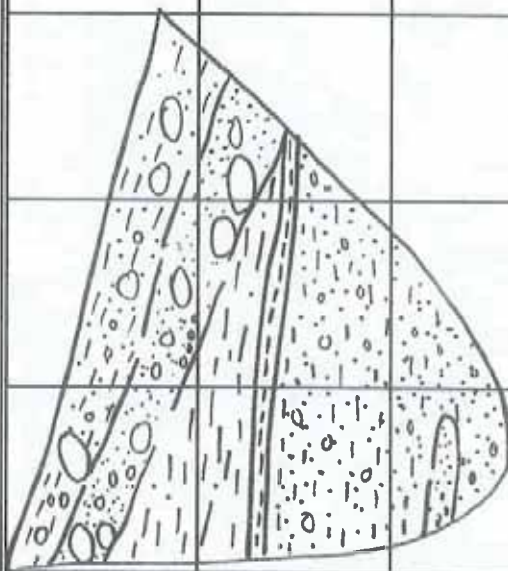
LOG OF EXCAVATION		Logged By: NM	Date Excavated: 6/5/06	Client: Pardee Homes
Trench No. TP95				
Depth (ft)	Description	Comments		
0 - 1.5	<u>Alluvium</u> : Medium brown silty SAND with gravels and cobbles, less than 25% is coarse grained, rootlets, moist, medium dense.			
1.5 - 3	Light grayish brown sandy GRAVEL to gravelly SAND with cobbles and lesser boulders (approximately 15% greater than 1' diameter) well graded, subrounded to rounded clasts typically a few inches to 10" diameter, moist, medium dense.			
3 - 5'3"	<u>Landslide Debris</u> : Red brown silty CLAY to CLAY with occasional coarse sand grains, very moist, medium stiff.			
5'3" - 5.5'	<u>Slide Plane</u> : Medium brown CLAY (high plasticity), abundant randomly oriented, polished shear surfaces, very moist, medium stiff			
5.5 - 12	<u>Mint Canyon Formation</u> : Mottled gray brown, orange brown and brown sandy CLAYSTONE to clayey SANDSTONE with abundant coarse sand grains and lesser gravels and cobbles, well graded, massive, very moist, very dense, occasional discontinuous pockets of orange brown fine to coarse grained SAND with occasional gravels and cobbles.			
Total Depth - 12' No groundwater No caving Backfilled				
Graphic Log				
scale 1" = 5'	GEOLABS-WESTLAKE VILLAGE	W.O.	8838	PLATE TP95

LOG OF EXCAVATION		Logged By: NM	Date Excavated: 6/5/06	Client: Pardee Homes
Trench No. TP96				
Depth (ft)	Description	Comments		
0 - 5	<p>Alluvium: Medium brown silty fine to coarse grained SAND with gravels, cobbles and boulders (approx. 10% greater than 1' diameter), subangular to rounded clasts typically a few inches to 1' diameter (predominantly cobbles and gravels), well graded, moist, medium dense.</p> <p>Mint Canyon Formation?: Light greenish gray gravel cobble CONGLOMERATE, moist, very dense, sandstone matrix supported.</p>			
5 - 7.5	<p>Total Depth - 7.5'</p> <p>No groundwater</p> <p>No caving</p> <p>Backfilled</p>			
Graphic Log				
scale 1" = 5'		GEOLABS-WESTLAKE VILLAGE	W.O. 8838	PLATE TP96

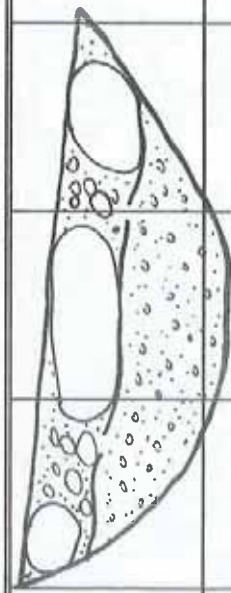
LOG OF EXCAVATION Trench No. TP97	Logged By: NM	Date Excavated: 6/5/06	Client: Pardee Homes
Depth (ft)	Description		Comments
0 - 2	Alluvium: Medium brown silty fine to coarse grained gravelly SAND with abundant cobbles and boulders (approx. 70% greater than 1' diameter), clasts are subangular to rounded and typically 6" to 2.5' diameter with a few boulders up to 3 or 4' diameter (one clast 4' by 2.5'), well graded, moist, medium dense.		
2 - 4.5	Mint Canyon Formation?: Light greenish gray medium to coarse grained CONGLOMERATE (sandstone matrix supported), moist, very dense, massive.		
	Total Depth - 4.5' No groundwater No caving Backfilled		
Graphic Log			
scale 1" = 5'	GEOLABS-WESTLAKE VILLAGE	W.O. 8838	PLATE TP97

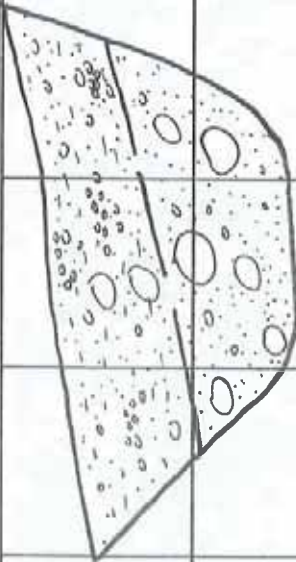
LOG OF EXCAVATION		Logged By: NM	Date Excavated: 6/5/06	Client: Pardee Homes
Trench No. TP98				
Depth (ft)	Description	Comments		
0 - 3	<u>Alluvium</u> : Medium brown clayey silty fine to coarse grained SAND with dispersed gravels and lesser cobbles (approx. 15%), well graded, moist, medium dense.			
3 - 6	<u>Saugus Formation?</u> : Light brown to tan fine to coarse grained SANDSTONE with gravels and lesser cobbles (occasional severely weathered granitic clast approx. 1' diameter), moderately graded, moist, very dense.			
Total Depth - 6' No groundwater No caving Backfilled				
Graphic Log				
scale 1" = 5'		GEOLABS-WESTLAKE VILLAGE	W.O. 8838	PLATE TP98

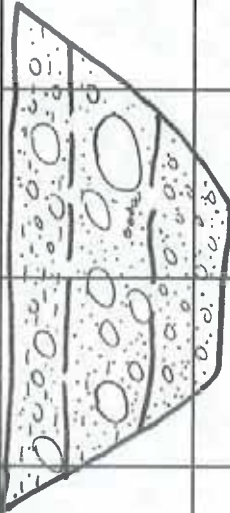
LOG OF EXCAVATION		Logged By: NM	Date Excavated: 6/5/06	Client: Pardee Homes
Trench No. TP99				
Depth (ft)	Description	Comments		
0 - 1.5	<u>Alluvium</u> : Medium brown silty SAND to sandy SILT with gravels, cobbles and sparse boulders (approx. 5% greater than 1" diameter) up to 1.5' diameter, moist, medium dense to medium stiff.			
1.5 - 3.5	Medium brown medium to coarse grained gravelly SAND with cobbles and occasional boulders (approx. 5% greater than 1" diameter), slightly friable, well graded, medium dense.			
3.5 - 5.5	<u>Mint Canyon Formation?</u> : Light greenish gray gravel cobble CONGLOMERATE, moist, very dense.			
	Total Depth - 5.5' No groundwater No caving Backfilled			
Graphic Log				
scale 1" = 5'	GEOLABS-WESTLAKE VILLAGE	W.O. 8838	PLATE	TP99

LOG OF EXCAVATION		Logged By: NM	Date Excavated: 6/6/06	Client: Pardee Homes
Trench No. TP100				
Depth (ft)	Description	Comments		
0 - 3	<p><u>Alluvium</u>: Medium brown silty SAND to sandy SILT with gravels, cobble, and lesser boulders (approx. 10% is boulder and 5% is greater than 1' diameter), clasts are subangular to rounded and typically a few inches to 1' diameter, well graded, moist, medium dense to medium stiff.</p>			
3 - 4	<p><u>Saugus Formation</u>: Light orangish brown medium to coarse grained sandy CONGLOMERATE, slightly moist, very dense, difficult to excavate.</p>			
	<p>Total Depth - 4' No groundwater No caving Backfilled</p>			
Graphic Log				
scale 1" = 5'		GEOLABS-WESTLAKE VILLAGE	W.O. 8838	PLATE TP100

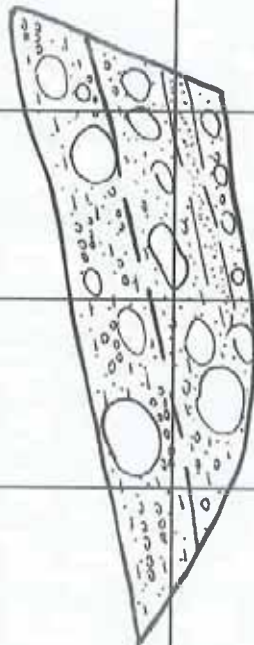
LOG OF EXCAVATION		Logged By: NM	Date Excavated: 6/6/06	Client: Pardee Homes
Trench No. TP101				
Depth (ft)	Description	Comments		
0 - 2	<u>Alluvium</u> : Medium brown silty clayey medium to coarse grained SAND with gravels, cobbles and lesser boulders (approx. 5% greater than 1' diameter), clasts are typically a few inches to 10" diameter up to 1.5'. moist, medium dense, porous.			
2 - 5	<u>Saugus Formation</u> : Light brown sandy CONGLOMERATE with 1' thick poorly graded discontinuous fine grained SANDSTONE interbed. Conglomerate is fine to medium grained sandstone matrix supported, moist, very dense, clasts are granitic and sedimentary (sandy claystone ripups or highly weathered volcanics).			
	Total Depth - 5' No groundwater No caving Backfilled			
Graphic Log				
scale 1" = 5'	GEOLABS-WESTLAKE VILLAGE	W.O. 8838	PLATE	TP101

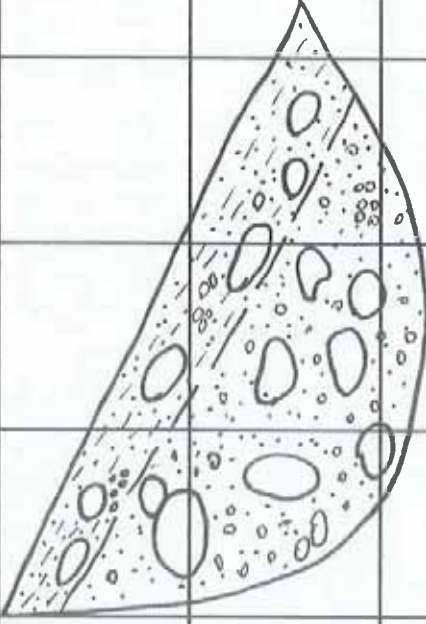
LOG OF EXCAVATION Trench No. TP102	Logged By: NM	Date Excavated: 6/6/06	Client: Pardee Homes
Depth (ft) 0 - 2 2 - 8.5	Description <u>Landslide Deposit:</u> Medium brown sandy CLAY with gravels, cobbles and occasional boulders up to 14" diameter, well graded, moist, medium stiff. <u>Saugus Formation?</u> : Light brown to light grayish brown gravel cobble CONGLOMERATE (medium grained sandstone matrix approximately 15% to 20%), granitic and lesser sedimentary clasts (bluish gray coarse grained sandy claystone), slightly moist, very dense, upper 1' is weathered/oxidized, approximately 5% are boulders up to 16" diameter. Total Depth - 8.5' No groundwater No caving Backfilled		
Comments			
scale 1" = 5'	GEOLABS-WESTLAKE VILLAGE	W.O. 8838	PLATE TP102

LOG OF EXCAVATION Trench No. TP103		Logged By: NM	Date Excavated: 6/6/06	Client: Pardee Homes
Depth (ft)	Description	Comments		
0 - 1.5	<u>Alluvium</u> : Light to medium brown fine to coarse grained SAND with gravels, cobbles and boulders (approximately 20% greater than 1' diameter up to 2'), approximately 30% is fine grained, loose, dry.			
1.5 - 3	<u>Saugus Formation?</u> : Light brown gravel cobble CONGLOMERATE, moist, very dense, difficult to excavate at 3'. Total Depth - 3' No groundwater No caving Backfilled			
Graphic Log				
scale 1" = 5'	GEOLABS-WESTLAKE VILLAGE	W.O. 8838	PLATE	TP103

LOG OF EXCAVATION		Logged By: NM	Date Excavated: 6/6/06	Client: Pardee Homes
Trench No. TP104				
Depth (ft)	Description	Comments		
0 - 8	<u>Landslide Debris</u> : Medium brown sandy CLAY to clayey SAND with scattered coarse sand and gravels, moist to very moist at 8', massive, medium dense to medium stiff.			
8 - 10.5	Irregular contact to light yellow brown fine to coarse grained SANDSTONE with gravels and cobbles, well graded, very moist to wet at base, 1' thick discontinuous orange brown interbed of silty SAND at 9-10', medium dense.			
10.5 - 11'8"	<u>Slide Plane?</u> : Medium brown CLAYSTONE (high plasticity) with abundant polished shears and mullion surfaces (discontinuous 6" thick interbed of fine grained silty sandstone at 11'), several gravels in claystone at base.			
11'8" - 13	<u>Saugus Formation?</u> : Medium brown sandy CLAYSTONE with coarse sand grains and lesser small gravels, massive, no shearing, increasingly more coarse sand with depth, moist very stiff to hard, small seepage in back corner of pit.			
Total Depth - 13' Seep at 13' No caving Backfilled				
Graphic Log				
scale 1" = 5'		GEOLABS-WESTLAKE VILLAGE	W.O. 8838	PLATE TP104

LOG OF EXCAVATION Trench No. TP105	Logged By: NM	Date Excavated: 6/6/06	Client: Pardee Homes	
Depth (ft)	Description			Comments
0 - 6	<u>Landslide Debris</u> : Medium orangish brown silty clayey fine to medium grained SAND with coarse sand and small gravels, occasional cobbles, well graded, massive, pinhole porosity, rootlets, slightly moist, medium dense.			
6 - 7	Irregular contact to medium brown CLAYSTONE with abundant polished shears/calcium carbonate specks, manganese stains, occasional small gravels and coarse sand grains, moist, medium stiff to stiff.			
7 - 7.5	Light brown clayey SILTSTONE to SILTSTONE, massive, moist, very stiff.			
7.5 - 8	Discontinuous light grayish brown fine to coarse SANDSTONE with gravels, moderately to well graded, slightly moist, very dense.			
8 - 8'3"	Light brown SILTSTONE, massive, moist, very stiff.			
@8'3"	2-3 mm thick claystone shear, over light brown silty very fine SANDSTONE, poorly graded, moist, massive, very dense.			
@8'9"	1/4" thick CLAYSTONE shear, irregular sharp contact.			
8'9.25" - 10	Medium brown sandy CLAYSTONE with dispersed coarse sand grains and very sparse small gravels, massive, moist, very stiff.			
10 - 12	Grades to light medium brown silty very fine grained SANDSTONE, massive, moist, very dense. Total Depth - 12'; No groundwater, No caving, Backfilled			
Graphic Log				
scale 1" = 5'	GEOLABS-WESTLAKE VILLAGE	W.O. 8838	PLATE	TP105

LOG OF EXCAVATION		Logged By: NM	Date Excavated: 6/7/06	Client: Pardee Homes
Trench No. TP106				
Depth (ft)	Description	Comments		
0 - 3	<u>Alluvium</u> : Medium brown silty clayey fine to coarse grained SAND to sandy CLAY with occasional gravels and very sparse cobbles and boulders up to 1' diameter, porous, rootlets, moist, medium stiff.			
3 - 7	<u>Saugus Formation?</u> : Reddish brown sandy MUDSTONE with coarse sand grains, moderately graded, massive, moist, seepage observed in small tight fractures at approximately 6'. Total Depth - 7' Seep at 6' No caving Backfilled			
Graphic Log				
scale 1" = 5'		GEOLABS-WESTLAKE VILLAGE	W.O. 8838	PLATE TP106

LOG OF EXCAVATION
Trench No. TP107

Logged By: NM

Date Excavated: 6/7/06

Client: Pardee Homes

Depth (ft)

Description

Comments

- 0 - 1 Alluvium: Dark brown sandy silty CLAY with occasional gravels and boulders (2-3 approx. 1' diameter), porous, moist, medium stiff.
- 1 - 3 Severely Weathered Saugus Formation: Medium brown gravel cobble CONGLOMERATE, clayey sand matrix supported, moist, medium dense to dense.
- 3 - 6 Saugus Formation: Light brown gravel cobble CONGLOMERATE with a 1' thick interbed of fine grained SANDSTONE from 4-5'.
Contacts are gradational, moist, very dense.

Total Depth - 6'
No groundwater
No caving
Backfilled

Graphic Log

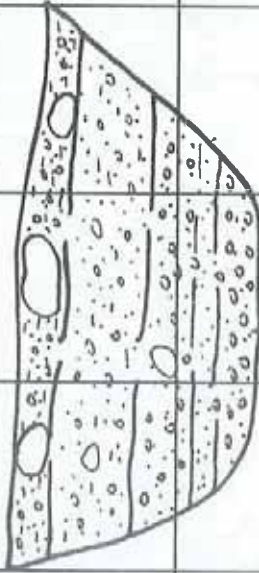

scale 1" = 5'

GEOLABS-WESTLAKE VILLAGE

W.O. 8838

PLATE

TP107

LOG OF EXCAVATION		Logged By: NM	Date Excavated: 6/7/06	Client: Pardee Homes
Trench No. TP108				
Depth (ft)	Description	Comments		
0 - 1	<u>Topsoil</u> : Dark brown sandy CLAY with dispersed gravels, cobbles, and occasional boulders, porous, slightly moist, medium stiff.			
1 - 2	<u>Alluvium</u> : Medium brown sandy CLAY with gravels, cobbles and occasional boulders (1 clast near surface is approx. 2' maximum diameter), typically 1-1.5' diameter, well graded, moist, rootlets, medium dense (approximately 3% greater than 1' diameter).			
2 - 3	<u>Saugus Formation</u> : Light brown to light reddish brown very fine to silty very fine grained SANDSTONE, wavy irregular contact above and below, upper few inches is weathered, poorly graded, moist, very dense.			
3 - 6	Light yellowish brown sandy CONGLOMERATE with several clasts up to approx. 1' diameter, fine to medium grained sandstone supported matrix, moist.			
	Total Depth - 6' No groundwater No caving Backfilled			
Graphic Log				
scale 1" = 5'		GEOLABS-WESTLAKE VILLAGE	W.O. 8838	PLATE TP108

LOG OF EXCAVATION Trench No. TP109		Logged By: NM	Date Excavated: 6/7/06	Client: Pardee Homes
Depth (ft)	Description	Comments		
0 - 3	<u>Alluvium</u> : Medium brown sandy CLAY to clayey SAND with abundant gravels, cobbles and boulders (approximately 20% greater than 1" diameter), several boulders up to approx. 2' diameter, slightly moist, medium dense.			
3 - 6	<u>Saugus Formation?</u> : Light brown sandy gravel cobble CONGLOMERATE, sandstone matrix supported, slightly moist, very dense. Total Depth - 6' No groundwater No caving Backfilled			
Graphic Log				
scale 1" = 5'		GEOLABS-WESTLAKE VILLAGE	W.O. 8838	PLATE TP109

LOG OF EXCAVATION		Logged By: NM	Date Excavated: 6/7/06	Client: Pardee Homes
Trench No. TP110				
Depth (ft)	Description	Comments		
0 - 3	<p><u>Alluvium</u>: Medium brown silty fine to coarse grained gravelly SAND with abundant cobbles and boulders (approximately 25% greater than 1' diameter), well graded, subangular to subrounded clasts typically 4-6" to approximately 1.5', moist, medium dense.</p> <p><u>Saugus Formation?</u>: Light brown sandy gravel cobble CONGLOMERATE, fine to medium grained sandstone matrix supported, moist, very dense.</p>			
3 - 4.5	<p>Total Depth - 4.5'</p> <p>No groundwater</p> <p>No caving</p> <p>Backfilled</p>			
Graphic Log				
scale 1" = 5'	GEOLABS-WESTLAKE VILLAGE	W.O. 8838	PLATE	TP110

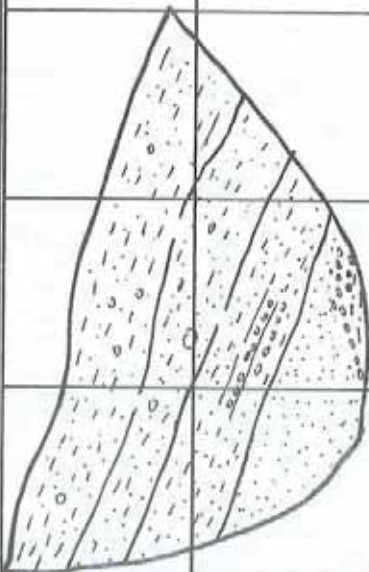
LOG OF EXCAVATION Trench No. TP111		Logged By: NM	Date Excavated: 6/7/06	Client: Pardee Homes
Depth (ft)	Description	Comments		
0 - 2	Colluvium: Dark brown sandy CLAY with occasional gravels, rootlets, porous, slightly moist, medium stiff.			
2 - 3	Gradational contact to reddish brown clayey SAND with occasional gravels and cobbles, massive, pinhole porosity, slightly moist, medium dense.			
3 - 5	Saugus Formation: Light reddish brown very fine grained silty SANDSTONE with occasional discontinuous coarse grained interbeds approximately 6" thick, poorly graded, moist, very dense.			
5 - 7.5	Gradational contact with light reddish brown fine grained SANDSTONE, poorly graded, massive, moist, very dense, scoured contact with discontinuous siltstone.			
	Total Depth - 7.5' No groundwater No caving Backfilled			
Graphic Log				
scale 1" = 5'	GEOLABS-WESTLAKE VILLAGE	W.O.	8838	PLATE TP111

LOG OF EXCAVATION
Trench No. TP112

Logged By: NM

Date Excavated: 6/7/06

Client: Pardee Homes

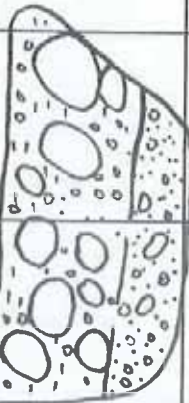
Depth (ft)	Description	Comments												
0 - 3	<p><u>Alluvium</u>: Medium brown clayey fine to coarse grained gravelly SAND with abundant cobbles and boulders (approximately 35% greater than 1' diameter), clasts typically 6" to 18" diameter (as coarse as 2.5" diameter), well graded, moist, medium dense.</p> <p><u>Saugus Formation?</u>: Light brown gravel cobble CONGLOMERATE with medium grained sandstone supported matrix, moist, very dense.</p> <p>Total Depth - 5' No groundwater No caving Backfilled</p>													
Graphic Log														
scale 1" = 5'	GEOLABS-WESTLAKE VILLAGE	W.O. 8838	PLATE	TP112										

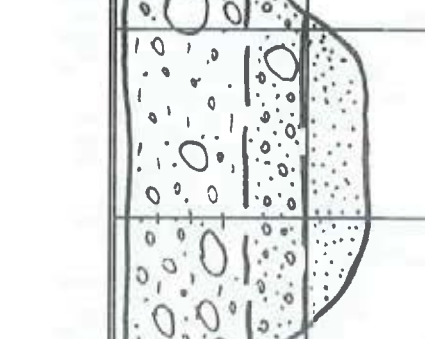
LOG OF EXCAVATION Trench No. TP113	Logged By: NM	Date Excavated: 6/7/06	Client: Pardee Homes
Depth (ft)	Description	Comments	
0 - 3	Alluvium: Medium brown sandy CLAY to clayey SAND with abundant gravels, cobbles and lesser boulders (approx. 10%) up to 1' diameter, well graded, rootlets, moist, medium dense.		
3 - 4.5	<u>Saugus Formation</u> : Light brown sandy CONGLOMERATE (matrix supported), occasional boulders approximately 1' diameter, moist, very dense.		
4.5 - 6	Irregular contact to light brown fine to very fine grained SANDSTONE, poorly graded, moist, very dense.		
Total Depth - 6' No groundwater No caving Backfilled			
A	Graphic Log		
scale 1" = 5'			
GEOLABS-WESTLAKE VILLAGE		W.O. 8838	PLATE TP113

LOG OF EXCAVATION		Logged By: NM	Date Excavated: 6/8/06	Client: Pardee Homes
Trench No. TP114				
Depth (ft)	Description	Comments		
0 - 2.5	<u>Alluvium</u> : Medium brown silty fine to coarse grained SAND with gravels and cobbles, slightly friable, rootlets, well graded, slightly moist, very dense.			
2.5 - 5	<u>Mint Canyon Formation?</u> : Mottled light greenish gray and reddish brown fine grained SANDSTONE with occasional coarse sand grains, poorly graded, massive, moist, very dense.			
5 - 6	Light greenish gray sandy CONGLOMERATE, irregular undulating contact, sandstone matrix supported, massive, moist, very dense.			
Total Depth - 6' No groundwater No caving Backfilled				
Graphic Log				
scale 1" = 5'		GEOLABS-WESTLAKE VILLAGE	W.O. 8838	PLATE TP114

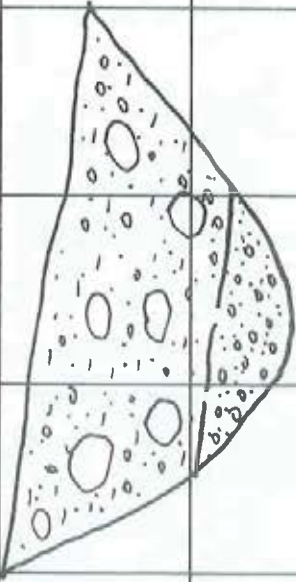
LOG OF EXCAVATION		Logged By: NM	Date Excavated: 6/8/06	Client: Pardee Homes
Trench No. TP115				
Depth (ft)	Description	Comments		
0 - 4.5	<u>Alluvium</u> : Medium brown clayey silty SAND with gravel, cobbles and boulders (approximately 10% greater than 1' diameter), subrounded clasts typically a few inches to approximately 1' diameter, moist, medium dense.			
4.5 - 6.5	<u>Mint Canyon Formation?</u> : Light greenish gray sandy gravel cobble CONGLOMERATE, moist, very dense (sandstone matrix supported).			
	Total Depth - 6.5' No groundwater No caving Backfilled			
Graphic Log				
scale 1" = 5'	GEOLABS-WESTLAKE VILLAGE	W.O. 8838	PLATE	TP115

LOG OF EXCAVATION		Logged By: NM	Date Excavated: 6/8/06	Client: Pardee Homes
Trench No. TP116				
Depth (ft)	Description	Comments		
0 - 4.5	Alluvium: Medium brown silty fine to coarse grained gravelly SAND with cobbles and lesser boulders (approximately 15%), several clasts up to approximately 2' diameter (fractures when hit with bucket) but typically 1-3" diameter, well graded, slightly friable in bottom 1' (less fines), moist, medium dense.			
4.5 - 6	Mint Canyon Formation?: Light gray gravel cobble CONGLOMERATE, moist, very dense, massive.			
	Total Depth - 6' No groundwater No caving Backfilled			
Graphic Log				
scale 1" = 5'		GEOLABS-WESTLAKE VILLAGE	W.O. 8838	PLATE TP116

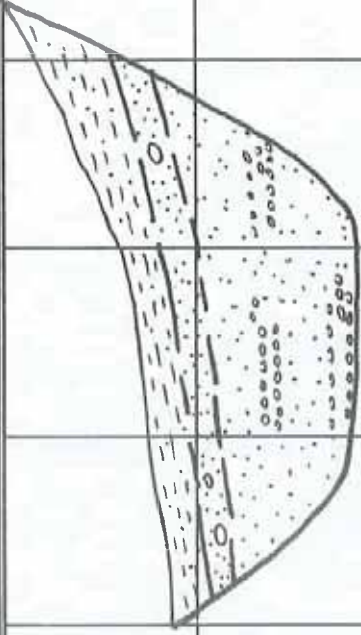
LOG OF EXCAVATION		Logged By: NM	Date Excavated: 6/8/06	Client: Pardee Homes
Trench No. TP117				
Depth (ft)	Description			
0 - 1	Alluvium: Dark brown sandy CLAY, porous, rootlets, moist.			
1 - 2	Severely Weathered Saugus Formation: Gradational contact to medium brown and reddish brown clayey SANDSTONE with occasional cobbles, porous, moist, medium dense.			
2 - 6	Saugus Formation: Mottled reddish brown and light gray fine grained SANDSTONE with crude discontinuous conglomeratic sandstone interbeds approx. 1' thick, moist to very moist at depth, very dense.			
	Total Depth - 6' No groundwater No caving Backfilled			
Graphic Log				
scale 1" = 5'		GEOLABS-WESTLAKE VILLAGE	W.O. 8838	PLATE TP117
Comments				

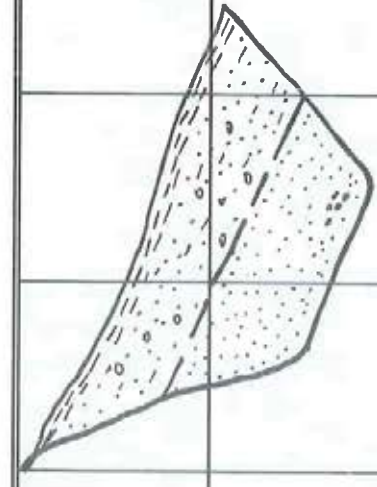
LOG OF EXCAVATION		Logged By: NM	Date Excavated: 6/8/06	Client: Pardee Homes
Trench No. TP118				
Depth (ft)	Description	Comments		
0 - 1	<u>Topsoil</u> : Dark brown sandy CLAY with occasional gravels, porous, moist, rootlets, medium stiff.			
1 - 2.5	<u>Colluvium</u> : Medium brown clayey SAND with occasional gravels and cobbles, porous, moist, medium dense.			
2.5 - 5.5	<u>Saugus Formation</u> : Light reddish brown fine grained SANDSTONE with occasional scattered gravels and cobbles, poorly graded, massive, moist, very dense.			
	Total Depth - 5.5' No groundwater No caving Backfilled			
Graphic Log				
scale 1" = 5'		GEOLABS-WESTLAKE VILLAGE	W.O. 8838	PLATE TP118

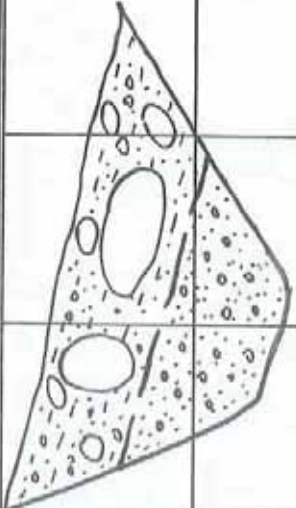
LOG OF EXCAVATION Trench No. TP119		Logged By: NM	Date Excavated: 6/8/06	Client: Pardee Homes
Depth (ft)	Description	Comments		
0 - 3	<u>Alluvium</u> : Medium brown clayey silty fine to coarse grained SAND with gravels, cobbles and boulders (approximately 15% greater than 1" diameter), angular to rounded clasts typically a few inches to 8" diameter with 4 or 5 clasts up to approximately 1.5-2' diameter, moist, medium dense.			
3 - 6	<u>Saugus Formation</u> : Light brown and light greenish gray sandy CONGLOMERATE (1-2 clasts are approximately 1' diameter and highly fractured), moist, very dense. Total Depth - 6' No groundwater No caving Backfilled			
Graphic Log				
scale 1" = 5'		GEOLABS-WESTLAKE VILLAGE	W.O. 8838	PLATE TP119

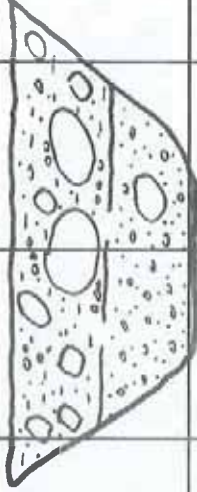
LOG OF EXCAVATION		Logged By: NM	Date Excavated: 6/8/06	Client: Pardee Homes
Trench No. TP120				
Depth (ft)	Description	Comments		
0 - 2.5	<u>Alluvium</u> : Medium brown clayey silty SAND with abundant gravels, cobbles and lesser boulders (approx. 10-15% greater than 1' diameter) up to 2' diameter, well graded, moist, medium dense.			
2.5 - 4.5	<u>Saugus Formation</u> : Light brown sandy CONGLOMERATE with occasional boulders approximately 1' diameter, moist, very dense.			
	Total Depth - 4.5' No groundwater No caving Backfilled			
Graphic Log				
scale 1" = 5'	GEOLABS-WESTLAKE VILLAGE	W.O. 8838	PLATE	TP120

LOG OF EXCAVATION		Logged By: NM	Date Excavated: 6/8/06	Client: Pardee Homes
Trench No. TP121				
Depth (ft)	Description	Comments		
0 - 3	<p><u>Alluvium</u>: Medium brown silty clayey SAND with abundant gravels, cobbles and boulders (approximately 25% greater than 1" diameter), well graded, moist, medium dense, coarse sand at approximately 2-3'.</p> <p><u>Saugus Formation</u>: Light yellow brown medium to coarse grained SANDSTONE with scattered gravels and lesser cobbles, moderately graded, very moist, very dense.</p> <p>Total Depth - 6' No groundwater No caving Backfilled</p>			
Graphic Log				
scale 1" = 5'		GEOLABS-WESTLAKE VILLAGE	W.O. 8838	PLATE TP121

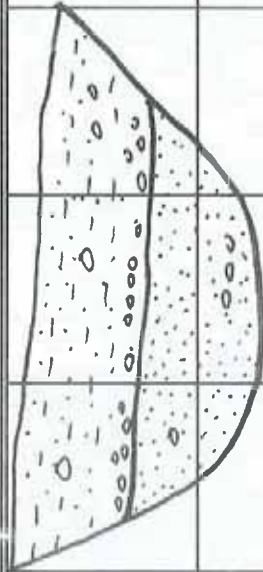
LOG OF EXCAVATION Trench No. TP122	Logged By: NM	Date Excavated: 6/8/06	Client: Pardee Homes
Depth (ft)	Description		
0 - 3	<p><u>Colluvium</u>: Dark brown sandy CLAY with scattered gravels and cobbles (approximately 5% are gravel to cobble clasts), rootlets, porous, moist, medium stiff.</p>		
3 - 6	<p><u>Saugus Formation</u>: Sharp contact with light brown fine grained SANDSTONE with occasional scattered gravels and lesser cobbles, massive, poorly graded, moist, very dense, color change to light reddish brown at 5.5'.</p>		
<p>Total Depth - 6' No groundwater No caving Backfilled</p>			
Graphic Log			
scale 1" = 5'	GEOLABS-WESTLAKE VILLAGE	W.O. 8838	PLATE TP122

LOG OF EXCAVATION		Logged By: NM	Date Excavated: 6/8/06	Client: Pardee Homes
Trench No. TP123				
Depth (ft)	Description	Comments		
0 - 1	<u>Topsoil</u> : Dark brown sandy CLAY with scattered gravels, moist, rootlets, medium stiff.			
1 - 2.5	<u>Colluvium</u> : Medium brown sandy CLAY to clayey SAND with gravels and occasional cobbles to boulders up to approximately 14" diameter, moist, medium stiff to medium dense.			
2.5 - 5	<u>Saugus Formation</u> : Light brown and light reddish brown sandy CONGLOMERATE, fine to coarse grained sandstone supported matrix, moist, very dense.			
Total Depth - 5' No groundwater No caving Backfilled				
Graphic Log				
scale 1" = 5'		GEOLABS-WESTLAKE VILLAGE	W.O. 8838	PLATE TP123

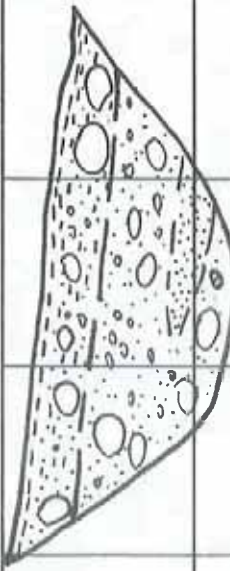
LOG OF EXCAVATION		Logged By: NM	Date Excavated: 6/9/06	Client: Pardee Homes
Trench No. TP124				
Depth (ft)	Description	Comments		
0 - 0.5	<u>Topsoil</u> : Dark brown sandy CLAY with gravels and cobbles, rootlets, porous, moist, medium stiff.			
0.5 - 1.5	<u>Alluvium</u> : Medium brown sandy CLAY with abundant gravels, cobbles and lesser boulders (approximately 5%), angular to rounded granitic clasts up to approx. 1' diameter, well graded, moist, medium dense.			
1.5 - 5	<u>Saugus Formation</u> : Gradational contact to mottled light reddish brown and light greenish gray gravel cobble CONGLOMERATE with a discontinuous 1' thick interbed of light gray silty fine grained SANDSTONE at 3-4', moist, very dense. Total Depth - 5' No groundwater No caving Backfilled			
				
Graphic Log				
scale 1" = 5'				
		GEOLABS-WESTLAKE VILLAGE	W.O. 8838	PLATE TP124

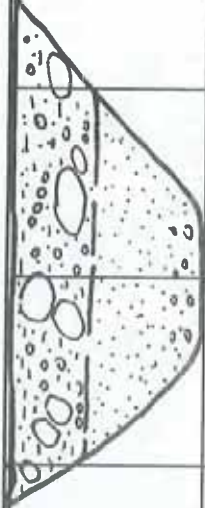
LOG OF EXCAVATION		Logged By: NM	Date Excavated: 6/9/06	Client: Pardee Homes
Trench No. TP125				
Depth (ft)	Description	Comments		
0 - 2	<u>Alluvium</u> : Medium brown to medium orangish brown clayey SAND with abundant gravels, cobbles and lesser boulders (approximately 10%), angular to subrounded clasts up to 18" diameter (approximately 10% greater than 12" diameter), abundant rootlets, moist, medium dense, clear contact with unit below.			
2 - 4	<u>Saugus Formation</u> : Yellow brown fine grained SANDSTONE, poorly graded, moist, massive, very dense.			
4 - 5	Grading to fine grained SANDSTONE with gravels (approximately 35%), moist, very dense.			
	Total Depth - 5' No groundwater No caving Backfilled			
Graphic Log				
scale 1" = 5'	GEOLABS-WESTLAKE VILLAGE	W.O. 8838	PLATE	TP125

Depth (ft)	Description	Comments
0 - 2	<p>Alluvium: Medium brown to reddish brown (with depth) sandy CLAY to clayey SAND with abundant gravels, cobbles, and lesser boulders (approximately 15% greater than 1' diameter), 1 or 2 boulders up to 1.5' diameter, porous, moist, medium dense.</p>	
2 - 5	<p>Saugus Formation; Yellow brown fine and fine to coarse grained SANDSTONE with scattered gravels and cobbles, massive, moist, very dense.</p>	
<p>Total Depth - 5' No groundwater No caving Backfilled</p>		

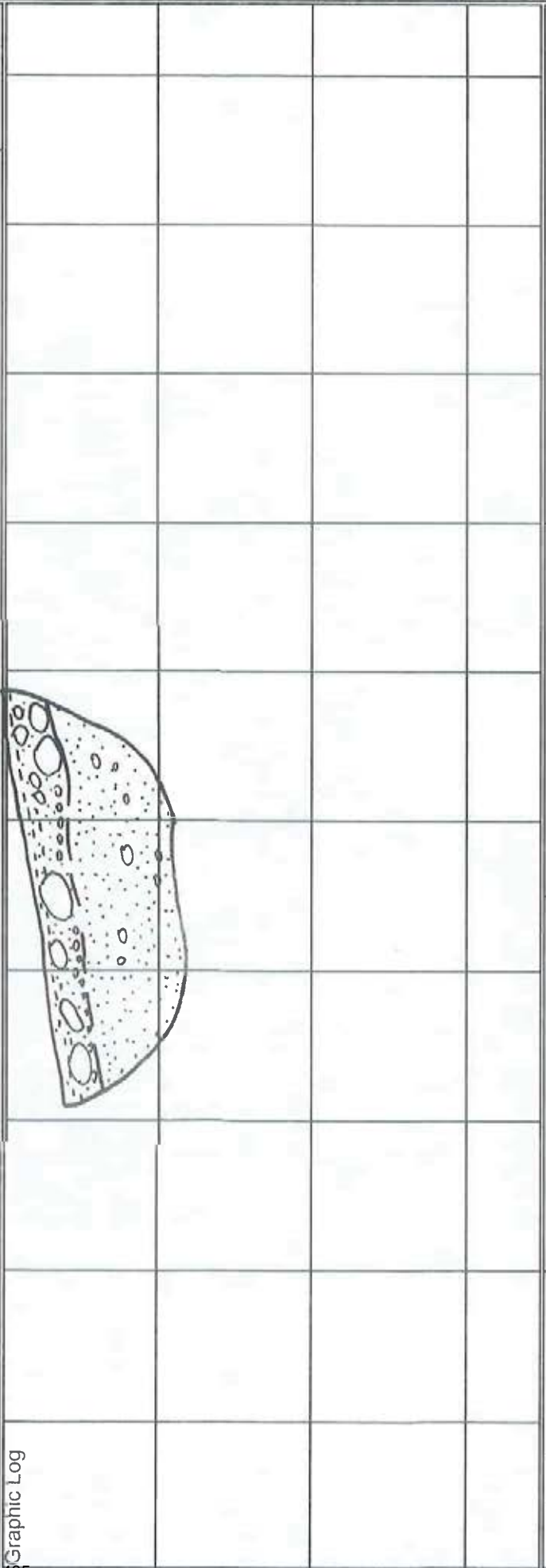

LOG OF EXCAVATION		Logged By: NM	Date Excavated: 6/9/06	Client: Pardee Homes
Trench No. TP127				
Depth (ft)	Description	Comments		
0 - 2	Alluvium: Medium brown silty clayey SAND with abundant gravels, cobbles, and lesser boulders up to approximately 1' diameter, well graded, moist, medium dense.			
2 - 5	<u>Saugus Formation</u> : Sharp contact to yellowish brown fine to coarse grained conglomeratic SANDSTONE (approximately 50% is sandstone), moist, very dense, massive.			
	Total Depth - 5' No groundwater No caving Backfilled			
Graphic Log				
scale 1" = 5'		GEOLABS-WESTLAKE VILLAGE	W.O. 8838	PLATE TP127

LOG OF EXCAVATION		Logged By: NM	Date Excavated: 6/9/06	Client: Pardee Homes
Trench No. TP128				
Depth (ft)	Description	Comments		
0 - 1.5	<u>Alluvium</u> : Medium brown clayey SAND with abundant gravels, cobbles and boulders (2-3 boulders up to 2' diameter), becoming more sandy with depth, well graded, moist, medium dense.			
1.5 - 2.5	<u>Saugus Formation</u> : Orangish brown coarse grained CONGLOMERATE, moist, very dense, clasts commonly gravel and cobble, slightly undulating crude contact with unit below.			
2.5 - 4	Light yellow brown fine grained SANDSTONE, poorly graded, moist, massive, very dense, faint crude contact with unit below.			
4 - 5	Light yellow brown conglomeratic SANDSTONE (approximately 50% fines), moderately graded, moist, very dense.			
Total Depth - 5' No groundwater No caving Backfilled				
A-16 Graphic Log				
scale 1" = 5'		GEOLABS-WESTLAKE VILLAGE	W.O. 8838	PLATE TP128

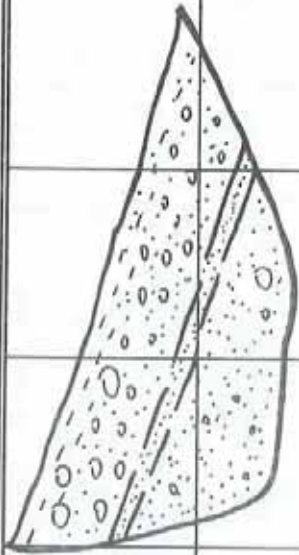
LOG OF EXCAVATION		Logged By: NM	Date Excavated: 6/9/06	Client: Pardee Homes
Trench No. TP129				
Depth (ft)	Description	Comments		
0 - 2.5	<u>Colluvium</u> : Medium brown sandy CLAY with abundant subrounded to rounded gravels and cobbles, slightly moist, rootlets, medium dense.			
2.5 - 3	<u>Weathered Saugus Formation</u> : Gradational contact to orangish brown medium to coarse grained SANDSTONE, moderately graded, slightly moist, dense.			
3 - 6	<u>Saugus Formation</u> : Light yellow brown medium to coarse grained SANDSTONE with scattered gravels (approximately 15%), moderately graded, massive, moist, very dense.			
	Total Depth - 6' No groundwater No caving Backfilled			
Graphic Log				
scale 1" = 5'	GEOLABS-WESTLAKE VILLAGE	W.O. 8838	PLATE	TP129

Depth (ft)	Description	Comments
0 - 1.5	<u>Topsoil/Dump Fill</u> : Dark brown sandy clayey SILT with abundant pieces of small trash (bottles, tin, plastic), dry, loose.	
1.5 - 2.5	<u>Weathered Saugus Formation</u> : Light brown silty fine to coarse grained SANDSTONE with gravels, moderately graded, slightly friable, moist, medium dense.	
2.5 - 3'4"	<u>Saugus Formation</u> : Medium brown SILTSTONE to clayey SILTSTONE, massive, moist, hard.	
3'4" - 3'5"	Medium brown CLAYSTONE with pervasive internal shears, not highly polished, moist, very stiff.	
3'5" - 6	Light medium brown MUDSTONE with abundant white round specs (1-2mm), massive, moist, hard.	
Total Depth - 6' No groundwater No caving Backfilled		

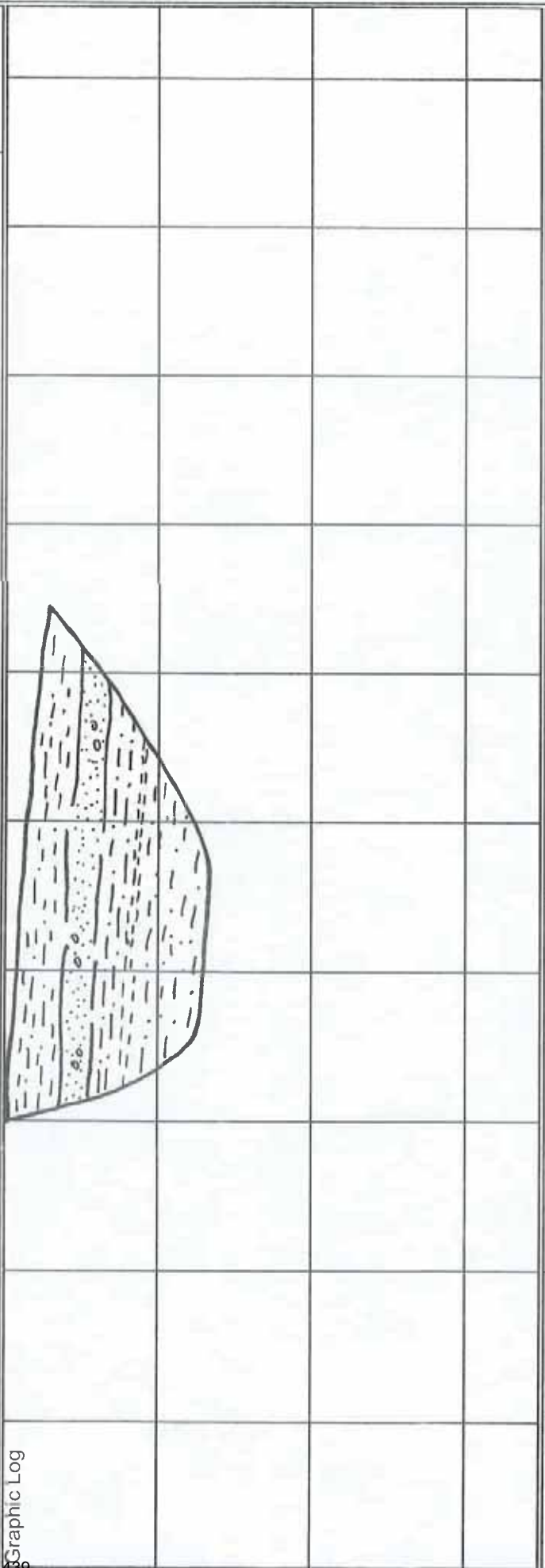

LOG OF EXCAVATION		Logged By: NM	Date Excavated: 6/9/06	Client: Pardee Homes
Trench No. TP131				
Depth (ft)	Description	Comments		
0 - 2	<u>Dump Fill/Colluvium</u> : Medium brown clayey silty SAND with gravels, cobbles, and occasional boulders up to approximately 1' diameter, abundant trash (glass, tin, metal pipe), porous, moist, medium dense.			
2 - 3	<u>Severely Weathered Saugus Formation</u> : Orange brown medium to coarse grained SANDSTONE with gravels and cobbles, moderately graded, slightly moist, dense.			
3 - 5	<u>Saugus Formation</u> : Light brown fine to coarse grained SANDSTONE with scattered gravels (approximately 25%), massive, moderately graded, moist, very dense.			
	Total Depth - 5' No groundwater No caving Backfilled			
Graphic Log				
scale 1" = 5'		GEOLABS-WESTLAKE VILLAGE	W.O. 8838	PLATE TP131

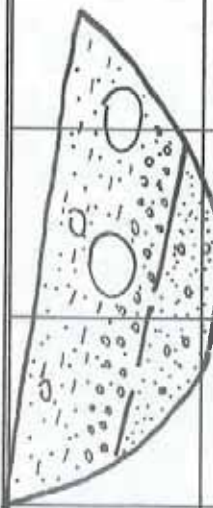
LOG OF EXCAVATION Trench No. TP132		Logged By: NM	Date Excavated: 6/9/06	Client: Pardee Homes
Depth (ft)	Description	Comments		
0 - 3	<u>Dump Fill/Colluvium</u> : Medium brown clayey silty SAND with gravels, cobbles and boulders (approximately 10%), with 2-3 clasts up to approximately 1.5' diameter, abundant trash (mostly metal cans/boxes) in upper 2.5', dry, loose.			
3 - 4.5	<u>Saugus Formation</u> : Light yellow brown medium to coarse grained SANDSTONE with scattered gravels (approximately 30%), moderately graded, massive, moist, very dense.			
	Total Depth - 4.5' No groundwater No caving Backfilled			
Graphic Log				
scale 1" = 5'	GEOLABS-WESTLAKE VILLAGE	W.O.	8838	PLATE TP132

LOG OF EXCAVATION		Logged By: NM	Date Excavated: 6/9/06	Client: Pardee Homes
Trench No. TP133				
Depth (ft)	Description	Comments		
0 - 3	<u>Topsoil</u> : Medium brown clayey silty SAND with occasional gravels, slightly moist, porous, medium dense, occasional old metal pipe.			
3 - 5.5	<u>Colluvium</u> : Light medium brown silty fine to medium grained SAND and clayey SAND with occasional gravels, slightly moist, medium dense.			
5.5 - 6'3"	<u>Saugus Formation</u> : Medium brown clayey SILTSTONE to silty CLAYSTONE with occasional claystone fragments, massive, moist, very stiff.			
6'3" - 7'3"	Light grayish brown fine to medium grained SANDSTONE, moderately graded, slightly moist, very dense.			
7'3" - 8	Medium brown clayey fine grained SANDSTONE with coarse sand grains, slightly moist, very dense.			
Total Depth - 8' No groundwater No caving Backfilled				
Graphic Log				
scale 1" = 5'		GEOLABS-WESTLAKE VILLAGE	W.O. 8838	PLATE TP133

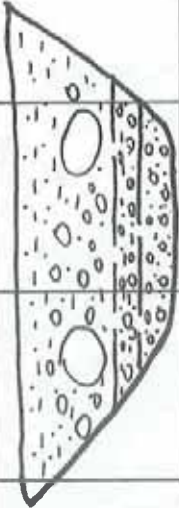
LOG OF EXCAVATION		Logged By: NM	Date Excavated: 6/12/06	Client: Pardee Homes
Trench No. TP134				
Depth (ft)	Description	Comments		
0 - 2.5	Alluvium: Medium brown sandy CLAY with gravels, cobbles and occasional boulders (approximately 2-3% greater than 1' diameter), subangular to rounded clasts typically a few inches to 8" diameter, well graded, dry to slightly moist with depth, medium dense, rootlets coarser grained with depth.			
2.5 - 3	Severely Weathered Saugus Formation: Gradational contact to orange brown CONGLOMERATE with sandy clay matrix, occasional rootlets, moist, dense.			
3 - 4	Saugus Formation: Mottled light reddish brown and light greenish gray CONGLOMERATE with fine to medium grained sandstone matrix (approximately 15%), moist, very dense.			
Total Depth - 4' No groundwater No caving Backfilled				
Graphic Log				
scale 1" = 5'		GEOLABS-WESTLAKE VILLAGE	W.O. 8838	PLATE TP134

LOG OF EXCAVATION		Logged By: NM	Date Excavated: 6/12/06	Client: Pardee Homes
Trench No. TP135				
Depth (ft)	Description	Comments		
0 - 2	<u>Alluvium</u> : Medium brown sandy CLAY with subangular to subrounded gravels, cobbles, and occasional boulders up to approximately 1' diameter, clasts typically 3" diameter, well graded, dry to moist with depth, medium dense, rootlets, porous.			
2 - 3	<u>Saugus Formation</u> : Light orangish brown medium to coarse grained SANDSTONE with gravels (10-15%), moderately graded with crude faint flat lying contacts, moist, very dense.			
3 - 4	Light yellow brown medium to coarse grained SANDSTONE with very sparse gravels (less than 10%), moderately graded, moist, very dense.			
4 - 5	Crude faint contact to light yellow brown medium to coarse grained gravelly SANDSTONE, moderately graded, moist, very dense.			
Total Depth - 5' No groundwater No caving Backfilled				
Graphic Log				
scale 1" = 5'		GEOLABS-WESTLAKE VILLAGE	W.O. 8838	PLATE TP135

LOG OF EXCAVATION
 Trench No. TP136

Logged By: NM

Date Excavated: 6/12/06

Client: Pardee Homes

Comments

Depth (ft)

0 - 2

Alluvium: Medium brown sandy CLAY with gravels, cobbles, and boulders (approximately 15% greater than 1' diameter), subangular to subrounded clasts up to 2' diameter, rootlets, well graded, slightly moist, medium dense.

2 - 4

Saugus Formation: Light yellow brown gravelly SANDSTONE with occasional oxidation stains, moderately graded, moist, very dense.

4 - 6

Light yellow brown medium to coarse grained SANDSTONE with sparse gravels and cobbles, moderately graded, massive, moist, very dense.

Total Depth - 6'

No groundwater

No caving

Backfilled

Graphic Log

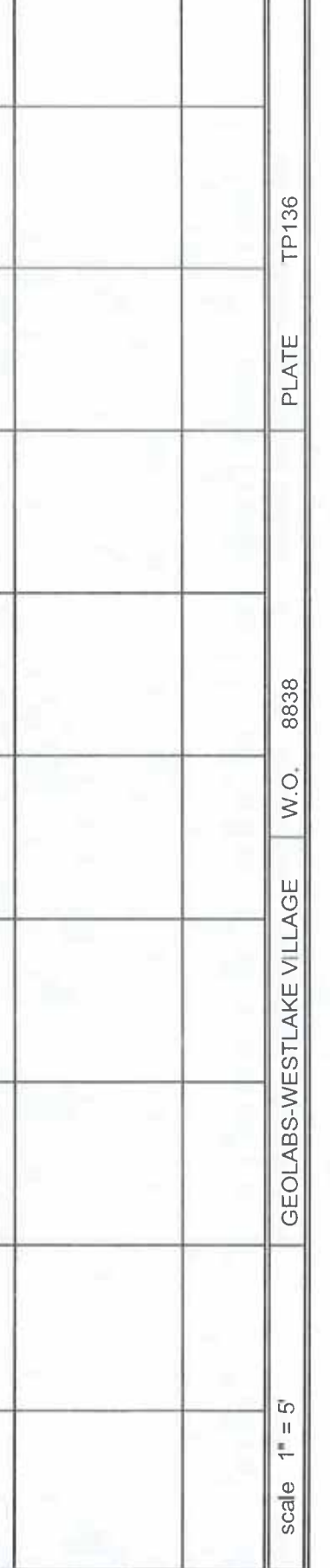

scale 1" = 5'

GEOLABS-WESTLAKE VILLAGE W.O. 8838

PLATE TP136

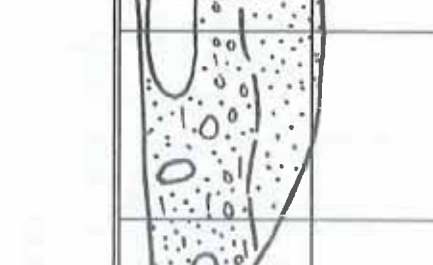
LOG OF EXCAVATION Trench No. TP137	Logged By: JN	Date Excavated: 6/12/06	Client: Pardee Homes
Depth (ft)	Description		
0 - 2.5	Alluvium: Medium brown sandy CLAY with subangular to subrounded gravels, cobbles and boulders, rootlets, well graded, slightly moist, medium dense (several large boulders approximately 3' diameter), gradational undulatory contact.		
2.5 - 4.5	Mint Canyon Formation: Light greenish gray fine grained SANDSTONE, slight orange brown oxidation, poorly graded, massive, very dense, moist.		
Total Depth - 4.5'			
No groundwater			
No caving			
Backfilled			
Graphic Log			
scale 1" = 5'	GEOLABS-WESTLAKE VILLAGE	W.O. 8838	PLATE TP137
Comments			

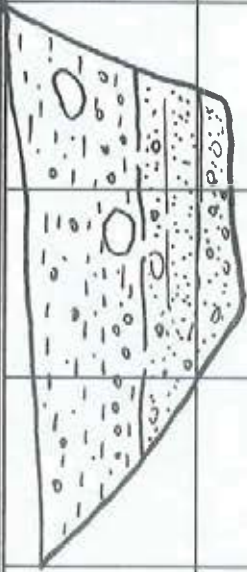
LOG OF EXCAVATION		Logged By: NM	Date Excavated: 6/12/06	Client: Pardee Homes
Trench No. TP138				
Depth (ft)	Description	Comments		
0 - 3	<p><u>Colluvium</u>: Dark brown sandy silty CLAY with scattered gravels and cobbles (occasional boulders up to approximately 1' diameter), well graded, porous, rootlets, dry to moist at depth, medium dense, trash in upper 1' (metal scraps).</p>			
3 - 5.5	<p><u>Saugus Formation</u>: Mottled light greenish gray and light reddish brown gravel cobble CONGLOMERATE with a discontinuous 1' thick interbed of light reddish brown fine grained SANDSTONE (from 3.5-4.5'), moist, very dense.</p> <p>Total Depth - 5.5' No groundwater No caving Backfilled</p>			
<p>Graphic Log</p> 				
<p>scale 1" = 5'</p>		<p>GEOLABS-WESTLAKE VILLAGE W.O. 8838 PLATE TP138</p>		

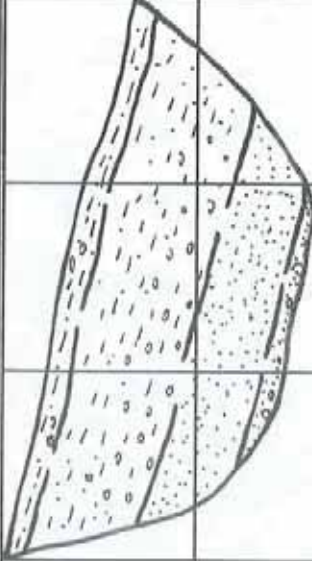
LOG OF EXCAVATION		Logged By: NM	Date Excavated: 6/12/06	Client: Pardee Homes
Trench No. TP139				
Depth (ft)	Description	Comments		
0 - 1	<u>Topsoil</u> : Dark brown clayey SILT with occasional gravels and cobbles, porous, rootlets, medium dense.			
1 - 4	<u>Alluvium</u> : Medium brown sandy CLAY with abundant fine gravels and lesser coarse gravels and cobbles, well graded, massive, moist, medium stiff.			
4 - 5.5	<u>Saugus Formation</u> : Medium orange brown to light reddish brown fine to medium grained SANDSTONE, moderately graded, massive, moist, very dense, small calcium carbonate specs.			
5.5 - 6	Gradational contact to light greenish gray fine grained SANDSTONE with angular to subrounded gravel and cobbles at 5.5', poorly to moderately graded, moist, very dense.			
	Total Depth - 6' No groundwater No caving Backfilled			
Graphic Log				
scale 1" = 5'		GEOLABS-WESTLAKE VILLAGE	W.O. 8838	PLATE TP139

LOG OF EXCAVATION		Logged By: NM	Date Excavated: 6/12/06	Client: Pardee Homes
Trench No. TP140				
Depth (ft)	Description	Comments		
0 - 3.5	Alluvium: Medium brown sandy CLAY to clayey SAND with abundant subangular to rounded gravel, cobble, and boulders (approximately 25% greater than 1' diameter), abundant rootlets, pinhole porosity, grading to coarse grained SAND at 2.5'; well graded.			
3.5 - 6	Saugus Formation: Tan to light brown fine to medium grained SANDSTONE, massive, moist, very dense, occasional gravels.			
	Total Depth - 6' No groundwater No caving Backfilled			
Graphic Log				
scale 1" = 5'		GEOLABS-WESTLAKE VILLAGE	W.O. 8838	PLATE TP140

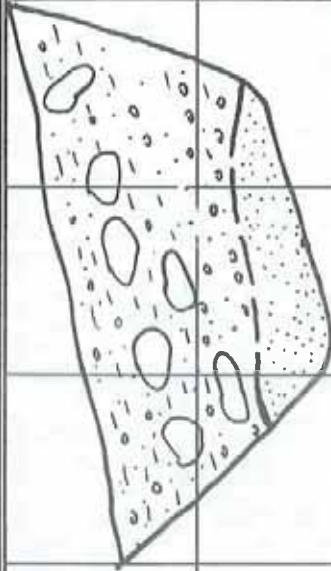

LOG OF EXCAVATION
 Trench No. TP141

Logged By: NM

Date Excavated: 6/13/06

Client: Pardee Homes

Depth (ft)

0 - 1.5

1.5 - 5

Description

Colluvium: Medium brown silty SAND with gravels, porous, well graded, roots, medium dense.

Saugus Formation: Light orangish brown fine to coarse grained SANDSTONE with abundant gravels and cobbles, clasts are typically 3" to 10" diameter, massive, moist, very dense.

Total Depth - 5'

No groundwater

No caving

Backfilled

Comments									

scale 1" = 5'

GEOLABS-WESTLAKE VILLAGE W.O. 8838

PLATE TP141

LOG OF EXCAVATION		Logged By: NIM	Date Excavated: 6/13/06	Client: Pardee Homes
Trench No. TP-142				
Depth (ft)	Description	Comments		
0 - 1.5	<u>Colluvium</u> : Medium brown clayey fine to coarse grained SAND with abundant gravels and cobbles (several boulders up to approximately 1-2' diameter at surface), well graded, medium dense, dry.			
1.5 - 2	<u>Severely Weathered Saugus Formation</u> : Orange brown coarse grained sandy gravel cobble CONGLOMERATE with clay in matrix, moist, dense.			
2 - 5.5	<u>Saugus Formation</u> : Light brown to light orange brown sandy gravel cobble CONGLOMERATE (sandstone matrix supported), massive, moist, very dense.			
Total Depth - 5.5'				
No groundwater				
No caving				
Backfilled				
Graphic Log				
scale 1" = 5'		GEOLABS-WESTLAKE VILLAGE W.O. 8838 PLATE TP142		

LOG OF EXCAVATION
 Trench No. TP143
 Logged By: NM
 Date Excavated: 6/13/06
 Client: Pardee Homes

Depth (ft)	Description	Comments
0 - 3.5	<u>Colluvium</u> : Medium brown sandy CLAY with scattered gravels and cobbles, occasional boulders up to 1' diameter, porous, moist, roots, medium stiff.	
3.5 - 4.5	<u>Weathered Saugus Formation</u> : Gradational contact to medium brown sandy gravel cobble CONGLOMERATE with sandy clay matrix, rootlets, slightly moist, medium dense.	
4.5 - 6.5	<u>Saugus Formation</u> : Light brown sandy gravel cobble CONGLOMERATE, massive, moist, very dense.	
6.5 - 7	Irregular scoured contact to light brown very fine grained SANDSTONE, poorly graded, moist, massive, very dense.	
	Total Depth - 7' No groundwater No caving Backfilled	

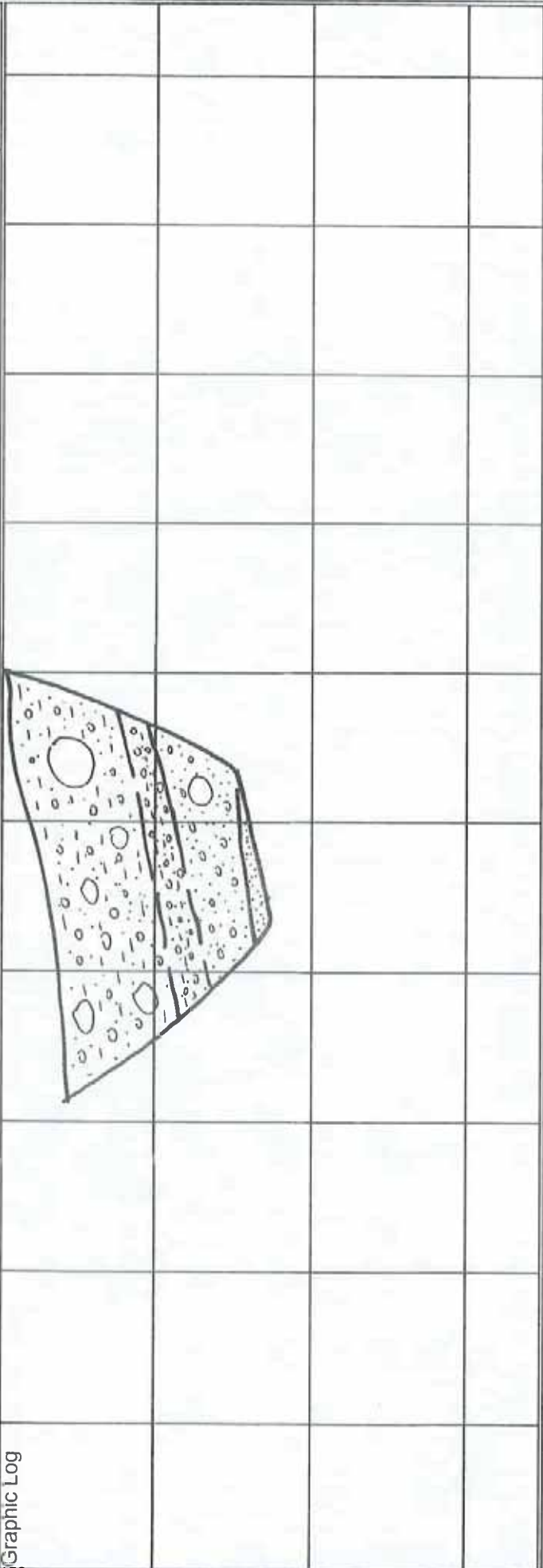

scale 1" = 5'

GEOLABS-WESTLAKE VILLAGE W.O. 8838 PLATE TP143

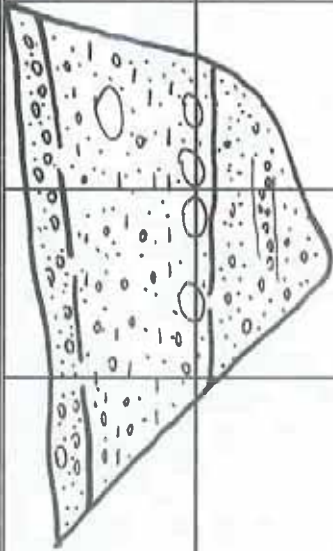
LOG OF EXCAVATION		Logged By: NM	Date Excavated: 6/13/06	Client: Pardee Homes
Trench No. TP144				
Depth (ft)	Description	Comments		
0 - 1	<u>Topsoil</u> : Medium brown clayey SAND to sandy CLAY with abundant gravels and cobbles, well graded, roots, slightly moist, medium dense to medium stiff.			
1 - 4.5	<u>Colluvium</u> : Medium brown sandy CLAY with scattered gravels and cobbles (higher % of clasts from 3.5-4.5' depth), occasional rootlets, moist, stiff.			
4.5 - 7	<u>Saugus Formation</u> : Light brown medium to coarse grained gravelly SANDSTONE with a 1' thick discontinuous interbed of gravel CONGLOMERATE from 5-6', moist, very dense.			
	Total Depth - 7' No groundwater No caving Backfilled			
Graphic Log				
scale 1" = 5'	GEOLABS-WESTLAKE VILLAGE	W.O. 8838	PLATE	TP144

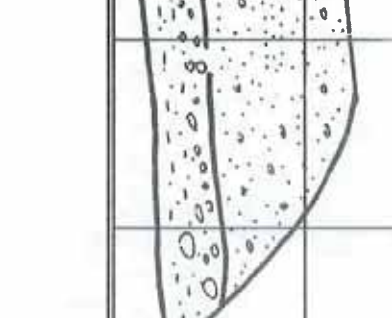
LOG OF EXCAVATION Trench No. TP145	Logged By: NM	Date Excavated: 6/13/06	Client: Pardee Homes
Depth (ft)	Description		
0 - 1.5	<p>Colluvium: Medium brown silty clayey SAND with gravels and cobbles (mostly in bottom 6"), well graded, porous, rootlets, slightly moist to moist with depth, medium dense.</p>		
1.5 - 5	<p>Saugus Formation: Light yellow brown sandy gravel CONGLOMERATE to conglomeratic fine to medium grained SANDSTONE, moderately to well graded, moist, very dense.</p>		
<p>Total Depth - 5' No groundwater No caving Backfilled</p>			
Graphic Log			
scale 1" = 5'	GEOLABS-WESTLAKE VILLAGE	W.O. 8838	PLATE TP145

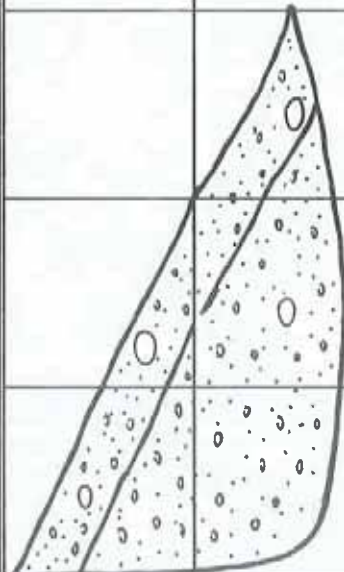
LOG OF EXCAVATION Trench No. TP146		Logged By: NM	Date Excavated: 6/13/06	Client: Pardee Homes
Depth (ft)	Description	Comments		
0 - 1.5	<u>Colluvium</u> : Medium brown fine to coarse grained SAND with gravel to sandy GRAVEL (mostly fine gravels), rootlets, slightly moist, medium dense.			
1.5 - 7	<u>Landside Deposit (remnant Saugus Formation)</u> : Light yellow brown coarse grained fine gravel CONGLOMERATE, massive, moist, very dense. Total Depth - 7' No groundwater No caving Backfilled			
Graphic Log				
				
scale 1" = 5'	GEOLABS-WESTLAKE VILLAGE	W.O. 8838	PLATE	TP146

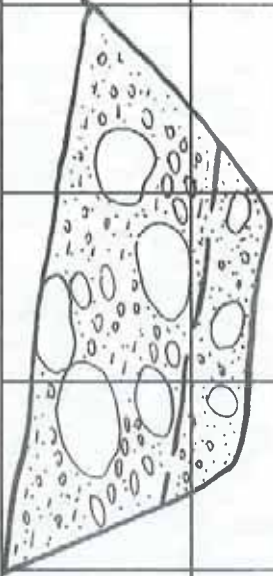
LOG OF EXCAVATION		Logged By: NM	Date Excavated: 6/13/06	Client: Pardee Homes
Trench No. TP147				
Depth (ft)	Description	Comments		
0 - 4	<p>Alluvium: Medium brown silty clayey fine to coarse grained SAND with abundant gravels, cobbles, and boulders (a few 3-4' subrounded boulders at surface), approximately 15% greater than 1' diameter, well graded, less fine content with depth, dry to moist at 3.5', medium dense.</p>			
4 - 5.5	<p><u>Saugus Formation?</u>: Light greenish gray and light brown CONGLOMERATE with fine to coarse grained sandstone supported matrix, moist, very dense, one 1.5' diameter clast.</p> <p>Total Depth - 5.5' No groundwater No caving Backfilled</p>			
Graphic Log				
scale 1" = 5'		GEOLABS-WESTLAKE VILLAGE	W.O. 8838	PLATE TP147

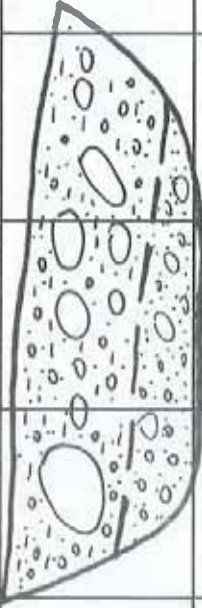
LOG OF EXCAVATION		Logged By: NM	Date Excavated: 6/13/06	Client: Pardee Homes
Trench No. TP148				
Depth (ft)	Description	Comments		
0 - 3	<p><u>Alluvium</u>: Medium brown silty fine to coarse grained SAND with abundant gravels, cobbles and lesser boulders (approximately 10%) approximately 15% of boulders are between 1' to 2' diameter, moist, medium dense.</p> <p><u>Saugus Formation?</u>: Light orangish brown sandy gravel cobble CONGLOMERATE, moist, very dense.</p> <p>Total Depth - 4.5' No groundwater No caving Backfilled</p>			
Graphic Log				
scale 1" = 5'		GEOLABS-WESTLAKE VILLAGE	W.O. 8838	PLATE TP148

LOG OF EXCAVATION Trench No. TP149		Logged By: NM	Date Excavated: 6/13/06	Client: Pardee Homes
Depth (ft)	Description	Comments		
0 - 7	Colluvium: Medium brown silty fine to medium grained SAND with gravels and cobbles, moist to wet with seepage at approximately 7', abundant boulders on surface up to approx. 2' diameter, medium dense, steeply incised at contact.			
7 - 8.5	Saugus Formation?: Light yellow brown sandy CONGLOMERATE with occasional boulders (one ciast in bottom of trench approximately 2' diameter); very moist, very dense.			
	Total Depth - 8.5' Seep at 7' No caving Backfilled			
Graphic Log				
scale 1" = 5'	GEOLABS-WESTLAKE VILLAGE	W.O. 8838	PLATE	TP149

LOG OF EXCAVATION
 Trench No. TP150

Logged By: NM

Date Excavated: 6/13/06

Client: Pardee Homes

Depth (ft)	Description	Comments			
0 - 2	Alluvium: Medium to dark brown silty clayey SAND with abundant gravels and cobbles with lesser boulders (approx. 15%), subangular to rounded clasts typically a few inches diameter with 3 or 4 clasts up to 2' diameter, roots, porous, slightly moist, medium dense.				
2 - 3	Saugus Formation?: Orange brown fine to medium grained sandy gravel CONGLOMERATE, massive, slightly moist, roots, dense, highly weathered.				
3 - 5	Light yellow brown fine to medium grained sandy gravel CONGLOMERATE, massive, moist, very dense.				
	Total Depth - 5' No groundwater No caving Backfilled				
Graphic Log					
scale 1" = 5'	GEOLABS-WESTLAKE VILLAGE	W.O.	8838	PLATE	TP150

LOG OF EXCAVATION		Logged By: NM	Date Excavated: 6/14/06	Client: Pardee Homes
Trench No. TP151				
Depth (ft)	Description	Comments		
0 - 1.5	<u>Alluvium:</u> Medium to dark brown sandy CLAY with scattered gravels and cobbles (approximately 15%), rootlets, moist, porous, medium stiff.			
1.5 - 3	<u>Saugus Formation:</u> Light grayish brown sandy silty CLAY, moist, massive, medium stiff, occasional rootlets, highly weathered to 3'.			
3 - 5	Light brown and light reddish brown fine grained and silty fine grained SANDSTONE, poorly graded, massive, moist, very dense.			
Total Depth - 5'				
No groundwater				
No caving				
Backfilled				
Graphic Log				
scale 1" = 5'				
GEOLABS-WESTLAKE VILLAGE		W.O.	8838	PLATE TP151

LOG OF EXCAVATION Trench No. TP152	Logged By: NM	Date Excavated: 6/14/06	Client: Pardee Homes
Depth (ft)	Description		
0 - 1	Topsoil: Dark brown clayey SAND with gravels, cobbles, and lesser boulders (approximately 15% greater than 1' diameter), typically 1-1.5' diameter, rootlets, porous, slightly moist, medium dense.		
1 - 3	Alluvium: Medium brown sandy CLAY with gravels, cobbles and lesser boulders (approximately 15% greater than 1' diameter, typically 1-1.5' diameter), sandy CLAY at 2', massive moist, medium stiff to stiff.		
3 - 5	Saugus Formation: Light brown fine to coarse grained SANDSTONE with scattered small gravels, moderately graded, massive. Gradational contact with medium to coarse grained SANDSTONE at 4', moist, very dense, calcium carbonate stains.		
Total Depth - 5'	No groundwater		
No caving	Backfilled		
A-5	Graphic Log		
scale 1" = 5'	GEOLABS-WESTLAKE VILLAGE	W.O. 8838	PLATE TP152

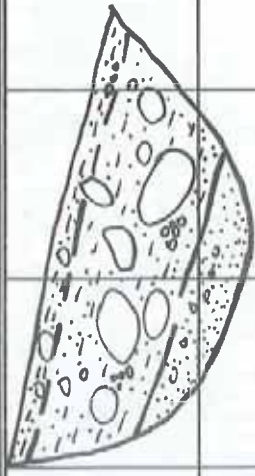

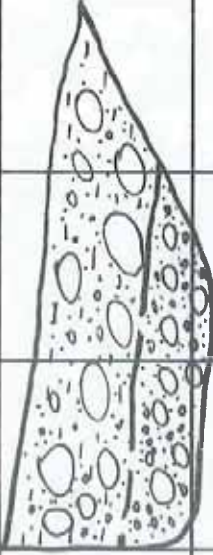
LOG OF EXCAVATION		Logged By: NIM	Date Excavated: 6/14/06	Client: Pardee Homes
Trench No. TP153				
Depth (ft)	Description	Comments		
0 - 3	<p><u>Alluvium</u>: Medium brown fine to coarse grained clayey SAND with abundant angular to subrounded gravels, cobbles and lesser boulders (approximately 15%) up to 1.5' diameter, well graded, porous, rootlets, moist, medium dense.</p> <p><u>Saugus Formation</u>: Light brown and light orangish brown sandy CONGLOMERATE, abundant cobbles, massive, moist, very dense, sandstone supported matrix.</p>			
3 - 5	<p>Total Depth - 5'</p> <p>No groundwater</p> <p>No caving</p> <p>Backfilled</p>			
Graphic Log				
scale 1" = 5'	GEOLABS-WESTLAKE VILLAGE	W.O. 8838	PLATE	TP153

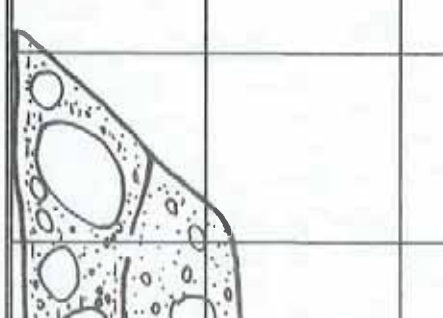
LOG OF EXCAVATION Trench No. TP154	Logged By: NM	Date Excavated: 6/14/06	Client: Pardee Homes
Depth (ft)	Description	Comments	
0 - 2.5	<p><u>Alluvium</u>: Medium brown clayey fine to coarse grained SAND with abundant gravels, cobbles and boulders (approximately 25% greater than 1' diameter), several boulders up to 3' diameter, coarsening with depth, well graded, slightly moist, medium dense.</p> <p><u>Saugus Formation</u>: Light brown sandy CONGLOMERATE fine to coarse grained sandstone supported matrix, occasional boulders up to 1.5' diameter, moist, very dense.</p> <p>Total Depth - 5' No groundwater No caving Backfilled</p>		
2.5 - 5			
Graphic Log			
scale 1" = 5'	GEOLABS-WESTLAKE VILLAGE	W.O. 8838	PLATE TP154

LOG OF EXCAVATION
 Trench No. TP155

Logged By: NM

Date Excavated: 6/14/06

Client: Pardee Homes

Depth (ft)

Description

Comments

0 - 2.5

Alluvium: Medium brown silty fine to coarse grained SAND with abundant gravels, cobbles and boulders (approximately 25% greater than 1' diameter up to approximately 2.5' diameter), moist, medium dense, rootlets.

2.5 - 5

Saugus Formation: Light orangish to light brown fine to coarse grained sandy CONGLOMERATE with several 1.5' diameter clasts of granite/tonalite, moist to very moist with depth, very dense.

Total Depth - 5'
 No groundwater
 No caving
 Backfilled

Graphic Log

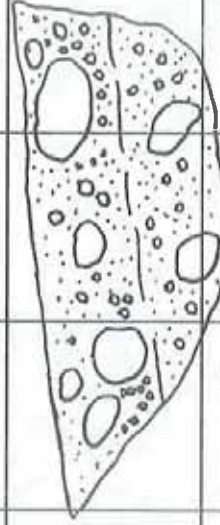

scale 1" = 5'

GEOLABS-WESTLAKE VILLAGE

W.O. 8838

PLATE

TP155

LOG OF EXCAVATION		Logged By:	Date Excavated:	Client:
Trench No. TP156		NM	6/14/06	Pardee Homes
Depth (ft)	Description	Comments		
0 - 3	<p>Alluvium: Medium brown clayey silty fine to coarse grained SAND with abundant angular to subrounded gravels, cobbles and lesser boulders (approximately 10% greater than 1' diameter), pockets of medium to coarse grained SAND at 2', well graded, rootlets, moist, medium dense.</p> <p>Saugus Formation: Irregular undulating contact to light brown gravel cobble CONGLOMERATE (approximately 40% fine to coarse grained sandstone supported matrix), massive, moist to very moist, very dense.</p> <p>Total Depth - 5' No groundwater No caving Backfilled</p>			
3 - 5				
Graphic Log				
				
scale 1" = 5'		GEOLABS-WESTLAKE VILLAGE	W.O. 8838	PLATE TP156

Depth (ft)	Description	Comments
0 - 3.5	<u>Colluvium</u> : Medium brown sandy CLAY with gravels and cobbles, occasional boulders approximately 1' diameter, moist, stiff, rootlets.	
3.5 - 4'2"	<u>Saugus Formation</u> : Gradational contact with light brown silty very fine grained SANDSTONE, moderately graded, massive, slightly moist, very dense.	
4'2" - 4'10"	Light medium brown SILTSTONE ranging from 3" to 8" thick, base is interfingered with sandstone below, semi planar contacts with a discontinuous paper thin silty claystone bed at base, moist, very stiff.	
4'10" - 5'4"	Light reddish brown silty fine to medium grained SANDSTONE, moderately graded, massive with semi planar contact at base.	
5'4" - 8.5	Light brown to light greenish brown fine to coarse grained SANDSTONE with gravels and cobbles (conglomeratic sandstone).	
	Total Depth - 8.5' No groundwater No caving Backfilled	

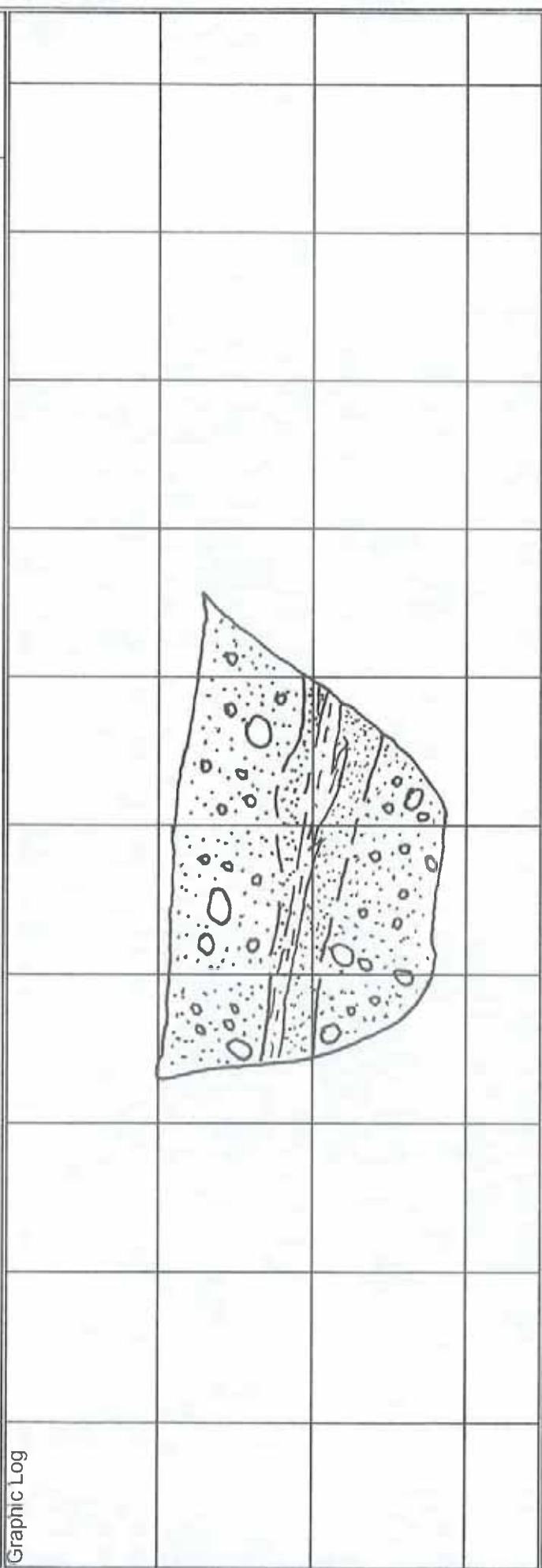

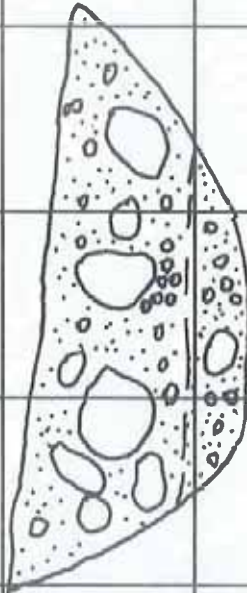
LOG OF EXCAVATION		Logged By: NM	Date Excavated: 6/14/06	Client: Pardee Homes
Trench No. TP158				
Depth (ft)	Description	Comments		
0 - 4	<p><u>Alluvium</u>: Medium brown clayey fine to coarse grained SAND with abundant gravels, cobbles and boulders (approximately 35% greater than 1' diameter), boulder clasts typically 1-2' diameter, well graded with discontinuous pockets up to 1' thick of coarse sand, moist to very moist at base, medium dense.</p> <p><u>Saugus Formation</u>: Light brown sandy CONGLOMERATE, very moist, very dense.</p> <p>Total Depth - 6' No groundwater No caving Backfilled</p>			
Graphic Log				
scale 1" = 5'		GEOLABS-WESTLAKE VILLAGE	W.O. 8838	PLATE TP158

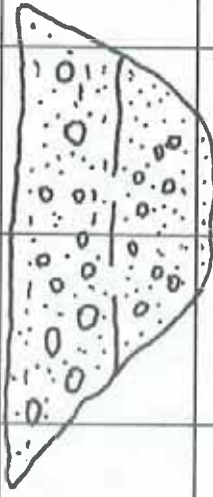
LOG OF EXCAVATION Trench No. TP159		Logged By: NM	Date Excavated: 6/14/06	Client: Pardee Homes
Depth (ft)	Description	Comments		
0 - 2.5	<u>Alluvium</u> : Medium brown silty SAND with gravels and cobbles up to 1' diameter, porous, well graded, rootlets, moist, medium dense.			
2.5 - 5	<u>Saugus Formation</u> : Light brown fine to coarse grained SANDSTONE with gravels (conglomeratic sandstone), moderately to well graded, massive, moist, very dense.			
	Total Depth - 5' No groundwater No caving Backfilled			
Graphic Log				
				
scale 1" = 5'		GEOLABS-WESTLAKE VILLAGE	W.O. 8838	PLATE TP159

LOG OF EXCAVATION		Logged By: NM	Date Excavated: 6/14/06	Client: Pardee Homes
Trench No. TP160				
Depth (ft)	Description	Comments		
0 - 2	<u>Colluvium</u> : Medium to dark brown fine to coarse grained sandy CLAY to clayey SAND with gravels and occasional cobbles, porous, rootlets, slightly moist, medium stiff.			
2 - 2.5	<u>Weathered Saugus Formation</u> : Red brown fine to coarse grained sandy CLAY, moist, stiff.			
2.5 - 5	<u>Saugus Formation</u> : Light yellowish brown fine to coarse grained SANDSTONE with scattered gravels (approximately 10%), moderately graded, massive, moist, very dense			
Total Depth - 5' No groundwater No caving Backfilled				
Graphic Log				
scale 1" = 5'		GEOLABS-WESTLAKE VILLAGE	W.O. 8838	PLATE TP160

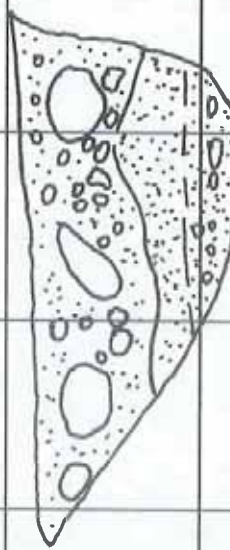
LOG OF EXCAVATION		Logged By: NM	Date Excavated: 6/15/06	Client: Pardee Homes
Trench No. TP161				
Depth (ft)	Description	Comments		
0 - 3	<u>Alluvium</u> : Medium brown clayey fine to coarse grained SAND with gravels, cobbles and boulders (approximately 25% greater than 1' diameter), boulders typically 1.5-2' diameter, mostly granitic, well graded, rootlets, moist, medium dense.			
3 - 5.5	<u>Saugus Formation</u> : Irregular undulating contact with light brown fine grained SANDSTONE, poorly graded with a gradational flat lying contact at approximately 4', with light yellowish brown fine to coarse grained SANDSTONE with gravels and cobbles (approximately 20%), moderately graded, moist, very dense.			
	Total Depth - 5.5' No groundwater No caving Backfilled			
Graphic Log				
				
scale 1" = 5'		GEOLABS-WESTLAKE VILLAGE	W.O. 8838	PLATE TP161

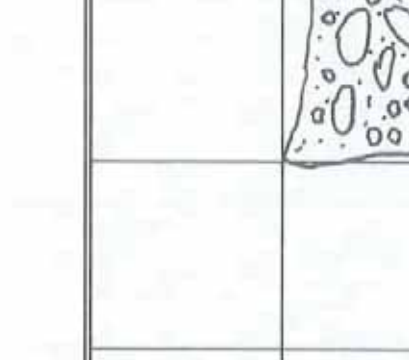
LOG OF EXCAVATION Trench No. TP162	Logged By: NM	Date Excavated: 6/15/06	Client: Pardee Homes
Depth (ft)	Description	Comments	
0 - 3	Alluvium: Medium brown clayey silty SAND with gravels, cobbles and boulders (approximately 25% greater than 1' diameter), boulders typically 1-2' diameter, well graded, rootlets, dry at surface to moist with depth, medium dense.		
3 - 6	<u>Saugus Formation</u> : Gradational contact with orangish brown and light reddish brown fine to coarse grained sandy CONGLOMERATE (abundant gravels and cobbles), massive, moist, very dense.		
Total Depth - 6'			
No groundwater			
No caving			
Backfilled			
Graphic Log			
			
scale 1" = 5'			
GEOLABS-WESTLAKE VILLAGE		W.O. 8838	PLATE TP162

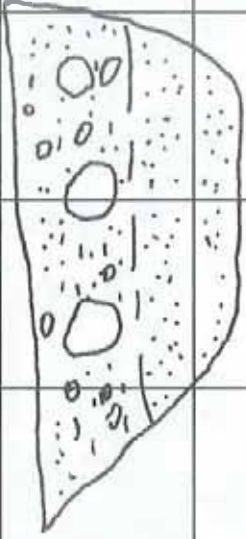
LOG OF EXCAVATION		Logged By: NM	Date Excavated: 6/15/06	Client: Pardee Homes
Trench No. TP163				
Depth (ft)	Description	Comments		
0 - 3	<p>Alluvium: Medium brown clayey silty SAND with gravels, cobbles and lesser boulders (approximately 5%) up to 1.5' diameter, well graded, rootlets, slightly moist, medium dense.</p> <p>Saugus Formation: Gradational contact with light reddish brown silty fine grained SANDSTONE with coarse sand grains, moderately graded, massive, moist, very dense, calcium carbonate stains in upper 2'.</p>			
3 - 6	<p>Total Depth - 6'</p> <p>No groundwater</p> <p>No caving</p> <p>Backfilled</p>			
Graphic Log				
scale 1" = 5'		GEOLABS-WESTLAKE VILLAGE	W.O. 8838	PLATE TP163

LOG OF EXCAVATION Trench No. TP164		Logged By: NM	Date Excavated: 6/15/06	Client: Pardee Homes	Comments
Depth (ft)	Description				
0 - 2'	<u>Topsoil</u> : Medium brown sandy CLAY with occasional gravels, porous, rootlets.				
2 - 9'	<u>Landslide Debris</u> : Crudely interbedded light medium brown silty fine to coarse grained SAND and medium brown sandy CLAY, occasional graevils, discontinuous wavy contact, abundant rootlets, pinhole porosity.				
9 - 9'8"	Medium brown sandy CLAYSTONE, grading to silty CLAYSTONE in bottom 2-3 inches (possible base of slide but with no clearly defined bounding surface), slightly polished when picked fresh, moist, massive, stiff.				
9'8" - 10'4"	<u>Saugus Formation?</u> : Contact not planar but clear to light brown silty fine grained SANDSTONE, massive, moist, very dense.				
10'4" - 10'7"	Grading to medium brown silty CLAY, massive, moist, very stiff.				
10'7" - 11'7"	Grading to light brown sandy SILTSTONE, massive, moist, very stiff.				
11'7" - 12.5'	Light grayish brown fine to coarse grained SANDSTONE with abundant fine gravels, well graded, massive, calcium carbonate stains, moist, very dense to hard. Total Depth - 12.5'. No groundwater, No caving, Backfilled				
Graphic Log					
scale 1" = 5'	GEOLABS-WESTLAKE VILLAGE	W.O.	8838	PLATE	TP164

LOG OF EXCAVATION		Logged By: NM	Date Excavated: 6/16/06	Client: Pardee Homes
Trench No. TP165				
Depth (ft)	Description	Comments		
0 - 4.5	Landslide Debris?: Medium brown silty sandy CLAY with scattered gravels and cobbles, several boulders at base up to 14" diameter, well graded, moist, medium stiff.			
4.5 - 7	Gradational contact with medium brown silty very fine grained SANDSTONE, massive, moist, very dense.			
7 - 13	Saugus Formation?: Gradational contact to medium brown to light reddish brown silty fine grained SANDSTONE with coarse sand and fine gravel, 8-10' has higher concentration of small gravels (approximately 40%), massive with occasional vague flat lying gradational contacts, moist, very dense.			
	Total Depth - 13' No groundwater No caving Backfilled			
Graphic Log				
scale 1" = 5'				
		GEOLABS-WESTLAKE VILLAGE	W.O. 8838	PLATE TP165

LOG OF EXCAVATION
Trench No. TP166

Logged By: NM

Date Excavated: 6/16/06

Client: Pardee Homes

Comments

Description

0 - 1.5
Alluvium: Medium brown fine to coarse grained gravelly SAND with scattered cobbles and very sparse boulders up to 1.5' diameter (one at surface approximately 2' diameter), well graded, loose to medium dense, dry, rootlets.

1.5 - 4
Saugus Formation: Light brown sandy CONGLOMERATE with fine to coarse grained sandstone supported matrix, massive, moist, very dense.

Total Depth - 4'
No groundwater
No caving
Backfilled

Graphic Log

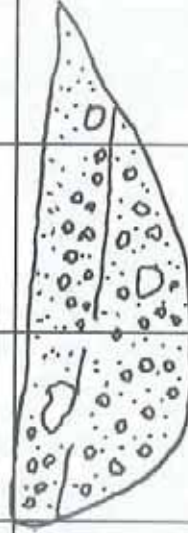

scale 1" = 5'

GEOLABS-WESTLAKE VILLAGE

W.O. 8838

PLATE

TP166

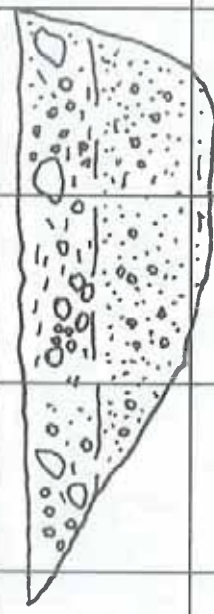
LOG OF EXCAVATION		Logged By: NM	Date Excavated: 6/16/06	Client: Pardee Homes
Trench No. TP167				
Depth (ft)	Description	Comments		
0 - 2	Alluvium: Medium brown silty fine to coarse grained SAND with gravels, cobbles, and sparse boulders (approximately 1' diameter), well graded, porous, rootlets, dry to moist with depth, medium dense.			
2 - 5	Saugus Formation: Gradational contact with medium brown silty fine grained SANDSTONE with coarse sand and fine gravel massive, moist, very dense.			
Total Depth - 5' No groundwater No caving Backfilled				
Graphic Log				
scale 1" = 5'		GEOLABS-WESTLAKE VILLAGE	W.O. 8838	PLATE TP167

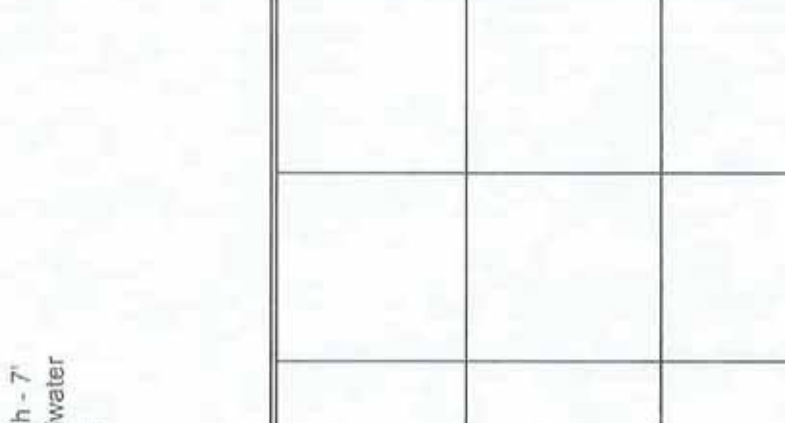
LOG OF EXCAVATION Trench No. TP168	Logged By: NM	Date Excavated: 6/16/06	Client: Pardee Homes
Depth (ft)	Description		
0 - 4.5	Alluvium: Medium brown sandy CLAY with scattered angular to subrounded gravels, cobbles and lesser boulders (in upper 18") up to 1.5' diameter, rootlets, moist, medium stiff to stiff with deph.		
4.5 - 7	Saugus Formation: Light medium brown silty fine to medium grained SANDSTONE with occasional coarse sand and fine gravel at 6", grades to silty fine to medium grained SANDSTONE with abundant coarse sand and small gravels, massive, moist, very dense.		
Total Depth - 7'	No groundwater		
No caving	Backfilled		
Graphic Log			
scale 1" = 5'	GEOLABS-WESTLAKE VILLAGE	W.O. 8838	PLATE TP168

LOG OF EXCAVATION		Logged By: NM	Date Excavated: 6/16/06	Client: Pardee Homes
Trench No. TP169				
Depth (ft)	Description	Comments		
0 - 2	<u>Alluvium</u> : Medium brown silty clayey SAND with gravels, cobbles and occasional boulders, approximately 1' diameter, well graded, slightly moist, medium dense, rootlets.			
2 - 4.5	<u>Saugus Formation</u> : Gradational contact with light reddish brown silty fine to medium grained SANDSTONE with scattered coarse sand and sparse fine gravels, calcium carbonate stains, rootlets, massive, moist, dense, highly weathered to 4.5'.			
4.5 - 6	Grading to light reddish brown to medium brown fine to medium grained SANDSTONE with scattered coarse sand and fine subangular to rounded fine gravels, massive, moist, very dense.			
Total Depth - 6' No groundwater No caving Backfilled				
Graphic Log				
scale 1" = 5'		GEOLABS-WESTLAKE VILLAGE	W.O. 8838	PLATE TP169

LOG OF EXCAVATION Trench No. TP170		Logged By: RMP	Date Excavated: 8/2/06	Client: Pardee Homes
Depth (ft)	Description	Comments		
0 - 1.5	<u>Topsoil</u> : Dark brown fine to medium grained sandy clayey SILT, graded, stiff, moist, rootlets.			
1.5 - 3	<u>Saugus Formation</u> : Yellowish brown sandy SILTSTONE, poorly graded, very stiff, moist, weakly indurated.			
3 - 5	Grades to subangular to subrounded fine grained gravel CONGLOMERATE with weakly cemented silty fine to coarse sand matrix, well graded, dense, moist.	@5' B N86W/28NE		
5 - 5.5	Dark brown CLAYSTONE, poorly graded, very stiff, moist, sheared, variable thickness (1-6" thick) but continuous, wavy upper contact.			
5.5 - 8	Grades to subangular to subrounded yellow brown fine grained gravel CONGLOMERATE, well graded, dense, moist, trace cobbles.			
	Total Depth - 8' No groundwater No caving Backfilled			
Graphic Log				
scale 1" = 5'	GEOLABS-WESTLAKE VILLAGE	W.O. 8838	PLATE	TP170

LOG OF EXCAVATION		Logged By: RMP	Date Excavated: 8/2/06	Client: Pardee Homes
Trench No. TP171				
Depth (ft)	Description	Comments		
0 - 1.5	<u>Topsoil</u> : Brown silty fine to coarse grained SAND, graded, dense, dry to moist, with depth, rootlets.			
1.5 - 3.5	<u>Saugus Formation</u> : Yellowish brown fine grained gravelly silty fine to coarse grained SANDSTONE, graded, dense, moist, weakly cemented.			
3.5 - 4.5	1' thick channelled sand in east wall, yellowish brown subangular to subrounded fine grained gravel CONGLOMERATE with slightly friable silty fine to coarse sand matrix, well graded, dense, moist.			
4.5 - 5.5	Brown silty CLAYSTONE with fine to coarse sand, graded, hard, moist.			
5.5 - 5.7	Grades to yellowish brown subangular to subrounded fine to coarse grained gravel CONGLOMERATE with weakly cemented silty fine to coarse sand matrix, well graded.			
5.7 - 7	Brown fine to coarse grained sandy silty CLAYSTONE, graded, hard, moist.			
7 - 8	Grades to yellowish brown subangular to subrounded fine to coarse grained gravel CONGLOMERATE with weakly cemented silty fine to coarse sand matrix, well graded.			
8 - 9.5	1.5' thick dark yellowish brown CLAYSTONE, hard, moist, sheared, waxy.			
@9.5'	Grades to fine grained gravelly fine to coarse grained sandy CLAYSTONE, graded, hard, moist, weakly indurated.			
Graphic Log				
scale 1" = 5'		Total Depth - 9.5' No groundwater No caving Backfilled		
		GEOLABS-WESTLAKE VILLAGE W.O. 8838 PLATE TP171		

LOG OF EXCAVATION		Logged By:	RMP	Date Excavated:	8/2/06	Client:	Pardee Homes
Trench No.		TP172					
Depth (ft)	Description	Comments					
0 - 2	<u>Topsoil:</u> Dark brown clayey fine to coarse grained SANDSTONE, graded, dense, moist, rootlets, pervasive white carbonate veinlets in lower 6".						
2 - 3.5	<u>Saugus Formation:</u> 4" thick dark yellowish brown fine to medium grained sandy CLAYSTONE, very stiff, moist.						
3.5 - 5.5	Grades to yellowish brown subangular to subrounded fine grained gravel CONGLOMERATE with weakly cemented to slightly friable clayey fine to coarse sand matrix, well graded, dense, moist.						
5.5 - 6.5	Reddish brown fine grained gravelly clayey fine to medium grained SANDSTONE, graded, dense, moist, weakly indurated, discontinuous.						
6.5 - 7.5	Discontinuous channeled sand in head wall and part of west wall, yellowish brown subangular to subrounded fine grained gravel CONGLOMERATE with slightly friable fine to coarse sand matrix, well graded, dense.						
7.5 - 8	6" thick yellowish brown fine to medium grained sandy SILTSTONE, poorly graded, very stiff, moist.						
8 - 8'8"	2" thick dark yellowish brown silty CLAYSTONE, grades to 6" thick silty fine grained SANDSTONE interbed.						
8'8" - 9.5	CLAYSTONE grades to fine grained gravel CONGLOMERATE at 9'.						
Total Depth - 9.5', No groundwater, No caving, Backfilled							
Graphic Log							
scale 1" = 5'	GEOLABS-WESTLAKE VILLAGE	W.O.	8838	PLATE	TP172		

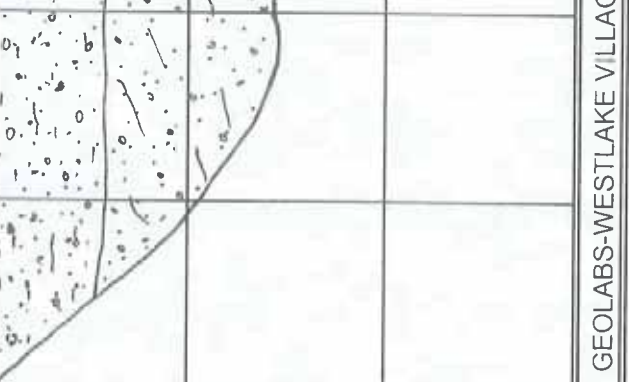
LOG OF EXCAVATION Trench No. TP173	Logged By: RMP	Date Excavated: 8/2/06	Client: Pardee Homes
<p>Depth (ft)</p> <p>0 - 3</p> <p>3 - 4</p> <p>4 - 5.5</p> <p>5.5 - 7</p>	<p>Description</p> <p>Topsoil: Dark brown fine to coarse grained SAND with clay, silt, and gravel, well graded, dense, dry to moist with depth, subangular to subrounded clasts, rootlets.</p> <p>Saugus Formation: Yellowish brown clayey fine to coarse grained SAND with fine gravel, graded, very dense, moist, weakly indurated, clasts are subangular to subrounded.</p> <p>Grades to yellowish brown subangular to subrounded fine grained gravel-cobble CONGLOMERATE with slightly friable to weakly cemented silty fine to coarse sand matrix, well graded, very dense, moist.</p> <p>Sharp scoured contact with yellowish brown silty fine to medium grained SANDSTONE, poorly graded, very dense, moist, weakly to moderately indurated, grades to coarse sand at 6', mottled appearance.</p>	<p>Total Depth - 7'</p> <p>No groundwater</p> <p>No caving</p> <p>Backfilled</p>	<p>Comments</p> <p>BN26W/27SW</p>
<p>Graphic Log</p>			
<p>scale 1" = 5'</p>	<p>GEOLABS-WESTLAKE VILLAGE</p>	<p>W.O. 8838</p>	<p>PLATE TP173</p>

LOG OF EXCAVATION		Logged By: RMP	Date Excavated: 8/2/06	Client: Pardee Homes
Trench No. TP174				
Depth (ft)	Description	Comments		
0 - 1	<u>Topsoil</u> : Dark brown clayey silty fine to coarse grained SAND, graded, dense, dry to moist with depth, rootlets.			
1 - 1.5	<u>Saugus Formation</u> : Yellowish brown subangular to subrounded fine grained gravel CONGLOMERATE with fine to coarse sand matrix, matrix, well graded, dense, moist, pervasive fractures, rootlets			
1.5 - 2	Yellowish brown fine grained sandy SILTSTONE, poorly graded, very stiff, moist, rootlets, pervasive fractures.			
2 - 2.5	1" thick fine grained gravel layer.	BN46W/10SW		
2.5 - 4.5	Grades to yellowish brown subangular fine grained gravelly fine to coarse grained SANDSTONE with silt, graded, very dense, moist, weakly indurated, upper 6" pervasively fractured.			
4.5 - 6	Grades to yellowish brown subangular to subrounded gravel to cobble CONGLOMERATE with fine to coarse sand matrix, well graded, very dense, moist.			
Total Depth - 6' (refusal on cobble) No groundwater No caving Backfilled				
Graphic Log				
scale 1" = 5'	GEOLABS-WESTLAKE VILLAGE	W.O.	8838	PLATE TP174

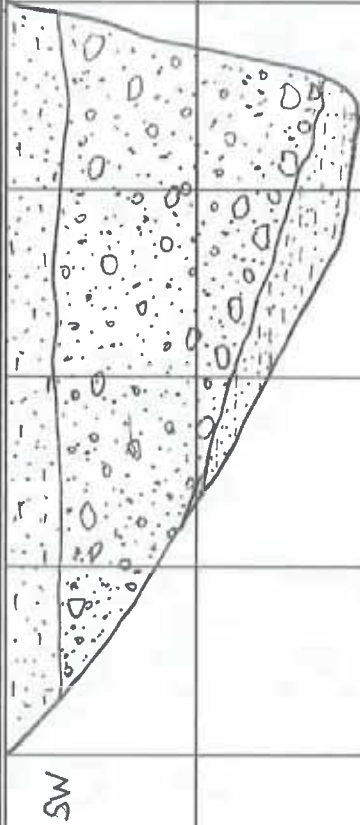
LOG OF EXCAVATION Trench No. TP175	Logged By: RMP	Date Excavated: 8/2/06	Client: Pardee Homes
<p>Depth (ft)</p> <p>0 - 1.5</p> <p>1.5 - 8</p> <p>8 - 9</p>	<p>Description</p> <p><u>Topsoil</u>: Dark brown to yellowish brown fine grained gravelly silty fine to coarse grained SAND, graded, medium dense, moist.</p> <p><u>Terrace Deposits</u>: Pale yellowish brown subangular to subrounded cobble GRAVEL with slightly friable fine to coarse sand matrix, well graded, very dense, moist, weathered to 8.5', rootlets to 7'.</p> <p><u>Saugus Formation</u>: Sharp, wavy, and slightly scoured contact with yellowish brown fine grained sandy SILTSTONE, poorly graded, very dense, moist.</p>	<p>Total Depth - 9'</p> <p>No groundwater</p> <p>No caving</p> <p>Backfilled</p>	<p>Comments</p> <p>@8.5' Approx. CN2E/36SE</p>
<p>Graphic Log</p>			
<p>scale 1" = 5'</p>	<p>GEOLABS-WESTLAKE VILLAGE</p>	<p>W.O. 8838</p>	<p>PLATE TP175</p>

LOG OF EXCAVATION Trench No. TP176		Logged By: RMP	Date Excavated: 8/2/06	Client: Pardee Homes
Depth (ft)	Description	Comments		
0 - 1	<u>Topsoil</u> : Dark brown clayey silty fine to coarse grained SAND, graded, dense, dry to moist with depth, rootlets.			
1 - 2	<u>Saugus Formation</u> : Dark brown clayey silty fine to coarse grained SANDSTONE, graded, very dense, moist.			
2 - 3	Yellowish brown silty fine to medium grained SANDSTONE, poorly graded, very dense, moist.			
3 - 4.5	Pale brown fine grained gravelly silty fine to medium grained SANDSTONE, graded, dense, moist, pervasively fractured, pervasive white carbonate veins, rootlets.			
4.5 - 6	Grades to pale brown silty fine to coarse grained SANDSTONE, poorly graded to graded, very dense, moist, carbonate veins, no fractures.			
6 - 9	Grades to yellowish brown subangular to subrounded fine to coarse grained gravel CONGLOMERATE with silty fine to coarse sand matrix, well graded, very dense, moist.			
9 - 10.5	Yellowish brown fine grained gravelly fine to coarse grained SANDSTONE with silt and clay, graded, very dense, very moist.			
10.5 - 11	Grades to fine grained gravel CONGLOMERATE.			
11 - 12	Sharp, wavy, slightly scoured contact with dark yellowish brown fine to coarse grained sandy SILTSTONE, poorly graded, hard, moist.			
Graphic Log		Total Depth - 12' No groundwater No caving Backfilled		
scale 1" = 5'		PLATE TP176		

A-485

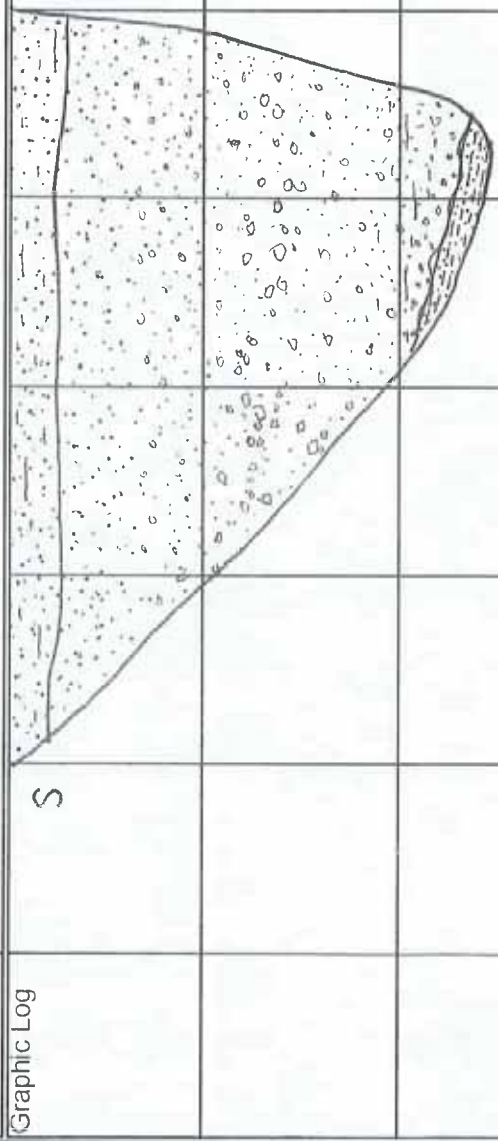

LOG OF EXCAVATION		Logged By: RMP	Date Excavated: 8/2/06	Client: Pardee Homes
Trench No. TP177				
Depth (ft)	Description	Comments		
0 - 2	<u>Topsoil</u> : Brown silty fine to medium grained SAND with gravel, poorly graded, medium dense, moist.			
2 - 3.5	<u>Saugus Formation</u> : Dark yellowish brown silty fine to coarse grained SANDSTONE with gravel, graded, dense, moist, weakly indurated, blocky appearance, pervasive fracturing.			
3.5 - 6.5	Pervasive, dry, white carbonate veins for 1.5'			
6.5 - 6'10"	4" thick dark yellowish brown CLAYSTONE, pervasively sheared, waxy, highly plastic, no dominant shear plane, although shears are roughly parallel to bedding.	BN15E/9NW		
6'10" - 9	Dark yellowish brown fine to medium grained sandy SILTSTONE, poorly graded, hard, moist.			
Total Depth - 9' No groundwater No caving Backfilled				
Graphic Log				
scale 1" = 5'	GEOLABS-WESTLAKE VILLAGE	W.O. 8838	PLATE	TP177

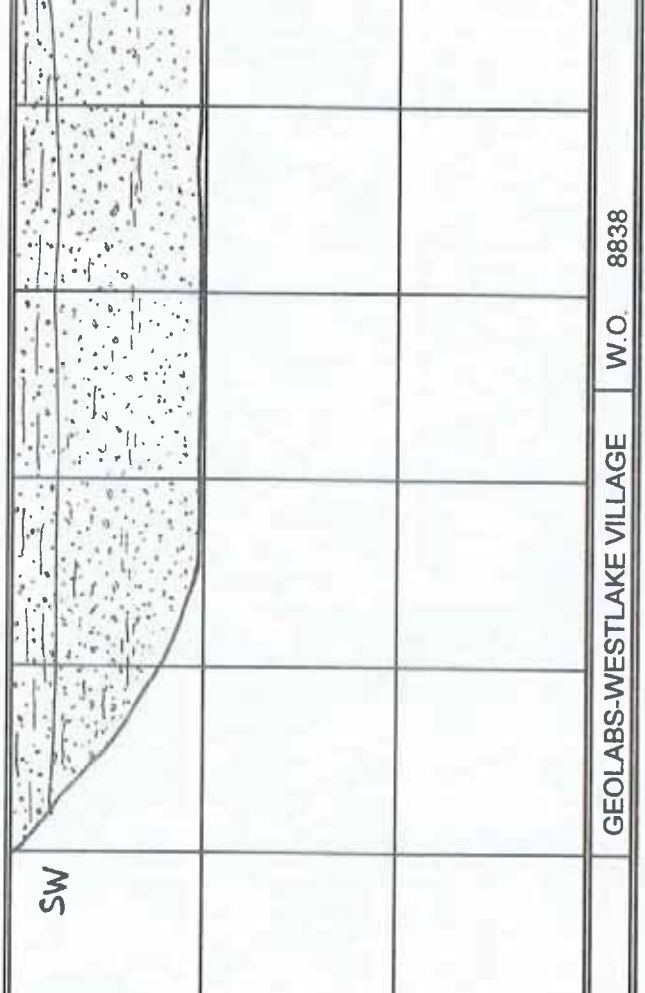
LOG OF EXCAVATION Trench No. TP178	Logged By: RMP	Date Excavated: 8/2/06	Client: Pardee Homes		
<p>Depth (ft)</p> <p>0 - 1</p> <p>1 - 2</p> <p>2 - 2.5</p> <p>2.5 - 3</p> <p>3 - 5</p>	<p>Description</p> <p><u>Topsoil</u>: Brown very clayey fine to coarse grained SAND, graded, dense, moist.</p> <p><u>Saugus Formation</u>: Yellowish brown clayey silty fine to coarse grained SANDSTONE, graded, dense to very dense, moist, weakly indurated, dry, white carbonate veins throughout, rootlets.</p> <p>Fine grained gravels in SANDSTONE.</p> <p>Mottled appearance (brown, olive green, yellowish brown) in SANDSTONE, olive green colored material is finer grained (fine to medium grained sandy clayey SILTSTONE).</p> <p>Grades to yellow brown fine to medium grained SANDSTONE, hard, moist.</p>	<p>Total Depth - 5'</p> <p>No groundwater</p> <p>No caving</p> <p>Backfilled</p>	<p>Comments</p>		
<p>Graphic Log</p> <p>SW</p> 					
<p>scale 1" = 5'</p>	<p>GEOLABS-WESTLAKE VILLAGE</p>	<p>W.O. 8838</p>	<p>PLATE</p>	<p>TP178</p>	

LOG OF EXCAVATION
Trench No. TP179

Logged By: RMP

Date Excavated: 8/2/06

Client: Pardee Homes

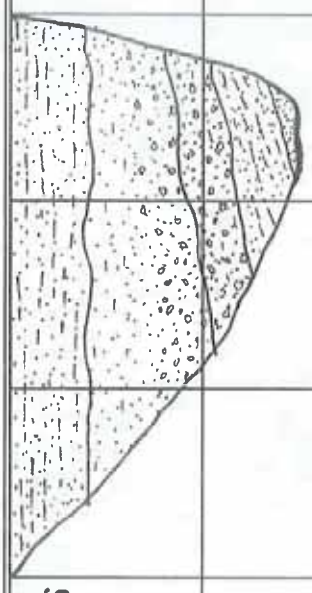
Depth (ft)	Description	Comments
0 - 2	<u>Topsoil:</u> Brown to yellowish brown silty fine to medium grained SAND to fine to medium grained sandy SILT, poorly graded, medium dense to stiff, dry.	
2 - 2.5	<u>Saugus Formation:</u> Yellowish brown silty fine to coarse grained SANDSTONE, graded, dense, dry, rootlets, weakly indurated.	
2.5 - 4	Grades to subangular to subrounded fine grained gravel CONGLOMERATE with slightly friable silty fine to coarse sand matrix, well graded, dense, dry, rootlets, pervasively fractures.	
4 - 5.5	Olive green subangular to subrounded fine to coarse grained gravel CONGLOMERATE with weakly cemented silty fine to coarse sand matrix, well graded, very dense, moist.	BN69W/8SW
5.5 - 6	Yellowish brown silty fine grained SANDSTONE to fine grained sandy SILTSTONE, poorly graded, hard, moist, weakly indurated.	
6 - 7	Olive green silty fine to coarse grained SANDSTONE, hard, moist, weakly indurated.	
	Total Depth - 7' No groundwater No caving Backfilled	
Graphic Log		

scale 1" = 5'

GEOLABS-WESTLAKE VILLAGE

W.O. 8838

PLATE

TP179

LOG OF EXCAVATION		Logged By: RMP	Date Excavated: 8/4/06	Client: Pardee Homes
Trench No. TP180				
Depth (ft)	Description	Comments		
0 - 1.5	Topsoil: Dark brown silty fine to coarse grained SAND with subangular fine gravel, graded, medium dense, moist, weakly cemented, rootlets.			
1.5 - 3.5	Colluvium: Yellowish brown very silty fine grained SAND, poorly graded, medium dense, moist, weakly cemented, pervasive fracturing filled with white carbonate veins, rootlets.			
3.5 - 4	6" thick dark yellowish brown fine to medium grained sandy silty CLAY, poorly graded, very stiff, moist, non-plastic, weakly cemented.			
4 - 7	Saugus Formation; Mottled dark yellowish brown silty fine grained SANDSTONE to fine grained sandy SILTSTONE, poorly graded, very dense to hard, moist, weakly cemented, and olive green clayey silty fine to coarse grained SANDSTONE, graded, very dense, moist, weakly cemented.	@7' CH N45W/14SW		
7 - 9	3-4" thick discontinuous channel deposit, olive green fine gravel CONGLOMERATE with silty fine to coarse sand matrix, graded, weakly cemented, subangular to subrounded.			
Total Depth - 9' No groundwater No caving Backfilled				
Graphic Log				
scale 1" = 5'	GEOLABS-WESTLAKE VILLAGE	W.O.	8838	PLATE TP180

LOG OF EXCAVATION		Logged By: RMP	Date Excavated: 8/4/06	Client: Pardee Homes
Trench No. TP181				
Depth (ft)	Description	Comments		
0 - 1.5	<u>Topsoil</u> : Dark brown clayey silty fine to coarse grained SAND with fine gravel, graded, medium dense, moist, weakly cemented, rootlets.			
1.5 - 9	<u>Saugus Formation</u> : Weathered to 4' (rootlets).			
2.5 - 3	Grades to dark yellowish brown coarse gravel CONGLOMERATE with silty fine to medium sand matrix, well graded, dense, moist, subrounded to rounded, weakly cemented, pervasive carbonate veinlets.			
3 - 4	Yellowish brown silty fine to coarse grained SANDSTONE with fine gravel, graded, dense, moist, weakly cemented.			
4 - 5	Color change to pale brown, lose silt, gravels coarsen to cobbles.			
5 - 5'3"	Wavy slightly scoured contact with 3" thick dark yellowish brown CLAYSTONE, poorly graded, very stiff, moist, slightly plastic.	@5' B N75E/37NW		
5'3" - 8	Grades to yellowish brown clayey silty fine to coarse grained SANDSTONE, graded, moist, weakly cemented.			
8 - 9	Grades to pale brown cobble CONGLOMERATE with silty fine to coarse sand matrix, well graded, dense, moist, slightly friable, subrounded.	@8.5' B N61E/25NW		
Total Depth - 9' No groundwater, No caving, Backfilled				
Graphic Log				
scale 1" = 5'		GEOLABS-WESTLAKE VILLAGE	W.O. 8838	PLATE TP181

LOG OF EXCAVATION
Trench No. TP182

Logged By: RMP

Date Excavated: 8/4/06

Client: Pardee Homes

Description

Comments

0 - 2 Topsoil: Dark brown clayey silty fine to coarse grained SAND with fine gravel, graded, medium dense, moist, weakly cemented, rootlets.

2 - 6 Saugus Formation: Weathered to 6' (rootlets, carbonate veins), pale brown gravel to cobble CONGLOMERATE with silty fine to coarse sand matrix, well graded, moist, slightly friable, subrounded, overlying highly scoured contact with dark yellowish brown silty CLAYSTONE, poorly graded, very stiff, moist, non-plastic, weakly cemented, pervasive carbonate veins, contact is sharp in northern portion of trench on west wall only, other walls have scoured contact.

@2' C
N88W/49NE
@2.5' B
Approximate
N79E/19SE

Total Depth - 6'
No groundwater
No caving
Backfilled

Graphic Log

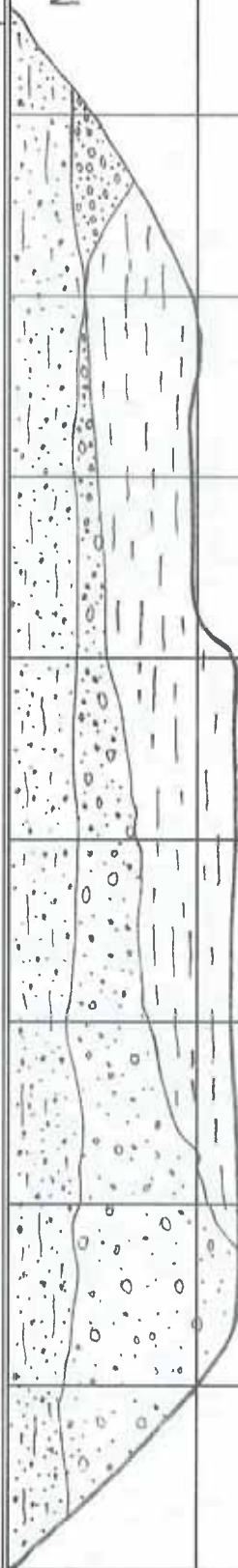

scale 1" = 5'

GEOLABS-WESTLAKE VILLAGE

W.O. 8838

PLATE

TP182

LOG OF EXCAVATION
Trench No. TP183

Logged By: RMP

Date Excavated: 8/4/06

Client: Pardee Homes

Depth (ft)	Description	Comments
0 - 1.5	<u>Topsoil</u> : Dark brown silty fine to coarse grained SAND with fine gravel, graded, loose, dry, slightly friable, rootlets.	
1.5 - 5	<u>Terrace Deposits</u> : Reddish brown fine to coarse grained gravel CONGLOMERATE with fine to coarse sand matrix, well graded, dense, moist, subangular to subrounded, weakly cemented, grades to cobble CONGLOMERATE at base with trace boulders.	
5 - 7	<u>Saugus Formation</u> : Weathered to 7' (rootlets), yellowish brown cobble CONGLOMERATE with fine to coarse sand matrix, well graded, dense, moist, slightly friable, subrounded to rounded.	@6' B N7W/16SW
Total Depth - 7' No groundwater No caving Backfilled		

N16E →

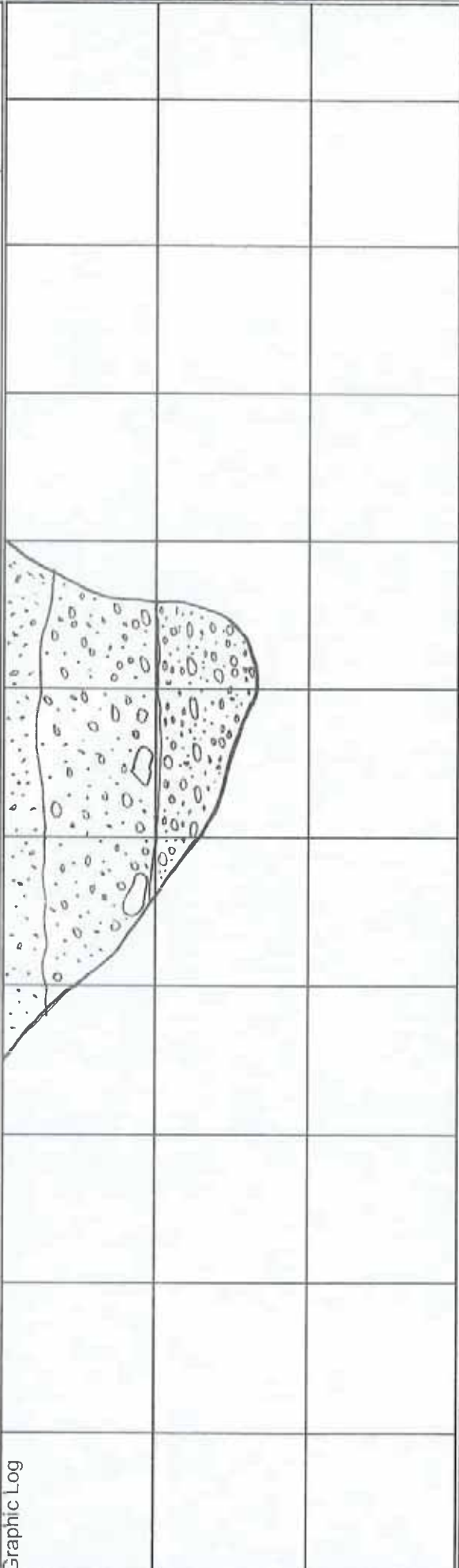

scale 1" = 5'

GEOLABS-WESTLAKE VILLAGE

W.O. 8838

PLATE

TP183

LOG OF EXCAVATION
 Trench No. TP184
 Logged By: RMP
 Date Excavated: 8/4/06
 Client: Pardee Homes

Depth (ft)	Description	Comments
0 - 3	<u>Topsoil</u> : Brown silty fine to coarse grained SAND with fine gravel, graded, loose, dry, slightly friable, rootlets.	
3 - 12.5	<u>Weathered Saugus Formation</u> : Yellowish brown clayey silty fine to coarse grained SANDSTONE, graded, medium dense, moist, slightly friable, occasional subangular to subrounded gravels and cobbles, rootlets to 8'.	
7 - 7'3"	1-3" thick discontinuous red clayey SILTSTONE to silty CLAYSTONE, poorly graded, stiff, moist, slightly plastic.	
8 - 8.5	6" thick discontinuous pale brown silty fine to coarse grained SANDSTONE with fine gravel.	
8.5 - 12.5	Silty fine grained SANDSTONE to fine grained sandy SILTSTONE, poorly graded, dense, moist, grades down to yellowish brown clayey silty fine to coarse grained SANDSTONE, graded, medium dense, moist, slightly friable.	
	Total Depth - 12.5' No groundwater No caving Backfilled	

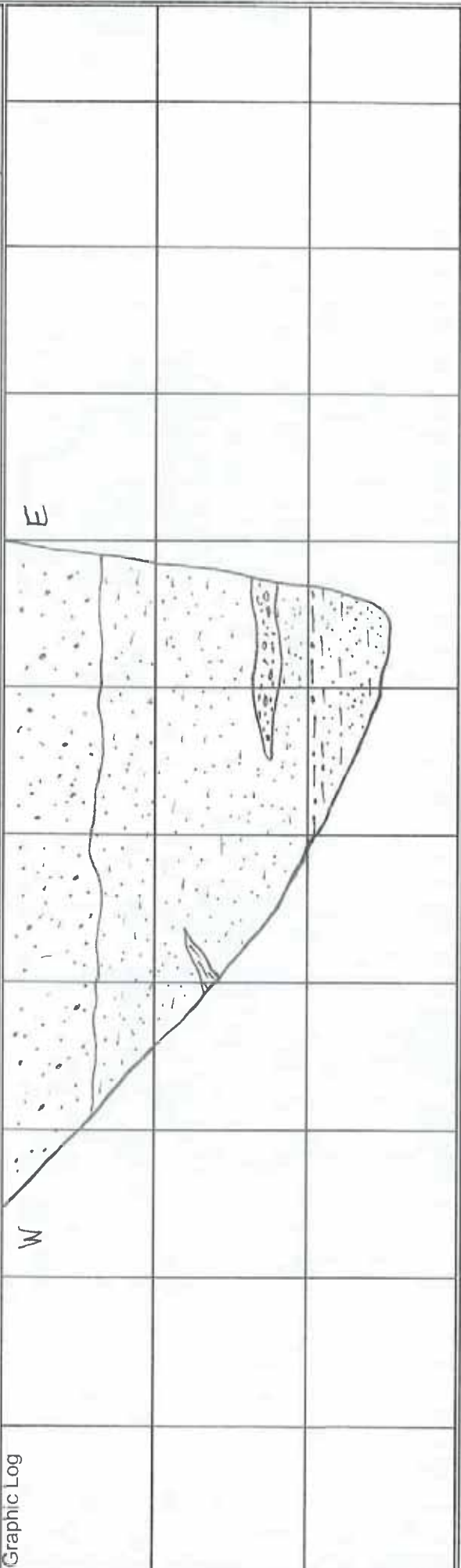

scale 1" = 5' GEOLABS-WESTLAKE VILLAGE W.O. 8838 PLATE TP184

LOG OF EXCAVATION
Trench No. TP185

Logged By: RMP

Date Excavated: 8/4/06

Client: Pardee Homes

Description

Depth (ft)

0 - 0.5

Topsoil: Dark brown silty fine to coarse grained SAND with fine gravel, graded, loose, dry, slightly friable, rootlets.

0.5 - 3

Terrace Deposits: Reddish brown fine grained GRAVEL with fine to coarse sand matrix, well graded, dense, moist, weakly cemented, subangular to subrounded, upper foot fractured and blocky, rootlets, grades to cobble GRAVEL at base.

3 - 9

Saugus Formation: Yellowish brown gravel to cobble CONGLOMERATE with fine to coarse sand matrix, well graded, dense, moist, slightly friable, subangular to subrounded.

@5' B
N80W/37NE

Total Depth - 9'
No groundwater
No caving
Backfilled

N52E →

Graphic Log

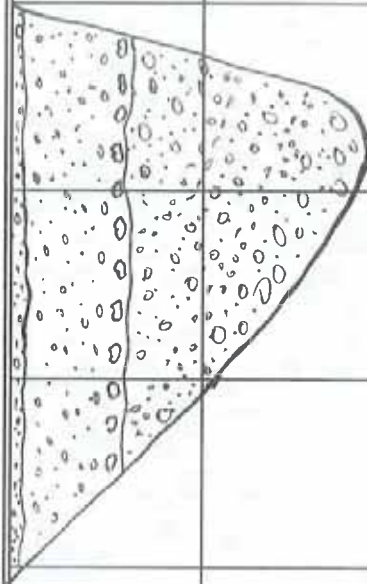

scale 1" = 5'

GEOLABS-WESTLAKE VILLAGE

W.O. 8838

PLATE

TP185

LOG OF EXCAVATION
Trench No. TP186

Logged By: RMP

Date Excavated: 8/4/06

Client: Pardee Homes

Depth (ft)	Description	Comments
0 - 2	<u>Topsoil</u> : Dark brown silty fine to coarse grained SAND with fine gravel, graded, medium dense, dry, rootlets, weakly cemented.	
2 - 4	<u>Colluvium</u> : Yellowish brown fine to coarse grained GRAVEL with fine to coarse sand matrix, well graded, medium dense, moist, slightly friable.	
4 - 7	Highly irregular contact with mottled yellowish brown clayey SILT and dark yellowish brown silty CLAY, poorly graded, stiff, moist, non-plastic, weakly cemented.	
7 - 9	<u>Saugus Formation</u> : Weathered to 9', rootlets to 8', pale brown gravel to cobble CONGLOMERATE with silty fine to coarse sand matrix, well graded, dense, moist, slightly friable, occasional rootlets in upper foot.	@8' B N76W/24NE
9 - 10	Yellowish brown clayey SILTSTONE, poorly graded, very stiff, moist, weakly cemented, massive.	
Total Depth - 10' No groundwater No caving Backfilled		

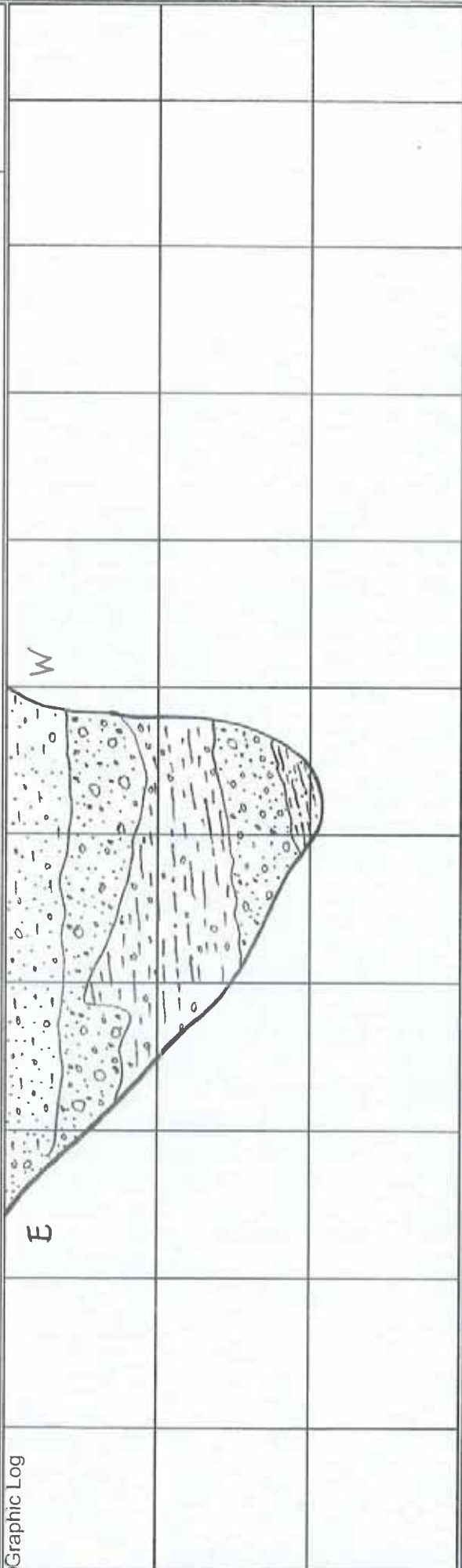

scale 1" = 5'

GEOLABS-WESTLAKE VILLAGE W.O. 8838

PLATE TP186

LOG OF EXCAVATION
Trench No. TP187

Logged By: RMP

Date Excavated: 8/4/06

Client: Pardee Homes

Depth (ft) Description

- 0 - 1 Topsoil: Dark brown silty fine to coarse grained SAND with fine gravel, graded, loose, dry, slightly friable, rootlets.
- 1 - 2.5 Saugus Formation: Weathered to 14', rootlets, reddish brown fine grained gravel CONGLOMERATE with silty fine to coarse sand matrix, graded, dense, moist, weakly cemented, clasts are subangular to subrounded.
- 2.5 - 14 Yellowish brown subrounded cobble CONGLOMERATE with friable fine to coarse sand matrix, well graded, dense, moist.

Total Depth - 14'
No groundwater
No caving
Backfilled

@4' Approx.
BN79E/14NW

Comments

N20E →

Graphic Log

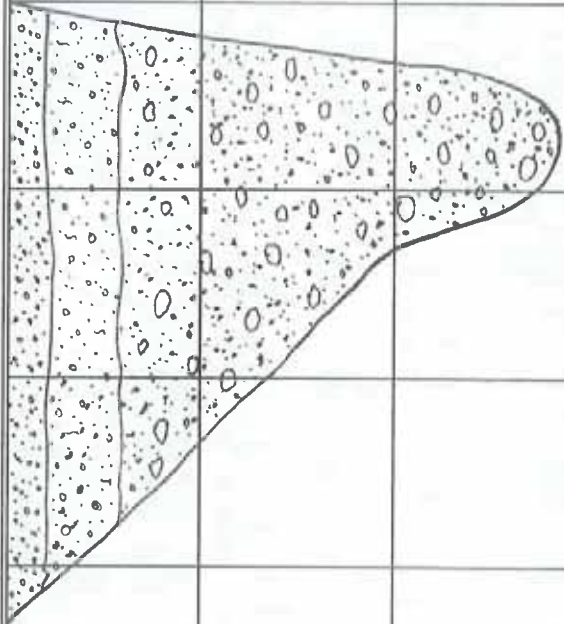

scale 1" = 5'

GEOLABS-WESTLAKE VILLAGE

W.O. 8838

PLATE

TP187

LOG OF EXCAVATION
Trench No. TP188

Logged By: RMP

Date Excavated: 8/4/06

Client: Pardee Homes

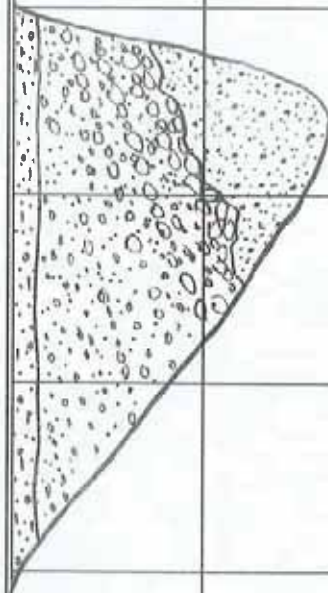
Depth (ft)	Description	Comments
0 - 1	<u>Topsoil</u> : Dark brown silty fine to coarse grained SAND with fine gravel, graded, loose, dry, friable, rootlets.	
1 - 6	<u>Saugus Formation</u> : Weathered to 6.5' (rootlets), yellowish brown subangular to subrounded fine grained gravel CONGLOMERATE with slightly friable to weakly cemented clayey silty fine to coarse sand matrix, well graded, very dense, moist, rootlets, clasts coarsen to cobbles with depth.	@3.5' B N11W/6SW
6 - 8	Wavy, scoured contact with yellowish brown fine to coarse grained SANDSTONE, poorly graded, very dense, moist, weakly cemented.	
Total Depth - 8' No groundwater No caving Backfilled		
Graphic Log		
scale 1" = 5'	GEOLABS-WESTLAKE VILLAGE	W.O. 8838
	PLATE	TP188

LOG OF EXCAVATION		Logged By: RMP	Date Excavated: 8/4/06	Client: Pardee Homes
Trench No. TP189				
Depth (ft)	Description	Comments		
0 - 2.5	<u>Topsoil</u> : Dark brown silty fine to coarse grained SAND with fine gravel, graded, loose, dry, friable, rootlets.			
2.5 - 3.5	<u>Saugus Formation</u> : Weathered to 9' (rootlets to 7.5'), yellowish brown silty fine grained SANDSTONE, poorly graded, dense, moist, weakly indurated, massive.			
3.5 - 4	6" thick subangular to subrounded fine grained gravel CONGLOMERATE with slightly friable to weakly cemented silty fine to coarse sand matrix, well graded, very dense, moist.			
4 - 5.5	Yellowish brown fine grained sandy SILTSTONE, poorly graded, very stiff, moist, weakly indurated, massive.			
5.5 - 8.5	Grades to pale brown silty fine to medium grained SANDSTONE.	@8' B N34W/13SW		
8.5 - 9	Grades to subangular to subrounded gravel to cobble CONGLOMERATE with weakly cemented silty fine to coarse sand matrix, well graded, very dense, moist.			
9 - 9.5	Yellowish brown silty fine grained SANDSTONE, poorly graded, very dense, moist, weakly indurated, massive.			
Total Depth - 9.5' No groundwater No caving Backfilled				
Graphic Log	<p style="text-align: center;">N7E →</p>			
scale 1" = 5'	GEOLABS-WESTLAKE VILLAGE	W.O. 8838	PLATE	TP189

Depth (ft)	Description	Comments
0 - 1	<u>Topsoil</u> : Dark brown silty fine to coarse grained SAND with sparse fine gravel, graded, loose, dry, friable, rootlets.	
1 - 6	<u>Saugus Formation</u> : Weathered to 10' (rootlets to 8.5'), yellowish brown fine grained sandy SILTSTONE, poorly graded, stiff, dry, pervasively fractured and blocky, pervasive carbonate veins.	
3 - 3'3"	Grades to 3" thick subrounded fine grained gravel CONGLOMERATE with friable fine to coarse sand matrix, graded, medium dense, dry.	
6 - 6'3"	3" thick dark yellowish brown silty CLAYSTONE, poorly graded, very stiff, moist, carbonate veinlets, non-plastic, weakly indurated.	
6'3" - 8	Grades to yellowish brown subangular to subrounded fine to coarse grained gravel CONGLOMERATE with weakly cemented silty fine to coarse sand matrix, well graded, dense, moist.	@7' Approx. BN2E/4SE
8 - 10	2' thick dark yellowish brown CLAYSTONE, hard, moist, non-plastic.	
10 - 12	Grades to silty fine grained SANDSTONE with sparse fine gravel, graded, very dense, moist, weakly indurated.	
Total Depth - 12' No groundwater No caving Backfilled		

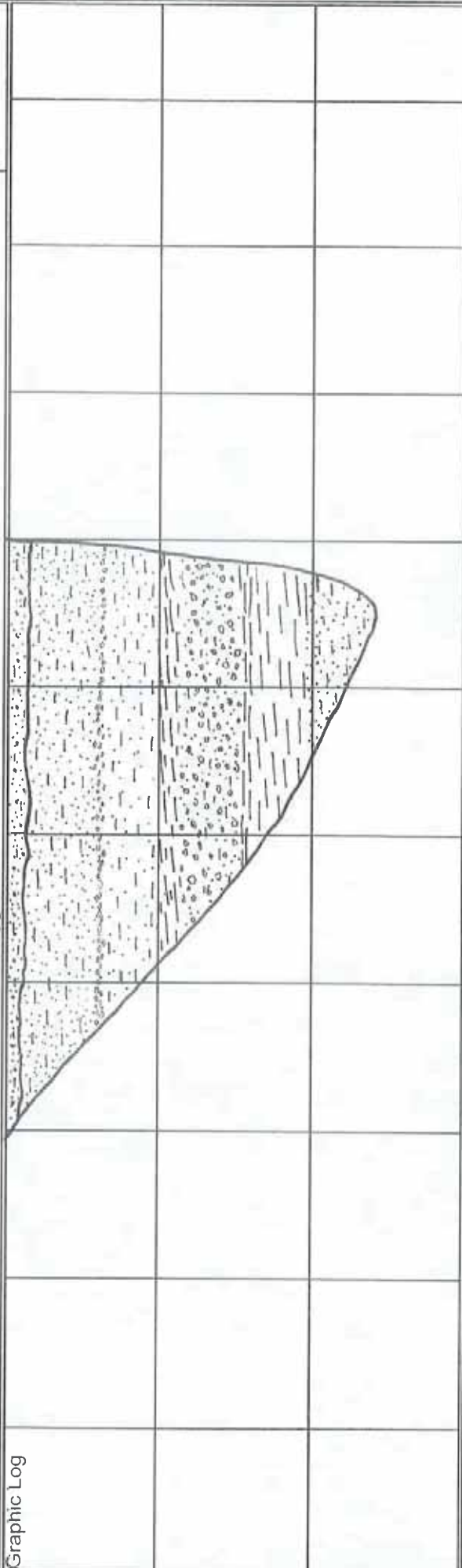

scale 1" = 5'

GEOLABS-WESTLAKE VILLAGE

W.O. 8838

PLATE

TP190

LOG OF EXCAVATION
Trench No. TP191

Logged By: RMP

Date Excavated: 8/7/06

Client: Pardee Homes

Depth (ft)

0 - 1

1 - 7.5

Description

Topsoil: Dark brown silty fine to coarse grained sandy fine GRAVEL with cobbles, well graded, loose, moist, rootlets.

Mint Canyon Formation: Weathered to 5', rootlets to 2.5', scoured interbeds of reddish brown and olive green subangular to subrounded cobble CONGLOMERATE with trace boulders and weakly cemented silty fine to coarse sand matrix, well graded, hard, moist.

Total Depth - 7.5'
No groundwater
No caving
Backfilled

@5' B
N28W/21SW

Comments

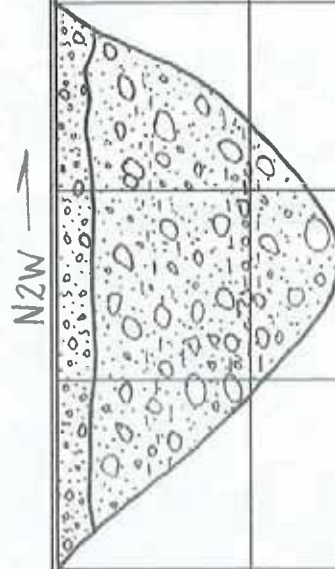

Graphic Log

scale 1" = 5'

GEOLABS-WESTLAKE VILLAGE

W.O. 8838

PLATE

TP191

LOG OF EXCAVATION Trench No. TP192	Logged By: RMP	Date Excavated: 8/7/06	Client: Pardee Homes		
Depth (ft)	Description			Comments	
0 - 1.5	<u>Topsoil</u> : Dark brown silty fine to coarse grained sandy GRAVEL with cobbles, well graded, loose, moist.				
1.5 - 2	<u>Saugus Formation</u> : Weathered to 4' (roots to 3'), reddish brown subangular to subrounded fine grained gravel CONGLOMERATE with slightly friable fine to coarse sand matrix, well graded, very dense, moist.				
2 - 3	Grades to gravel to cobble CONGLOMERATE.				
3 - 4.5	Scoured contact to dark brown fine to coarse grained sandy SILTSTONE with trace fine gravel, poorly graded, hard, moist, weakly indurated, massive, blocky.				
4.5 - 7	Dark yellowish brown subangular to subrounded gravel to cobble CONGLOMERATE with weakly cemented fine to coarse sandy silt matrix, well graded, hard, matrix coarsens with depth and becomes slightly friable.			@6' B N40W/8SW	
	Total Depth - 7' No groundwater No caving Backfilled				
Graphic Log					
scale 1" = 5'	GEOLABS-WESTLAKE VILLAGE	W.O.	8838	PLATE	TP192

LOG OF EXCAVATION		Logged By: RMP	Date Excavated: 8/7/06	Client: Pardee Homes
Trench No. TP193				
Depth (ft)	Description	Comments		
0 - 1.5	<u>Topsoil</u> : Dark brown fine to coarse grained sandy silty GRAVEL, well graded, loose, dry, weakly cemented, fractured and blocky.			
1.5 - 4.5	<u>Saugus Formation</u> : Weathered to 5' (roots to 4'), yellowish brown subangular to subrounded gravel to cobble CONGLOMERATE with slightly friable fine to coarse sand matrix (trace silt), well graded, very dense, dry.	@4' B N24W/16SW		
4.5 - 5.5	Wavy, sharp, slightly scoured contact to mottled brown and olive green trace gravelly silty fine to coarse grained SANDSTONE, poorly graded, very dense, moist, weakly cemented, massive.			
5.5 - 7	Yellow brown subangular to subrounded gravel to cobble CONGLOMERATE with slightly friable fine to coarse sand matrix (trace silt), well graded, hard, moist.			
Total Depth - 7' No groundwater No caving Backfilled				
Graphic Log				
scale 1" = 5'	GEOLABS-WESTLAKE VILLAGE	W.O. 8838	PLATE	TP193

LOG OF EXCAVATION Trench No. TP194		Logged By: RMP	Date Excavated: 8/7/06	Client: Pardee Homes
Depth (ft)	Description	Comments		
0 - 1	Topsoil: Dark brown fine to coarse grained sandy SILT with fine gravel, graded, soft, dry, slightly friable.			
1 - 2.5	Saugus Formation: Weathered to 5' (roots to 3'), yellowish brown fine to coarse grained SANDSTONE, poorly graded, very dense, moist, slightly friable.			
2.5 - 7	Grades to yellowish brown subangular to subrounded cobble CONGLOMERATE with slightly friable silty fine to coarse sand matrix, well graded, very dense, moist.	@6' B N44W/20SW		
7 - 7.5	Wavy, sharp, scoured contact with 6" thick mottled dark brown and olive green silty fine to medium grained SANDSTONE, poorly graded, hard, moist, weakly indurated.			
7.5 - 8	Grades to yellowish brown subangular to subrounded cobble CONGLOMERATE with slightly friable silty fine to coarse sand matrix, well graded, hard, moist.			
Total Depth - 8' No groundwater No caving Backfilled				
Graphic Log				
scale 1" = 5'	GEOLABS-WESTLAKE VILLAGE	W.O. 8838	PLATE	TP194

LOG OF EXCAVATION
 Trench No. TP195

Logged By: RMP

Date Excavated: 8/7/06

Client: Pardee Homes

Depth (ft)	Description	Comments
0 - 1	<u>Topsoil</u> : Dark gray brown silty fine to coarse grained SAND with fine gravel, graded, loose, dry, weakly cemented, rootlets.	
1 - 9	<u>Mint Canyon Formation</u> : Weathered to 8', rootlets to 5', light yellowish brown subangular to subrounded cobble CONGLOMERATE with slightly friable matrix, well graded, very dense, moist.	@5' B N35E/18NW
Total Depth - 9' No groundwater No caving Backfilled		

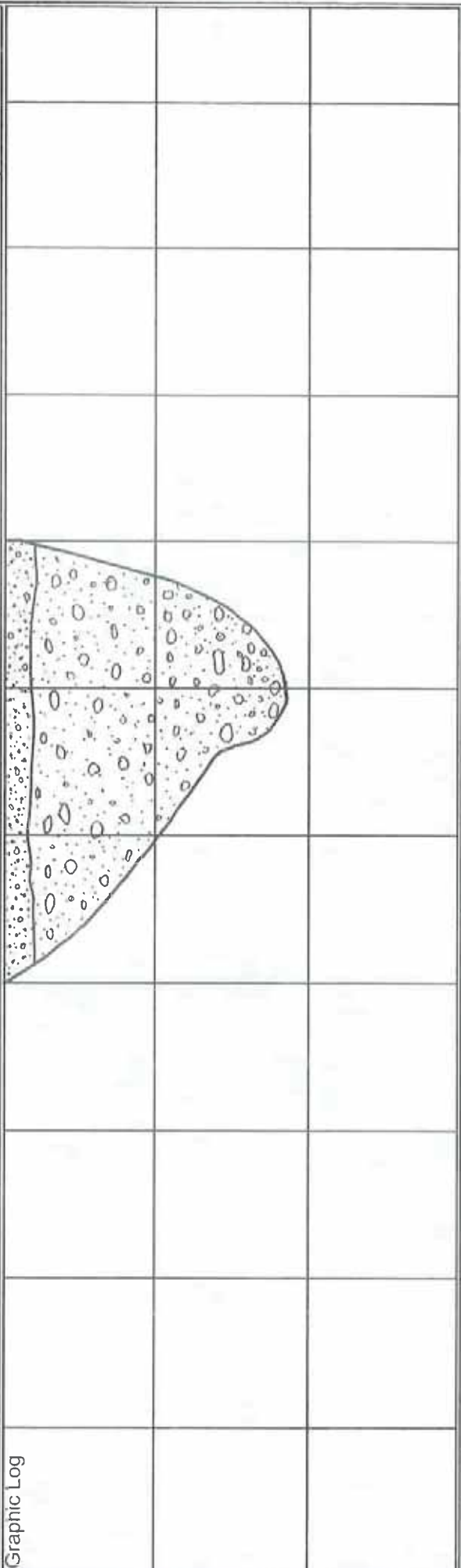

scale 1" = 5' GEOLABS-WESTLAKE VILLAGE W.O. 8838 PLATE TP195

Depth (ft)	Description	Comments
0 - 2.5	<u>Topsoil</u> : Dark brown fine to coarse grained sandy SILT, graded, loose to medium dense, moist, slightly friable.	
2.5 - 9	<u>Mint Canyon Formation</u> : Weathered to 9' (roots to 8'), yellowish brown fine grained sandy SILTSTONE, poorly graded, very stiff, moist, weakly indurated, white carbonate veinlets, occasional subangular fine gravel, massive.	
9 - 10	Hard.	
Total Depth - 10' No groundwater No caving Backfilled		

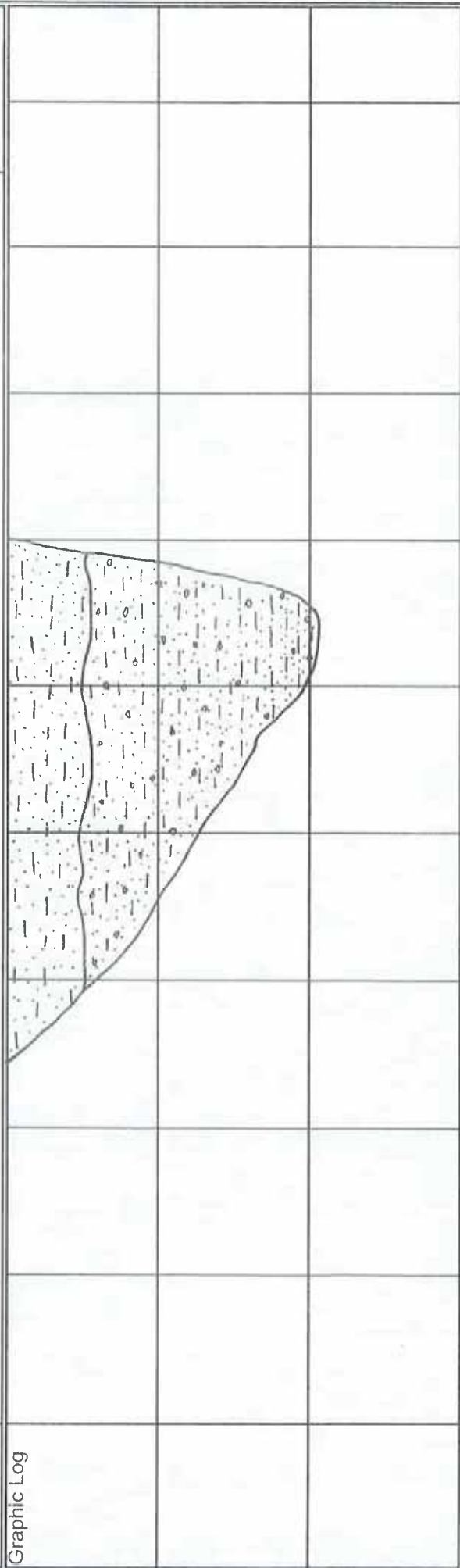

LOG OF EXCAVATION
Trench No. TP197

Logged By: RMP

Date Excavated: 8/7/06

Client: Pardee Homes

Depth (ft)	Description	Comments
0 - 2.5	<u>Topsoil</u> : Dark brown fine to coarse grained sandy SILT with fine gravel, graded, stiff, moist, weakly cemented.	
2.5 - 5.5	<u>Mint Canyon Formation</u> : Weathered to 8.5' (roots to 5', carbonate veins), pale yellowish brown subangular to subrounded fine grained gravel CONGLOMERATE with slightly friable with silty fine to coarse sand matrix, well graded, medium dense, moist.	
5.5 - 7.5	Grades to subangular to subrounded gravel to cobble CONGLOMERATE with slightly friable silty fine to coarse sand matrix, well graded, dense, moist.	
7.5 - 9.5	Scoured, irregular contact with discontinuous pale brown silty fine to coarse grained SANDSTONE, poorly graded, hard, moist, slightly friable, massive, white carbonate veins.	@8' Approx. BN57W/19SW
9.5 - 10.5	Grades to subangular to subrounded cobble CONGLOMERATE with slightly friable silty fine to coarse sand matrix, well graded, hard, moist.	
Total Depth - 10.5' No groundwater No caving Backfilled		

N85E →

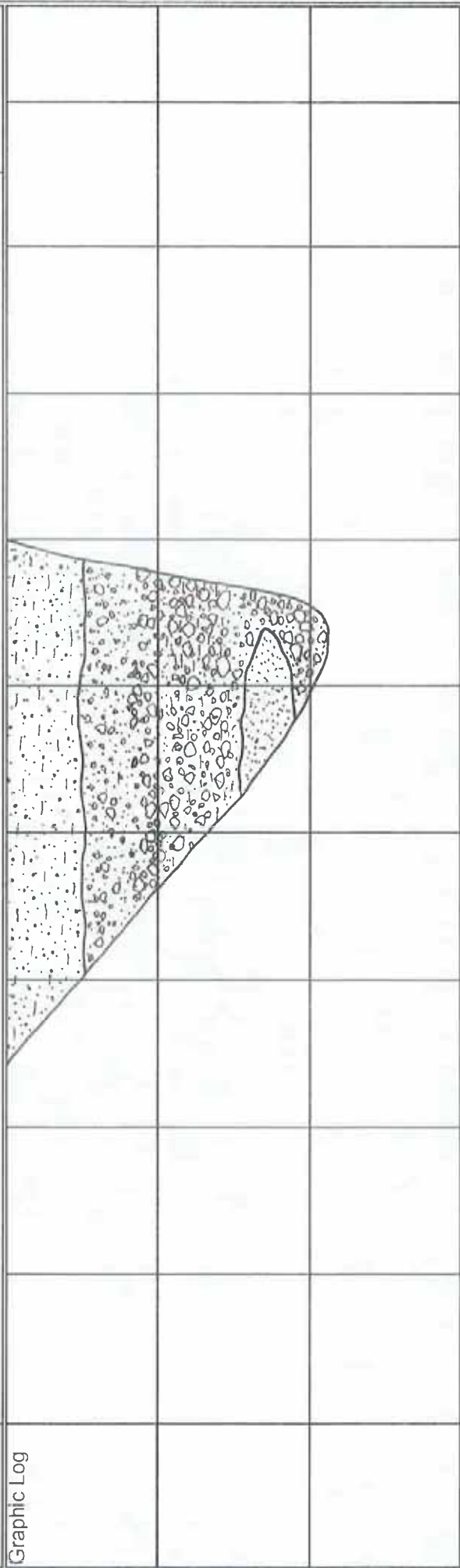

scale 1" = 5'

GEOLABS-WESTLAKE VILLAGE

W.O. 8838

PLATE

TP197

Depth (ft)	Description	Comments
0 - 2	<u>Topsoil</u> : Dark brown fine to coarse grained sandy SILT with fine gravel, graded, soft, moist, rootlets.	
2 - 12	<u>Mint Canyon Formation</u> : Weathered to 8', roots to 4', light yellowish brown subangular to subrounded cobble CONGLOMERATE with slightly friable matrix, well graded, dense, moist, trace boulders.	@7' Approx. BN5W/15SW
@8'	Grades to very dense.	
	Total Depth - 12' No groundwater No caving Backfilled	

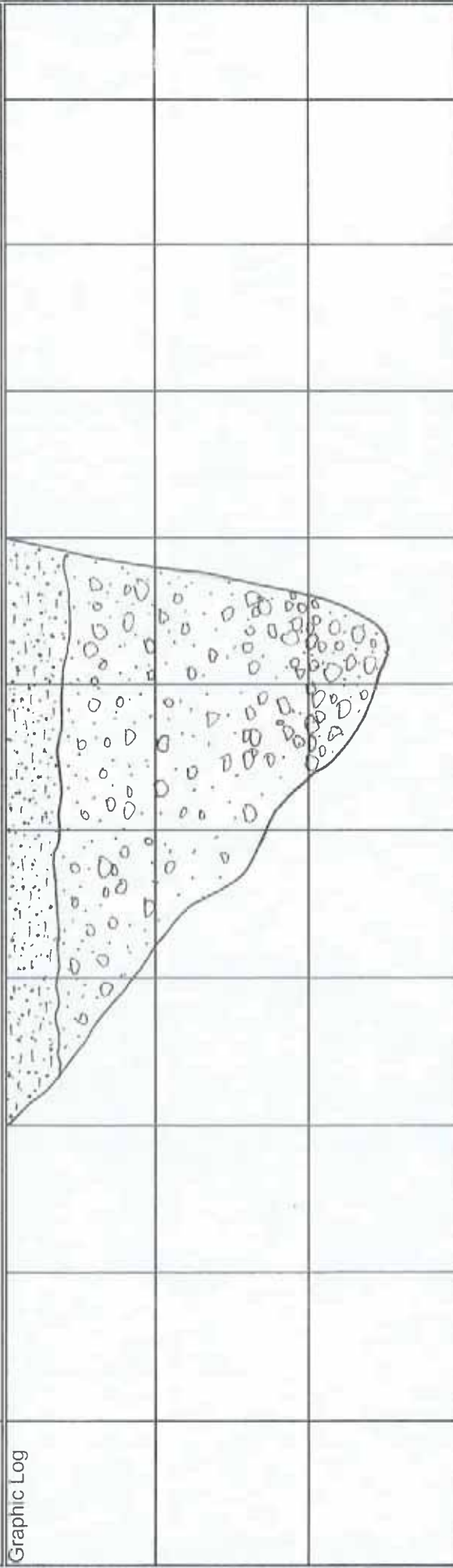

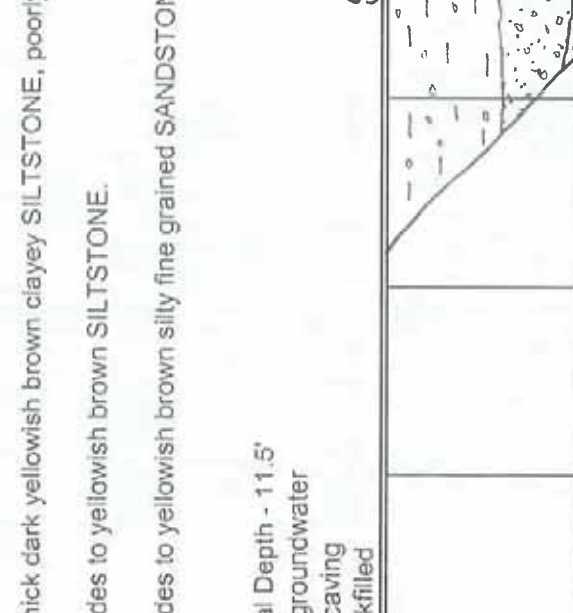
LOG OF EXCAVATION Trench No. TP199	Logged By: RMP	Date Excavated: 8/7/06	Client: Pardee Homes
Depth (ft)	Description		
0 - 3	Topsoil: Dark brown fine to coarse grained sandy SILT with fine gravel, graded, very stiff, moist, rootlets.		
3 - 5.5	Saugus Formation: Weathered to 9' (roots to 5'), yellowish brown silty fine grained SANDSTONE, poorly graded, dense, moist, weakly indurated, massive.		
5.5 - 6	Grades to yellowish brown fine to coarse grained SANDSTONE with fine gravel, graded, dense, moist, slightly friable.		
6 - 8	Wavy, scoured contact with yellowish brown fine grained sandy SILTSTONE, poorly graded, very stiff, moist, slightly friable, massive, white carbonate veins.		
8 - 8.5	6" thick dark yellowish brown clayey SILTSTONE, poorly graded, hard, moist, weakly indurated, massive.		
8.5 - 11	Grades to yellowish brown SILTSTONE.		
11 - 11.5	Grades to yellowish brown silty fine grained SANDSTONE, poorly graded, hard, moist, weakly indurated.		
	Total Depth - 11.5' No groundwater No caving Backfilled		
Graphic Log			
scale 1" = 5'	GEOLABS-WESTLAKE VILLAGE	W.O. 8838	PLATE TP199

@5.5' B
N81E/13SE

LOG OF EXCAVATION		Logged By: RMP	Date Excavated: 8/8/06	Client: Pardee Homes
Trench No. TP200				
Depth (ft)	Description			
0 - 3	Topsoil: Dark brown clayey fine to coarse grained sandy SILT, graded, very stiff, moist, blocky and pervasively fractured, rootlets.			
3 - 6	Terrace Deposits: Weathered to 6' (rootlets), yellow brown silty fine grained SAND, poorly graded, dense, moist, consolidated, pervasive carbonate veins.			
6 - 11	Grades to yellow brown cobble to boulder GRAVEL with slightly friable fine to coarse sand matrix, well graded, very dense, moist, subrounded to rounded, 10% boulders.			
Total Depth - 11' No groundwater No caving Backfilled				
NTE →				
Graphic Log				
scale 1" = 5'	GEOLABS-WESTLAKE VILLAGE	W.O. 8838	PLATE	TP200

LOG OF EXCAVATION
Trench No. TP201

Logged By: RMP

Date Excavated: 8/8/06

Client: Pardee Homes

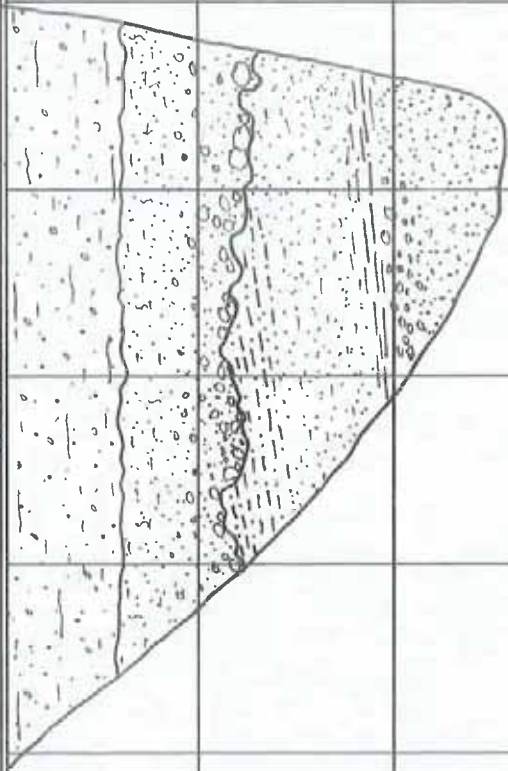
Depth (ft)	Description	Comments
0 - 3	<u>Topsoil</u> : Dark brown clayey silty fine to coarse grained SAND with fine gravel, graded, dense, moist, rootlets.	
3 - 4	<u>Terrace Deposits</u> : Yellowish brown silty fine to coarse grained SAND, poorly graded, very dense, moist, consolidated, roots.	
4 - 6	Grades to yellowish brown subangular to subrounded fine to coarse grained gravel CONGLOMERATE with slightly friable silty fine to coarse sand matrix, well graded, very dense, moist.	
6 - 6.5	<u>Saugus Formation</u> : Weathered to 9.5', irregular scoured contact with yellowish brown fine grained sandy SILTSTONE, poorly graded, very dense, moist, slightly friable.	
6.5 - 9	Grades to silty fine to medium grained SANDSTONE.	
9 - 9.5	Gradational contact with 6" thick dark yellowish brown CLAYSTONE, very stiff, moist, weakly indurated, medium plastic, pervasive internal shearing truncated above and below by sandstone beds, discontinuous (scoured out by conglomerate on east wall), sharp, irregular, sheared contact with material below.	@10' B N6E/19NW
9.5 - 10.5	Channel Deposit: Yellow brown subangular to subrounded gravel CONGLOMERATE with slightly friable silty fine to coarse sand matrix, well graded, very dense, moist.	
10.5 - 12.5	Yellowish brown fine to coarse grained SANDSTONE, poorly graded, very dense, moist, slightly friable, massive.	Total Depth - 12.5' No groundwater No caving Backfilled
Graphic Log	 <p>The graphic log is a cross-section of the excavation showing soil layers. The vertical axis represents depth in feet, with markers at 0, 3, 4, 6, 6.5, 9, 9.5, 10.5, and 12.5. The horizontal axis represents distance across the excavation. The soil layers are depicted with various patterns and textures corresponding to the descriptions in the table. A north arrow is shown pointing towards the top of the page, labeled 'N25E'.</p>	
scale 1" = 5'	GEOLABS-WESTLAKE VILLAGE W.O. 8838	PLATE TP201

LOG OF EXCAVATION
Trench No. TP202

Logged By: RMP

Date Excavated: 8/8/06

Client: Pardee Homes

Comments

Description

Topsoil: Dark brown fine to coarse grained sandy silty CLAY with fine gravel, graded, very dense, moist, rootlets.

Terrace Deposits: Pale brown cobble to boulder GRAVEL with slightly friable fine to coarse sand matrix, well graded, very dense, moist.

Saugus Formation: Weathered to 11.5', yellowish brown fine to coarse grained SANDSTONE, poorly graded, very dense, moist, slightly friable.

Total Depth - 11.5'
No groundwater
No caving
Backfilled

Graphic Log

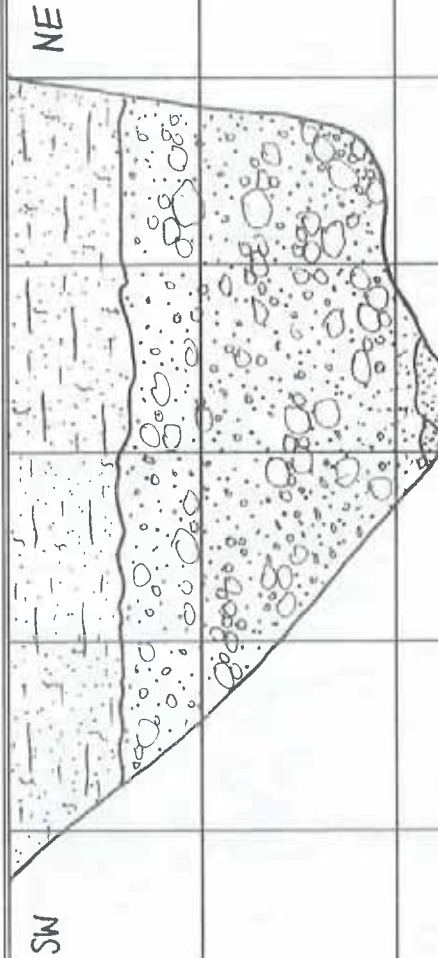

scale 1" = 5'

GEOLABS-WESTLAKE VILLAGE W.O. 8838

PLATE

TP202

LOG OF EXCAVATION		Logged By: RMP	Date Excavated: 8/8/06	Client: Pardee Homes
Trench No. TP203				
Depth (ft)	Description	Comments		
0 - 1	<p><u>Topsoil</u>: Dark brown clayey silty fine to coarse grained SAND with fine gravel, graded, very dense, moist.</p> <p><u>Saugus Formation</u>: Weathered to 4.5' (roots to 4'), yellow brown subangular to subrounded gravel to cobble CONGLOMERATE with slightly friable matrix, well graded, very dense, moist, trace boulders (2' diameter in east wall).</p> <p>Total Depth - 6' No groundwater No caving Backfilled</p>	@3' Approx. BN85W/14SW		
1 - 6				
Graphic Log				
scale 1" = 5'	GEOLABS-WESTLAKE VILLAGE	W.O.	8838	PLATE TP203

Depth (ft)	Description	Comments
0 - 2	<u>Topsoil</u> : Dark grayish brown silty fine to coarse grained SAND with fine to coarse gravel, graded, dense, dry, slightly friable, rootlets.	
2 - 3	<u>Saugus Formation</u> : Weathered to 8' (roots to 5'), brown fine grained sandy CLAYSTONE with subangular fine gravel, graded, very stiff, moist, weakly indurated.	
3 - 4	1' thick discontinuous channeled sand, yellowish brown silty fine to coarse grained SANDSTONE with subangular fine gravel, graded, very dense, moist, massive, slightly friable.	@3' CH N39E/25SE
4 - 4.5	Dark yellowish brown clayey silty fine to coarse grained SANDSTONE, graded, very dense, moist, weakly indurated.	
4.5 - 7	Yellowish brown silty fine to coarse grained SANDSTONE, poorly graded, very dense, moist, weakly indurated, massive, pervasive subhorizontal carbonate veins.	
7 - 10	Yellowish brown subangular to subrounded gravel to cobble CONGLOMERATE with slightly friable silty fine to coarse sand matrix, well graded, hard, moist.	
Total Depth - 10' No groundwater No caving Backfilled		

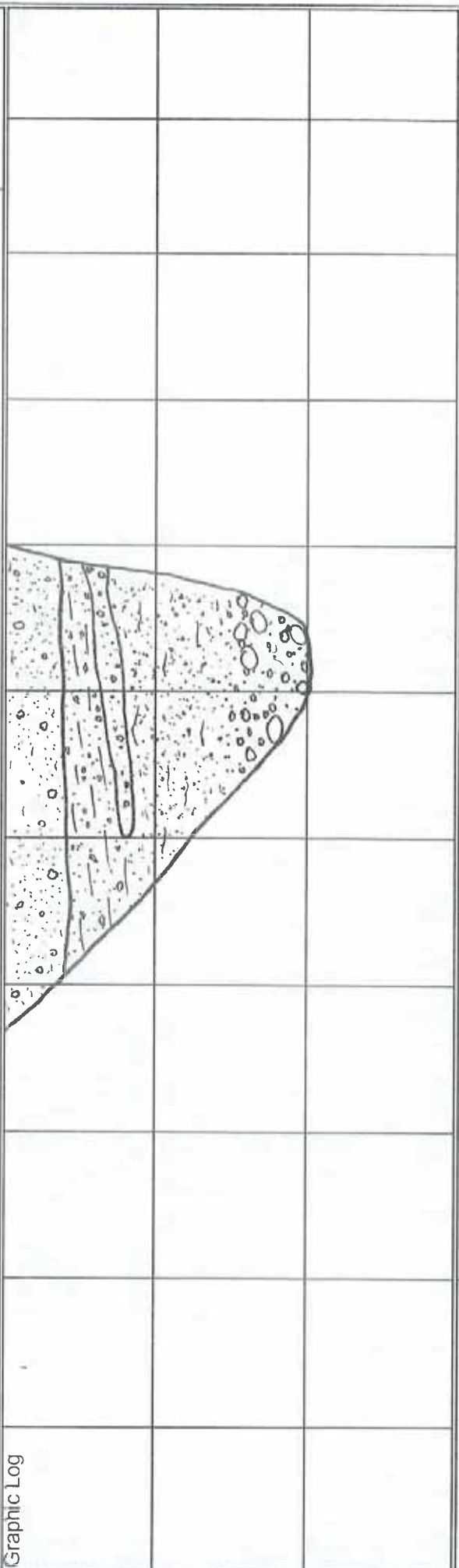

LOG OF EXCAVATION		Logged By: RMP	Date Excavated: 8/8/06	Client: Pardee Homes
Trench No. TP205				
Depth (ft)	Description	Comments		
0 - 1	<u>Topsoil</u> : Dark grayish brown silty fine to coarse grained SAND with fine gravel, graded, dense, dry, rootlets, slightly friable.			
1 - 8	<u>Saugus Formation</u> : Weathered to 6' (rootlets to 3'), yellowish brown subangular to subrounded gravel to cobble CONGLOMERATE with slightly friable fine to coarse sand matrix, well graded, very dense, moist.			
@6'	1' thick fine to coarse grained SANDSTONE layer.			
	Total Depth - 8' No groundwater No caving Backfilled			
Graphic Log				
scale 1" = 5'	GEOLABS-WESTLAKE VILLAGE	W.O.	8838	PLATE TP205

Depth (ft)	Description	Comments
0 - 2	<p><u>Topsoli</u>: Yellow brown clayey silty fine to coarse grained sandy fine GRAVEL, well graded, very dense, moist, rootlets.</p>	
2 - 7	<p><u>Saugus Formation</u>: Weathered to 6' (roots to 3'), Yellow brown gravelly SANDSTONE, grading to gravel to cobble CONGLOMERATE with slightly friable fine to coarse sand matrix, well graded, very dense, moist.</p> <p>Total Depth - 7' No groundwater No caving Backfilled</p>	<p>@5' Approx. BN13W/17SW</p>

A-515

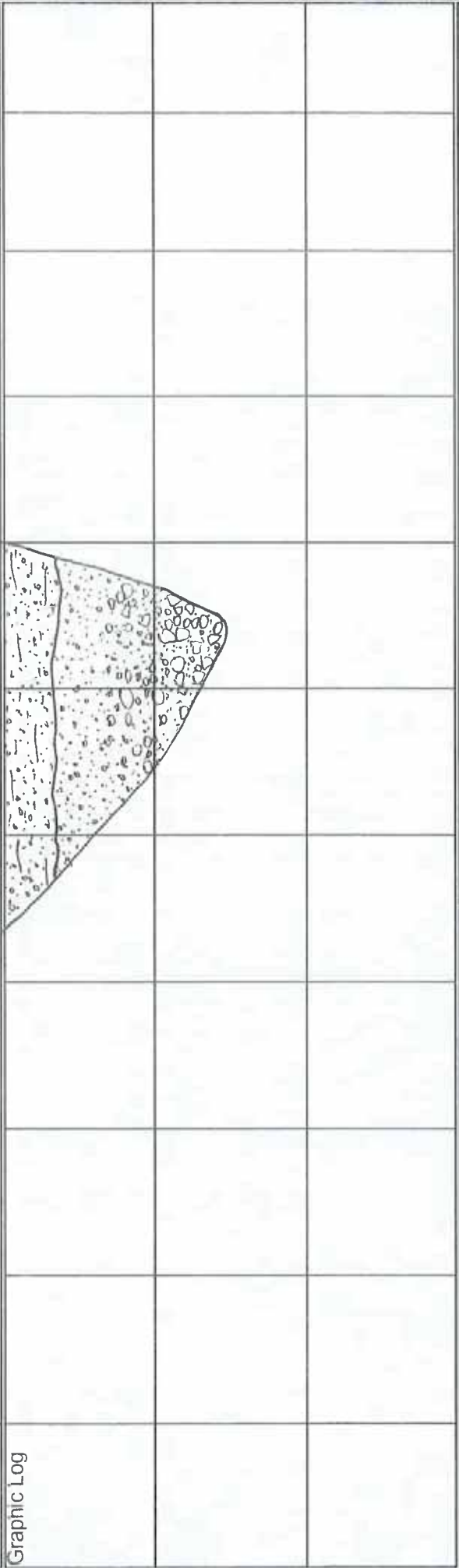

LOG OF EXCAVATION
Trench No. TP207

Logged By: RMP

Date Excavated: 8/8/06

Client: Pardee Homes

Depth (ft)	Description	Comments
0 - 1.5	<u>Topsoil</u> : Brown clayey silty fine to coarse grained SAND with fine gravel, graded, very dense, moist.	
1.5 - 3.5	<u>Saugus Formation</u> : Weathered to 8' (roots to 4', matrix tighter at 8' with more fines), yellowish brown subangular to subrounded fine to coarse grained gravel CONGLOMERATE with slightly friable fine to coarse sand matrix, well graded, very dense, moist.	
3.5 - 6	Bedding subparallel carbonate veins.	
5.5 - 8.5	Yellowish brown fine to coarse grained SANDSTONE with fine gravel, graded, very dense, moist, slightly friable, massive.	
8.5 - 9.5	Grades to subangular to subrounded gravel to cobble CONGLOMERATE with slightly friable fine to coarse sand matrix, well graded, hard, moist.	@9' B N35W/8SW
9.5 - 10	Yellowish brown fine to coarse grained SANDSTONE with fine gravel, graded, hard, moist, slightly friable, massive.	
Total Depth - 10' No groundwater No caving Backfilled		

A-516

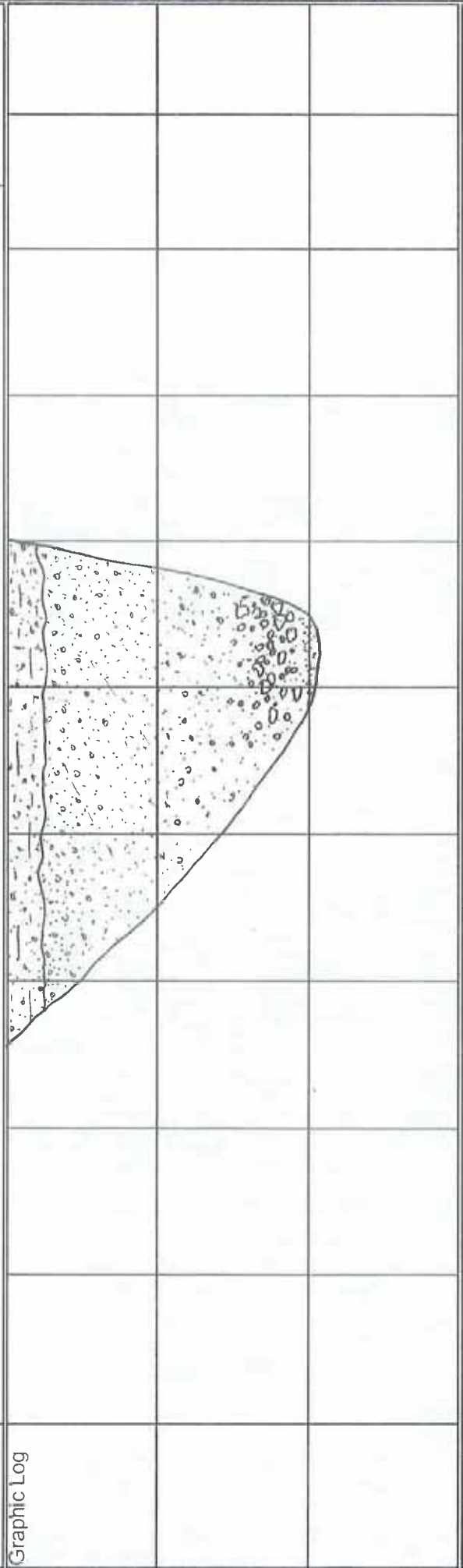

scale 1" = 5'

GEOLABS-WESTLAKE VILLAGE

W.O. 8838

PLATE

TP207

LOG OF EXCAVATION
Trench No. TP208

Logged By: RMP

Date Excavated: 8/8/06

Client: Pardee Homes

Description

Comments

- 0 - 2.5 Topsoil: Brown silty fine to coarse grained SAND, poorly graded, very dense, moist, rootlets.
- 2.5 - 5 Saugus Formation: Weathered to 9.5' (roots to 8'), yellowish brown silty fine grained SANDSTONE, poorly graded, very dense, moist, moderately indurated, pervasively fractured and blocky with white carbonate staining in fractures.
- 5 - 7.5 Yellowish brown silty fine grained SANDSTONE with sparse fine gravel, poorly graded, very dense, moist, weakly indurated, massive.
- 7.5 - 8.5 Grades to yellowish brown subangular to subrounded fine to coarse grained gravel CONGLOMERATE with slightly friable silty fine sand matrix, graded, very dense, moist.
- 8.5 - 10 Dark yellowish brown fine to medium grained sandy SILTSTONE, poorly graded, very dense, moist, weakly indurated, massive.

@8' B
N52W/14SW

Total Depth - 10'
No groundwater
No caving
Backfilled

A-517

N27E →

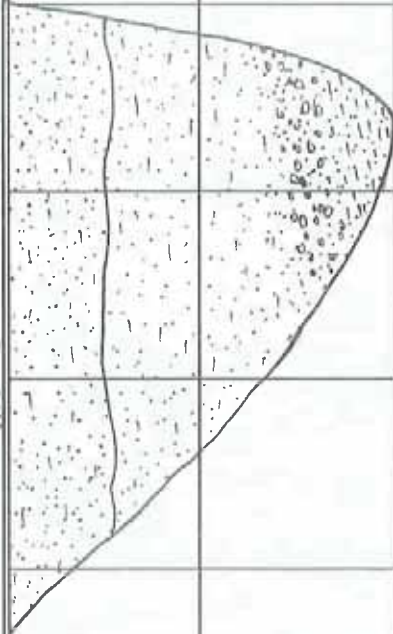

Graphic Log

scale 1" = 5'

GEOLABS-WESTLAKE VILLAGE

W.O. 8838

PLATE

TP208

LOG OF EXCAVATION		Logged By: RMP	Date Excavated: 6/21/07	Client: Pardee Homes
Trench No. TP209				
Depth (ft)	Description	Comments		
0 - 1	<u>Soil Formation:</u> Dark brown fine to coarse grained sandy GRAVEL with silt and clay, poorly sorted, medium dense, dry to moist, clasts subrounded fine gravel to boulder size, boulders to 13" in diameter, abundant root hairs and roots to 1/8" diameter.			
1 - 2.5	<u>Mint Canyon Formation:</u> Yellowish brown subrounded gravel to cobble CONGLOMERATE with silty fine to coarse sandstone matrix and boulders to 14" in diameter, poorly sorted, very dense, dry to moist, weathered, occasional rootlets.			
2.5 - 7.5	Yellowish brown subrounded gravel to cobble CONGLOMERATE with silty fine to coarse sandstone matrix, poorly sorted, very dense, moist, with trace rootlets. @5.5' - 2' thick channel sand deposit in south wall; silty fine to coarse grained SANDSTONE with gravel.	@4' Approx. BN14W/12SW		
Total Depth - 7.5' No groundwater No caving				
Graphic Log				
scale 1" = 5'	GEOLABS-WESTLAKE VILLAGE	W.O.	8838	PLATE TP209

LOG OF EXCAVATION		Logged By: RMP	Date Excavated: 6/21/07	Client: Pardee Homes
Trench No. TP210				
Depth (ft)	Description			
0 - 6	<p><u>Mint Canyon Formation</u>: Yellowish brown subangular to subrounded gravel to cobble CONGLOMERATE with silty fine to coarse sandstone matrix and trace boulders to 2' in diameter, poorly sorted, very dense, moist, slightly friable, poorly bedded, rootlets in upper 6"-1'; with boulder sized pockets of silty fine to medium sandstone.</p>			
	<p>Total Depth - 6' No groundwater No caving</p>			
A-519				
Graphic Log				
scale 1" = 5'				
GEOLABS-WESTLAKE VILLAGE			W.O. 8838	PLATE TP210

Comments

@2' B
 N16W/10SW

LOG OF EXCAVATION		Logged By: RMP	Date Excavated: 6/21/07	Client: Pardee Homes
Trench No. TP211				
Depth (ft)	Description	Comments		
0 - 1	Soil Formation: Brown silty fine to coarse grained SAND with subangular to subrounded gravel, moderately sorted, very dense, dry, rootlets.			
1 - 4	Saugus Formation: Dark yellowish brown clayey SILTSTONE with fine to coarse sand and silty CLAYSTONE with fine to coarse sand, moderately well sorted, very stiff, moist, massive, slightly plastic, scattered veins and pockets of caliche.			
Total Depth - 4' No groundwater No caving				
Graphic Log	<p>A hand-drawn graphic log showing soil layers. The top layer is labeled 'Topsoil' and contains small circles representing rootlets. Below it is a layer labeled 'J.G.' with diagonal hatching. A north arrow points to 'N58E'.</p>			
scale 1" = 5'		GEOLABS-WESTLAKE VILLAGE	W.O. 8838	PLATE TP211

LOG OF EXCAVATION		Logged By: RMP	Date Excavated: 6/21/07	Client: Pardee Homes
Trench No. TP212				
Depth (ft)	Description	Comments		
0 - 1	<u>Soil Formation:</u> Dark brown clayey fine to coarse grained SAND with silt and subrounded gravel, poorly sorted, very dense, moist, rootlets.			
1 - 4.5	<u>Saugus Formation:</u> Yellowish brown silty fine to coarse grained SANDSTONE with subangular to subrounded gravel, somewhat poorly sorted, medium dense, moist, massive, slightly friable.			
1 - 6	Yellowish brown silty fine to coarse grained SANDSTONE with clay, moderately well sorted, very dense, moist, pervasive subvertical carbonate cemented fractures, weakly indurated.	@5' Approx. BN-S/12W		
4.5 - 6	<u>Channel Deposit:</u> Yellowish brown subangular to subrounded gravel to cobble CONGLOMERATE with fine to coarse sandstone matrix, poorly sorted, very dense, dry, slightly friable.			
Total Depth - 6' No groundwater No caving				
Graphic Log				
scale 1" = 5'	GEOLABS-WESTLAKE VILLAGE	W.O. 8838	PLATE	TP212

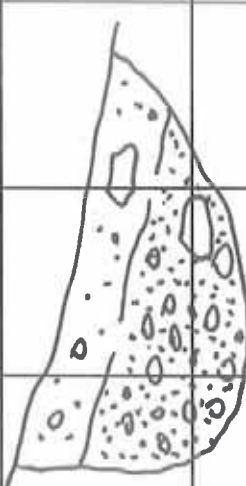
LOG OF EXCAVATION		Logged By: DS	Date Excavated: 6/28/07	Client: Pardee Homes
Trench No. TP213				
Depth (ft)	Description	Comments		
0 - 2	<u>Colluvium</u> : Grayish brown clayey gravelly SAND with abundant subrounded cobbles up to 12" diameter, porous, rootlets to 2', dry and loose in upper 18", clasts are predominantly granitic, subrounded and 4" to 8" in diameter, dry and medium dense.			
2 - 5	<u>Saugus Formation</u> : Mottled yellowish brown cobble CONGLOMERATE, matrix supported, poorly cemented and slightly friable, clasts consist of subrounded granitic and lesser volcanic lithologies, 2" to 16" diameter, predominantly 2" to 6" diameter, matrix consists of poorly sorted silty sand, massively bedded, dry and dense.			
	Total Depth - 5' No groundwater No caving			
Graphic Log				
scale 1" = 5'	GEOLABS-WESTLAKE VILLAGE	W.O. 8838	PLATE	TP213

LOG OF EXCAVATION		Logged By: DS	Date Excavated: 6/28/07	Client: Pardee Homes
Trench No. TP214				
Depth (ft)	Description	Comments		
0 - 2.5	<u>Colluvium</u> : Light grayish brown clayey gravelly SAND to sandy CLAY with scattered subrounded cobbles up to 18" diameter, predominantly 4" to 8" diameter, slightly porous, rootlets to 12", dry and medium dense, friable, desiccation cracks in clayey zones, minor sloughing of sidewalls from 0-2'.	@3' Approx. BN19W/14SW BN9E/20NW		
2.5 - 3	<u>Saugus Formation</u> : Yellowish tan gravelly SANDSTONE, poorly cemented, slightly friable, dry and dense.			
3 - 5	Yellowish tan fine to medium grained SANDSTONE, poorly cemented, friable, upper contact with overlying unit is slightly undulatory, cobble of weathered anorthosite at 4.5', damp and dense.			
Total Depth - 5' No groundwater Minor sloughing of sidewalls from 0-2'				
Graphic Log				
scale 1" = 5'	GEOLABS-WESTLAKE VILLAGE	W.O.	8838	PLATE TP214

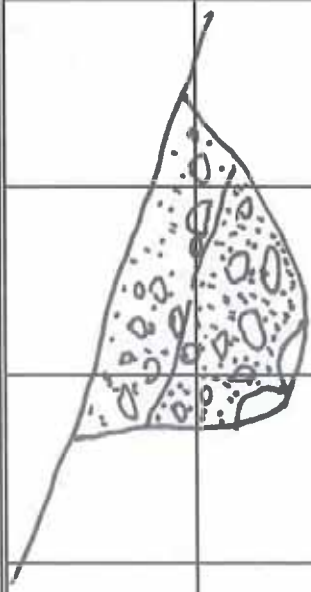
LOG OF EXCAVATION		Logged By: DS	Date Excavated: 6/28/07	Client: Pardee Homes
Trench No. TP215				
Depth (ft)	Description	Comments		
0 - 2	<u>Colluvium</u> : Brown cobbly SAND with clay and scattered subrounded boulders up to 24" diameter, predominantly granitic lithologies, dry and medium dense.			
2 - 4	<u>Saugus Formation</u> : Yellowish tan gravel CONGLOMERATE with scattered subrounded granitic cobbles up to 18" diameter, matrix supported, matrix consists of poorly sorted sand, moderately cemented, refusal at 4' due to cementation and boulder, massively bedded, dry and very dense.			
	Total Depth - 4' No groundwater Minor sloughing of sidewalls from 0-2'			
Graphic Log				
scale 1" = 5'	GEOLABS-WESTLAKE VILLAGE	W.O. 8838	PLATE	TP215

LOG OF EXCAVATION		Logged By: DS	Date Excavated: 6/28/07	Client: Pardee Homes
Trench No. TP216				
Depth (ft)	Description	Comments		
0 - 2.5	<u>Colluvium</u> : Grayish brown sandy CLAY with gravel and lesser cobbles, clasts typically subrounded granitics, slightly dessicated with dessication cracks, dry and firm in upper 12", damp and very firm from 12"-2.5'.			
2.5 - 5	<u>Saugus Formation</u> : White to light gray sandy CONGLOMERATE, massive bedding, subrounded clasts from 1" to 18" diameter, predominantly granitic and monzonite composition, matrix supported with poorly sorted silty sand, dry and dense, poorly cemented, friable.			
Total Depth - 5' No groundwater No caving				
Graphic Log				
scale 1" = 5'	GEOLABS-WESTLAKE VILLAGE	W.O. 8838	PLATE	TP216

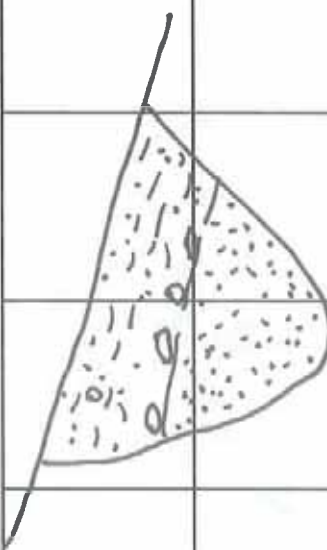
LOG OF EXCAVATION		Logged By: DS	Date Excavated: 6/28/07	Client: Pardee Homes
Trench No. TP217				
Depth (ft)	Description	Comments		
0 - 3	<u>Colluvium</u> : Grayish brown clayey SAND to sandy CLAY with scattered gravel and subrounded cobbles up to 8" diameter, primarily along basal contact, slightly porous, dessication cracks up to 12" deep, 1-2mm wide.			
3 - 5	<u>Saugus Formation</u> : Tan to yellowish tan silty fine to medium grained SANDSTONE, poor to no cementation, friable, poorly bedded, damp and dense.	@4' Fracture N33W/34SW @5' Approx. BN3E/20NW BN2W/20SW		
Total Depth - 5' No groundwater No caving				
Graphic Log				
scale 1" = 5'		GEOLABS-WESTLAKE VILLAGE	W.O. 8838	PLATE TP217

LOG OF EXCAVATION		Logged By: DS	Date Excavated: 6/28/07	Client: Pardee Homes
Trench No. TP218				
Depth (ft)	Description	Comments		
0 - 2.5	<u>Colluvium</u> : Brown sandy CLAY with scattered gravel and subrounded pebbles up to 4" diameter, dry and very firm.			
2.5 - 4	<u>Weathered Saugus Formation</u> : Brown clayey SANDSTONE, abundant white carbonates and root hairs along sinuous, discontinuous fracture, massive texture, dry and dense.			
4 - 6	<u>Saugus Formation</u> : Brown clayey SANDSTONE to sandy MUDSTONE, sparse white carbonates along tight, discontinuous fractures, damp and very stiff.			
Total Depth - 6' No groundwater No caving				
Graphic Log				
scale 1" = 5'	GEOLABS-WESTLAKE VILLAGE	W.O. 8838	PLATE	TP218

LOG OF EXCAVATION		Logged By: DS	Date Excavated: 6/28/07	Client: Pardee Homes
Trench No. TP219				
Depth (ft)	Description	Comments		
0 - 3.5	<u>Colluvium</u> : Brown sandy CLAY with silt and minor gravel, dessication cracks in upper 12", sparse white carbonates, increasingly sandy with depth, grading into clayey SAND at 2.5'.			
3.5 - 6.5	<u>Saugus Formation</u> : Light brown clayey SANDSTONE with sparse gravel, massive texture, poor cementation, damp and dense.			
Total Depth - 6.5' No groundwater No caving				
Graphic Log				
scale 1" = 5'		GEOLABS-WESTLAKE VILLAGE	W.O. 8838	PLATE TP219

LOG OF EXCAVATION
Trench No. 1

Logged By: CW

Date Excavated: 8/8/95

Client: Pardee-Monarch Hills

Depth (ft)	Description	Comments
0 - 3.5	Slope Wash: Medium reddish clayey SAND with granitic and metamorphic cobbles, subrounded to subangular, dry, moderately loose, rootlets to 3', some desiccation cracks.	
3.5 - 8	Saugus Formation: Light orange brown fine to coarse SAND, gravels and cobbles, dry to slightly moist, well-graded sand and gravel stringers, some dark mineral lineations.	

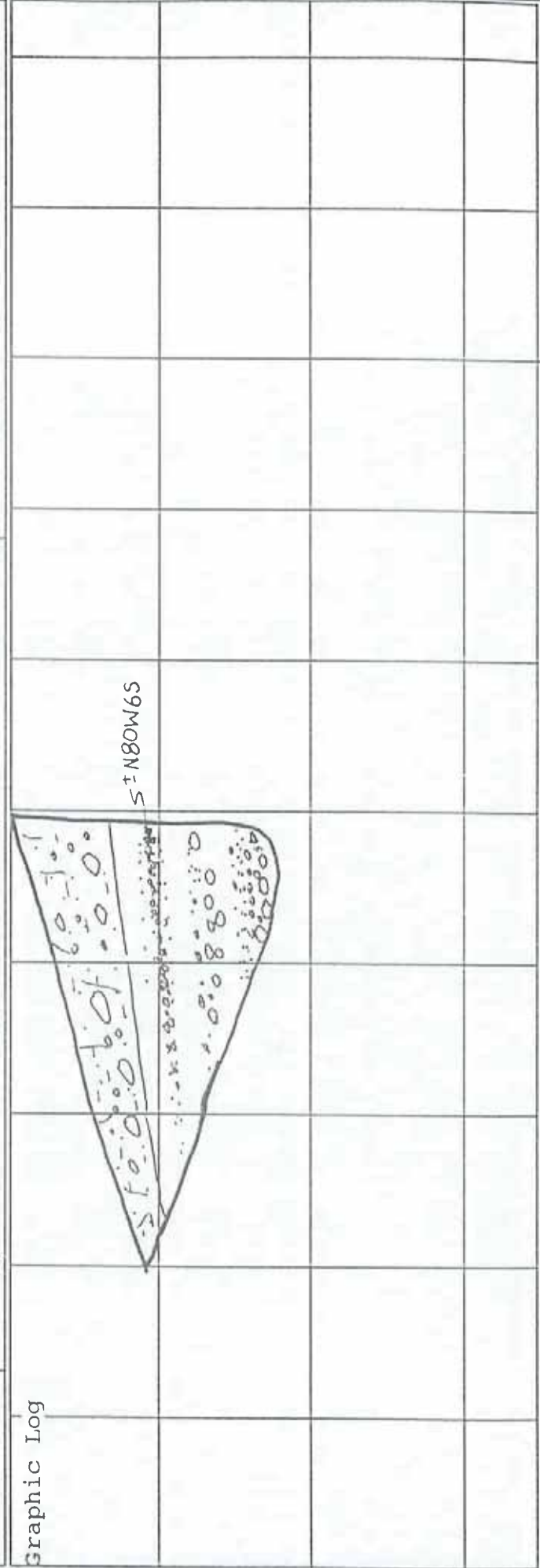

scale 1" = 5'

GEOLABS - WESTLAKE VILLAGE

W.O. 8386

PLATE T1

Depth (ft)	Description	Comments
0 - 18"	Slope Wash: Medium brown sandy CLAY, dry, loose, porous, desiccated rootlets throughout.	
18" - 6'	Saugus Formation: Medium orange brown silty SAND, frequent subrounded coarse sands, small pebbles, carbonate nodules and veins, rootlets, dry, medium firm.	
6 - 8	Light grey to brown fine to coarse SANDS and GRAVELS, dry, dense, well-graded, gravels subrounded to subangular, rootlets.	
8 - 9	Medium orange brown, silty SAND, to sandy SILT, slightly moist, dense, carbonate nodules, occasional subrounded coarse sands and pebble.	

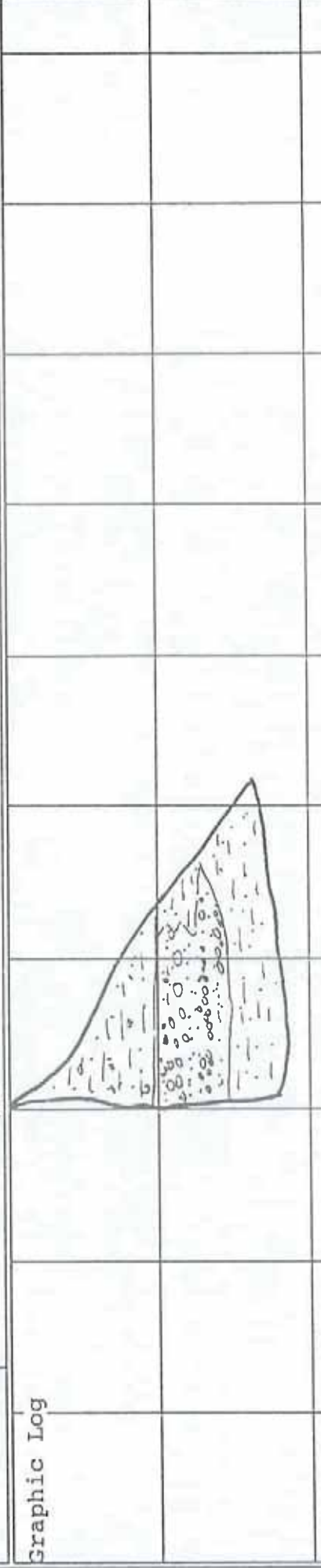

Client: Pardee-Monarch Hills

Date Excavated: 8/8/95

Logged By: CW

LOG OF EXCAVATION
Trench No. 3

Comments

Depth (ft) Description

0 - 18" Slope Wash-Medium brown, clayey SAND, dry, loose, roots, desiccation cracks.

18" - 3' Saugus Formation: Dark reddish brown sandy CLAY matrix and subrounded to subangular cobbles and boulders, slightly moist, dense.

3 - 6 Medium to light brown fine to coarse SAND, gravels and cobbles, well-graded, slightly moist, dense.

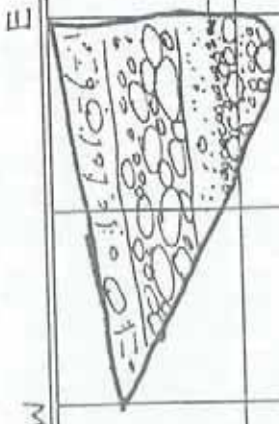

Graphic Log

PLATE T3

W.O. 8386

GEO LABS - WESTLAKE VILLAGE

scale 1" = 5'

LOG OF EXCAVATION
Trench No. 4

Logged By: CW

Date Excavated: 8/8/95

Client: Pardee-Monarch Hills

Comments

Depth (ft) Description

0 - 3 Slope Wash: Dark brown clayey SILT, dry, loose, very porous, cobbles at base of unit, rootlets, desiccation cracks.

3 - 5.5 Saugus Formation: Medium brown fine to coarse SAND, well-bedded, some black mineral lineation, slightly moist, loose.

5.5 - 7 Medium brown to reddish brown silty SAND, fine to coarse gravels and cobbles, moist, dense, subangular cobbles, moderately graded.

W E

Graphic Log

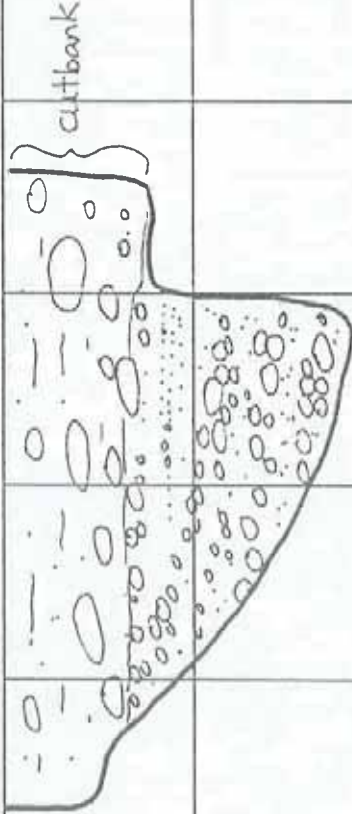

scale 1" = 5'

GEO LABS - WESTLAKE VILLAGE

W.O. 8386

PLATE T4

LOG OF EXCAVATION
Trench No. 5

Logged By: CW

Date Excavated: 8/8/95

Client: Pardee-Monarch Hills

Description

Depth (ft)

0 - 4
Slope Wash: Medium brown silty clayey silty SAND, dry, loose, porous, abundant rootlets to 8", then infrequent, upper 8" very loose, bioturbated, abundant gravels, subangular to angular, few cobbles.

4 - 7
Saugus Formation: Mottled orange/white coarse SAND and cobble CONGLOMERATES, dry, dense, iron staining around cobbles and gravels, subrounded to subangular, moderately cemented.

Comments

S N

Graphic Log

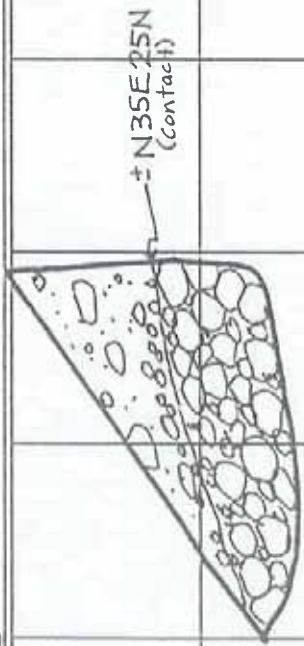

scale 1" = 5'

GEO LABS - WESTLAKE VILLAGE

W.O. 8386

PLATE T5

LOG OF EXCAVATION
Trench No. 6

Logged By: CW

Date Excavated: 8/8/95

Client: Pardee-Monarch Hills

Comments

Description

0 - 18" Slope Wash: Medium brown clayey SAND, medium to coarse grained, dry, moderately loose, rootlets upper 10", desiccation cracks upper 10".

18" - 4' Saugus Formation: Medium gray medium to coarse SAND and GRAVELS, dry, mildly cemented, somewhat well-graded.

4 - 6 Mottled orange/white CONGLOMERATE, dry, dense, poorly graded, cemented, iron staining at contact and around cobbles.

S N

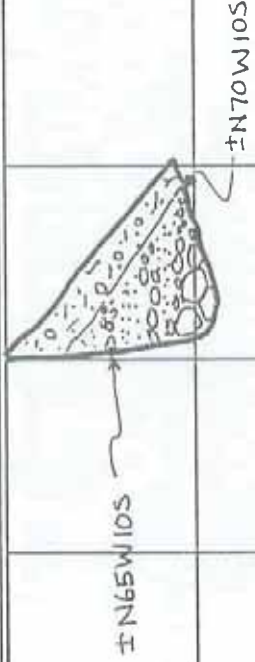

Stratigraphic Log

scale 1" = 5'

GEOLABS - WESTLAKE VILLAGE

W.O. 8386

PLATE T6

LOG OF EXCAVATION
Trench No. 7

Logged By: CW

Date Excavated: 8/8/95

Client: Pardee-Monarch Hills

Depth (ft) Description

0 - 3 Slope Wash: Medium to dark brown sandy clayey SILT, dry, loose, porous, rootlets to 12", cobbles, gravels.

3 - 7 Saugus Formation: Mottled orange/white CONGLOMERATE, dry, dense, cemented, iron staining at contact and around cobbles and gravels.

Comments

Graphic Log

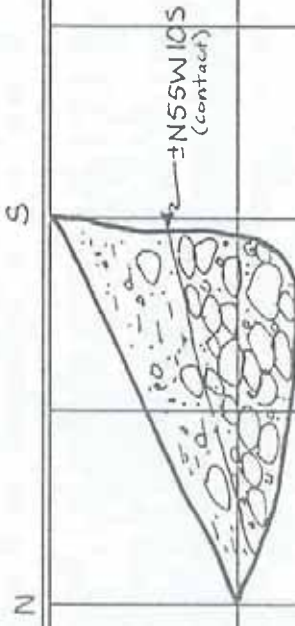

scale 1"= 5'

GEO LABS - WESTLAKE VILLAGE

W.O. 8386

PLATE T7

LOG OF EXCAVATION
Trench No. 8

Logged By: CW

Date Excavated: 8/8/95

Client: Pardee-Monarch Hills

Comments

Description

Depth (ft)

0 - 2 Slope Wash: Dark brown clayey SILT with SAND, some gravels and subrounded cobbles, rootlets to 12", dry, loose, porous.

2 - 7 Saugus Formation: Mottled orange/white CONGLOMERATES, dry, dense, cemented.

N S

Graphic Log

±N65E10N

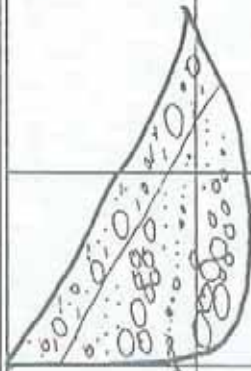

scale 1" = 5'

GEOLABS - WESTLAKE VILLAGE

W.O. 8386

PLATE T8

LOG OF EXCAVATION
Trench No. 9

Logged By: CW

Date Excavated: 8/8/95

Client: Pardee-Monarch Hills

Comments

Depth (ft)

0 - 3 Slope Wash: Dark brown clayey SILT with sand and gravels, occasional cobbles, rootlets to 18", dry to slightly moist, moderately loose, upper 12" porous.

3 - 4.5 Saugus Formation: Dark reddish brown clayey SAND, coarse sands, gravels, some cobbles, dry, loose to medium loose, rootlets, somewhat graded.

4.5 - 7 Mottled orange/white CONGLOMERATE, iron staining on cobbles.

S N

Graphic Log

±170E7N
(contact)

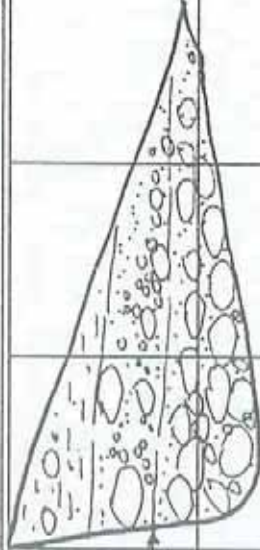

scale 1" = 5'

GEOLABS - WESTLAKE VILLAGE

W.O. 8386

PLATE T9

LOG OF EXCAVATION Trench No. 10	Logged By: CW	Date Excavated: 8/8/95	Client: Pardee-Monarch Hills
Depth (ft)	Description	Comments	
0 - 10"	Slope Wash: Dark brown sandy SILT, dry, loose, porous.		
10" - 5.5	Terrace Deposits: Reddish brown clayey SAND, gravels and cobbles, dry, dense to very tight.		
5.5 - 7	Saugus Formation: Medium to orange brown clayey SAND, some coarse sands, slightly moist, dense.		
Graphic Log			
scale 1"= 5'	GEOLABS - WESTLAKE VILLAGE	W.O. 8386	PLATE T10

LOG OF EXCAVATION
Trench No. 11

Logged By: CW

Date Excavated: 8/8/95

Client: Pardee-Monarch Hills

Comments

Depth (ft)	Description
0 - 12"	Slope Wash: Dark brown clayey SILT with some sand, dry, medium loose, porous, some gravels and cobbles, rootlets to 12".
12" - 4'	Saugus Formation: Reddish brown clayey SAND, CONGLOMERATE, gravels and cobbles, subangular to subrounded, slightly moist, dense.
4 - 6.5	Reddish brown sand with gravels and cobbles, dry, moderately loose.
6.5 - 8.5	Light brown to light gray brown SAND and coarse gravels, dry, dense, roots in coarse gravel bed, well-graded.

S N

Graphic Log

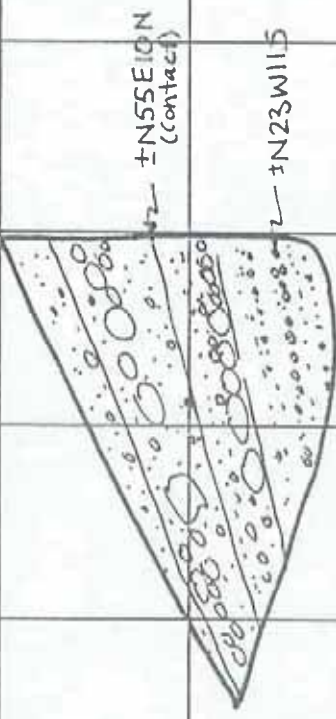

scale 1" = 5'

GEOLABS - WESTLAKE VILLAGE W.O. 8386

PLATE T11

LOG OF EXCAVATION
Trench No. 12

Logged By: CW

Date Excavated: 8/9/95

Client: Pardee-Monarch Hills

Depth (ft)

Description

Comments

0 - 5

Slope Wash: Dark brown slightly clayey sandy SILT, angular to subangular gravels and occasional cobble, dry, moderately loose, porous, rootlets to 2'.

5 - 7.5

Saugus Formation: Light reddish brown slightly clayey SAND CONGLOMERATE, dry, moderately dense, slightly porous, some rootlets.

N S

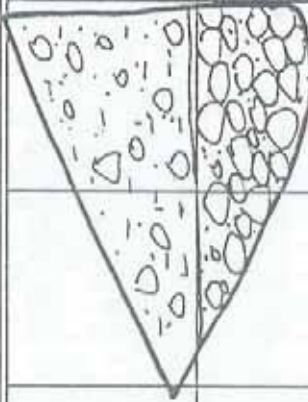

Graphic Log

scale 1" = 5'

GEOLABS - WESTLAKE VILLAGE

W.O. 8386

PLATE T12

LOG OF EXCAVATION
Trench No. 13

Logged By: CW

Date Excavated: 8/9/95

Client: Pardee-Monarch Hills

Depth (ft)

Description

Comments

0 - 2"

Slope Wash: Dark brown clayey SILT.

2" - 6'

Terrace Deposits: Reddish brown clayey SAND, gravels and cobbles, slightly moist, dense.

E . W

Graphic Log

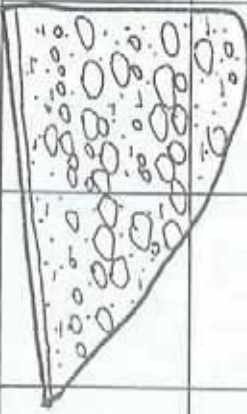

scale 1" = 5'

GEOLABS - WESTLAKE VILLAGE

W.O. 8386

PLATE T13

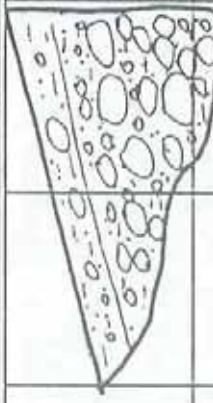
LOG OF EXCAVATION Trench No. 14	Logged By: CW	Date Excavated: 8/9/95	Client: Pardee-Monarch Hills
Depth (ft)	Description	Comments	
0 - 10"	Slope Wash: Dark brown clayey SILT, dry, moderately loose to loose, porous, rootlets throughout, some subrounded gravels, occasional cobbles.		
10" - 6'	Saugus Formation: Reddish clayey SAND CONGLOMERATE, subrounded to subangular, slightly moist, very dense, no bedding, poorly graded.		
SW NE			
			
Graphic Log			
scale 1"= 5'		W.O. 8386	PLATE T14

LOG OF EXCAVATION
Trench No. 15

Logged By: CW

Date Excavated: 8/9/95

Client: Pardee-Monarch Hills

Depth (ft)	Description	Comments
0 - 1	Slope Wash: Dark brown clayey SILT, gravels, some cobbles, porous, rootlets, dry, loose, desiccation cracks.	
1 - 2	Reddish clayey SAND, gravels, some rootlets, slightly moist, moderately dense, desiccation cracks.	
2 - 6	Saugus Formation: Light yellow brown CONGLOMERATE within slightly clayey silty SAND, dry, dense.	
<p>Graphic Log</p> <div style="display: flex; justify-content: center; align-items: center; gap: 10px;"> W  E </div>		

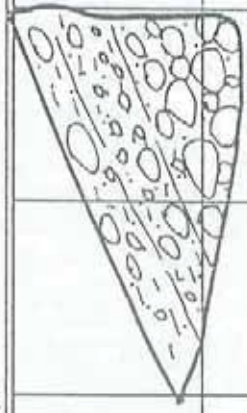

A-543

scale 1" = 5'

GEOLABS - WESTLAKE VILLAGE

W.O. 8386

PLATE T15

LOG OF EXCAVATION Trench No. 16 Logged By: CW Date Excavated: 8/9/95 Client: Pardee-Monarch Hills

Depth (ft)	Description	Comments
0 - 18"	Slope Wash: Dark brown clayey SAND, dry, moderately dense, some gravels and cobbles, rootlets.	
18" - 7'	Saugus Formation: Light brown to light orange brown silty SAND CONGLOMERATE, slightly moist, very dense, no bedding, contact weathered.	

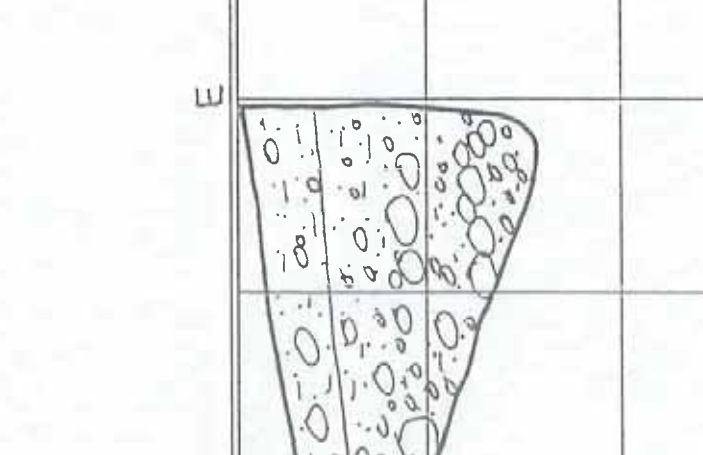

Graphic Log

scale 1" = 5'

GEOLABS - WESTLAKE VILLAGE W.O. 8386 PLATE T16

LOG OF EXCAVATION
Trench No. 17

Logged By: CW

Date Excavated: 8/9/95

Client: Pardee-Monarch Hills

Depth (ft)	Description	Comments
0 - 2	Slope Wash: Dark brown clayey SAND, some gravels, slightly moist, moderately dense, roots upper 8", desiccation cracks to depth of unit.	
2 - 6	Saugus Formation: Light yellow to light orange CONGLOMERATE, clayey sand matrix, slightly moist, dense, upper 12" of unit weathered, some iron staining at upper contact.	

Graphic Log

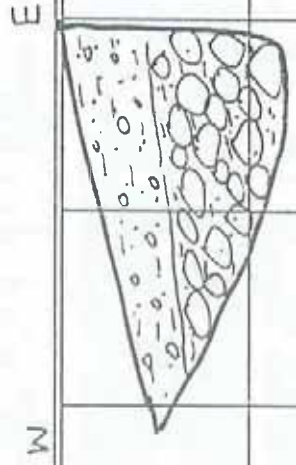

--	--	--	--	--	--	--	--	--	--	--	--	--	--	--

scale 1"= 5'

GEO LABS - WESTLAKE VILLAGE

W.O. 8386

PLATE T17

LOG OF EXCAVATION
Trench No. 19

Logged By: CW

Date Excavated: 8/10/95

Client: Pardee-Monarch Hills

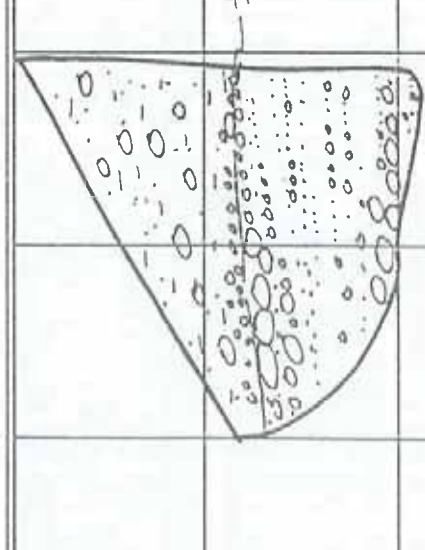
Depth (ft)	Description	Comments
0 - 6	Terrace Deposit: Reddish brown clayey SAND with gravels, dry to slightly moist, moderately loose to moderately dense, upper 18" desiccated, occasional roots.	
6 - 11	Saugus Formation: Reddish brown silty SAND and subangular gravels, moist, moderately dense, some well-graded layers. White calcareous concretions at upper contact area.	
<p>Graphic Log</p> 		

LOG OF EXCAVATION
Trench No. 20

Logged By: CW

Date Excavated: 8/10/95

Client: Pardee-Monarch Hills

Depth (ft)

Description

Comments

0 - 4

Terrace Deposit: Reddish brown clayey SAND and subangular gravels, moist, moderately dense, upper 12" very weathered, desiccation cracks, dry, rootlets.

4 - 5.5

Medium brown to medium reddish brown clayey silty SAND, abundant coarse sands, some subangular gravels, slightly moist, dense, moderately cemented.

5.5 - 9

Saugus Formation: Reddish brown slightly silty SAND and gravels, coarse grained sands, moderately well-graded, moist, dense.

Graphic Log

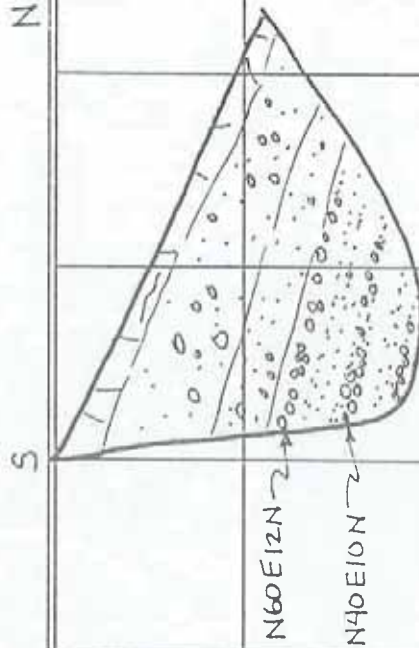

scale 1" = 5'

GEOLABS - WESTLAKE VILLAGE

W.O. 8386

PLATE T20

LOG OF EXCAVATION
Trench No. 21

Logged By: CW

Date Excavated: 8/10/95

Client: Pardee-Monarch Hills

Depth (ft)

0 - 18"

18" - 3'

3.5 - 5

5 - 7

7 - 8

Description

Slope Wash: Dark brown clayey SILT and sands, dry, moderately loose, porous, rootlets, desiccation cracks, occasional cobbles.

Reddish brown clayey SAND, coarse sands, slightly moist, moderately loose, some desiccation cracks. Mottled red/white, silty CLAY, carbonate veins throughout, moist, subangular gravel lenses, moderately loose.

Saugus Formation: Light orange sand and gravels, moderately graded, moist, moderately dense. Light brown fine SAND CONGLOMERATE, moist, dense subangular to subrounded cobbles, iron staining on cobbles.

Comments

N S

Graphic Log

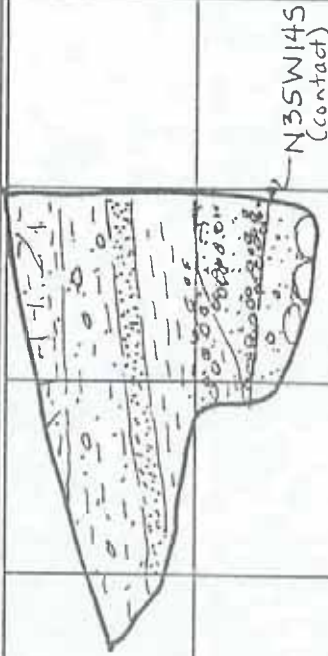

scale 1" = 5'

GEOLABS - WESTLAKE VILLAGE

W.O. 8386

PLATE T21

LOG OF EXCAVATION
Trench No. 22

Logged By: CW

Date Excavated: 8/10/95

Client: Pardee-Monarch Hills

Depth (ft)	Description	Comments
0 - 18"	Slope Wash: Dark brown slightly clayey SILT with sand, dry, loose, desiccation cracks, porous, occasional cobbles at lower contact.	
18" - 4'	Saugus Formation: Mottled red and white sandy SILT, some desiccation cracks to 2.5', carbonate veins throughout, abundant coarse sands and occasional gravels, slightly moist, dense.	
4 - 7.5	Reddish clayey SAND, slightly moist, dense, abundant subangular gravels and coarse sands, occasional cobbles.	

Graphic Log

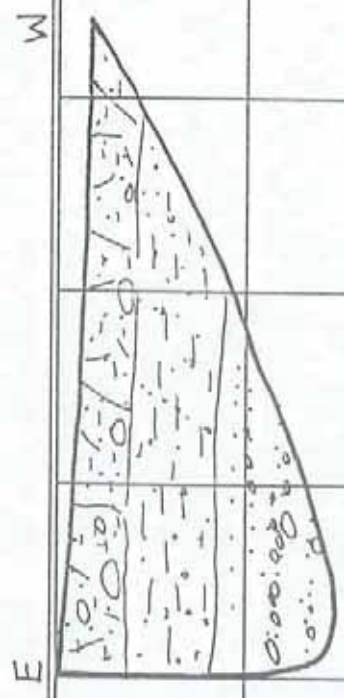

scale 1" = 5'

GEOLABS - WESTLAKE VILLAGE

W.O. 8386

PLATE T22

LOG OF EXCAVATION
Trench No. 23

Logged By: CW

Date Excavated: 8/10/95

Client: Pardee-Monarch Hills

Depth (ft) Description

0 - 3" Slope Wash: Dark brown clayey SILT and some gravels, dry, loose.

3" - 2' Saugus Formation: Light brown sandy SILT, some gravels, dry, loose, porous, rootlets, weathered.

2 - 7 Light brown sands and gravels, some silt beds.

Comments

Graphic Log

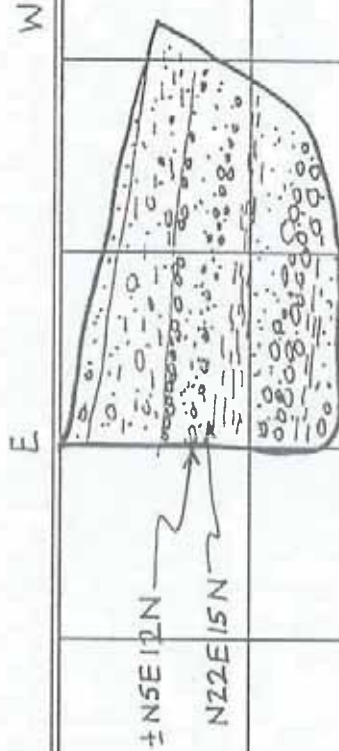

scale 1"= 5'

GEOIABS - WESTLAKE VILLAGE

W.O. 8386

PLATE T23

APPENDIX C

Laboratory Testing Results by Geolabs-Westlake Village

DRAFT

APPENDIX C

LABORATORY TEST RESULTS

Atterberg Limits ResultsPlate AL.1
Consolidation DiagramPlates C (boring).(depth)
Corrosivity Results.....HDR Engineering/Schiff
Laboratory Test DataTable
Particle Size DiagramsPlate PS.1-PS.3
Shear Test DiagramsPlates S(boring).(depth)

Grading Plan Review
Phase 3 of Tract No. 60922, Skyline Ranch,
Santa Clarita Area, County of Los Angeles, California

W.O. 8838
August 27, 2013

LABORATORY TESTING

Undisturbed and bulk samples of soil and rock materials encountered at the site were collected during the course of our field work. Selected laboratory tests completed on the retrieved samples are described below:

Moisture-Density

The field moisture content and dry unit weight were determined for each undisturbed sample. Dry unit weight is expressed in pounds per cubic foot and the moisture content represents a percentage of the dry unit weight. This test data is presented on the boring logs.

Shear Test

Shear tests were performed in a Direct Shear Machine of the strain control type commensurate with ASTM D 3080. The rate of deformation is approximately 0.01 inches per minute. Selected samples, as noted in the shear test diagram, were sheared at reduced rates of deformation. Shearing occurred under a variety of confining loads in order to determine the Coulomb shear strength parameters. The test was performed on undisturbed and remolded (@ 90% relative compaction) samples in an artificially saturated condition.

Stress-strain curves are presented in the page following the shear test diagram. It should be noted that for the case of undisturbed single-cycle shear tests the value at the end of the stress-strain curve were selected (residual value per LACDPW Manual for Preparation of Geotechnical Reports). The shear test diagrams have the descriptor of “Ultimate” to distinguish such single-cycle tests from multi-cycle shear tests.

Consolidation Test

Settlement predictions of the soil's behavior under load are made on the basis of consolidation tests (ASTM D 2435). A one inch high sample is loaded in a geometric progression and the resulting deformation is recorded at selected time intervals. Porous stones are placed in contact with the sample (top and bottom) to permit addition and release of pore fluid. The sample is inundated at a selected load (typically near overburden pressure) during the progression. Results are plotted on the enclosed Consolidation-Pressure Curves.

Compaction and Expansion Tests

To determine the compaction characteristics of the onsite materials, compaction tests are performed in accordance with ASTM D 1557. The maximum dry density is reported in pounds per cubic foot and the optimum moisture content as a percentage of the maximum dry density. Expansion index tests were performed in accordance with the criteria in U.B.C. 18-2. The results of these tests are included in Laboratory Test Data Table.

Table I - Laboratory Test Data

<u>Sample</u>	<u>Description</u>	Maximum Dry Density <u>PCF</u>	Optimum Moisture Content <u>%</u>	Expansion <u>Index</u>
B2@11-15'	Tan silty SAND (Saugus Fm.)	134	8	6
B3@5'	Tan clayey silty SAND (Saugus Fm.)	127	9	0
B3@38'	Lt. gray silty SAND w/ grave. (Mint Cyn.Fm.)	132	10	0
B9@15'	Lt. brown sandy SILT	124	11	19
B10@20'	Tan clayey med-cs SAND w/ gravel	137	7	4
B16@60'	Dark red sandy CLAY (TQs)			56
B19@15'	Tan silty f-cs SAND w/ gravel	128	10	10
B29@63'	Tan silty med.-coarse SAND (Saugus Fm.)	130	9	
B39@0-5'	Dark brown silty clayey SAND w/ gravel	133	10	2
B50 @ 30'	Lt. gray silty SAND	130	10	
B50 @ 67'	Lt. gray clayey silty SAND	126	12	
B58 @ 80'	Tan fine-med. Grained SAND	131	9	
B59 @ 25'	Tan silty SAND w/ gravel	129	9	
B60 @ 28'	Light brown clayey SAND	126	12	
B62 @ 5'	Light reddish brn. Clayey silty SAND			
B77@15'	Tan silty SAND w/ gravel	128	10	

B77@52'	Reddish brown sandy SILT	123	12
T3@1.5'	Brown clayey silty f-med. SAND	126	9.5
TP168@3.5-5.5'	Brown sandy CLAY	115	14
B1(1995)@15'	Gray silty SAND w/ gravel	133	7
B1(1995)@35'	Lt gray silty med-cs SAND	131	9
B1(1995)@72'	Lt. gray clayey silty SAND	125	10
B11(1995)@40'	Lt. gray clayey SAND	130	10

Atterberg Limits and Particle Size Analyses

Selected fine-grained samples were subject to particle-size analyses (ASTM D 422), hydrometer analyses, and Atterberg Limit testing (ASTM D 4318). The results of this testing is presented in the following table. Particle size analyses are presented on Plate PS.1-PS.3 of.

Sample	Liquid Limit	Plastic Limit	Plasticity Index	% Clay (finer than 0.005 mm)
B5@12' (TQs)	36.9%	18.9%	18	19%
B5@72' (Tmc)	40%	20.7%	20	9%
B13@27' (Tmc)	38.4%	17.4%	21	25%
B16@60' (TQs)	42.7%	15.9%	27	---
B16@63' (TQs)	57.5%	18.2%	40	---
B16@80' (TQs)	91.9%	32.2%	60	90%
B21@49' (TQs)	57.9%	18.2%	40	50%
B23@70' (TQs)	84.3%	27.3%	57	86%
B25@53' (TQs)	46.7%	19.2%	28	12%
B40@55' (Tmc)	36.3%	18.3%	18	54.2%
B48@97' (TQs)	63.9%	19.6%	45	---
B48@120' (TQs)	71%	21.3%	50	---
B54@56.5' (TQs)	65.7%	17.9%	48	---

Sand Equivalent

Selected samples were submitted for Sand Equivalent testing in accordance with California Test Method 217. The results of this testing is presented in the following table:

Sample	Material	Sand Equivalent
B77@15'	TQs-silty sand w/clay	17
B77@52'	TQs-silty sand	23

Qal #1 (from terminus of Canyon Crest Drive)	Alluvium-clean sand	85
Qal #2 (from terminus of Canyon Crest Drive)	Alluvium-sand	64
Tmc #1 (from terminus of Canyon Crest Drive)	Mint Canyon Fm. – Silty Sandstone	30

Durability, Specific Gravity, and Absorption Testing

Samples of the oversize rock present within the alluvium, Saugus Formation, and Mint Canyon Formation were collected and crushed into 1” diameter or less fragments for determination of their quality for various on-site construction material uses. The majority of these oversize rocks consisted of subrounded cobbles and boulders of granite, granodiorite, syenite, gabbro, and gneiss. The crushed material was submitted to BTC Laboratories for testing, the result of which is presented in the following table.

Sample	Durability Index California Test Method No. 229	Percentage Wear ASTM C 131		Apparent Specific Gravity ASTM C127	Absorption California Test Method No. 206
		100 Rev.	500 Rev.		
Alluvium Oversize Rock	65	9.5	37	2.67	0.6%
Saugus Fm. Oversize Rock	70	14.1	50.5	2.65	1.1%
Mint Cyn Fm. Oversize Rock	75	11.9	44.7	2.64	0.9%
2006 Greenbook Criteria for Rip Rap	52 Minimum	--	45 Maximum	2.5 Minimum	4.20 Maximum
2006 Greenbook Criteria for Crushed Aggregate Base	--	15 Maximum	52 Maximum	--	--

Based on these test results, the oversize rock from the alluvium and Mint Canyon Formation would pass the 2006 Standard Specification for Public Works Construction (Greenbook) criteria for Durability, Percentage Wear, Apparent Specific Gravity, and Absorption for use as rip rap. The durability results indicate that the rock from all three

geologic units is of adequate quality for use in crushed aggregate base. Of course, gradation, R-value, and Sand Equivalent criteria would be need to be met on materials crushed and screened for use as crushed aggregate base.

Crushed rock could be also utilized as subdrain/backdrain rock or simply entrained in engineered fills as a means of disposing of excess of oversize rock towards the end of rough grading.

CHEMICAL TESTING

Selected samples were submitted to M.J. Schiff and Associates for chemical testing to evaluate their corrosion potential. Results presented in Appendix G are summarized herein.

Sulfates

Preliminary testing of samples obtained from our borings indicate the on-site soils have low levels (< 0.10 % by weight) of sulfates which indicates a low corrosion potential for concrete. Near the completion of grading additional testing should be performed to verify the corrosion potential of the soils.

Sample	Sulfate % by weight
B2@10-15'	None Detected
B9@15'	0.061
B39@0-3'	0.037

Table 19-A-4 is reproduced for your reference with respect to concrete requirements for soils bearing soluble sulfates above 0.1% by weight.

TABLE 4.3.1 - REQUIREMENTS FOR CONCRETE EXPOSED TO SULFATE-CONTAINING SOLUTIONS (ACI 318-05)

SULFATE EXPOSURE	WATER-SOLUBLE SULFATE (SO ₄) IN SOIL, % by weight	SULFATE (SO ₄) IN WATER, ppm	CEMENT TYPE	Maximum Water-Cementitious Materials Ratio, by Weight, Normal-Weight Aggregate Concrete ¹	Minimum f _c Normal Weight and Lightweight Aggregate Concrete, psi ¹
------------------	---	--	-------------	--	---

Negligible	0.00 - 0.10	0 - 150	--	--	--
Moderate ²	0.10 - 0.20	150 - 1,500	II, IP(MS), IS(MS), P(MS), I(PM)(MS), I(SM)(MS)	0.50	4,000
Severe	0.20 - 2.00	1,500 - 10,000	V	0.45	4,500
Very severe	Over 2.00	Over 10,000	V plus pozzolan ³	0.45	4,500

¹ When both Table 4.3.2 and Table 4.2.2 are considered, the lowest applicable maximum water-cementitious material ratio and highest applicable minimum f'_c shall be used.

² Seawater

³ Pozzolan that has been determined by test or service record to improve sulfate resistance when used in concrete containing Type V cement.

Chlorides

Test results indicate that chloride levels (40 to 210 ppm) are below levels of concern with respect to corrosion.

pH levels

Test results presented in Appendix G indicate the on-site soils are typically neutral to slightly basic (pH 7-8).

Soil Resistivity

Representative samples of the earth materials encountered at the site were tested for resistivity. Resistivity of soils is inversely proportional to corrosiveness. Thus, the analysis helps in determining whether the soils may have a deleterious affect on underground metallic structures. A generally accepted correlation between resistivity and soil corrosiveness toward metals is provided below:

Resistivity (Ohm-Centimeter)	Corrosiveness
< 1,000	Severely Corrosive
1,000 - 2,000	Corrosive
2,000 - 10,000	Increasingly Moderate
> 10,000	Increasingly Mild

Laboratory Test Results

<u>Sample</u>	As-Received Resistivity <u>ohm-cm</u>	Saturated Resistivity <u>ohm-cm</u>
B2@10-15'	930,000	1,700
B9@15'	7,400	690
B39@0-3'	6,300	3,500

Based on these test results, the on-site soils are considered moderately corrosive to severely corrosive to ferrous metals when saturated. Appropriate mitigation measures should be obtained from an experienced corrosion engineer.

Atterberg Limits Test Results

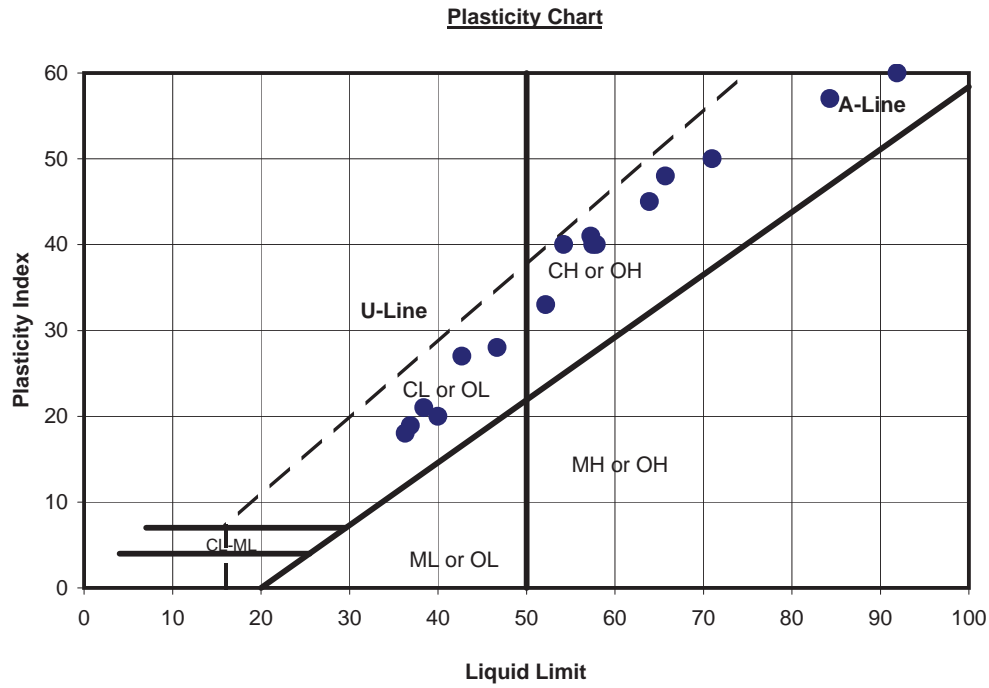

Location	Depth (ft)	LL	PI	Classification
B5 (TQs)	12	36.9	18.9	CL
B5 (Tmc)	72	40	20	CL
B13 (Tmc)	27	38.4	21	CL
B16 (TQs)	60	42.7	27	CL
B16 (TQs)	63	57.5	40	CH
B16 (TQs)	80	91.9	60	CH
B17 (TQs)	81.5	57.3	41	CH
B17 (TQs)	95	54.2	40	CH
B17 (TQs)	98	52.2	33	CH
B21 (TQs)	49	57.9	40	CH
B23 (TQs)	70	84.3	57	CH
B25 (TQs)	53	46.7	28	CL
B40 (Tmc)	55	36.3	18	CL
B48 (TQs)	97	63.9	45	CH
B48 (TQs)	120	71	50	CH
B54 (TQs)	56.5	65.7	48	CH

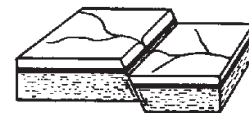

CONSOLIDATION - PRESSURE CURVE

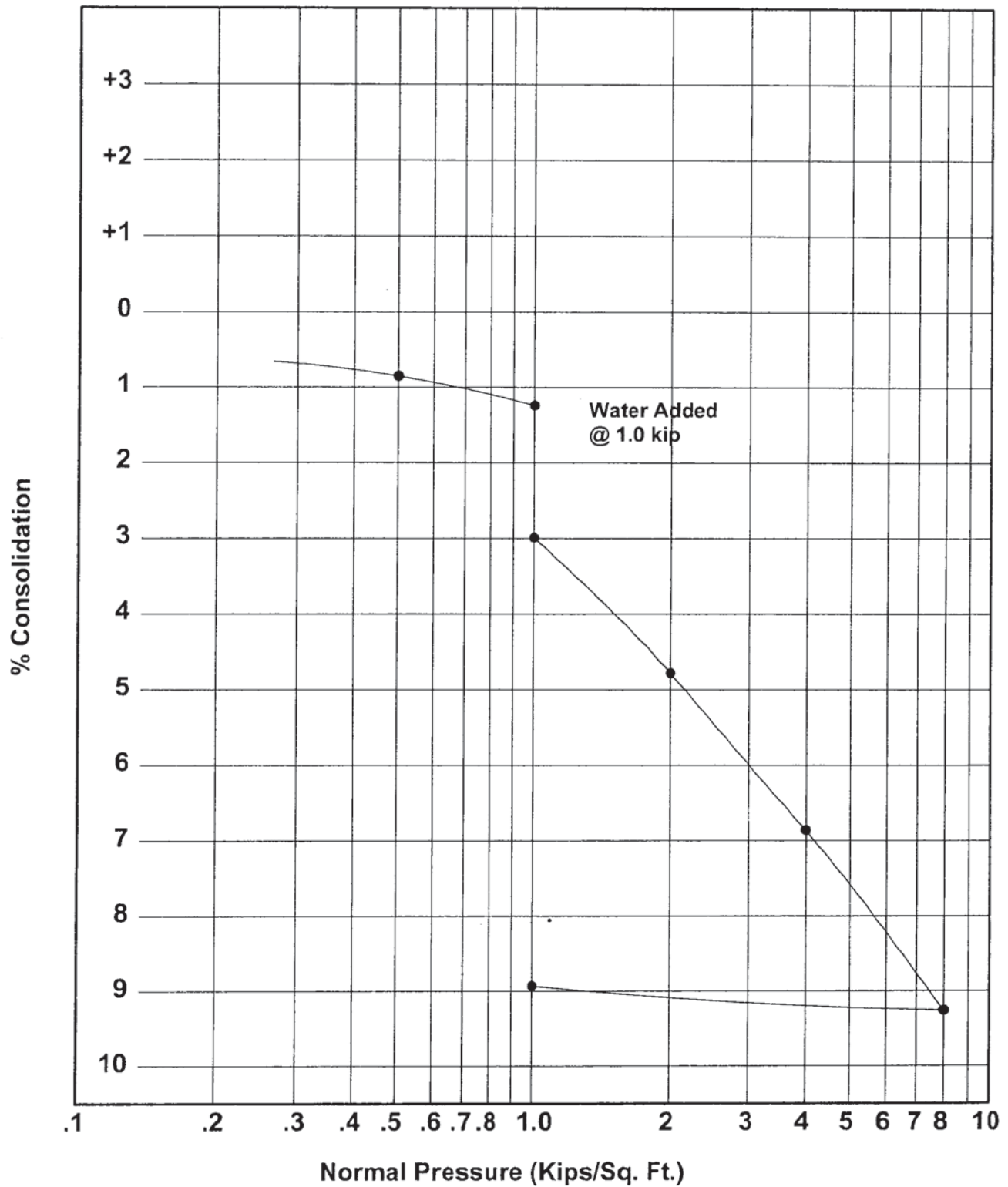

Project Skyline Ranch
 Location B2(1995)
 Depth 10 Feet
 Material Alluvium



Geolabs - Westlake Village

GEOLOGY AND SOIL ENGINEERING

DATE _____ BY DS
 SCALE _____ W.O. 8838

CONSOLIDATION - PRESSURE CURVE

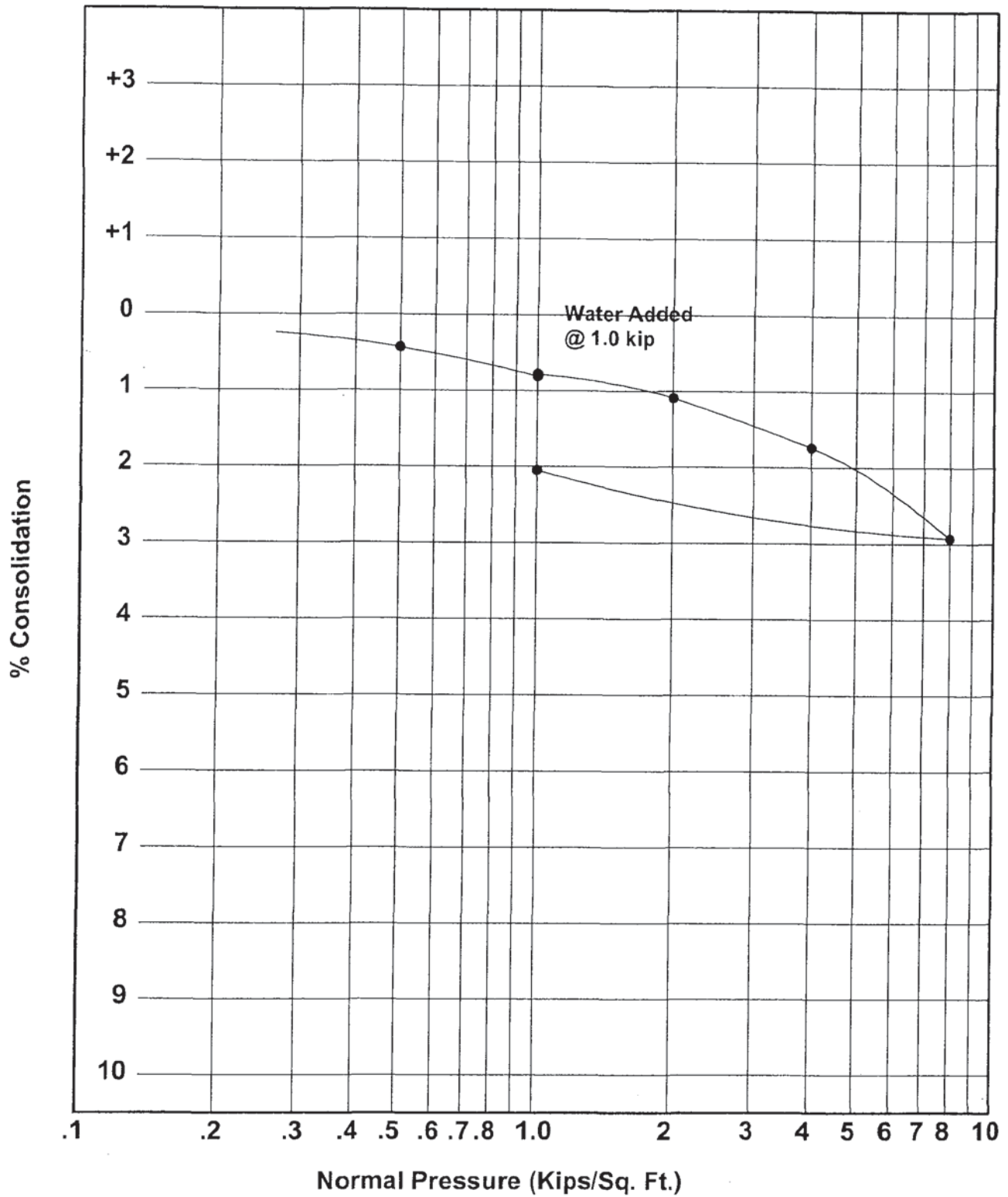

Project Skyline Ranch
 Location B2(1995)
 Depth 20 Feet
 Material Mint Canyon Formation



Geolabs - Westlake Village

GEOLOGY AND SOIL ENGINEERING

DATE _____ BY DS
 SCALE _____ W. O. 8838

CONSOLIDATION - PRESSURE CURVE

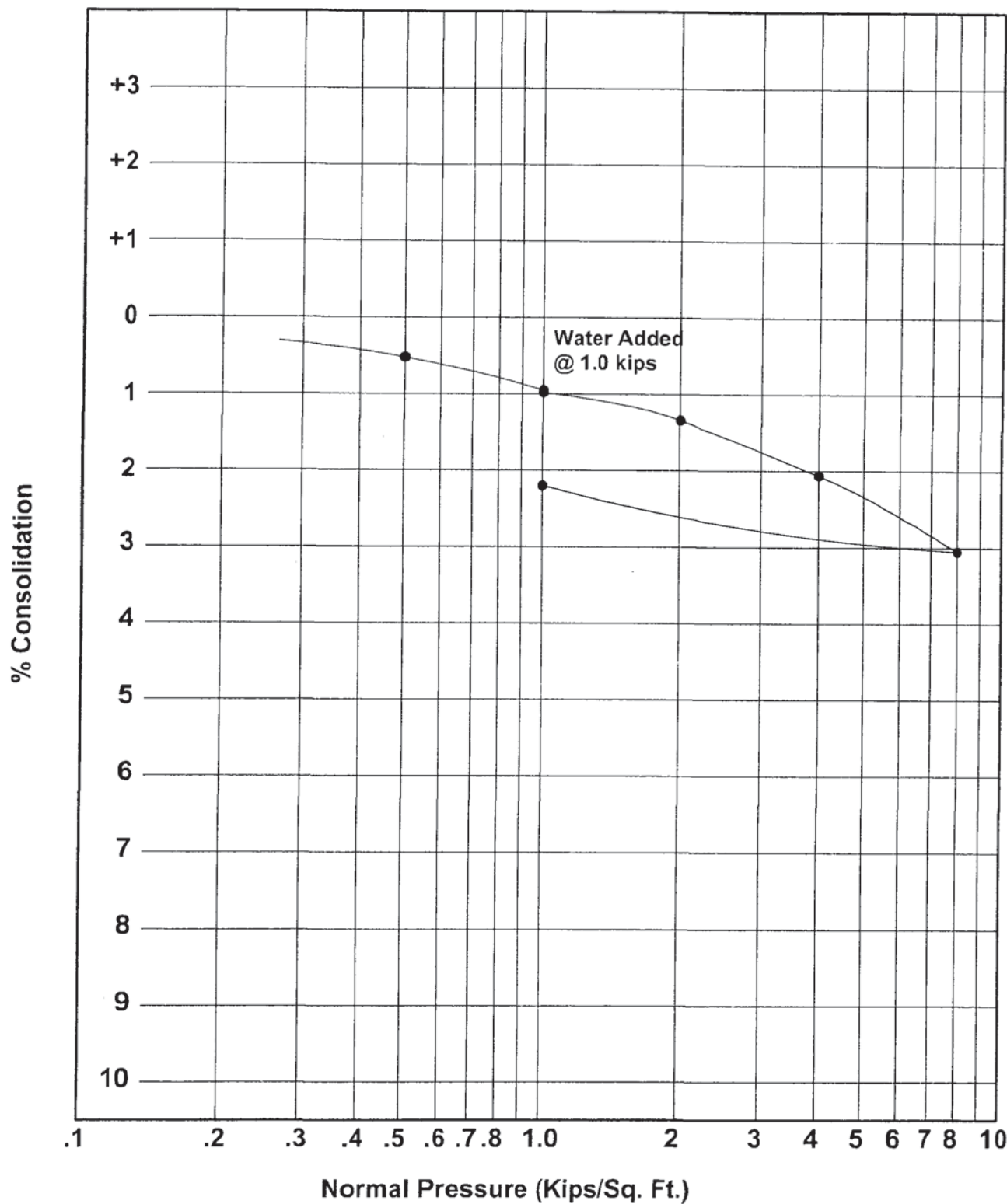

Project Skyline Ranch
 Location B2(1995)
 Depth 30 Feet
 Material Mint Canyon Fm.



Geolabs - Westlake Village

GEOLOGY AND SOIL ENGINEERING

DATE _____ BY DS
 SCALE _____ w.o. 8838

CONSOLIDATION - PRESSURE CURVE

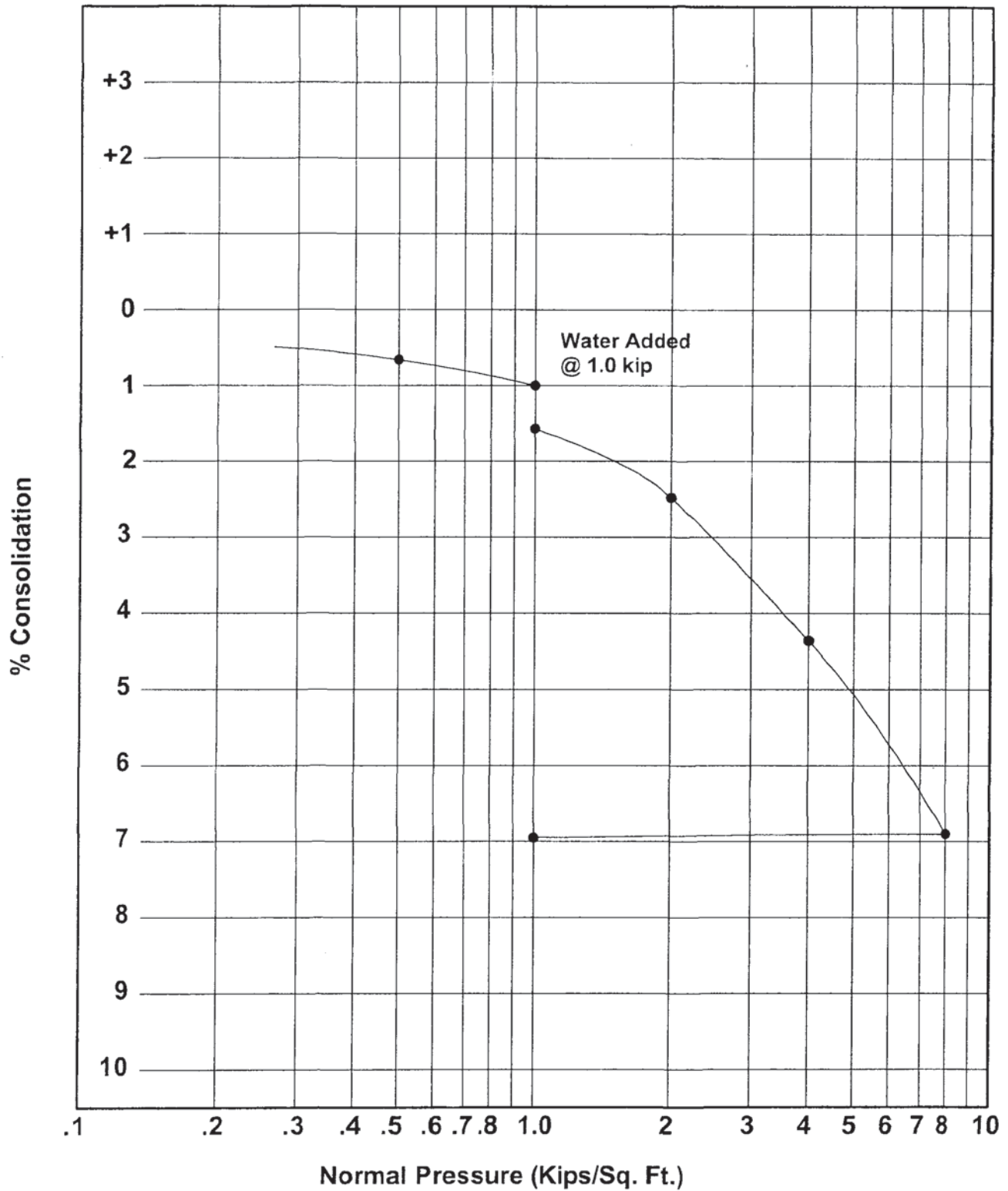

Project Skyline Ranch
 Location B3(1995)
 Depth 14 Feet
 Material Colluvium



Geolabs - Westlake Village

GEOLOGY AND SOIL ENGINEERING

DATE _____ BY DS
 SCALE _____ W.O. 8838

CONSOLIDATION - PRESSURE CURVE

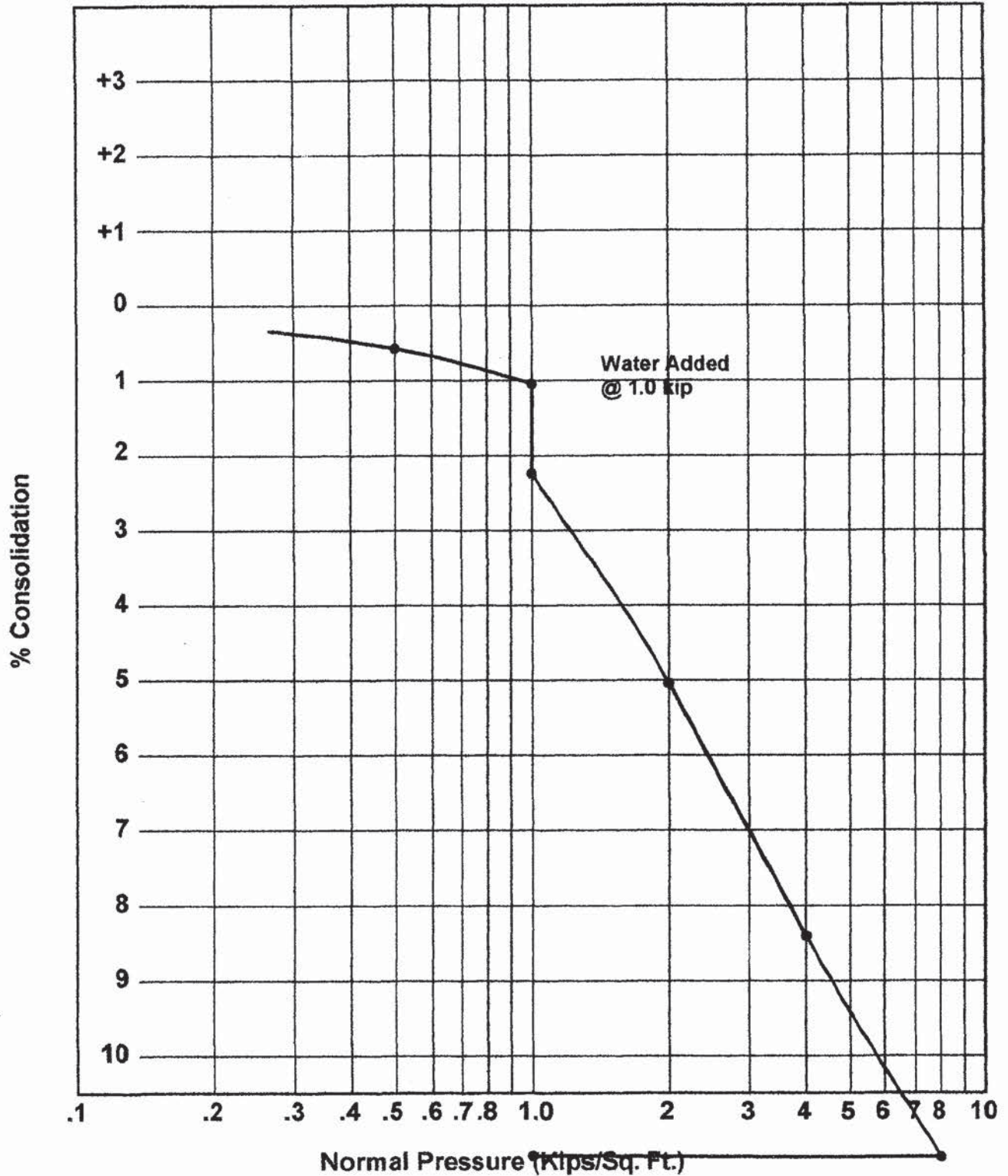

Project Skyline Ranch
 Location B3(1995)
 Depth 25 Feet
 Material Alluvium



Geolabs - Westlake Village
 GEOLOGY AND SOIL ENGINEERING

DATE _____ BY IDS
 SCALE _____ W.O. 8833

PLATE C3(1995).25

CONSOLIDATION - PRESSURE CURVE

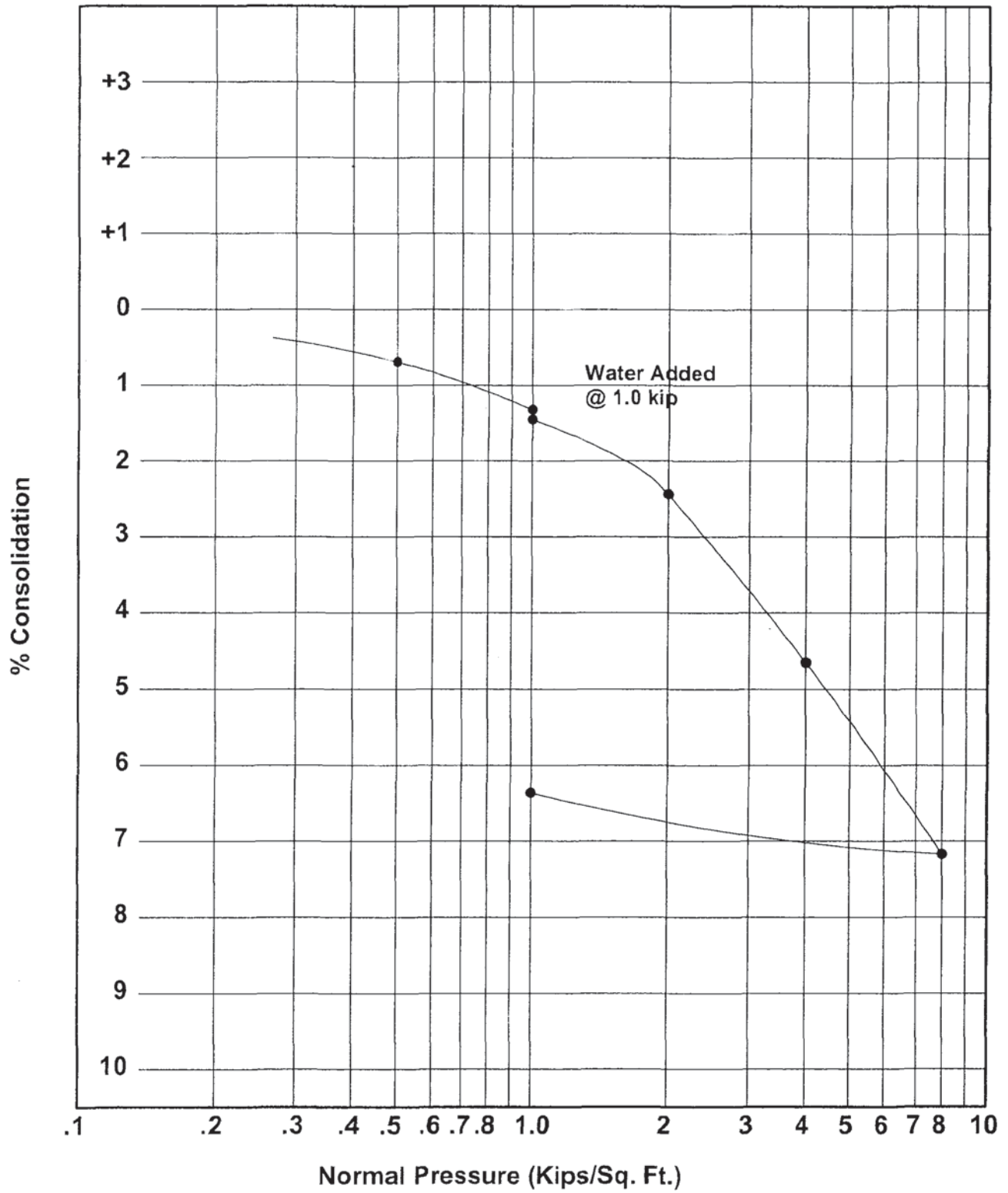

Project Skyline Ranch
 Location B8(1995)
 Depth 5 Feet
 Material Saugus Formation



Geolabs - Westlake Village

GEOLOGY AND SOIL ENGINEERING

DATE _____ BY DS
 SCALE _____ W.O. 8838

CONSOLIDATION - PRESSURE CURVE

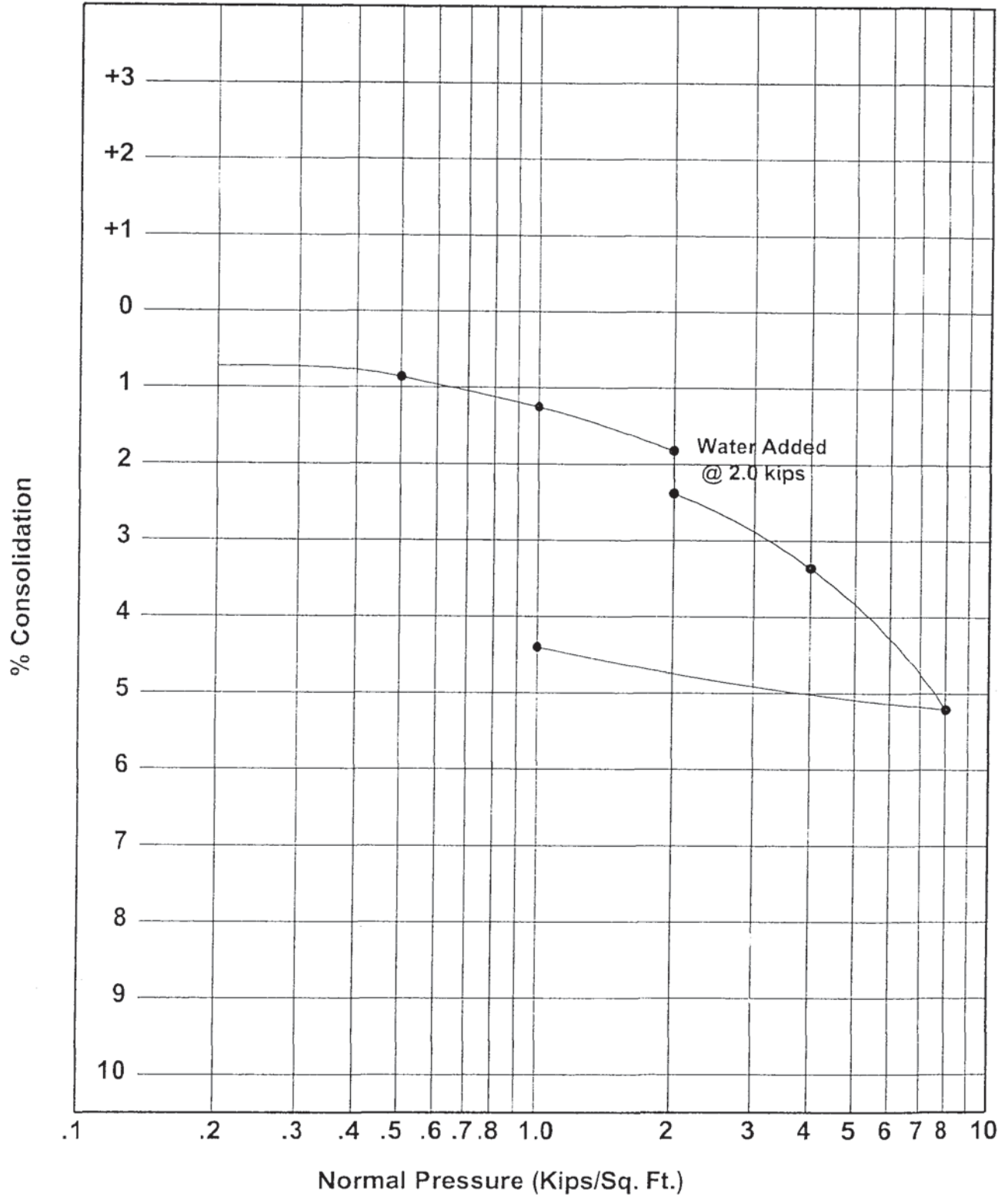

Project Monasabian Property
 Location Boring 1
 Depth 20 Feet
 Material Saugus Fm. - Silty SANDSTONE



Geolabs - Westlake Village

GEOLOGY AND SOIL ENGINEERING

DATE 8/02 BY DS
 SCALE _____ W.O. 8838

CONSOLIDATION - PRESSURE CURVE

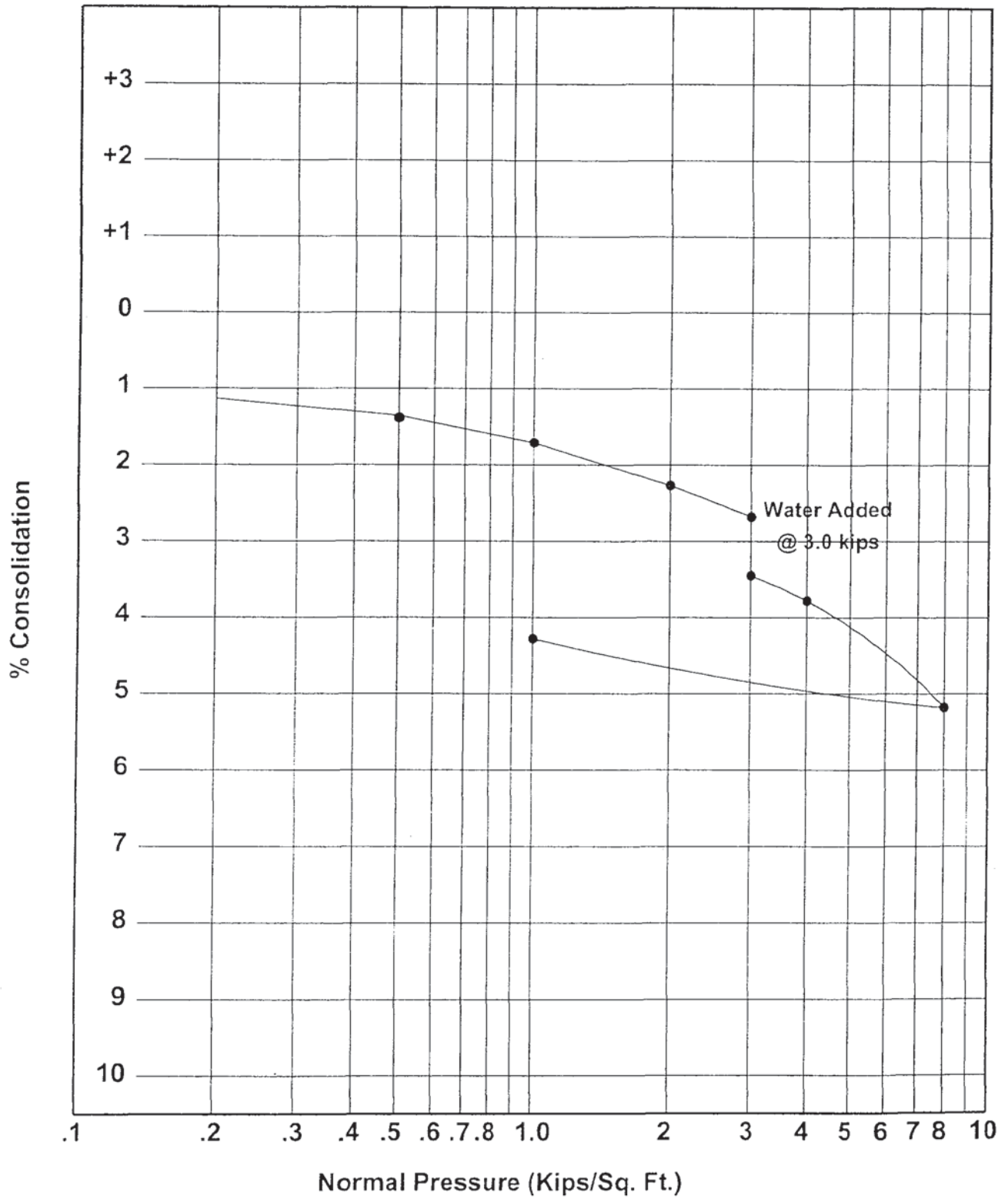

Project Monosabian Property
 Location Boring 2
 Depth 31 Feet
 Material Saugus Fm. - Sandy CONGLOM.



Geolabs - Westlake Village

GEOLOGY AND SOIL ENGINEERING

DATE 8/02 BY DS
 SCALE _____ W.O. 8838

CONSOLIDATION - PRESSURE CURVE

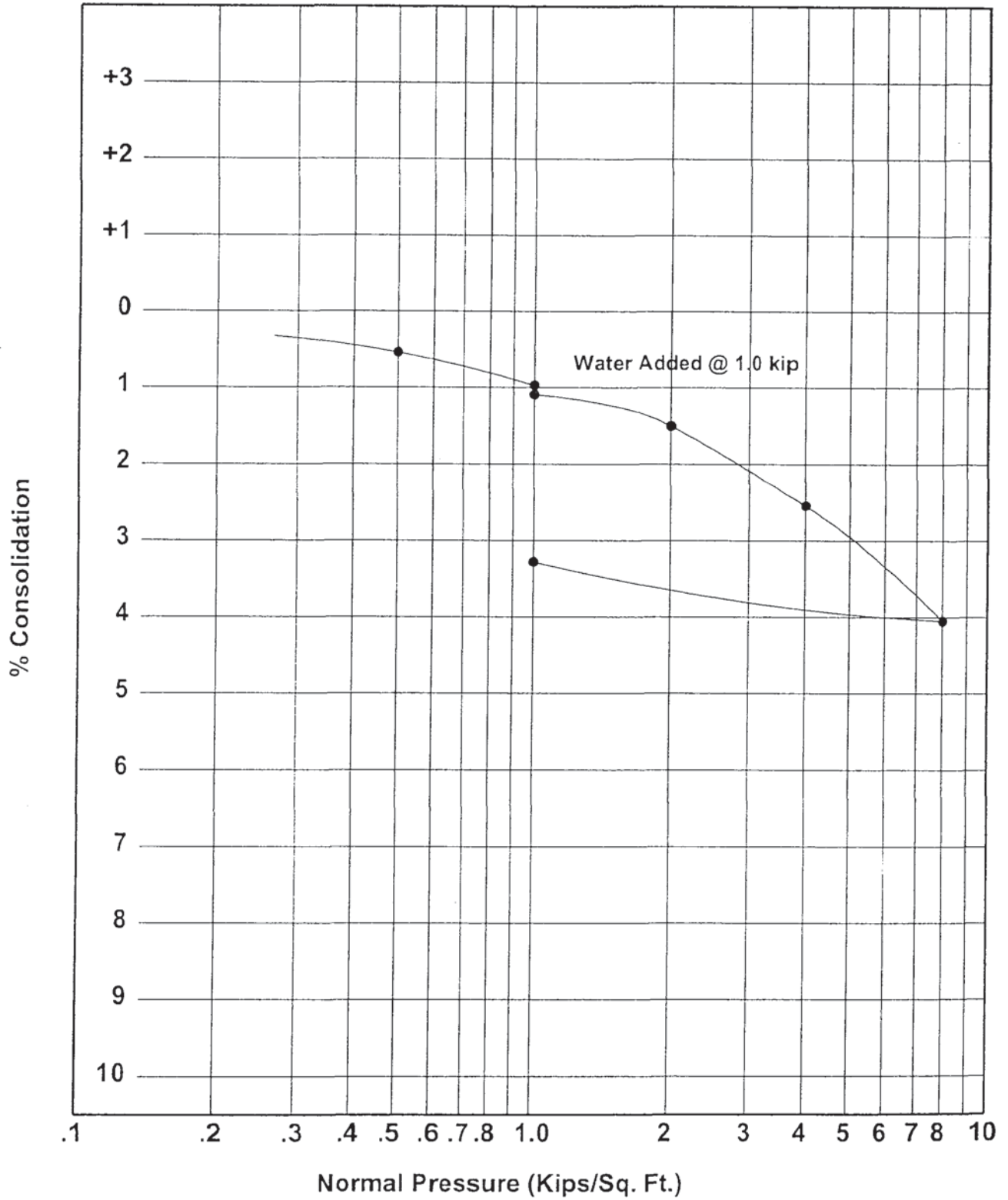

Project Mongsabian Property
 Location Boring 3
 Depth 10 Feet
 Material Saugus Fm. - Sandy CONGL.



Geolabs - Westlake Village

GEOLOGY AND SOIL ENGINEERING

DATE 8/02 BY DS
 SCALE _____ W.O. 8838

CONSOLIDATION - PRESSURE CURVE

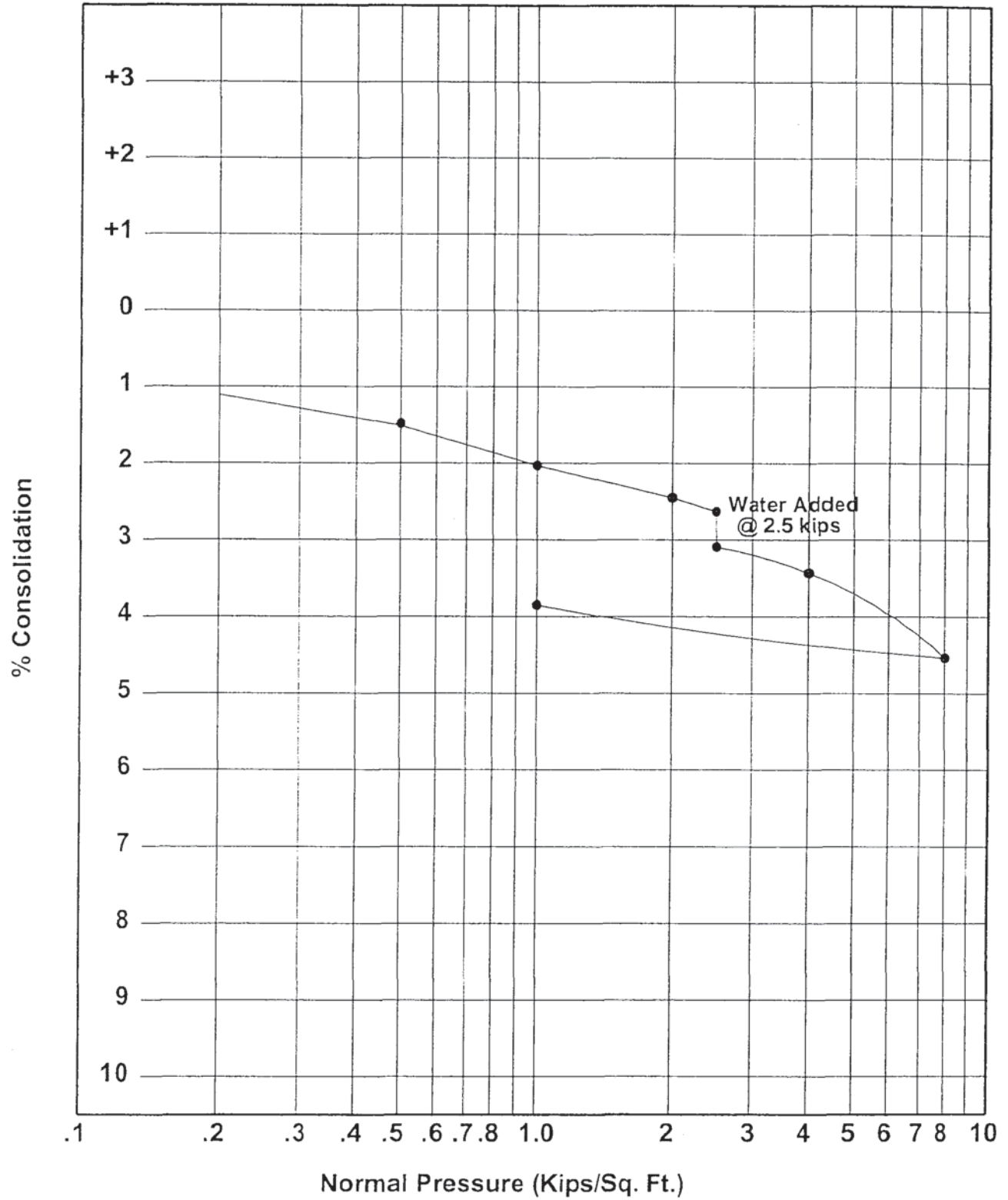

Project Monosabian Property
 Location Boring 3
 Depth 23 Feet
 Material Saugus Fm. - Gravelly SANDSTONE



Geolabs - Westlake Village

GEOLOGY AND SOIL ENGINEERING

DATE 8/02 BY DS
 SCALE _____ W.O. 8838

CONSOLIDATION - PRESSURE CURVE

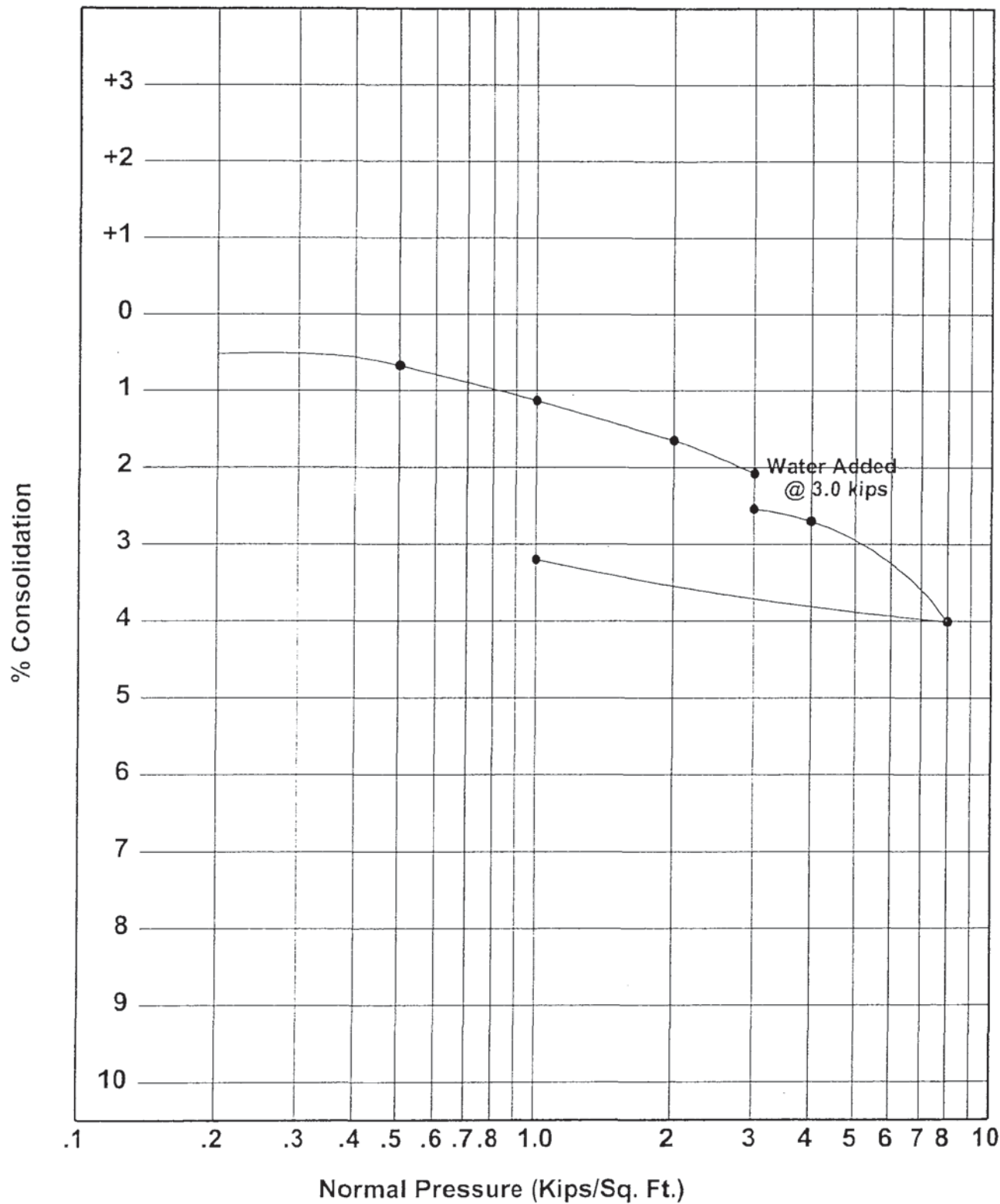

Project Monqsabian Property
 Location Boring 3
 Depth 30 Feet
 Material Saugus Fm. - Sandy CONGLOM.



Geolabs - Westlake Village

GEOLOGY AND SOIL ENGINEERING

DATE 8/02 BY DS
 SCALE _____ W.O. 8838

CONSOLIDATION - PRESSURE CURVE

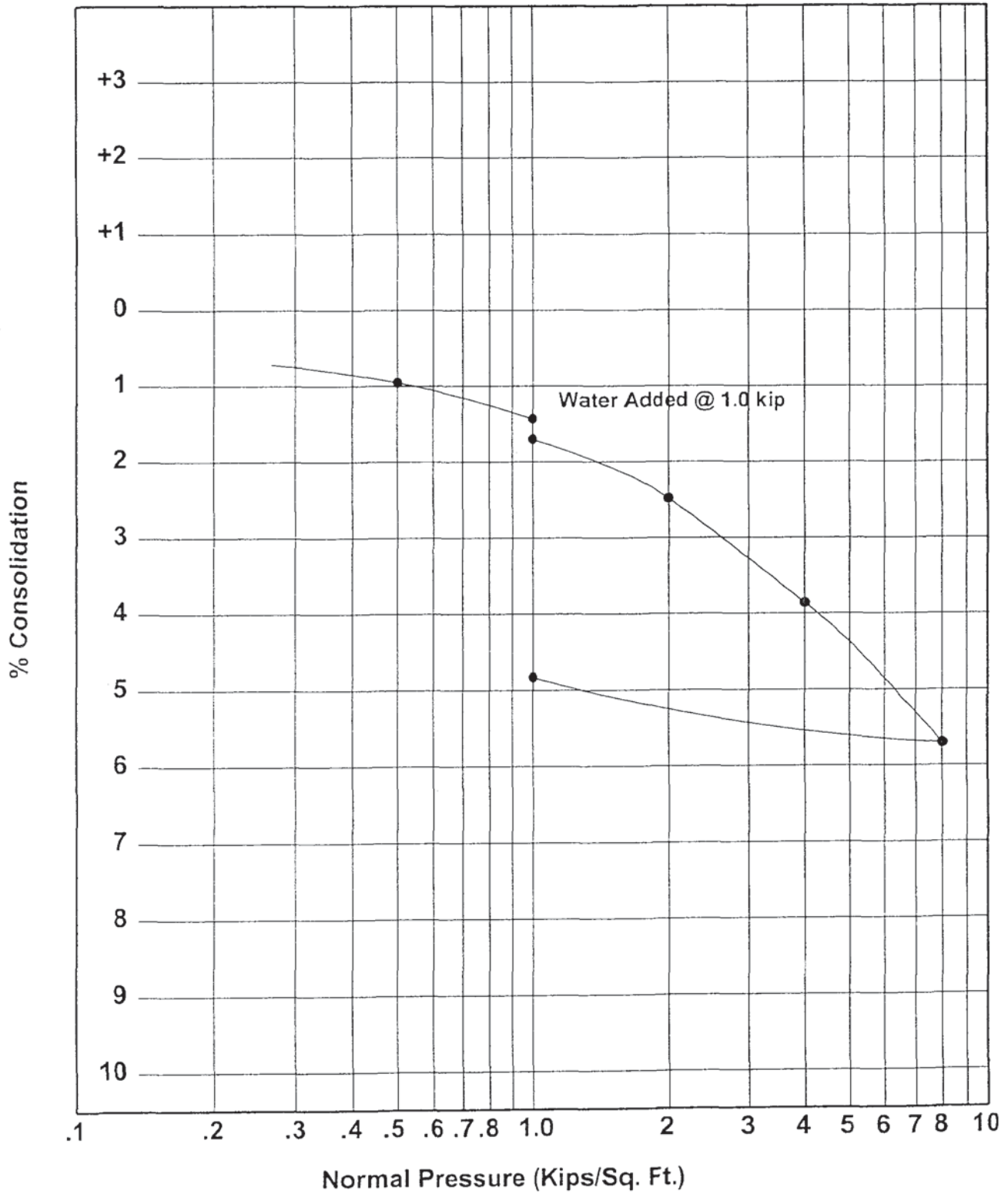

Project Monasabian Prop.
 Location Boring 4
 Depth 10.5 Feet
 Material Saugus Fm. - Sandy Conglomerate



Geolabs - Westlake Village

GEOLOGY AND SOIL ENGINEERING

DATE 9/02 BY DS
 SCALE _____ W.O. 8838

CONSOLIDATION - PRESSURE CURVE

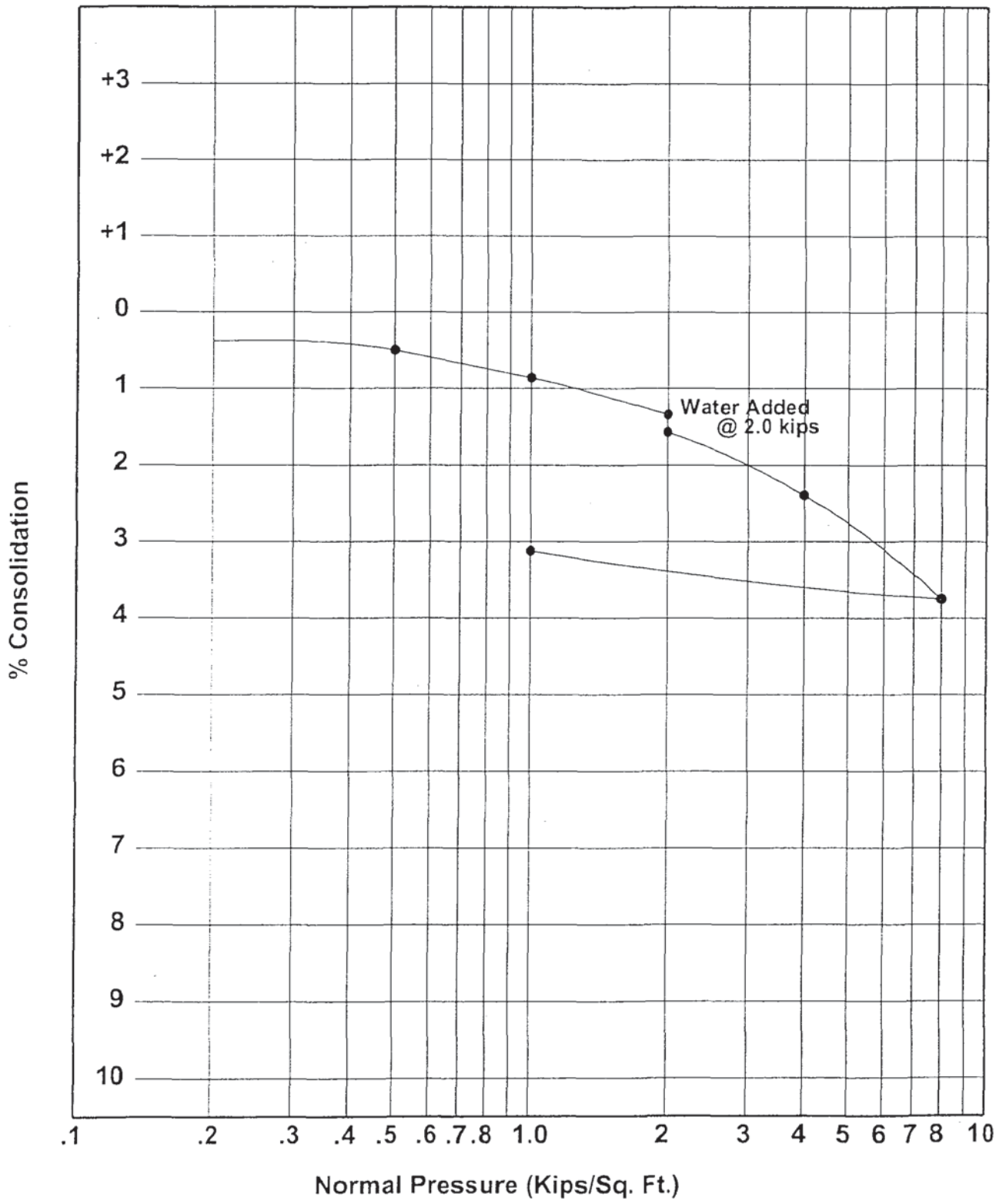

Project Monosabian Prop.
 Location Boring 4
 Depth 20 Feet
 Material Saugus Fm. - Gravelly SANDSTONE



Geolabs - Westlake Village

GEOLOGY AND SOIL ENGINEERING

DATE 9/02 BY DS
 SCALE _____ W.O. 8838

CONSOLIDATION - PRESSURE CURVE

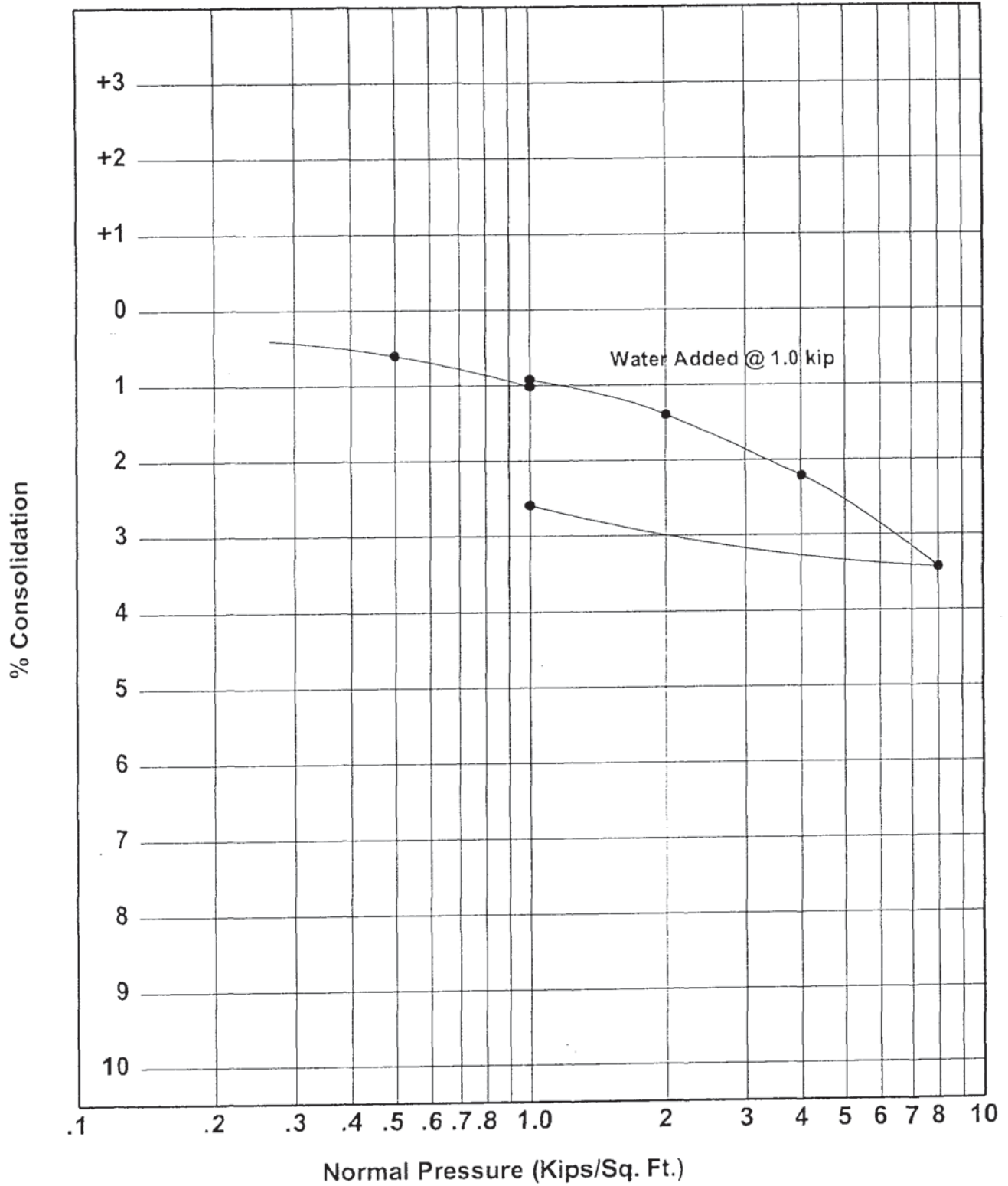

Project Monosabian Prop.
 Location Boring 5
 Depth 10 Feet
 Material Saugus Fm. - Fine to med.



SANDSTONE

Geolabs - Westlake Village

GEOLOGY AND SOIL ENGINEERING

DATE 9/02 BY DS
 SCALE _____ W.O. 8838

CONSOLIDATION - PRESSURE CURVE

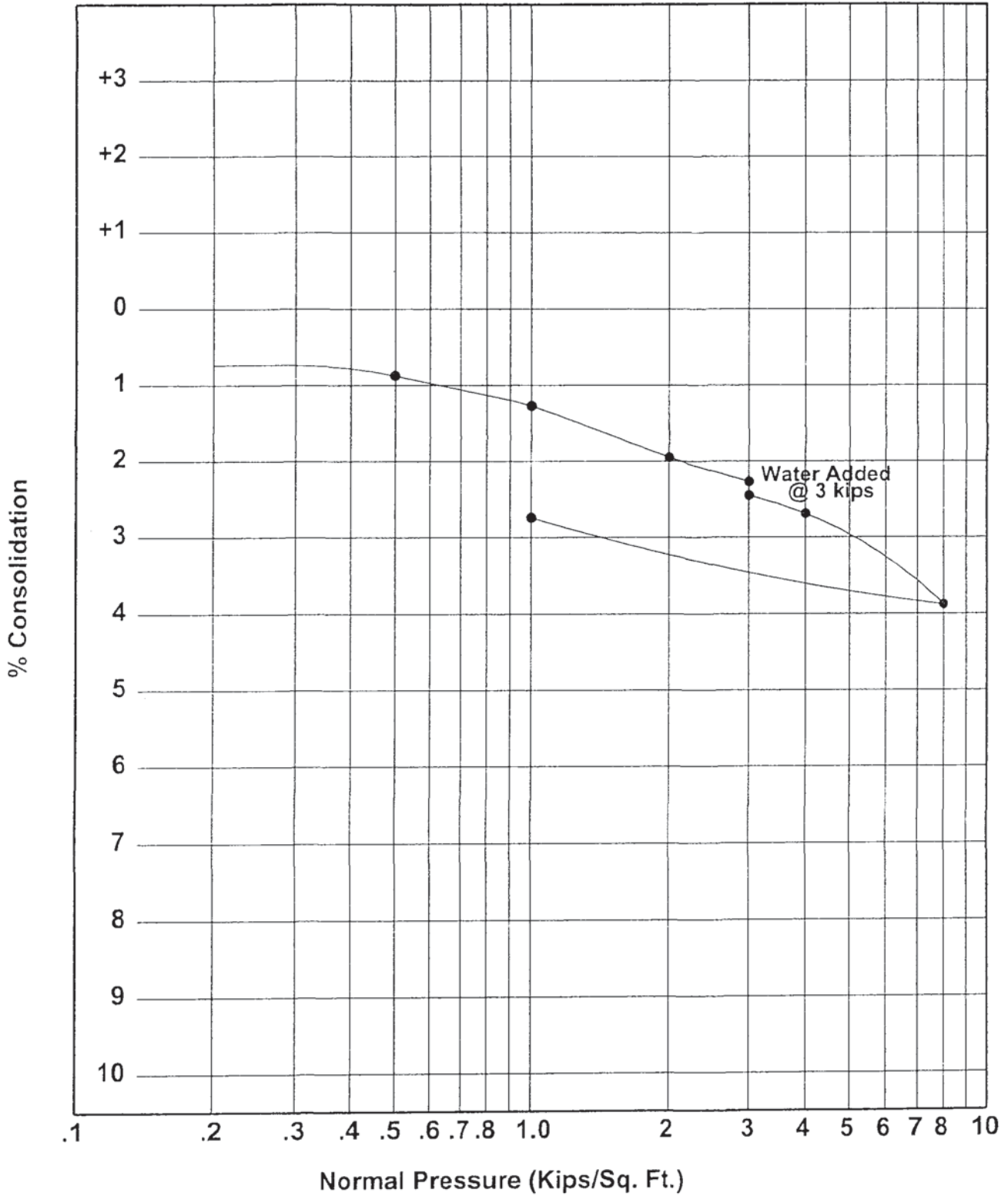

Project Monasabian Prop.
 Location Boring 5
 Depth 30 Feet
 Material Saugus Fm. - Fine to Med. SANDSTONE

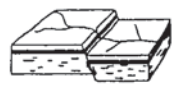

Geolabs - Westlake Village
 GEOLOGY AND SOIL ENGINEERING

DATE 9/02 BY DS
 SCALE _____ W.O. 8838

CONSOLIDATION RESULTS

Undisturbed Sample

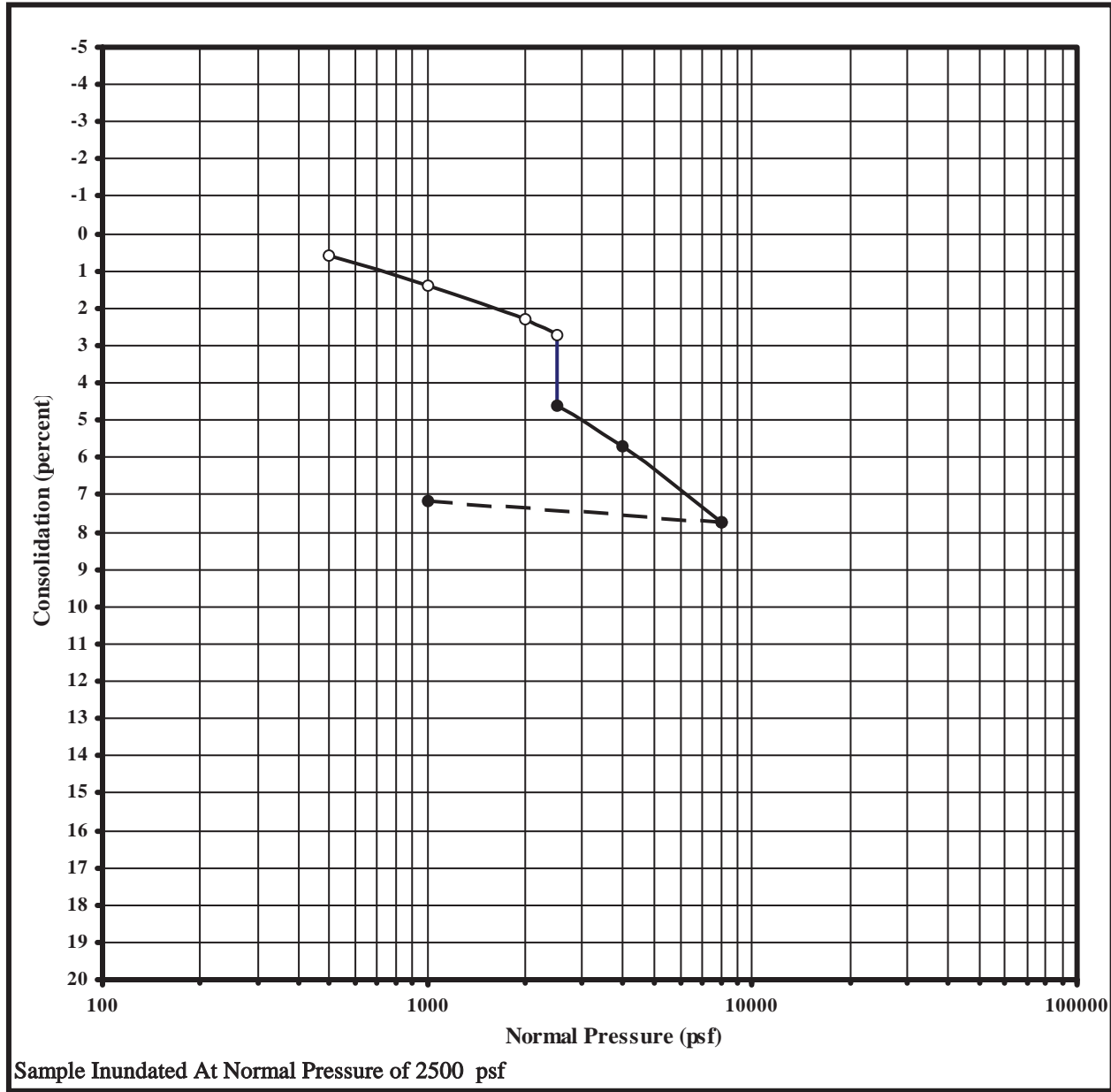

Sample Location: B30
Sample Depth: 25 ft.
Initial Moisture: 5.6 %
Init. Dry Density: 121.9 pcf

Geologic Unit: Alluvium
Material: gravelly SAND

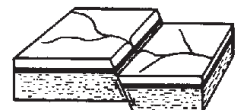

CONSOLIDATION RESULTS

Undisturbed Sample

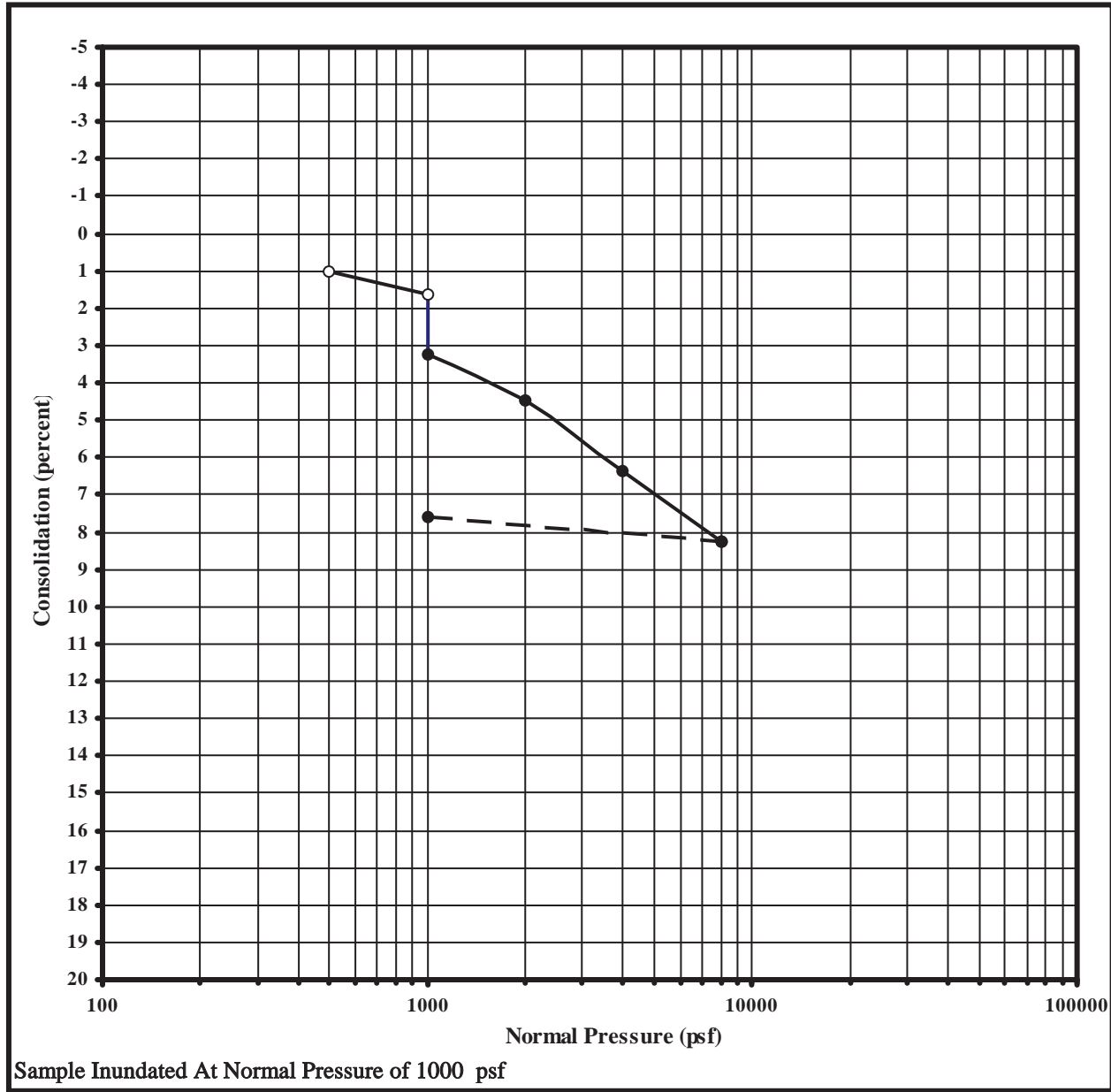

Sample Location: B35
Sample Depth: 8 ft.
Initial Moisture: 6.2 %
Init. Dry Density: 119.5 pcf

Geologic Unit: Alluvium
Material: silty SAND w/gvl

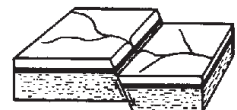

CONSOLIDATION - PRESSURE CURVE

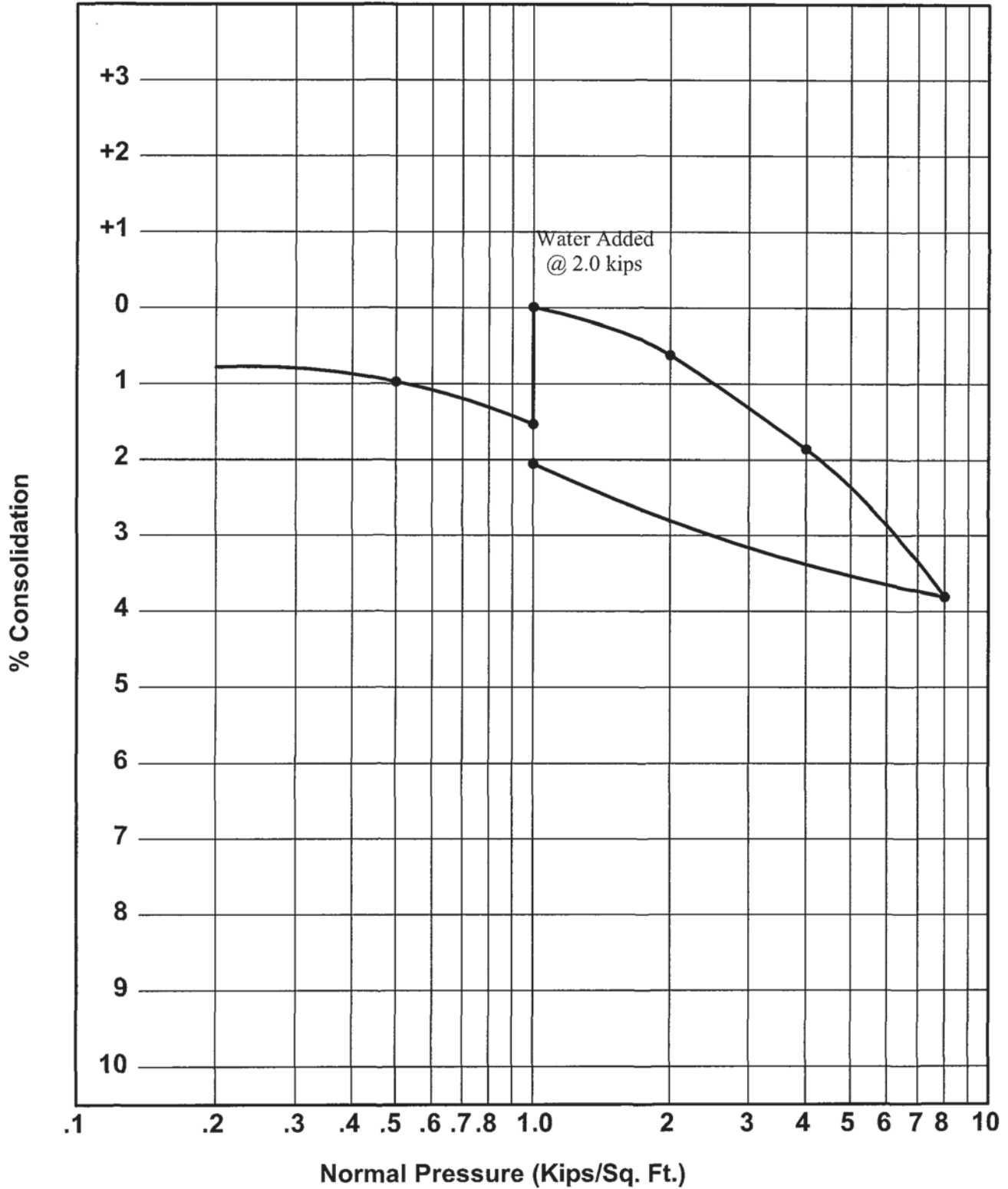

Project Location Tr. 060922 Skyline Ranch
B53
Depth 10 Feet
Material Saugus Formation - Claystone



Geolabs - Westlake Village
 GEOLOGY AND SOIL ENGINEERING

DATE _____ BY DS
 SCALE _____ W.O. 8838.001

CONSOLIDATION - PRESSURE CURVE

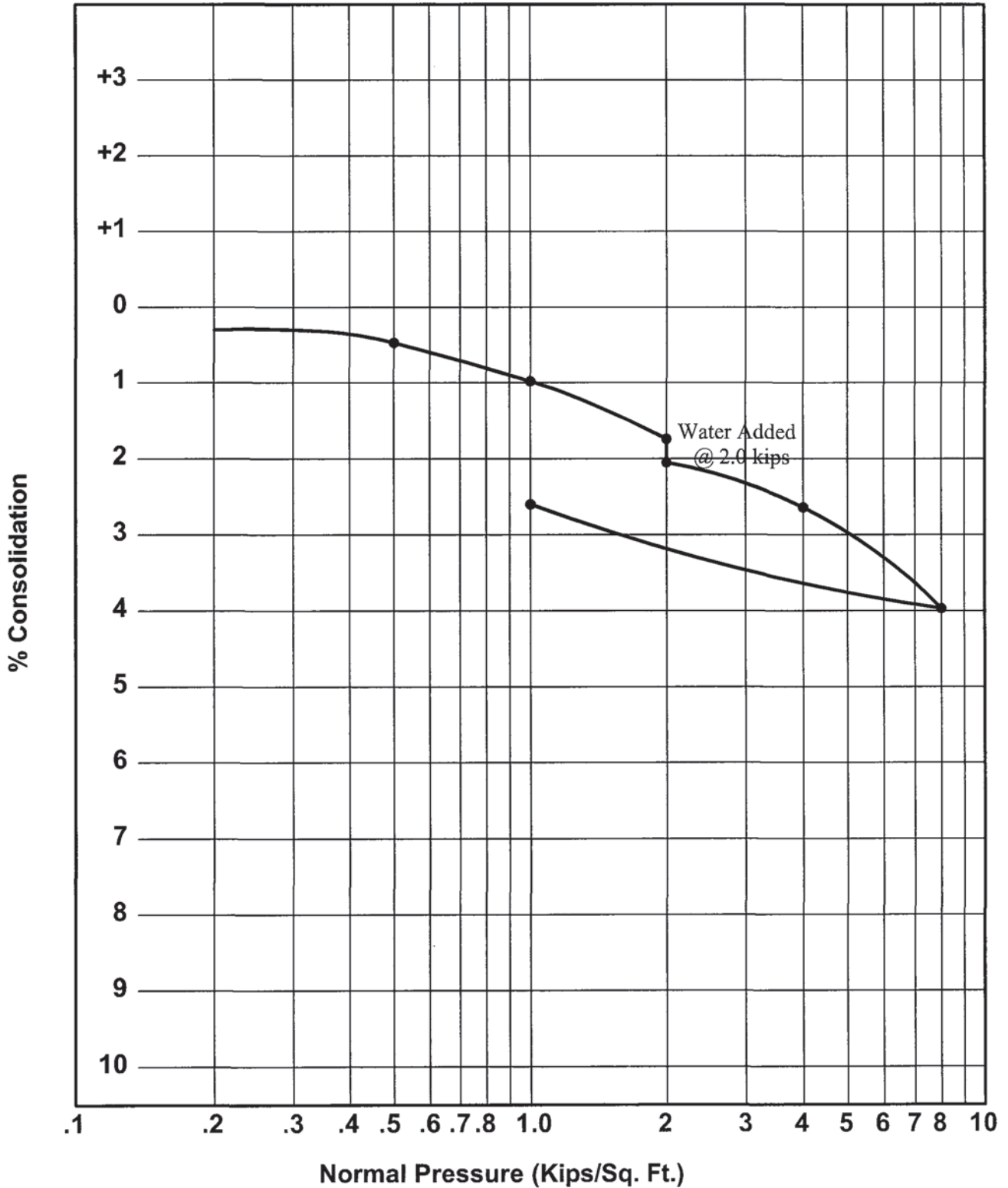

Project Tr. 060922 Skyline Ranch
Location B53
Depth 20 Feet
Material Saugus Formation



Geolabs - Westlake Village
 GEOLOGY AND SOIL ENGINEERING

DATE _____ BY DS
 SCALE _____ w.o. 8838.001

CONSOLIDATION - PRESSURE CURVE

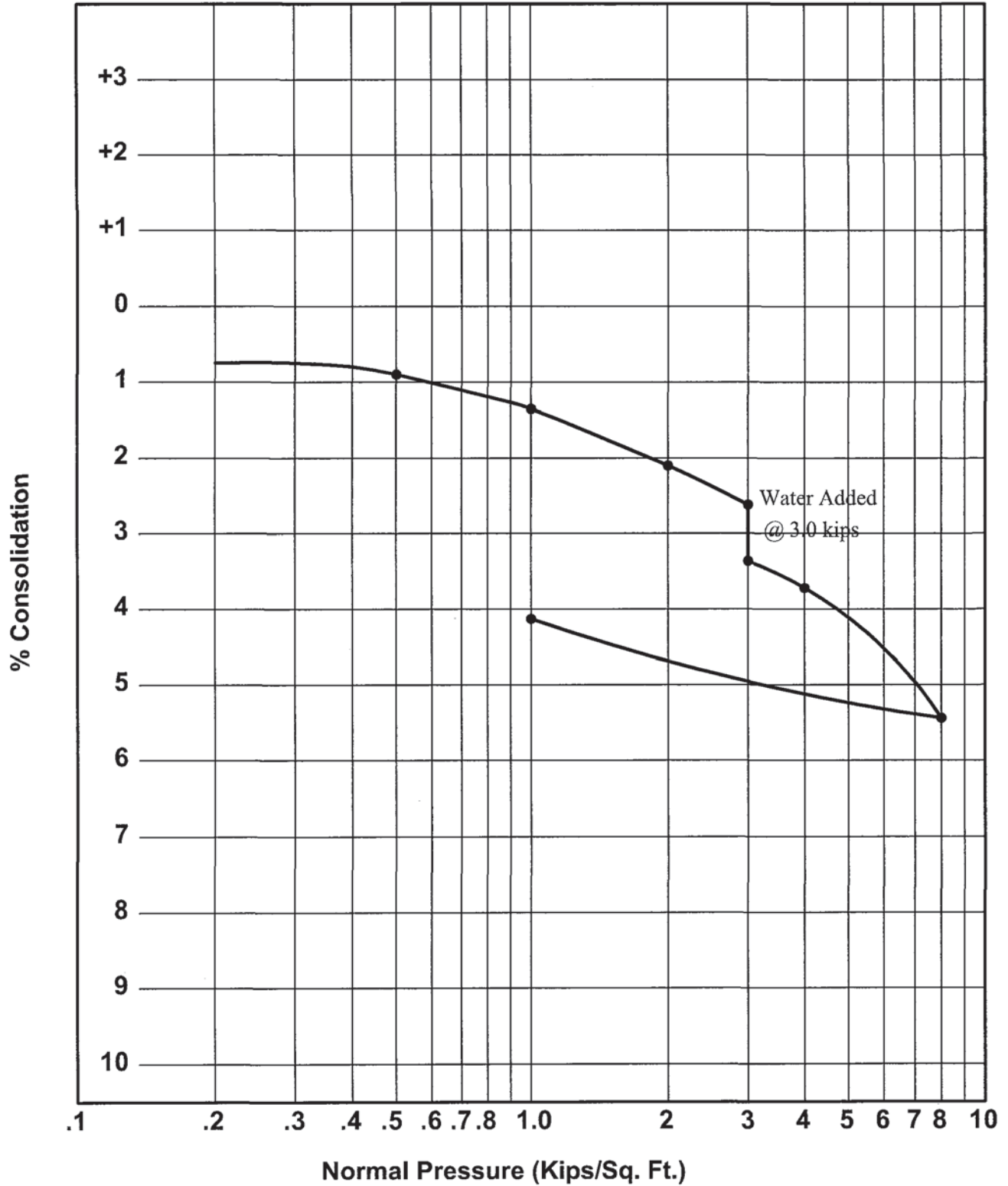

Project Tr. 060922 Skyline Ranch
Location B54
Depth 30 Feet
Material Landslide Debris



Geolabs - Westlake Village
 GEOLOGY AND SOIL ENGINEERING

DATE _____ BY DS
 SCALE _____ W.O. 8838.001

CONSOLIDATION - PRESSURE CURVE

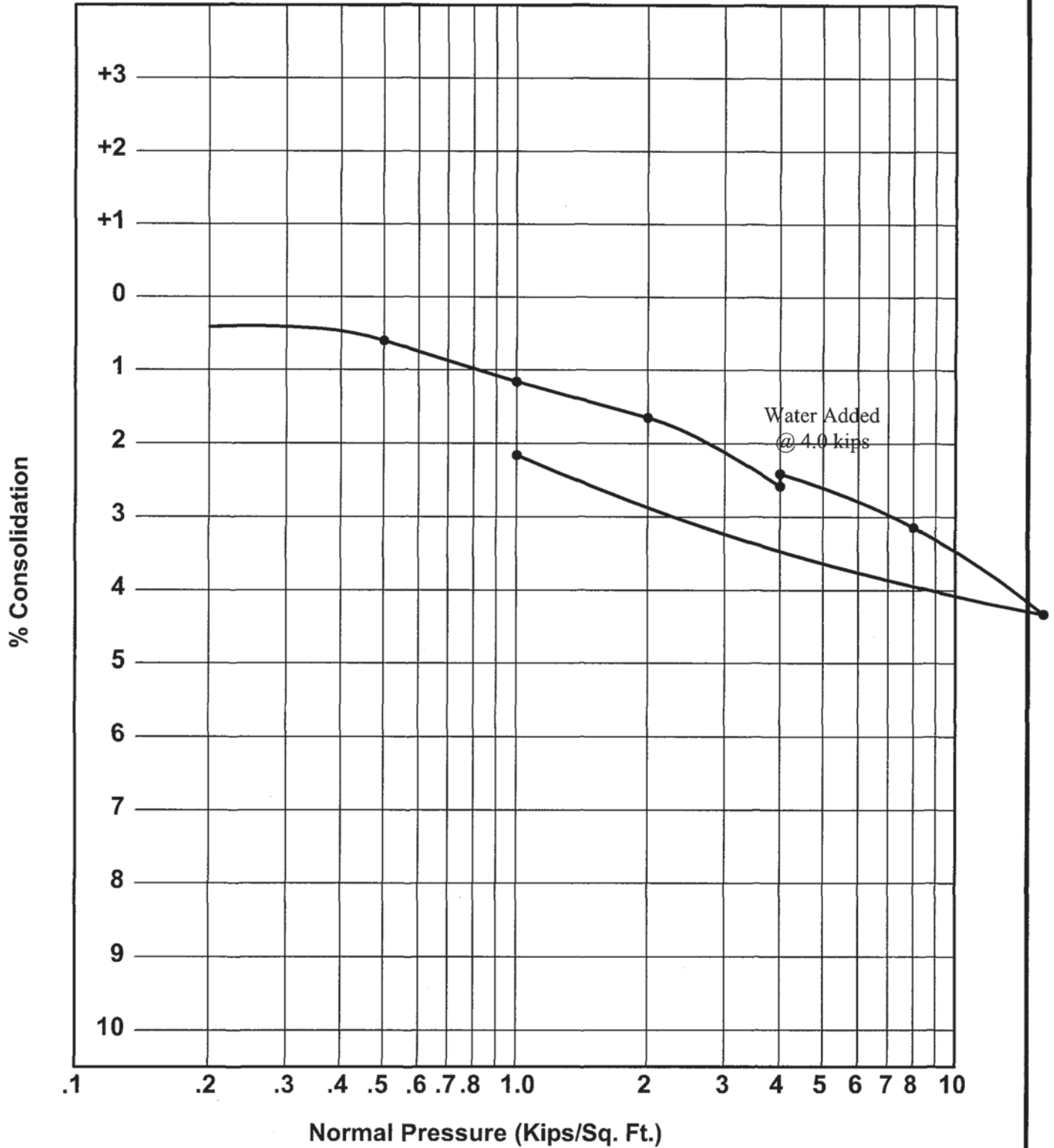

Project Tr. 060922 Skyline Ranch
Location B54
Depth 40 Feet
Material Landslide Debris



Geolabs - Westlake Village
 GEOLOGY AND SOIL ENGINEERING

DATE _____ BY DS
 SCALE _____ W.O. 8838.001

CONSOLIDATION - PRESSURE CURVE

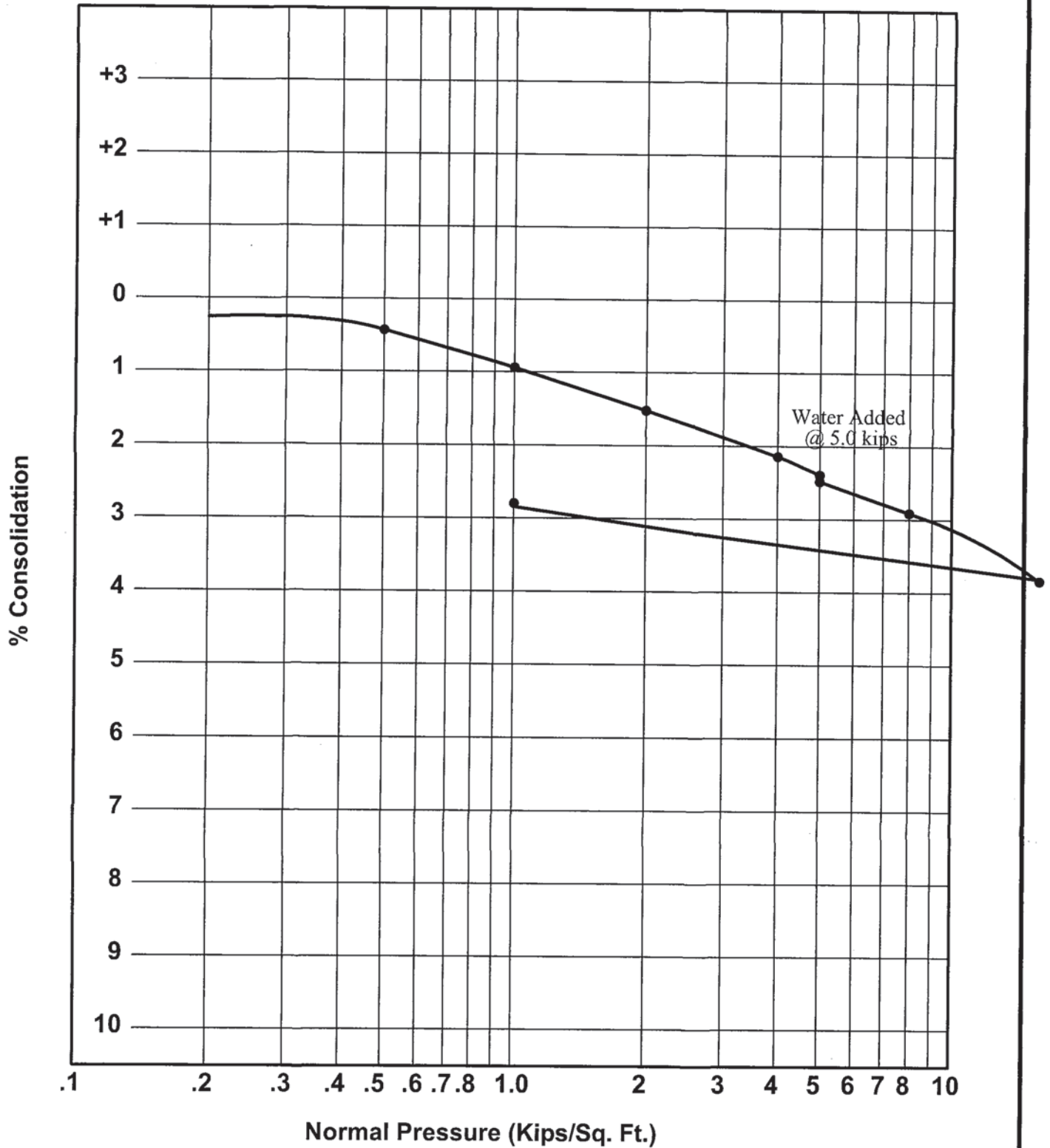

Project Location Tr. 060922 Skyline Ranch
Location B54
Depth 50 Feet
Material Landslide Debris



Geolabs - Westlake Village
 GEOLOGY AND SOIL ENGINEERING

DATE _____ BY DS
 SCALE _____ w.o. 8838.001

CONSOLIDATION - PRESSURE CURVE

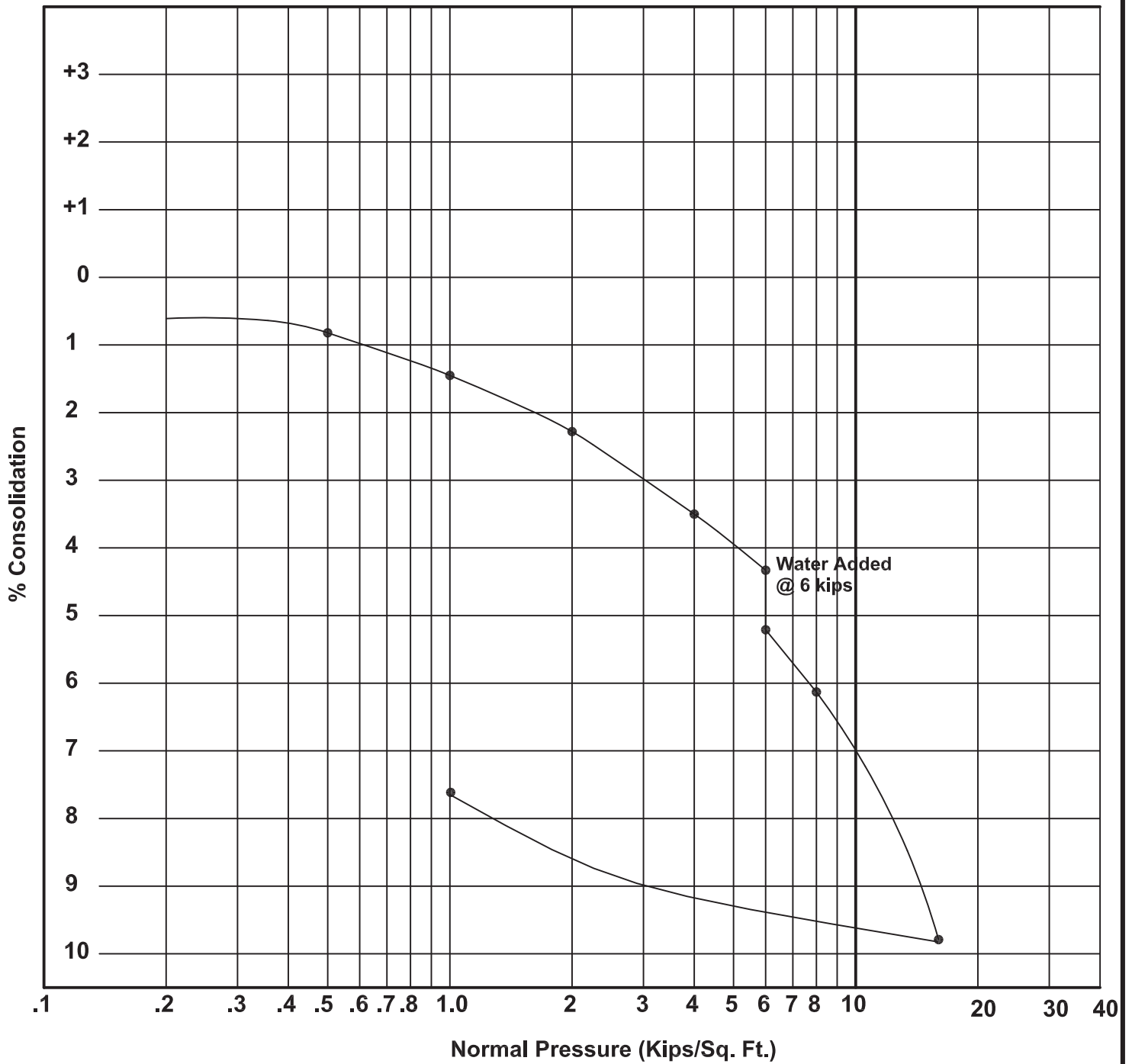

Project Skyline Ranch
Location B80
Depth 7.5'
Material Landslide Debris - clayey SAND with gravel



Geolabs - Westlake Village

GEOLOGY AND SOIL ENGINEERING

DATE 9/4/07 BY RMP
 SCALE NTS w.o. 8838

PLATE C80.7.5

CONSOLIDATION - PRESSURE CURVE

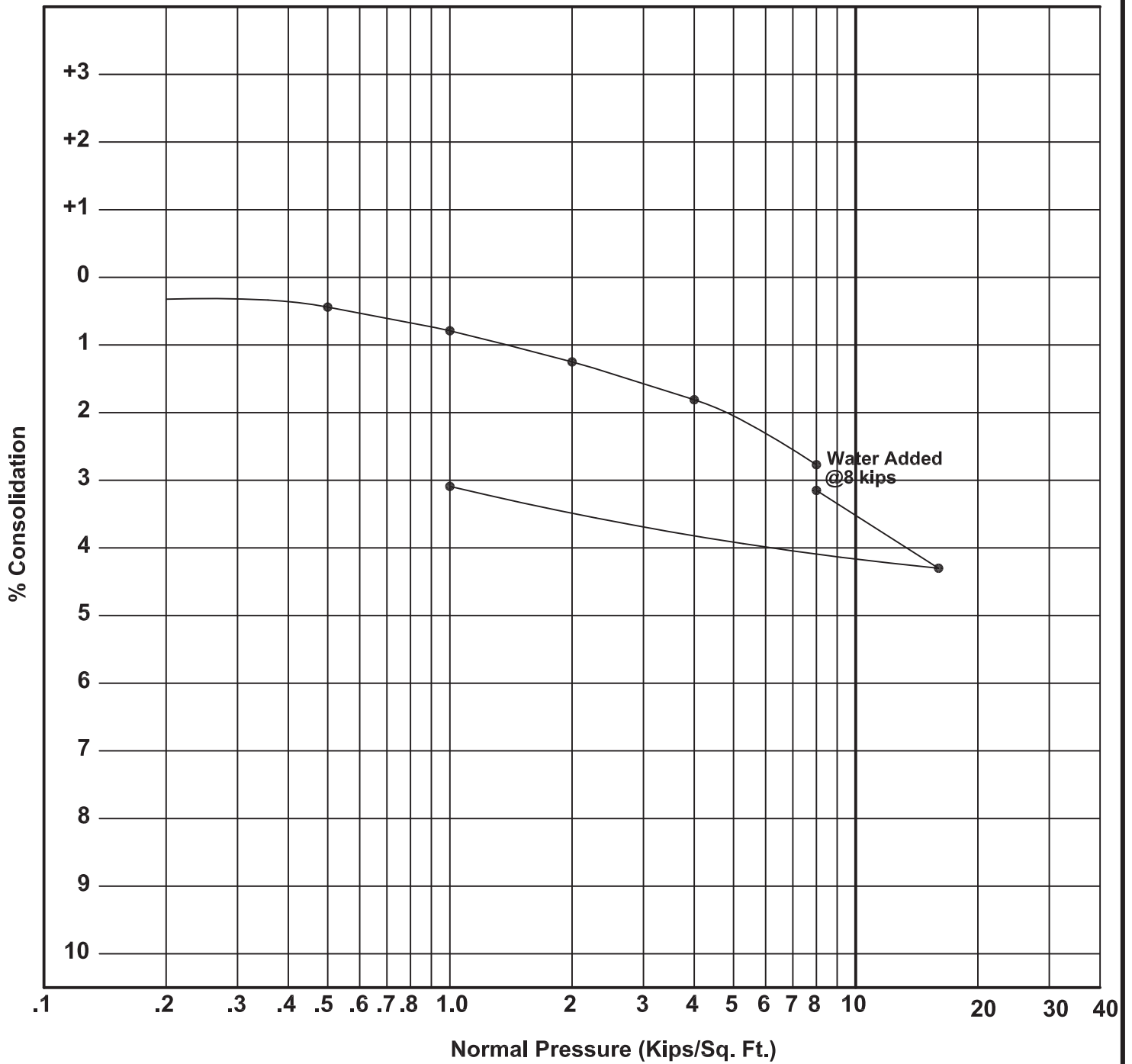

Project Skyline Ranch
Location B80
Depth 14'
Material Landslide Debris - clayey SAND with silt and gvl



Geolabs - Westlake Village

GEOLOGY AND SOIL ENGINEERING

DATE 9/4/07 BY RMP
 SCALE NTS W.O. 8838

PLATE C80.14

CONSOLIDATION - PRESSURE CURVE

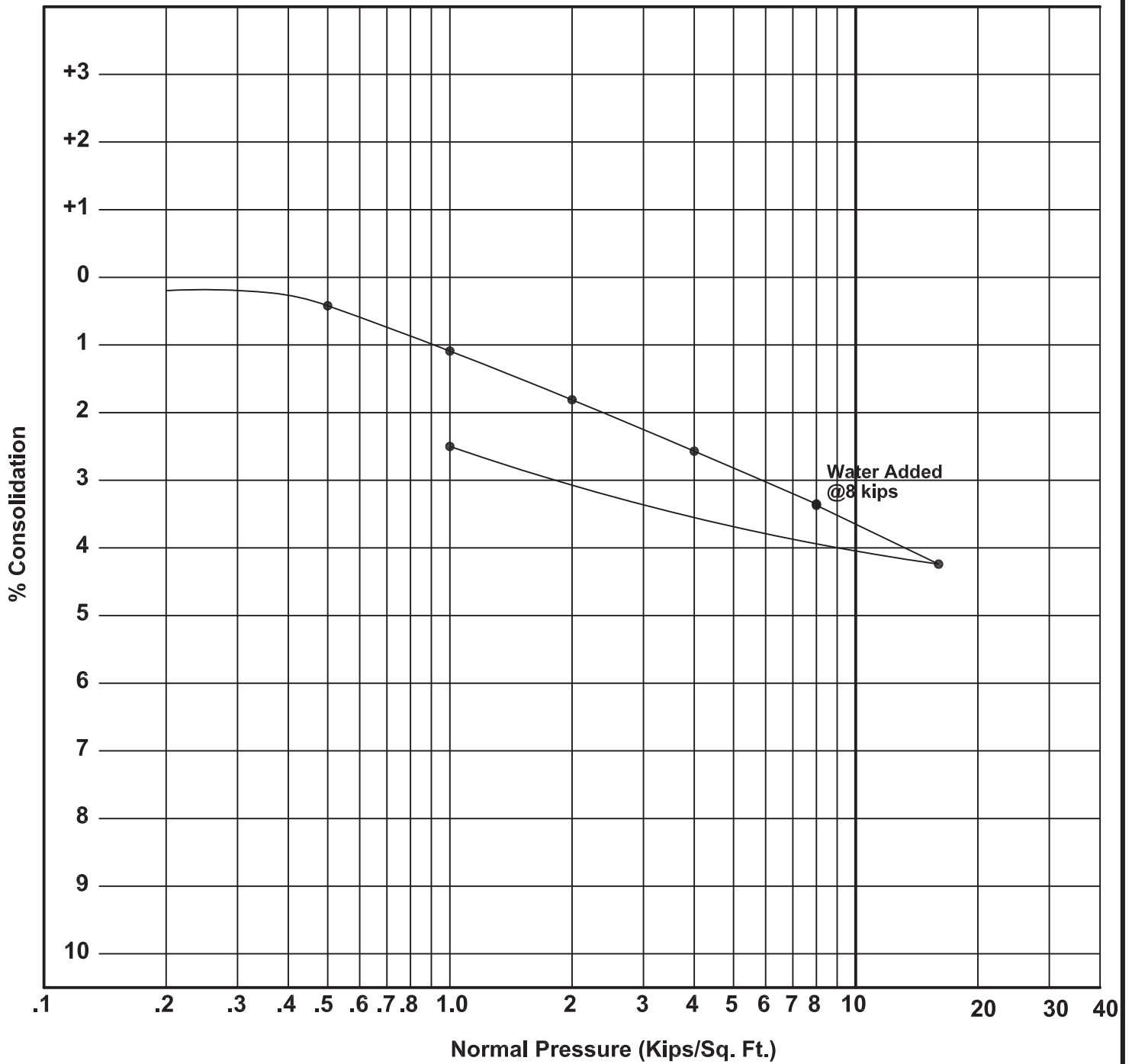

Project Skyline Ranch
 Location B80
 Depth 22'
 Material Landslide Debris - sandy SILT



Geolabs - Westlake Village

GEOLOGY AND SOIL ENGINEERING

DATE 9/4/07 BY RMP
 SCALE NTS W.O. 8838

PLATE C80.22

CONSOLIDATION - PRESSURE CURVE

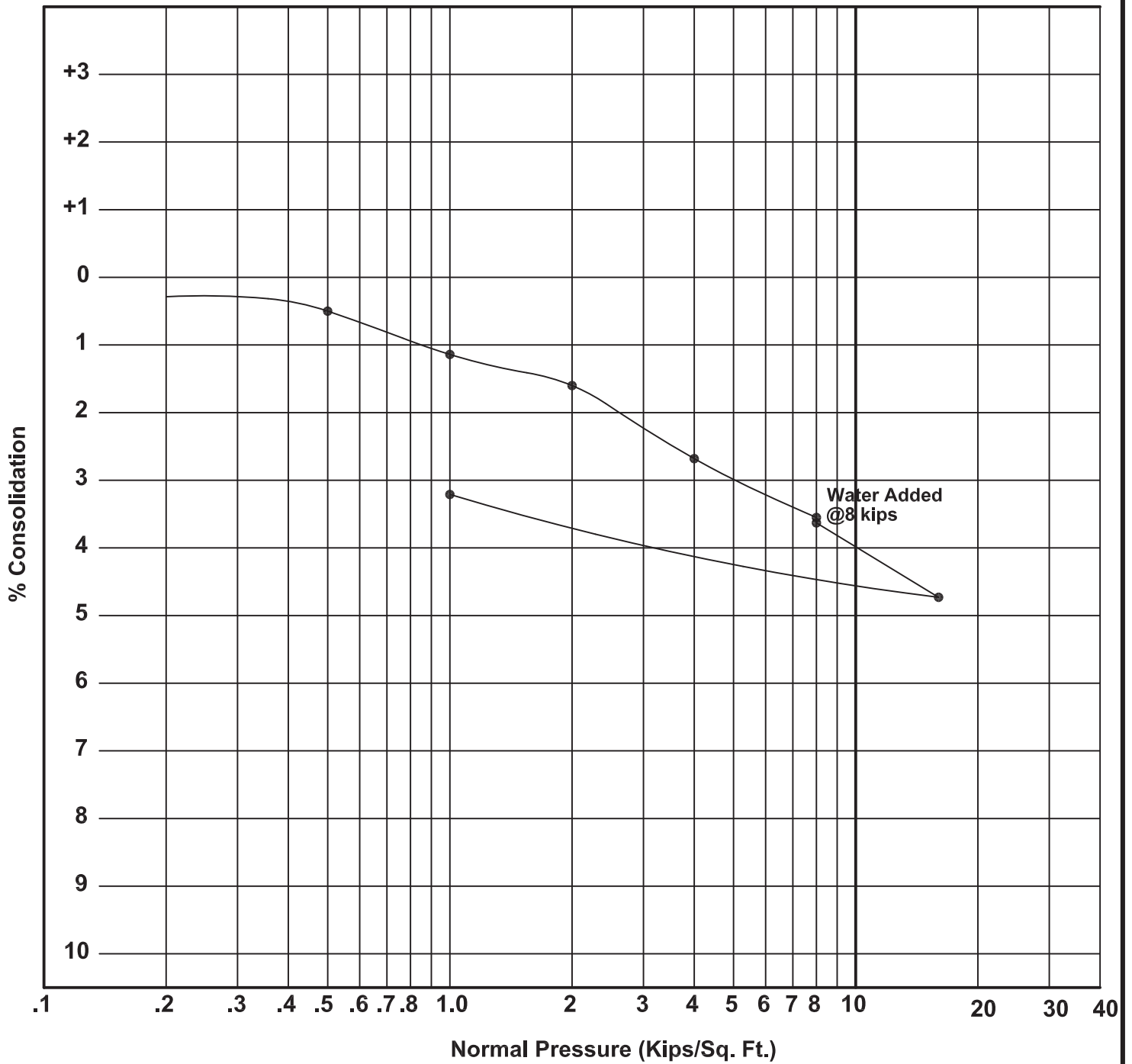

Project Skyline Ranch
Location B80
Depth 30'
Material Saugus Formation - CONGLOMERATE



Geolabs - Westlake Village

GEOLOGY AND SOIL ENGINEERING

DATE 9/4/07 BY RMP
 SCALE NTS W.O. 8838

PLATE C80.30

CONSOLIDATION - PRESSURE CURVE

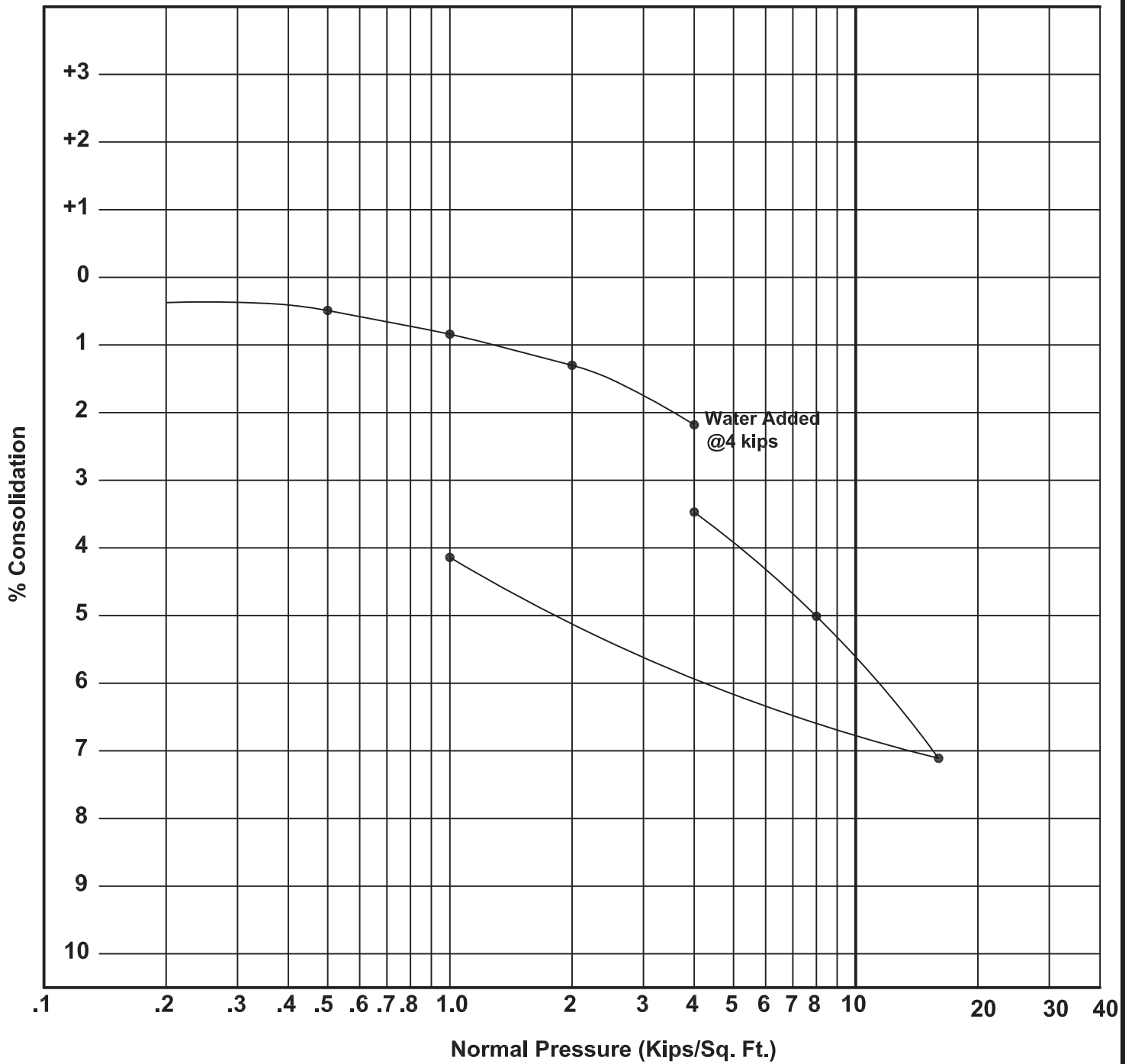

Project Skyline Ranch
 Location B81
 Depth 7'
 Material Landslide Debris - sandy GRAVEL



Geolabs - Westlake Village

GEOLOGY AND SOIL ENGINEERING

DATE 9/4/07 BY RMP
 SCALE NTS W.O. 8838

PLATE C81.7

CONSOLIDATION - PRESSURE CURVE

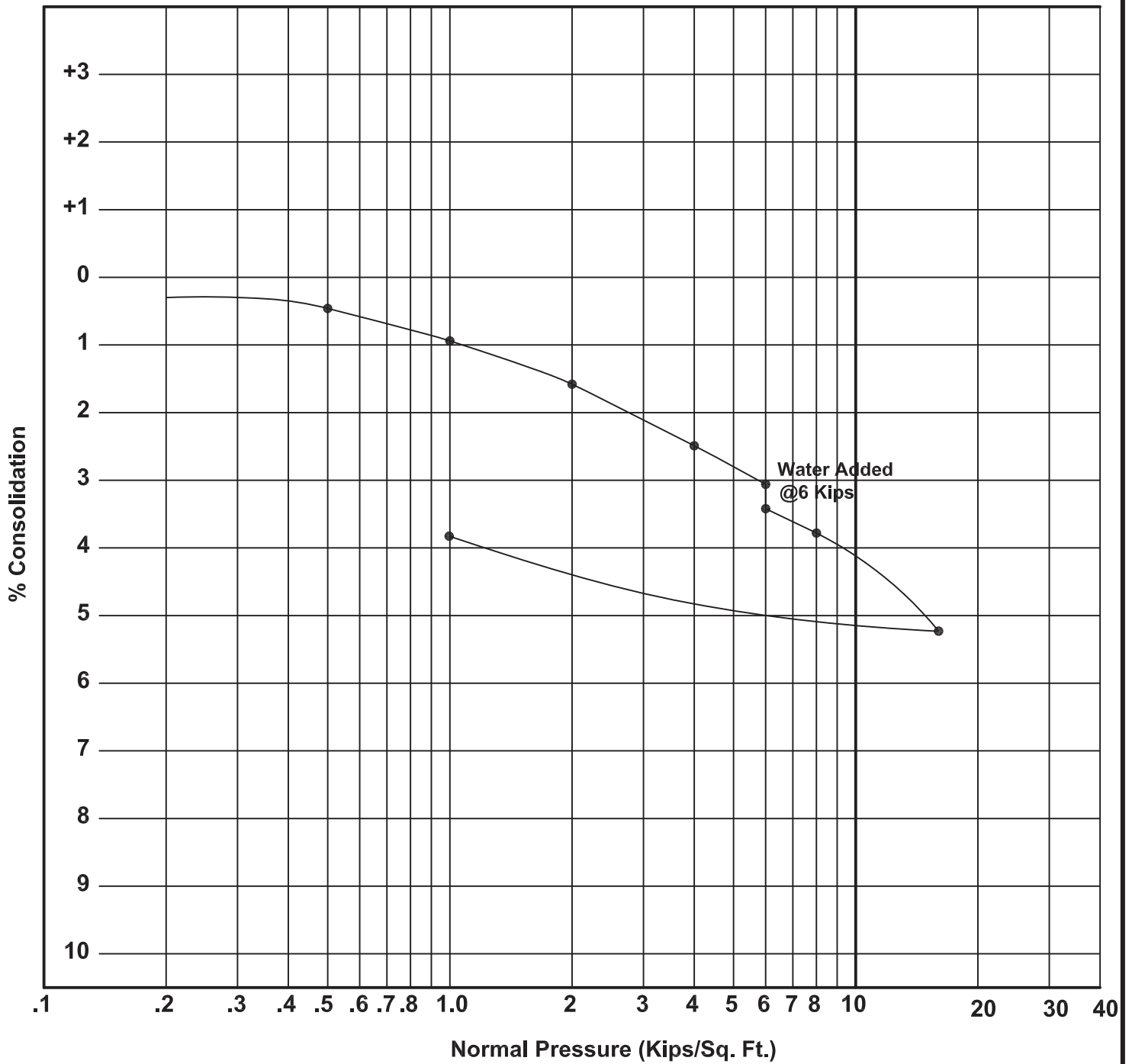

Project Skyline Ranch
Location B81
Depth 15'
Material Landslide Debris - sandy GRAVEL



Geolabs - Westlake Village

GEOLOGY AND SOIL ENGINEERING

DATE 9/4/07 BY RMP
 SCALE NTS w.o. 8838

PLATE C81.15

CONSOLIDATION - PRESSURE CURVE

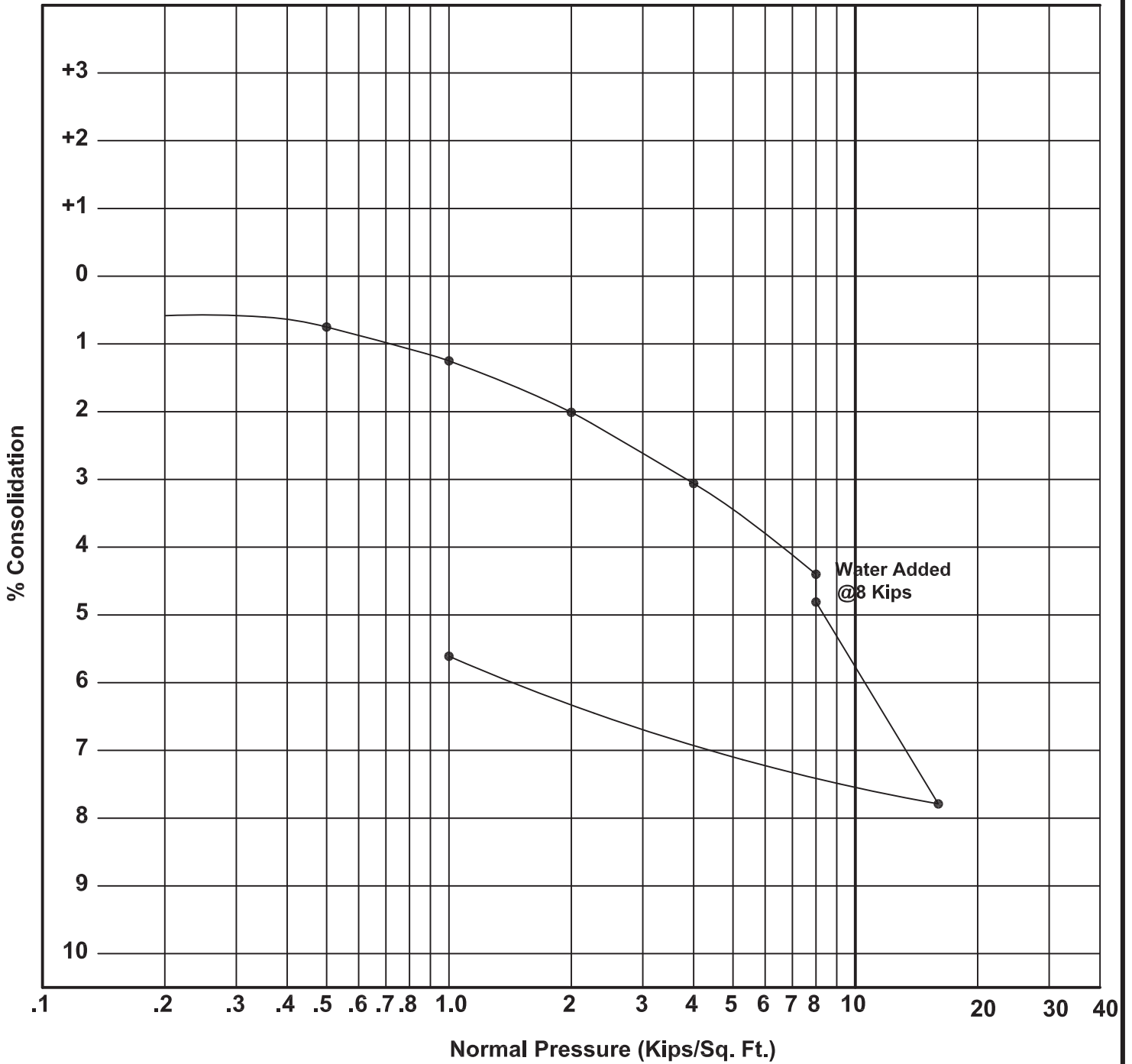

Project Skyline Ranch
Location B81
Depth 22'
Material Landslide Debris - sandy CLAY



Geolabs - Westlake Village

GEOLOGY AND SOIL ENGINEERING

DATE 9/4/07 BY RMP
 SCALE NTS w.o. 8838

PLATE C81.22

CONSOLIDATION - PRESSURE CURVE

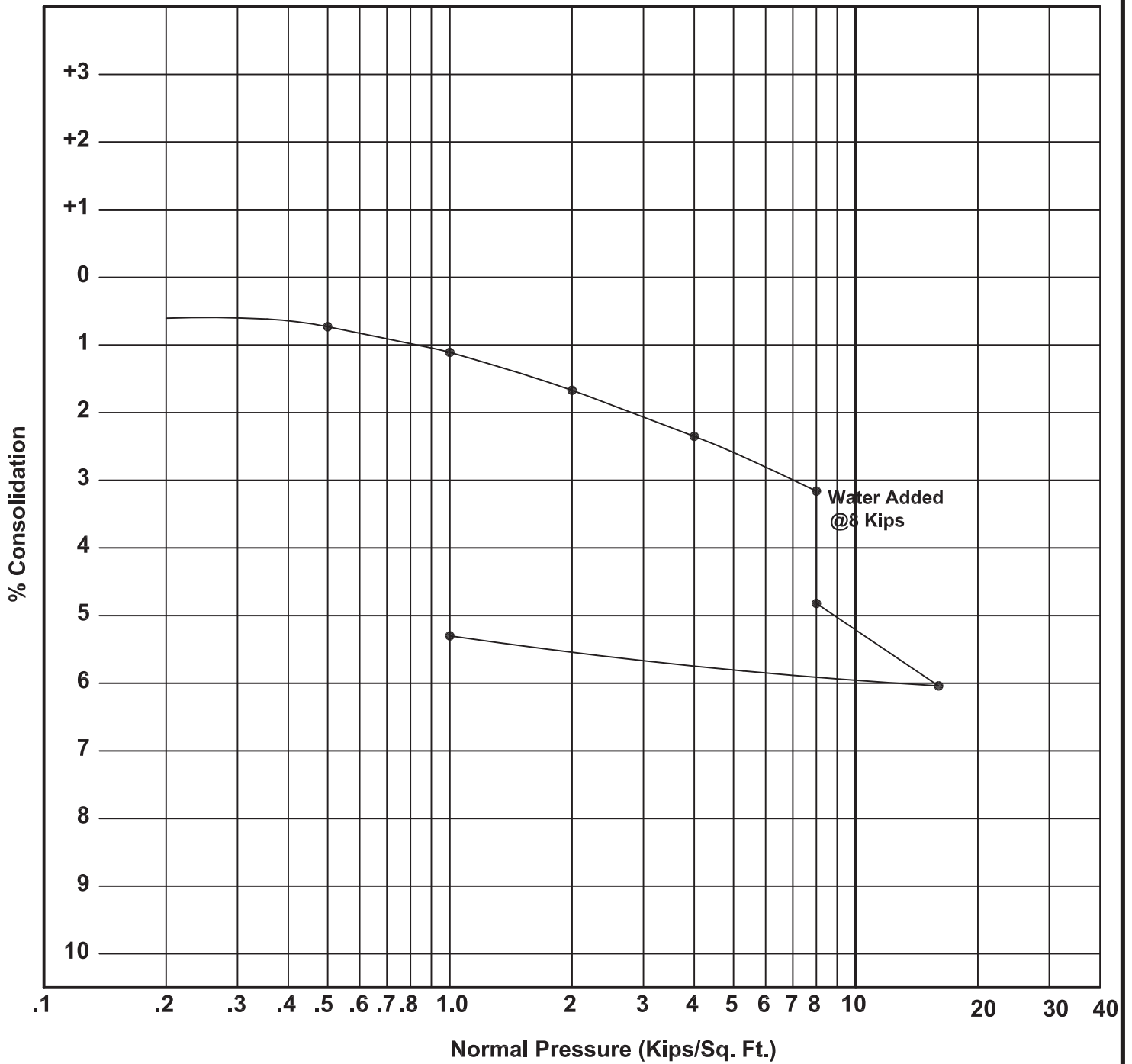

Project Skyline Ranch
Location B81
Depth 30'
Material Saugus Formation - gravelly SANDSTONE



Geolabs - Westlake Village

GEOLOGY AND SOIL ENGINEERING

DATE 9/5/07 BY RMP
 SCALE NTS w.o. 8838

PLATE C81.30

CONSOLIDATION - PRESSURE CURVE

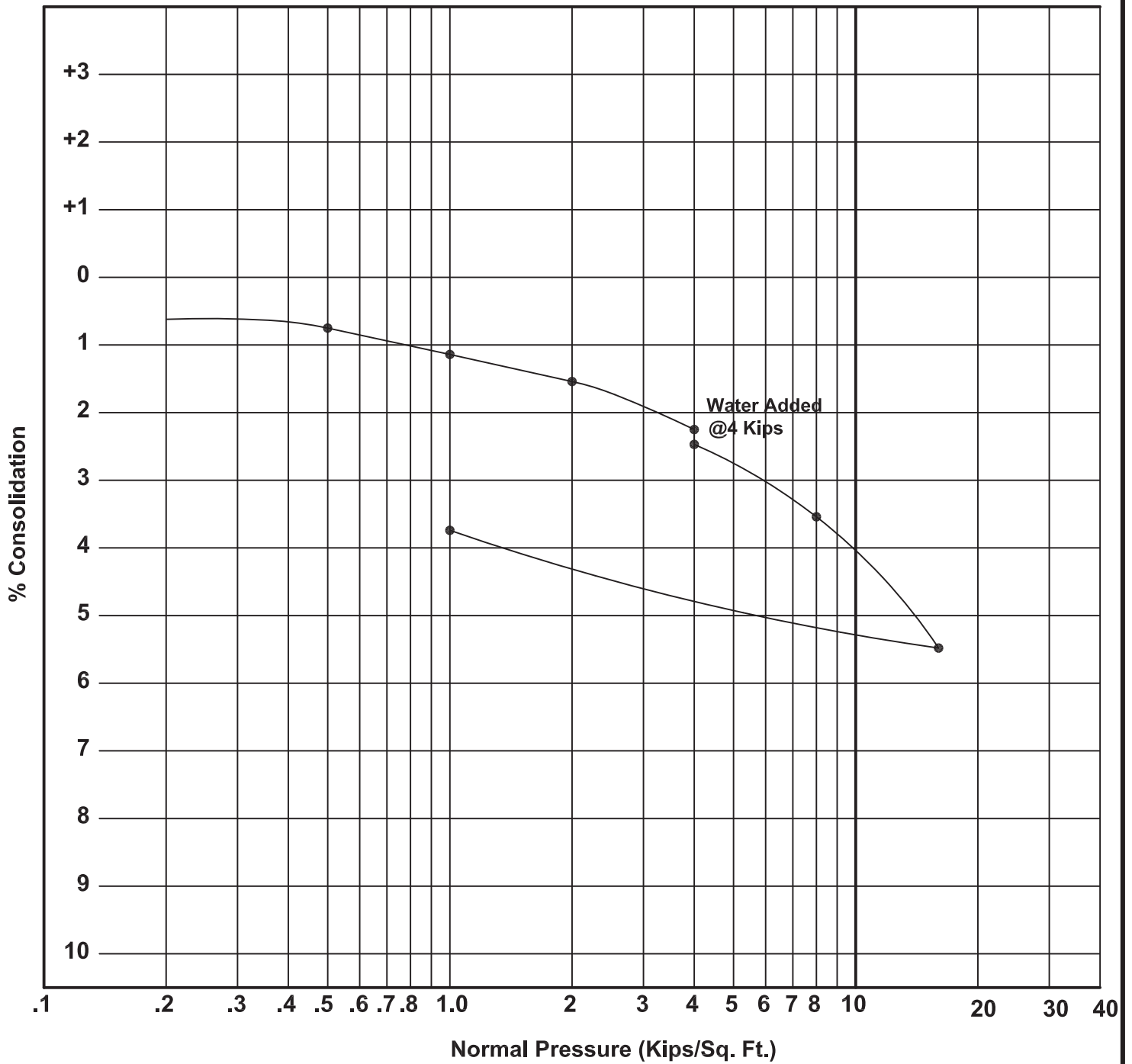

Project Skyline Ranch
Location B82
Depth 12'
Material Landslide Debris - silty SAND with gvl



Geolabs - Westlake Village

GEOLOGY AND SOIL ENGINEERING

DATE 9/5/07 BY RMP
 SCALE NTS W.O. 8838

PLATE C82.12

CONSOLIDATION - PRESSURE CURVE

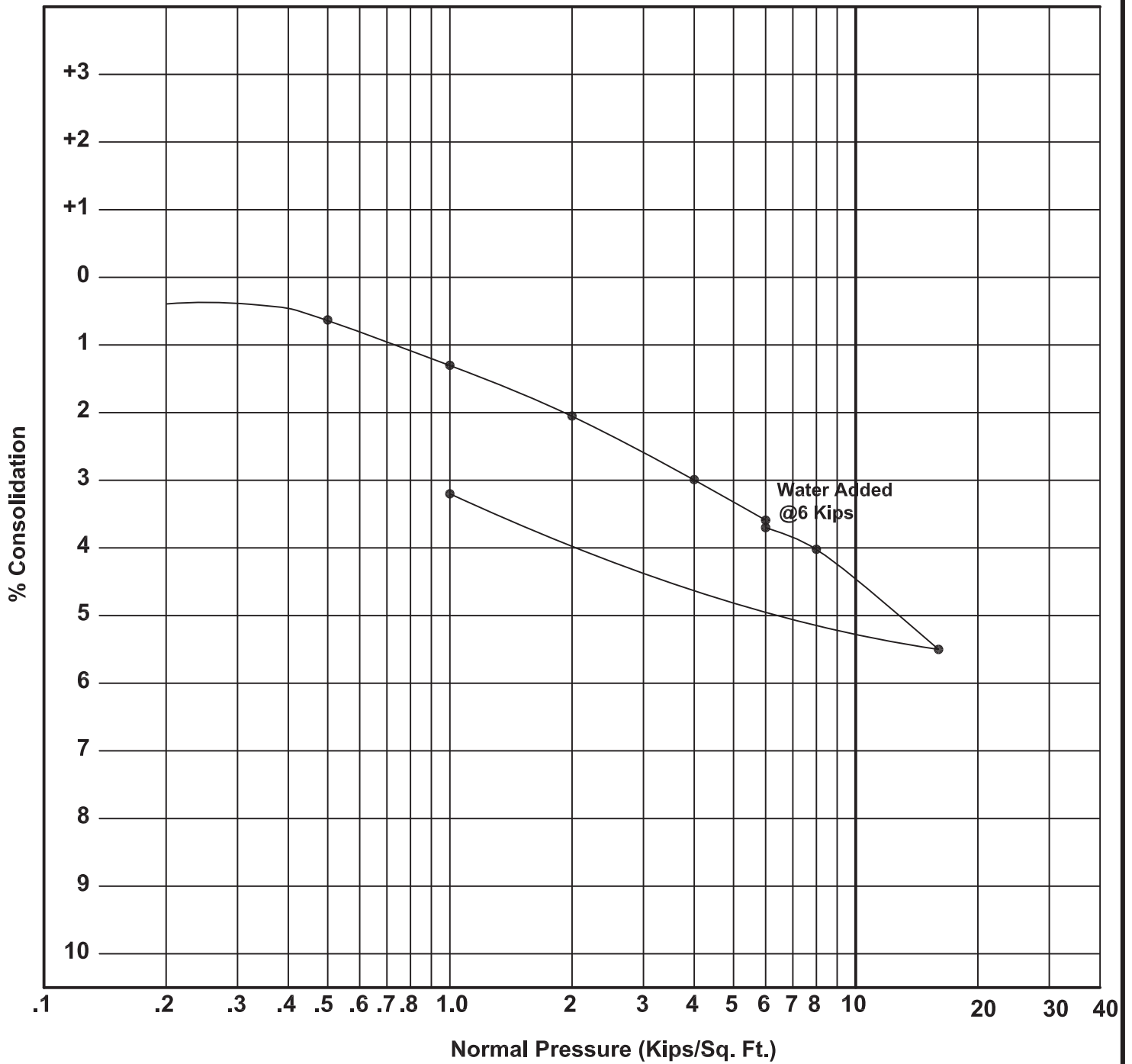

Project Skyline Ranch
 Location B82
 Depth 20'
 Material Landslide Debris - gravelly SAND



Geolabs - Westlake Village

GEOLOGY AND SOIL ENGINEERING

DATE 9/5/07 BY RMP
 SCALE NTS W.O. 8838

PLATE C82.20

CONSOLIDATION - PRESSURE CURVE

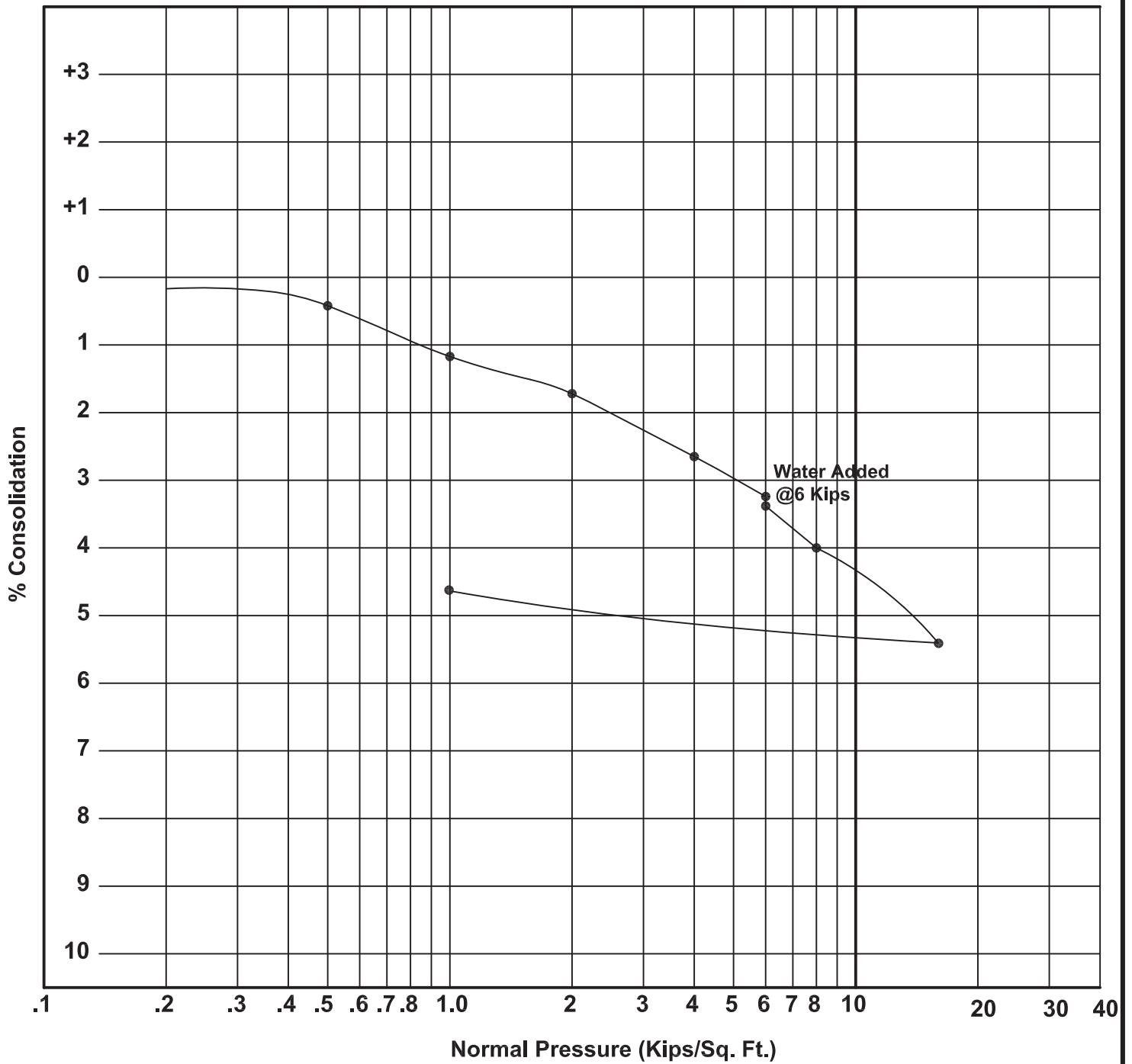

Project Skyline Ranch
Location B82
Depth 27'
Material Saugus Formation - clayey SILTSTONE



Geolabs - Westlake Village

GEOLOGY AND SOIL ENGINEERING

DATE 9/5/07 BY RMP
 SCALE NTS W.O. 8838

PLATE C82.27

CONSOLIDATION - PRESSURE CURVE

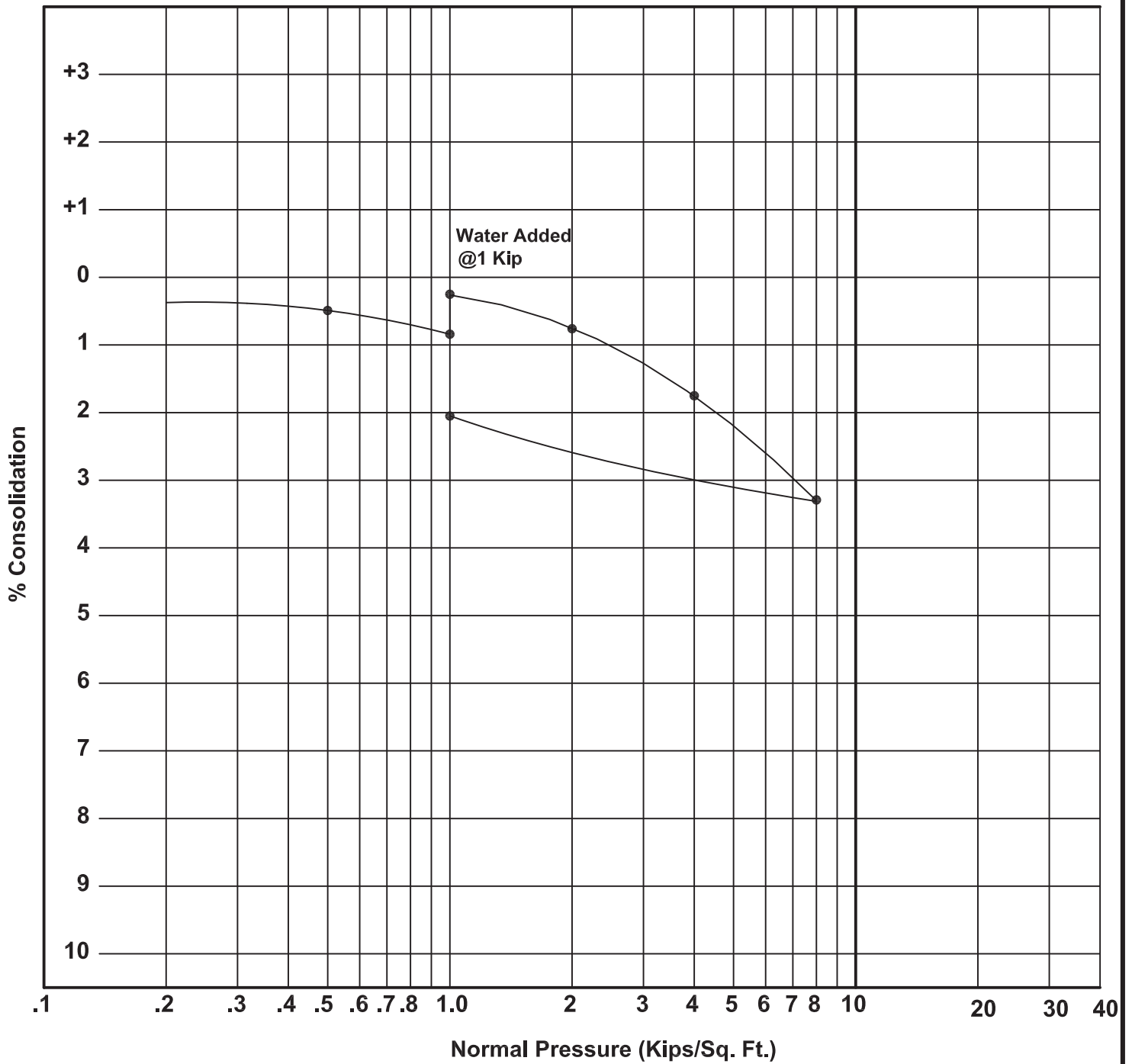

Project Skyline Ranch
Location B83
Depth 7'
Material Landslide Debris - sandy GRAVEL with silt



Geolabs - Westlake Village

GEOLOGY AND SOIL ENGINEERING

DATE 9/5/07 BY RMP
 SCALE NTS W.O. 8838

PLATE C83.7

CONSOLIDATION - PRESSURE CURVE

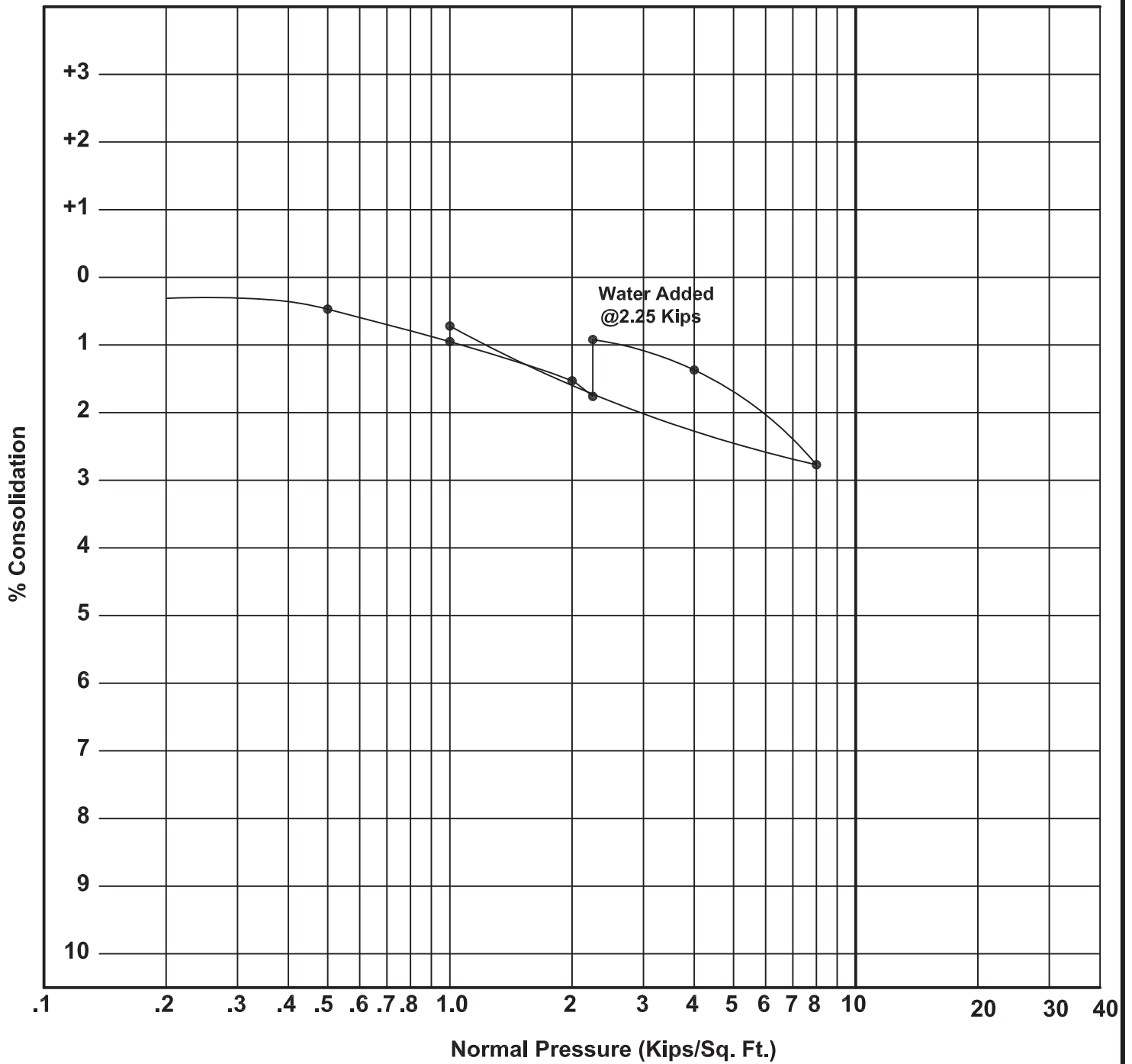

Project Skyline Ranch
Location B83
Depth 22'
Material Landslide Debris - silty CLAY and silty SAND



Geolabs - Westlake Village

GEOLOGY AND SOIL ENGINEERING

DATE 9/5/07 BY RMP
 SCALE NTS w.o. 8838

PLATE C83.22

CONSOLIDATION - PRESSURE CURVE

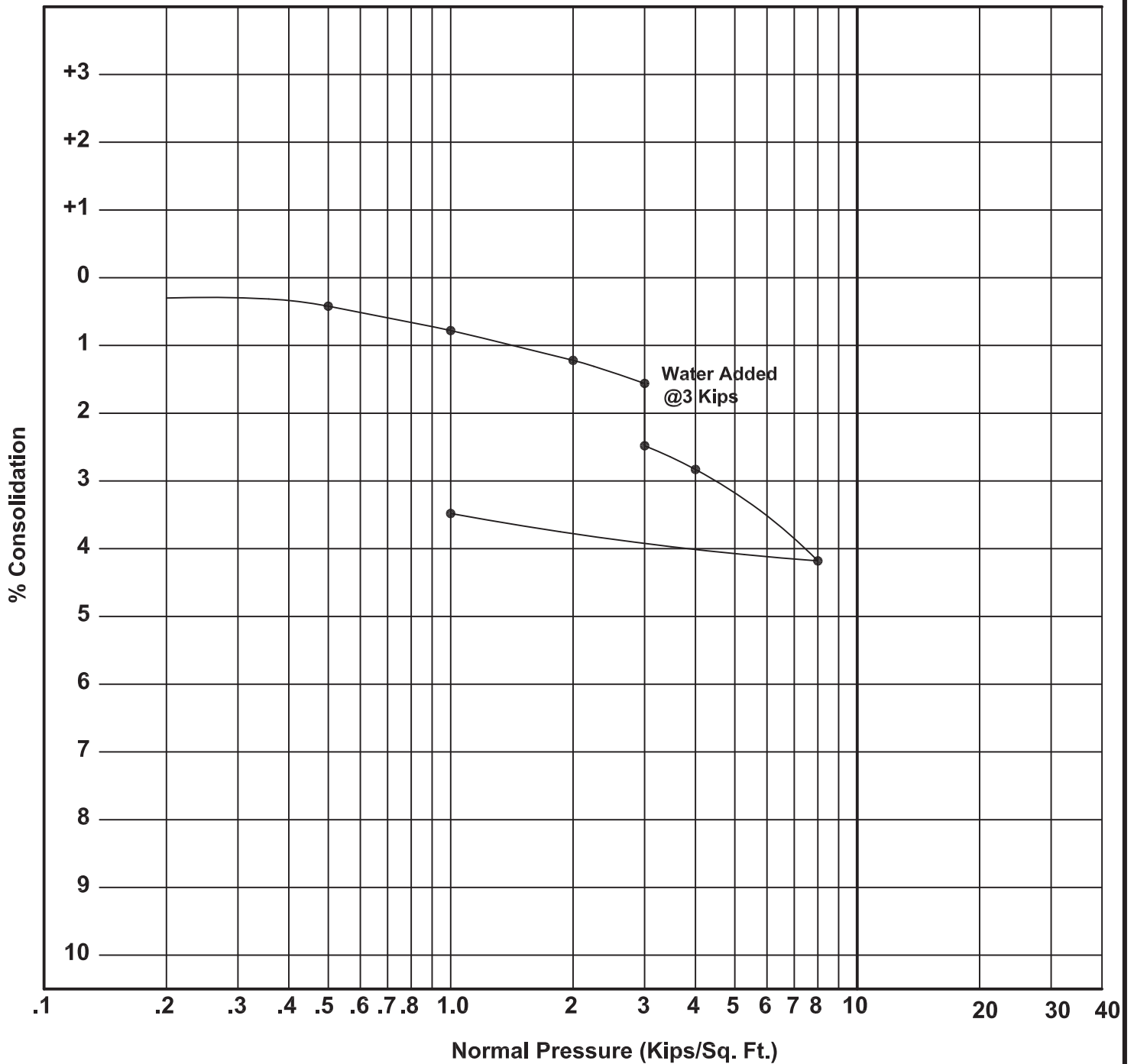

Project Skyline Ranch
Location B83
Depth 29'
Material Landslide Debris - sandy GRAVEL with clay



Geolabs - Westlake Village

GEOLOGY AND SOIL ENGINEERING

DATE 9/5/07 BY RMP
 SCALE NTS W.O. 8838

PLATE C83.29

CONSOLIDATION - PRESSURE CURVE

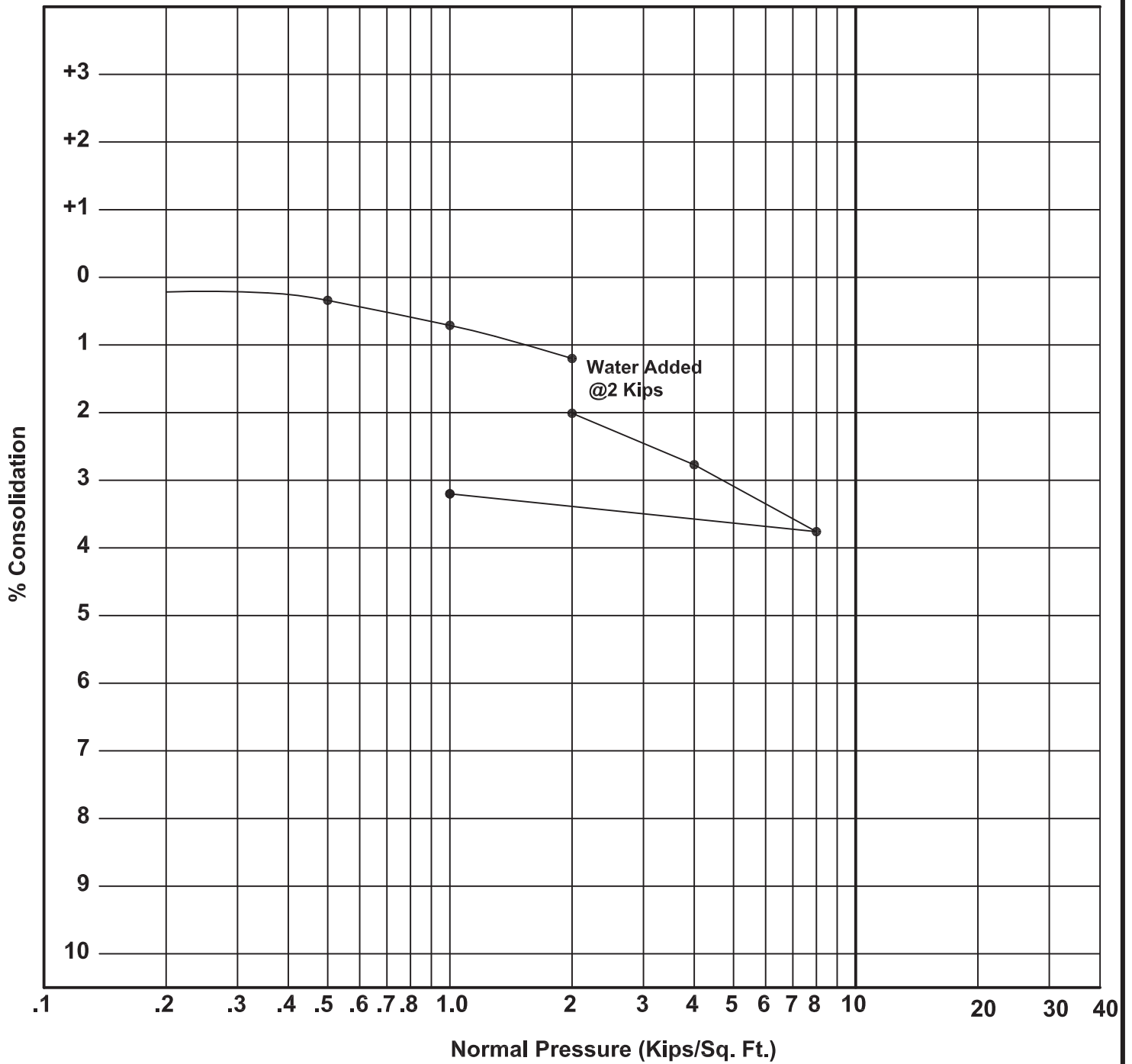

Project Skyline Ranch
Location B84
Depth 7'
Material Saugus Formation - gravelly SANDSTONE



Geolabs - Westlake Village

GEOLOGY AND SOIL ENGINEERING

DATE 9/5/07 BY RMP
 SCALE NTS w.o. 8838

PLATE C84.7

CONSOLIDATION - PRESSURE CURVE

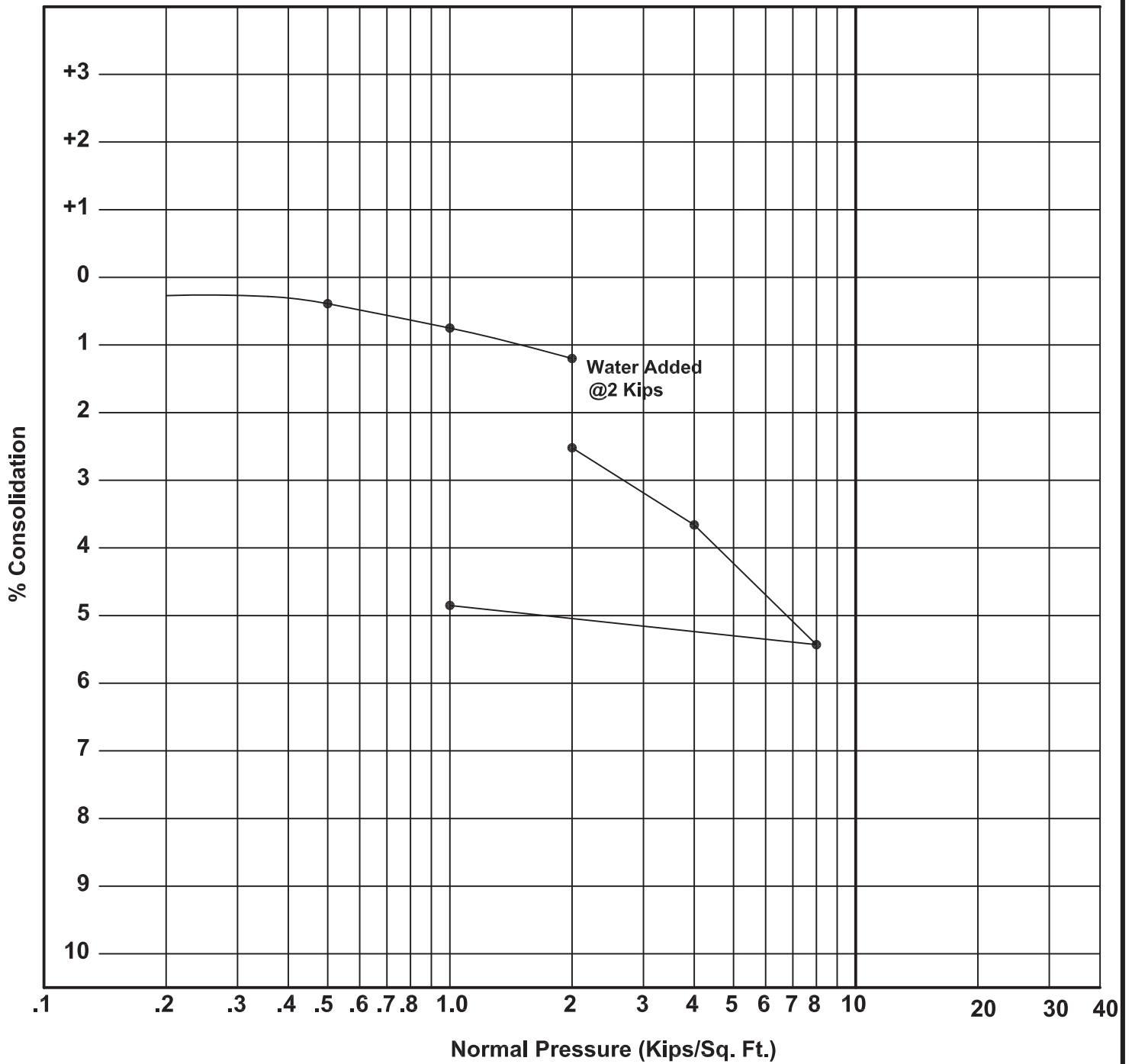

Project Skyline Ranch
Location B84
Depth 14'
Material Saugus Formation - gravelly SANDSTONE



Geolabs - Westlake Village

GEOLOGY AND SOIL ENGINEERING

DATE 9/5/07 BY RMP
 SCALE NTS w.o. 8838

PLATE C84.14

CONSOLIDATION - PRESSURE CURVE

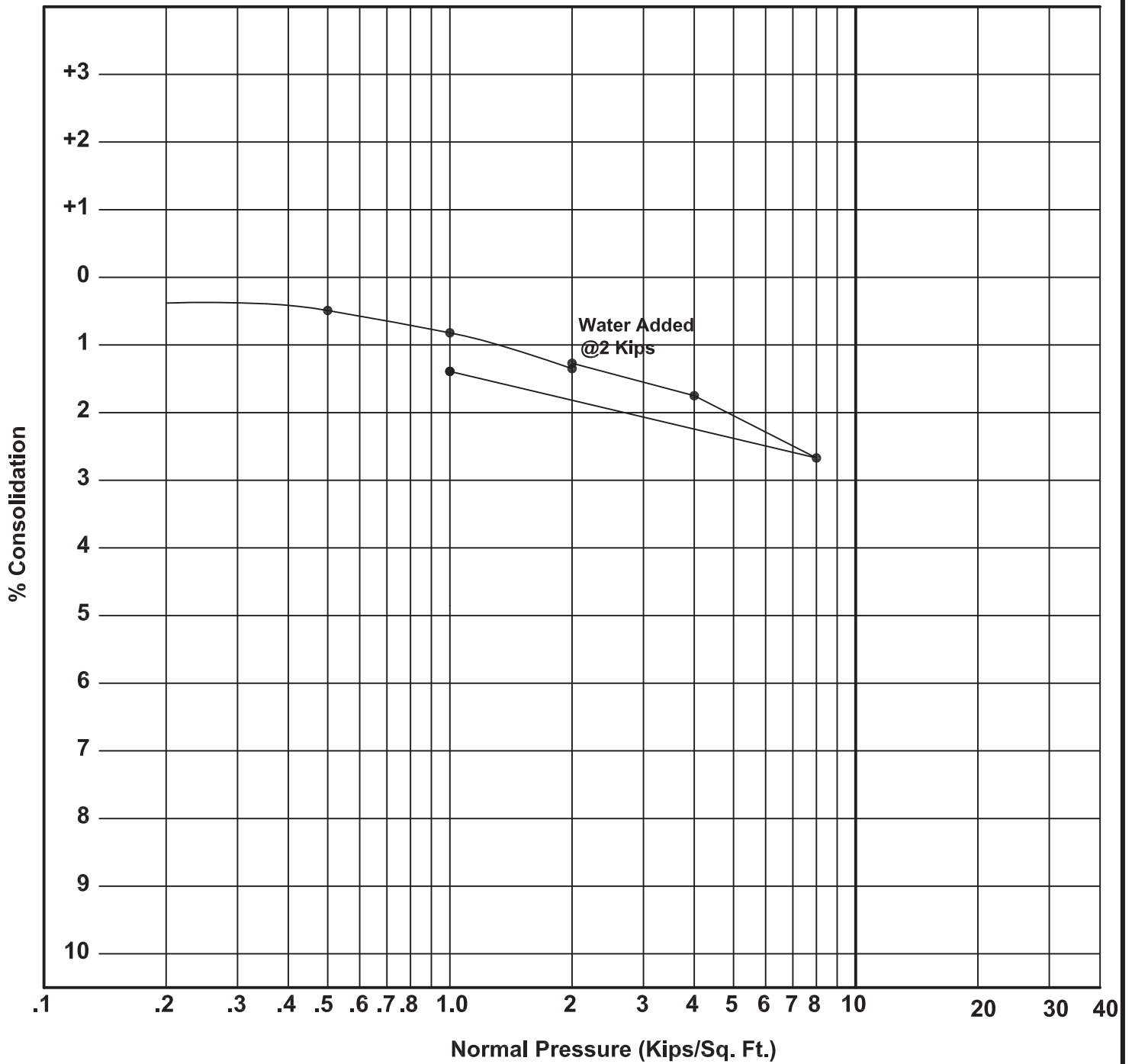

Project Skyline Ranch
Location B85
Depth 8'
Material Landslide Debris - clayey SAND with gvl



Geolabs - Westlake Village

GEOLOGY AND SOIL ENGINEERING

DATE 9/5/07 BY RMP
 SCALE NTS W.O. 8838

PLATE C85.8

CONSOLIDATION - PRESSURE CURVE

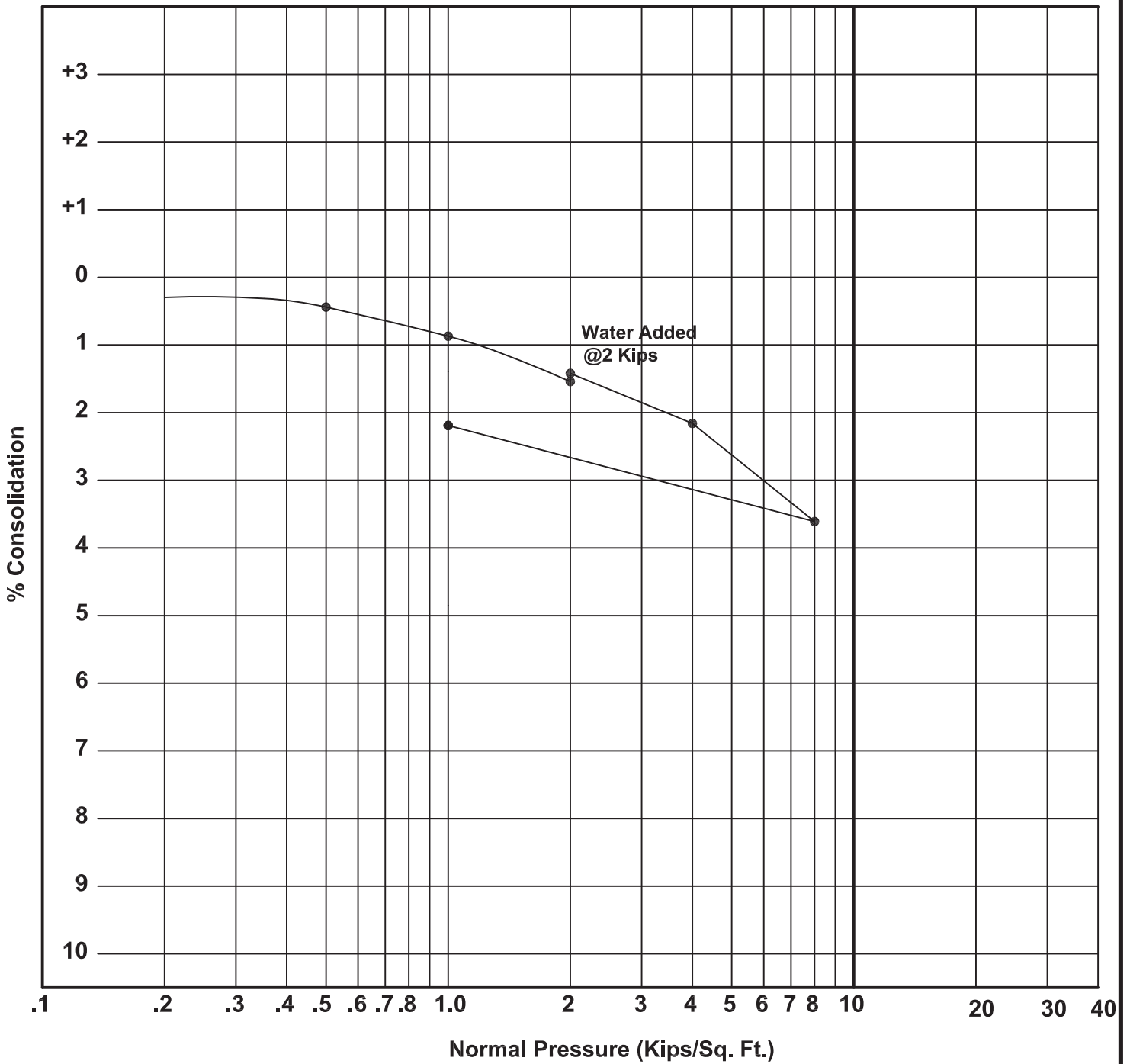

Project Skyline Ranch
Location B85
Depth 15'
Material Landslide Debris - silty SAND with clay



Geolabs - Westlake Village

GEOLOGY AND SOIL ENGINEERING

DATE 9/5/07 BY RMP
 SCALE NTS w.o. 8838

PLATE C85.15

CONSOLIDATION - PRESSURE CURVE

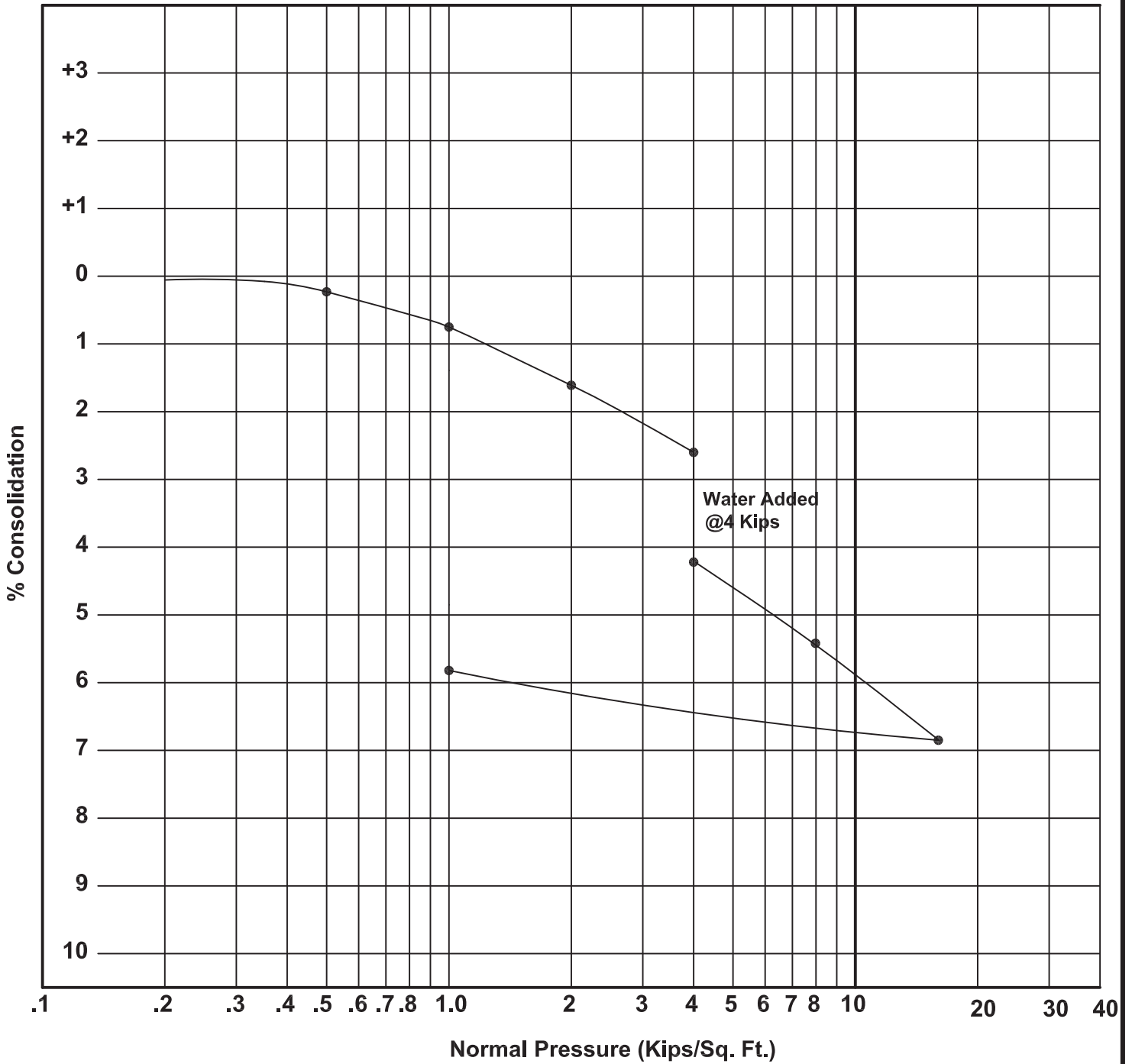

Project Skyline Ranch
Location B85
Depth 22'
Material Saugus Formation - gravelly SANDSTONE



Geolabs - Westlake Village

GEOLOGY AND SOIL ENGINEERING

DATE 9/5/07 BY RMP
 SCALE NTS W.O. 8838

PLATE C85.22

CONSOLIDATION - PRESSURE CURVE

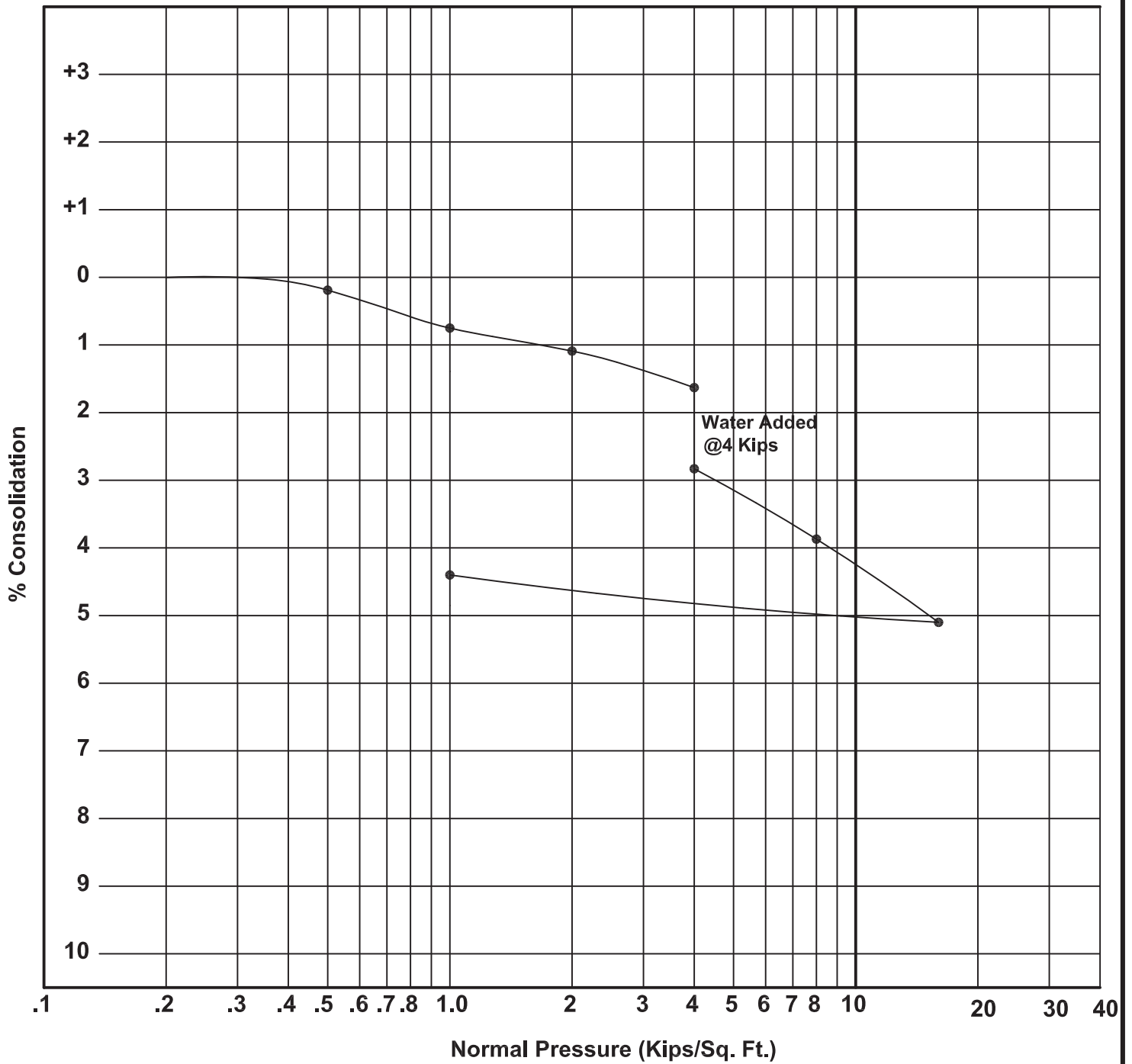

Project Skyline Ranch
 Location B85
 Depth 29'
 Material Saugus Formation - CONGLOMERATE



Geolabs - Westlake Village

GEOLOGY AND SOIL ENGINEERING

DATE 9/5/07 BY RMP
 SCALE NTS W.O. 8838

PLATE C85.29

CONSOLIDATION - PRESSURE CURVE

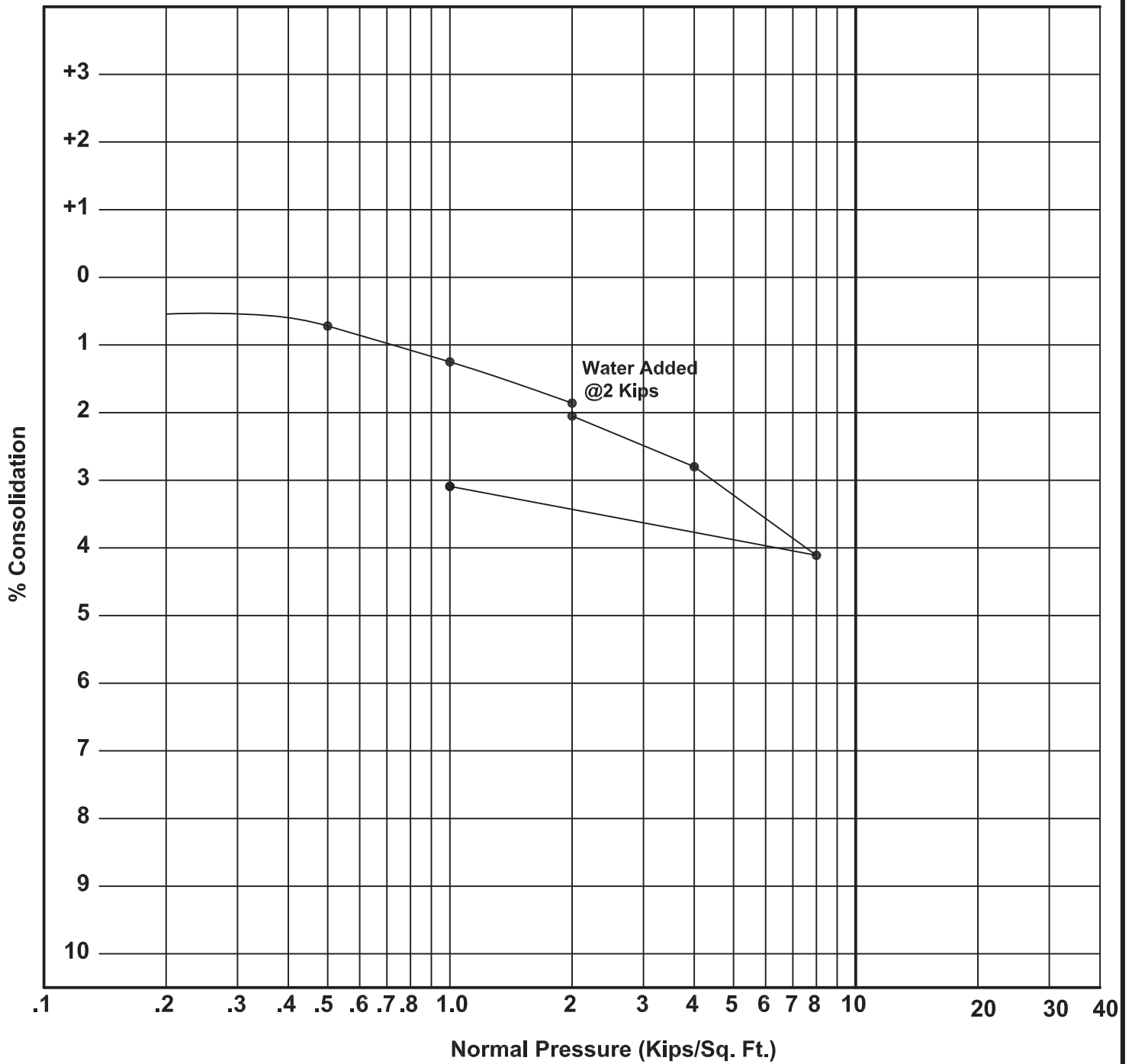

Project Skyline Ranch
Location B86
Depth 7'
Material Landslide Debris - clayey SAND with gvl



Geolabs - Westlake Village

GEOLOGY AND SOIL ENGINEERING

DATE 9/5/07 BY RMP
 SCALE NTS w.o. 8838

PLATE C86.7

CONSOLIDATION - PRESSURE CURVE

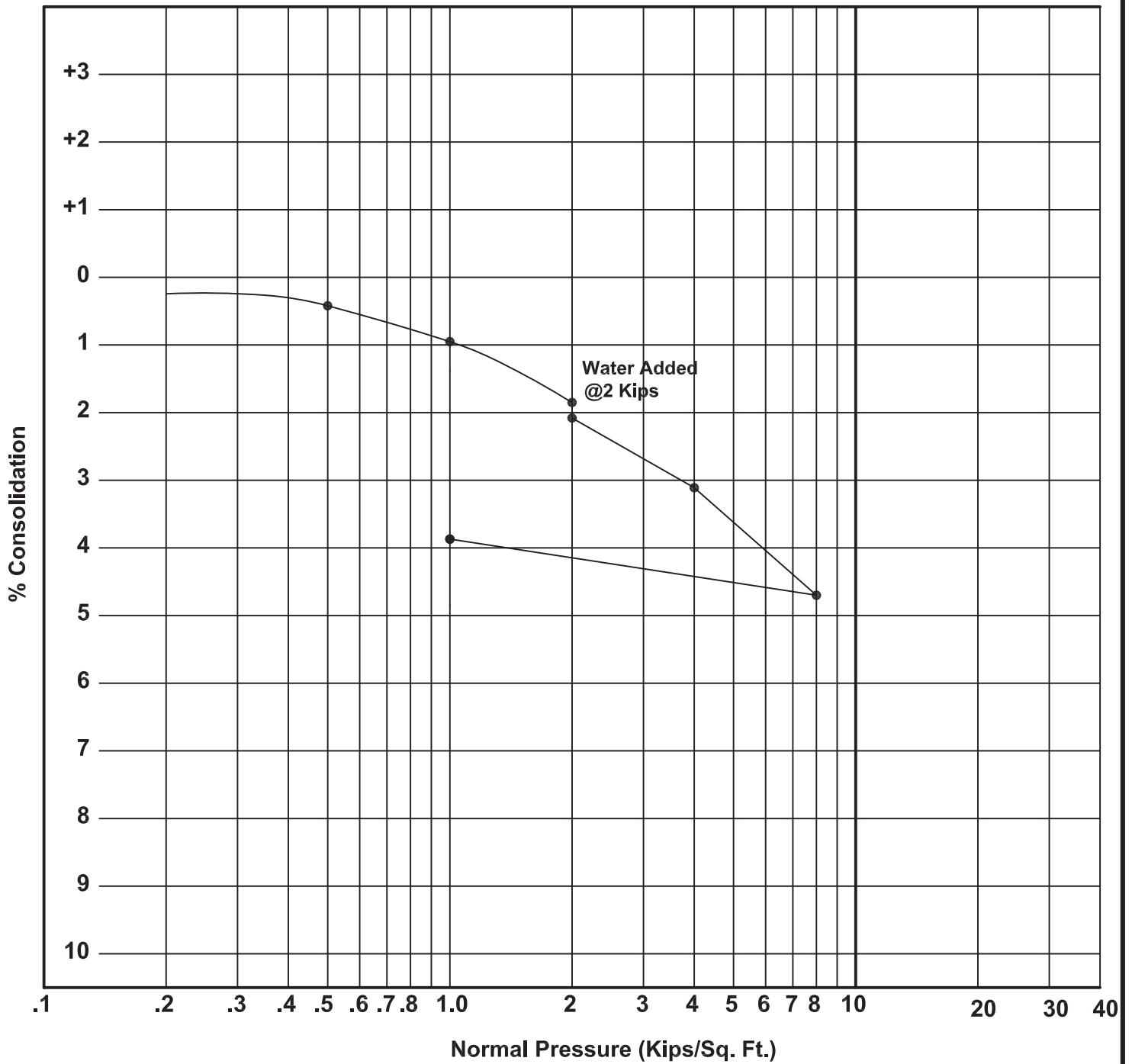

Project Skyline Ranch
Location B86
Depth 14'
Material Landslide Debris - silty SAND with gvl



Geolabs - Westlake Village

GEOLOGY AND SOIL ENGINEERING

DATE 9/5/07 BY RMP
 SCALE NTS W.O. 8838

PLATE C86.14

CONSOLIDATION - PRESSURE CURVE

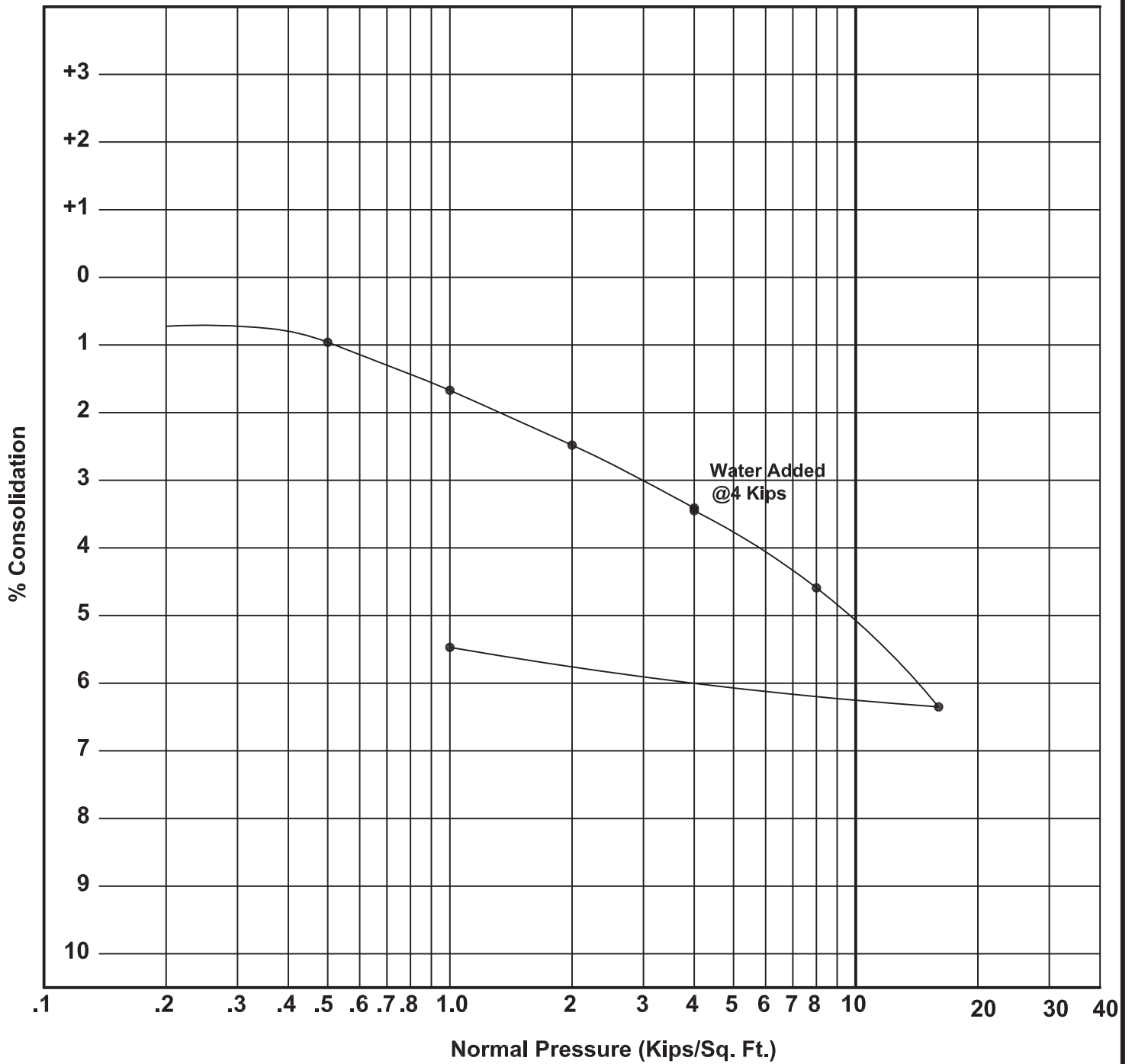

Project Skyline Ranch
Location B86
Depth 22'
Material Landslide Debris - silty SAND and silty CLAY



Geolabs - Westlake Village

GEOLGY AND SOIL ENGINEERING

DATE 9/5/07 BY RMP
 SCALE NTS w.o. 8838

PLATE C86.22

CONSOLIDATION - PRESSURE CURVE

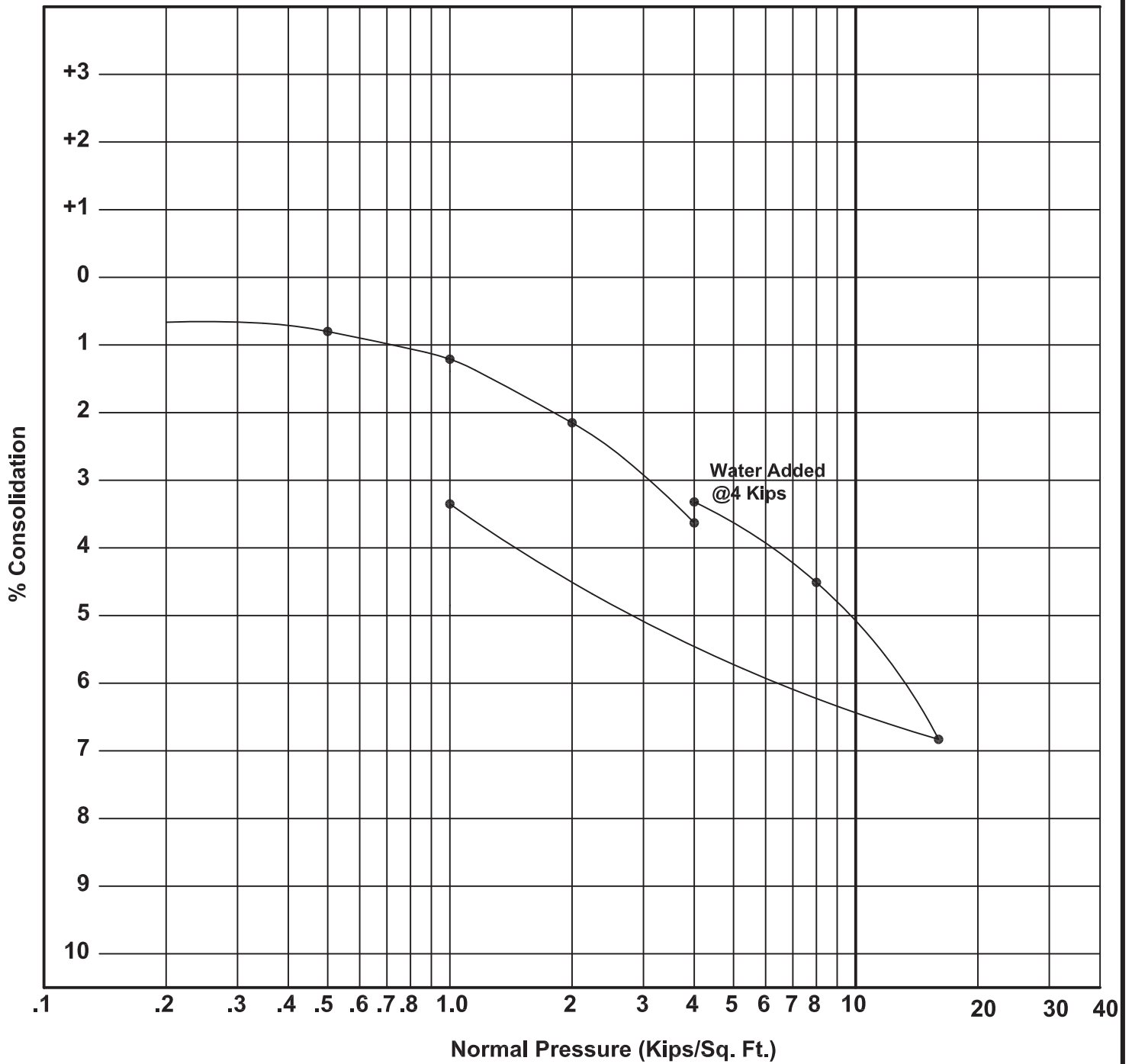

Project Skyline Ranch
Location B86
Depth 29'
Material Landslide Debris - SAND with trace gvl



Geolabs - Westlake Village

GEOLOGY AND SOIL ENGINEERING

DATE 9/5/07 BY RMP
 SCALE NTS W.O. 8838

PLATE C86.29

CONSOLIDATION - PRESSURE CURVE

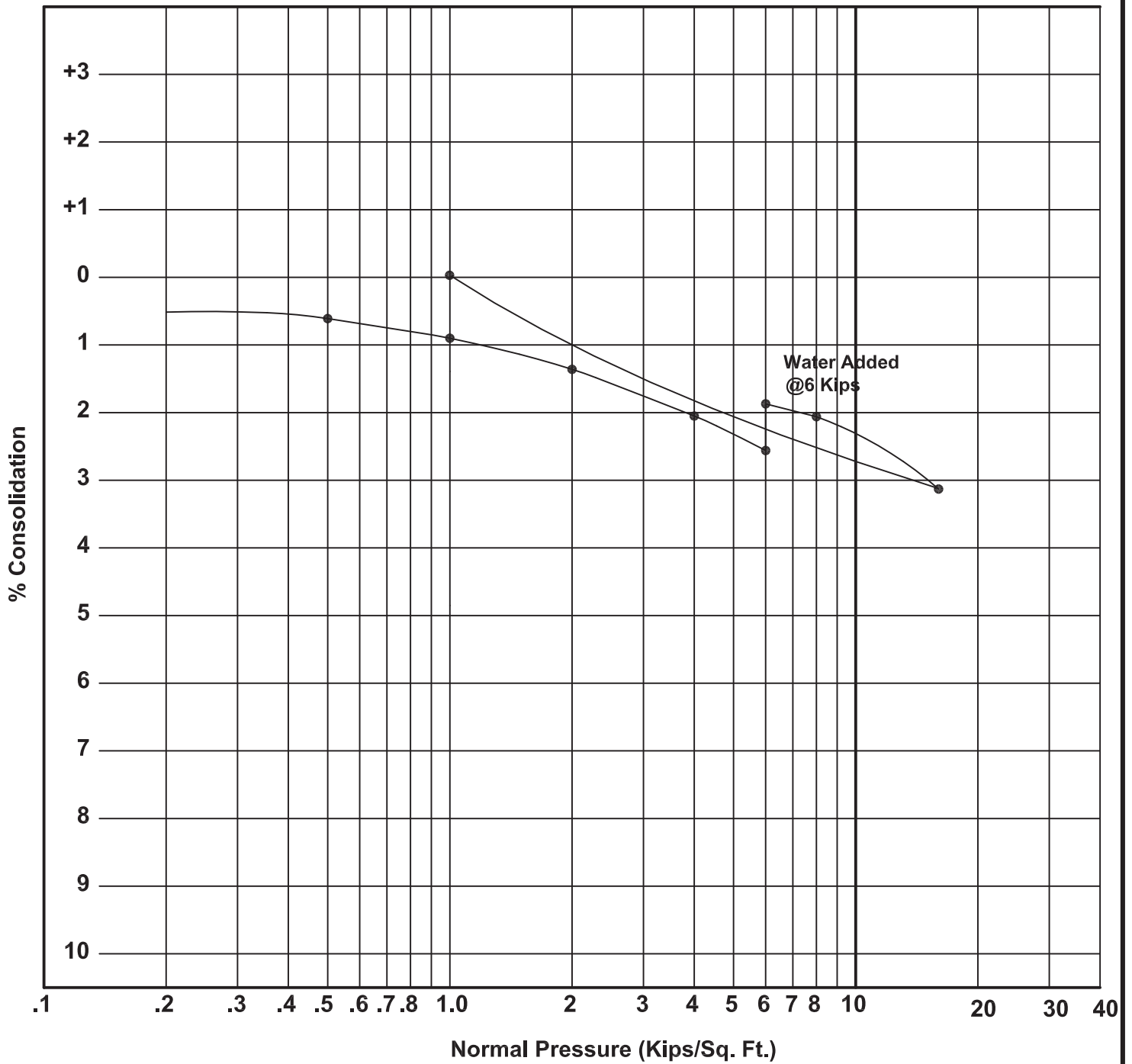

Project Skyline Ranch
Location B86
Depth 35'
Material Saugus Formation - clayey SANDSTONE



Geolabs - Westlake Village

GEOLOGY AND SOIL ENGINEERING

DATE 9/5/07 BY RMP
 SCALE NTS w.o. 8838

PLATE C86.35

CONSOLIDATION - PRESSURE CURVE

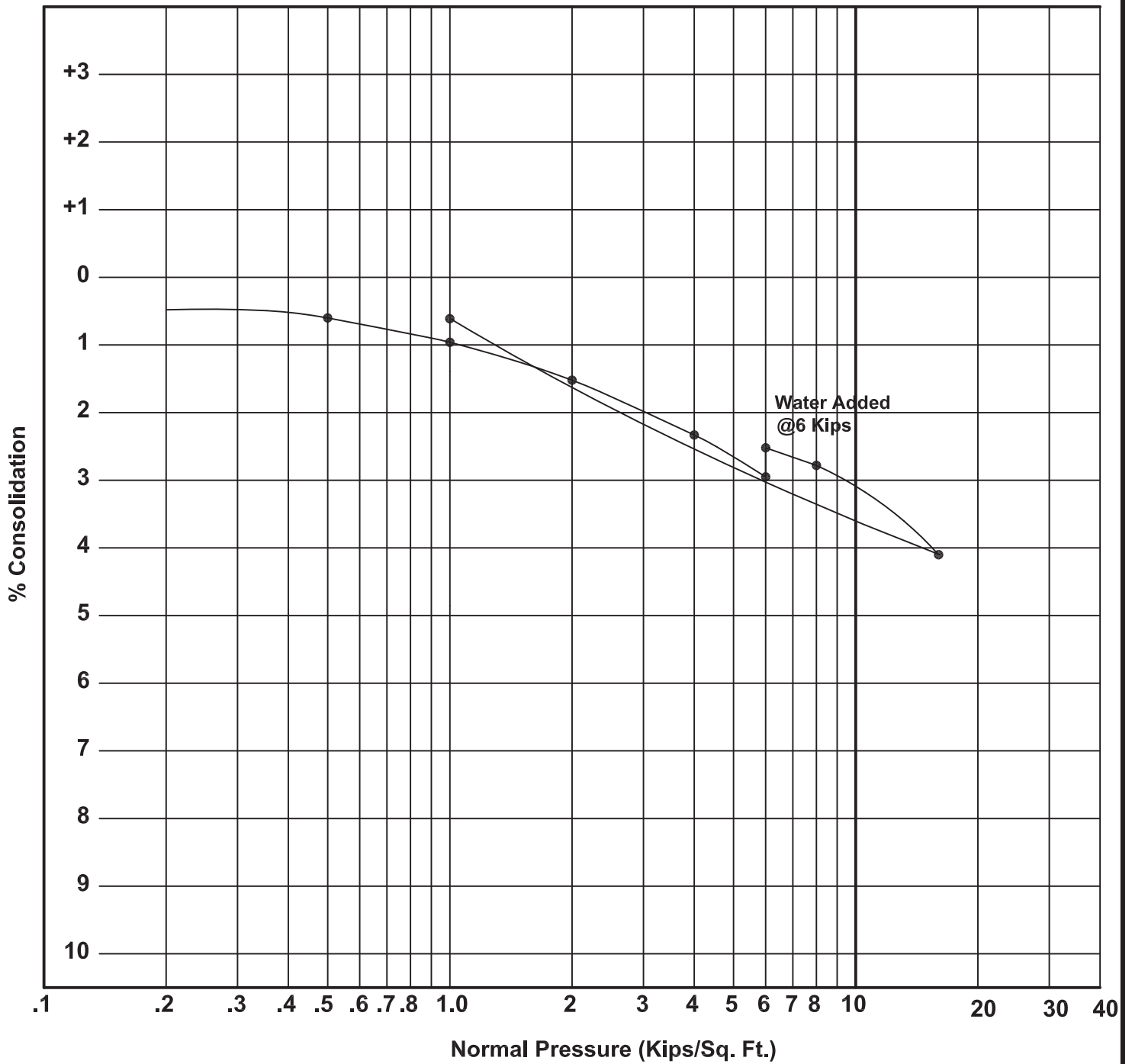

Project Skyline Ranch
Location B86
Depth 40'
Material Saugus Formation - silty fine SANDSTONE



Geolabs - Westlake Village

GEOLOGY AND SOIL ENGINEERING

DATE 9/5/07 BY RMP
 SCALE NTS w.o. 8838

PLATE C86.40

CONSOLIDATION - PRESSURE CURVE

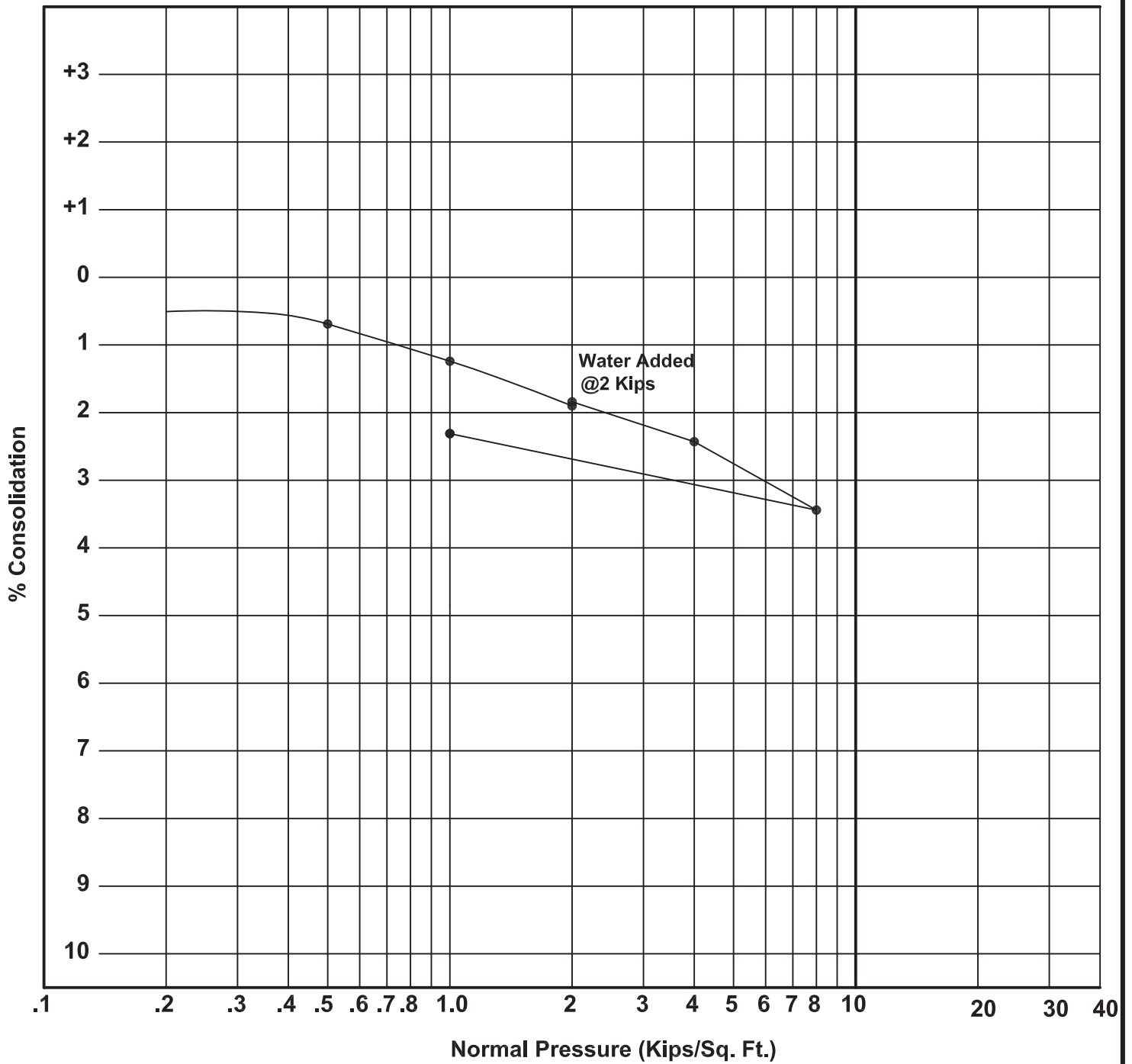

Project Skyline Ranch
Location B88
Depth 20'
Material Landslide Debris - clayey SAND with gvl



Geolabs - Westlake Village

GEOLOGY AND SOIL ENGINEERING

DATE 9/5/07 BY RMP
 SCALE NTS W.O. 8838

PLATE C88.20

CONSOLIDATION - PRESSURE CURVE

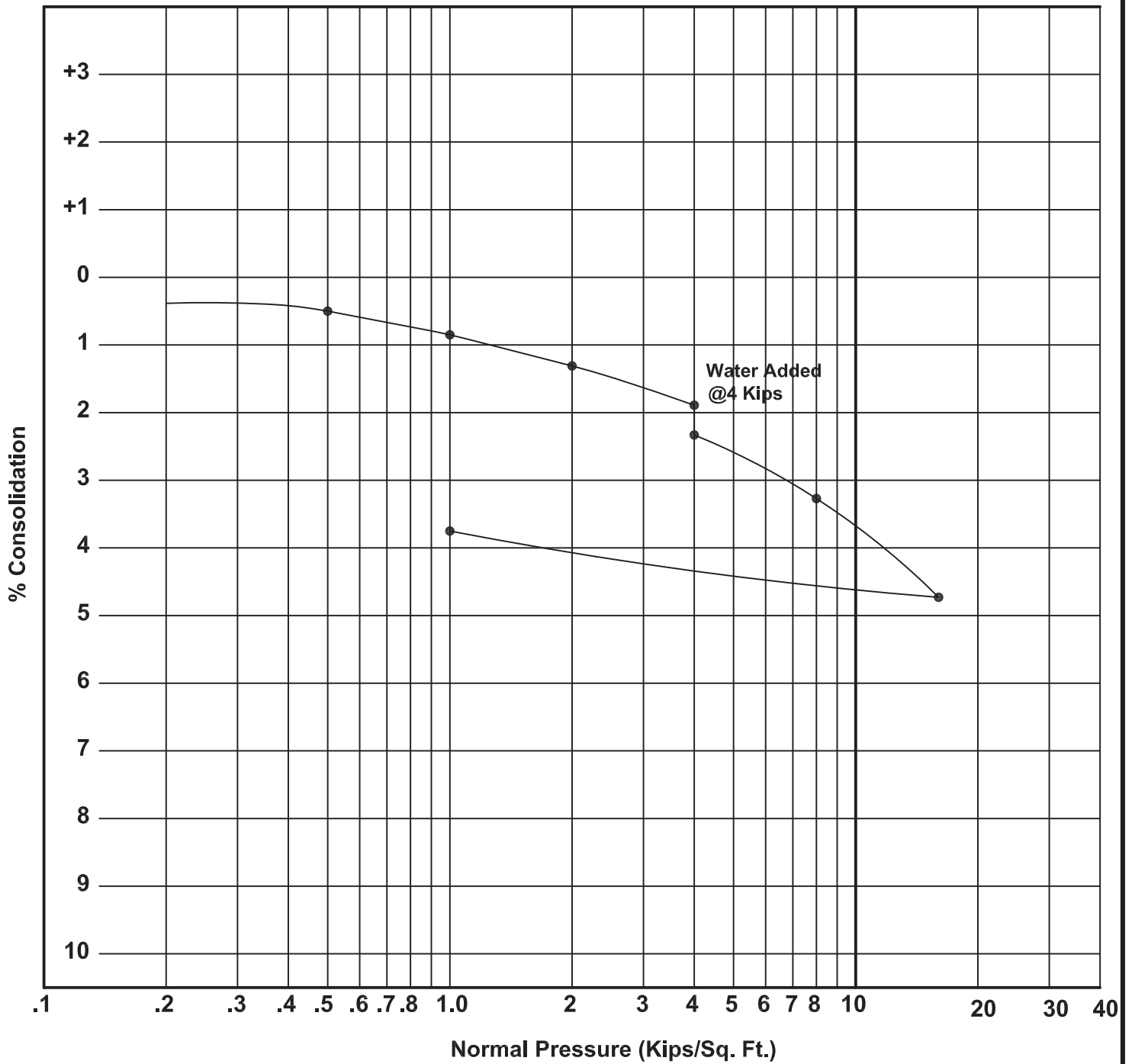

Project Skyline Ranch
Location B88
Depth 40'
Material Landslide Debris - silty SAND and GRAVEL



Geolabs - Westlake Village

GEOLOGY AND SOIL ENGINEERING

DATE 9/5/07 BY RMP
 SCALE NTS w.o. 8838

PLATE C88.40

CONSOLIDATION - PRESSURE CURVE

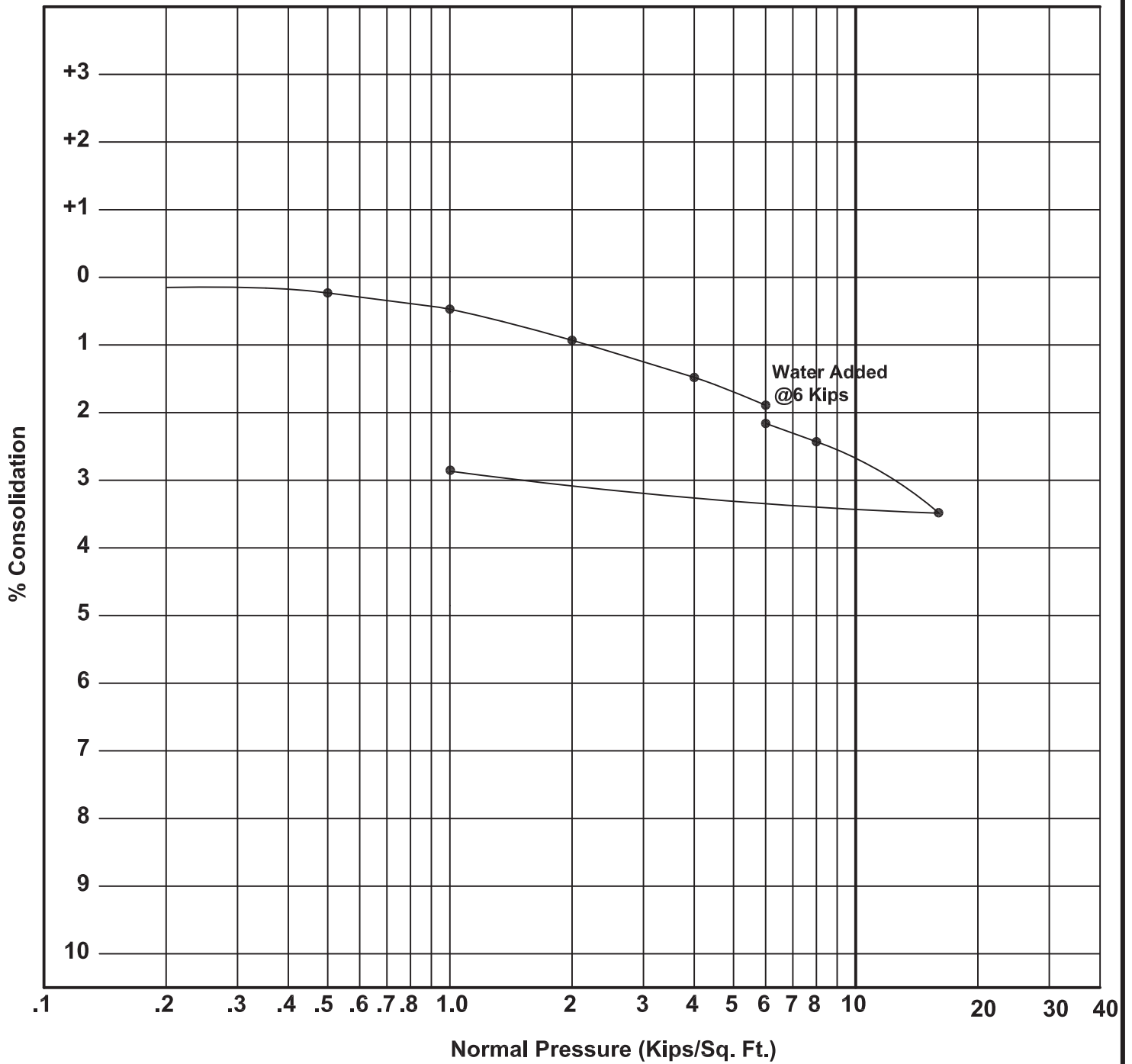

Project Skyline Ranch
Location B88
Depth 60'
Material Saugus Formation - SANDSTONE and CLAYSTONE



Geolabs - Westlake Village

GEOLOGY AND SOIL ENGINEERING

DATE 9/5/07 BY RMP
 SCALE NTS w.o. 8838

PLATE C88.60

CONSOLIDATION - PRESSURE CURVE

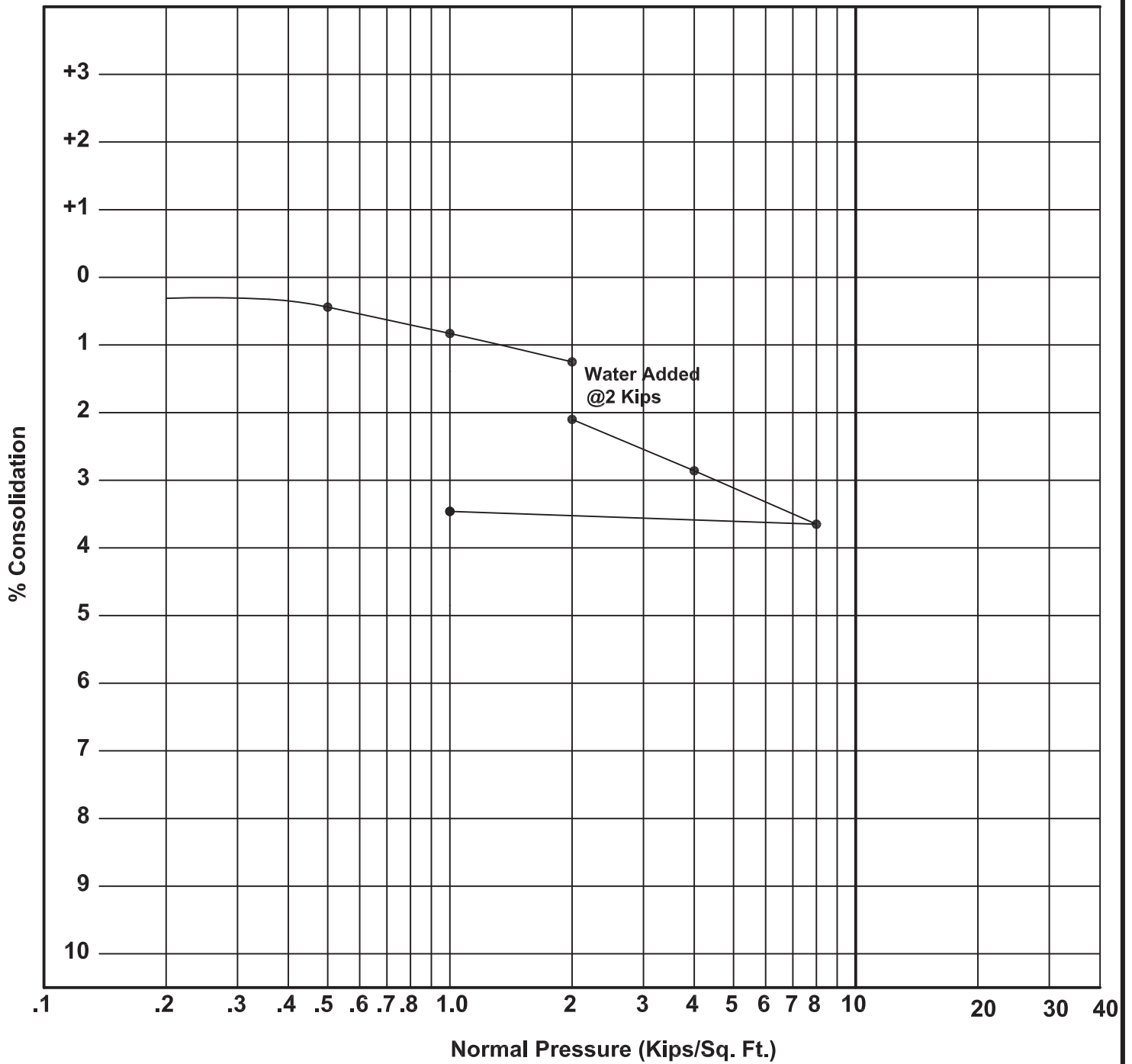

Project Skyline Ranch
Location B89
Depth 19'
Material Landslide Debris - gravelly SAND



Geolabs - Westlake Village

GEOLOGY AND SOIL ENGINEERING

DATE 9/5/07 BY RMP
 SCALE NTS W.O. 8838

PLATE C89.19

CONSOLIDATION - PRESSURE CURVE

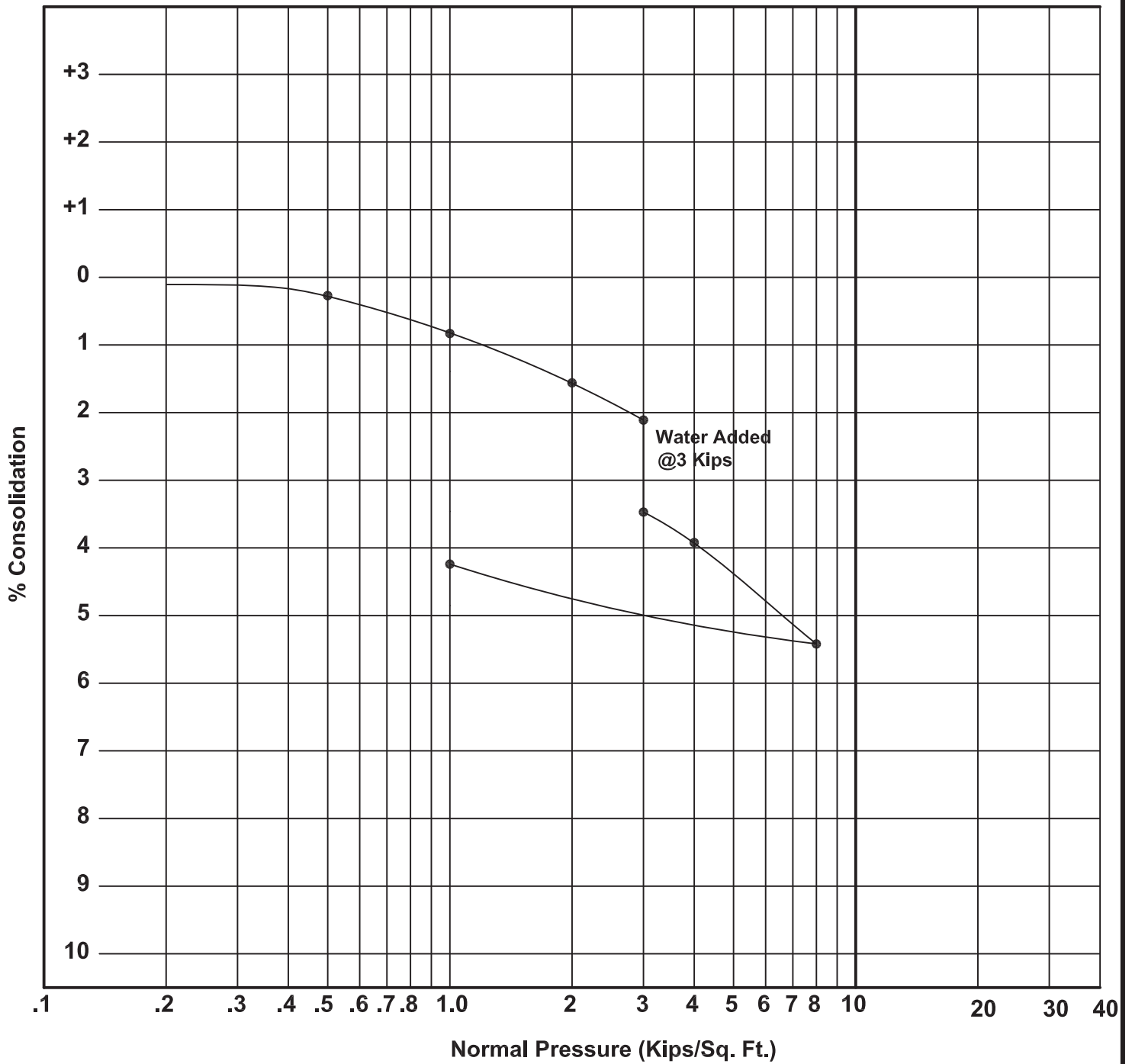

Project Skyline Ranch
Location B89
Depth 31'
Material Landslide Debris - clayey SAND and SILT with gv



Geolabs - Westlake Village

GEOLOGY AND SOIL ENGINEERING

DATE 9/5/07 BY RMP
 SCALE NTS W.O. 8838

PLATE C89.31

CONSOLIDATION - PRESSURE CURVE

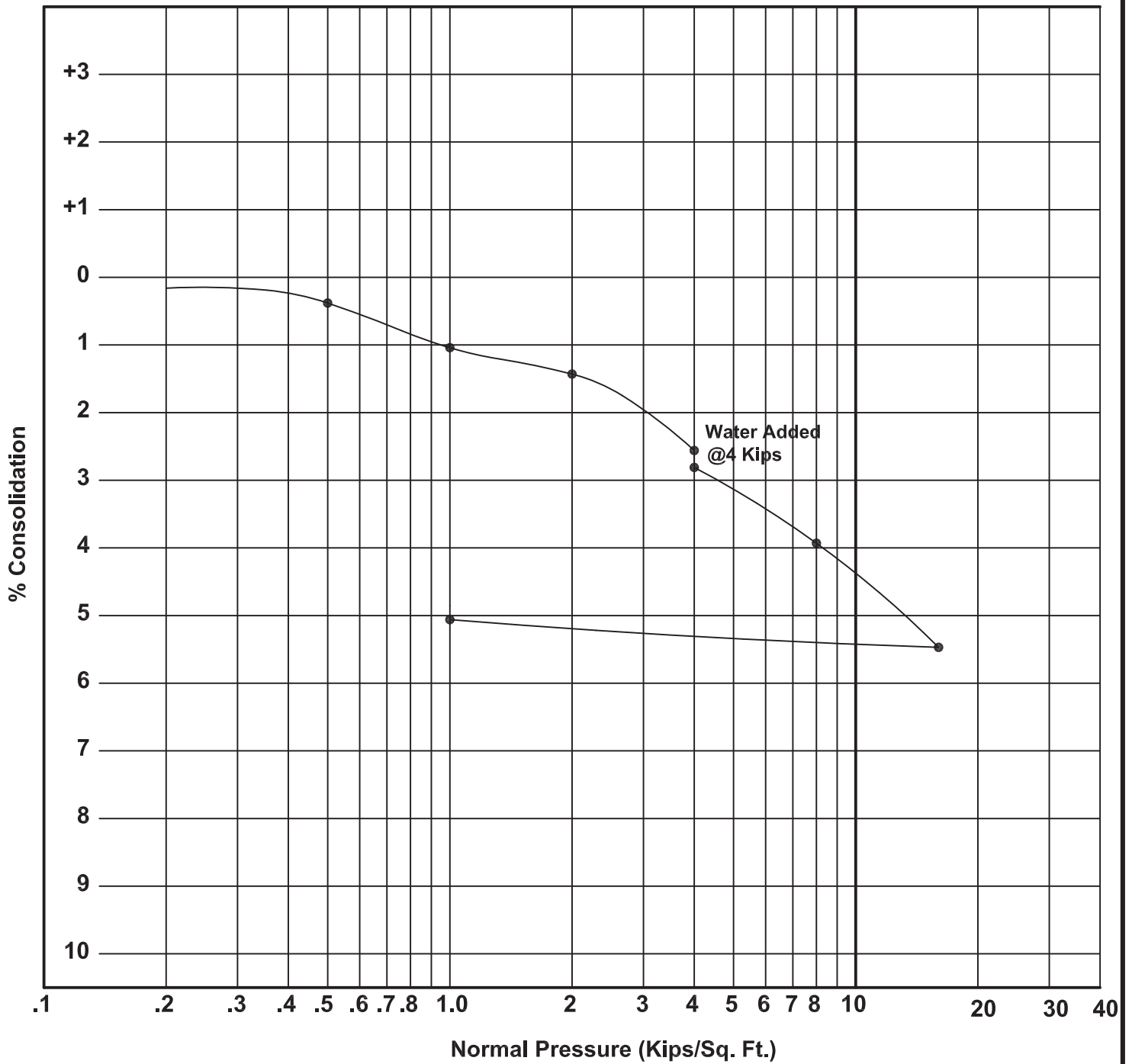

Project Skyline Ranch
Location B89
Depth 40'
Material Landslide Debris - clayey SAND with gvl



Geolabs - Westlake Village

GEOLOGY AND SOIL ENGINEERING

DATE 9/5/07 BY RMP
 SCALE NTS W.O. 8838

PLATE C89.40

CONSOLIDATION - PRESSURE CURVE

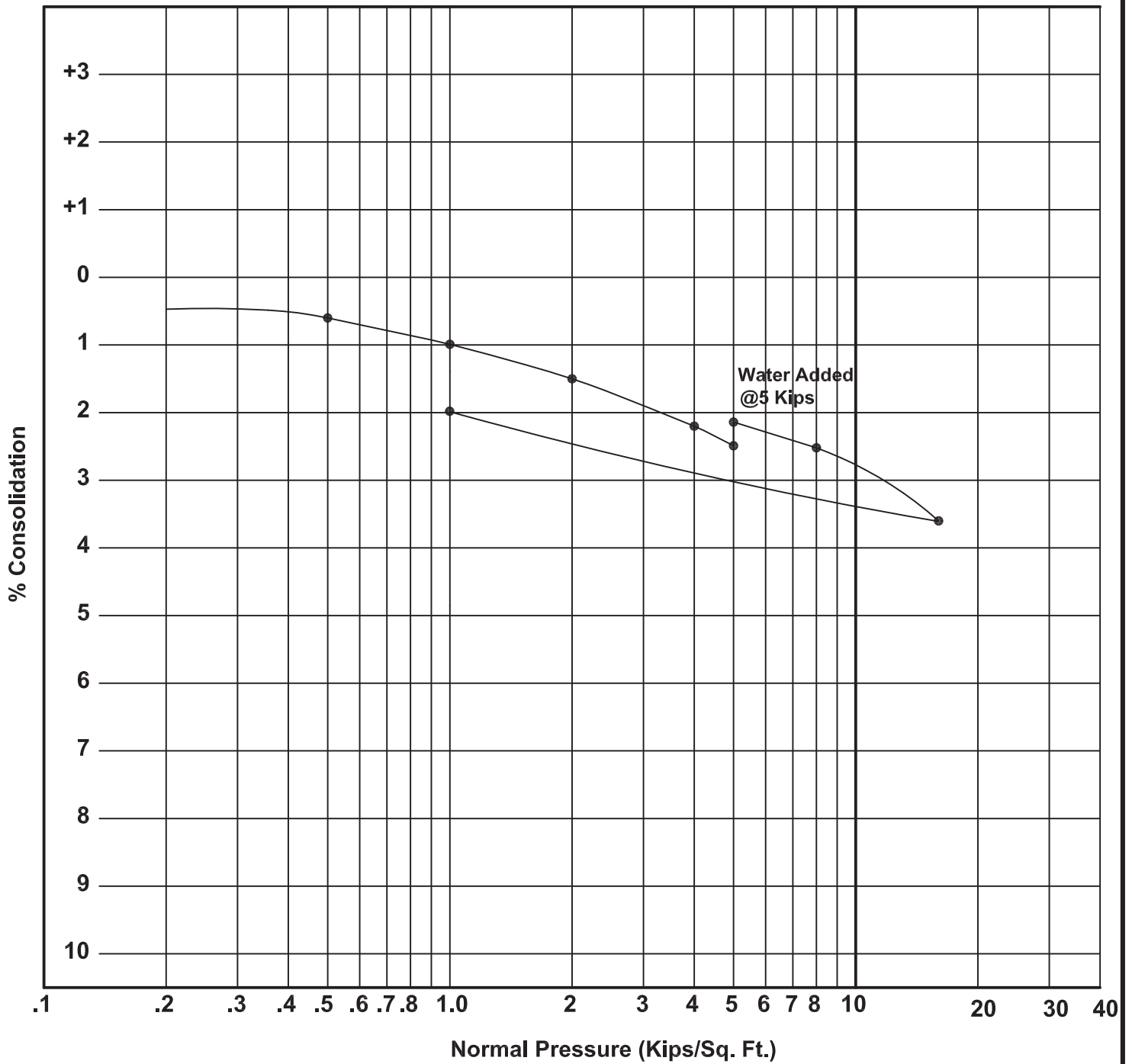

Project Skyline Ranch
Location B89
Depth 50'
Material Landslide Debris - clayey SAND with gvl



Geolabs - Westlake Village

GEOLOGY AND SOIL ENGINEERING

DATE 9/5/07 BY RMP
 SCALE NTS W.O. 8838

PLATE C89.50

CONSOLIDATION - PRESSURE CURVE

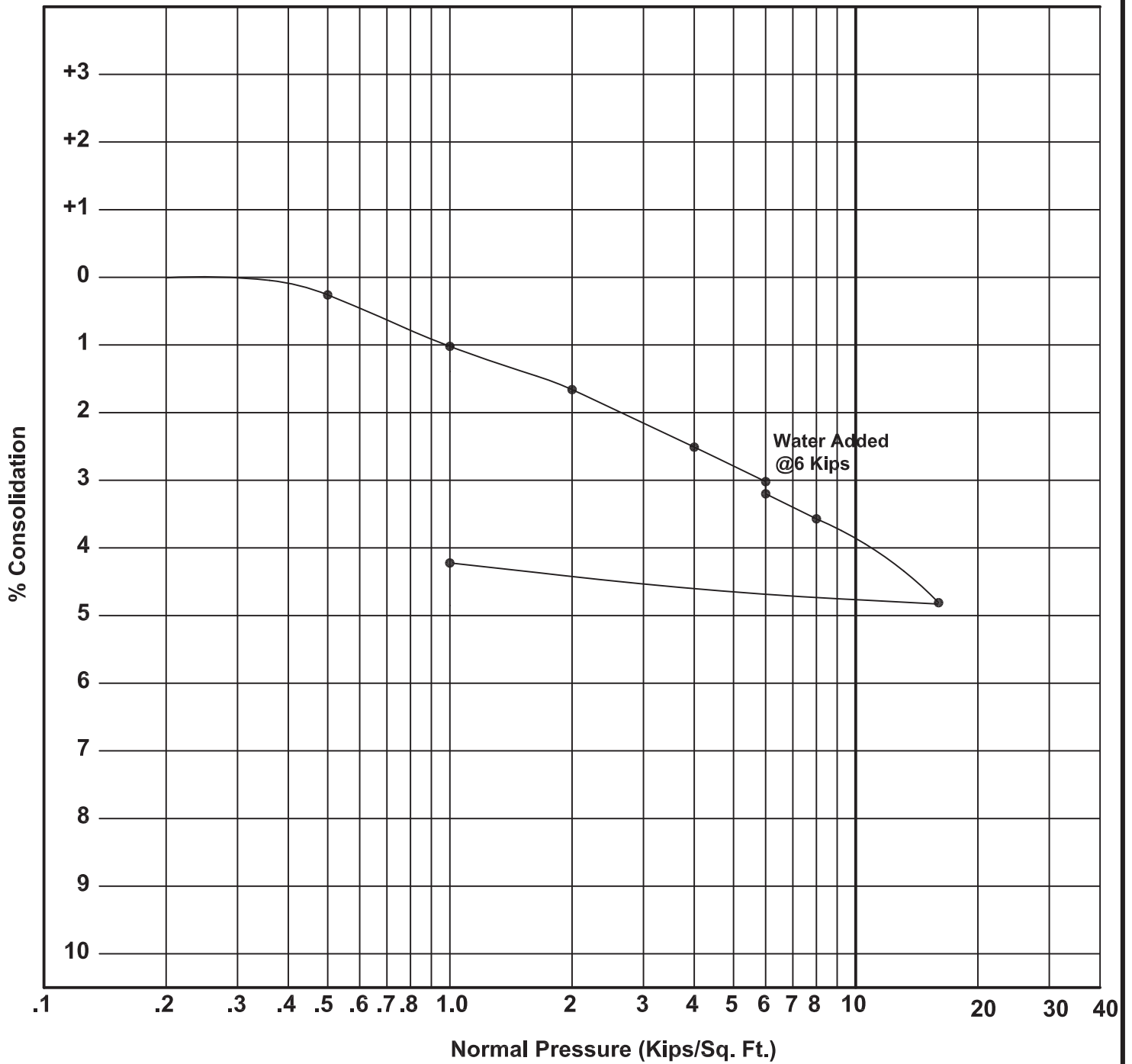

Project Skyline Ranch
 Location B89
 Depth 60'
 Material Saugus Formation - gravelly SANDSTONE



Geolabs - Westlake Village

GEOLOGY AND SOIL ENGINEERING

DATE 9/5/07 BY RMP
 SCALE NTS w.o. 8838

PLATE C89.60

CONSOLIDATION - PRESSURE CURVE

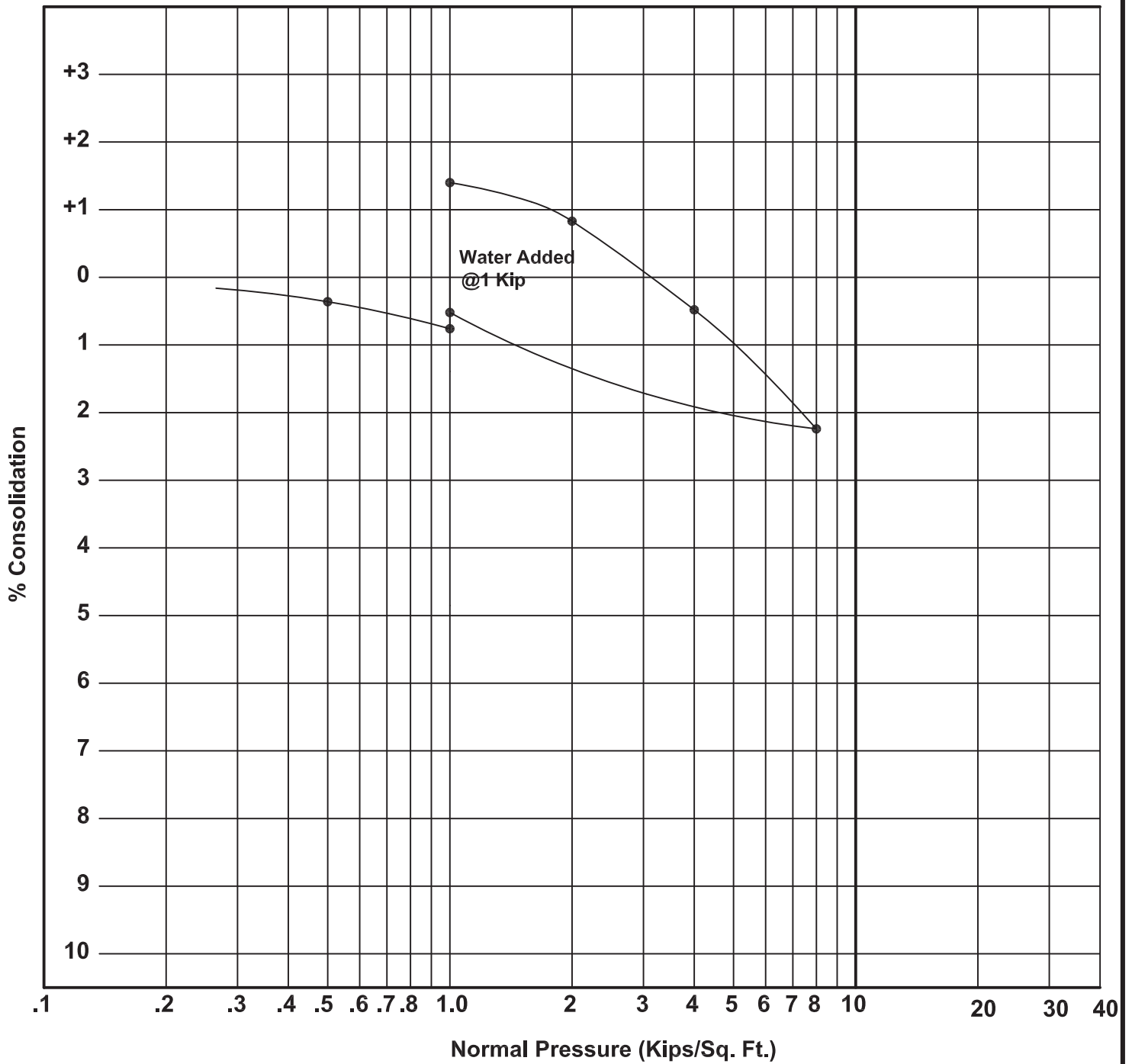

Project Skyline Ranch
Location B90
Depth 10'
Material Landslide Debris - gravelly SAND



Geolabs - Westlake Village

GEOLOGY AND SOIL ENGINEERING

DATE 9/5/07 BY RMP
 SCALE NTS W.O. 8838

PLATE C90.10

CONSOLIDATION - PRESSURE CURVE

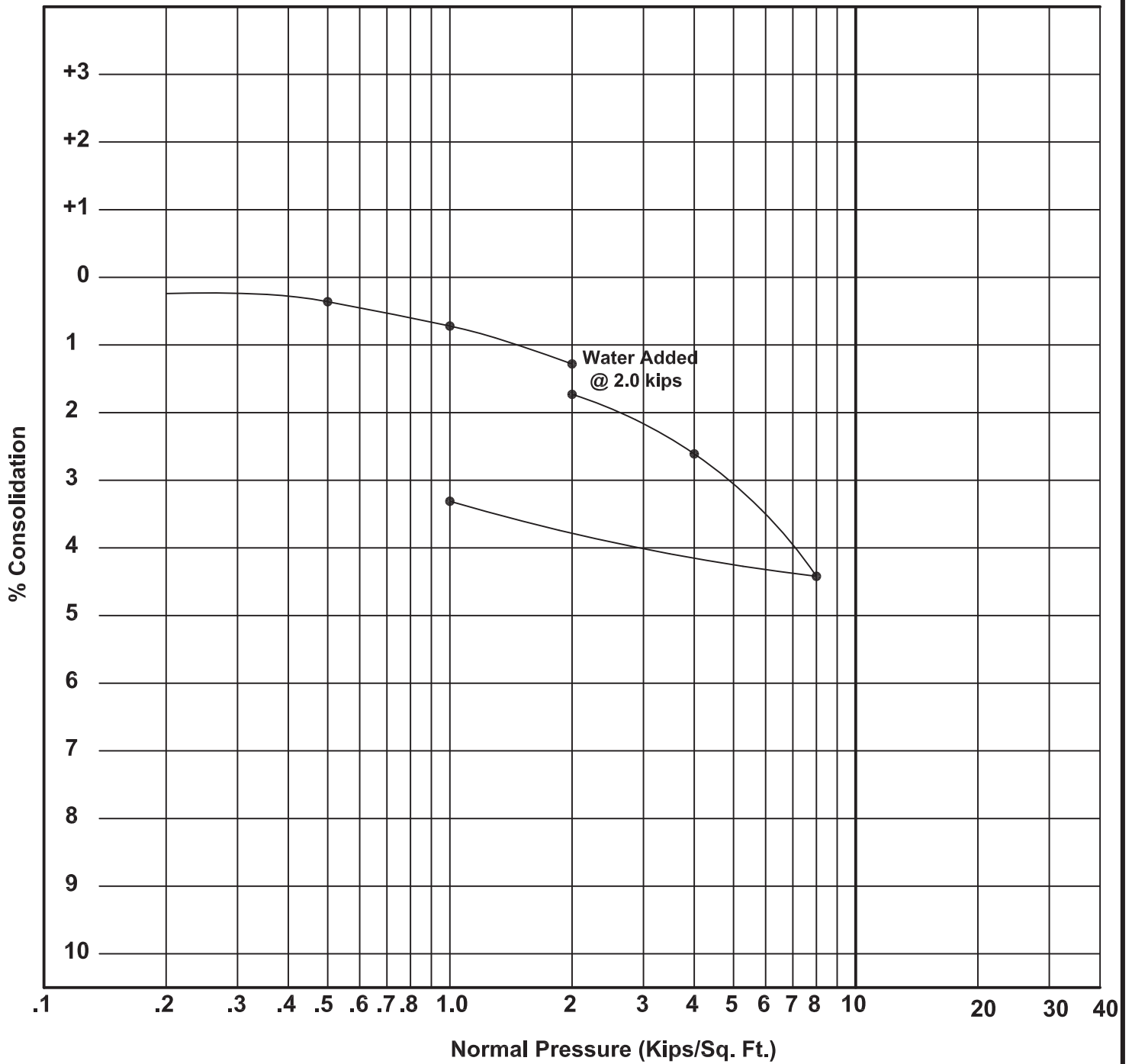

Project Tr. 060922 Skyline Ranch
Location B90
Depth 20 feet
Material Landslide Debris - Clayey SAND



Geolabs - Westlake Village
 GEOLOGY AND SOIL ENGINEERING

DATE _____ BY DS
 SCALE _____ w.o. 8838

PLATE C90.20

CONSOLIDATION - PRESSURE CURVE

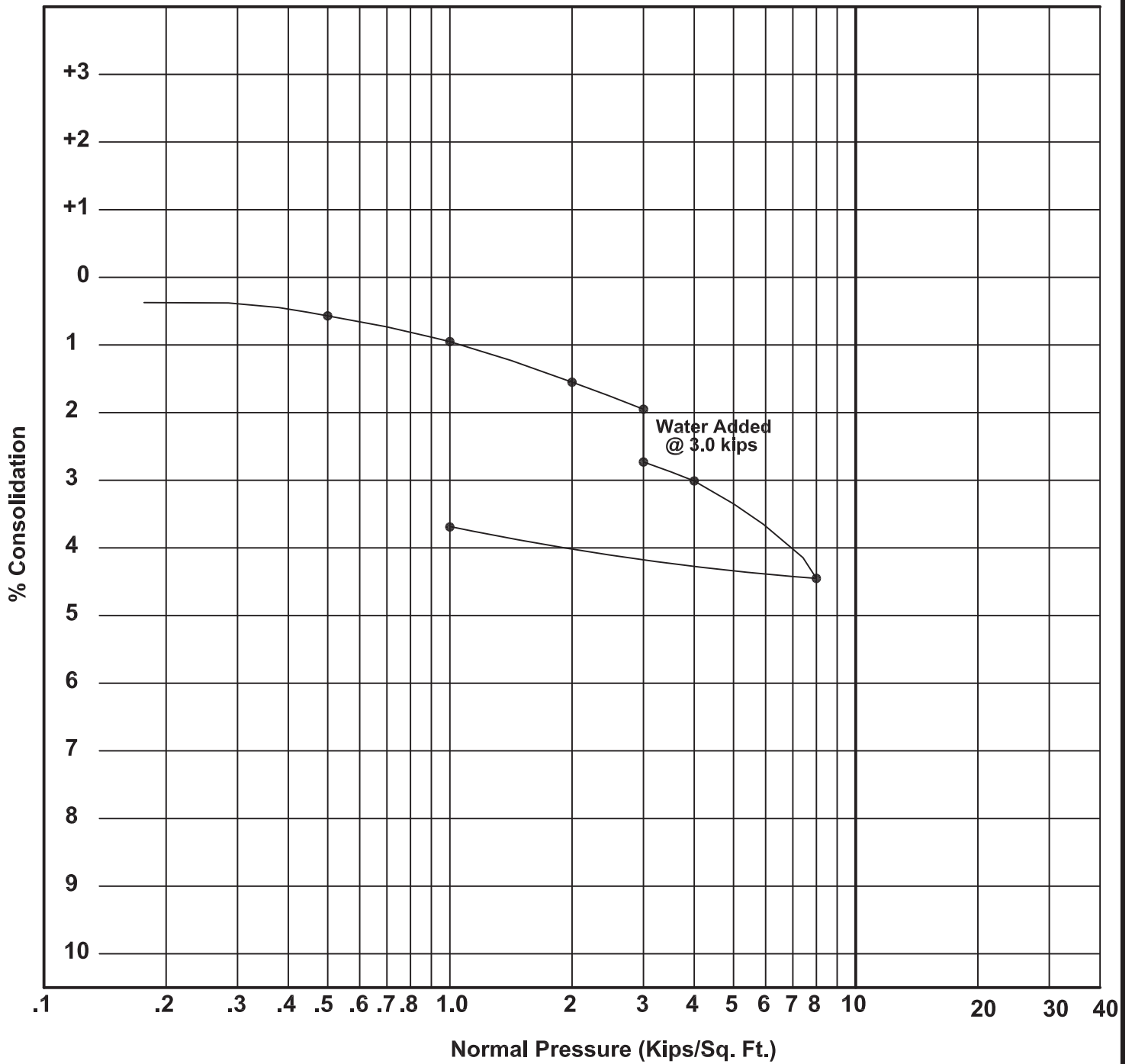

Project Tr. 060922 Skyline Ranch
Location B90
Depth 30 feet
Material Landslide Debris - Silty SAND



Geolabs - Westlake Village

GEOLOGY AND SOIL ENGINEERING

DATE _____ BY DS
 SCALE _____ w.o. 8838

PLATE C90.30

CONSOLIDATION - PRESSURE CURVE

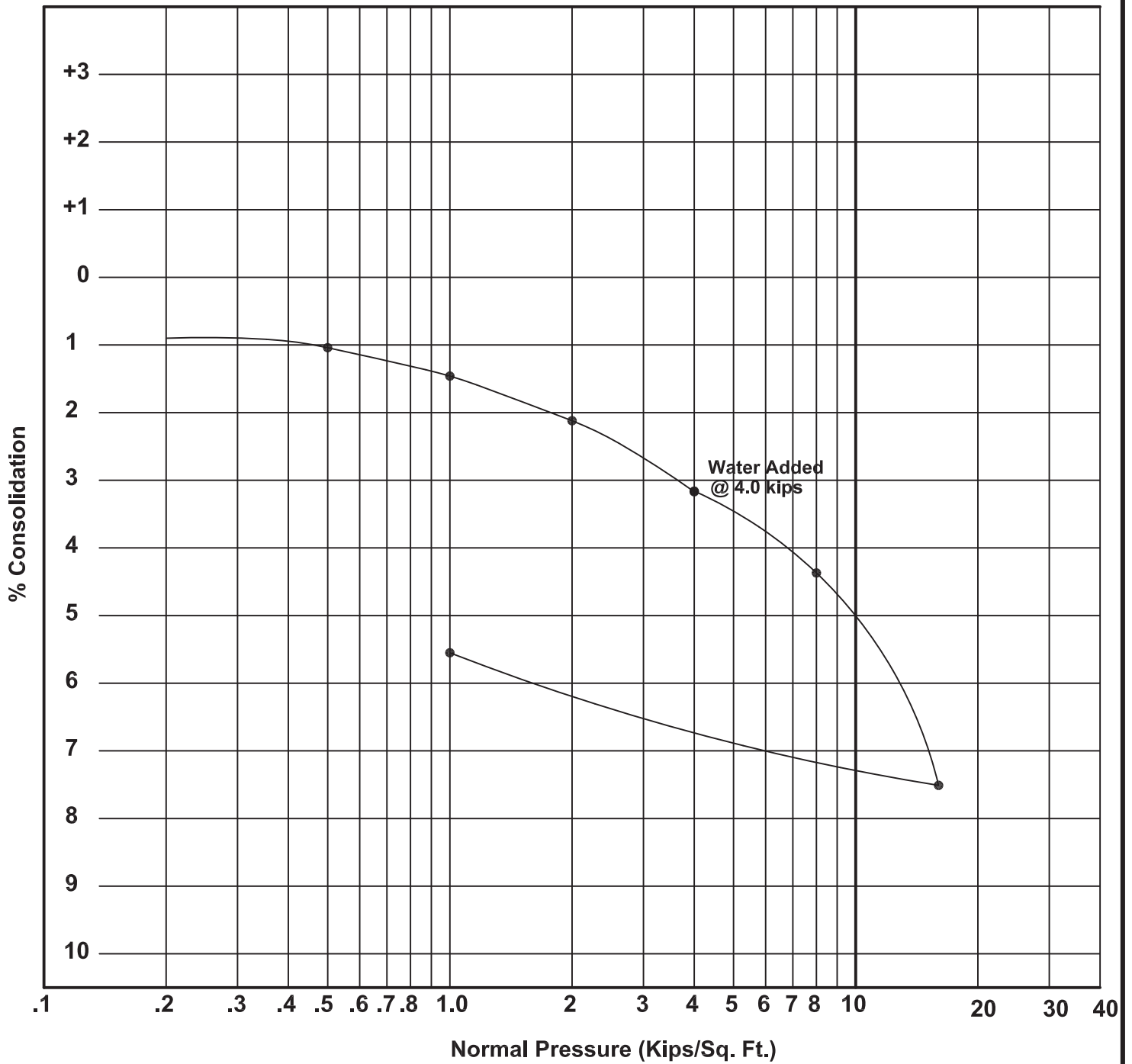

Project Tr. 060922 Skyline Ranch
Location B90
Depth 40 feet
Material Landslide Debris - Clayey SAND



Geolabs - Westlake Village

GEOLOGY AND SOIL ENGINEERING

DATE _____ BY DS
 SCALE _____ w.o. 8838

PLATE C90.40

CONSOLIDATION - PRESSURE CURVE

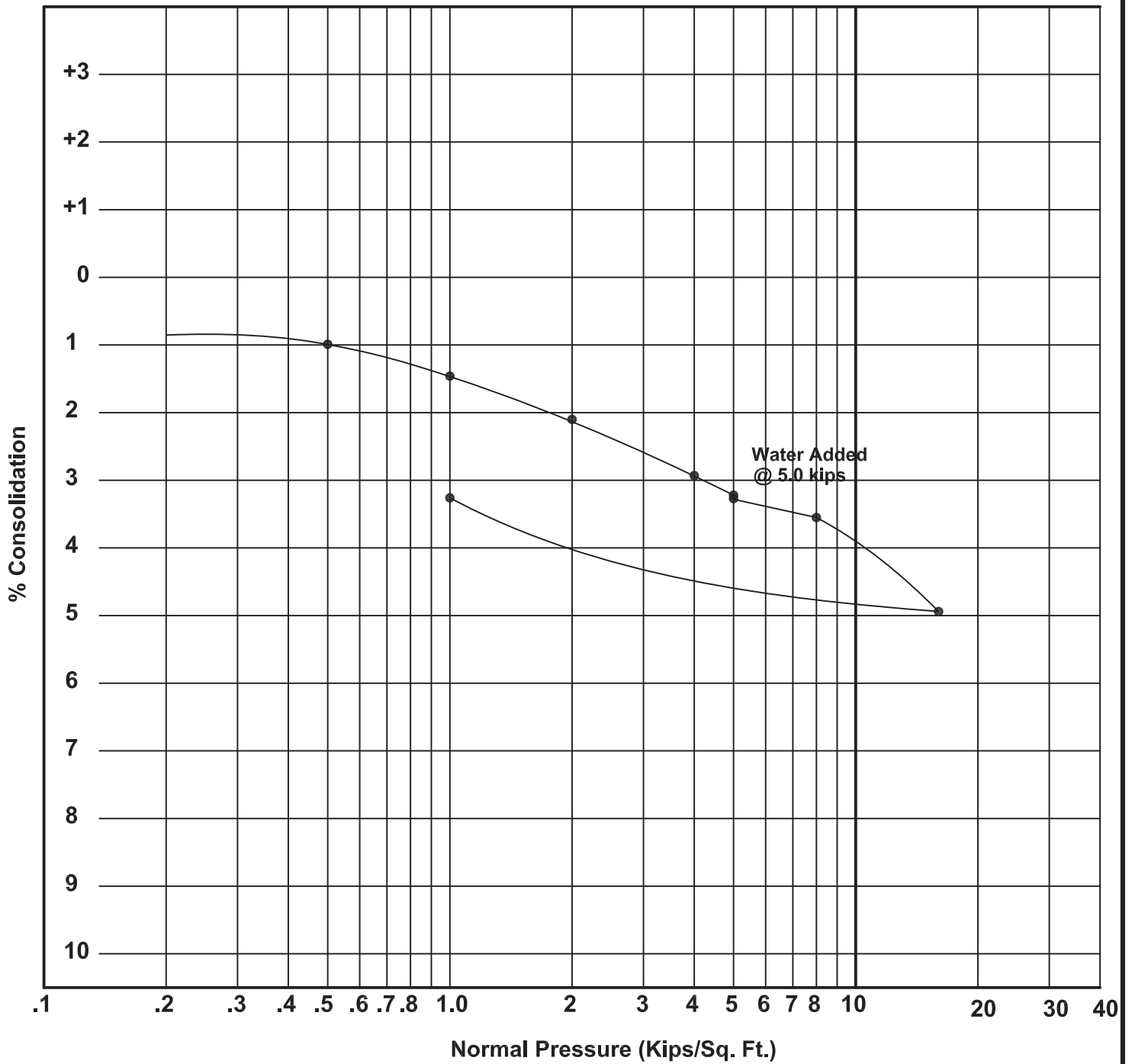

Project Tr. 060922 Skyline Ranch
Location B90
Depth 50 feet
Material Landslide Debris - Silty SAND



Geolabs - Westlake Village

GEOLOGY AND SOIL ENGINEERING

DATE _____ BY DS
 SCALE _____ w.o. 8838

PLATE C90.50

CONSOLIDATION - PRESSURE CURVE

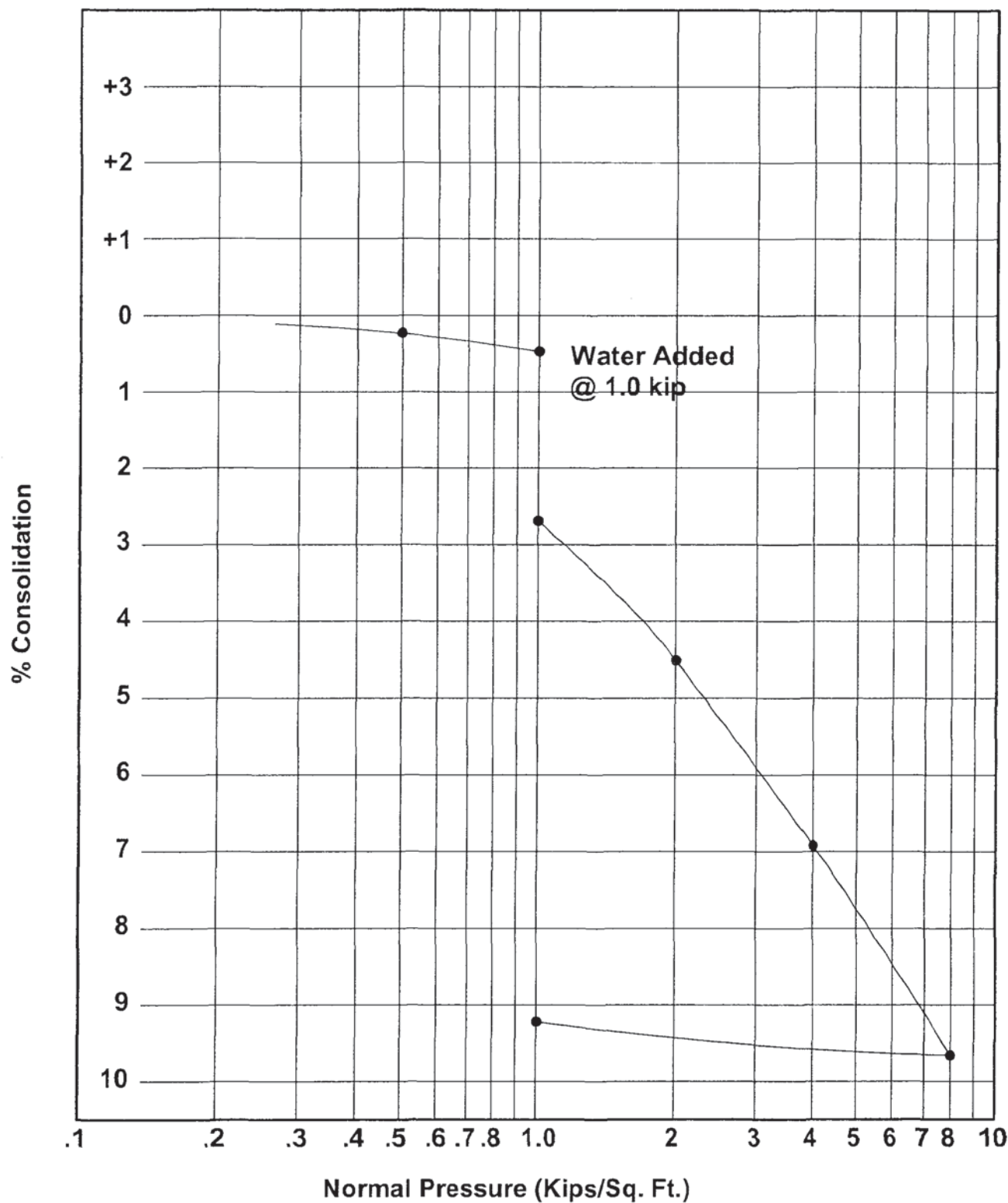

Project Skyline Ranch
Location T20
Depth 1.5 Feet
Material Terrace Deposits

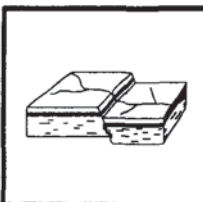

Geolabs - Westlake Village

GEOLOGY AND SOIL ENGINEERING

DATE _____ BY **DS**
 SCALE _____ W.O. **8838**

CONSOLIDATION - PRESSURE CURVE

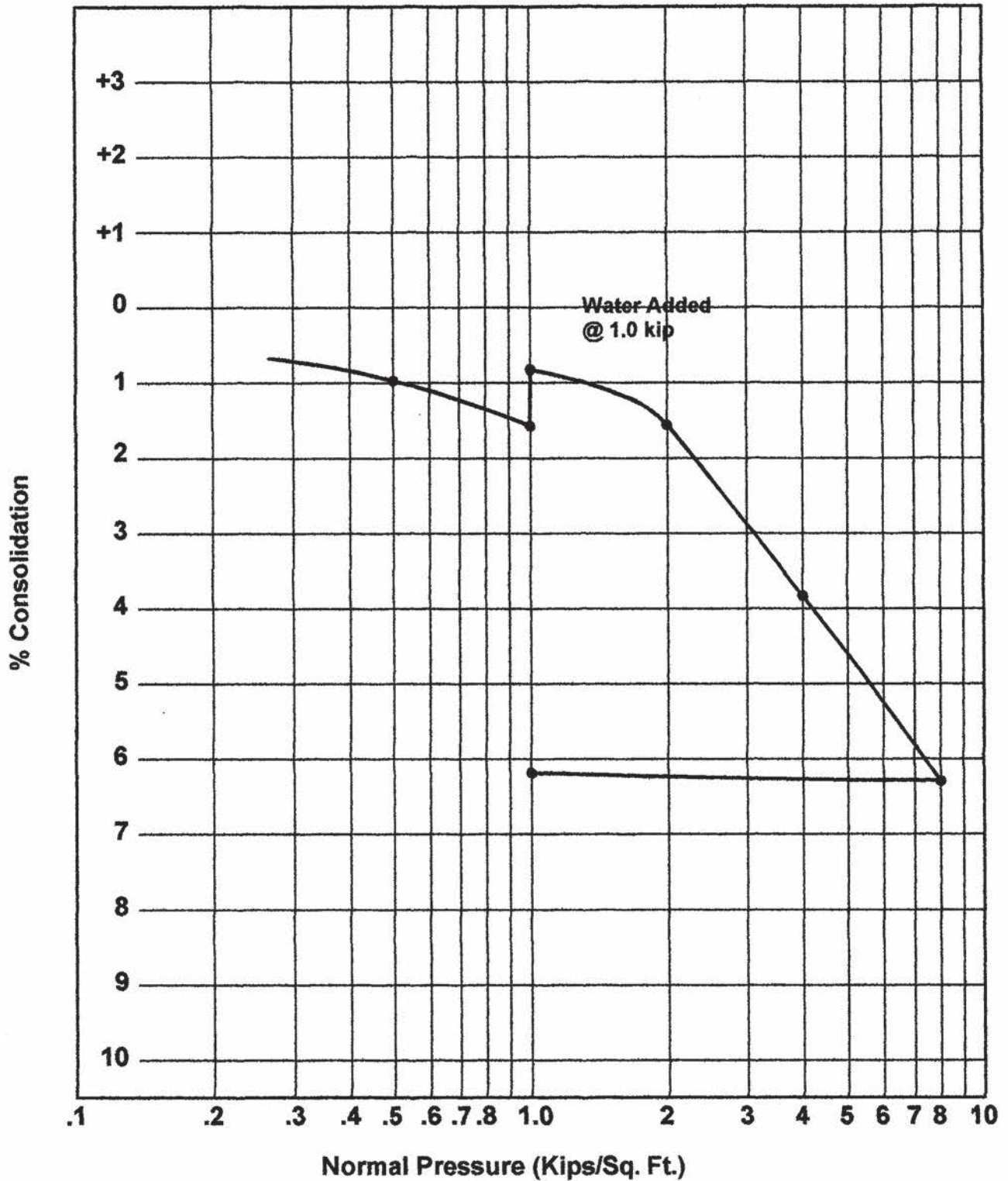

Project Skyline Ranch
 Location T21
 Depth 3 Feet
 Material Slopewash



Geolabs - Westlake Village

GEOLOGY AND SOIL ENGINEERING

DATE _____ BY DS
 SCALE _____ W.O. 8838

PLATE Ct21.3

CONSOLIDATION - PRESSURE CURVE

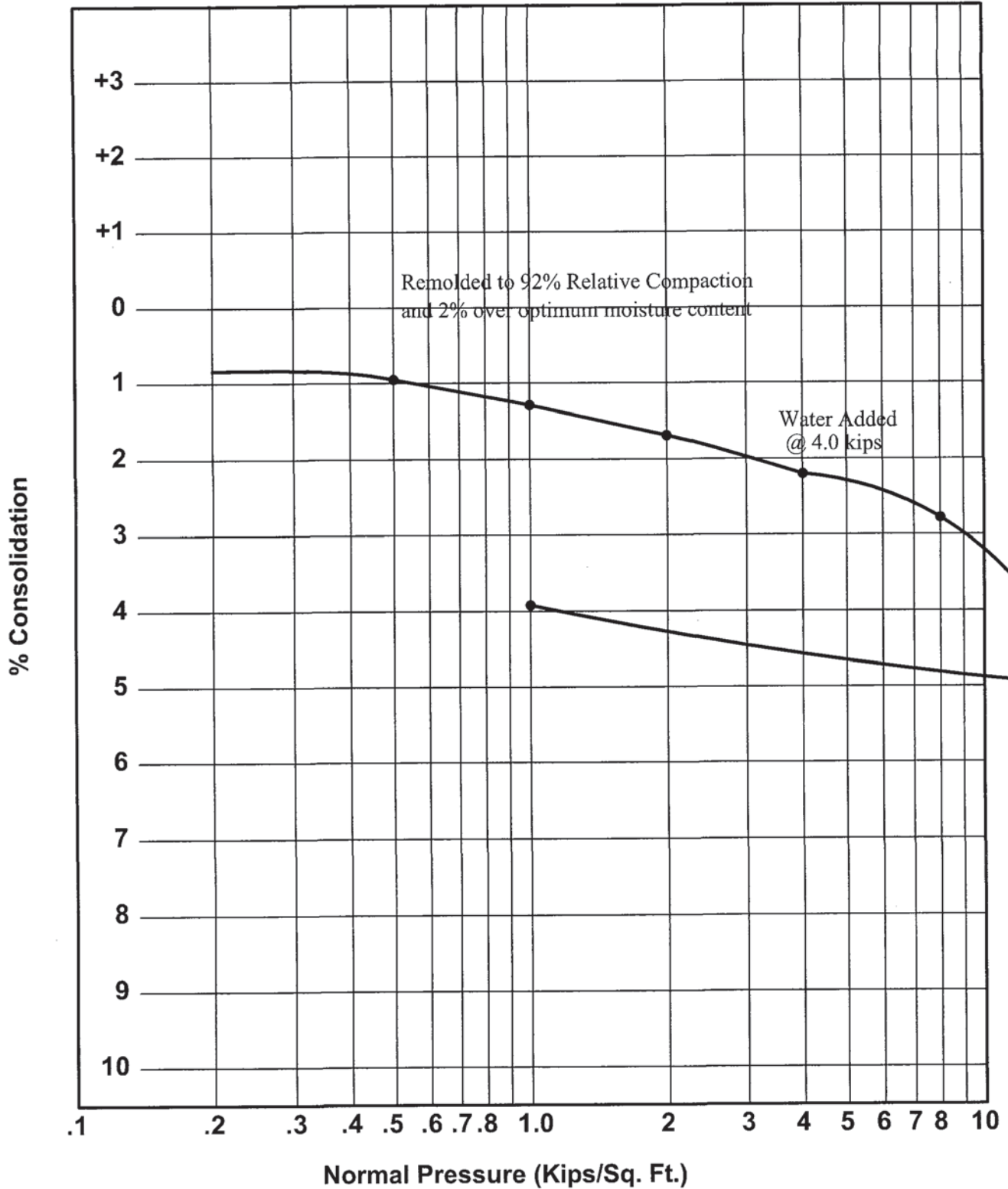

Project Tr. 060922 Skyline Ranch
Location B19
Depth 15 Feet
Material Silty fine-coarse SAND (Saugus Fm.)



Geolabs - Westlake Village
 GEOLOGY AND SOIL ENGINEERING

DATE _____ BY DS
 SCALE _____ W.O. 8838.001

CONSOLIDATION - PRESSURE CURVE

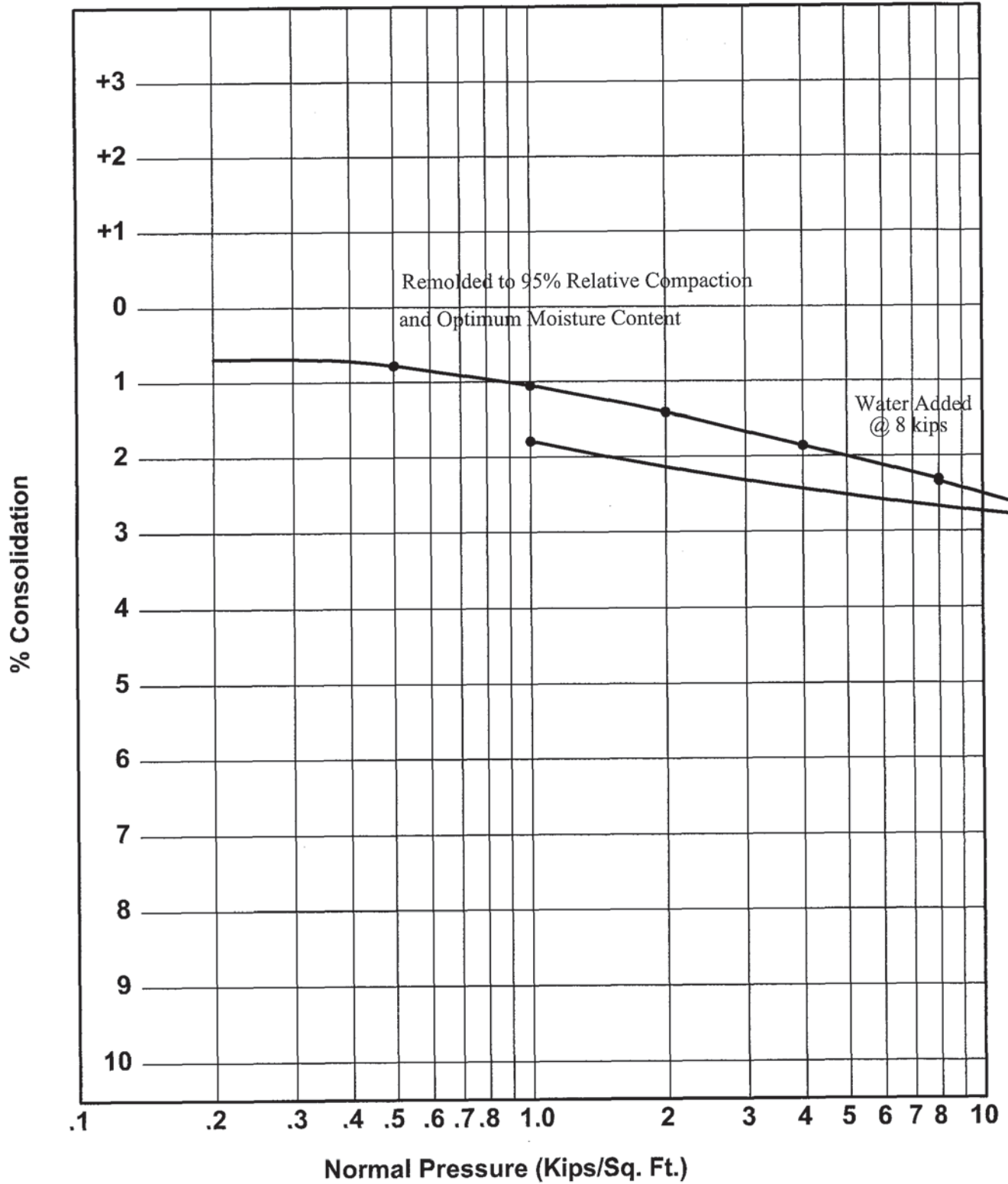

Project Tr. 060922 Skyline Ranch
Location B19
Depth 15 Feet
Material Silty fine-coarse SAND (Saugus Fm.)



Geolabs - Westlake Village
 GEOLOGY AND SOIL ENGINEERING

DATE _____ BY DS
 SCALE _____ W.O. 8838.001

CONSOLIDATION - PRESSURE CURVE

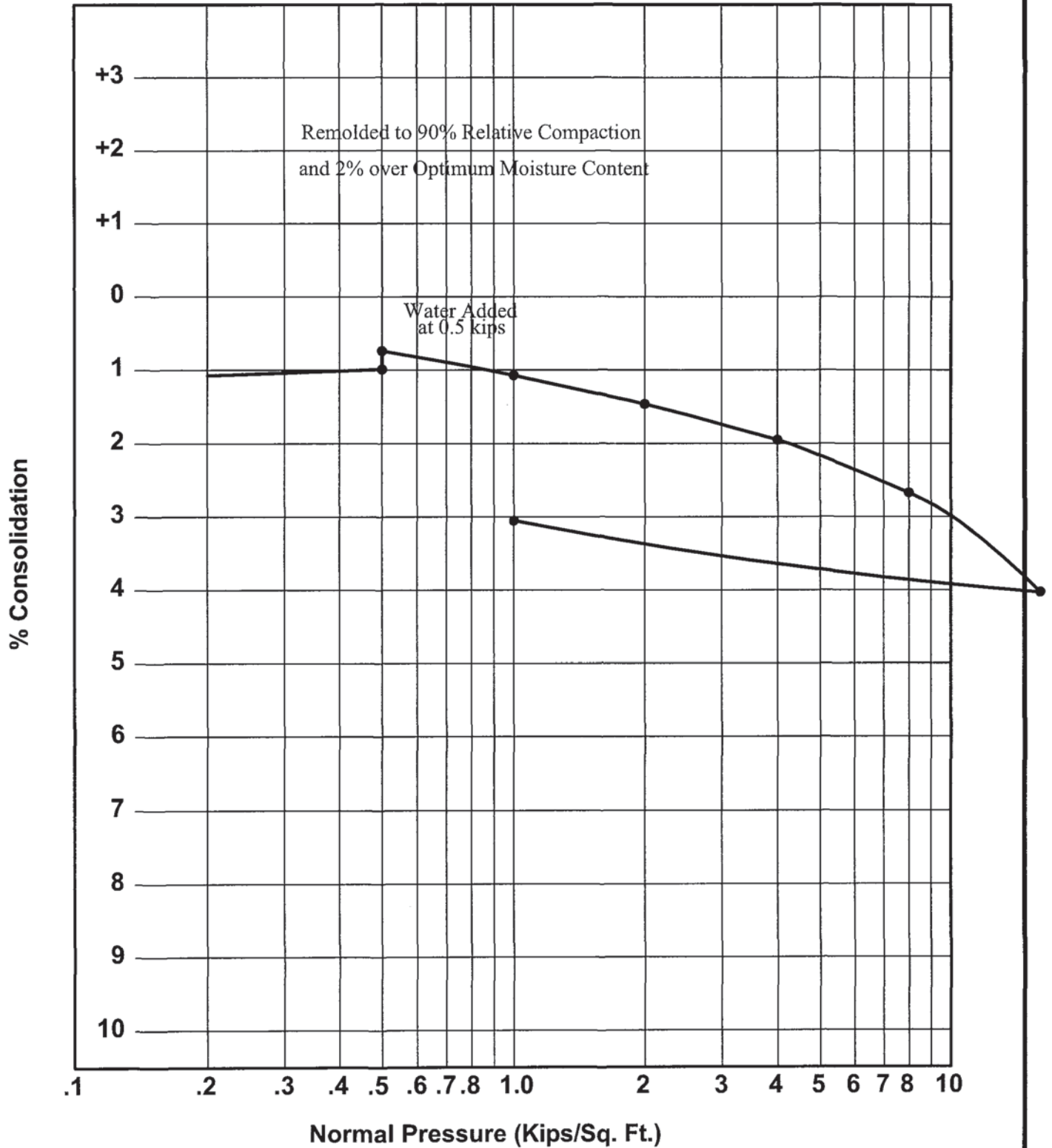

Project Tr. 060922 Skyline Ranch
Location B77
Depth 15 Feet
Material Silty SAND (Saugus Fm.)



Geolabs - Westlake Village
 GEOLOGY AND SOIL ENGINEERING

DATE _____ BY DS
 SCALE _____ W.O. 8838.001

CONSOLIDATION - PRESSURE CURVE

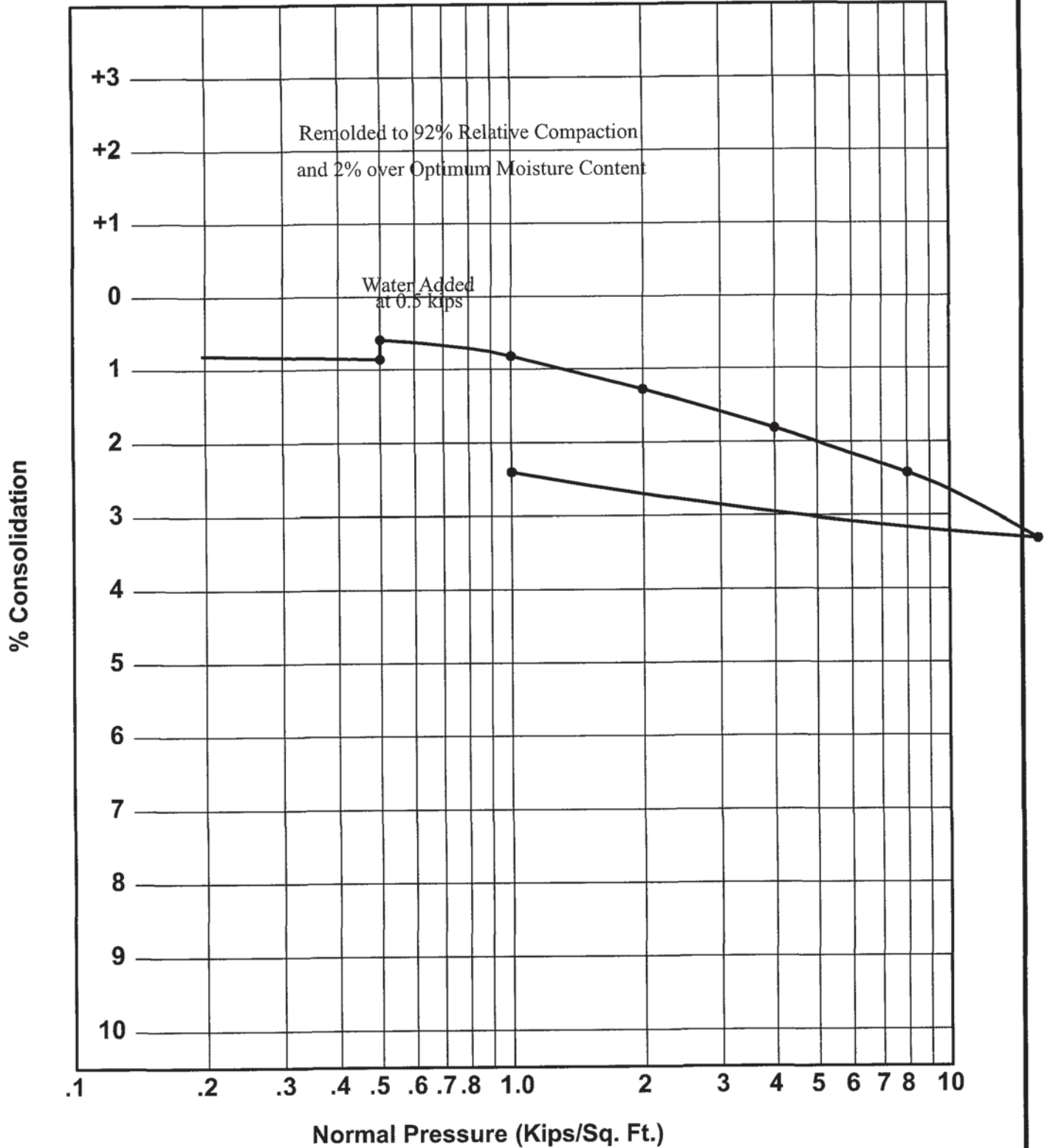

Project Tr. 060922 Skyline Ranch
Location B77
Depth 15 Feet
Material Silty SAND (Saugus Fm.)



Geolabs - Westlake Village
 GEOLOGY AND SOIL ENGINEERING

DATE _____ BY DS
 SCALE _____ W.O. 8838.001

CONSOLIDATION - PRESSURE CURVE

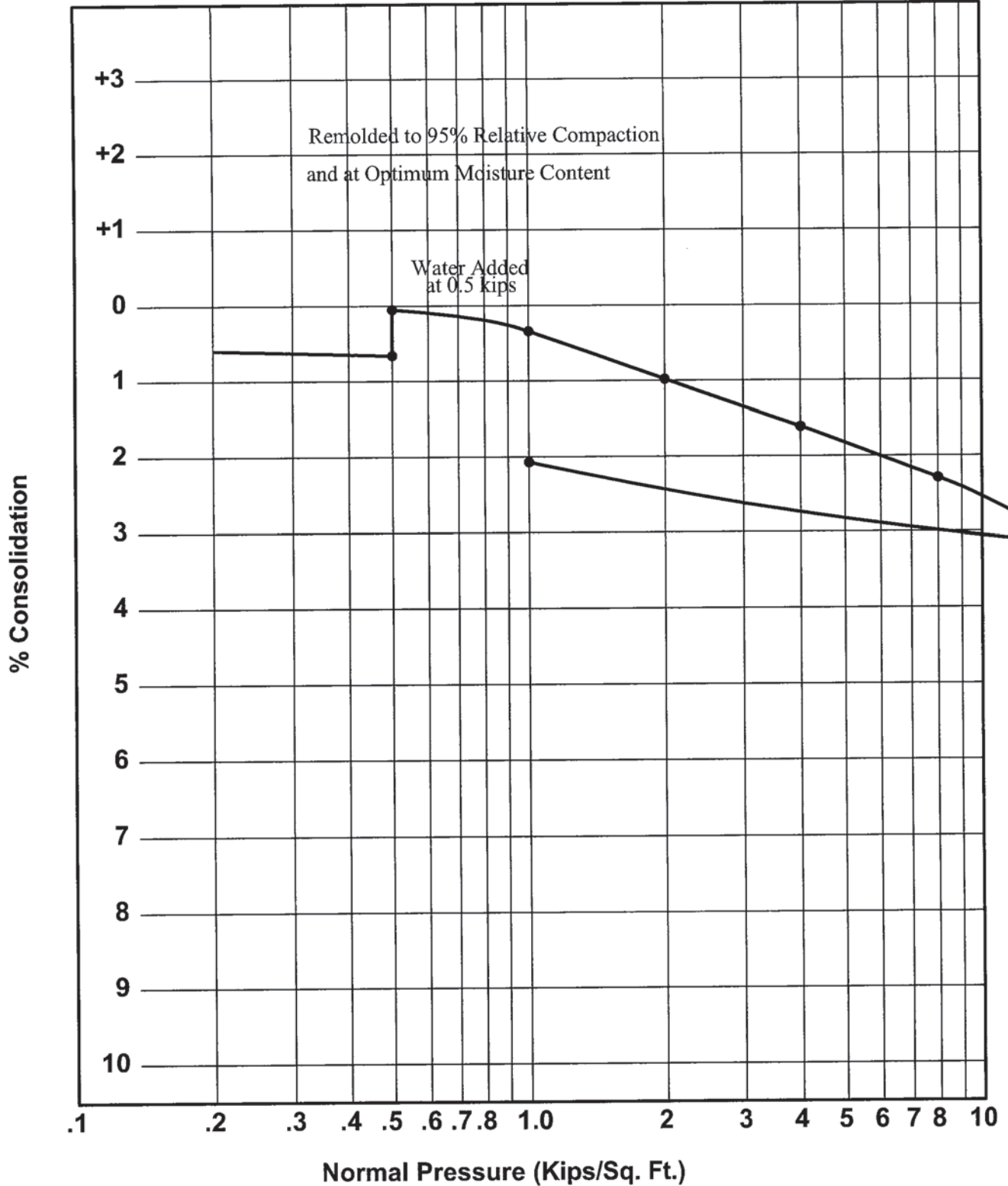

Project Tr. 060922 Skyline Ranch
Location B77
Depth 15 Feet
Material Silty SAND (Saugus Fm.)



Geolabs - Westlake Village
 GEOLOGY AND SOIL ENGINEERING

DATE _____ BY DS
 SCALE _____ W.O. 8838.001

CONSOLIDATION - PRESSURE CURVE

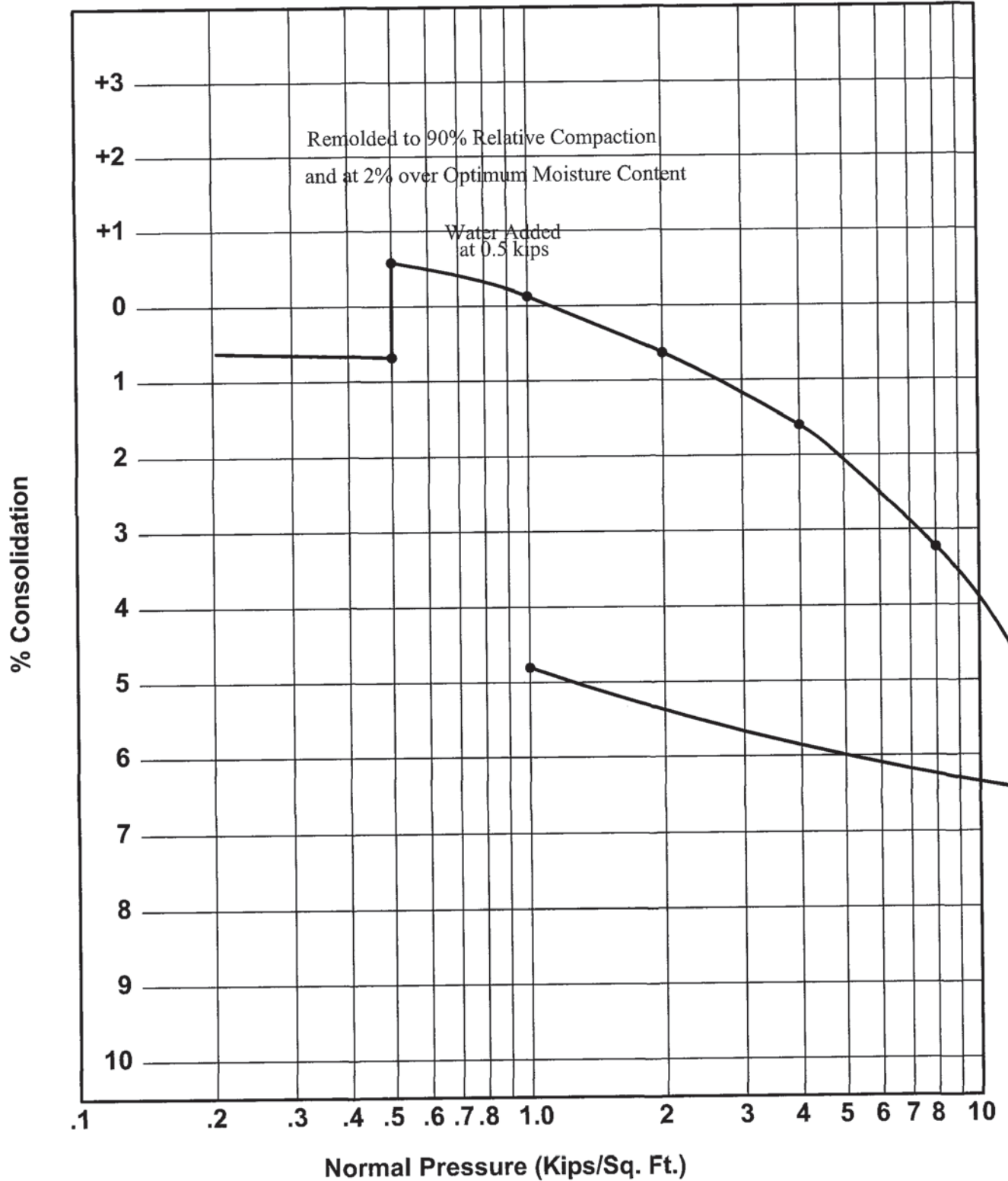

Project Tr. 060922 Skyline Ranch
Location B77
Depth 52 Feet
Material Sandy SILT (Saugus Fm.)



Geolabs - Westlake Village
 GEOLOGY AND SOIL ENGINEERING

DATE _____ BY DS
 SCALE _____ w.o. 8838.001

CONSOLIDATION - PRESSURE CURVE

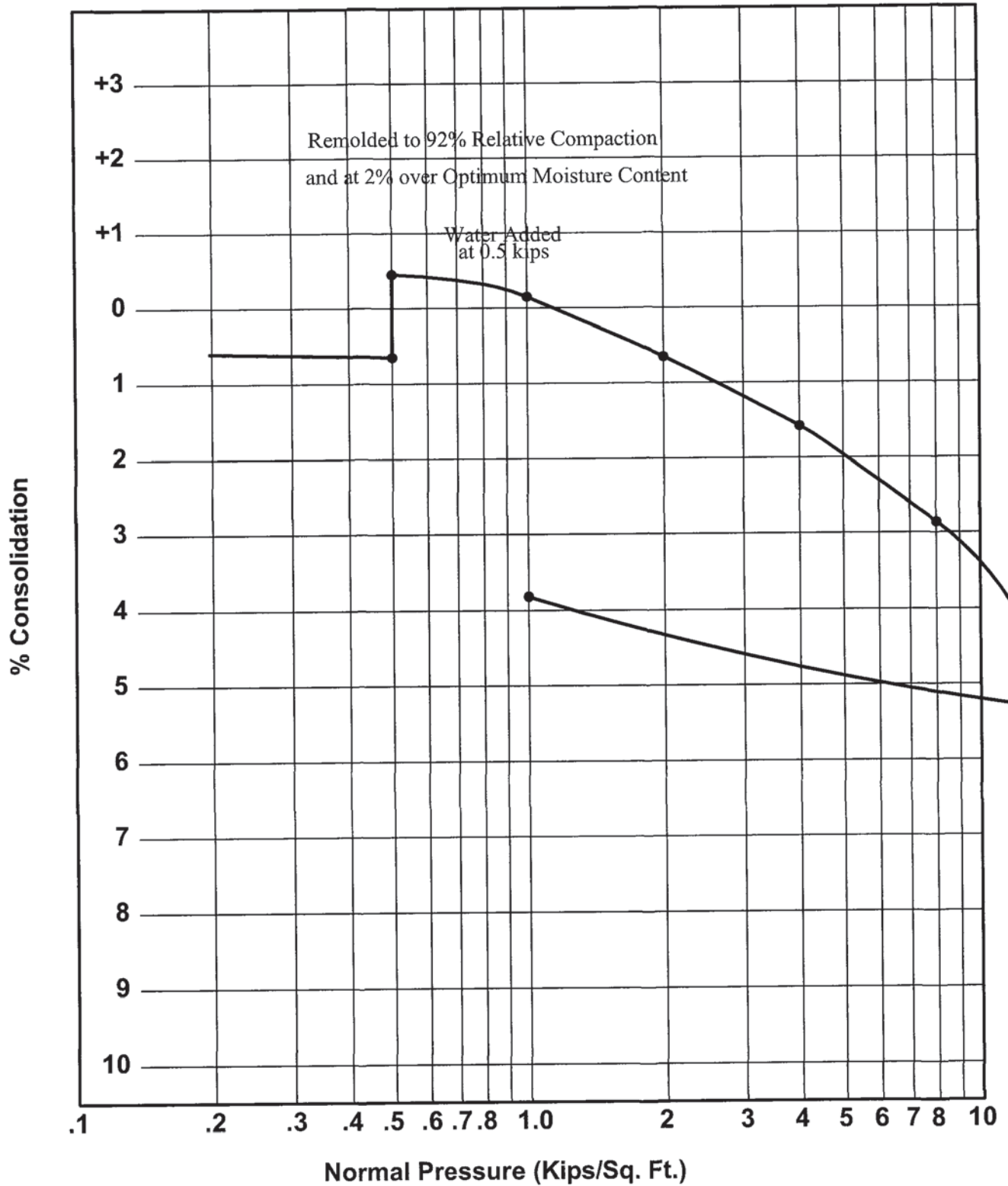

Project Tr. 060922 Skyline Ranch
Location B77
Depth 52 Feet
Material Sandy SILT (Saugus Fm.)



Geolabs - Westlake Village
 GEOLOGY AND SOIL ENGINEERING

DATE _____ BY DS
 SCALE _____ W.O. 8838.001

CONSOLIDATION - PRESSURE CURVE

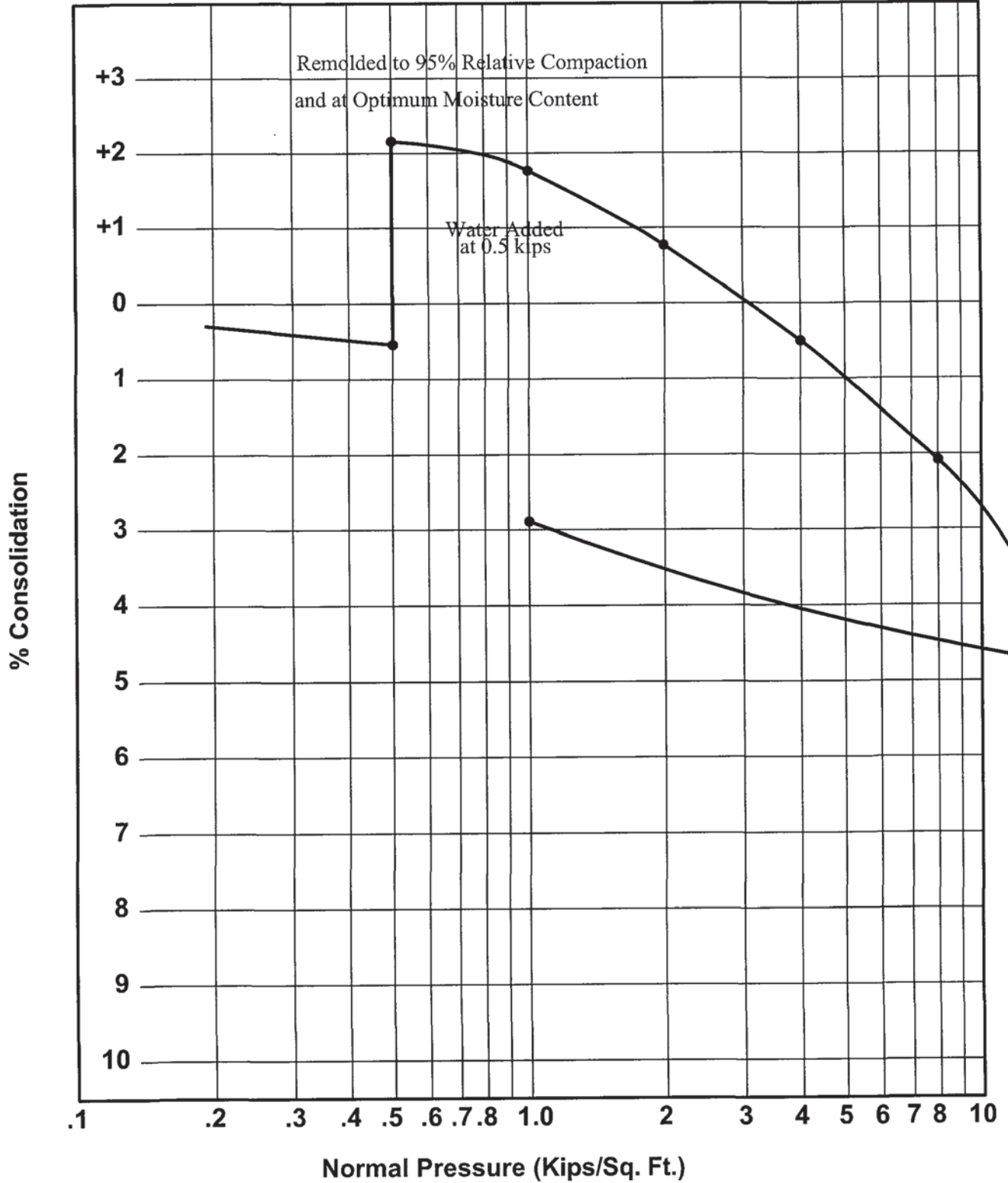

Project Tr. 060922 Skyline Ranch
Location B77
Depth 52 Feet
Material Sandy SILT (Saugus Fm.)



Geolabs - Westlake Village
 GEOLOGY AND SOIL ENGINEERING

DATE _____ BY DS
 SCALE _____ W.O. 8838.001

CONSOLIDATION - PRESSURE CURVE

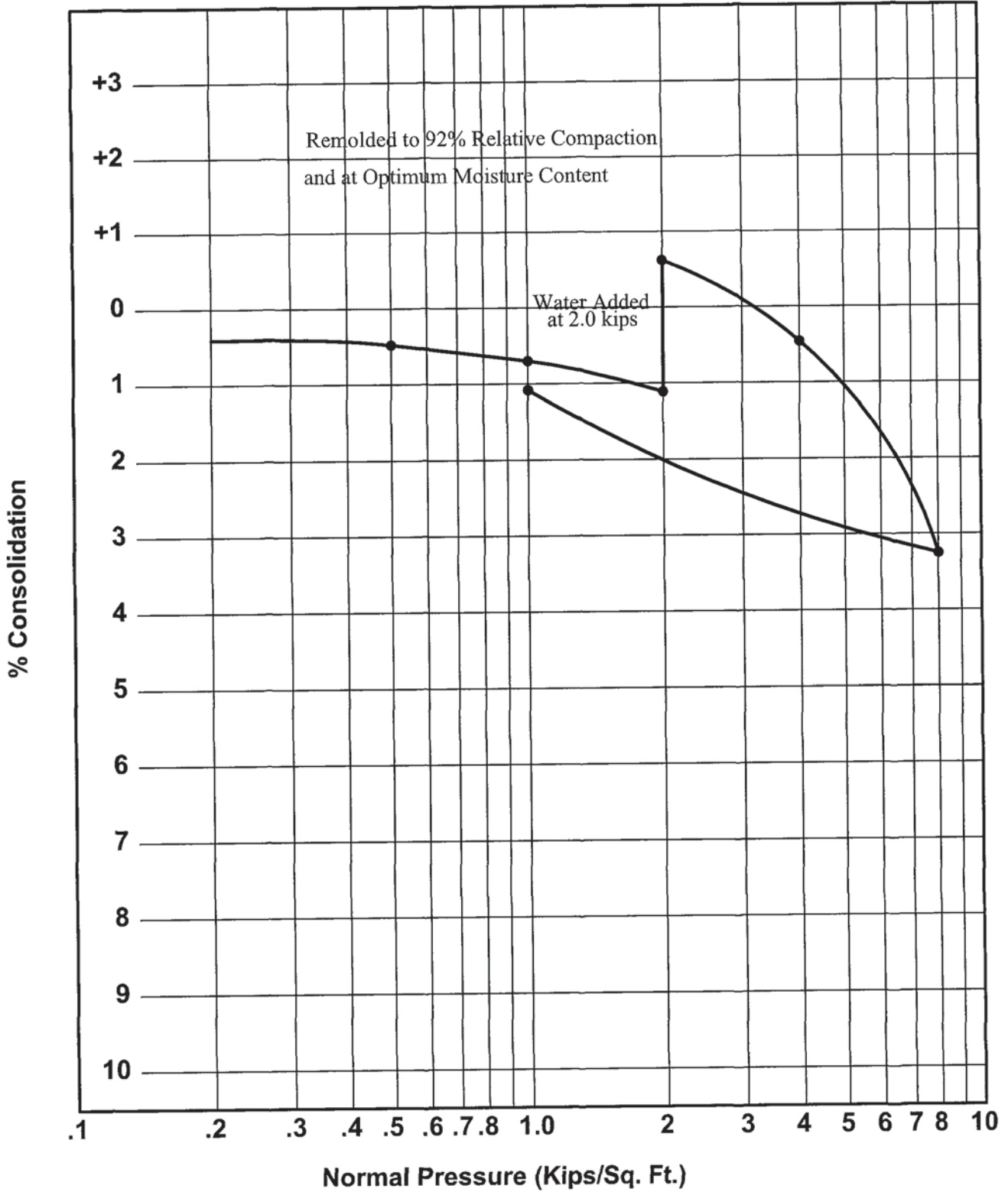

Project Location Tr. 060922 Skyline Ranch
TP168
Depth 3.5 to 5.5 Feet
Material Sandy CLAY (Alluvium)

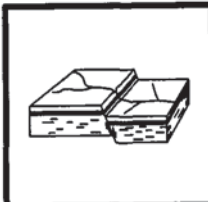

Geolabs - Westlake Village
 GEOLOGY AND SOIL ENGINEERING

DATE _____ BY DS
 SCALE _____ W.O. 8838.001

CONSOLIDATION RESULTS

Bulk Sample Remolded to 92 Percent Relative Compaction

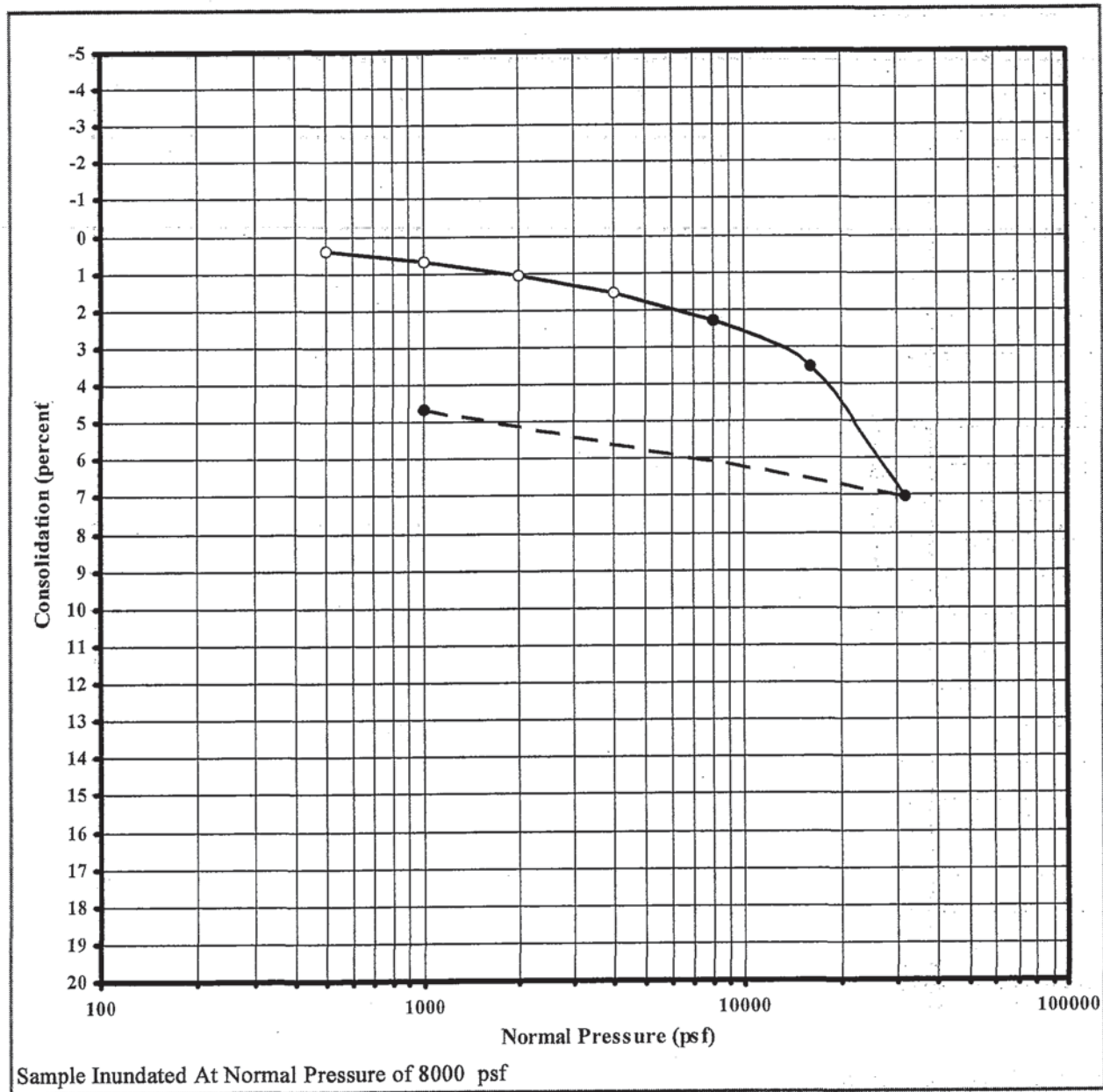

Sample Location: TP168
Sample Depth: 3.5 ft.
Initial Moisture: 16 %
Init. Dry Density: 105.8 pcf

Geologic Unit: Alluvium
Material:

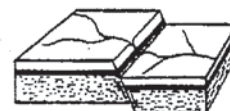

CONSOLIDATION RESULTS

Bulk Sample Remolded to 95 Percent Relative Compaction

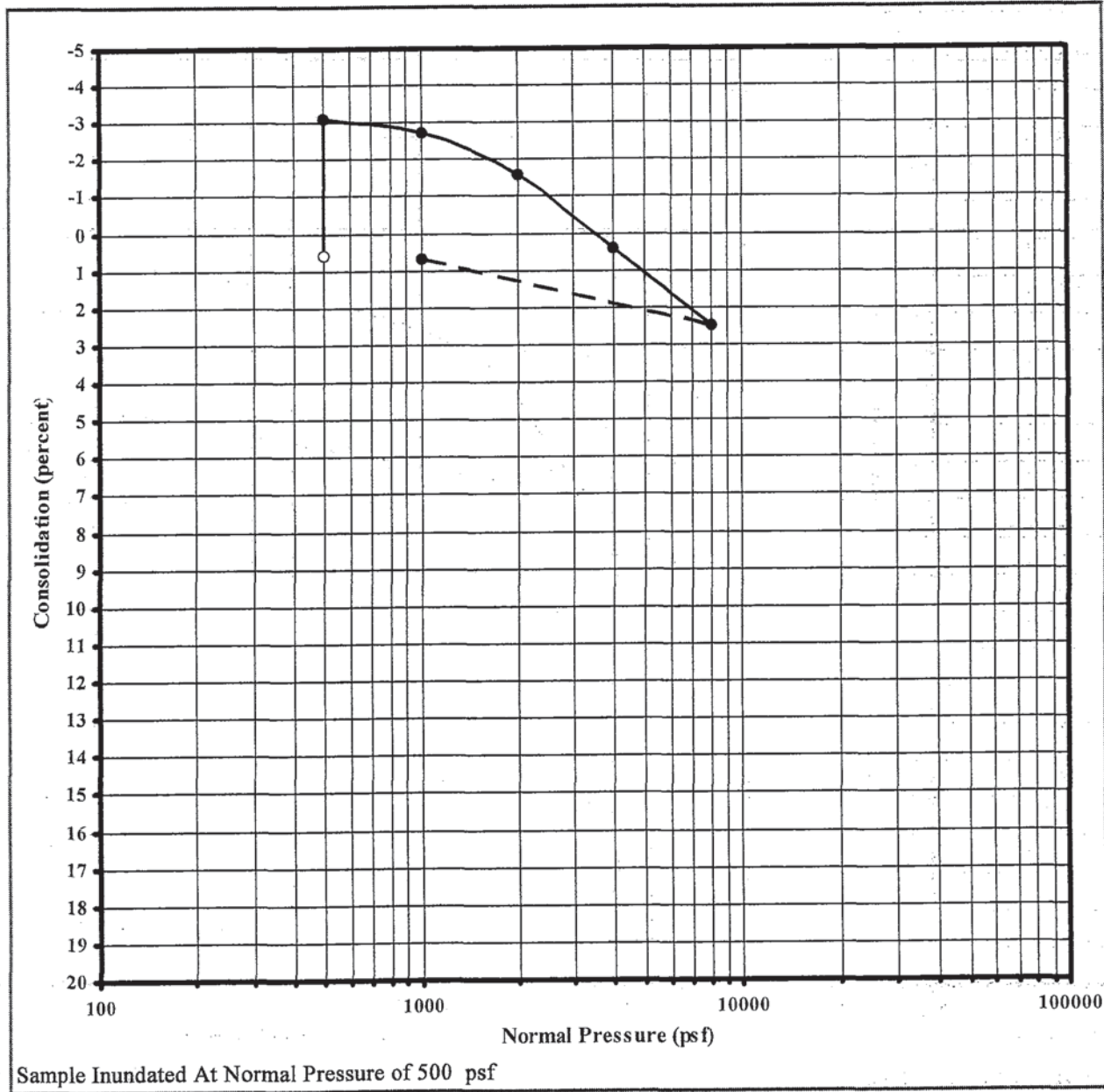

Sample Location: TP168
Sample Depth: 3.5 ft.
Initial Moisture: 16 %
Init. Dry Density: 109.25 pcf

Geologic Unit: Alluvium
Material:

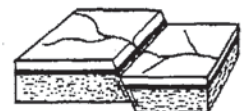

CONSOLIDATION - PRESSURE CURVE

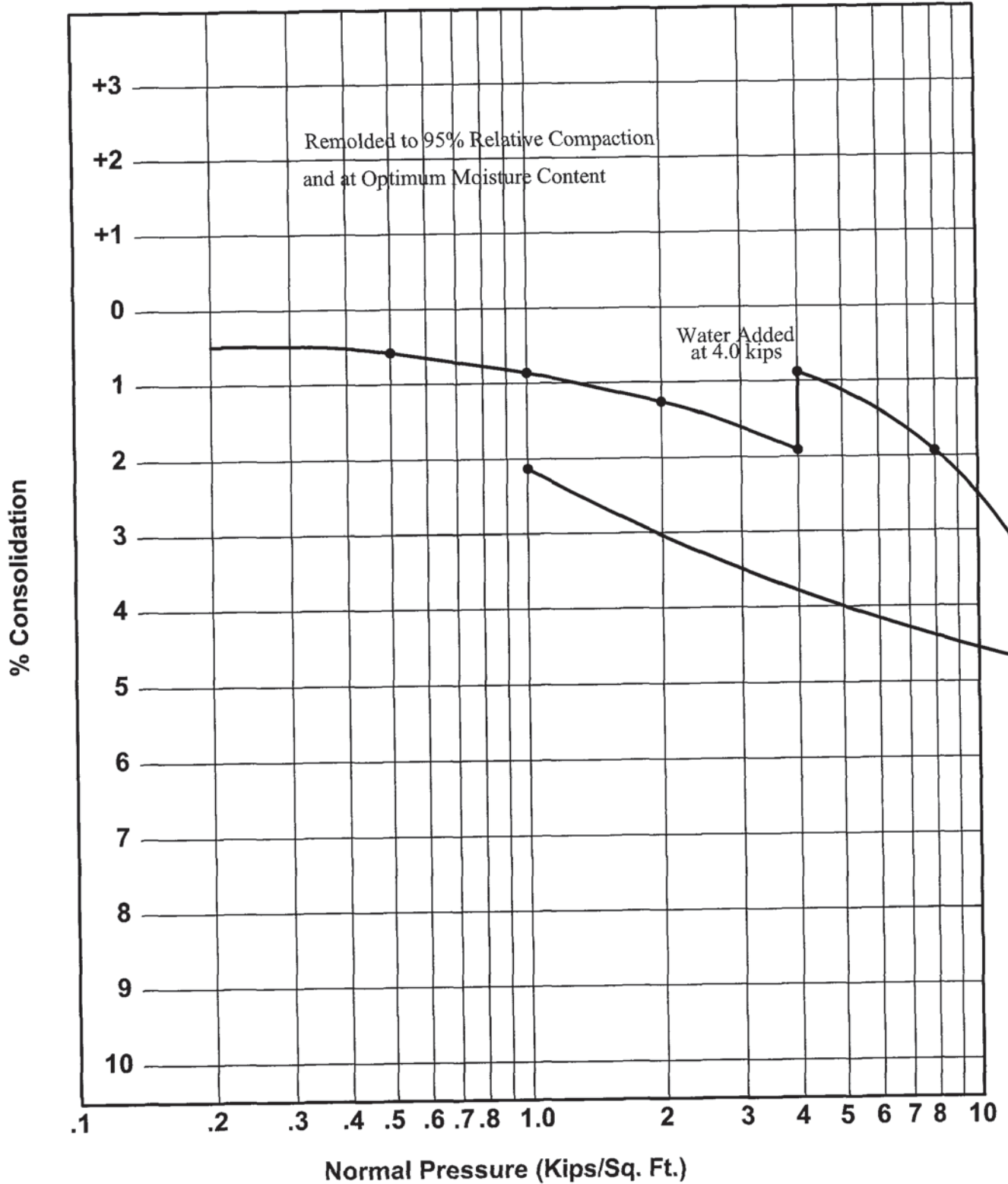

Project Location Tr. 060922 Skyline Ranch
TP168
Depth 3.5 to 5.5 Feet
Material Sandy CLAY (Alluvium)



Geolabs - Westlake Village
 GEOLOGY AND SOIL ENGINEERING

DATE _____ BY DS
 SCALE _____ W.O. 8838.001

CONSOLIDATION RESULTS

Bulk Sample Remolded to 95 Percent Relative Compaction

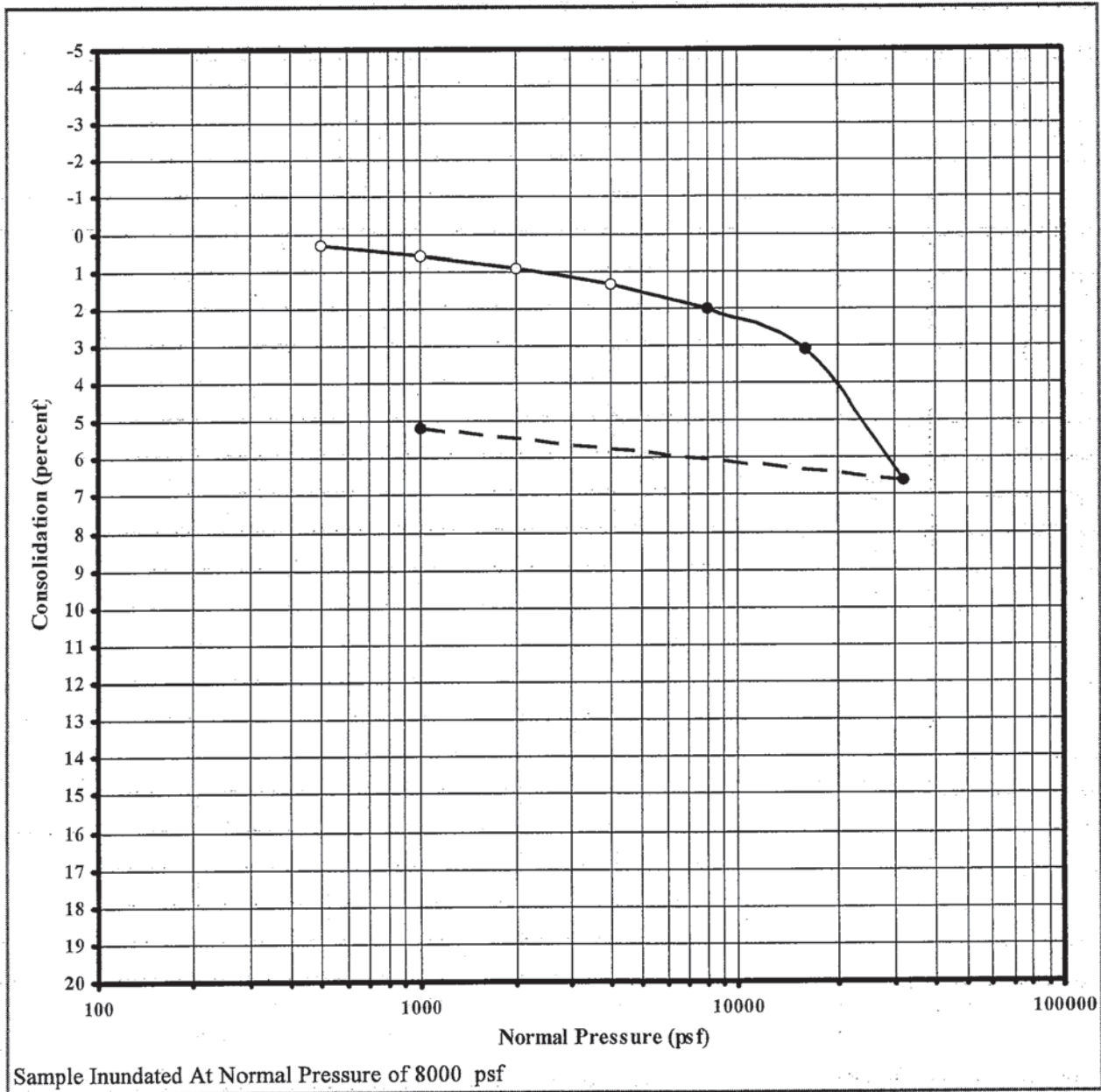

Sample Location: TP168

Sample Depth: 3.5 ft.

Initial Moisture: 16 %

Init. Dry Density: 109.25 pcf

Geologic Unit: Alluvium

Material:

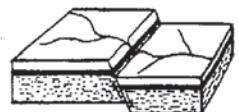

M.J. SCHIFF & ASSOCIATES, INC.

431 West Baseline Road
Claremont, CA 91711-1608

TEL (909)626-0967 / FAX (909) 626-3316
E-mail: mjsa@mjs-a.com <http://www.mjs-a.com>

TRANSMITTAL LETTER

DATE: December 4, 2002

ATTENTION: Dave

To: Geolabs
31119 Via Colinas, Suite 502
Westlake Village, CA 91362

SUBJECT: Laboratory Test Data
Monosabian
Your # 8838
Our # 02-1161LAB

COMMENTS: Enclosed are the results for the subject project.



James T. Keegan

Table 1 - Laboratory Tests on Soil Samples

Monosabian

Your #8838, MJS&A #02-1161LAB

22-Nov-02

Sample ID

B2

@ 10-15'

Resistivity		Units	
as-received		ohm-cm	930,000
saturated		ohm-cm	1,700
pH			7.9
Electrical			
Conductivity		mS/cm	0.07
Chemical Analyses			
Cations			
calcium	Ca ²⁺	mg/kg	16
magnesium	Mg ²⁺	mg/kg	ND
sodium	Na ¹⁺	mg/kg	47
Anions			
carbonate	CO ₃ ²⁻	mg/kg	ND
bicarbonate	HCO ₃ ¹⁻	mg/kg	104
chloride	Cl ¹⁻	mg/kg	40
sulfate	SO ₄ ²⁻	mg/kg	ND
Other Tests			
ammonium	NH ₄ ¹⁺	mg/kg	na
nitrate	NO ₃ ¹⁻	mg/kg	na
sulfide	S ²⁻	qual	na
Redox		mv	na

Electrical conductivity in millisiemens/cm and chemical analysis were made on a 1:5 soil-to-water extract.
 mg/kg = milligrams per kilogram (parts per million) of dry soil.

Redox = oxidation-reduction potential in millivolts

ND = not detected

na = not analyzed

M.J. SCHIFF & ASSOCIATES, INC.
431 West Baseline Road
Claremont, CA 91711

TEL (909) 626-0967 / FAX (909) 626-3316
E-mail: mjsa@mjschiff.com <http://www.mjschiff.com>

w 8838

TRANSMITTAL LETTER

DATE: December 3, 2003

ATTENTION: Dave Sakissian

To: Geolabs
31119 Via Colinas, Suite 502
Westlake Village, CA. 91362

SUBJECT: Laboratory Test Data
Montasabian
Your # 8838
MJS&A # 03-1370LAB

COMMENTS: Enclosed are the results for the subject project.



James T. Keegan

Laboratory Manager

Table 1 - Laboratory Tests on Soil Samples

Montasabian

Your #8838, MJS&A #03-1370LAB

20-Nov-03

Sample ID			
			B9
			@ 15'
Resistivity			
	Units		
as-received	ohm-cm		7,400
saturated	ohm-cm		690
pH			
			7.4
Electrical			
Conductivity	mS/cm		0.22
Chemical Analyses			
Cations			
calcium	Ca ²⁺	mg/kg	ND
magnesium	Mg ²⁺	mg/kg	19
sodium	Na ¹⁺	mg/kg	159
Anions			
carbonate	CO ₃ ²⁻	mg/kg	ND
bicarbonate	HCO ₃ ¹⁻	mg/kg	82
chloride	Cl ¹⁻	mg/kg	210
sulfate	SO ₄ ²⁻	mg/kg	61
Other Tests			
ammonium	NH ₄ ¹⁺	mg/kg	na
nitrate	NO ₃ ¹⁻	mg/kg	na
sulfide	S ²⁻	qual	na
Redox		mv	na

Electrical conductivity in millisiemens/cm and chemical analysis were made on a 1:5 soil-to-water extract.

mg/kg = milligrams per kilogram (parts per million) of dry soil.

Redox = oxidation-reduction potential in millivolts

ND = not detected

na = not analyzed



TRANSMITTAL LETTER

DATE: June 20, 2006

ATTENTION: Mr. Dave Sarkisian

To: Geolabs Westlake Village
3119 Via Colinas
Suite 502
Westlake Village, CA 91362

SUBJECT: Laboratory Test Data
Skyline Ranch
Your #8838
SA #06-1003LAB

COMMENTS: Enclosed are the results for the subject project.

James T. Keegan

Laboratory Manager



Table 1 - Laboratory Tests on Soil Samples

Geolabs Westlake Village
Skyline Ranch
Your #8838, MJS&A #06-1003LAB
7-Jun-06

Sample ID

B-39e0-3'

Table with 3 columns: Resistivity, Units, and values. Rows for 'as-received' (6,300 ohm-cm) and 'saturated' (3,500 ohm-cm).

pH 7.4

Electrical

Conductivity mS/cm 0.13

Chemical Analyses

Cations

Table with 4 columns: Name, Formula, Unit, and Value. Rows for calcium (83 mg/kg), magnesium (0.6 mg/kg), and sodium (34 mg/kg).

Anions

Table with 4 columns: Name, Formula, Unit, and Value. Rows for carbonate (ND mg/kg), bicarbonate (278 mg/kg), chloride (4.2 mg/kg), and sulfate (37 mg/kg).

Other Tests

Table with 4 columns: Name, Formula, Unit, and Value. Rows for ammonium (na mg/kg), nitrate (na mg/kg), sulfide (na qual), and Redox (na mV).

Electrical conductivity in millisiemens/cm and chemical analysis were made on a 1:5 soil-to-water extract.
mg/kg = milligrams per kilogram (parts per million) of dry soil.
Redox = oxidation-reduction potential in millivolts
ND = not detected
na = not analyzed

W.O. 8838

PARTICLE SIZE ANALYSIS

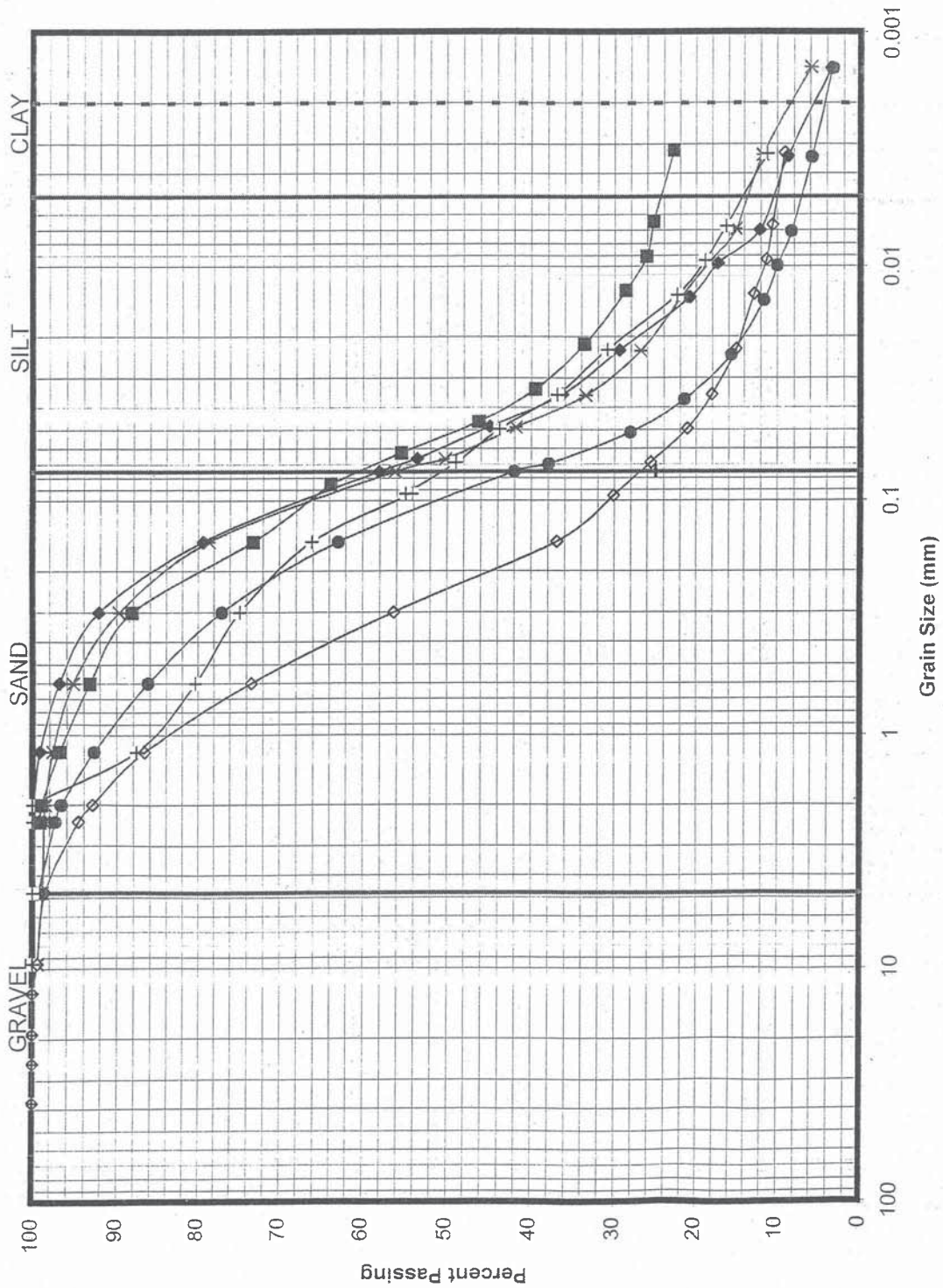

- ◆ B1 @ 20ft.
- * B1 @ 30ft.
- B1 @ 35ft.
- + B40 @ 55'
- ◇ B18 @ 2.5'
- B29 @ 5'
- B35 @ 7.5'

PARTICLE SIZE ANALYSIS

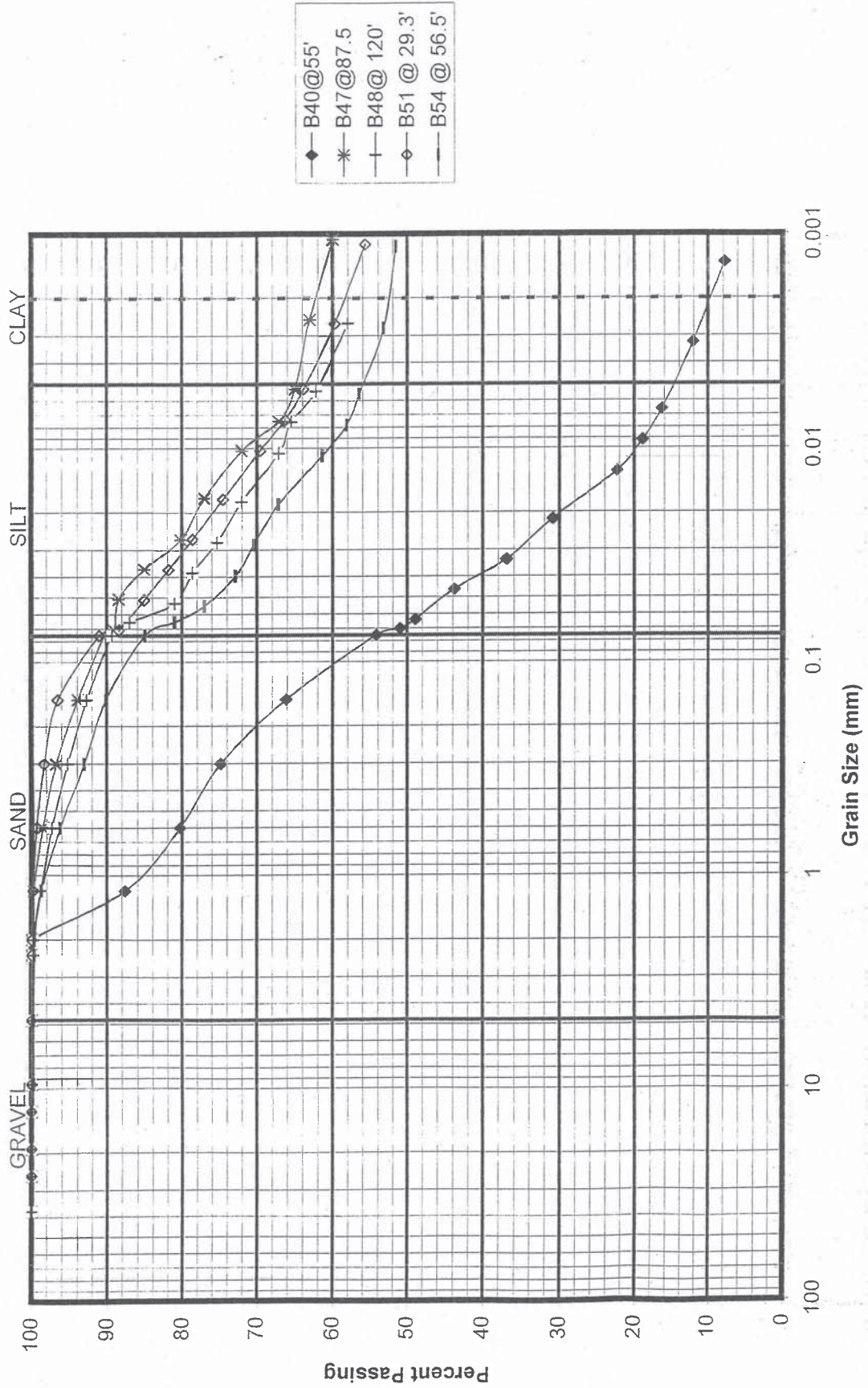

PARTICLE SIZE ANALYSIS

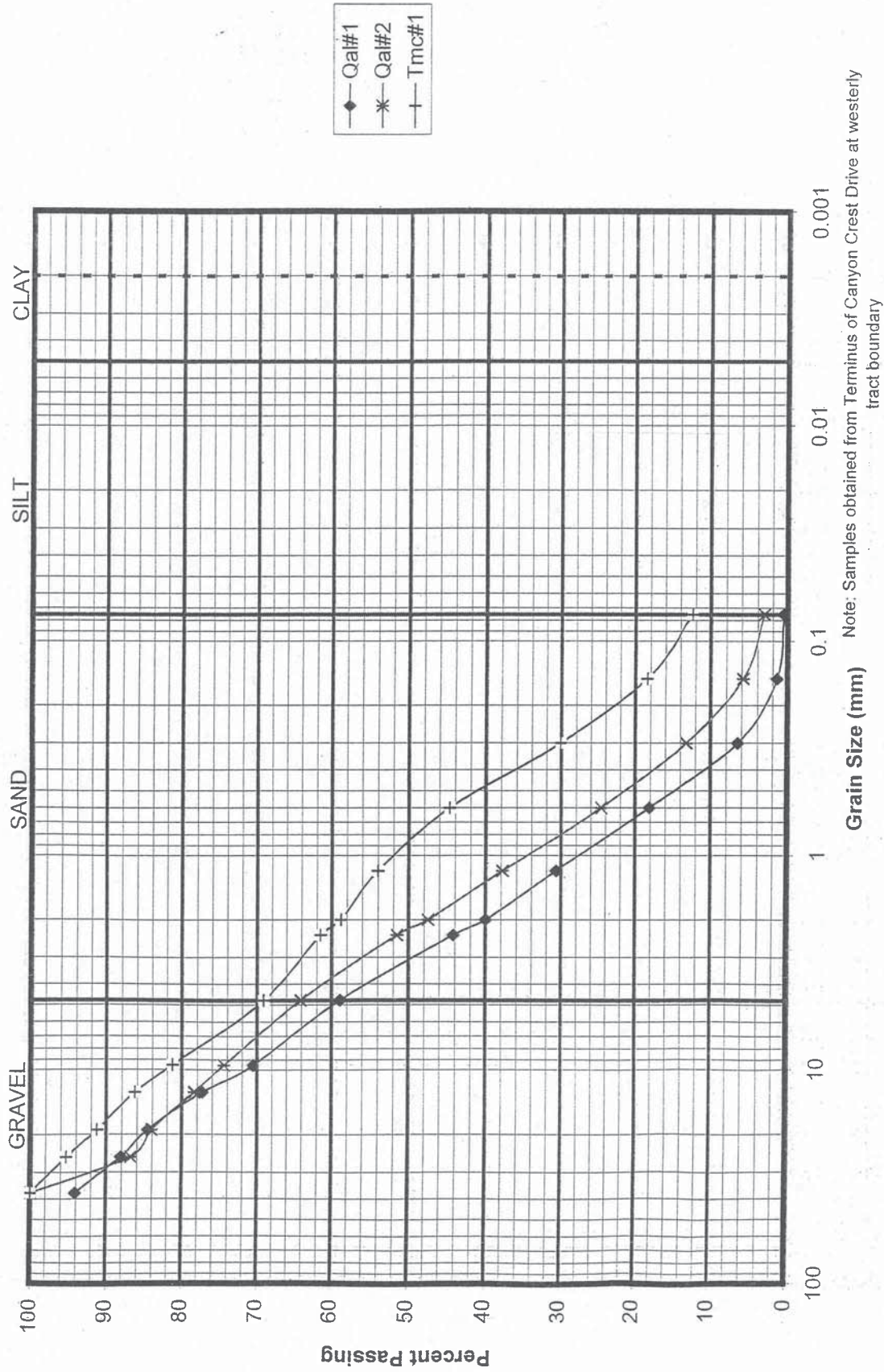

Note: Samples obtained from Terminus of Canyon Crest Drive at westerly tract boundary

PARTICLE SIZE ANALYSIS

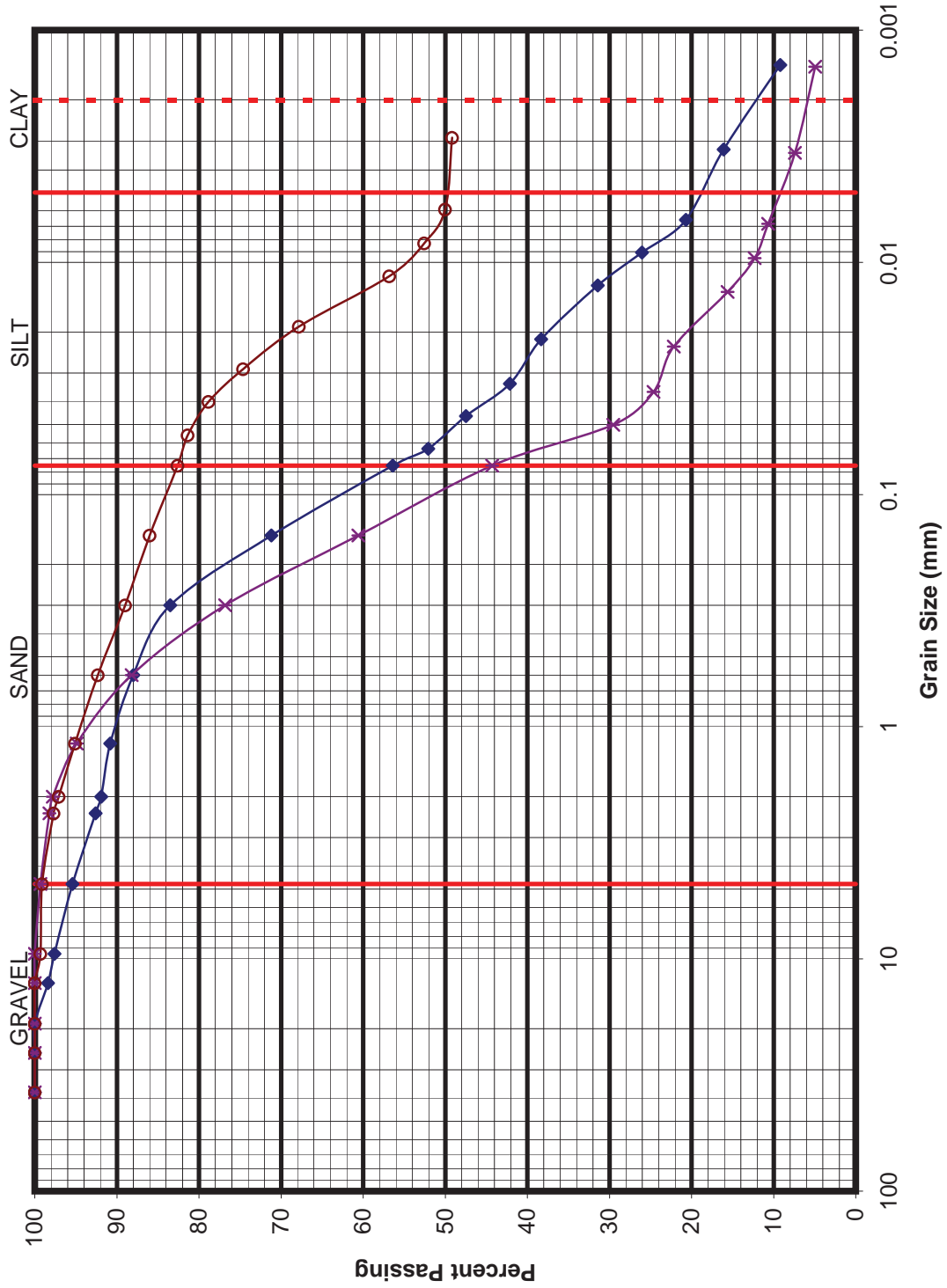

SHEAR TEST DIAGRAM

Material: Composite Plot for Engineered Fill

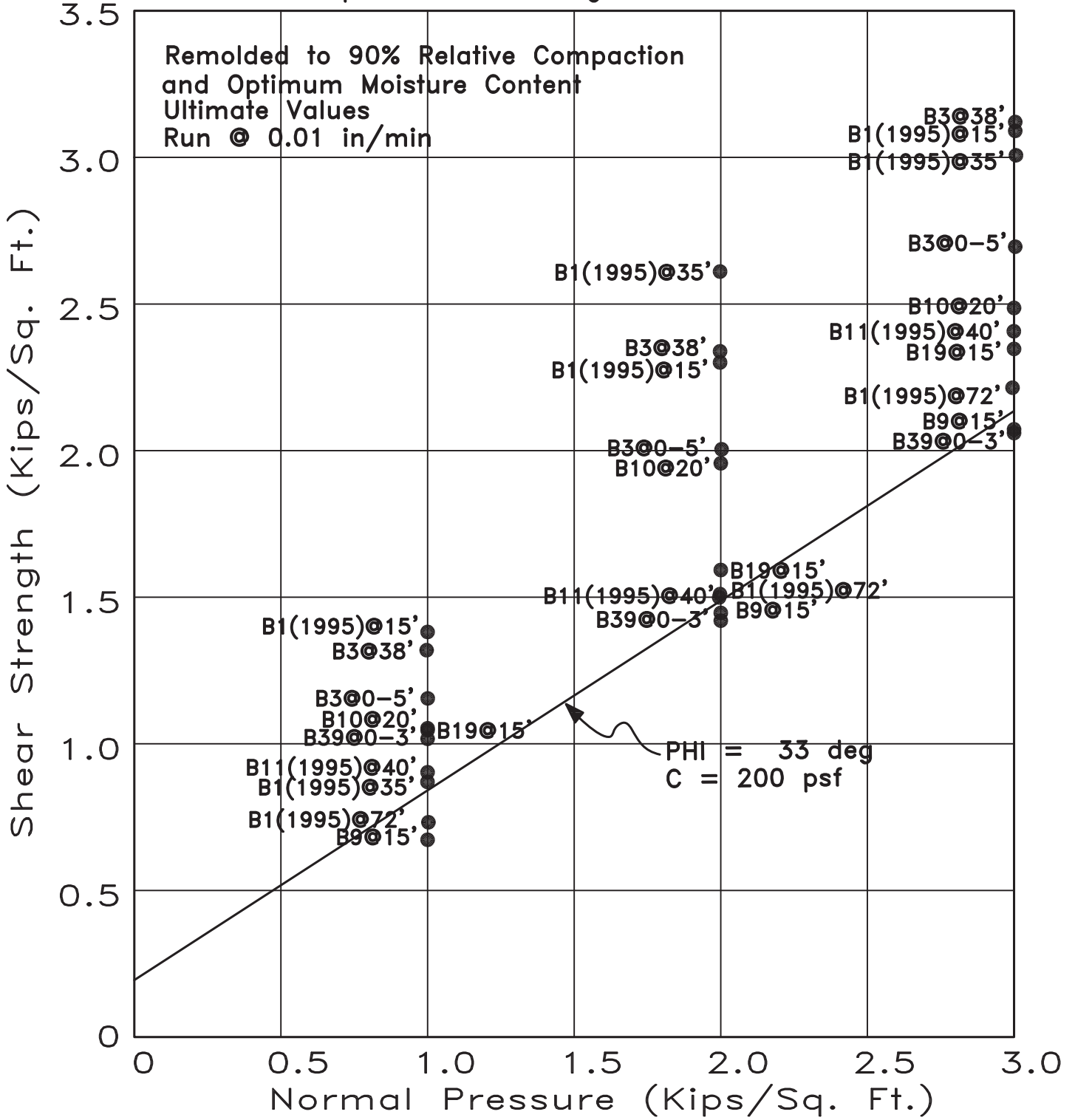

Project Tr. 060922 Skyline Ranch
 Excavation See Above
 Depth See Above



Geolabs - Westlake Village
 GEOLOGY AND SOIL ENGINEERING

BY DS
 DATE _____ W.O. 8838

SHEAR TEST DIAGRAM

COMPOSITE PLOT

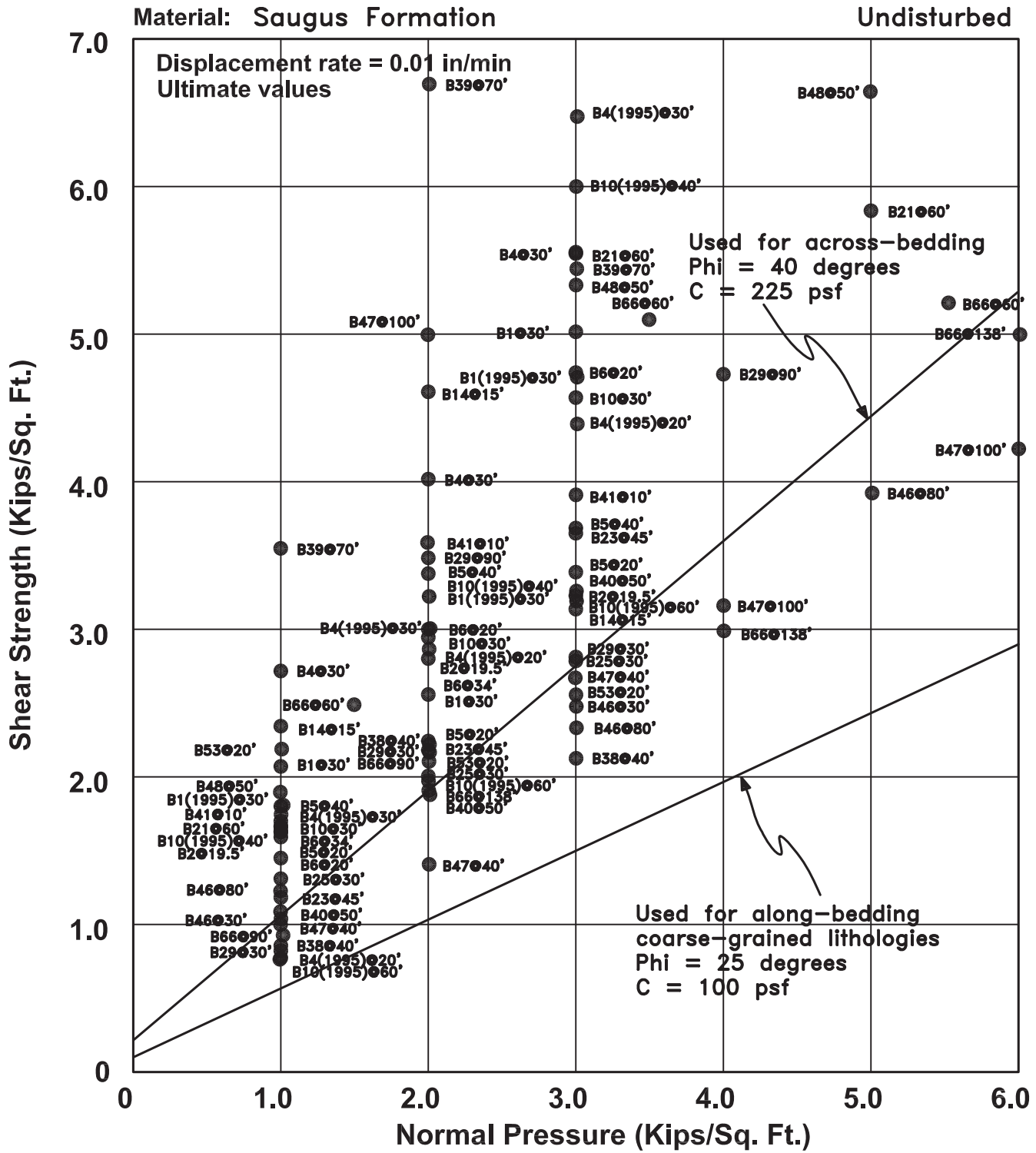

Project Skyline Ranch, Tr. 060922
 Excavation see graph
 Depth see graph



Geolabs - Westlake Village
 GEOLOGY AND SOIL ENGINEERING

BY SD
 DATE _____ W.O. 8838

SHEAR TEST DIAGRAM

COMPOSITE PLOT

Material: **Saugus Formation** Undisturbed
Along-bedding, fine-grained, unsheared

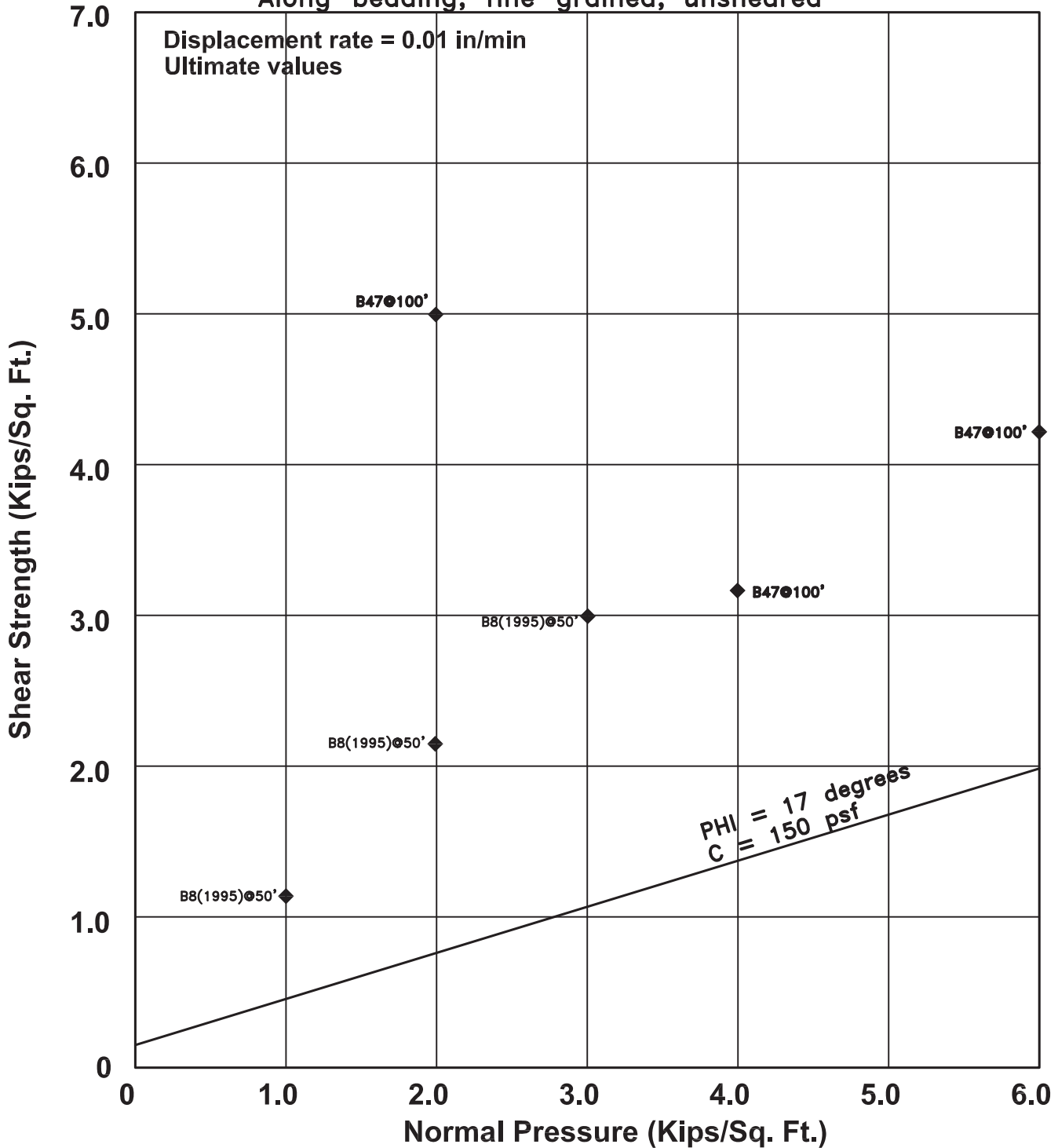

Project Skyline Ranch, Tr. 060922
 Excavation see graph
 Depth see graph



Geolabs - Westlake Village
 GEOLOGY AND SOIL ENGINEERING

BY SD
 DATE _____ W.O. 8838

SHEAR TEST DIAGRAM

Material: Saugus Formation - Along-bedding, fine-grained, sheared

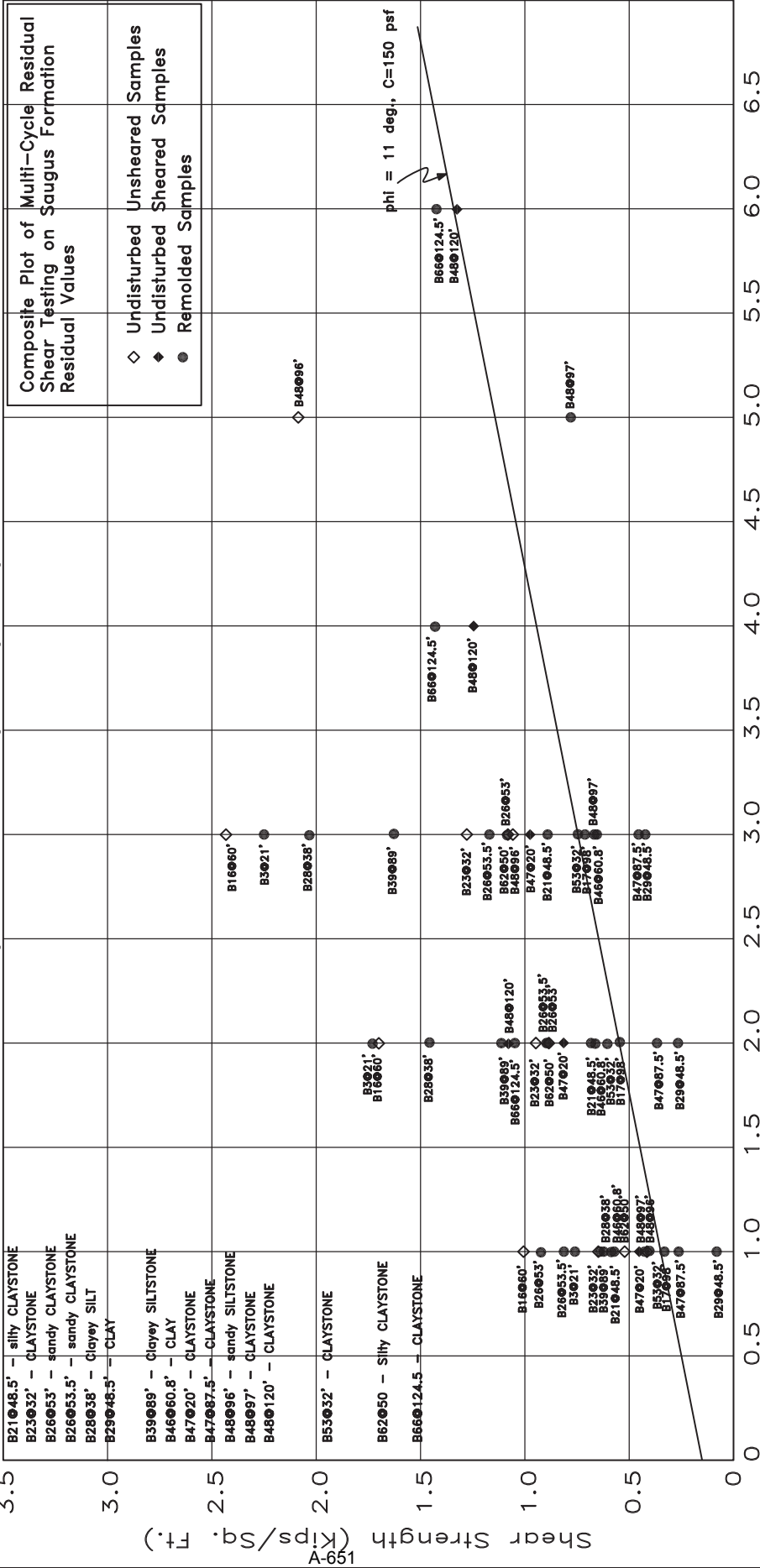

Composite Plot of Multi-Cycle Residual Shear Testing on Saugus Formation Residual Values

- ◇ Undisturbed Unsheared Samples
- ◆ Undisturbed Sheared Samples
- Remolded Samples

$\phi = 11 \text{ deg}, C = 150 \text{ psf}$

Normal Pressure (Kips/Sq. Ft.)

Project Tract 60922, Skyline Ranch
 Excavation Misc. _____
 Depth Misc. _____

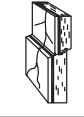

Geolabs - Westlake Village
 GEOLOGY AND SOIL ENGINEERING

DATE _____ BY W.O. 8838
 PLATE S.I.O.s-3

SHEAR TEST DIAGRAM

666030' ◆

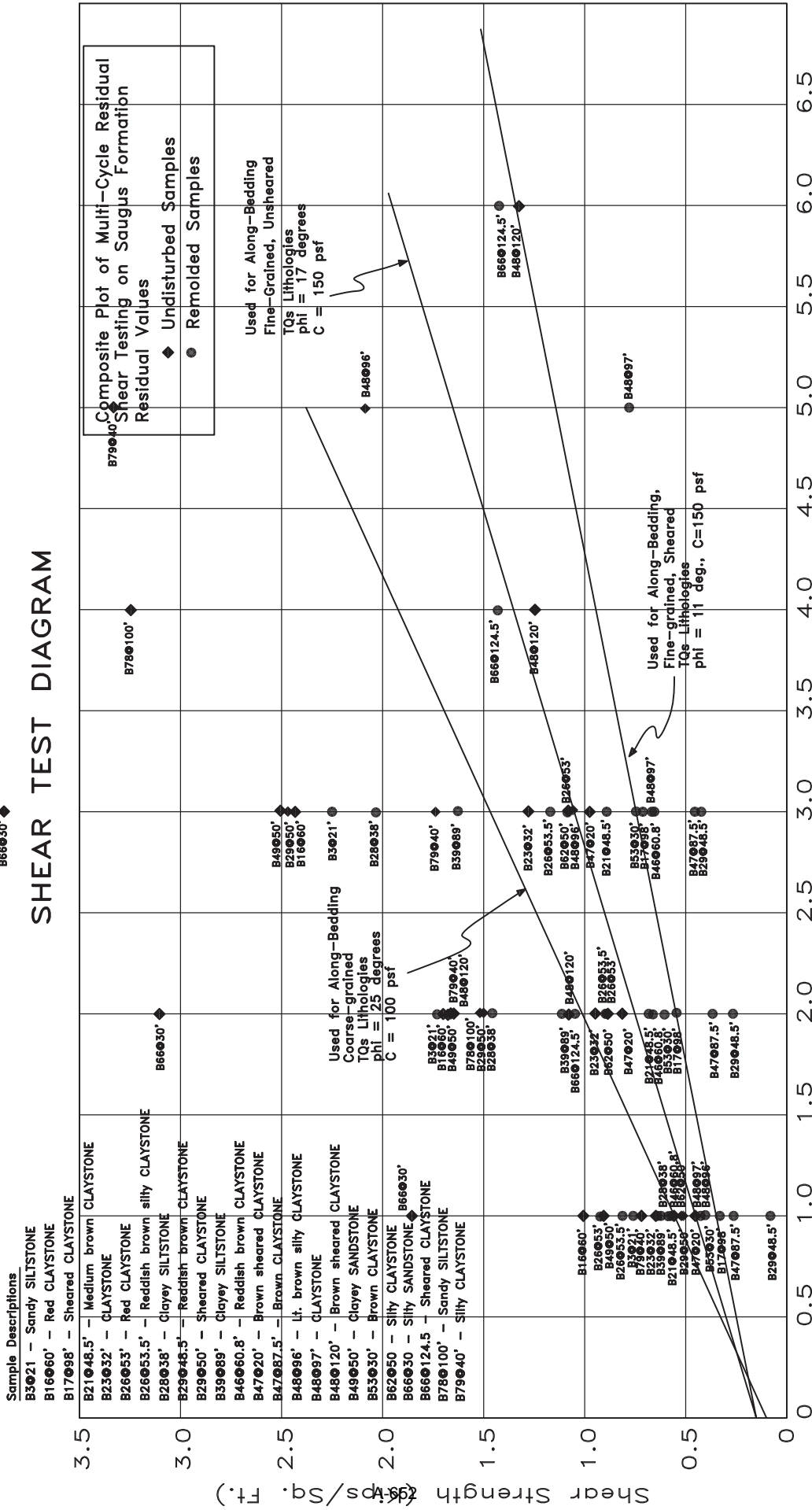

Normal Pressure (Kips/Sq. Ft.)

Project Tract 60922, Skyline Ranch
 Excavation Misc. _____
 Depth Misc. _____

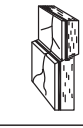

Geolabs - Westlake Village
 GEOLOGY AND SOIL ENGINEERING

DATE _____ BY: 8838
 DATE _____ BY: 8838
 DATE _____ BY: 8838

PLATE S10sm

SHEAR TEST DIAGRAM

COMPOSITE PLOT

Material: Landslide Slide Plane

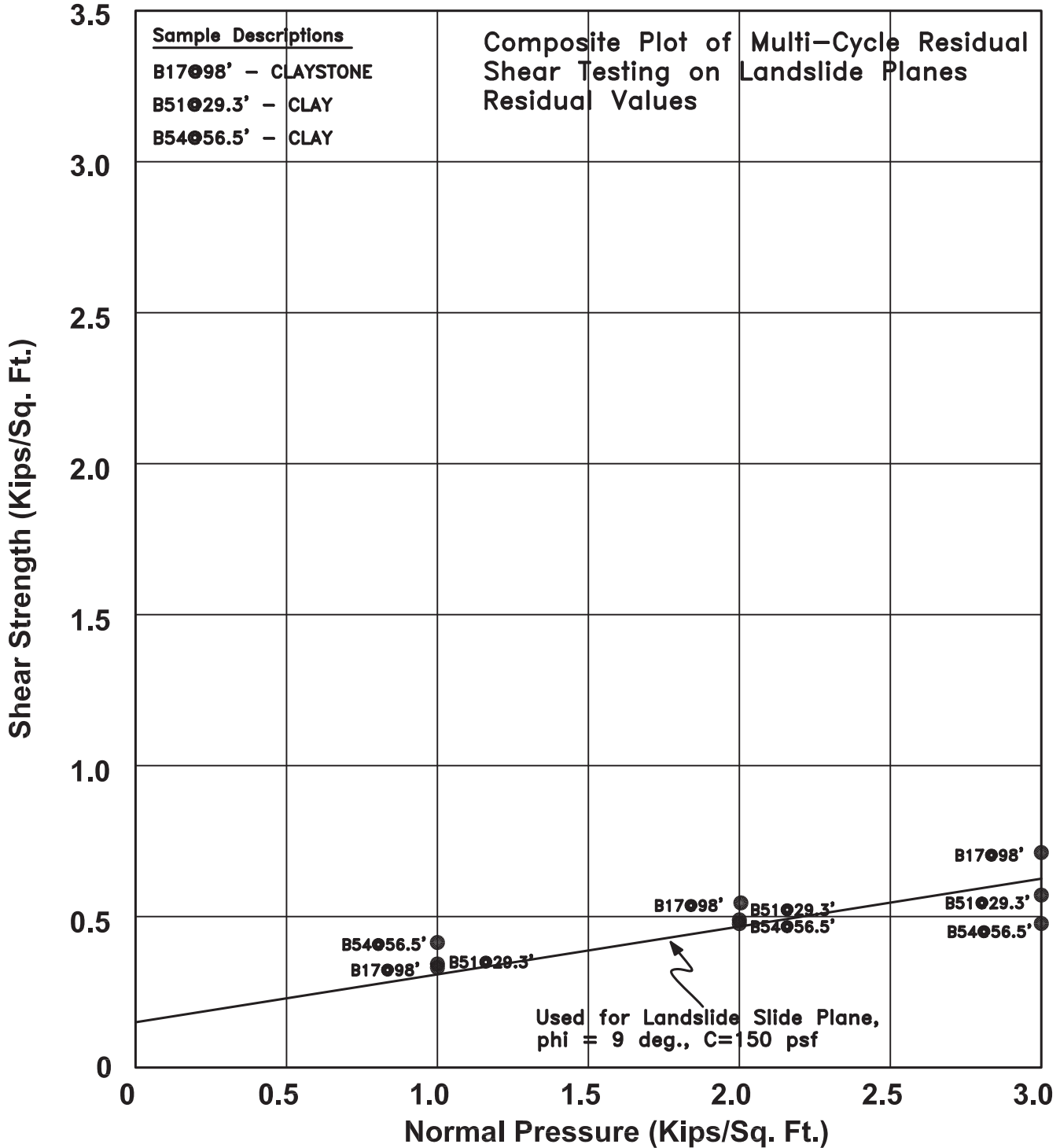

Project Skyline Ranch, Tr. 060922
 Excavation see graph
 Depth see graph



Geolabs - Westlake Village
 GEOLOGY AND SOIL ENGINEERING

DATE _____ BY SD
 W.O. 8838

SHEAR TEST DIAGRAM

Material: Composite Plot - Mint Canyon Formation

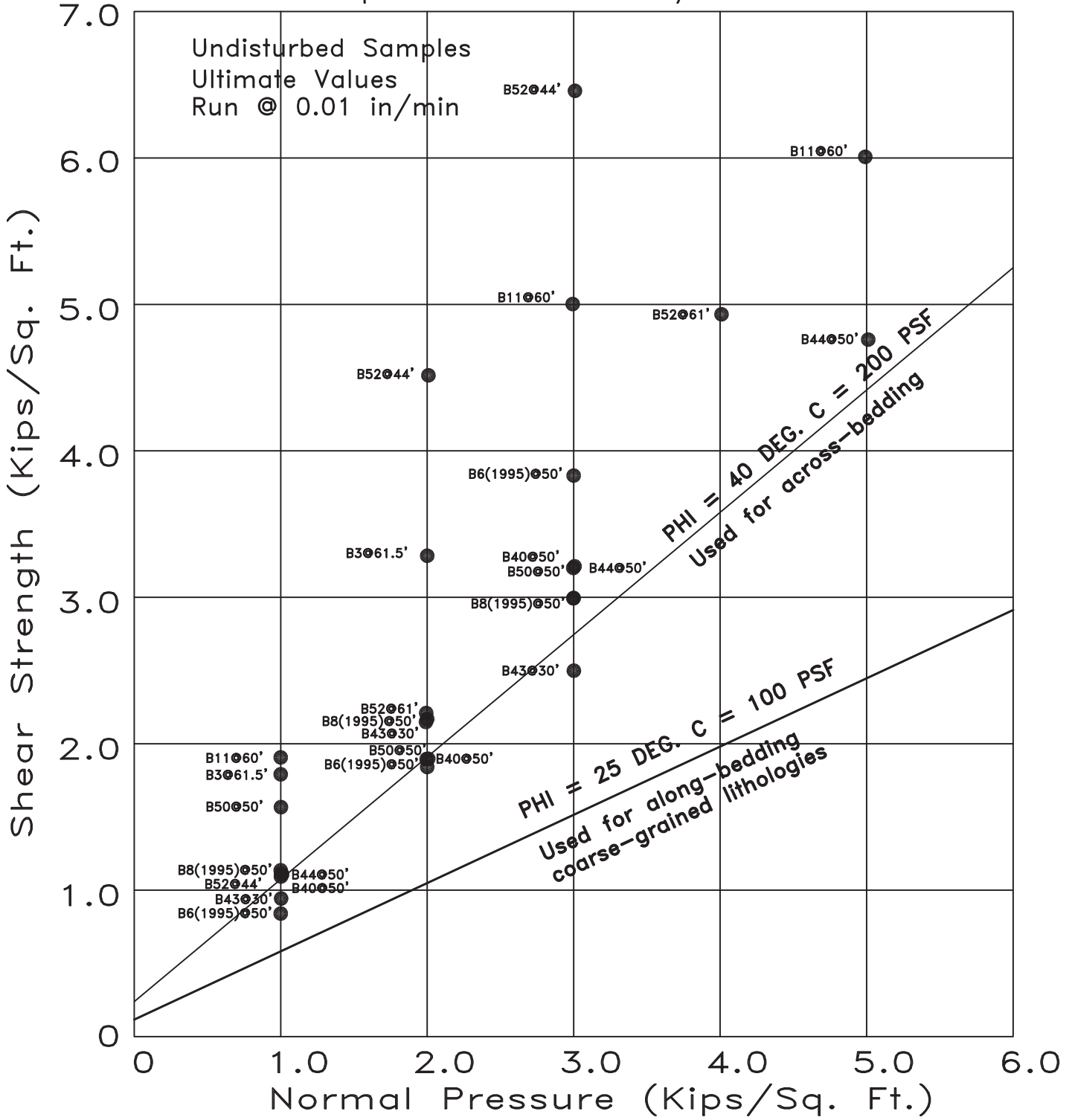

Project Skyline Ranch, Tr. 060922
 Excavation Misc.
 Depth Misc.



Geolabs - Westlake Village
GEOLOGY AND SOIL ENGINEERING

DATE _____ BY DS
 SCALE _____ W.O. 8838

SHEAR TEST DIAGRAM

Mint Canyon Formation

Material: Along-bedding, fine-grained, sheared

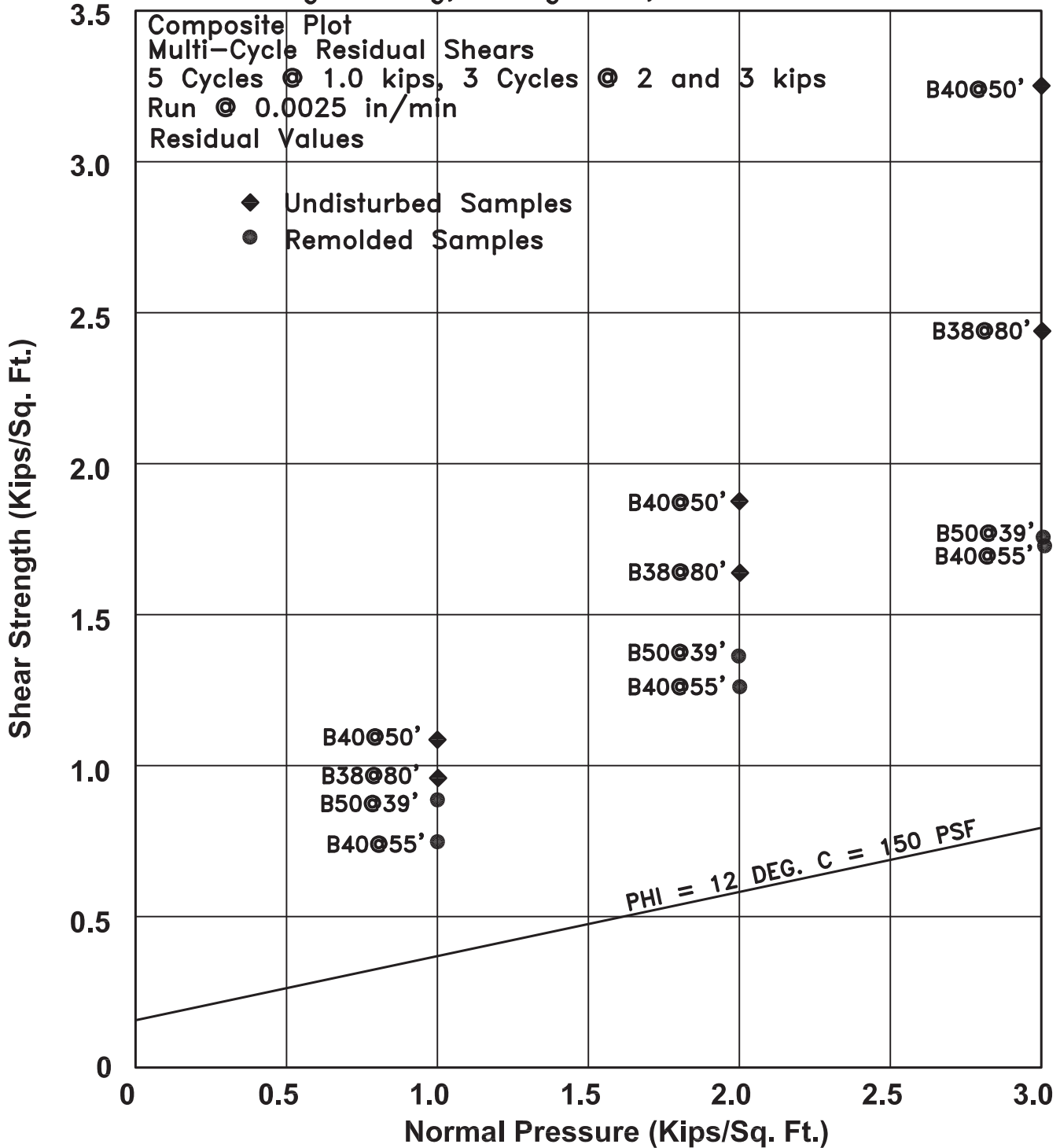

Project Tr. 60922 Skyline Ranch
 Excavation Misc.
 Depth Misc.



Geolabs - Westlake Village
 GEOLOGY AND SOIL ENGINEERING

DATE _____ BY _____
 W.O. 8838

SHEAR TEST DIAGRAM

Material: Saugus Formation - CONGLOMERATE

Presoaked, Undisturbed

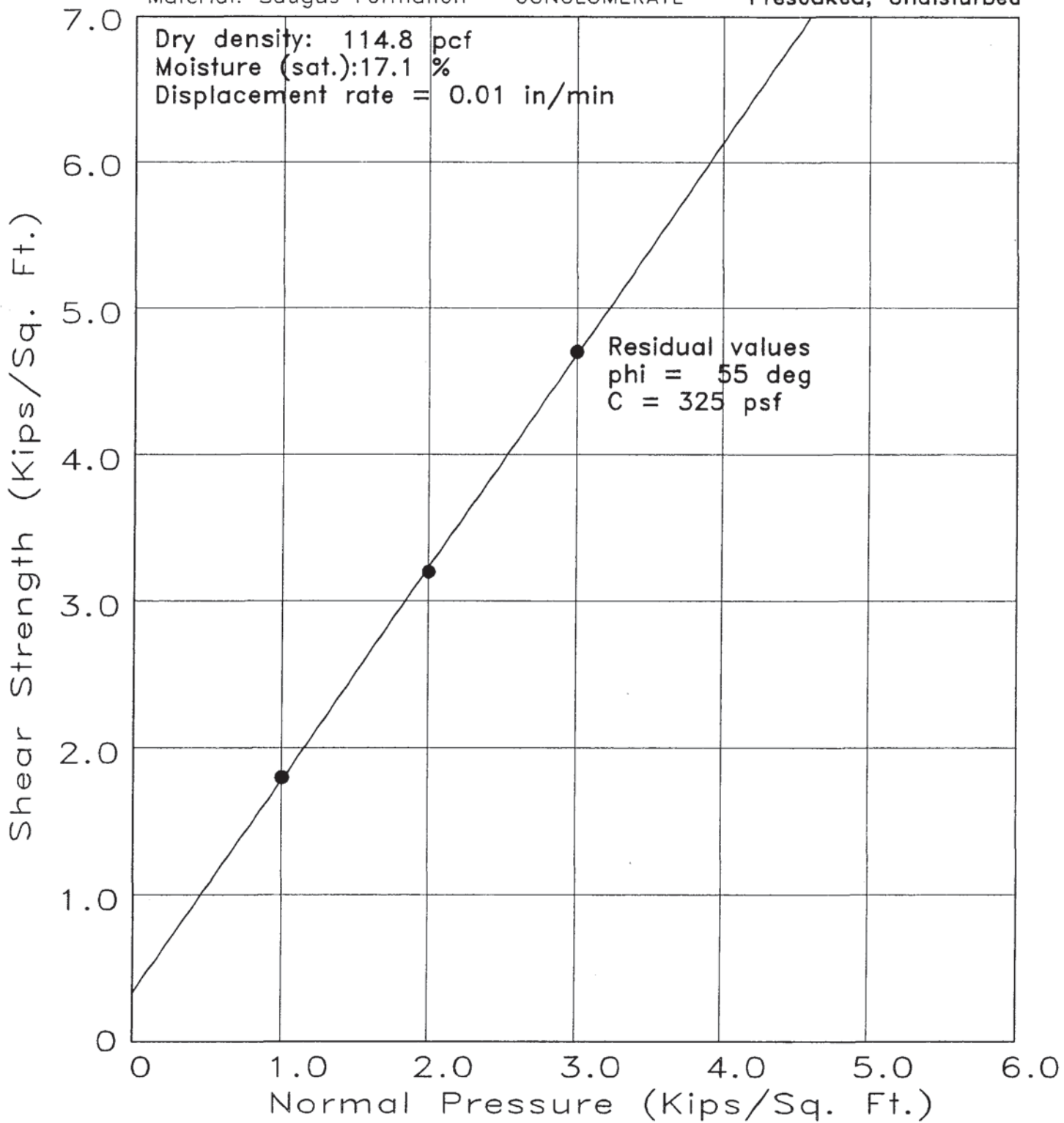

Project Skyline Ranch
 Excavation B1(1995)
 Depth 30'



Geolabs - Westlake Village
 GEOLOGY AND SOIL ENGINEERING

DATE 10/19/95 BY SD
 W.O. 8838

SHEAR TEST DIAGRAM

Material: Saugus Formation - SANDSTONE

Presoaked, Undisturbed

Dry Density: 112.2 pcf
 Moisture (sat.): 19.3 %
 Displacement rate = 0.01 in/min

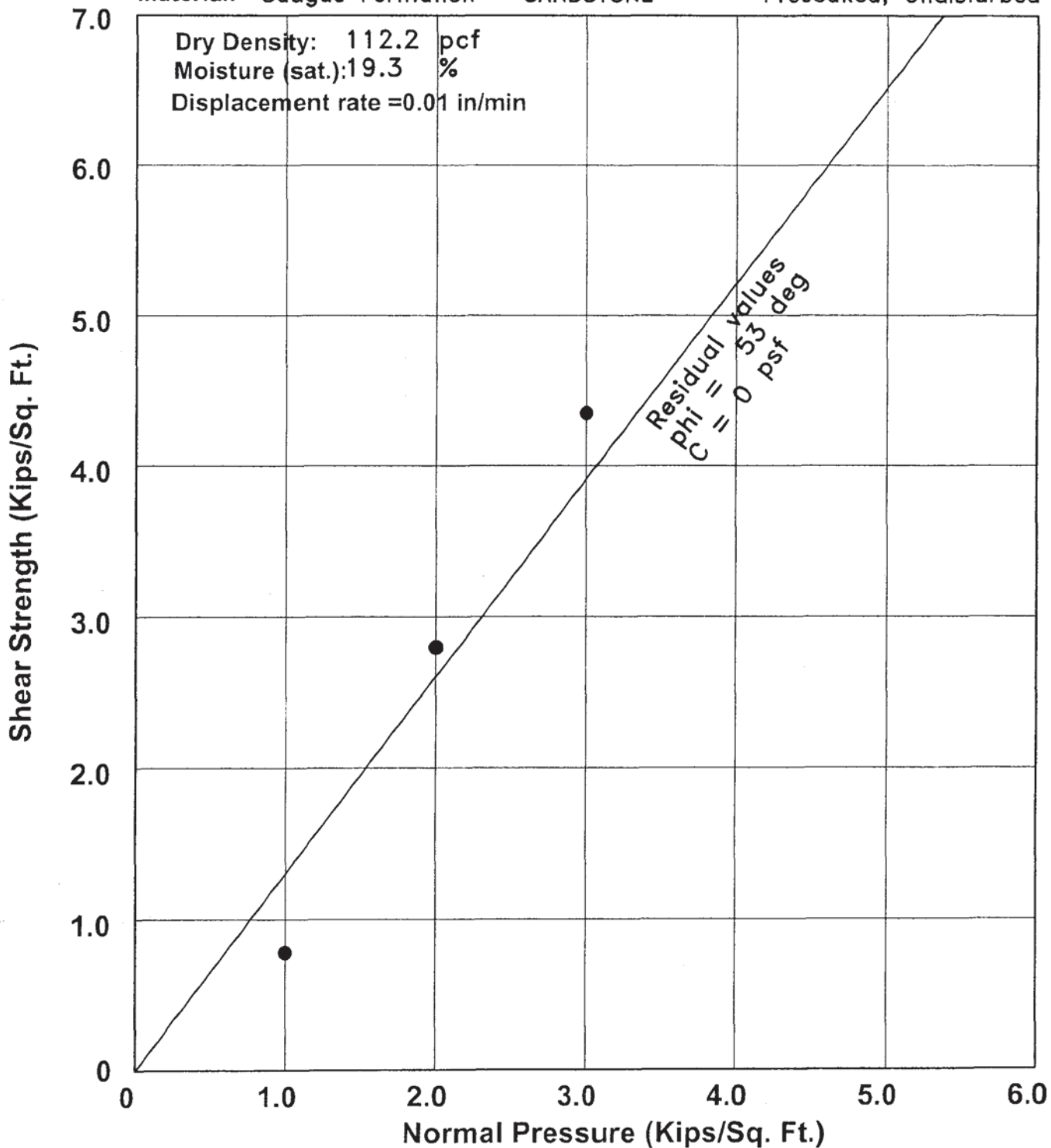

Project Skyline Ranch
 Excavation B4(1995)
 Depth 20'



Geolabs - Westlake Village
 GEOLOGY AND SOIL ENGINEERING

DATE 10/20/95 BY SD
 W.O. 8838

SHEAR TEST DIAGRAM

Material: Saugus Formation - CONGLOMERATE

Presoaked, Undisturbed

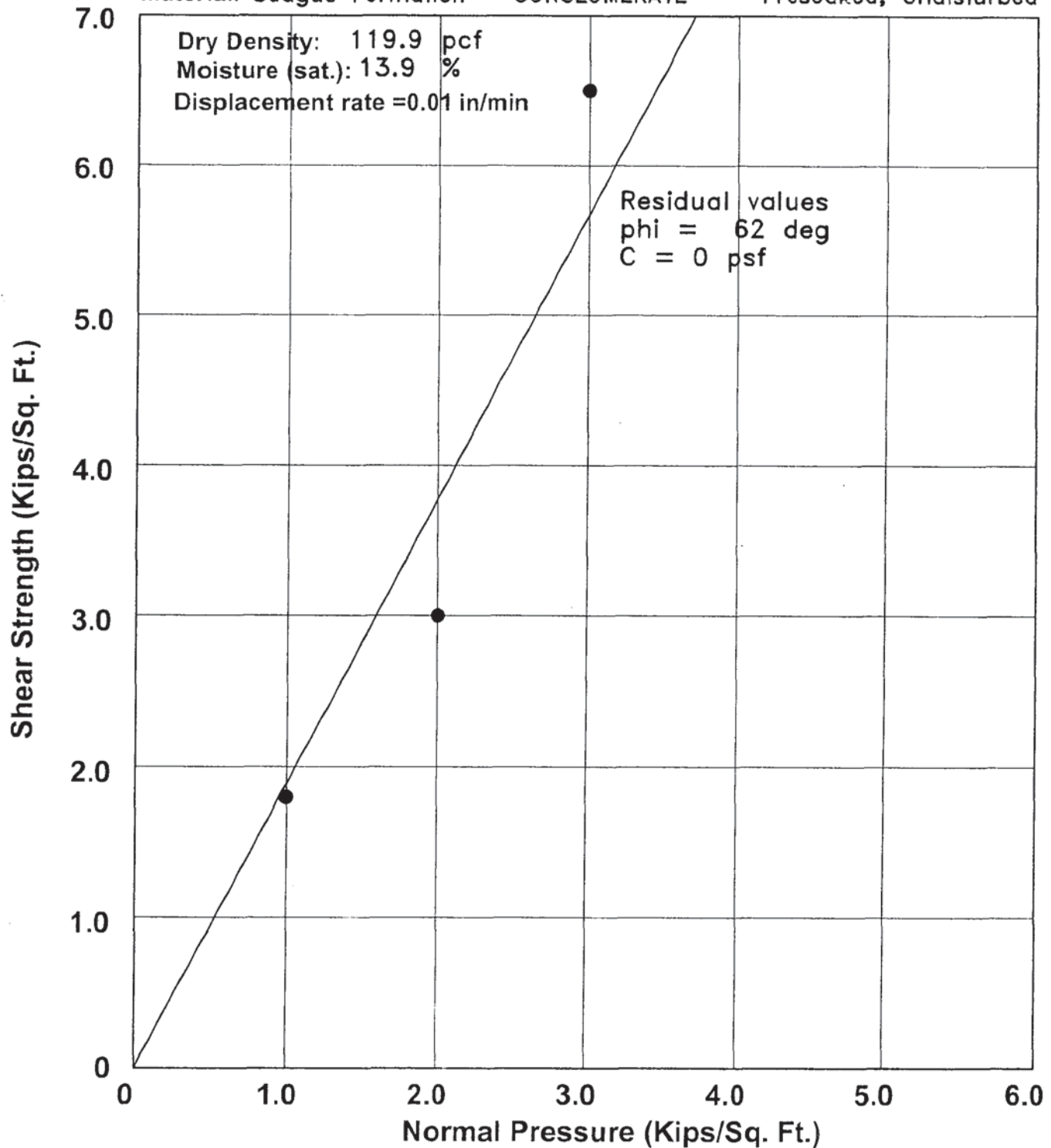

Project Skyline Ranch
 Excavation B4
 Depth 30'



Geolabs - Westlake Village
 GEOLOGY AND SOIL ENGINEERING

DATE 10/19/95 BY SD
 W.O. 8838

SHEAR TEST DIAGRAM

Material: Mint Canyon Fm. - CONGLOMERATE

Presoaked, Undisturbed

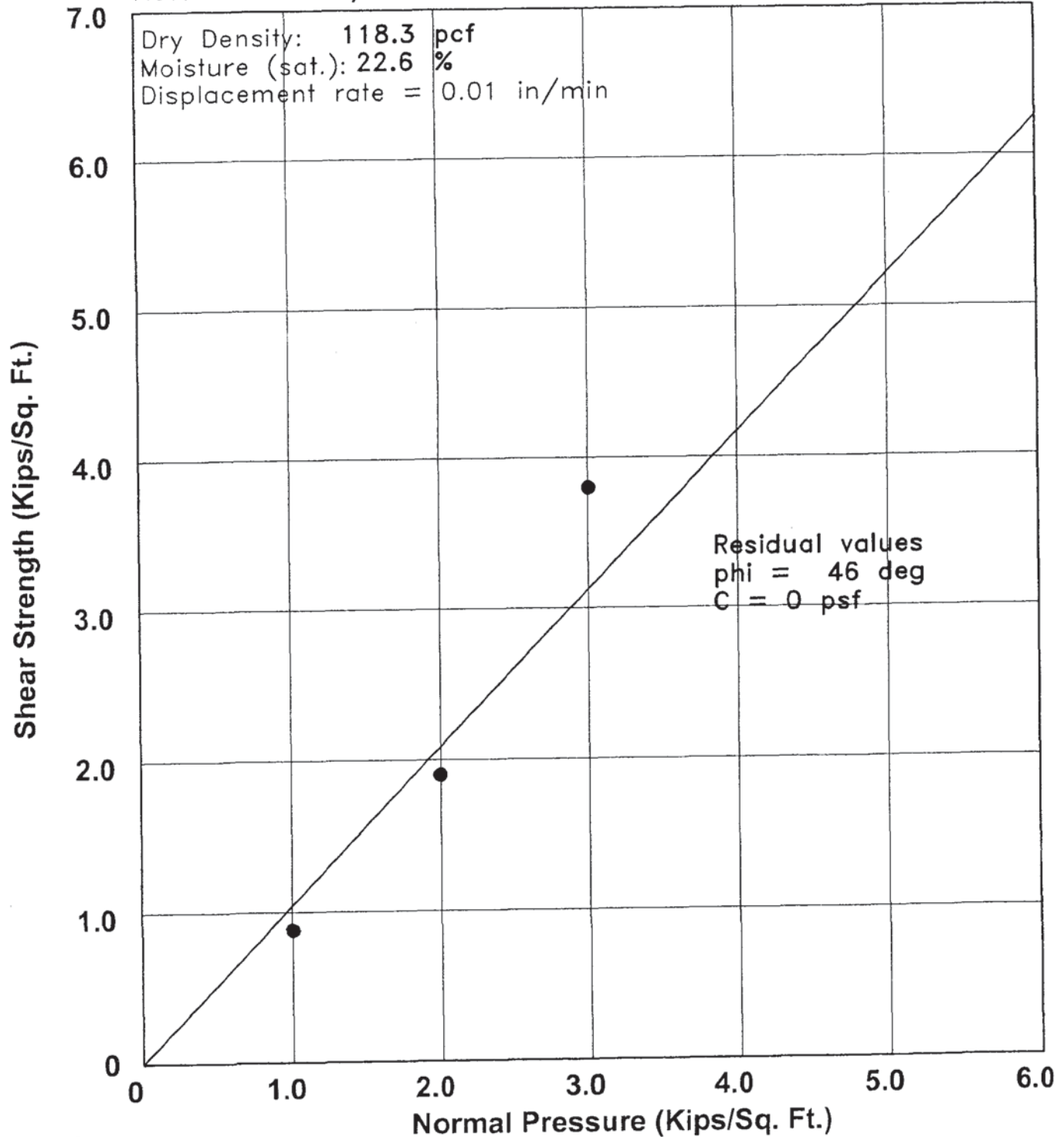

Project Skyline Ranch
 Excavation B6(1995)
 Depth 50'



Geolabs - Westlake Village
 GEOLOGY AND SOIL ENGINEERING

DATE 10/20/95 BY SD
 W.O. 8838

SHEAR TEST DIAGRAM

Material: Mint Canyon Fm. - CLAYSTONE Presoaked, ~~Presoaked~~, Undisturbed

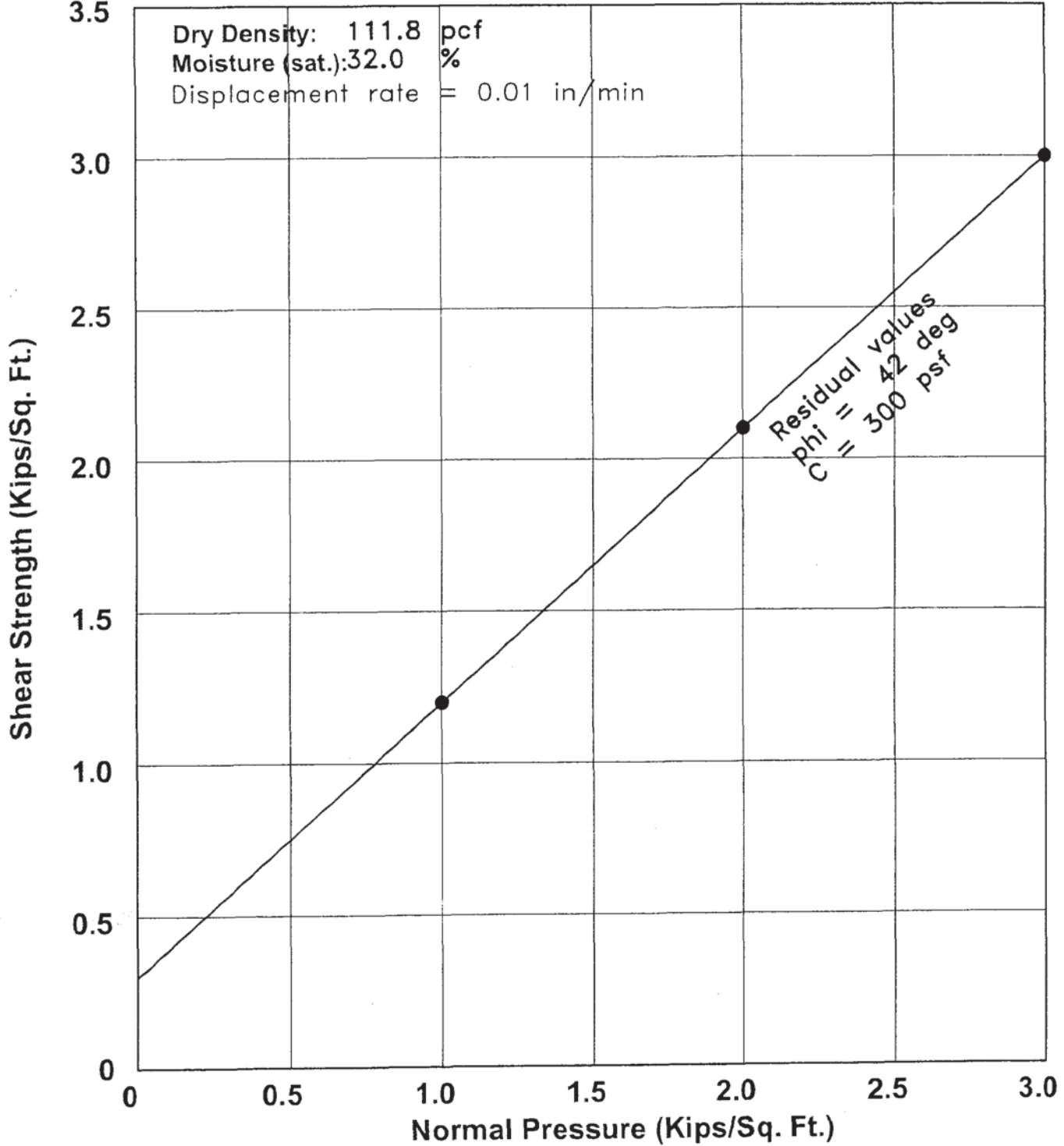

Project Skyline Ranch
 Excavation B8(1995)
 Depth 50'



Geolabs - Westlake Village
 GEOLOGY AND SOIL ENGINEERING

BY SD
 DATE 10/20/95 W.O. 8838

SHEAR TEST DIAGRAM

Material: Saugus Formation - gravelly SANDSTONE Presoaked, Undisturbed

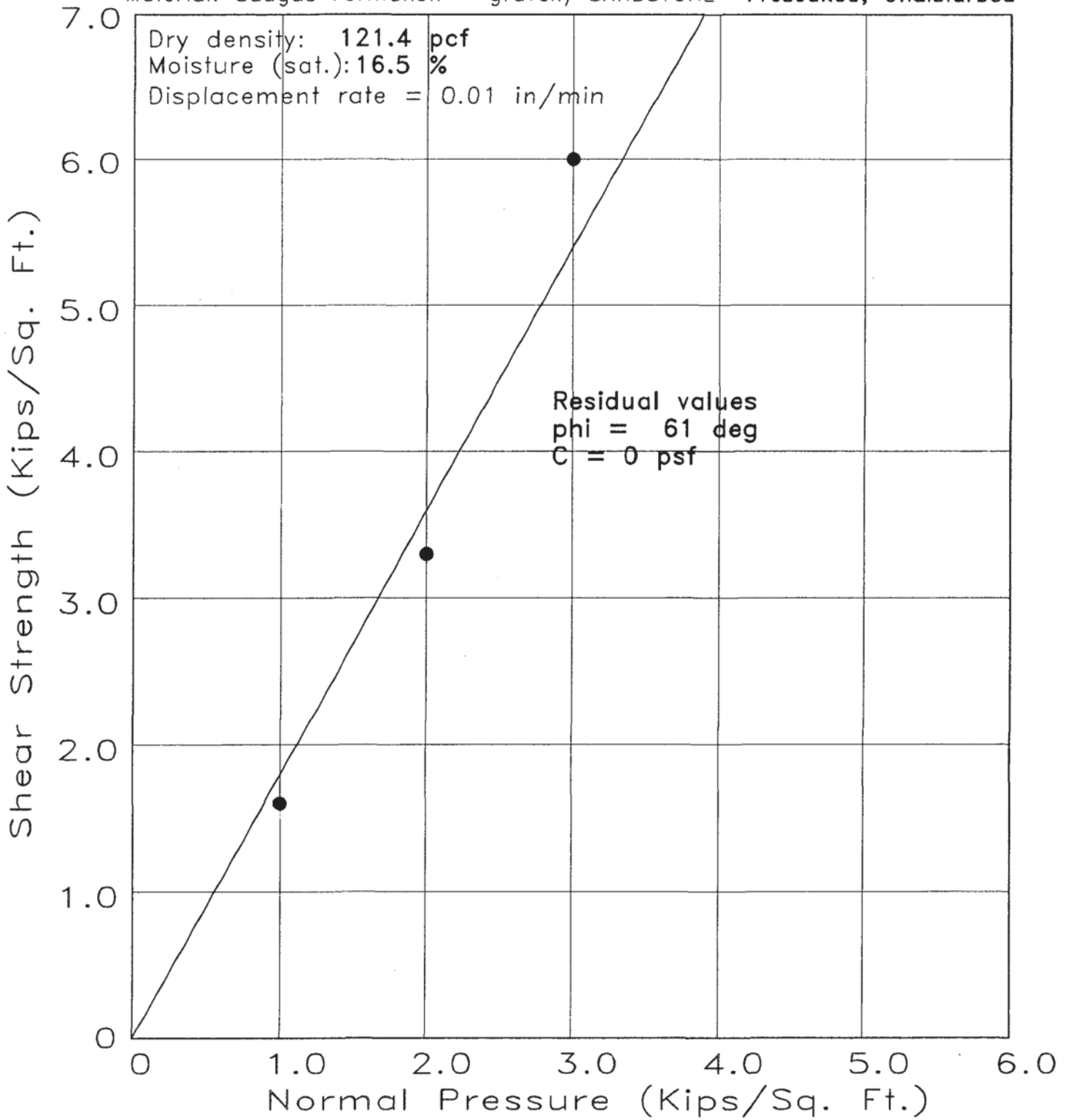

Project Skyline Ranch
 Excavation B10(1995)
 Depth 40'



Geolabs - Westlake Village
 GEOLOGY AND SOIL ENGINEERING

BY SD
 DATE 10/23/95 W.O. 8838

SHEAR TEST DIAGRAM

Material: Saugus Formation - SANDSTONE

Presoaked, Undisturbed

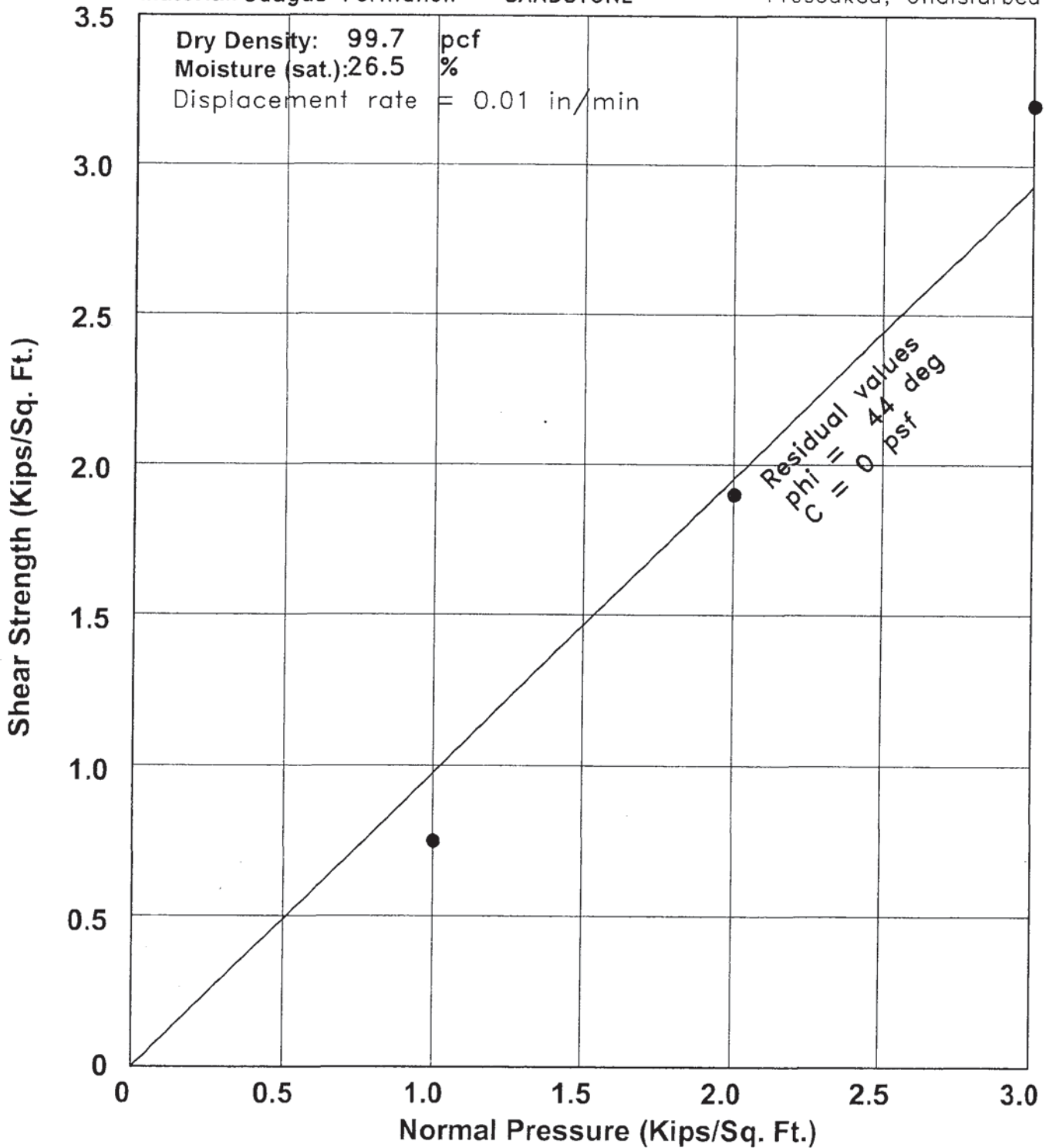

Project Skyline Ranch
 Excavation B10(1995)
 Depth 60'



Geolabs - Westlake Village
 GEOLOGY AND SOIL ENGINEERING

DATE 10/25/95 BY SD
 W.O. 8838

SHEAR TEST DIAGRAM

Material: Saugus Formation - gravelly SAND

Presoaked, Undisturbed

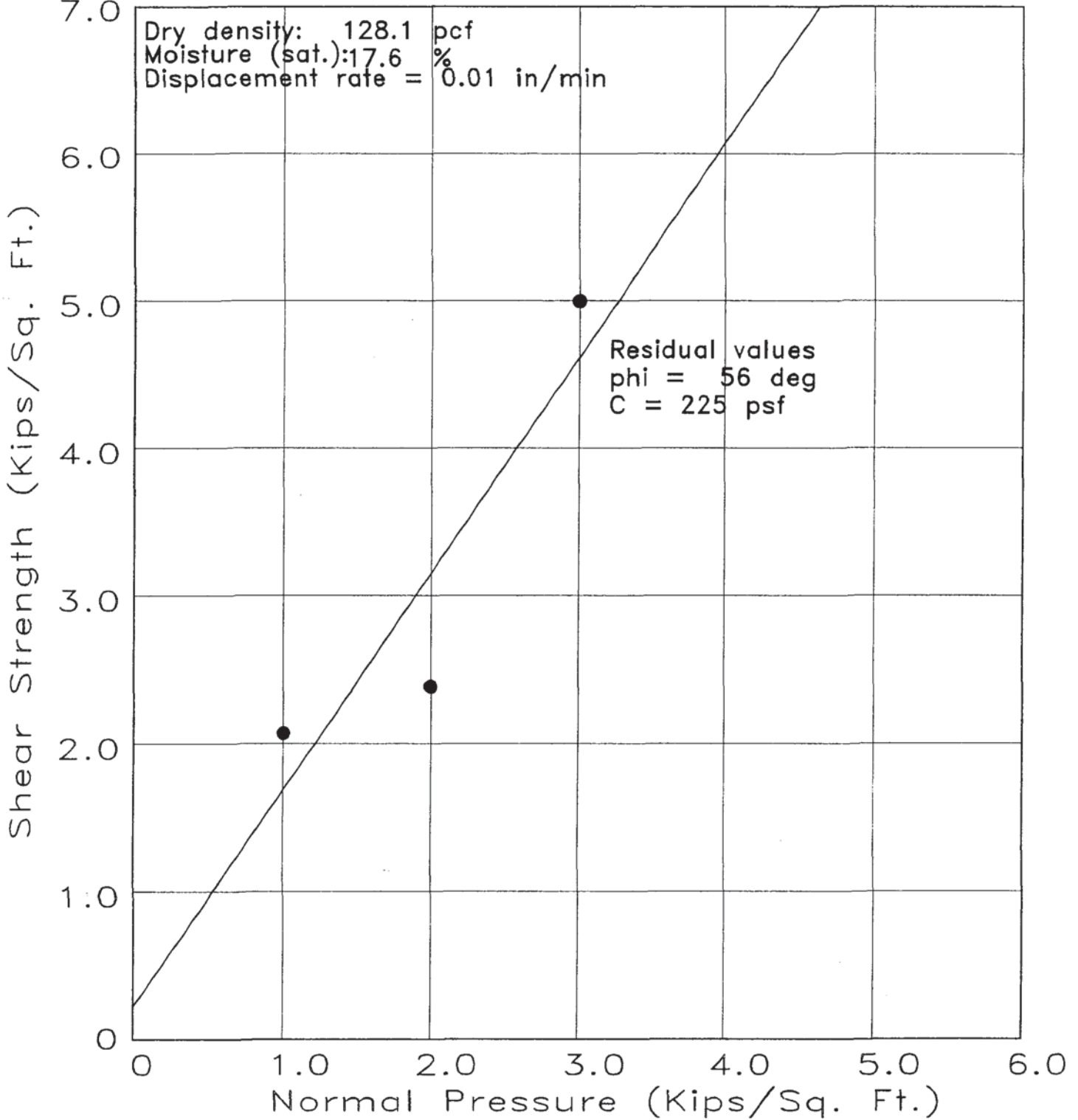

Project Skyline Ranch
 Excavation B1
 Depth 30'



Geolabs - Westlake Village
 GEOLOGY AND SOIL ENGINEERING

DATE 7/26/02 BY SD
 W.O. 8838

Excavation: B1 at 30 ft

W.O.: 8838

Displacement Rate: 0.01 in/min

SHEARS 1K, 2K, & 3K NORMAL LOADS

Undisturbed at 6.2%, sat. at 17.6%

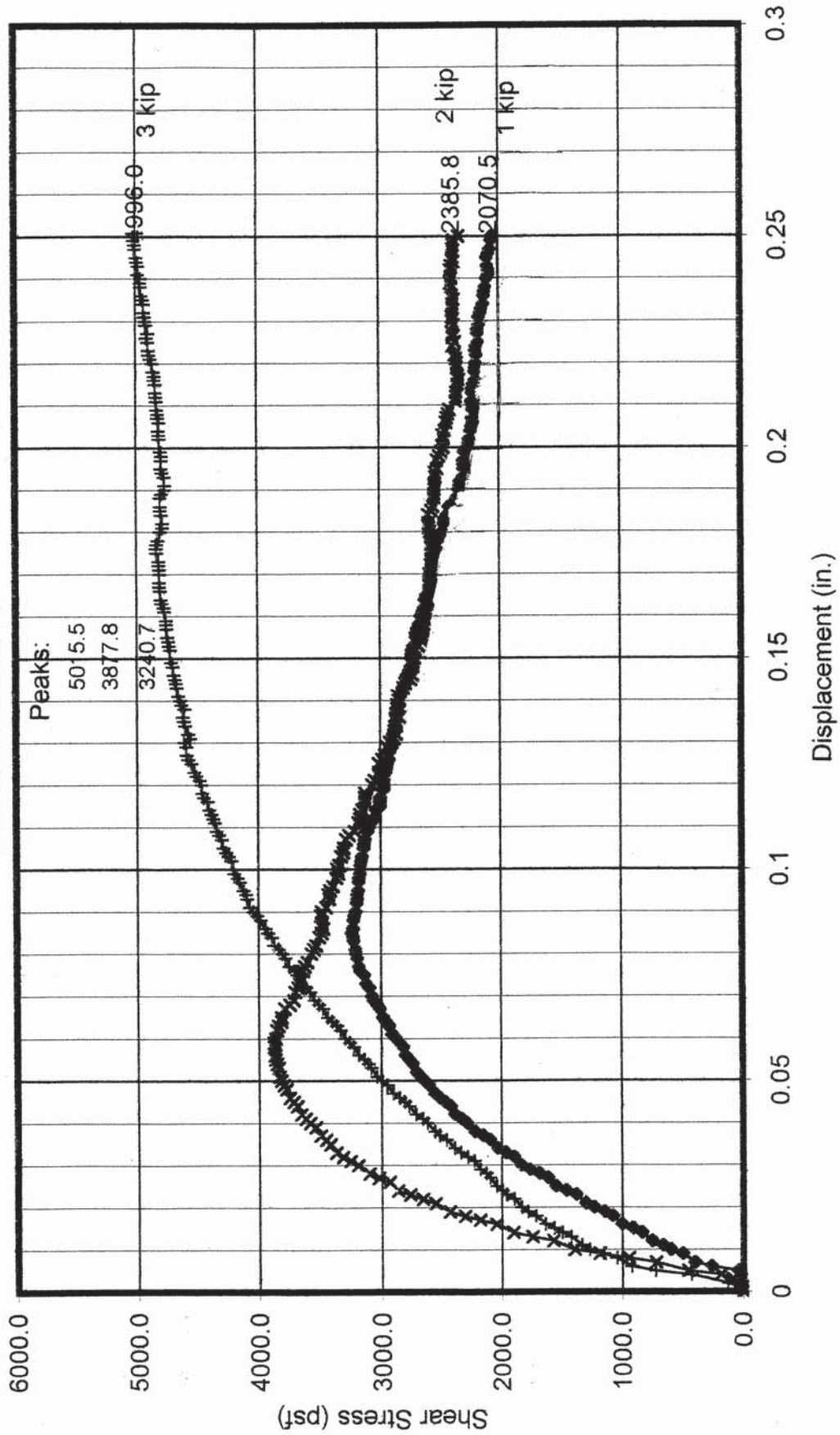

SHEAR TEST DIAGRAM

Material: Saugus Formation - CONGLOMERATE Presoaked, Undisturbed

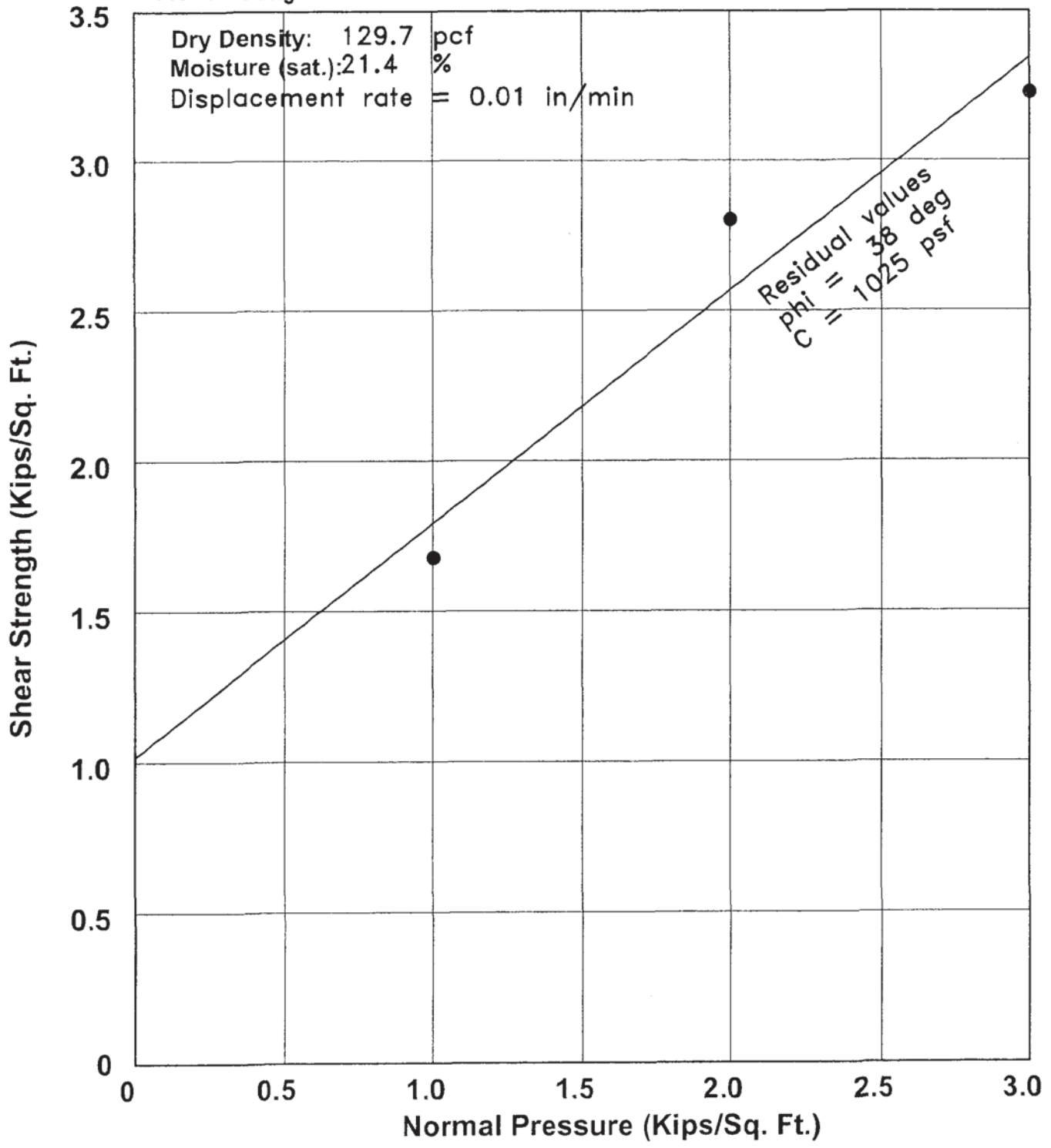

Project Skyline Ranch
 Excavation B2
 Depth 19.5'



Geolabs - Westlake Village
 GEOLOGY AND SOIL ENGINEERING

BY SD
 DATE 7/30/02 W.O. 8838

Excavation: B2 at 19.5 ft

W.O.: 8838

SHEARS 1K, 2K, & 3K NORMAL LOADS

Displacement Rate: 0.01 in/min

Undisturbed at 9.4%, sat. at 21.4%

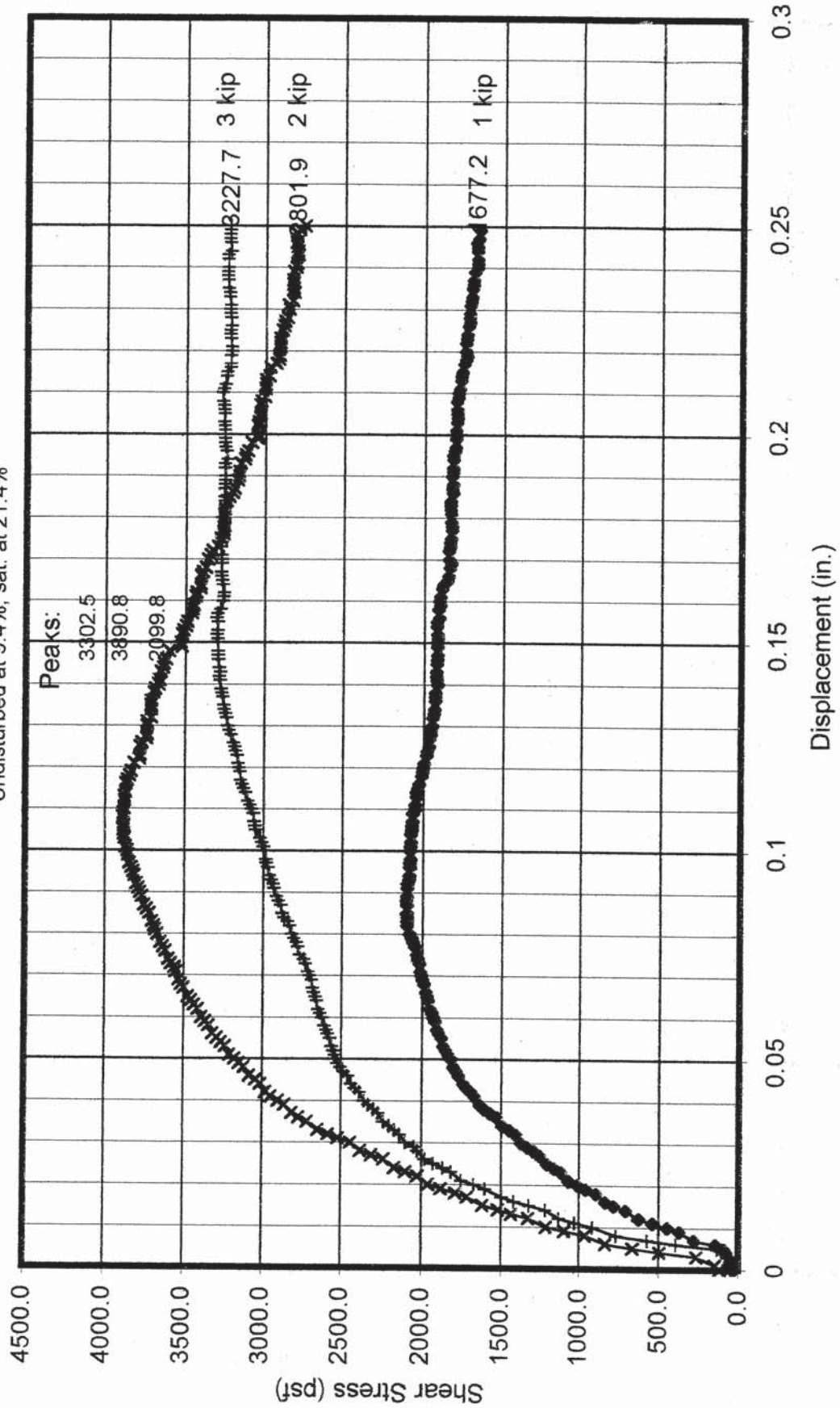

SHEAR TEST DIAGRAM

Material: Mint Canyon Formation - CONGLOMERATE Presoaked, Undisturbed

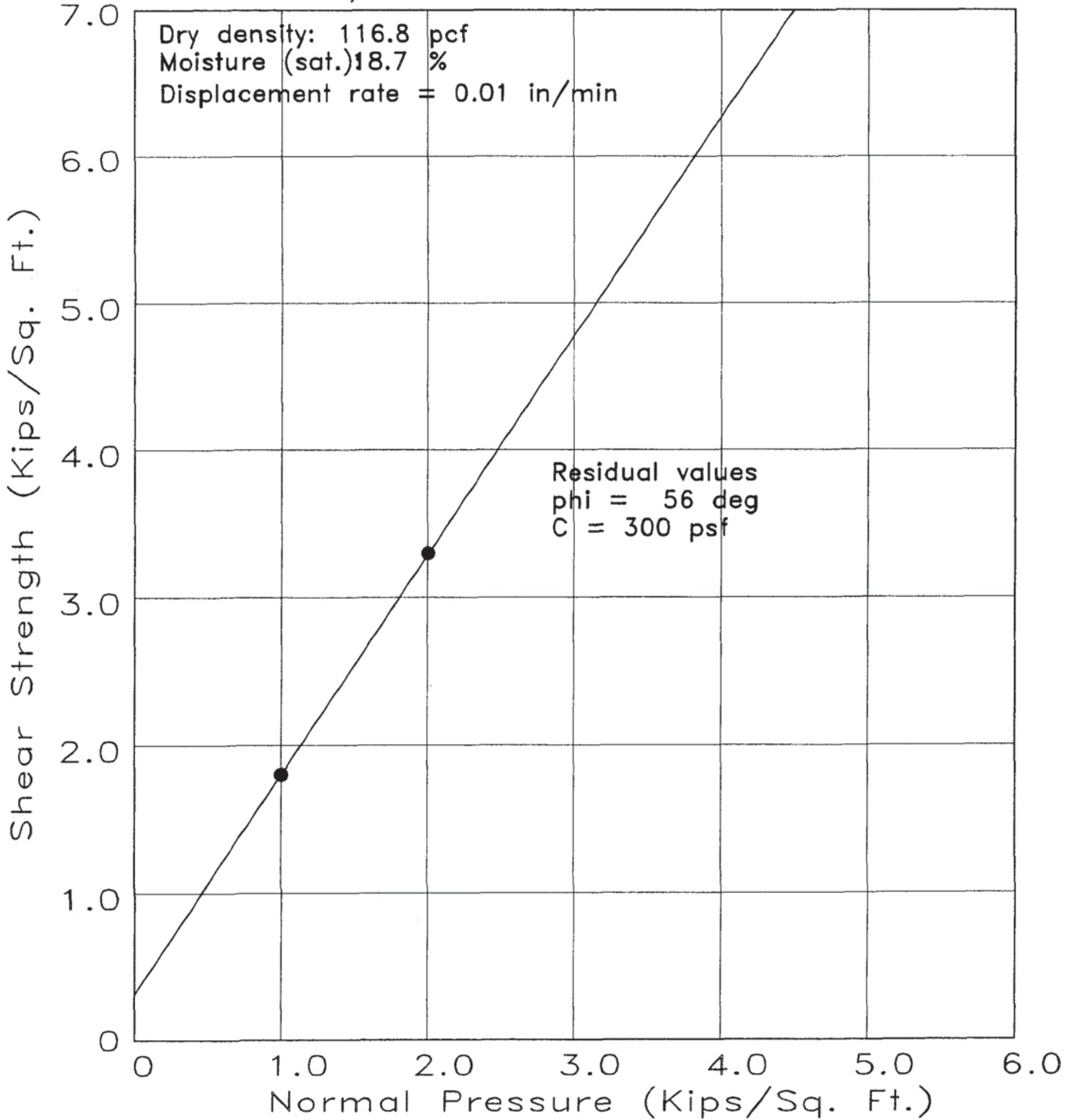

Project Skyline Ranch
 Excavation B3
 Depth 61.5'

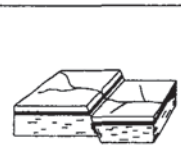

Geolabs - Westlake Village
 GEOLOGY AND SOIL ENGINEERING

DATE 8/14/02 BY SD
 W.O. 8838

Excavation: B3 at 61.5 ft

W.O.: 8838

Displacement Rate: 0.01 in/min

SHEARS 1K, 2K, & 3K NORMAL LOADS

Undisturbed at 4.7%, sat. at 18.7%

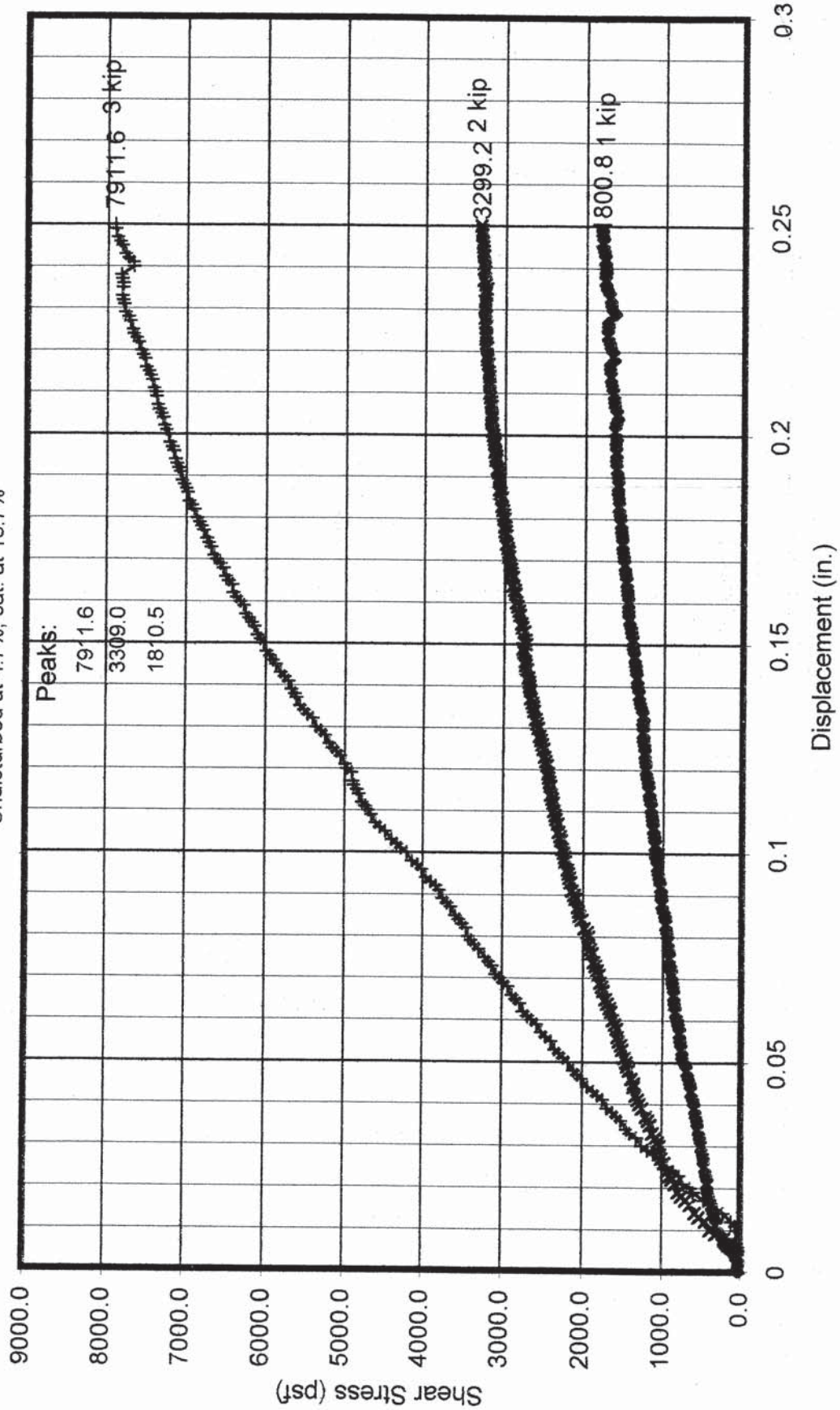

SHEAR TEST DIAGRAM

Material: Mint Canyon Formation – CONGLOMERATE Undisturbed

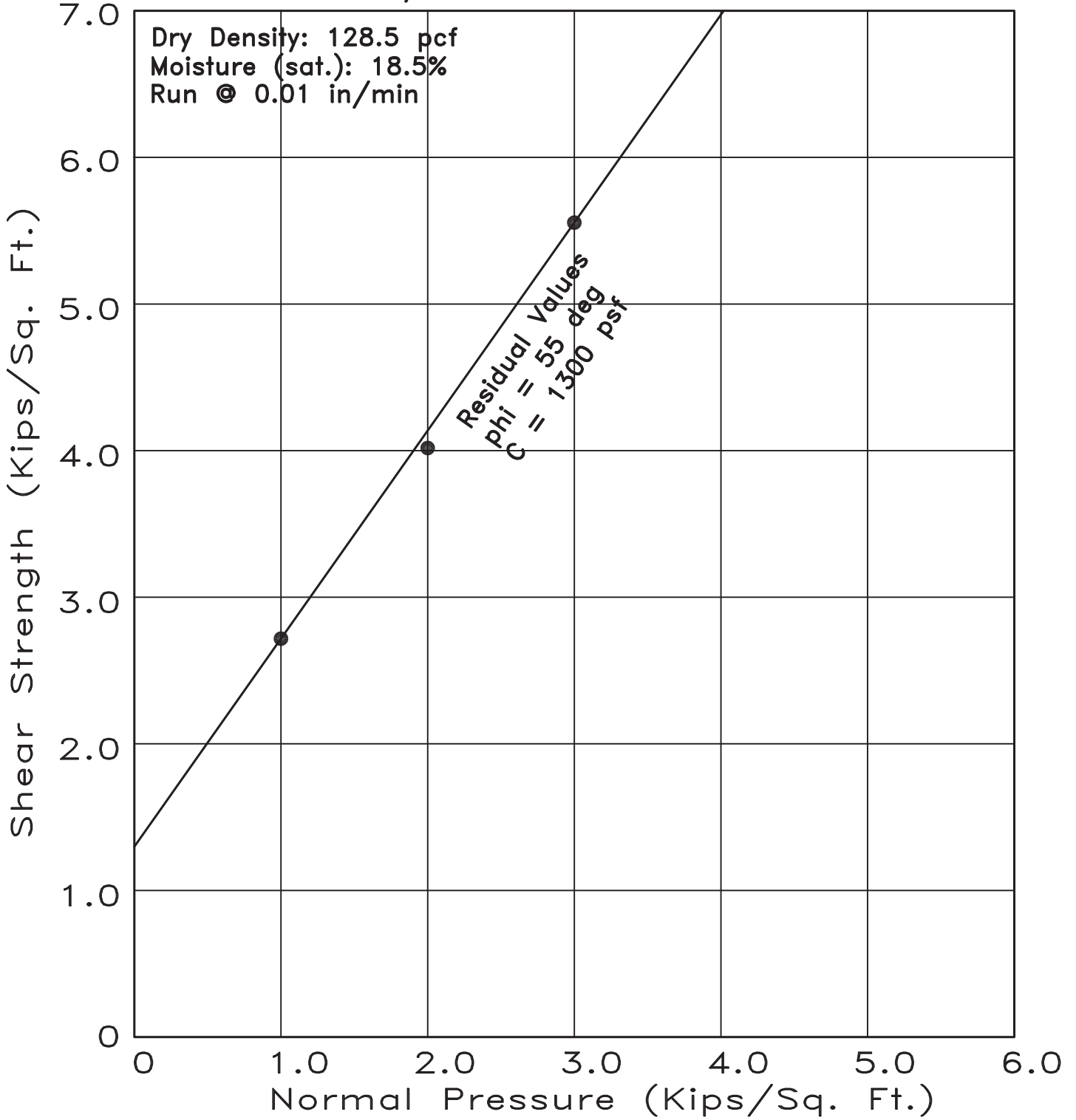

Project Skyline Ranch
 Excavation B4
 Depth 30 Feet



Geolabs – Westlake Village
 GEOLOGY AND SOIL ENGINEERING

BY SD
 DATE 8/14/02 W.O. 8838

Excavation: B4 at 30 ft

W.O.: 8838

Displacement Rate: 0.01 in/min

SHEARS 1K, 2K, & 3K NORMAL LOADS

Undisturbed, Sat at 18.5%

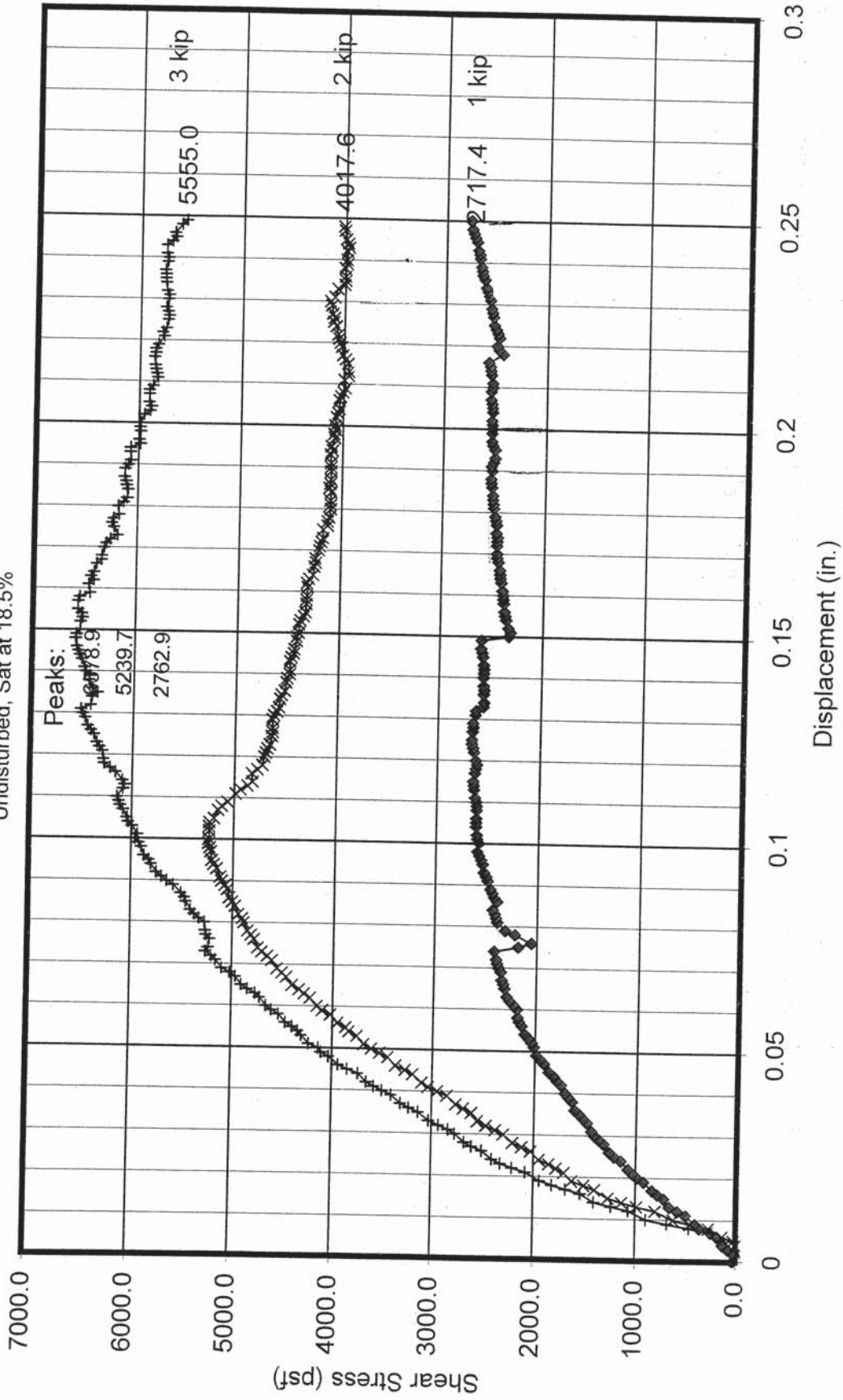

SHEAR TEST DIAGRAM

Material: Saugus Formation - gravelly SANDSTONE Presoaked, Undisturbed

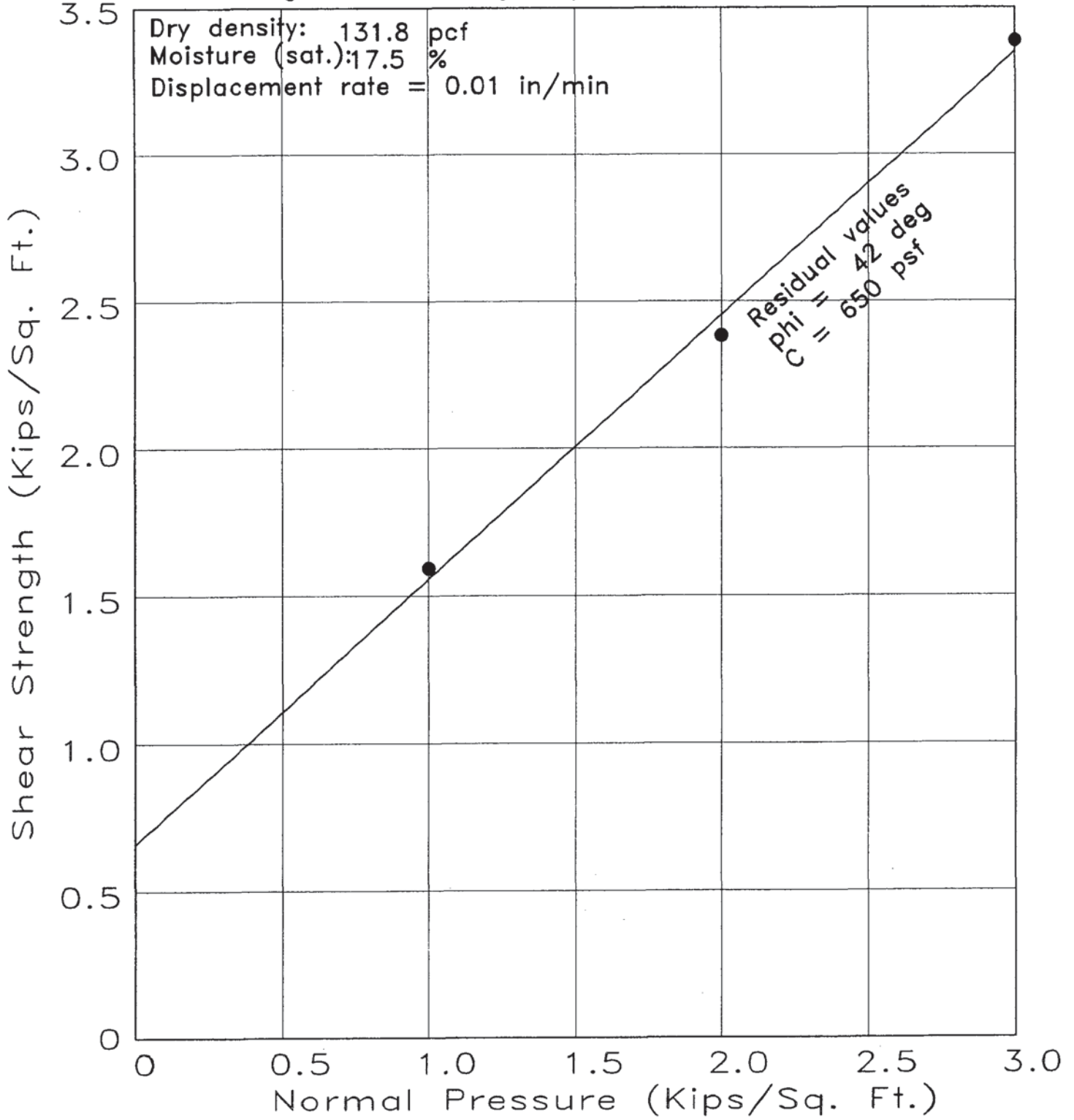

Project Skyline Ranch
 Excavation B5
 Depth 20'



Geolabs - Westlake Village
 GEOLOGY AND SOIL ENGINEERING

BY SD
 W.O. 8838

DATE 8/14/02

Excavation: B5 at 20 ft

W.O.: 8838

Displacement Rate: 0.01 in/min

SHEARS 1K, 2K, & 3K NORMAL LOADS

Undisturbed, Sat at 17.5%

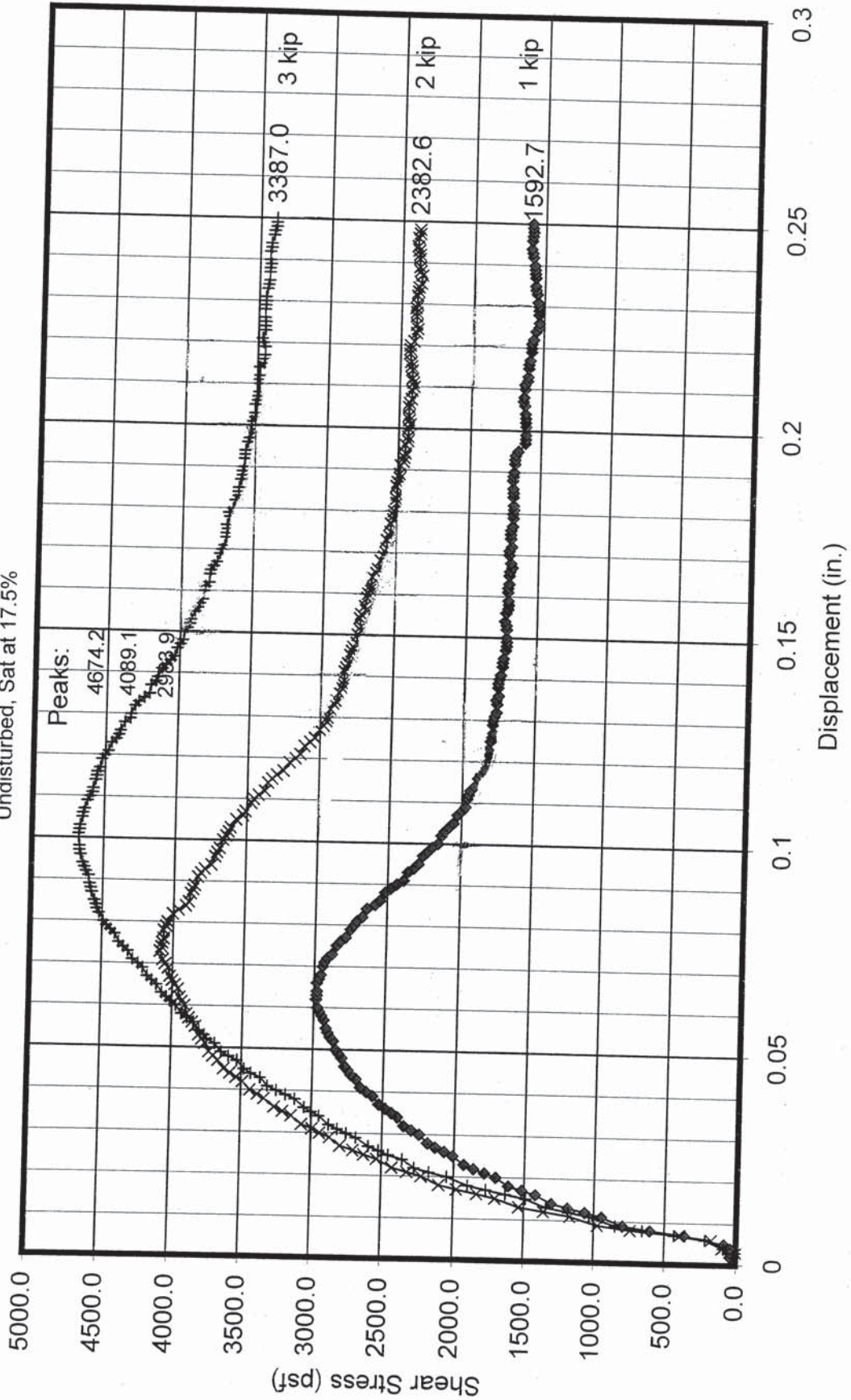

SHEAR TEST DIAGRAM

Material: Saugus Formation - CONGLOMERATE

Presoaked, Undisturbed

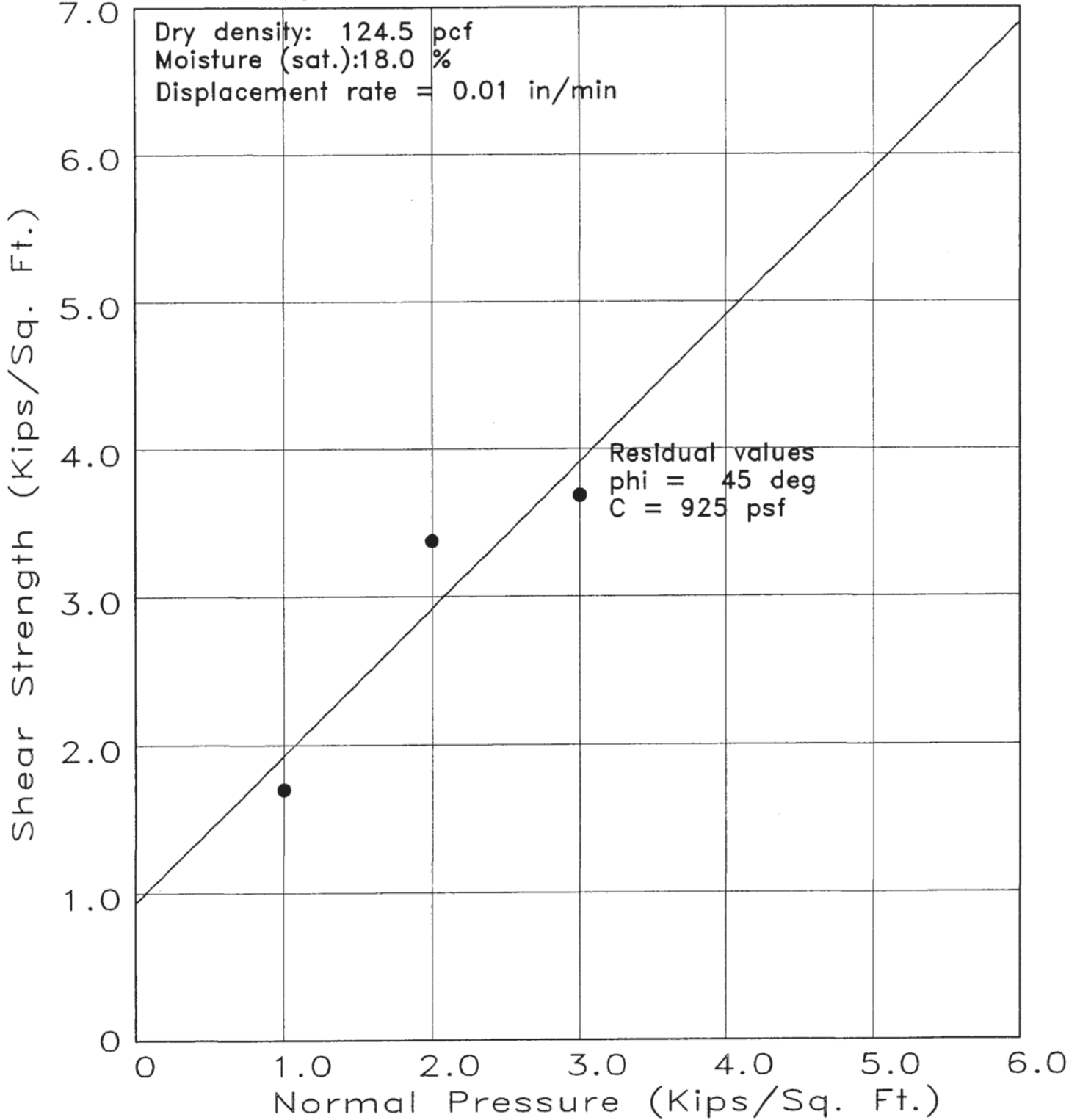

Project Skyline Ranch
 Excavation B5
 Depth 40'



Geolabs - Westlake Village
 GEOLOGY AND SOIL ENGINEERING

DATE 8/14/02 BY SD
 W.O. 8838

Excavation: B5 at 40 ft

W.O.: 8838

Displacement Rate: 0.01 in/min

SHEARS 1K, 2K, & 3K NORMAL LOADS

Undisturbed, sat at 18%

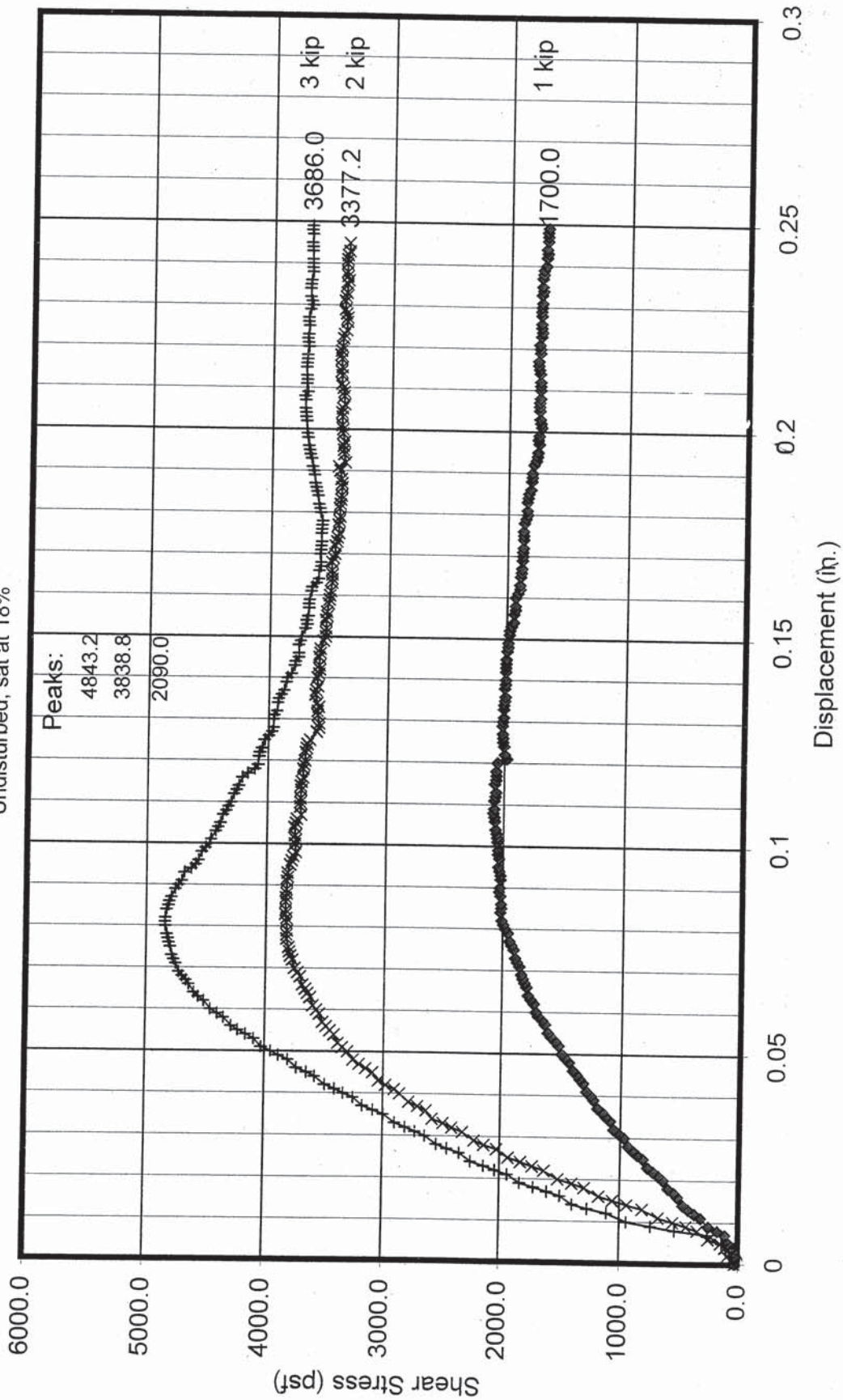

SHEAR TEST DIAGRAM

Material: Saugus Formation - gravelly SANDSTONE Presoaked, Undisturbed

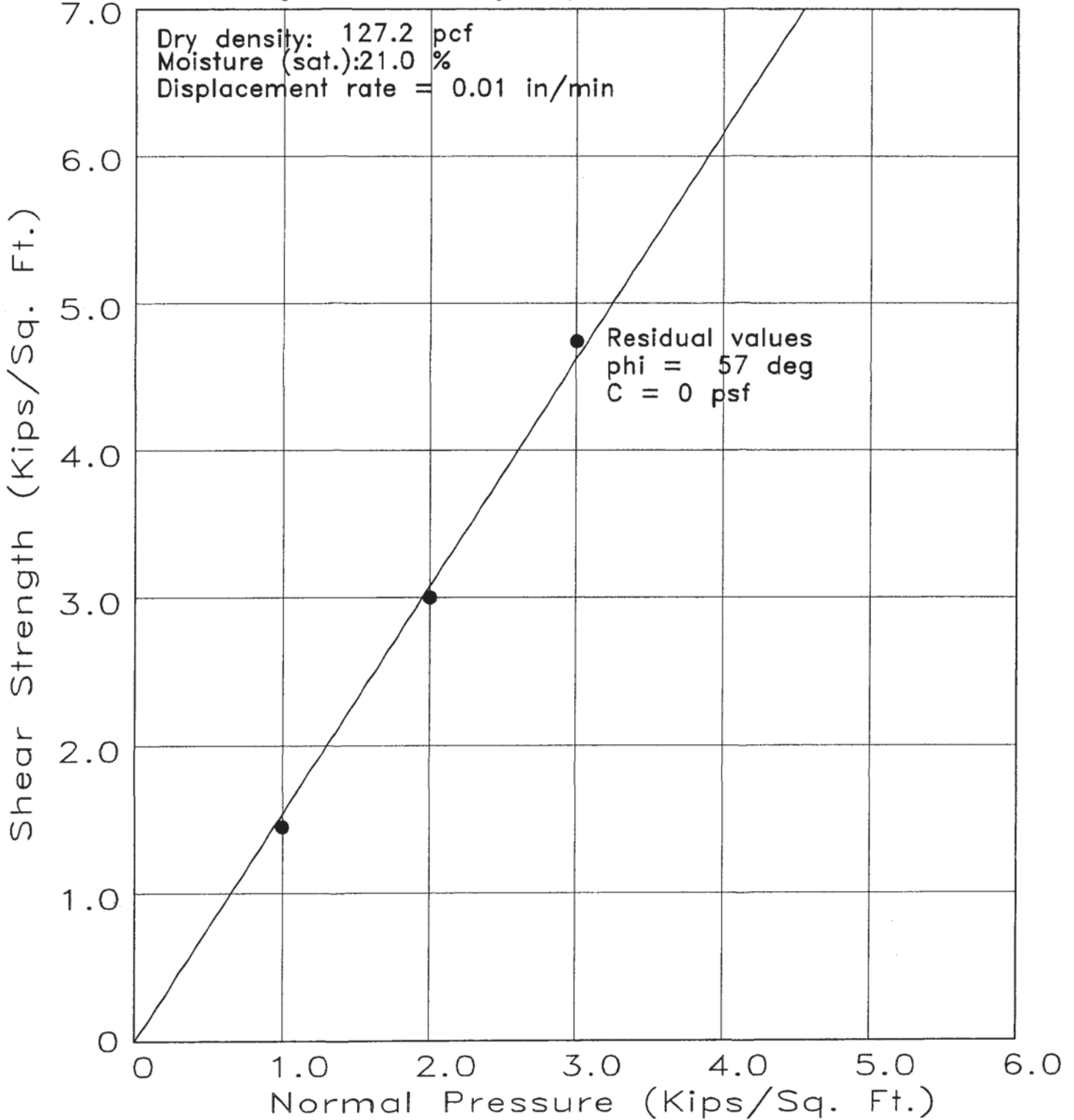

Project Skyline Ranch
 Excavation B6
 Depth 20'

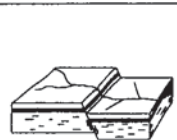

Geolabs - Westlake Village
 GEOLOGY AND SOIL ENGINEERING

DATE 8/27/02 BY SD
 W.O. 8838

Excavation: B6 at 20 ft

W.O.: 8838

Displacement Rate: 0.01 in/min

SHEARS 1K, 2K, & 3K NORMAL LOADS Undisturbed, sat at 21%

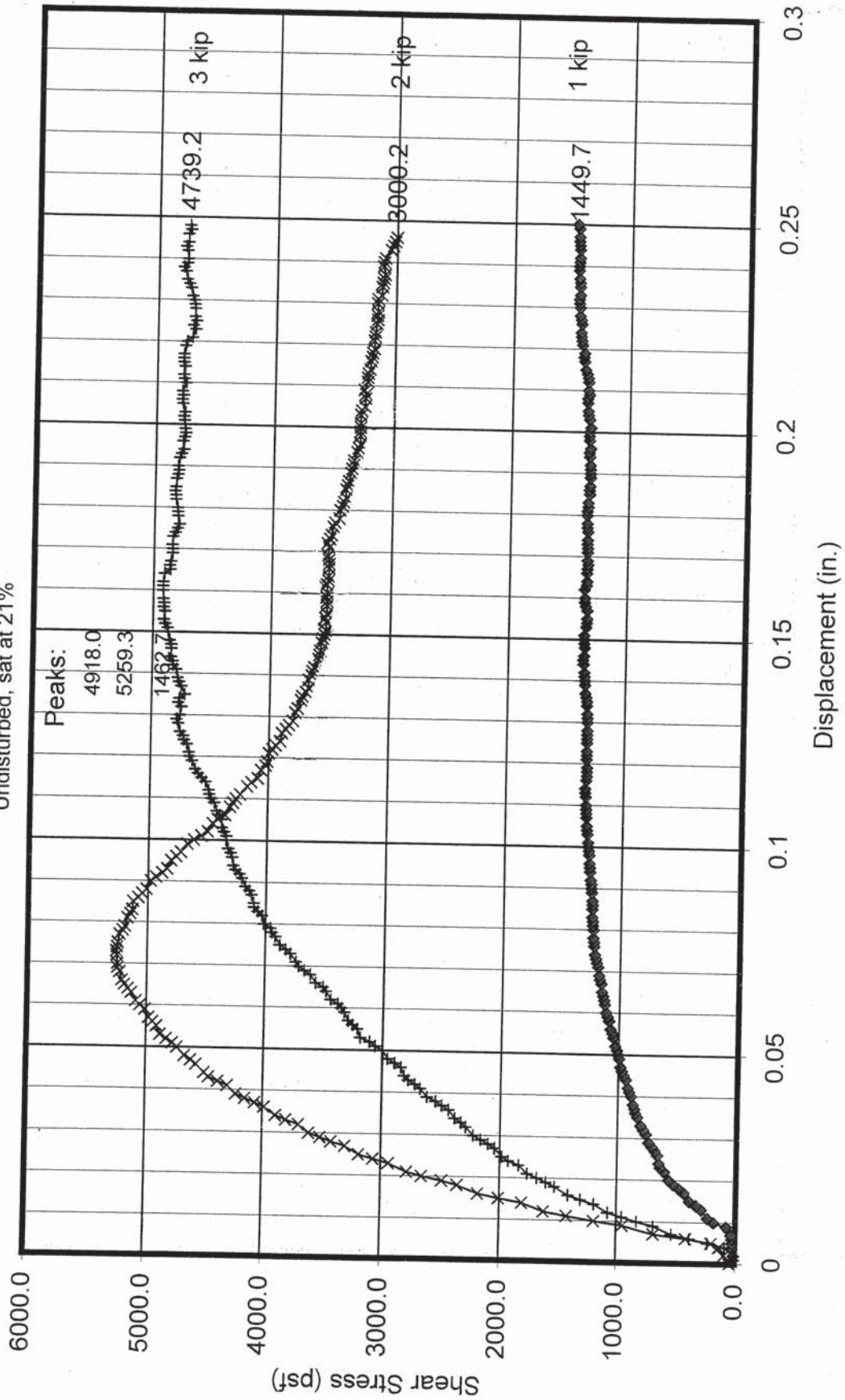

SHEAR TEST DIAGRAM

Material: Saugus Formation - CONGLOMERATE

Presoaked, Undisturbed

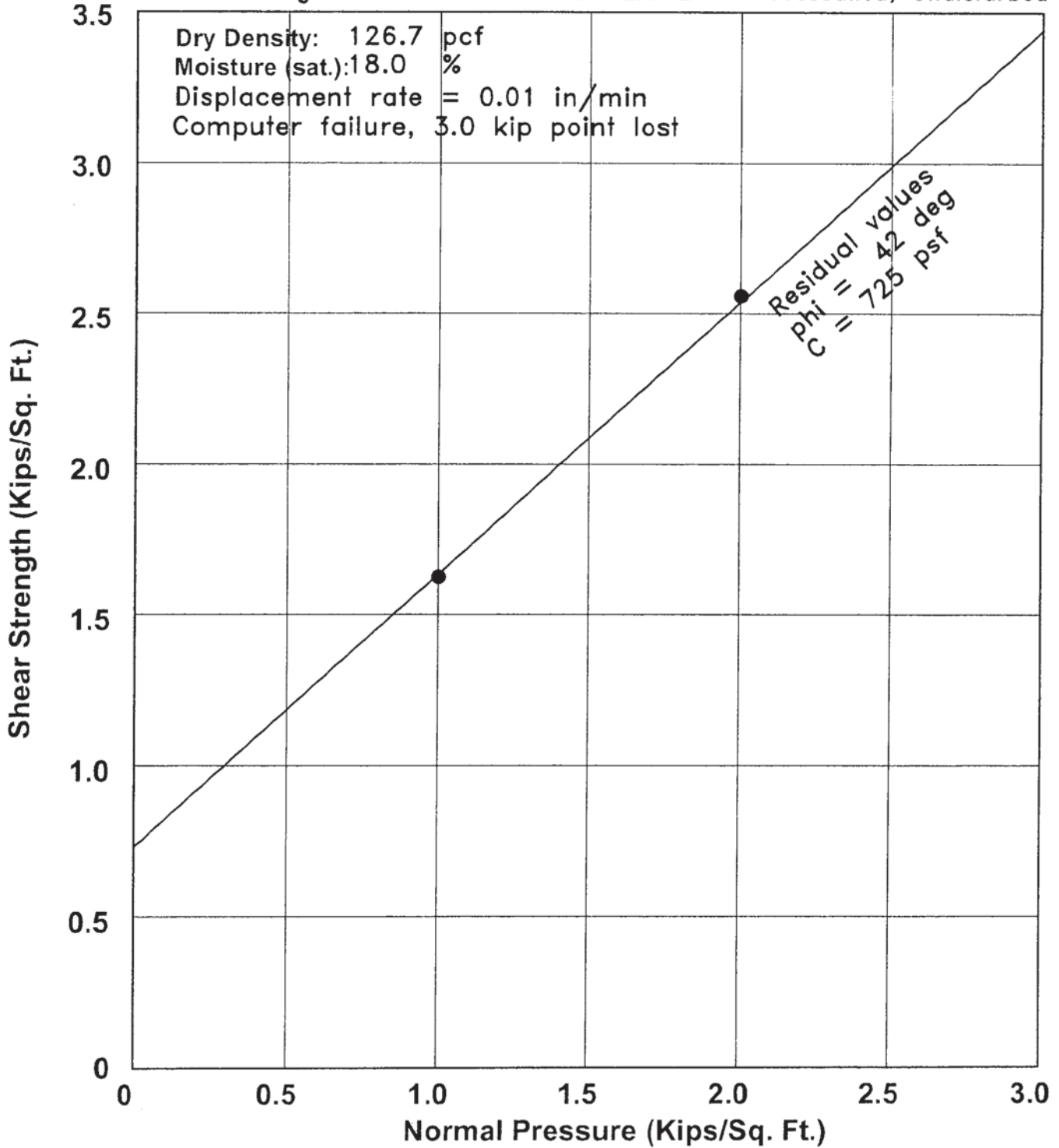

Project Skyline Ranch
 Excavation B6
 Depth 34'



Geolabs - Westlake Village
 GEOLOGY AND SOIL ENGINEERING

DATE 9/3/02 BY SD
 W.O. 8838

Excavation: B6 at 34 ft

W.O.: 8838

SHEARS 1K, 2K, & 3K NORMAL LOADS

Displacement Rate: 0.01 in/min

Undisturbed, sat at 18%

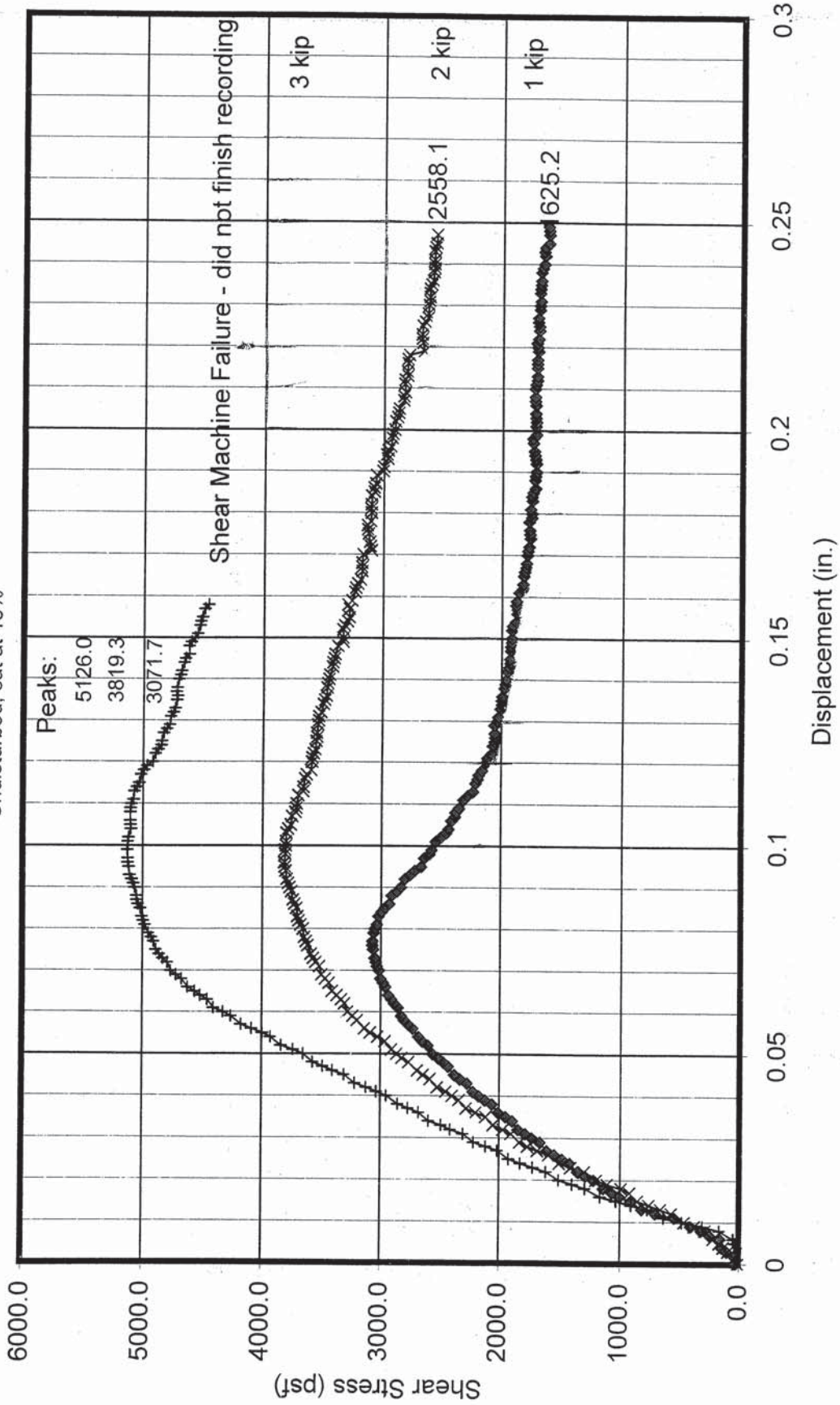

SHEAR TEST DIAGRAM

Material: Saugus Fm. - Conglomerate Undisturbed

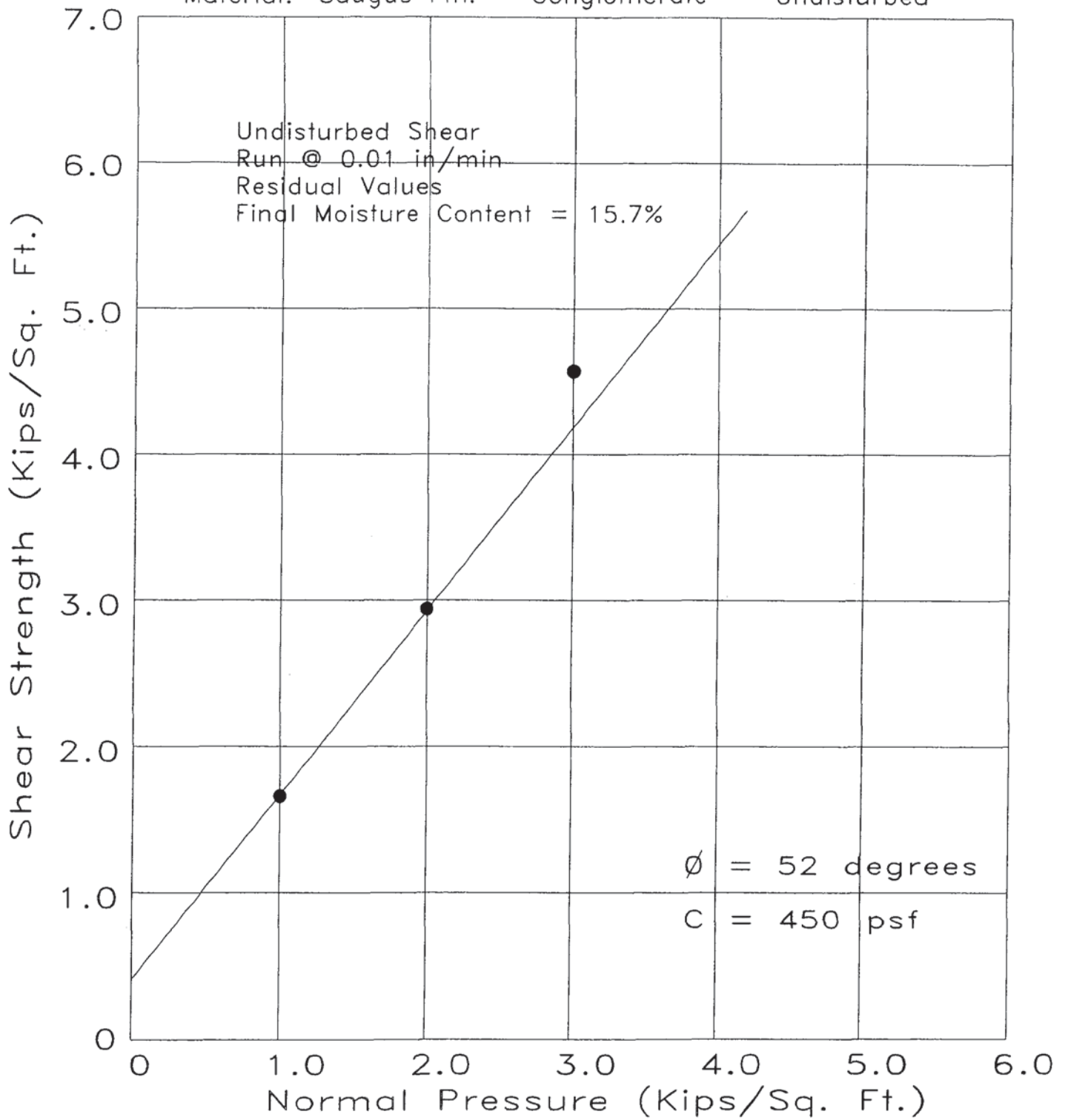

Project Skyline Ranch
Excavation B10
Depth 30 Feet



Geolabs - Westlake Village
GEOLOGY AND SOIL ENGINEERING

DATE 1/04 BY DS
SCALE _____ W.O. 8838

Excavation: B10 at 30 ft

W.O.: 8838

SHEARS 1K, 2K, & 3K NORMAL LOADS

Displacement Rate: 0.01 in/min

Undisturbed, sat. at 15.7%

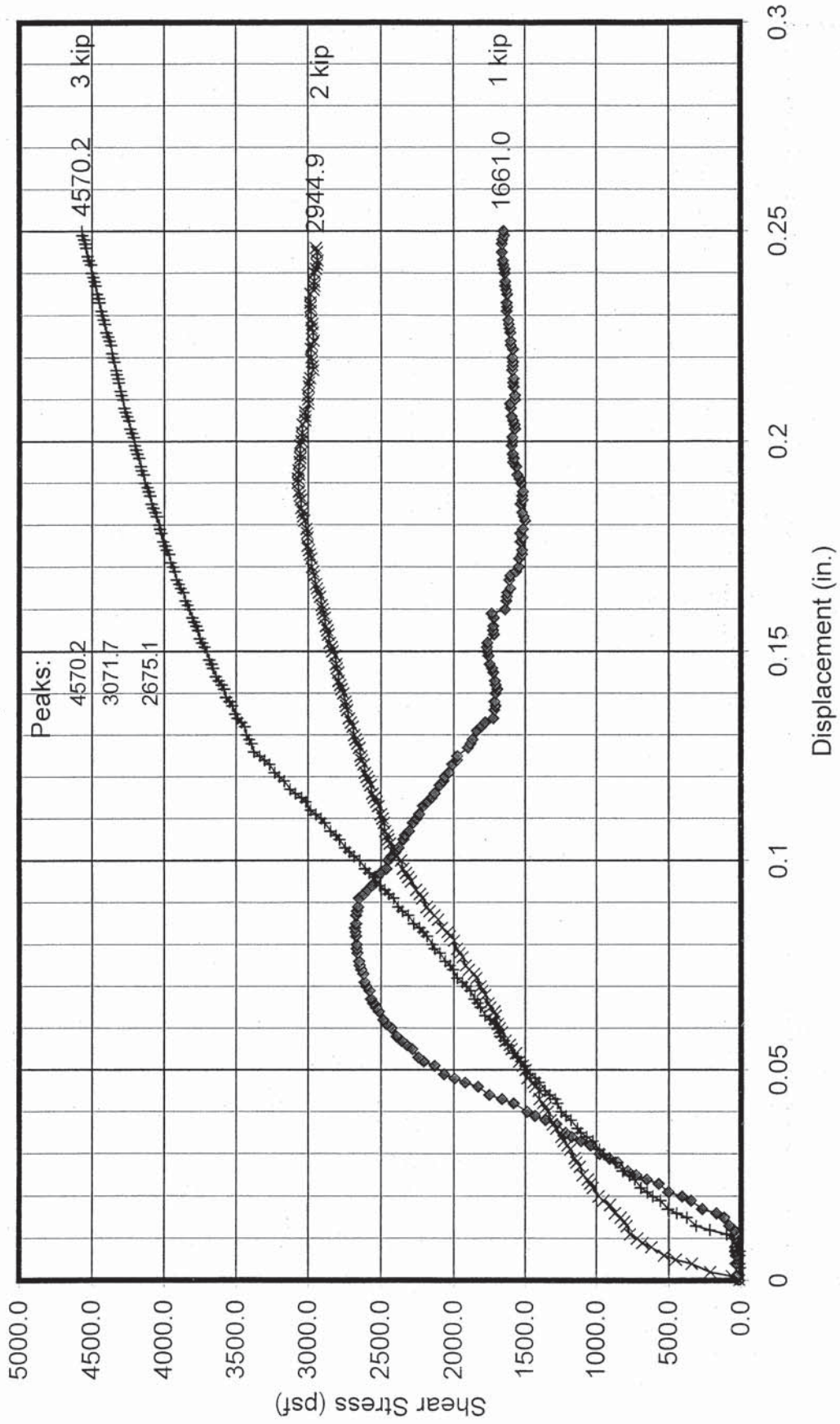

SHEAR TEST DIAGRAM

Material: Mint Canyon Formation – CONGLOMERATE Undisturbed

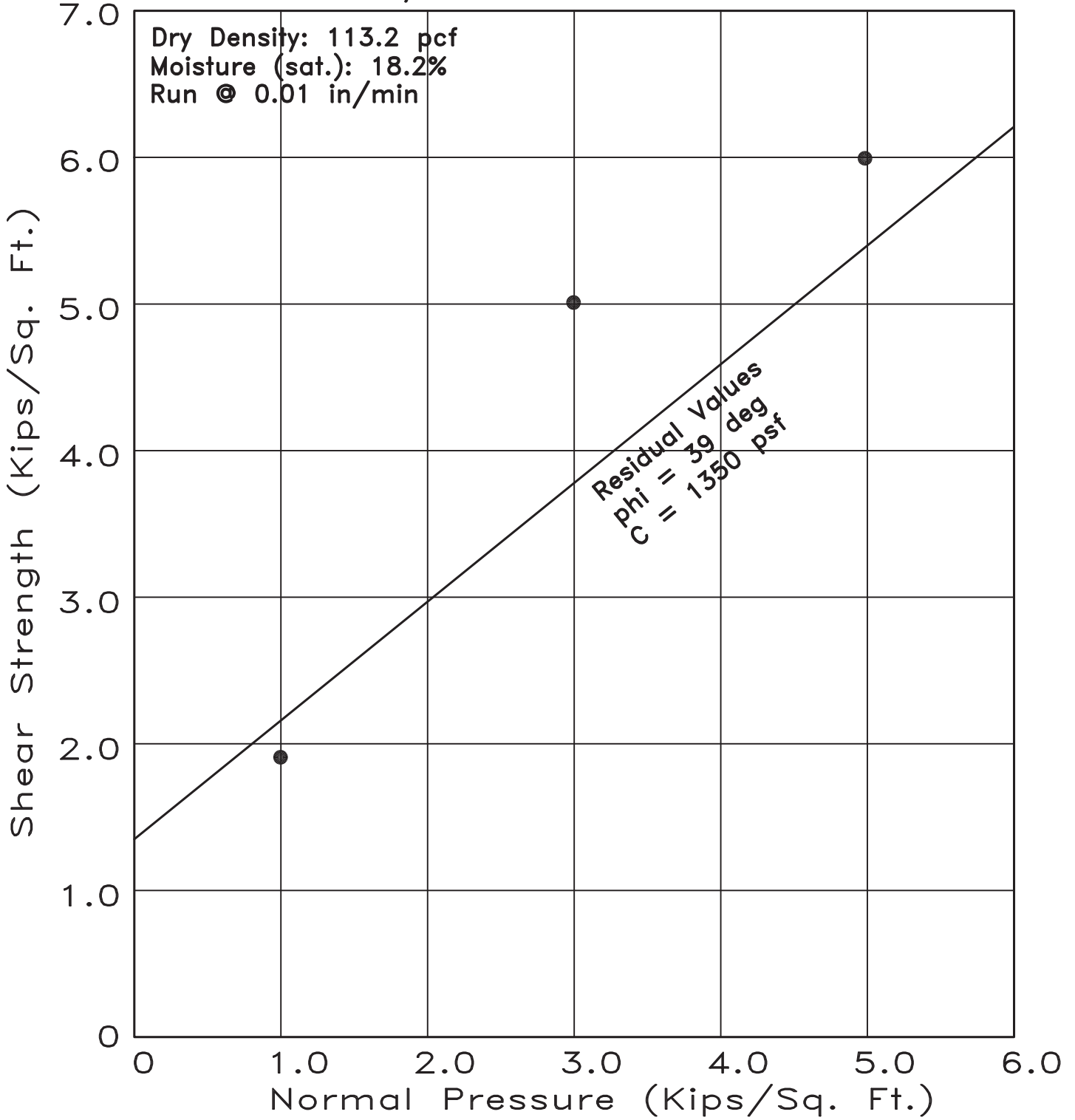

Project Skyline Ranch
 Excavation B11
 Depth 60 Feet



Geolabs – Westlake Village
 GEOLOGY AND SOIL ENGINEERING

BY SD
 DATE 1/12/04 W.O. 8838

Excavation: B11 at 60 ft

W.O.: 8838

SHEARS 1K, 2K, & 3K NORMAL LOADS Undisturbed, Sat at 18.2%

Displacement Rate: 0.01 in/min

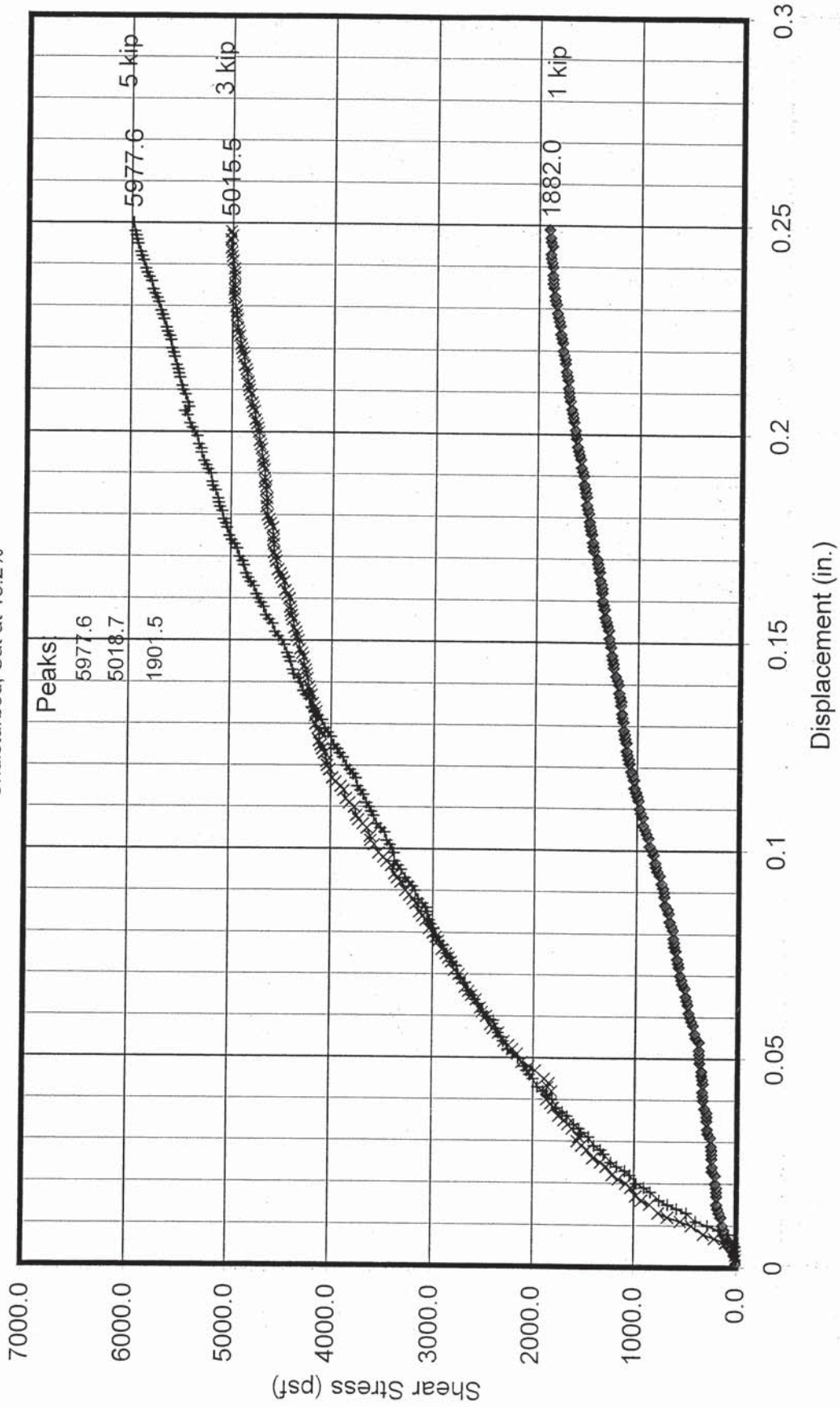

SHEAR TEST DIAGRAM

Material: Saugus Fm. - Silty SANDSTONE

Undisturbed

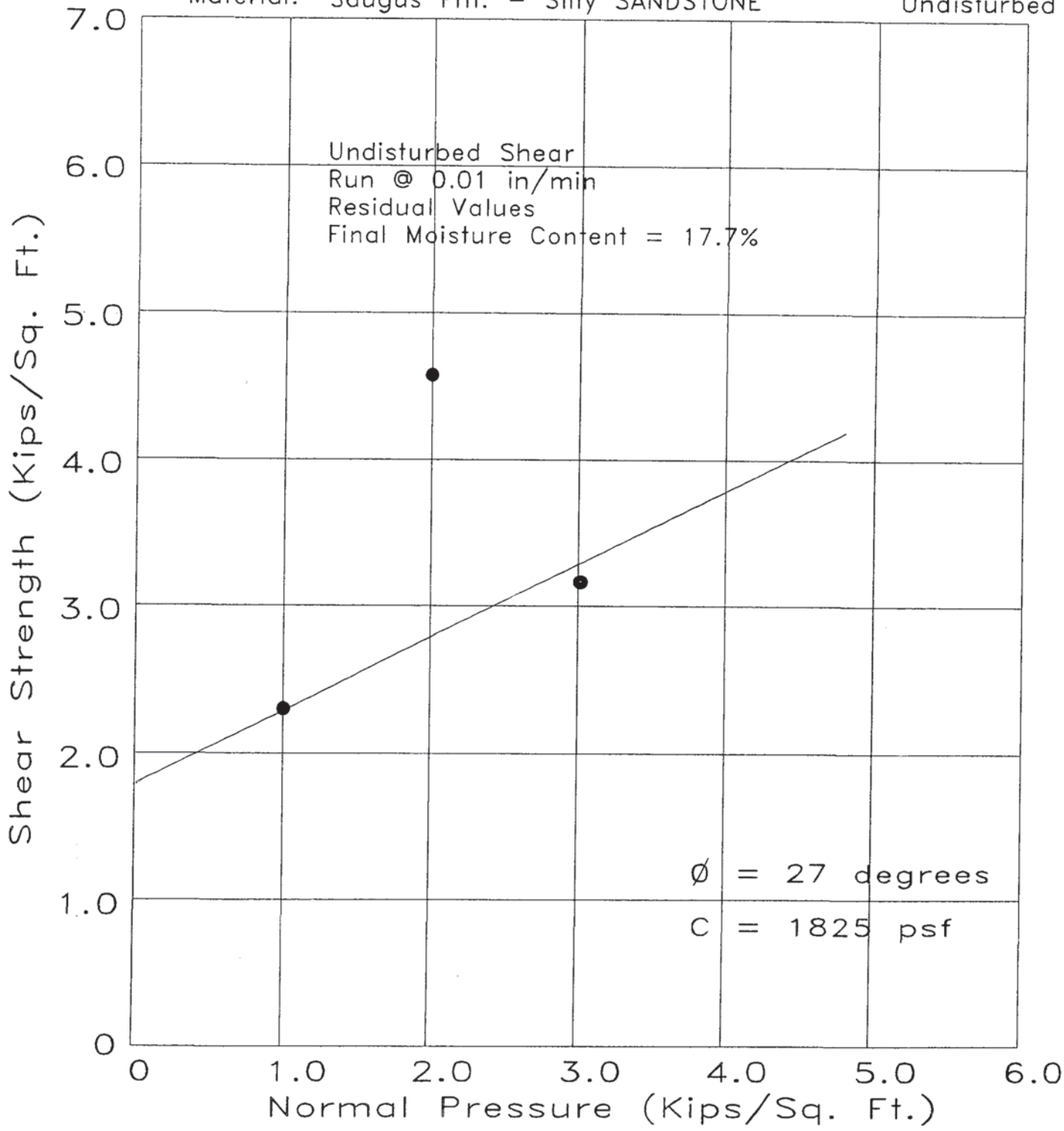

Project Skyline Ranch
 Excavation Boring 14
 Depth 15 Feet



Geolabs - Westlake Village
 GEOLOGY AND SOIL ENGINEERING

DATE _____ BY DS
 SCALE _____ W.O. 8838

Excavation: B14 at 15 ft

W.O.: 8838

Displacement Rate: 0.01 in/min

SHEARS 1K, 2K, & 3K NORMAL LOADS

Undisturbed, sat. at 17.7%

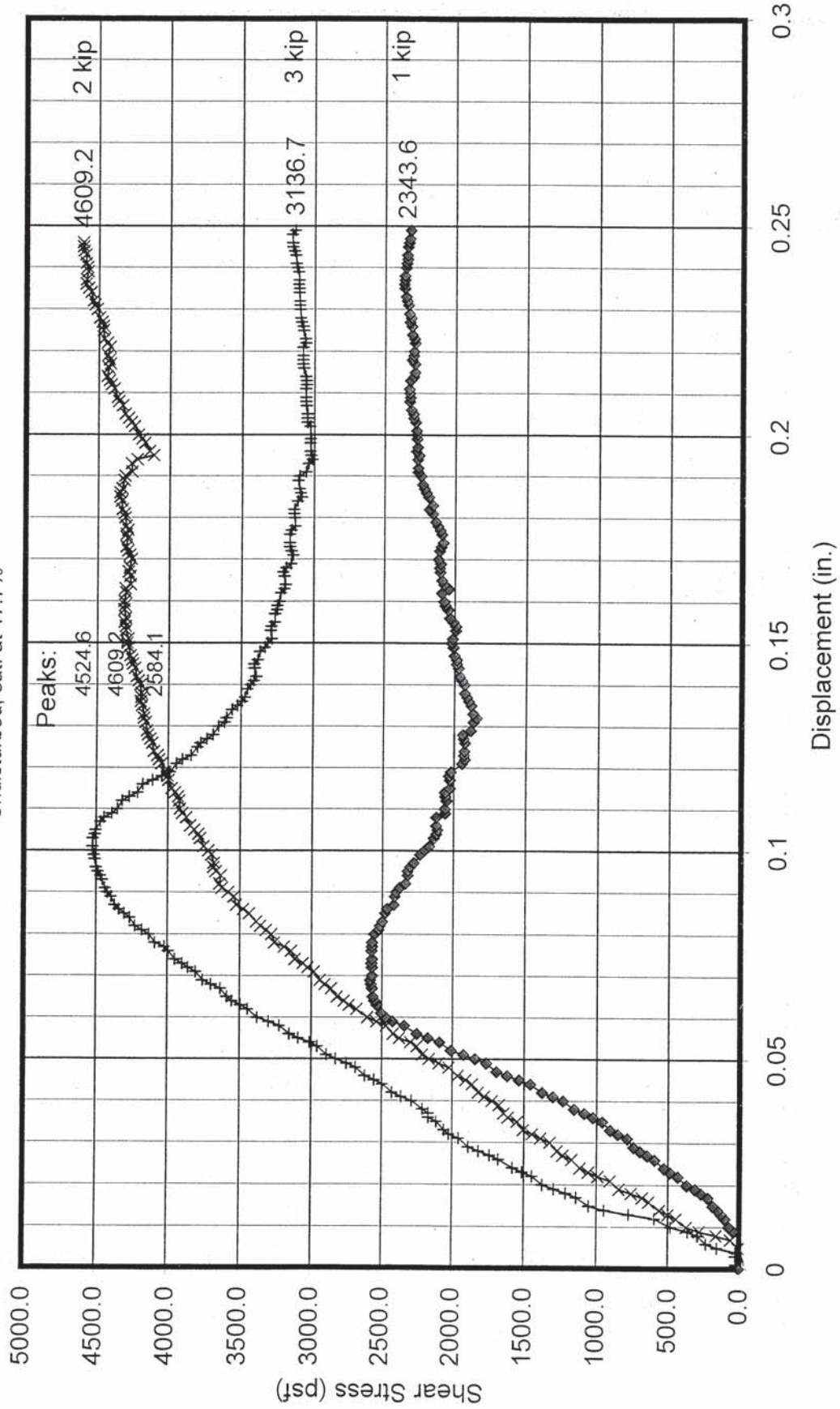

SHEAR TEST DIAGRAM

Material: Saugus Formation Presoaked, Undisturbed

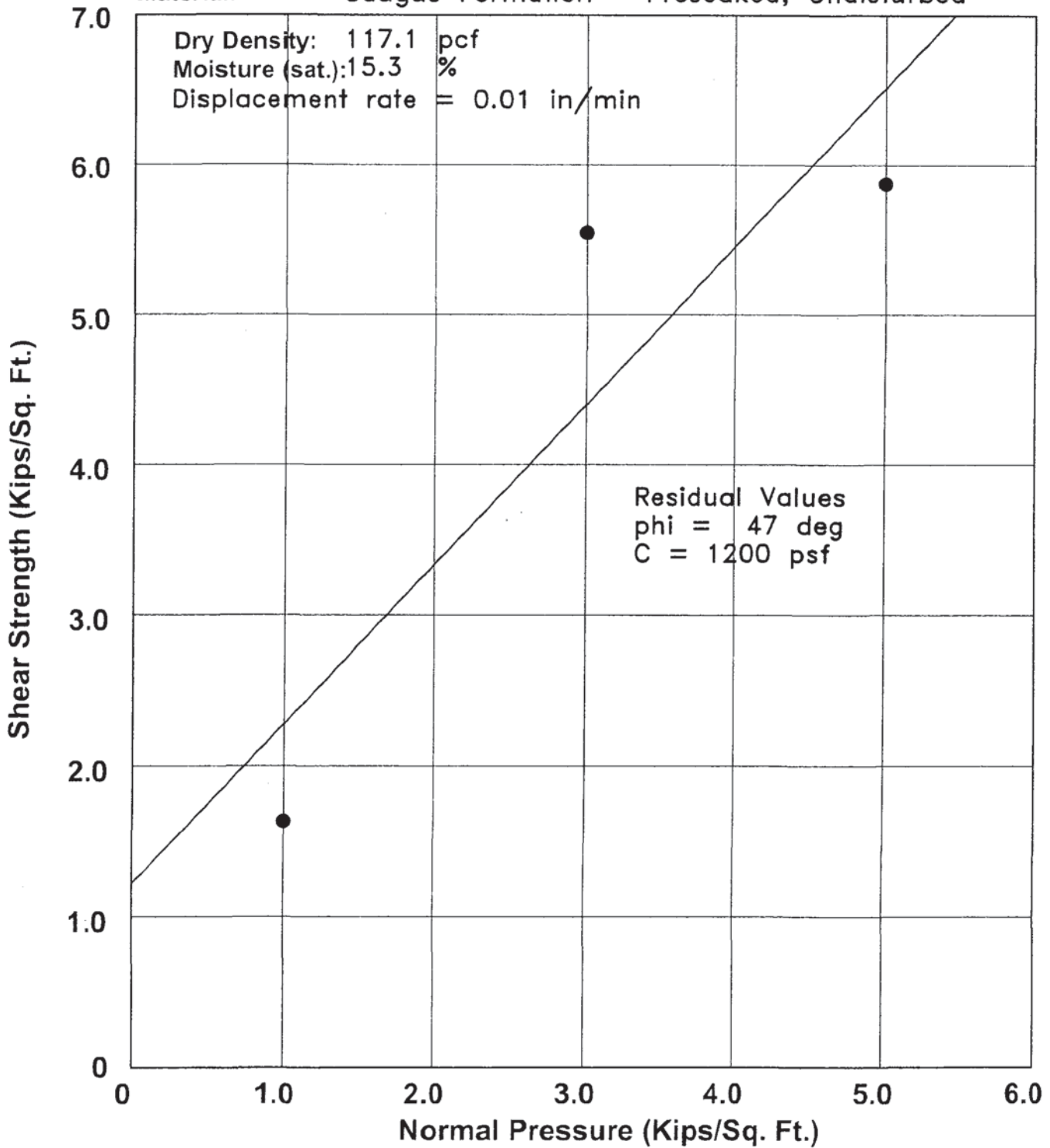

Project Skyline Ranch
 Excavation B21
 Depth 60'



Geolabs - Westlake Village
 GEOLOGY AND SOIL ENGINEERING

DATE 1/14/04 BY SD
 W.O. 8838

Excavation: B21 at 60 ft

W.O.: 8838

Displacement Rate: 0.01 in/min

SHEARS 1K, 2K, & 3K NORMAL LOADS

Undisturbed, sat at 15.3%

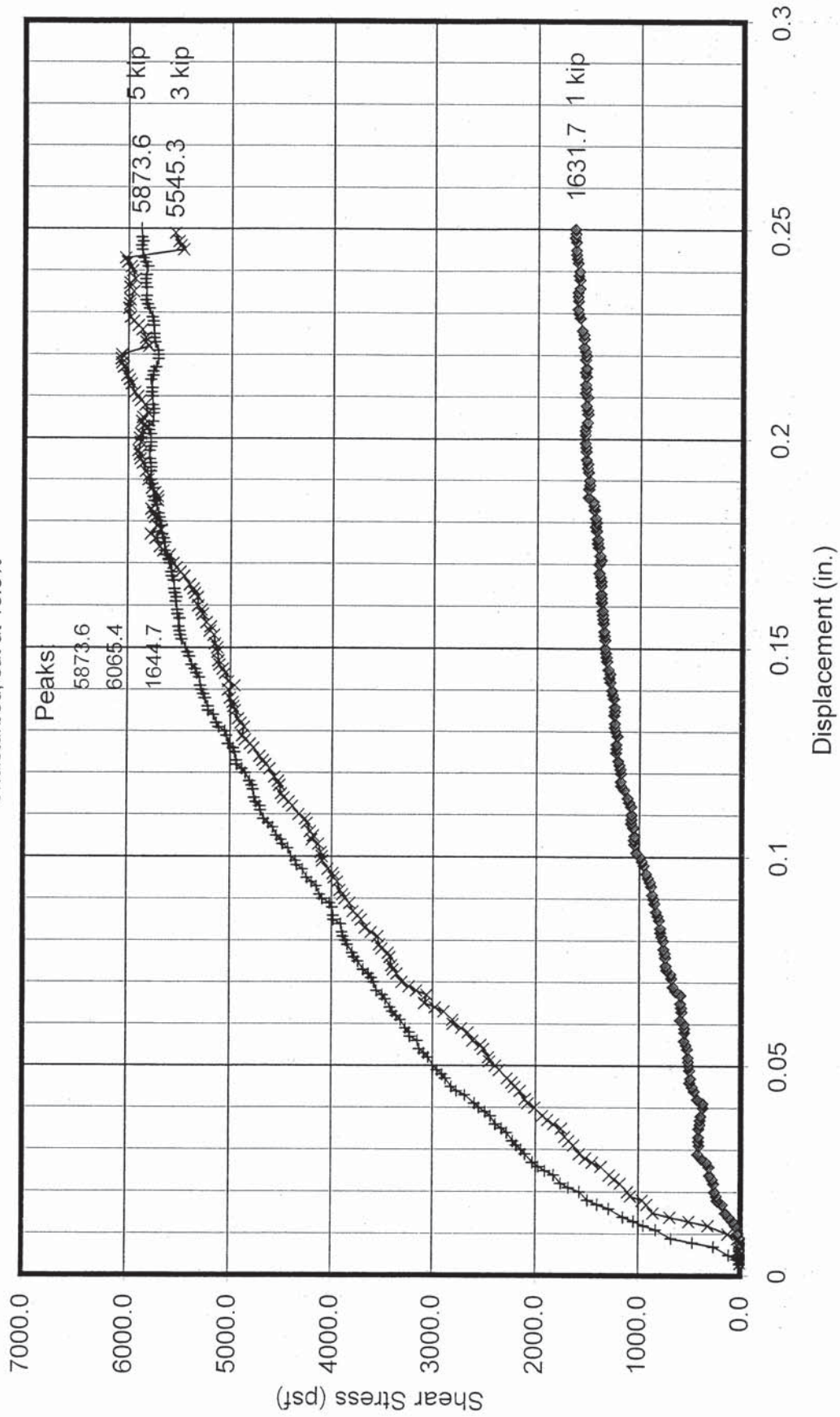

SHEAR TEST DIAGRAM

Material: Saugus Formation Presoaked, Undisturbed

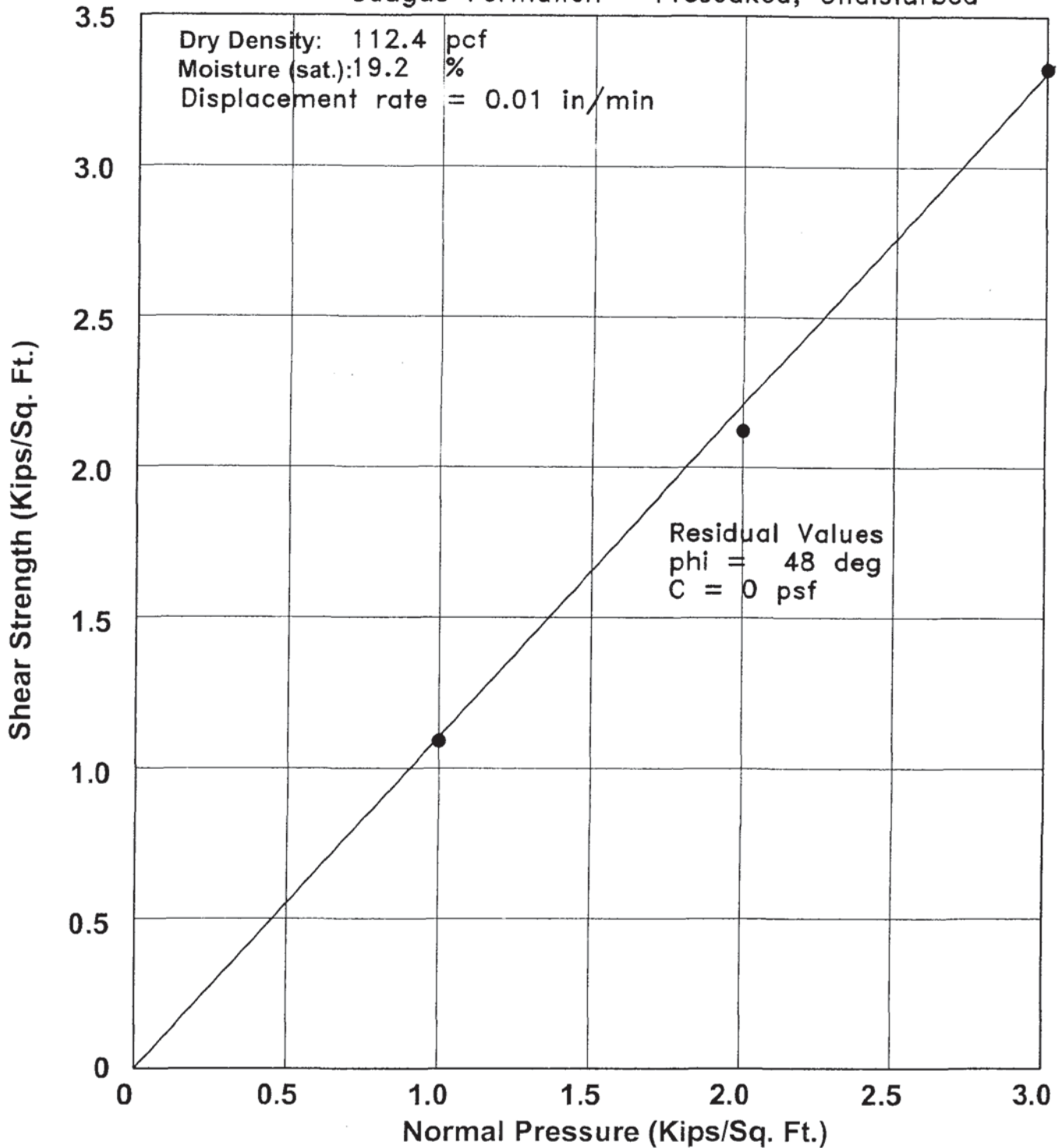

Project Skyline Ranch
 Excavation B23
 Depth 45'



Geolabs - Westlake Village
GEOLOGY AND SOIL ENGINEERING

BY SD
 DATE 1/12/04 W.O. 8838

Excavation: B23 at 45 ft

W.O.: 8838

Displacement Rate: 0.01 in/min

SHEARS 1K, 2K, & 3K NORMAL LOADS

Undisturbed, Sat at 19.2%

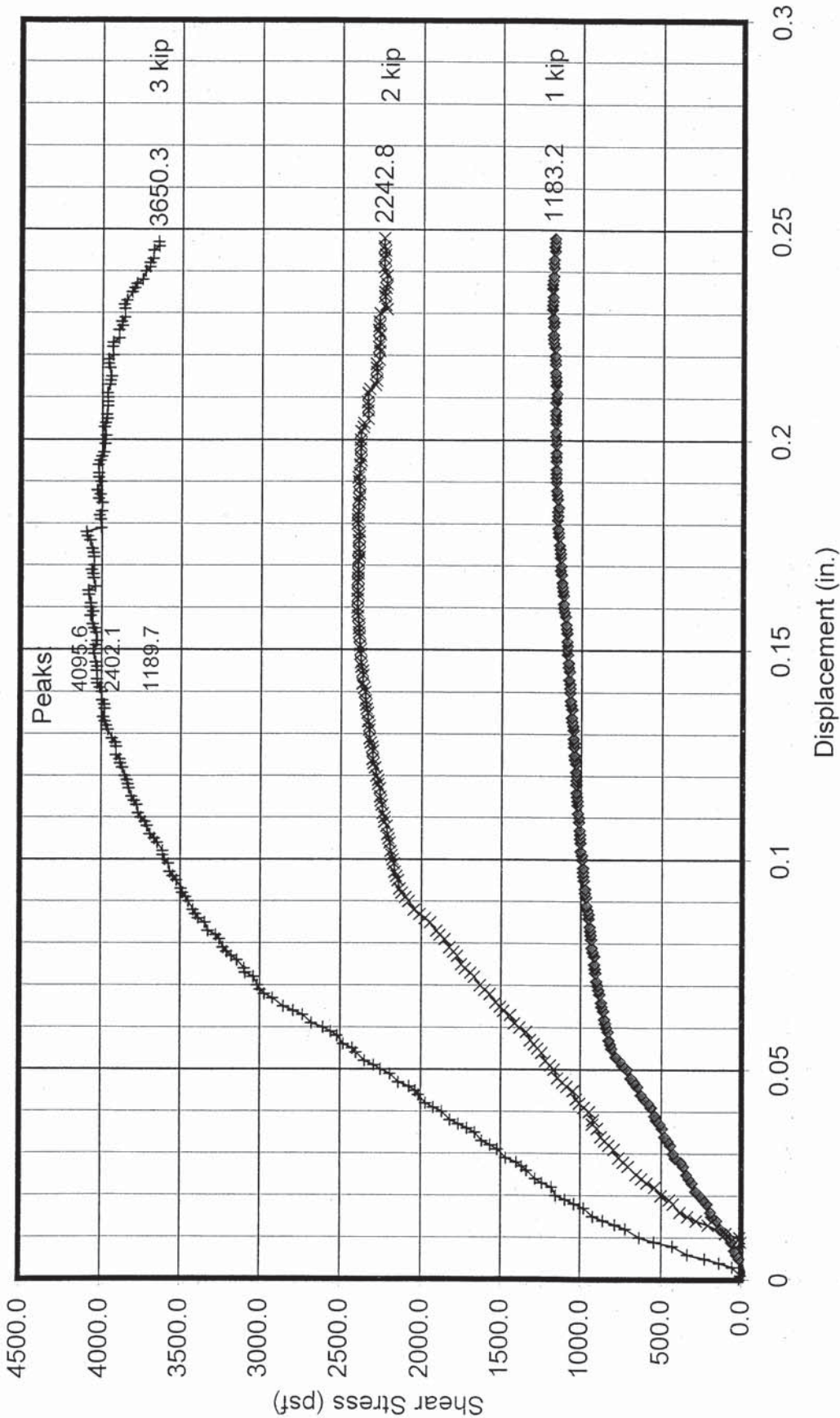

SHEAR TEST DIAGRAM

Material: Saugus Fm. - Clayey gravelly SANDSTONE

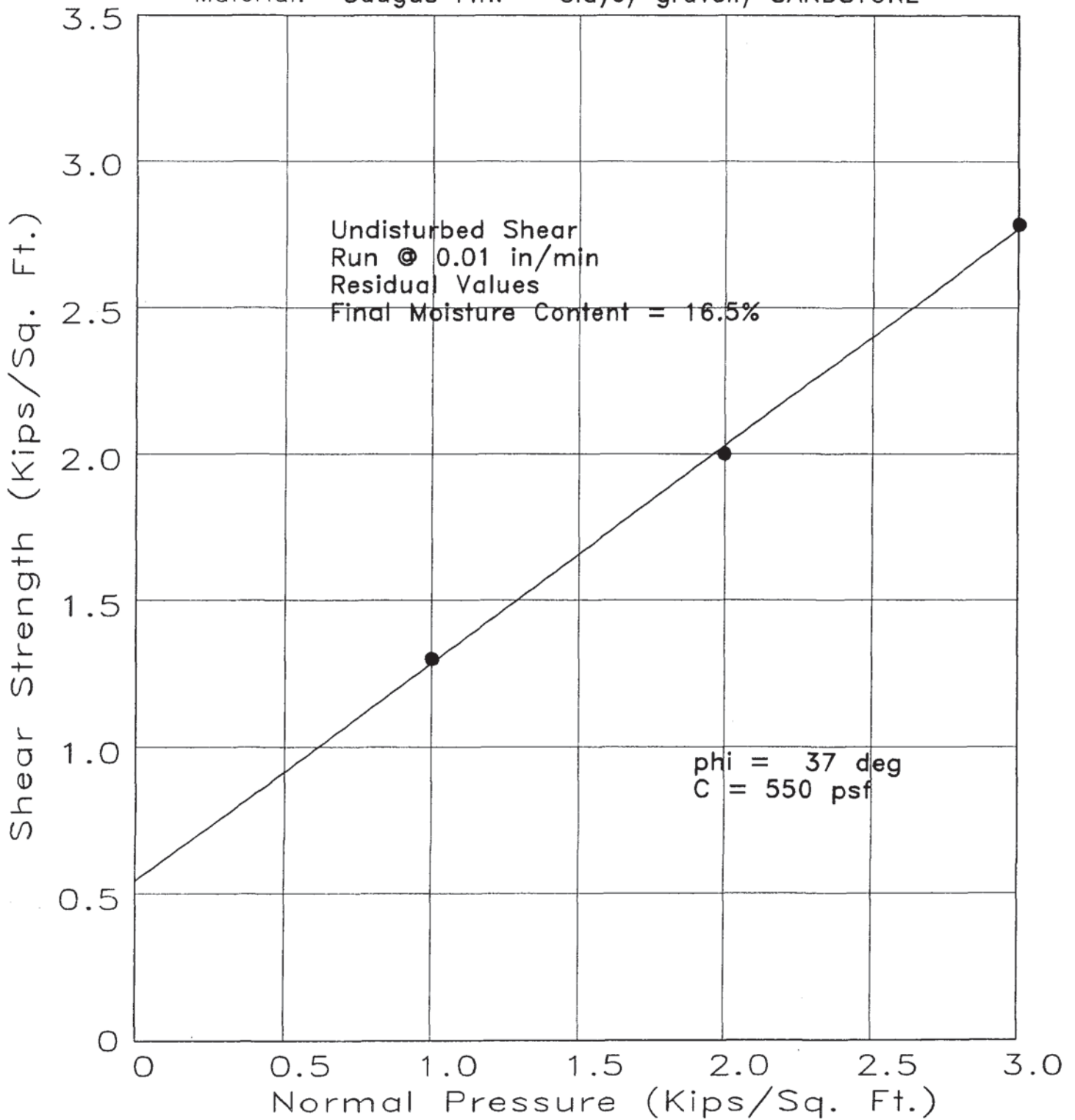

Project Skyline Ranch
Excavation Boring 25
Depth 30 Feet



Geolabs - Westlake Village
GEOLOGY AND SOIL ENGINEERING

BY DS
DATE _____ W.O. 8838

Excavation: B25 at 30 ft

W.O.: 8838

Displacement Rate: 0.01 in/min

SHEARS 1K, 2K, & 3K NORMAL LOADS

Undisturbed, sat at 16.5%

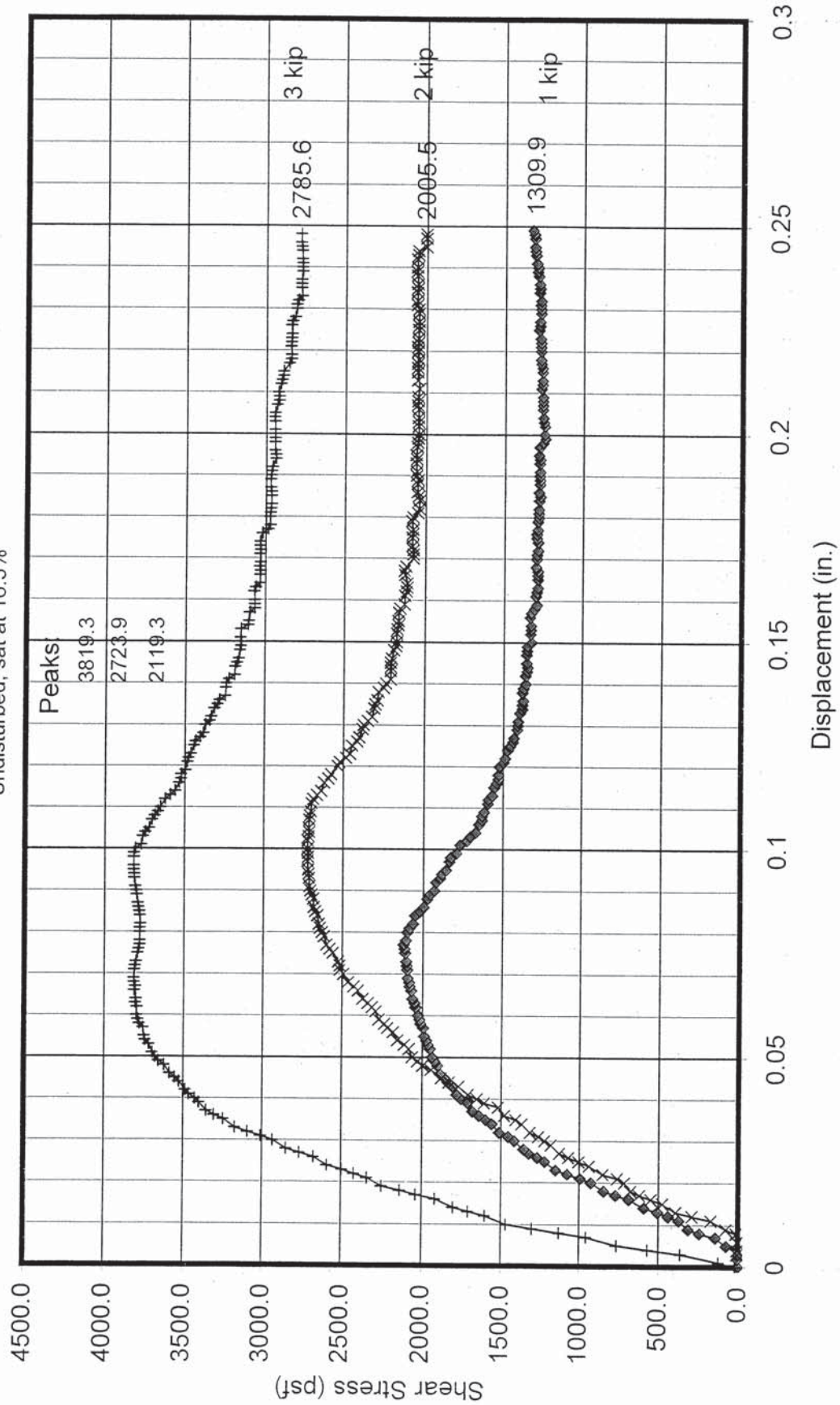

SHEAR TEST DIAGRAM

Material: Landslide Debris - Clayey fine-med. SANDSTONE

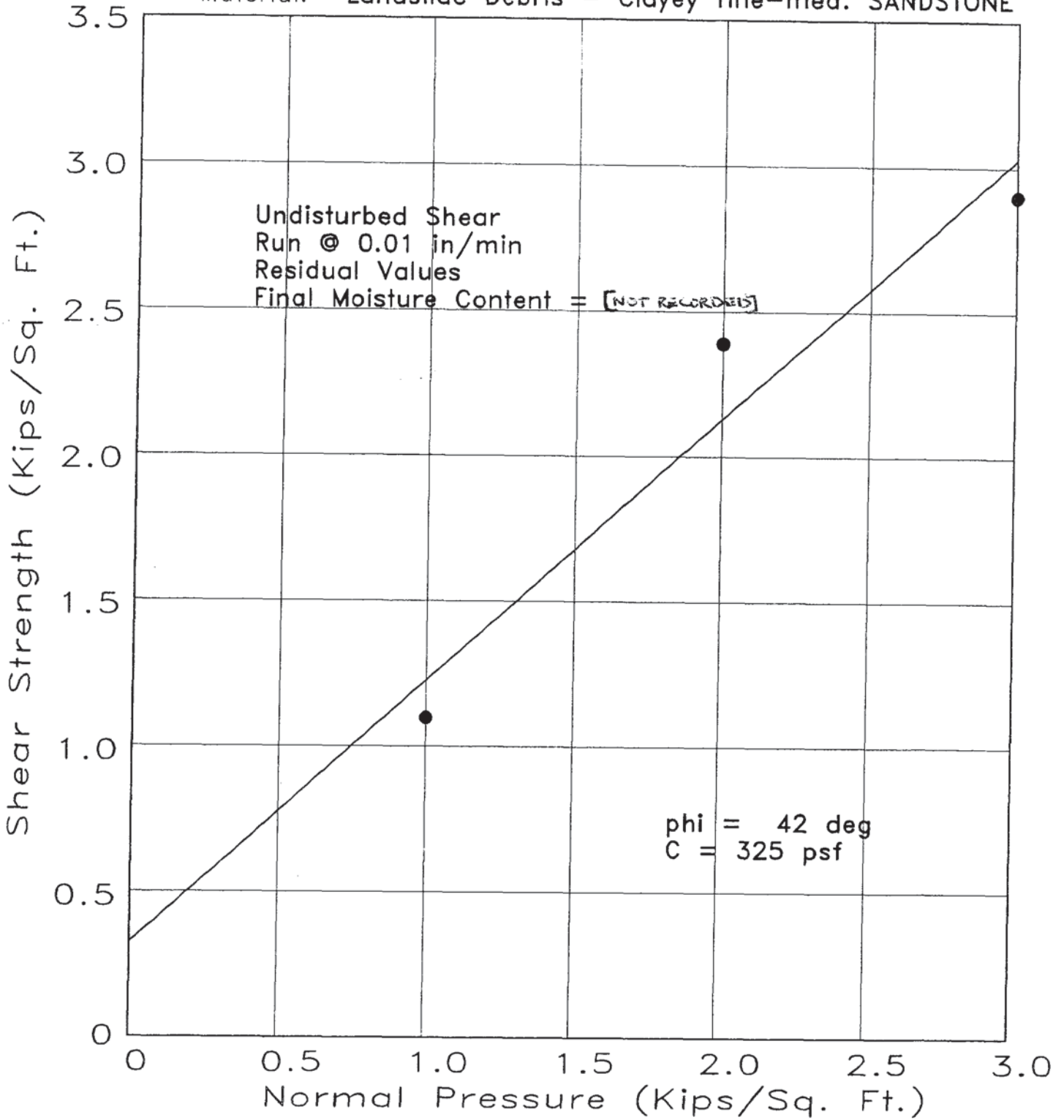

Project Skyline Ranch
Excavation Boring 27
Depth 15 Feet



Geolabs - Westlake Village
GEOLOGY AND SOIL ENGINEERING

BY DS
DATE _____ W.O. 8838

Excavation: B27 at 15 ft

W.O.: 8838

Displacement Rate: 0.01 in/min

SHEARS 1K, 2K, & 3K NORMAL LOADS

Undisturbed, sat at ???

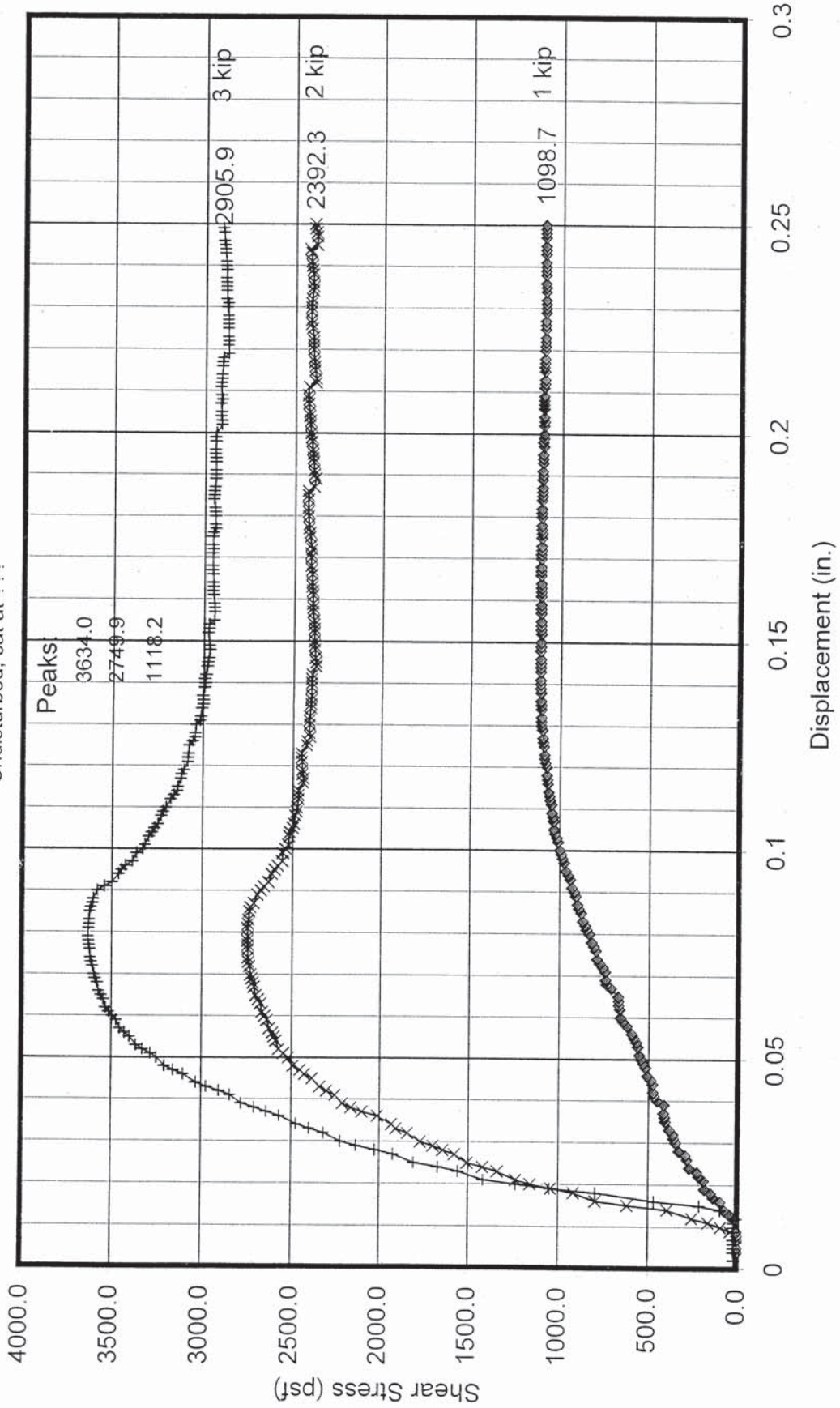

SHEAR TEST DIAGRAM

Material: Saugus Fm.— Sandstone Undisturbed

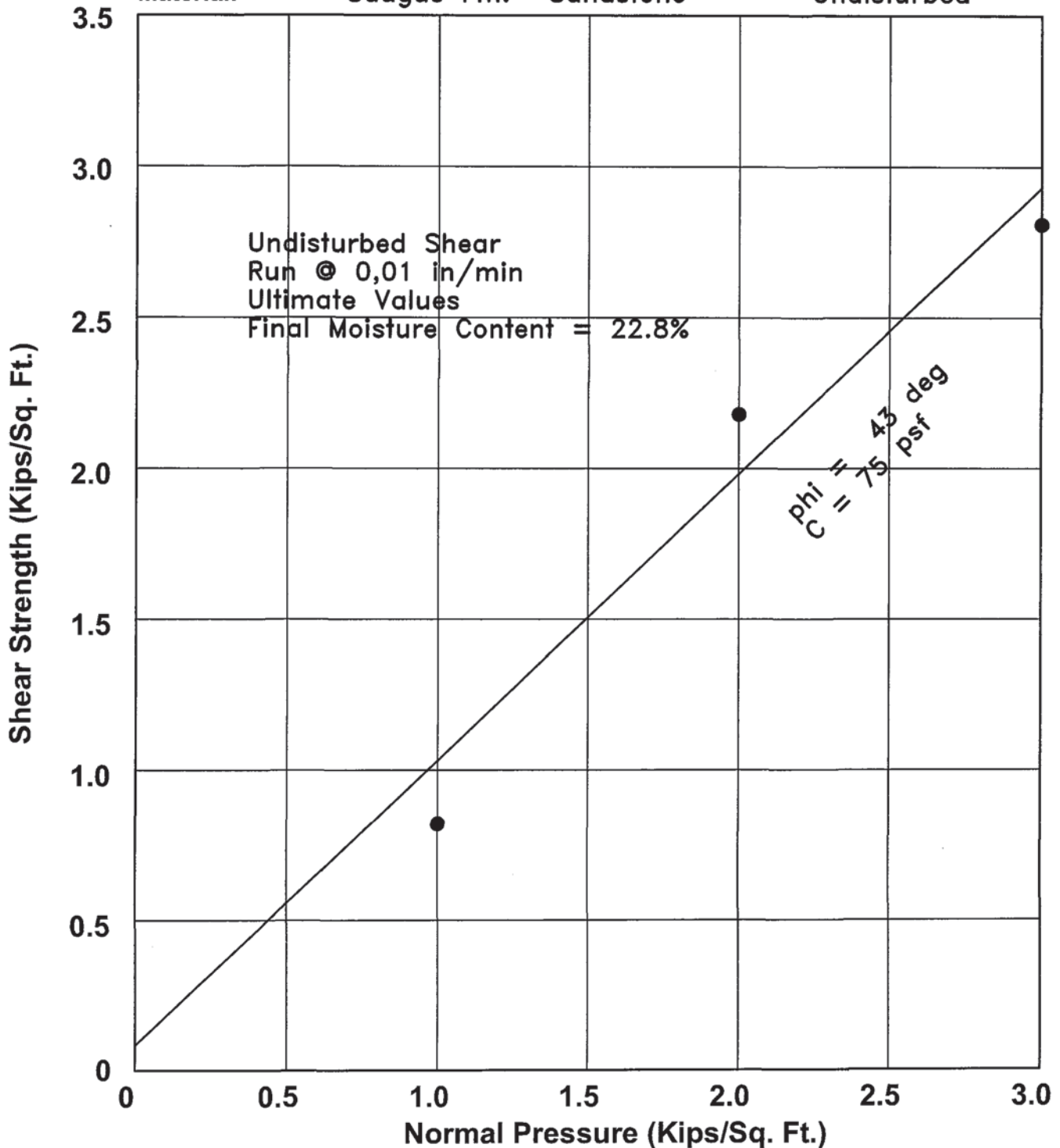

Project Skyline Ranch, TTM 060922
 Excavation Boring 29
 Depth 30 Feet



Geolabs - Westlake Village
 GEOLOGY AND SOIL ENGINEERING

BY DS
 DATE _____ W.O. 8838

PLATE S29.30

Excavation: B29 at 30 ft

W.O.: 8838

Displacement Rate: 0.01 in/min

SHEARS 1K, 2K, & 3K NORMAL LOADS

Undisturbed, Sat at 22.8 %

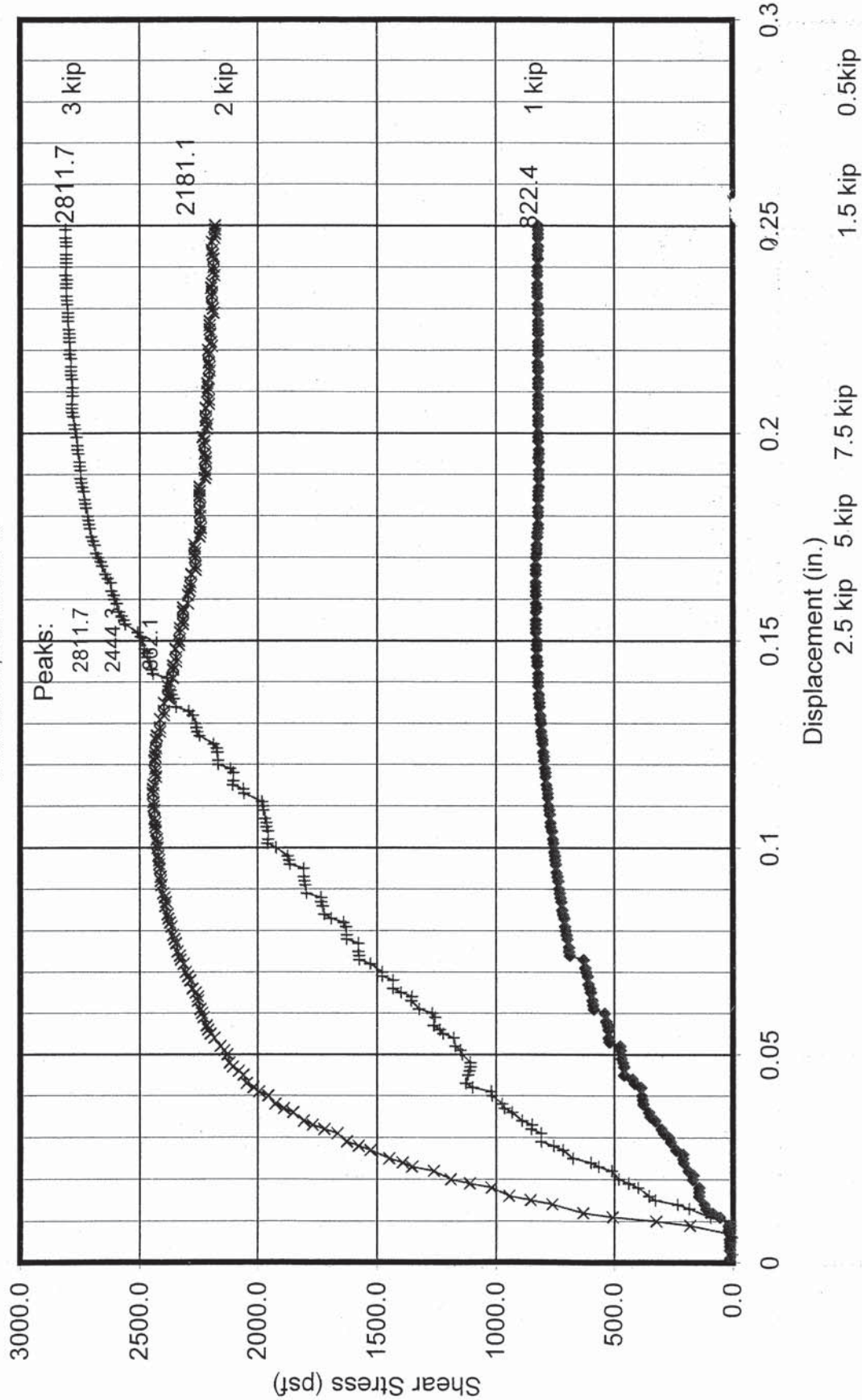

SHEAR TEST DIAGRAM

Material: Saugus Fm.. - Conglomerate

Undisturbed

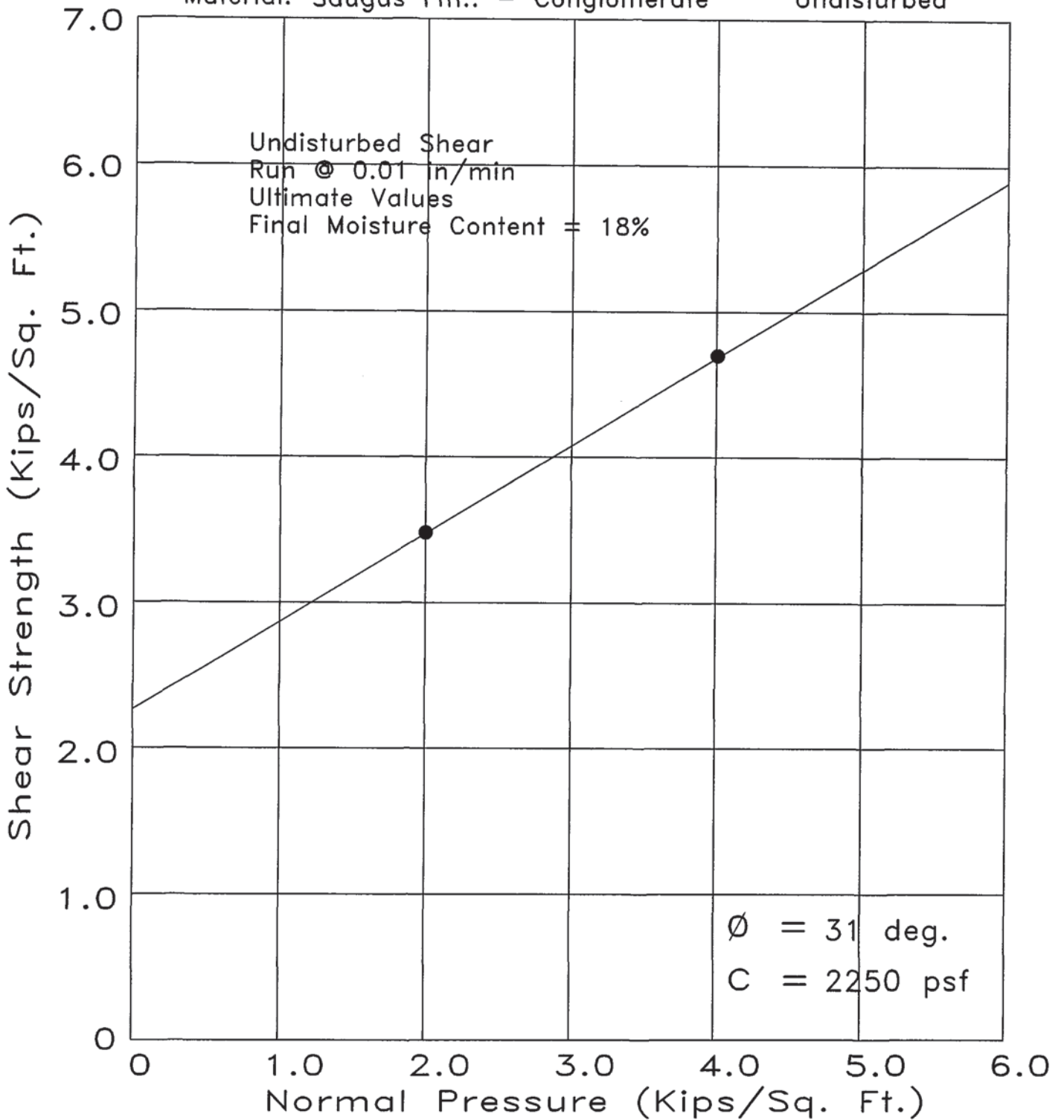

Project Skyline Ranch, TTM 060922
 Excavation Boring 29
 Depth 90 Feet



Geolabs - Westlake Village
 GEOLOGY AND SOIL ENGINEERING

DATE 8/04 BY DS
 SCALE _____ W.O. 8838

Excavation: B29 at 90 ft

W.O.: 8838

Displacement Rate: 0.01 in/min

SHEARS 1K, 2K, & 3K NORMAL LOADS

Undisturbed, sat at 18%

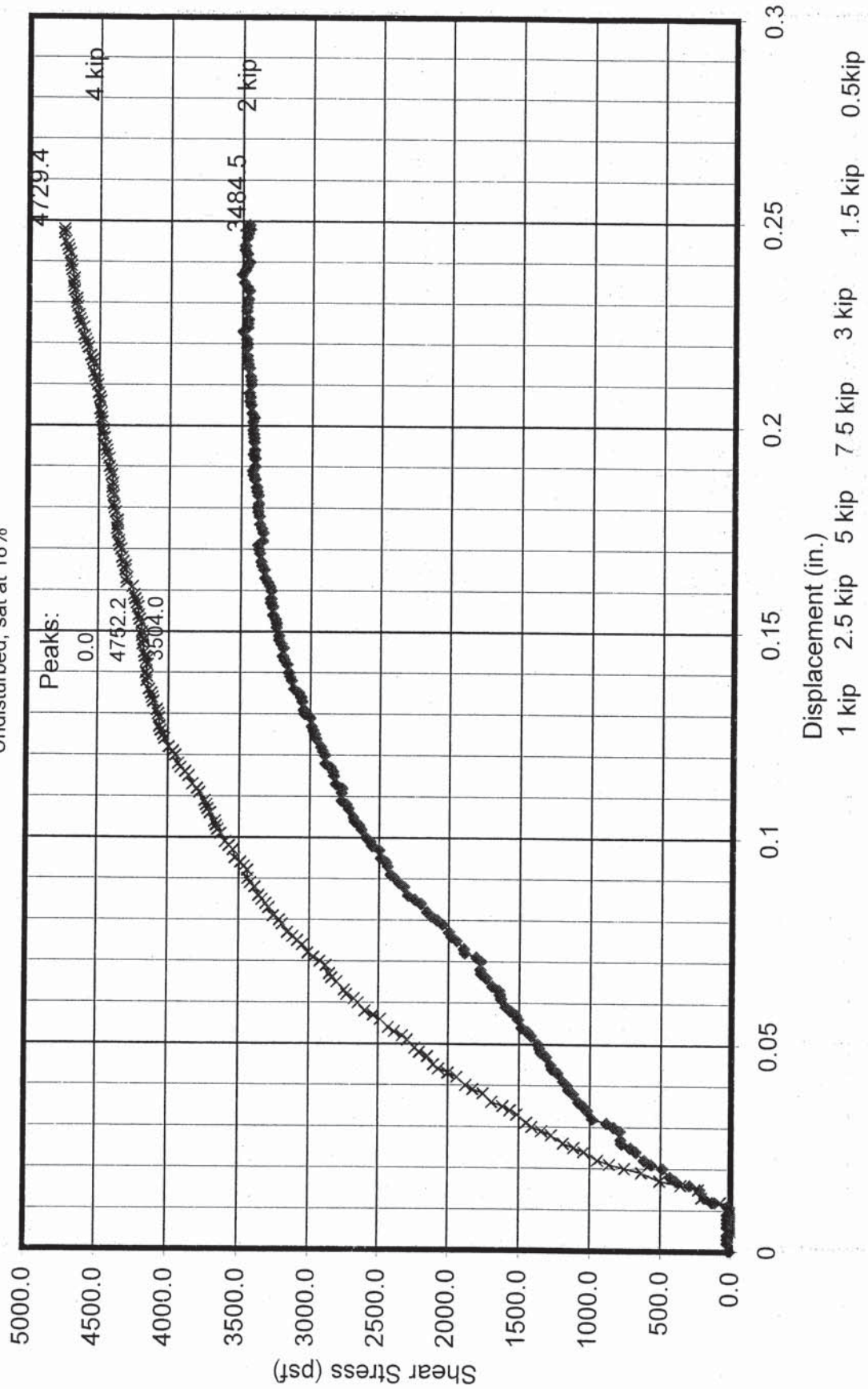

SHEAR TEST DIAGRAM

Material: Saugus Formation - CONGLOMERATE Undisturbed

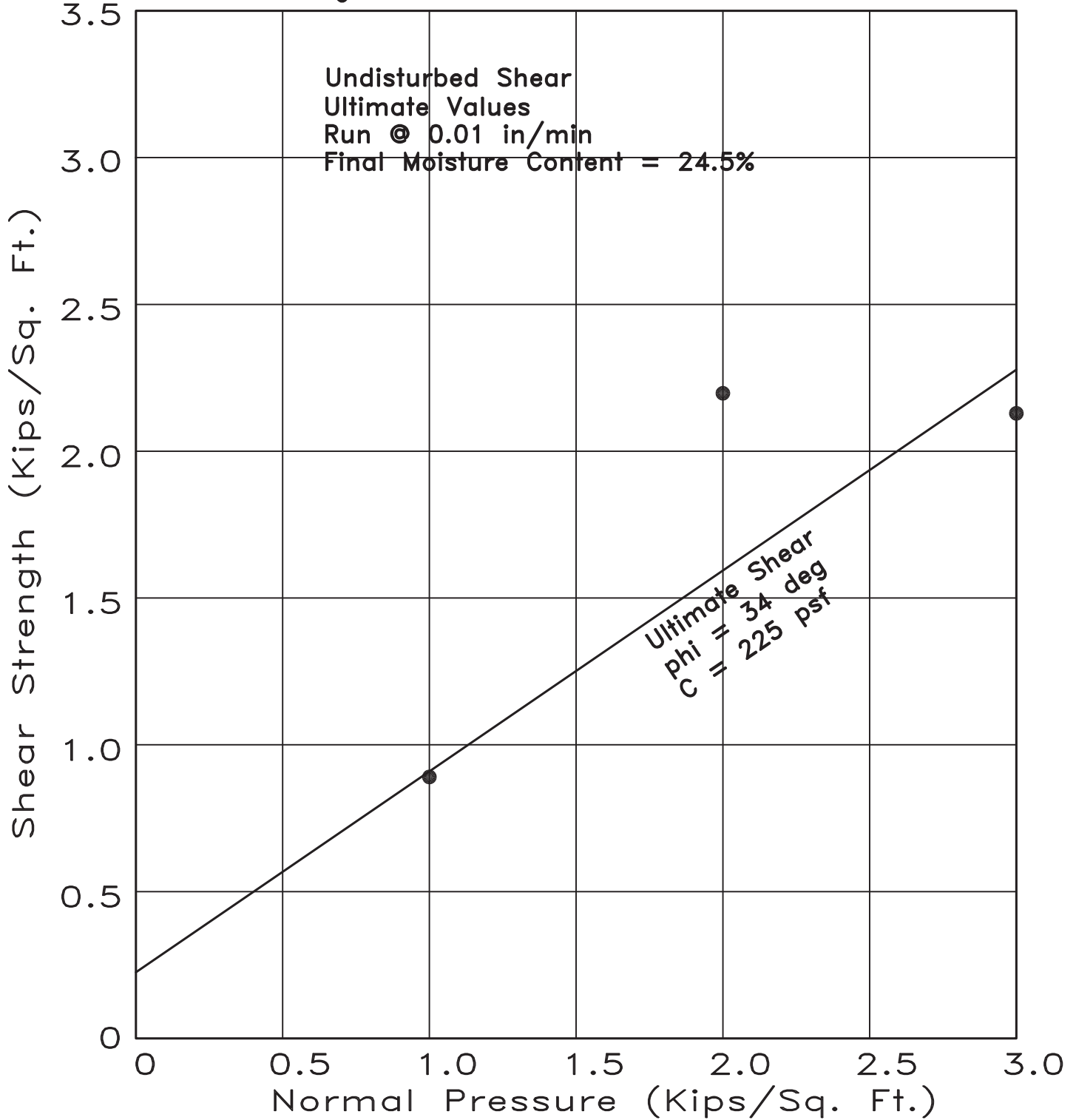

Project Tr. 060922 Skyline Ranch
 Excavation B38
 Depth 40 Feet



Geolabs - Westlake Village
GEOLOGY AND SOIL ENGINEERING

BY DS
 DATE _____ W.O. 8838

Excavation: B38 Depth: 40 ft Displacement Rate: 0.0100 in/min

SHEARS 1K, 2K, & 3K NORMAL LOADS Undisturbed, Sat at 24.5 %

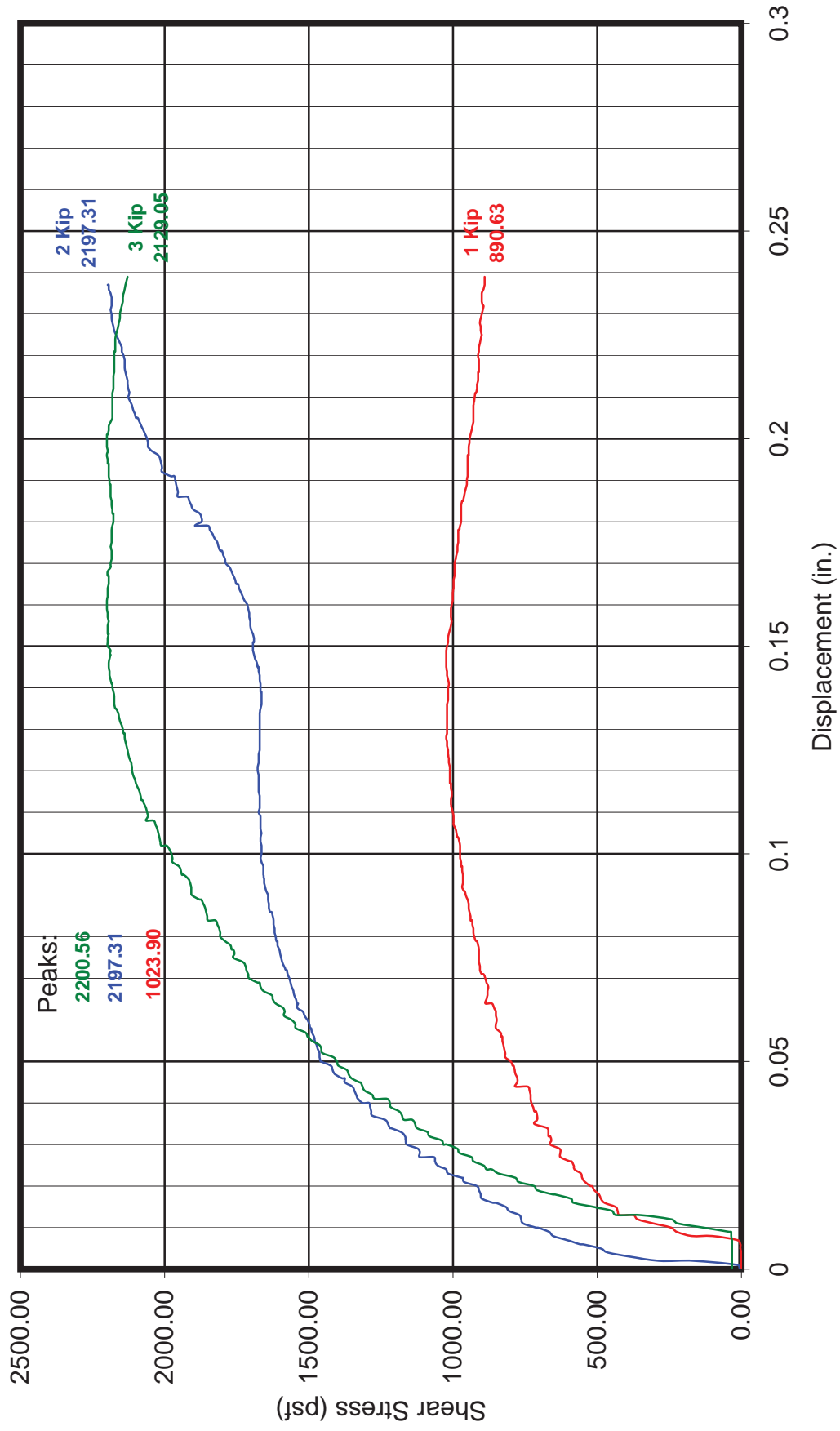

Excavation: B38 Depth: 40 ft

Client Name: Skyline Ranch Work Order #: 8838

B38 @ 40.xis

SHEAR TEST DIAGRAM

Material: Saugus Formation - CONGLOMERATE Undisturbed

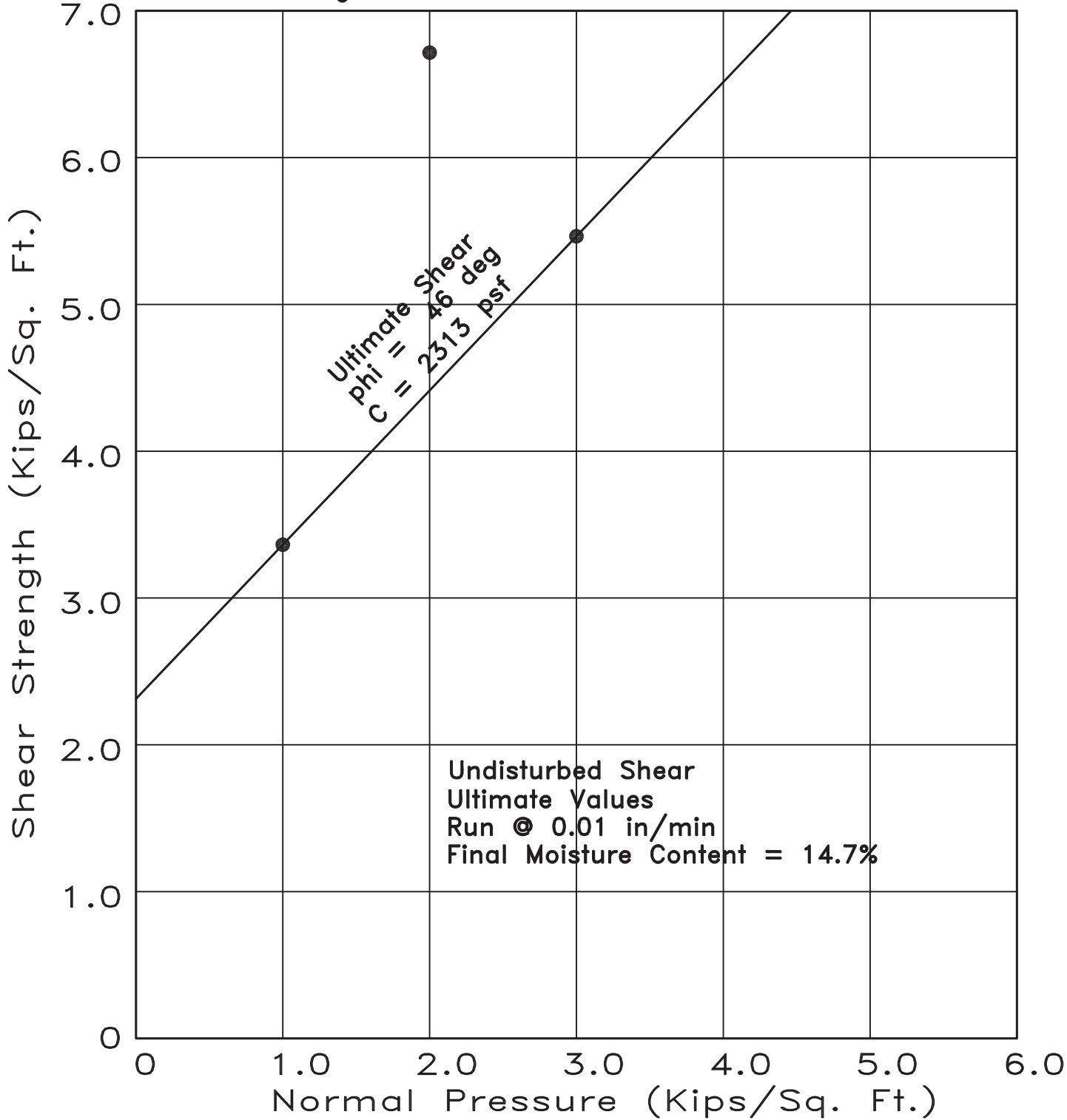

Project Tr. 060922 Skyline Ranch
 Excavation B39
 Depth 70 Feet



Geolabs - Westlake Village
 GEOLOGY AND SOIL ENGINEERING

BY DS
 DATE _____ W.O. 8838

Excavation: B39

Depth: 70 ft

Sample Description: Tan silty medium to coarse sand w/gravel

Displacement Rate: 0.0100 in/min

SHEARS 1K, 2K, & 3K NORMAL LOADS Undisturbed, Sat at 14.7 %

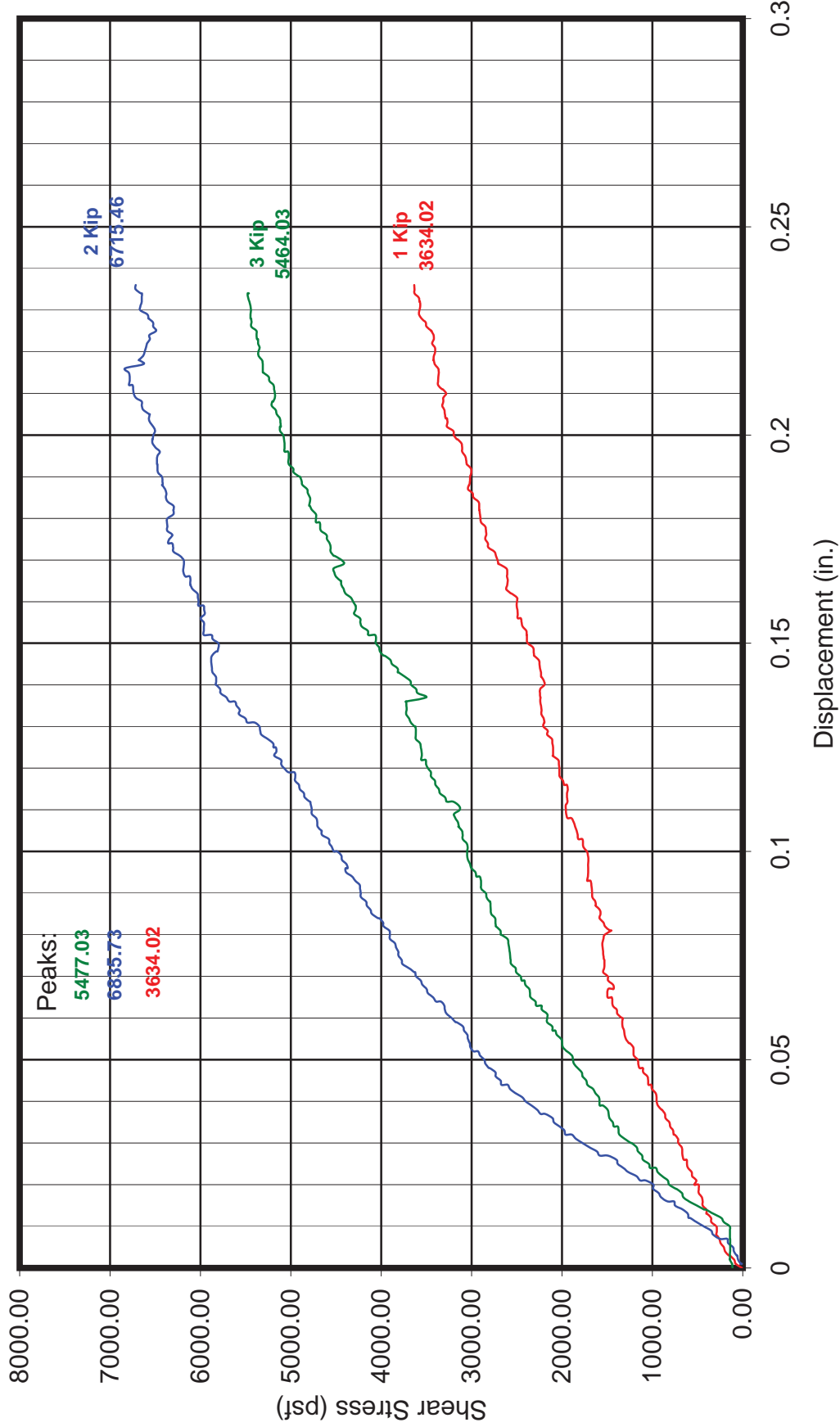

SHEAR TEST DIAGRAM

Material: Mint Canyon Fm - Greenish-gray CLAYSTONE Undisturbed

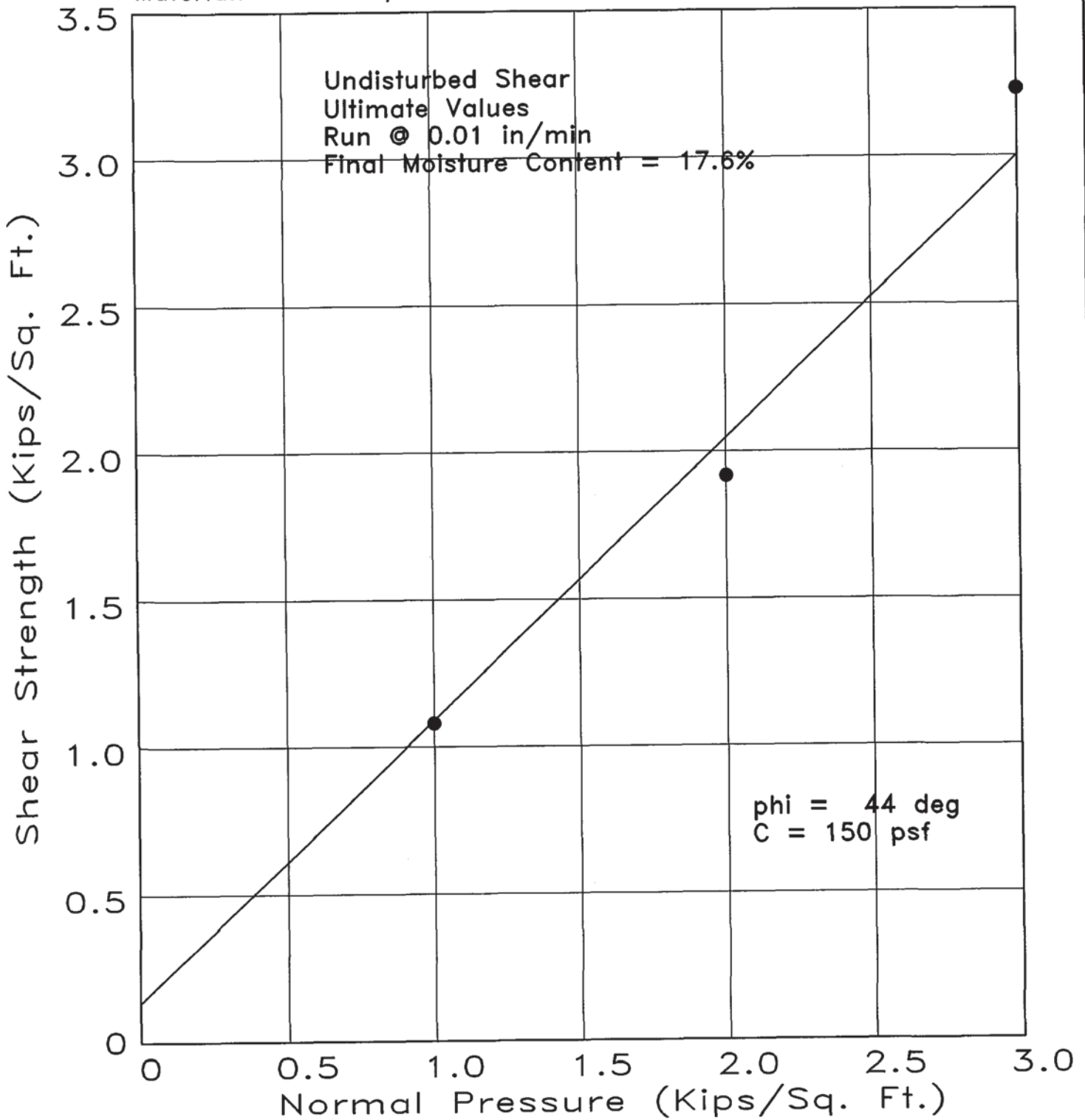

Project Tr. 060922 Skyline Ranch
Excavation B40
Depth 50 Feet



Geolabs - Westlake Village
GEOLOGY AND SOIL ENGINEERING

BY DS
DATE _____ W.O. 8838

Excavation: B40

Depth: 50 ft

Displacement Rate: 0.0100 in/min

SHEARS 1K, 2K, & 3K NORMAL LOADS Undisturbed, Sat at 17.6 %

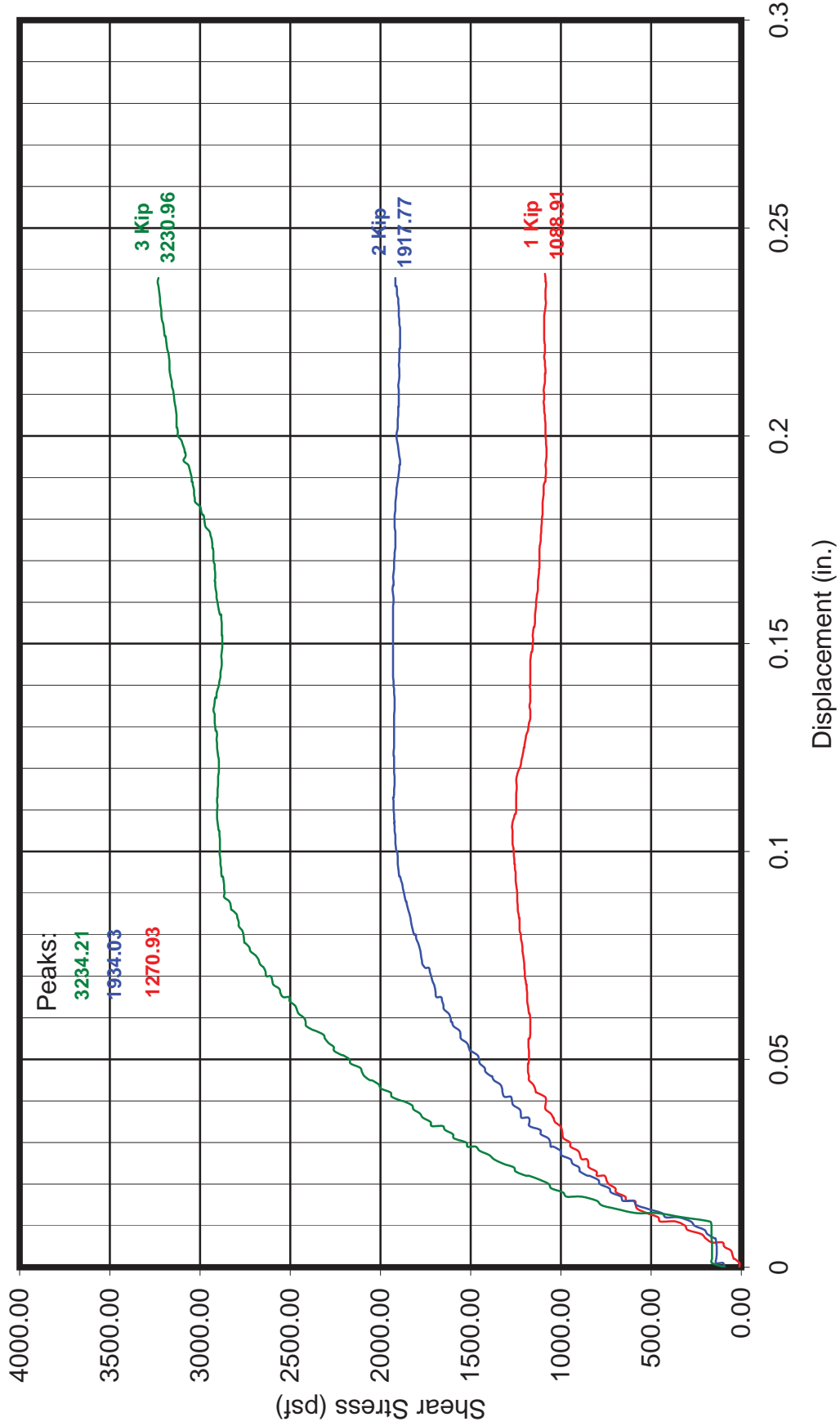

SHEAR TEST DIAGRAM

Material: Saugus Fm. - Med. to coarse-grained Sandstone

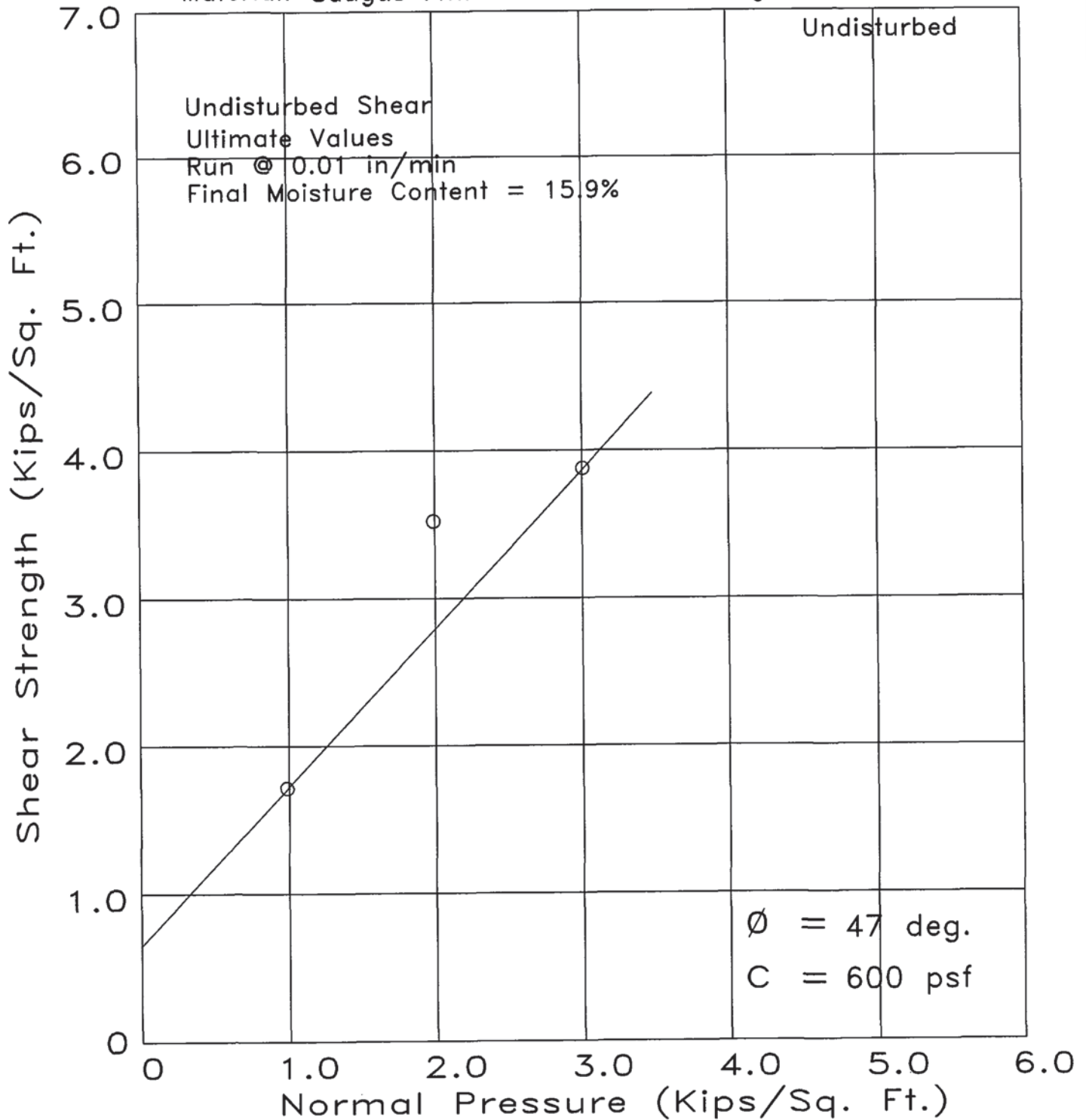

Project Tr. 060922 Skyline Ranch
 Excavation B41
 Depth 10 Feet



Geolabs - Westlake Village
 GEOLOGY AND SOIL ENGINEERING

DATE _____ BY DS
 SCALE _____ W.O. 8838

SHEARS 1K, 2K, & 3K NORMAL LOADS Undisturbed, Sat at 15.9 %

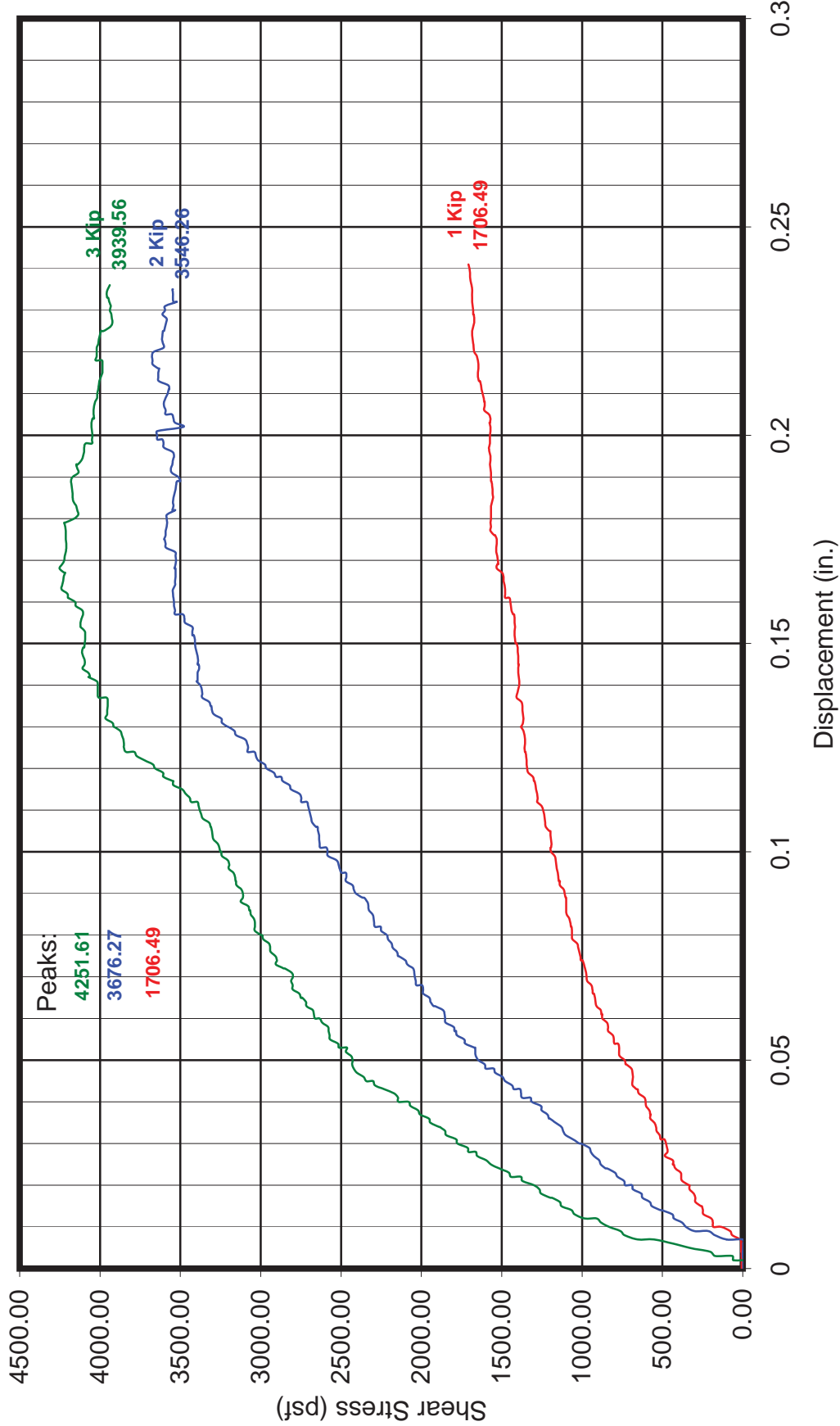

SHEAR TEST DIAGRAM

Material: Mint Canyon Formation - CONGLOMERATE Undisturbed

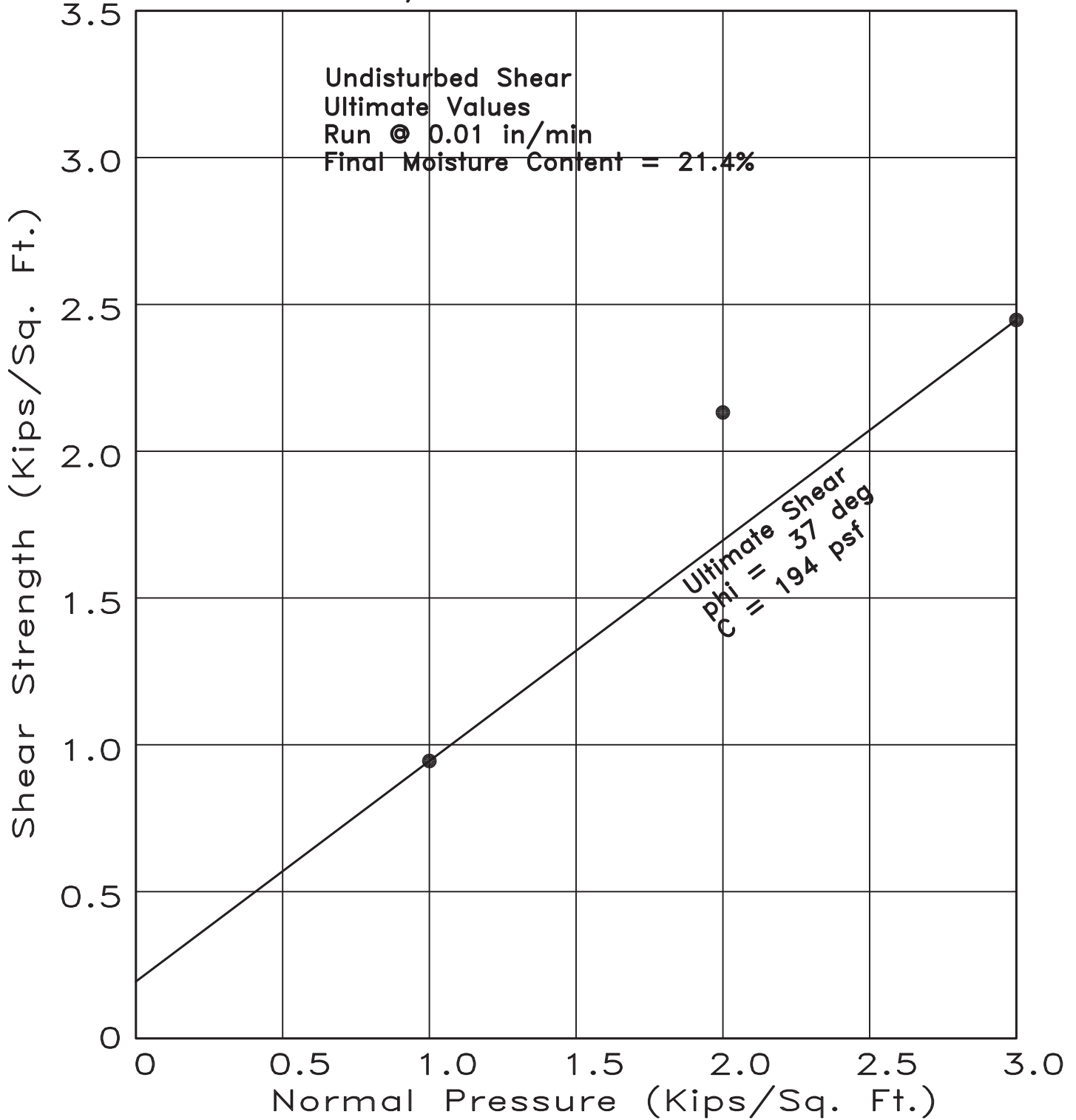

Project Tr. 060922 Skyline Ranch
Excavation B43
Depth 30 Feet



Geolabs - Westlake Village
GEOLOGY AND SOIL ENGINEERING

BY DS
DATE _____ W.O. 8838

Excavation: B43

Depth: 30 ft

Displacement Rate: 0.0100 in/min

SHEARS 1K, 2K, & 3K NORMAL LOADS Undisturbed, Sat at 21.4 %

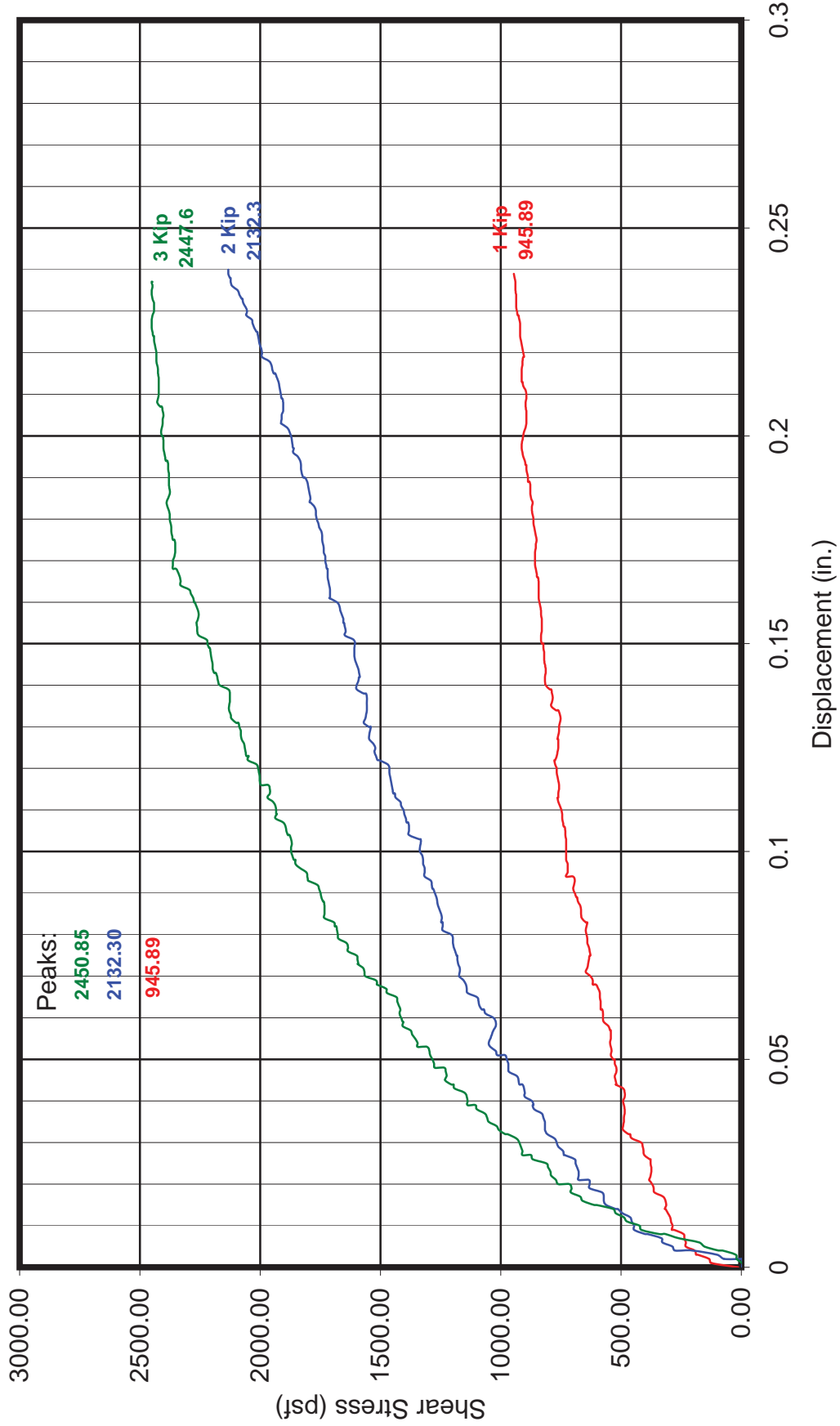

SHEAR TEST DIAGRAM

Material: Mint Canyon Fm. - Sandstone Undisturbed

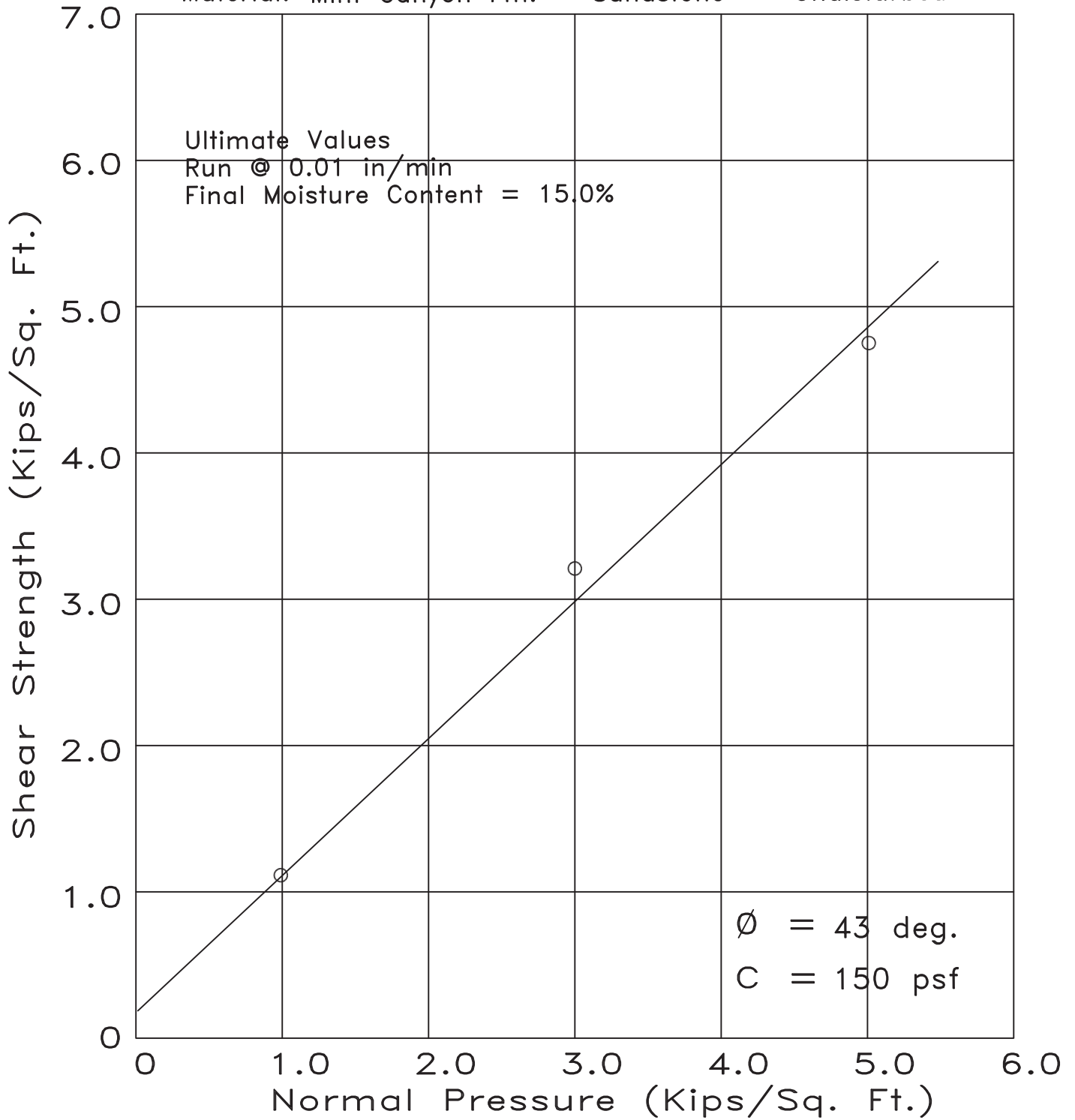

Project Tr. 060922 Skyline Ranch
Excavation B44
Depth 50 Feet



Geolabs - Westlake Village
GEOLOGY AND SOIL ENGINEERING

DATE _____ BY DS
SCALE _____ w.o. 8838

Excavation: B44 Depth: 50 ft Displacement Rate: 0.0100 in/min

SHEARS 1K, 3K, & 5K NORMAL LOADS Undisturbed, Sat at 15.0 %

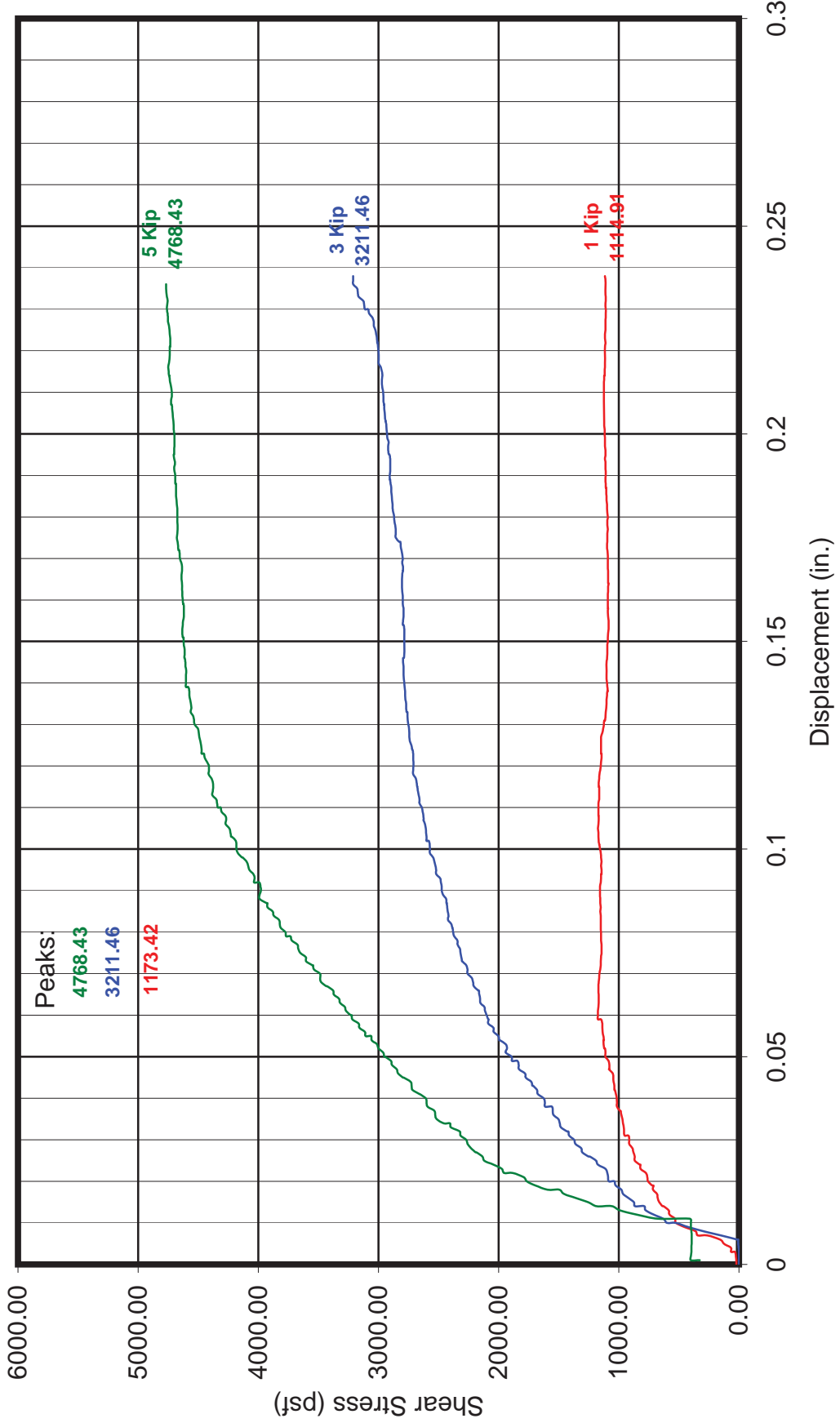

SHEAR TEST DIAGRAM

Material: Saugus Fm. - Fine to coarse SANDSTONE Undisturbed

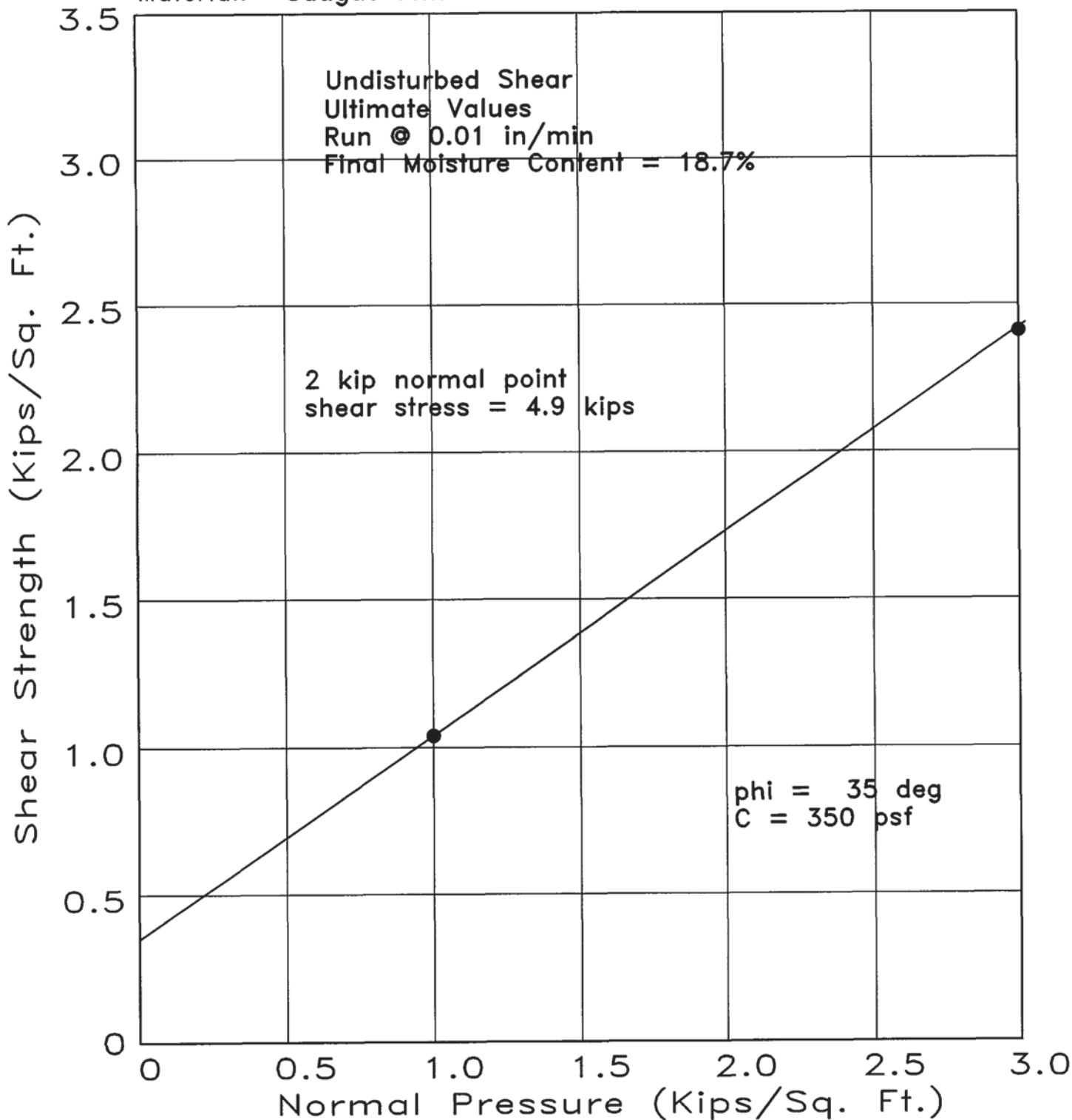

Project Tr. 060922 Skyline Ranch
 Excavation B46
 Depth 30 Feet



Geolabs - Westlake Village
GEOLOGY AND SOIL ENGINEERING

BY DS
 W.O. 8838
 DATE _____

Excavation: B46 Depth: 30 ft Displacement Rate: 0.0100 in/min

SHEARS 1K, 2K, & 3K NORMAL LOADS Undisturbed, Sat at 18.7 %

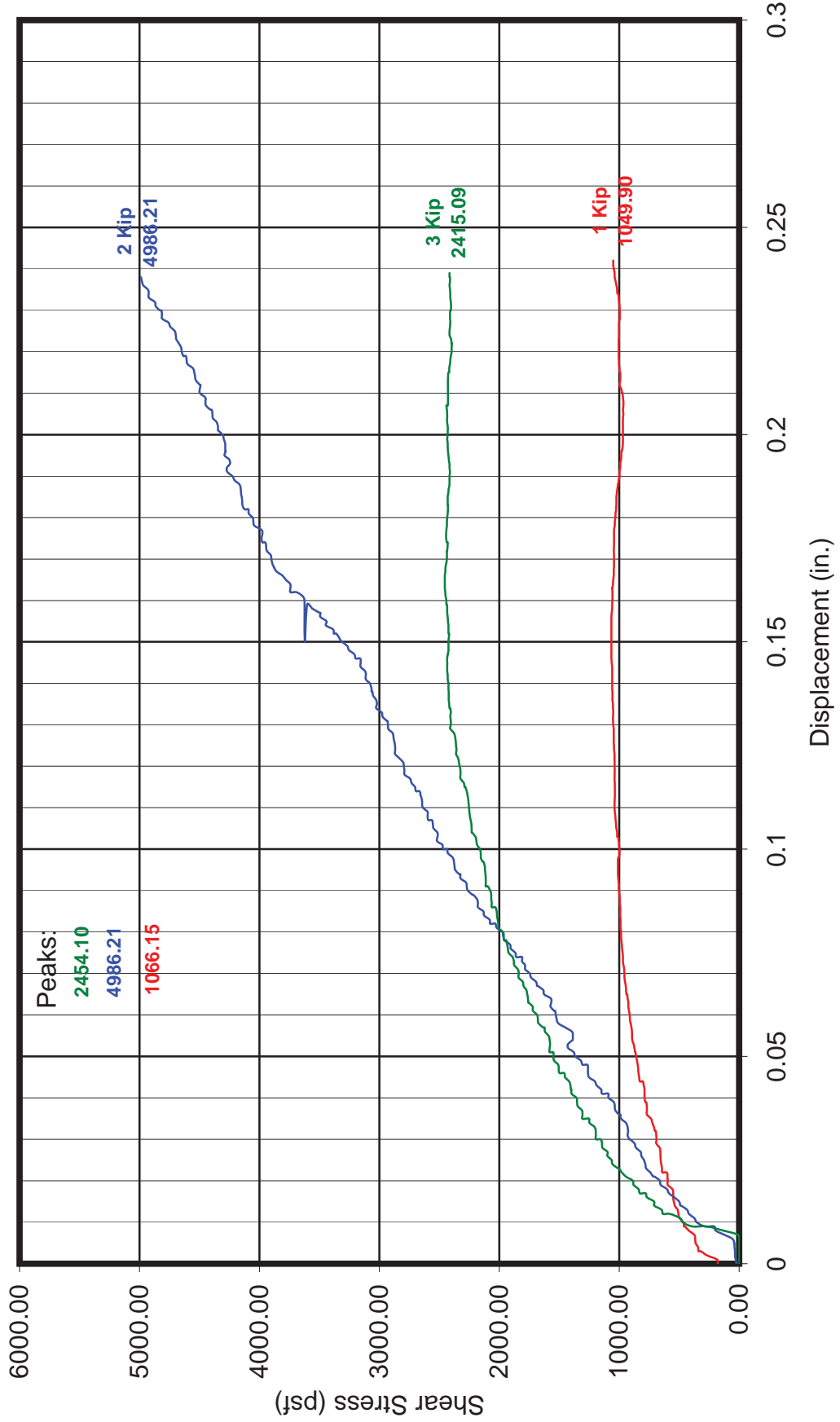

SHEAR TEST DIAGRAM

Material: Saugus Fm. - Fine-cs grained Sandstone

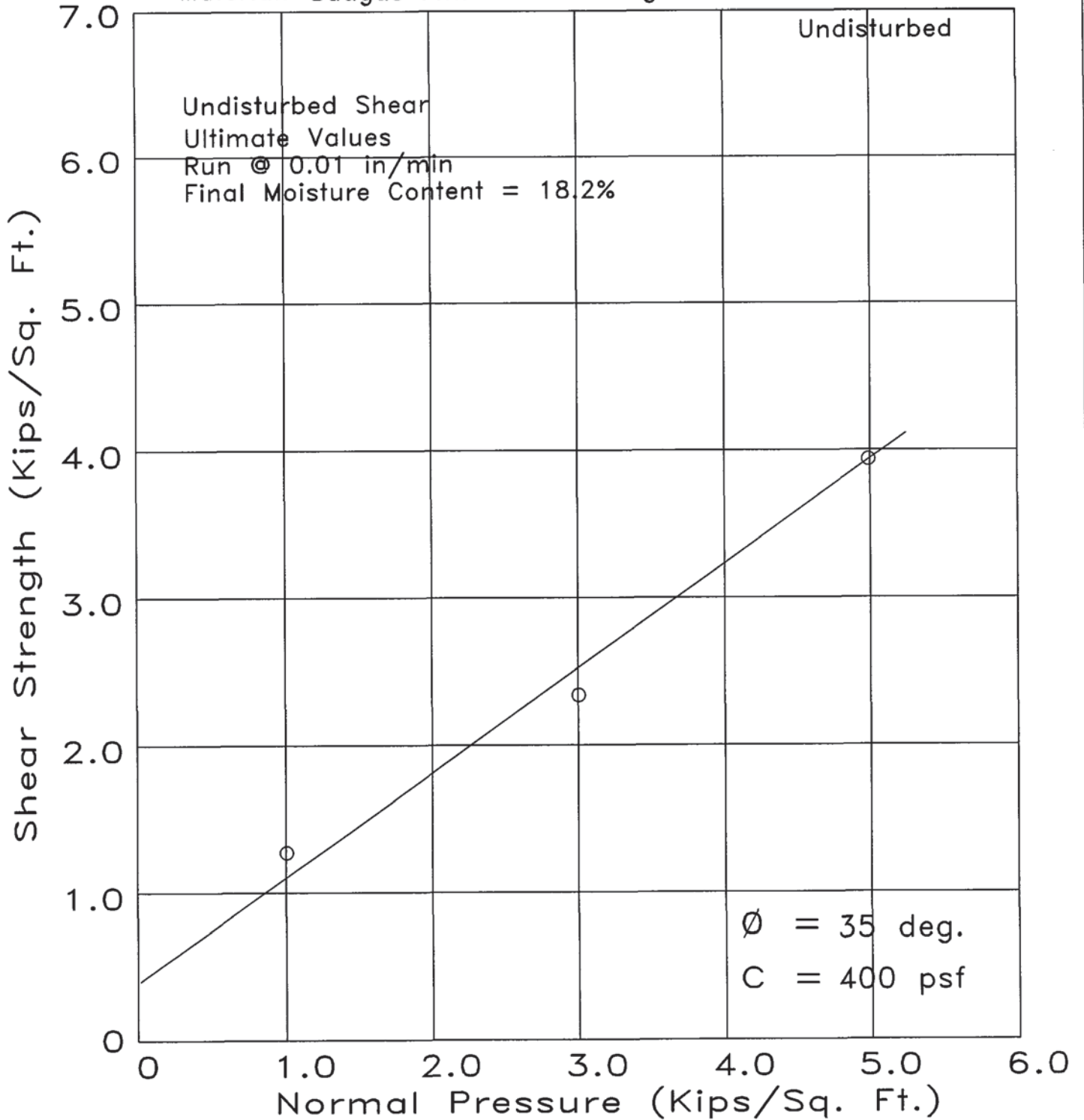

Project Tr. 060922 Skyline Ranch
Excavation B46
Depth 80 Feet



Geolabs - Westlake Village
GEOLOGY AND SOIL ENGINEERING

DATE _____ BY DS
SCALE _____ W.O. 8838

Excavation: B46

Depth: 80 ft

Displacement Rate: 0.0100 in/min

SHEARS 1K, 3K, & 5K NORMAL LOADS Undisturbed, Sat at 18.2 %

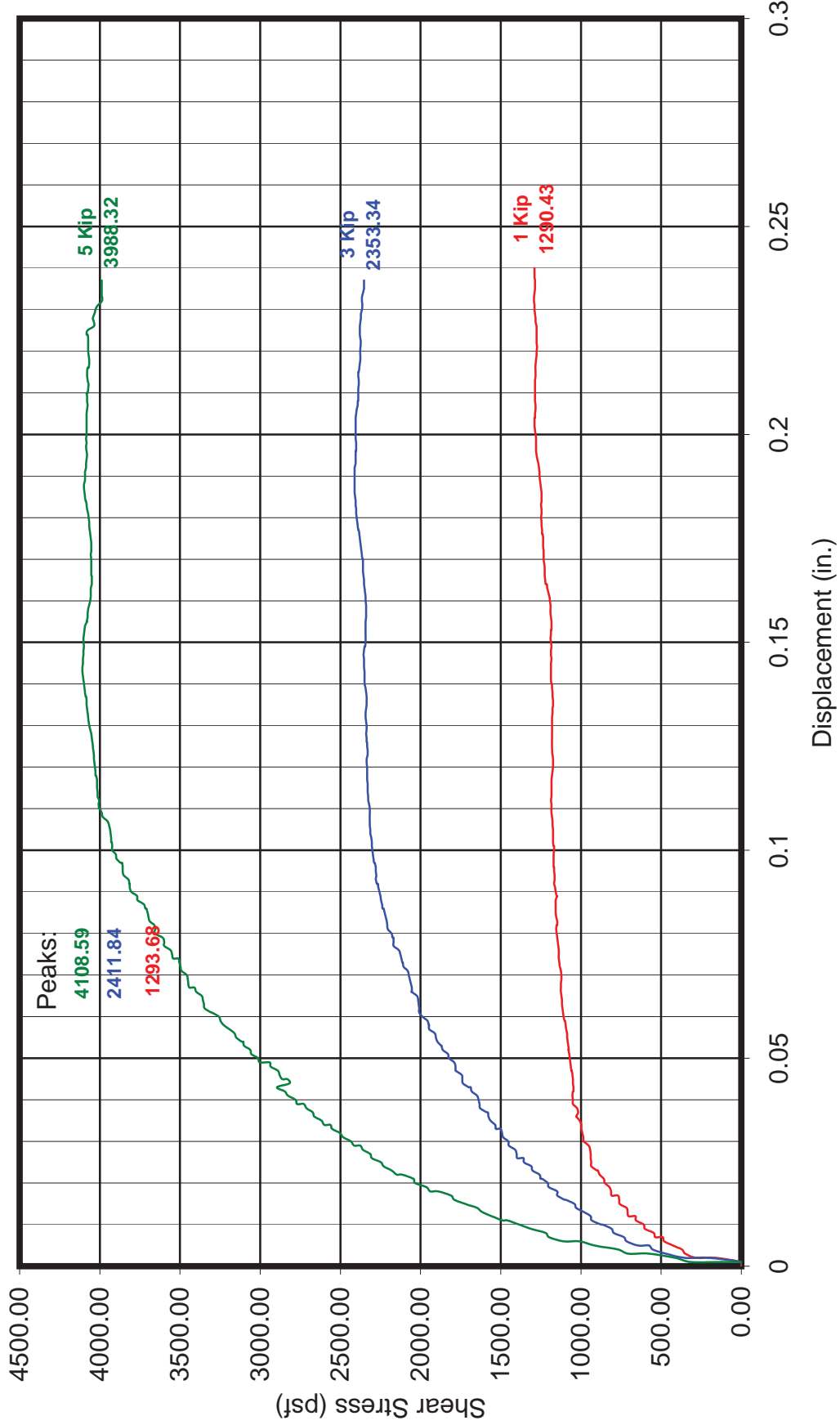

SHEAR TEST DIAGRAM

Material: Saugus Fm. - Silty SANDSTONE Undisturbed

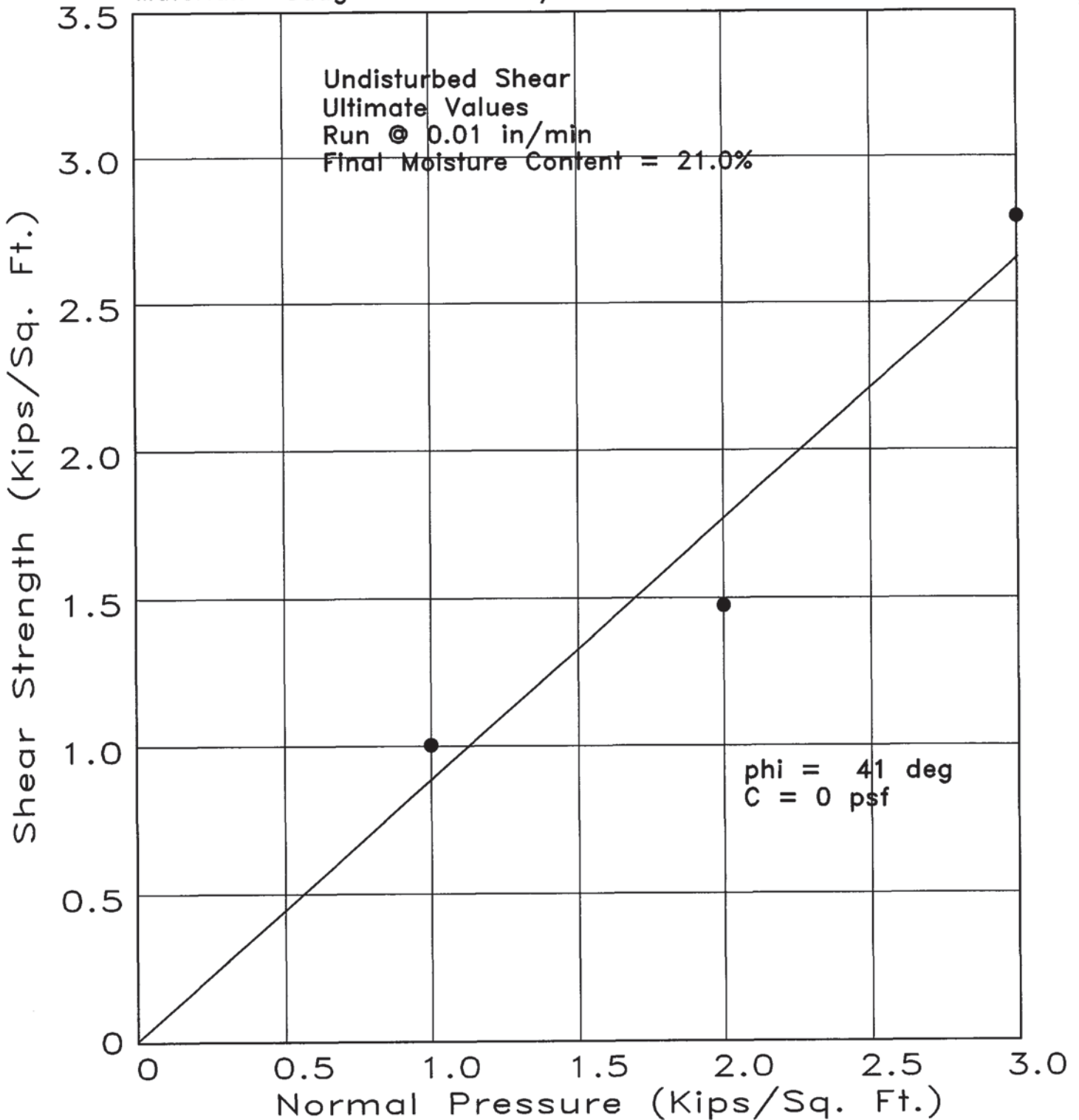

Project Tr. 060922 Skyline Ranch
 Excavation B47
 Depth 40 Feet



Geolabs - Westlake Village
GEOLOGY AND SOIL ENGINEERING

BY DS
 DATE _____ W.O. 8838

Excavation: B47 Depth: 40 ft Displacement Rate: 0.0100 in/min

SHEARS 1K, 2K, & 3K NORMAL LOADS Undisturbed, Sat at 21.0 %

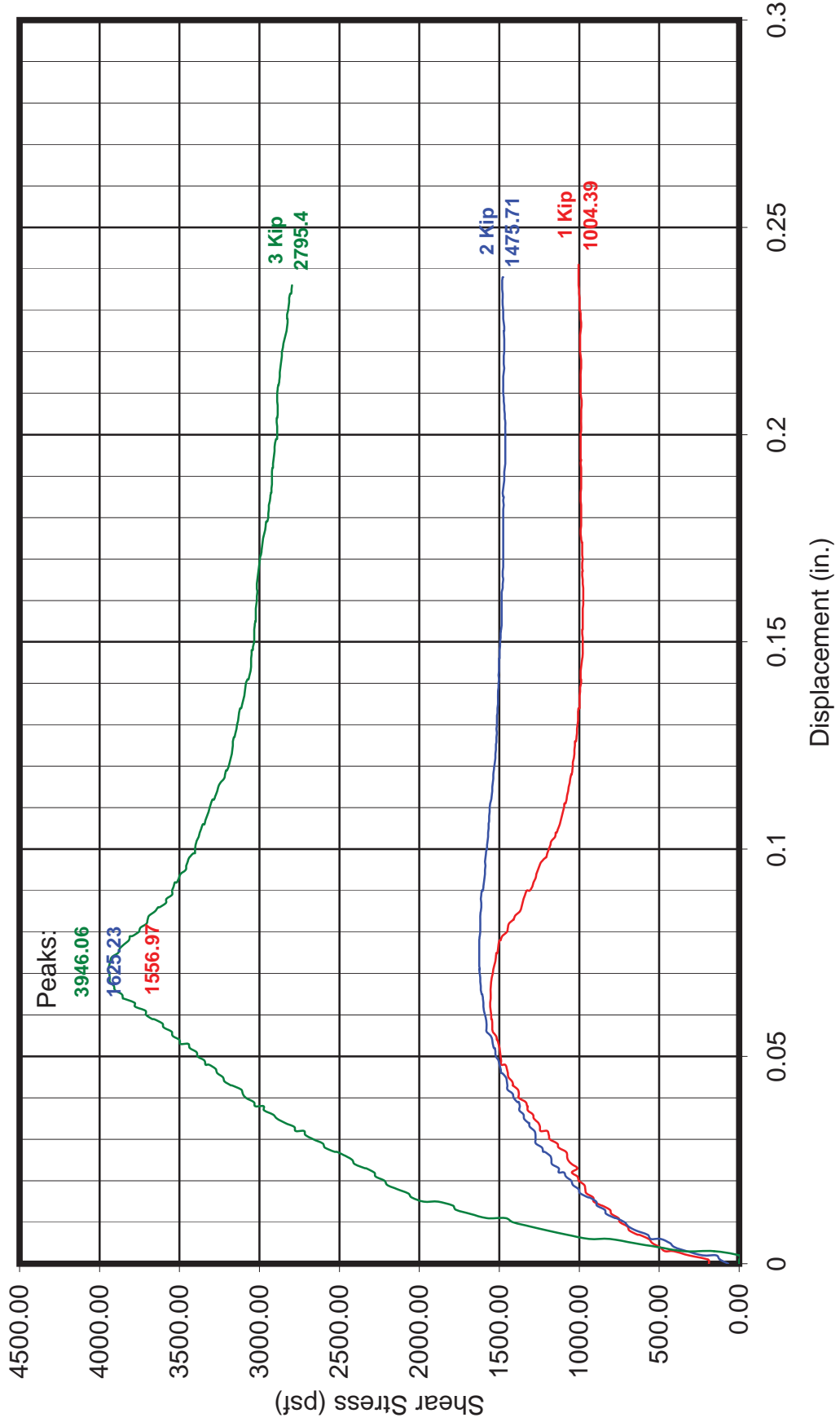

SHEAR TEST DIAGRAM

Material: Saugus Fm. - Brown CLAYSTONE

Undisturbed

Undisturbed Shear
Ultimate Values
Run @ 0.01 in/min
Final Moisture Content = 17.6%

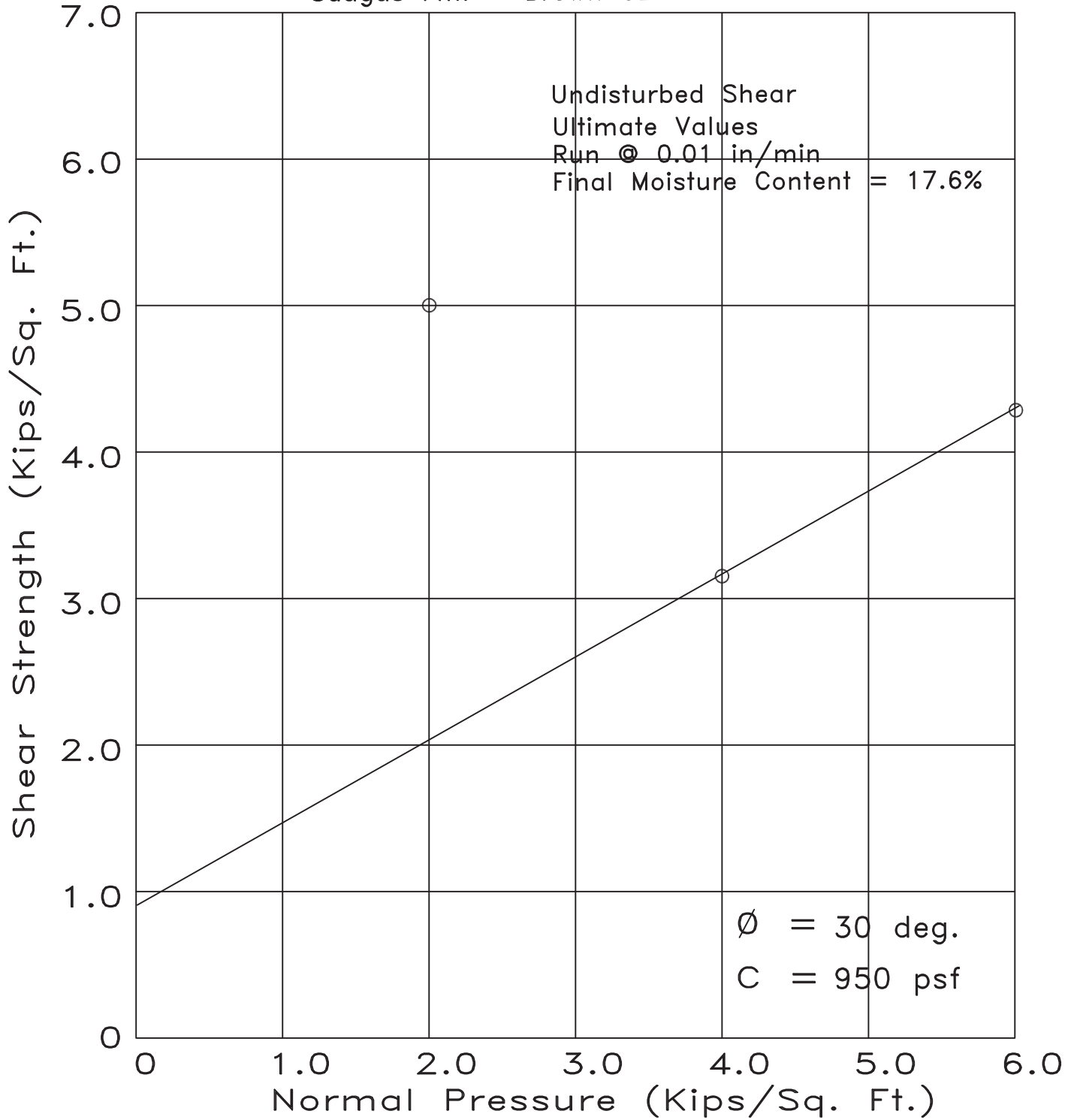

Project Tr. 060922 Skyline Ranch
 Excavation B47
 Depth 100 Feet



Geolabs - Westlake Village
 GEOLOGY AND SOIL ENGINEERING

DATE _____ BY DS
 SCALE _____ w.o. 8838

Excavation: B47

Depth: 100 ft

Displacement Rate: 0.0100 in/min

SHEARS 2K, 4K, & 6K NORMAL LOADS Undisturbed, Sat at 17.6 %

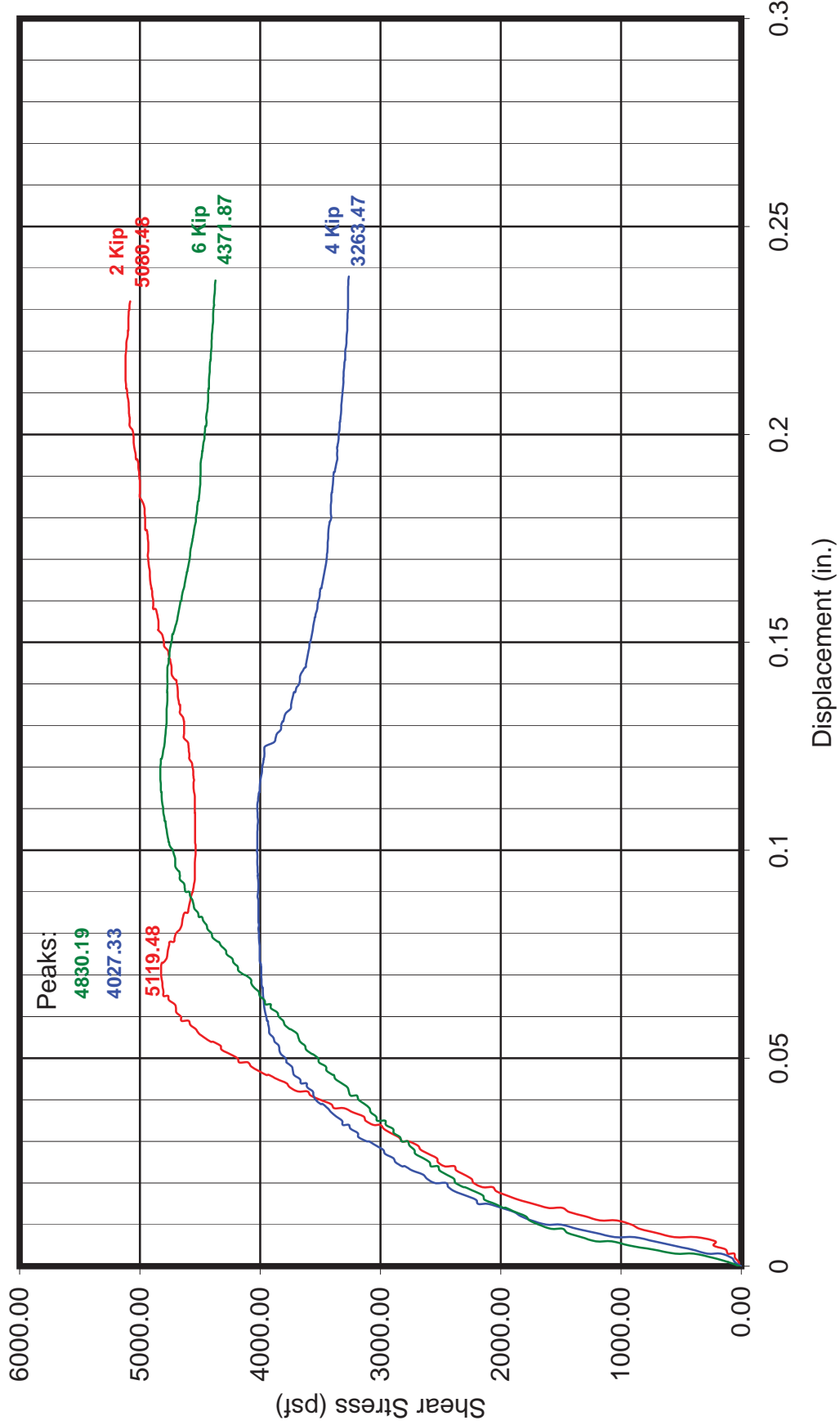

SHEAR TEST DIAGRAM

Material: Saugus Fm. - Gravelly silty SANDSTONE Undisturbed

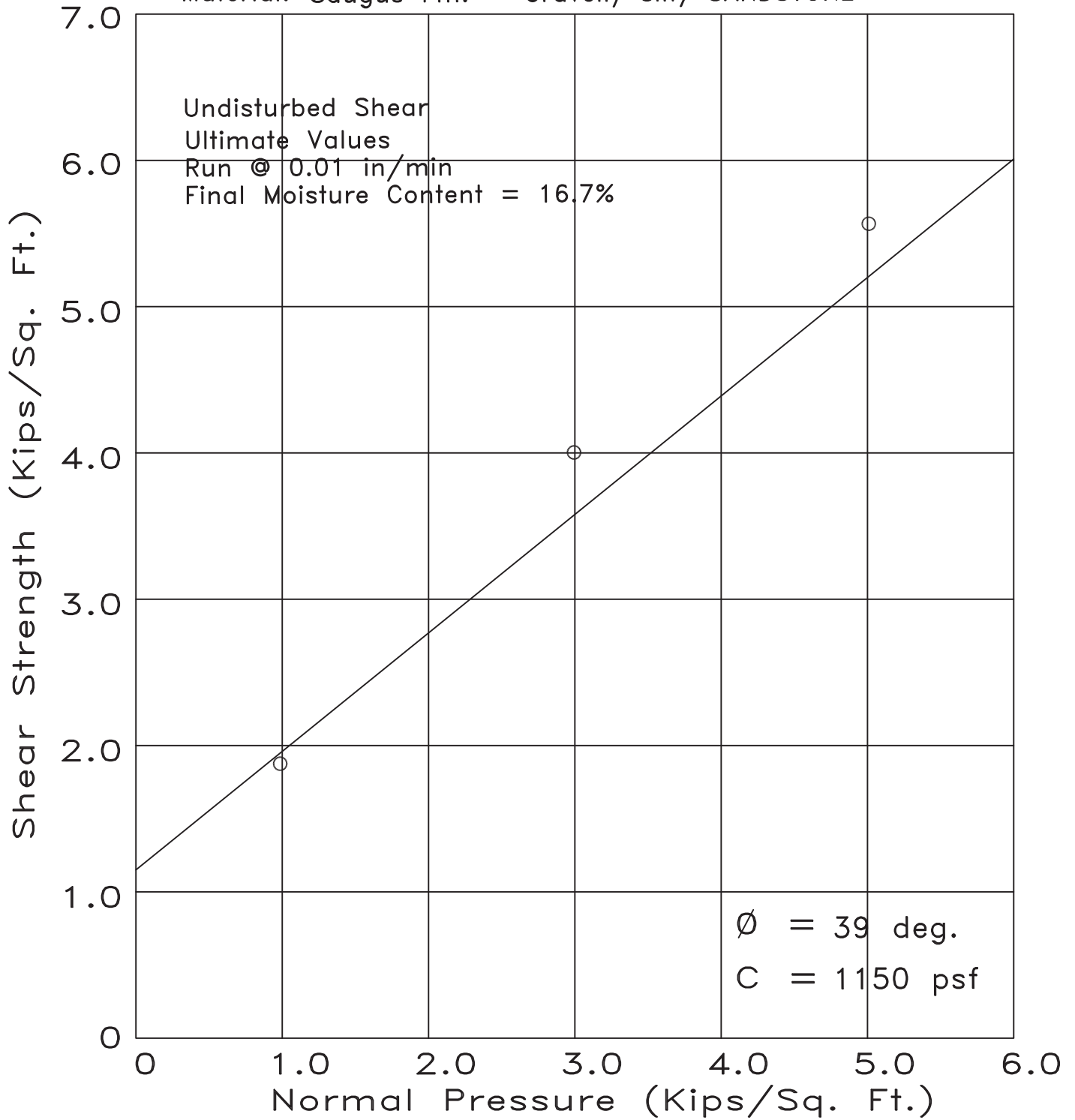

Project Tr. 060922 Skyline Ranch
Excavation B48
Depth 50 Feet



Geolabs - Westlake Village
GEOLOGY AND SOIL ENGINEERING

DATE _____ BY DS
SCALE _____ w.o. 8838

SHEARS 1K, 3K, & 5K NORMAL LOADS Undisturbed, Sat at 16.7 %

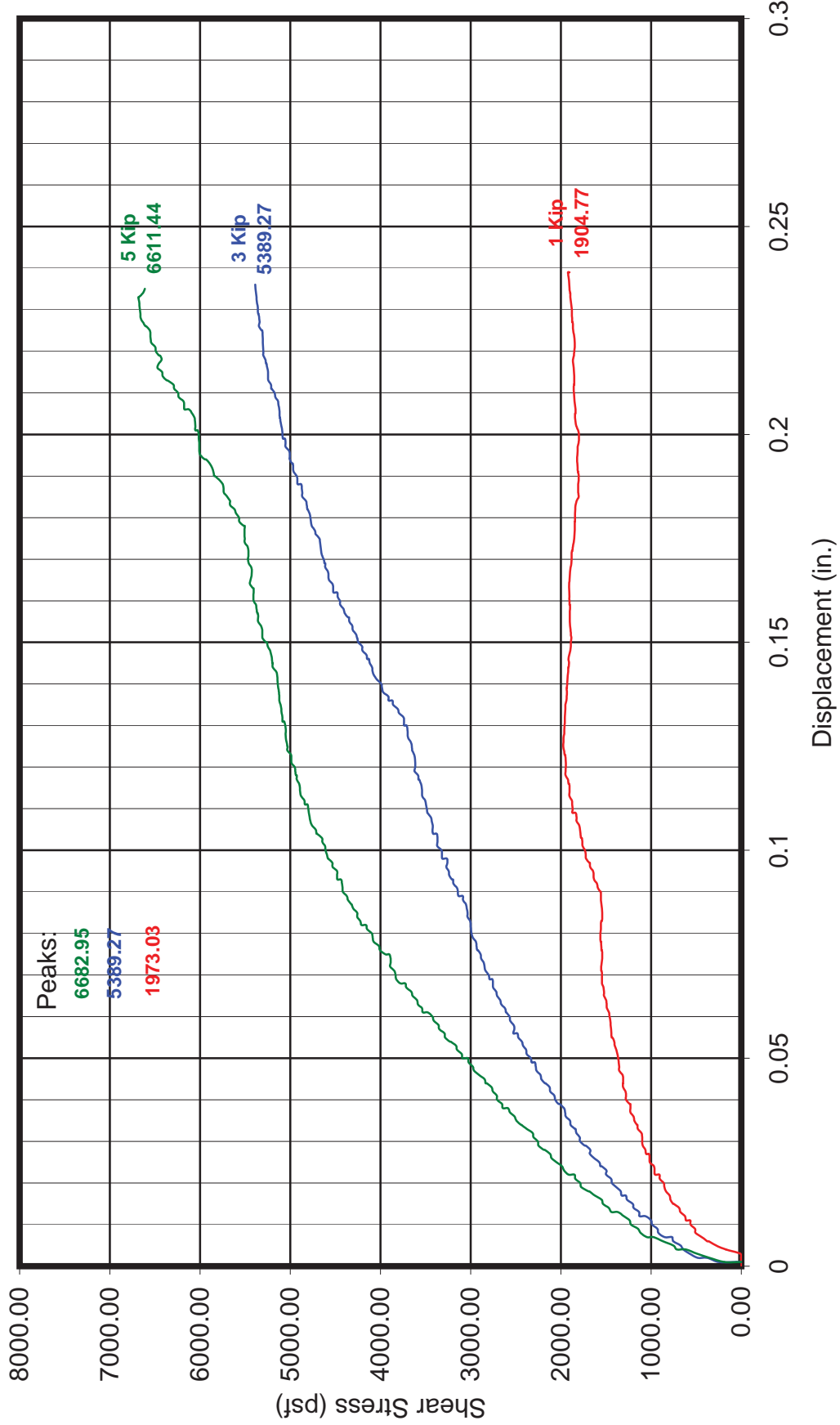

SHEAR TEST DIAGRAM

Material: Mint Canyon Formation - Sandstone Undisturbed

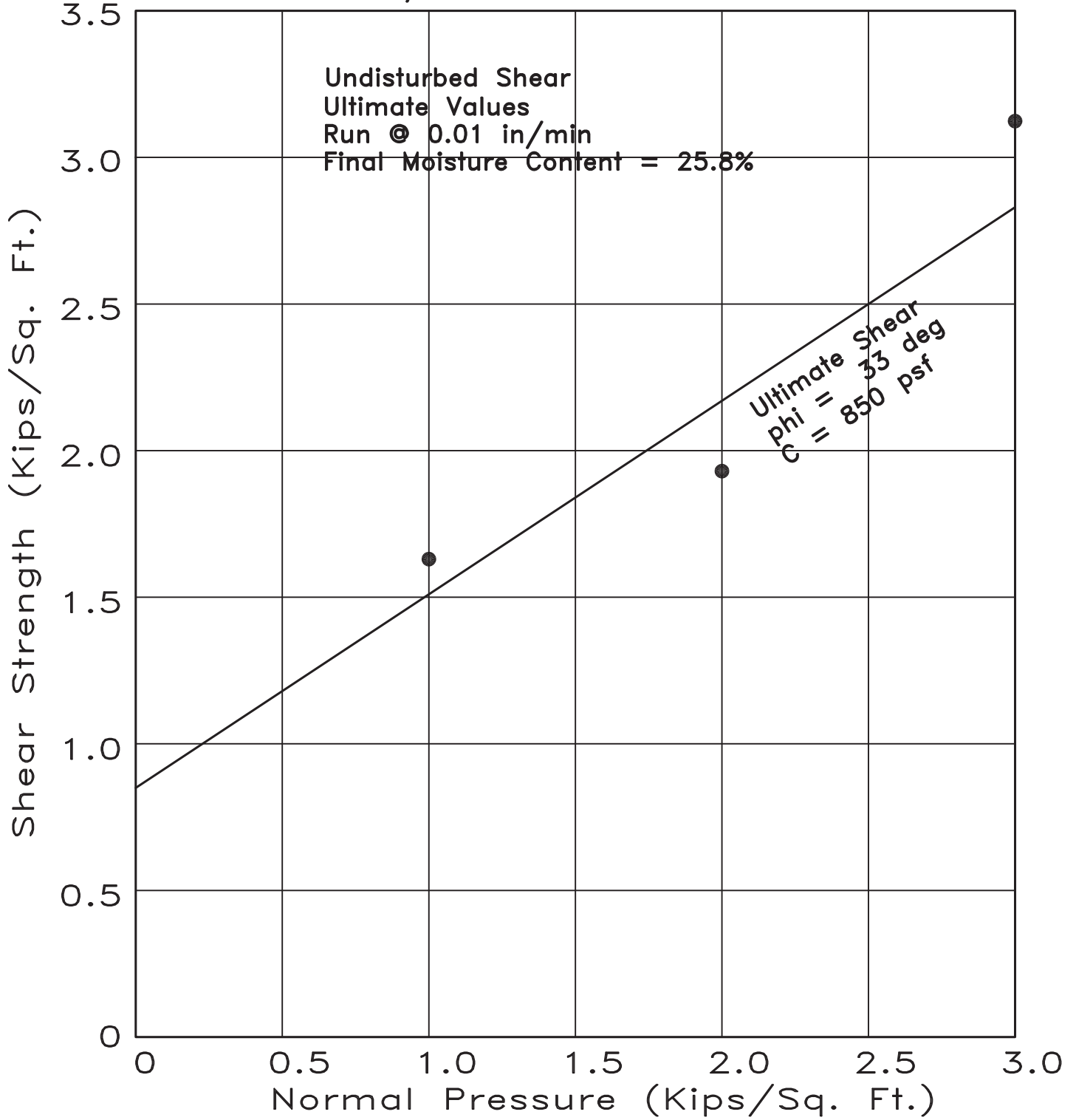

Project Tr. 060922 Skyline Ranch
 Excavation B50
 Depth 50 Feet



Geolabs - Westlake Village
GEOLOGY AND SOIL ENGINEERING

BY DS
 DATE _____ W.O. 8838

Excavation: B50 Depth: 50 ft Displacement Rate: 0.0100 in/min

SHEARS 1K, 2K, & 3K NORMAL LOADS Undisturbed, sat. @ 25.8%

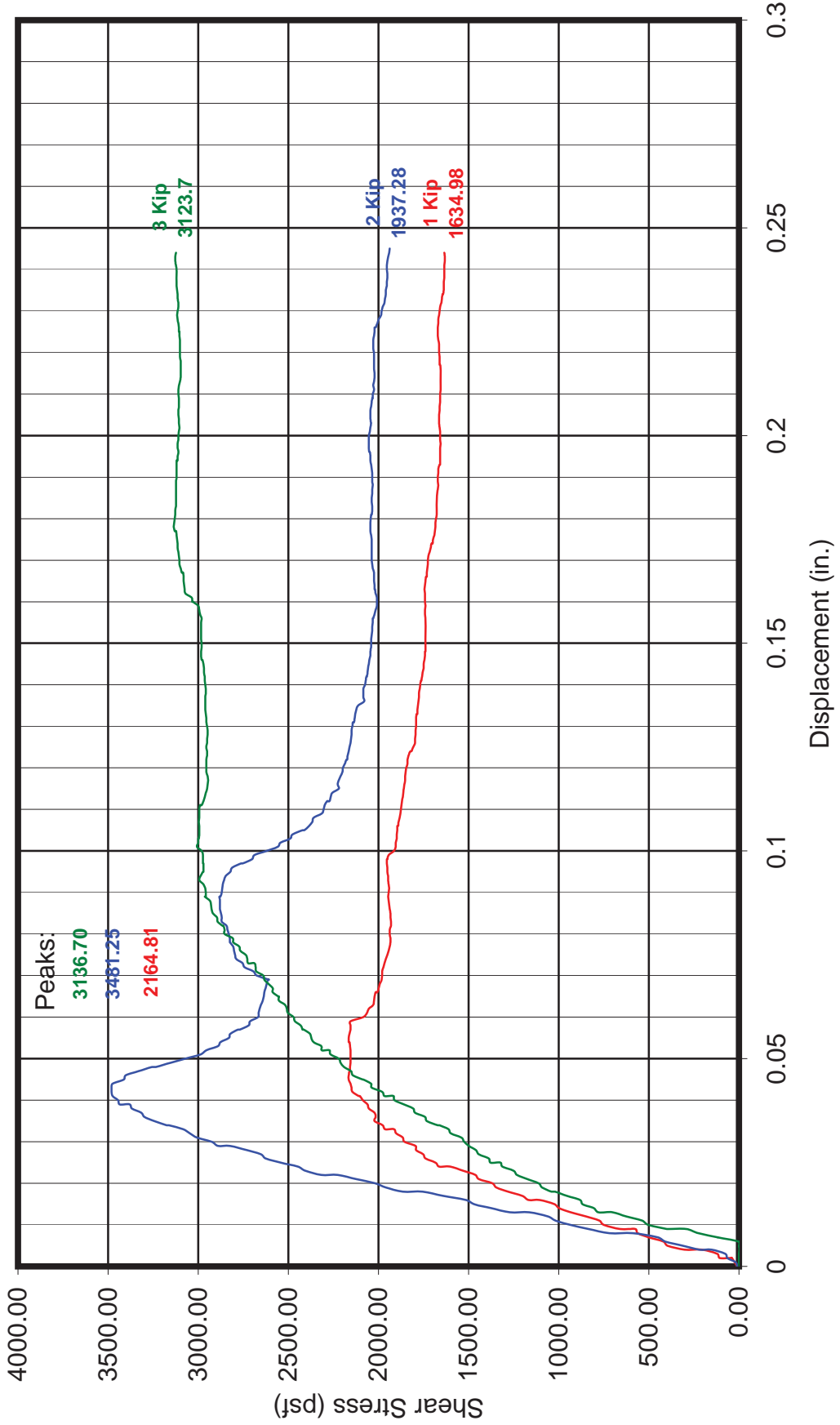

SHEAR TEST DIAGRAM

Material: Mint Canyon Fm. - CONGLOMERATE

Undisturbed

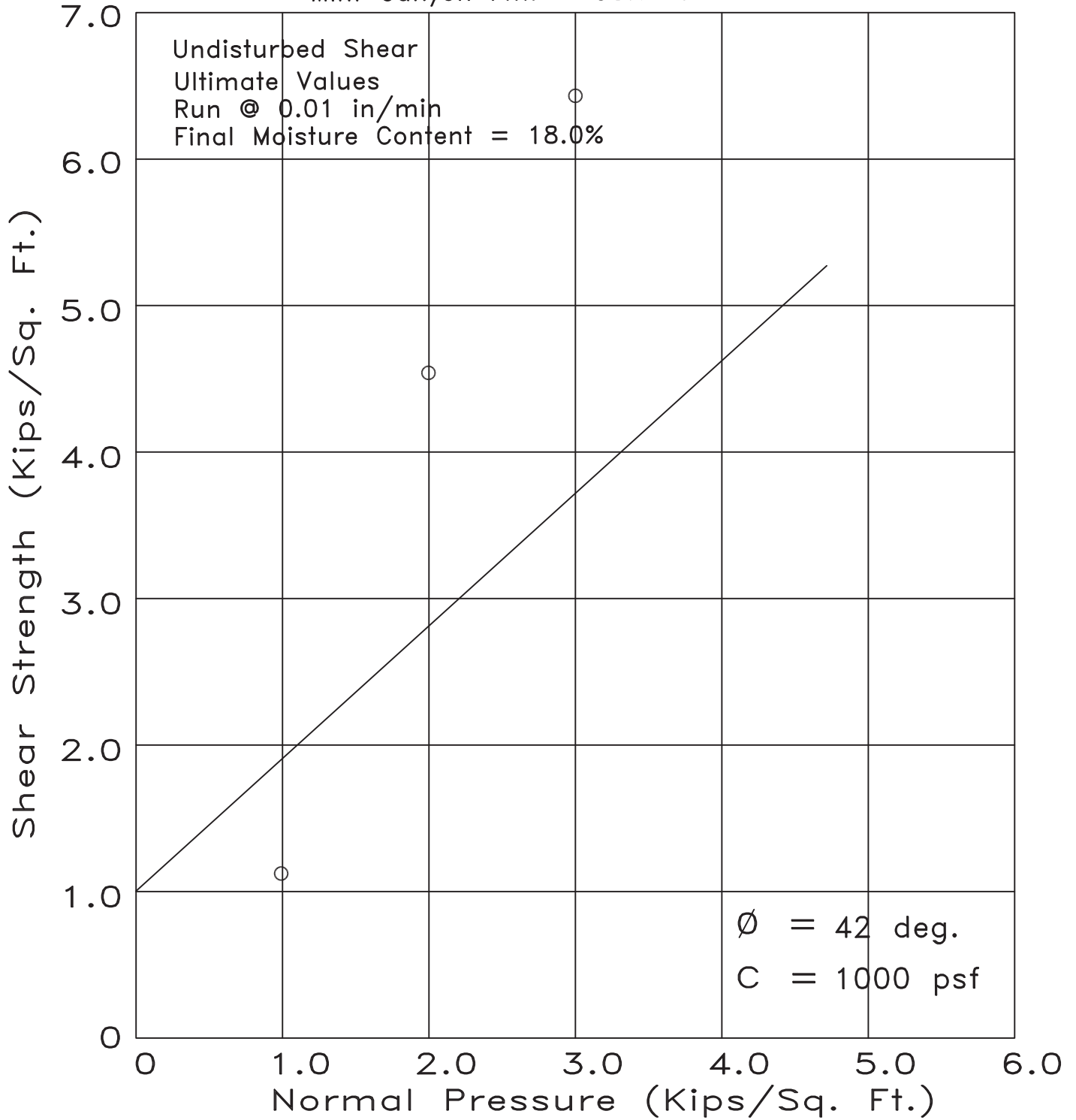

Project Tr. 060922 Skyline Ranch
Excavation B52
Depth 44 Feet



Geolabs - Westlake Village
GEOLOGY AND SOIL ENGINEERING

DATE _____ BY DS
SCALE _____ w.o. 8838

Excavation: B52 Depth: 44 ft Displacement Rate: 0.0100 in/min

SHEARS 1K, 2K, & 3K NORMAL LOADS Undisturbed, Sat at 18.0 %

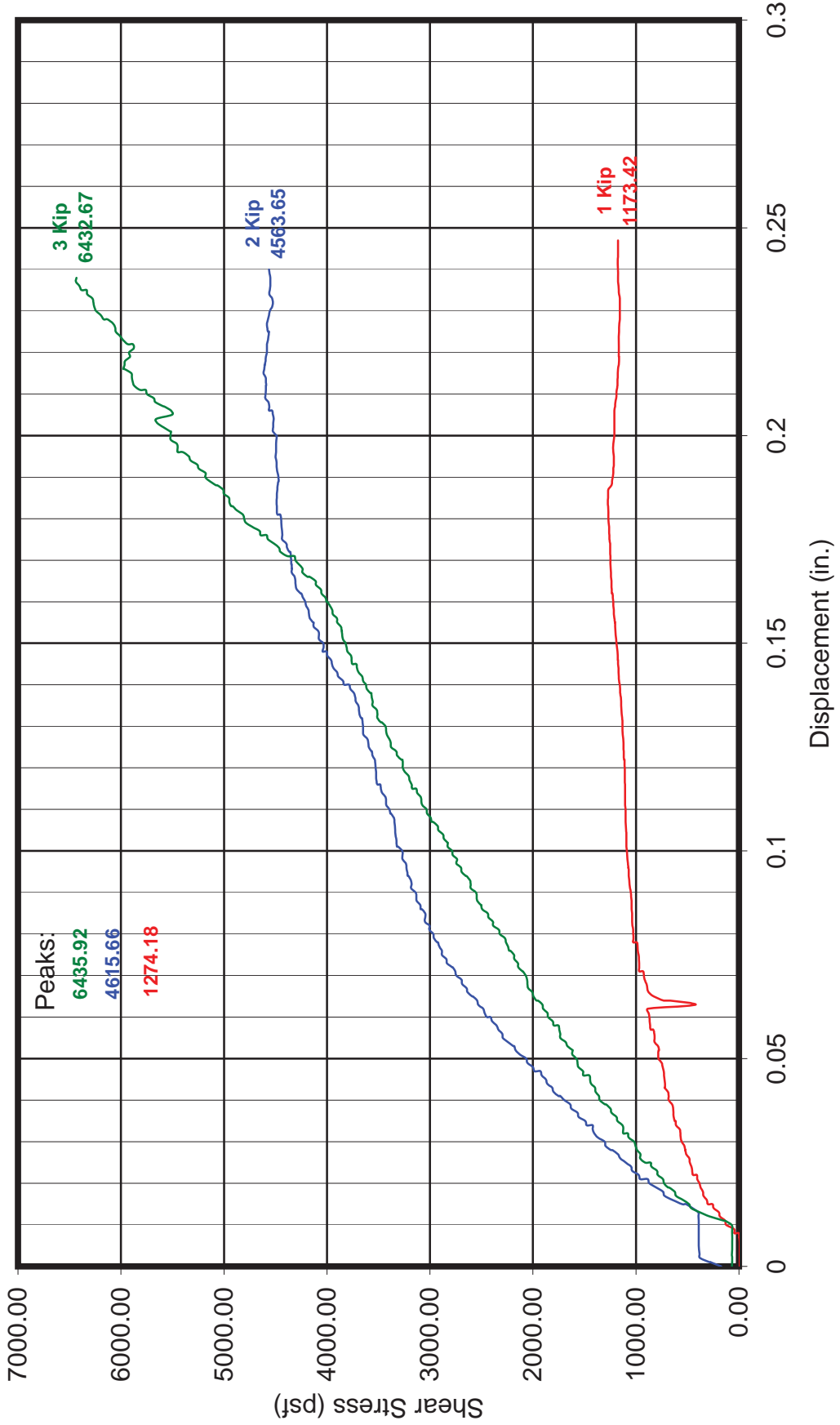

SHEAR TEST DIAGRAM

Material: Mint Canyon Fm. - Conglomerate

Undisturbed

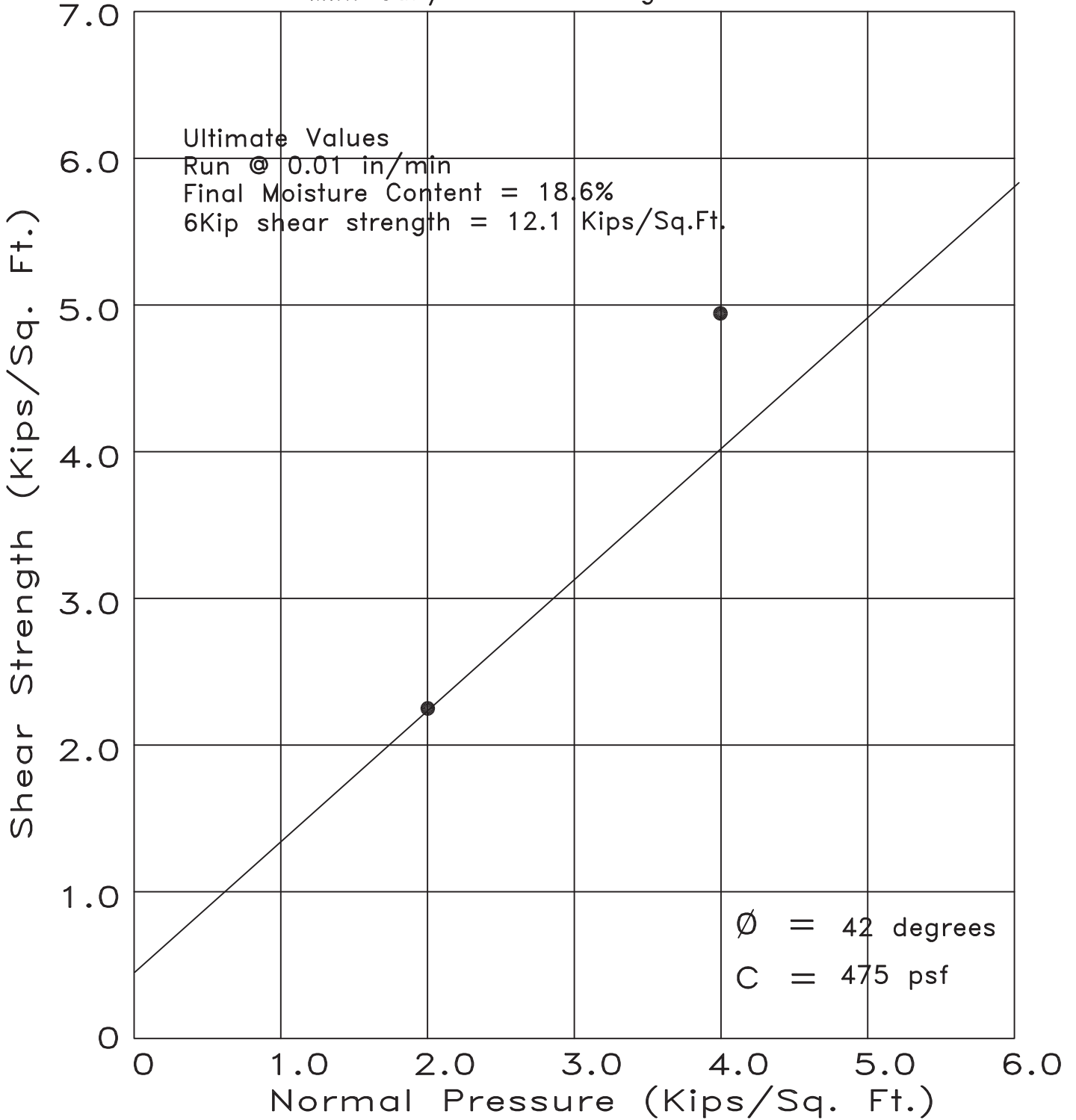

Project Skyline Ranch Tr. 060922
 Excavation B52
 Depth 61 Feet



Geolabs - Westlake Village
 GEOLOGY AND SOIL ENGINEERING

DATE _____ BY DS
 SCALE _____ w.o. 8838

Excavation: B52 Depth: 61 ft Displacement Rate: 0.0100 in/min

SHEARS 2K, 4K, & 6K NORMAL LOADS Undisturbed, Sat at 18.6 %

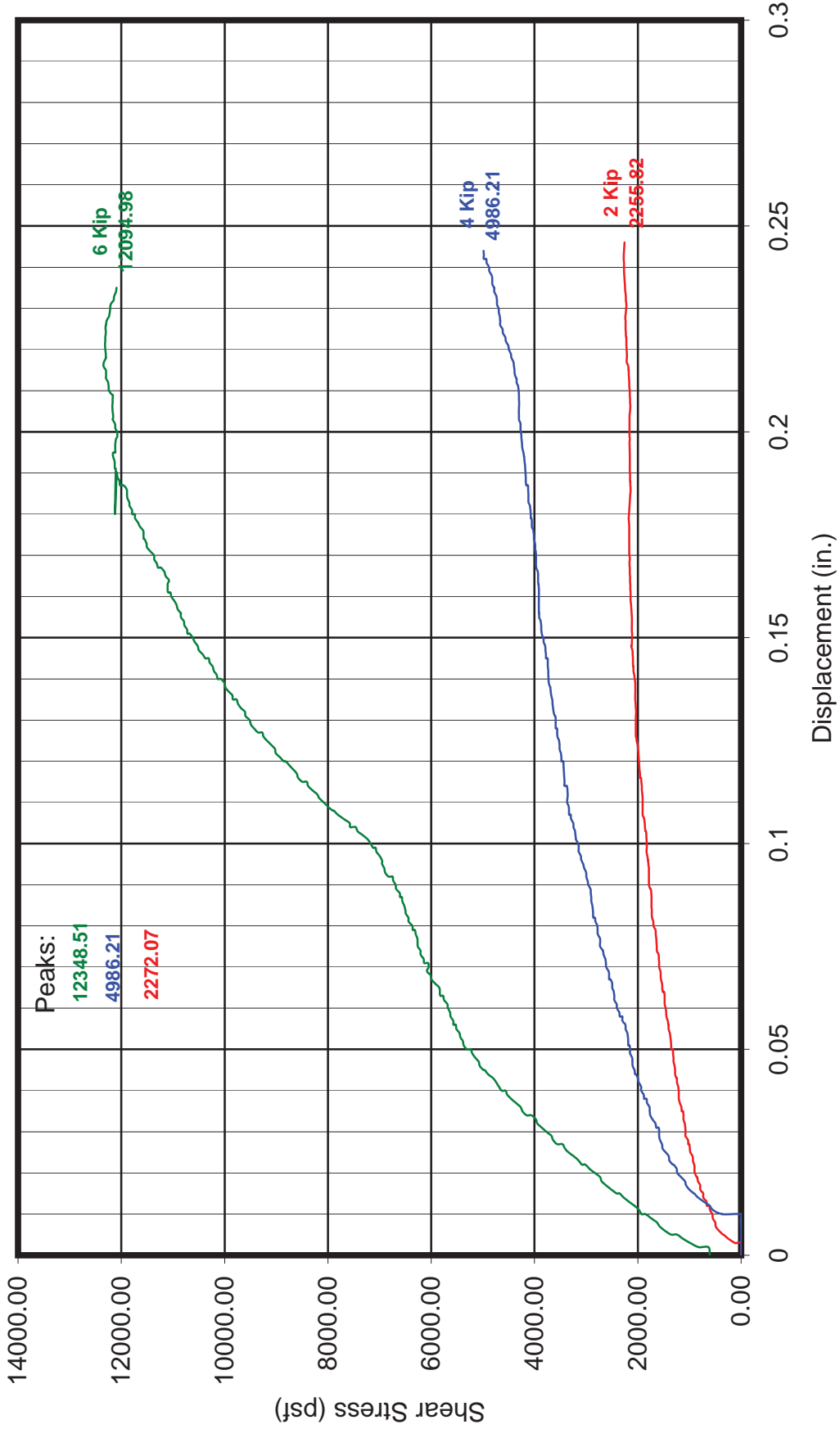

SHEAR TEST DIAGRAM

Material: Saugus Formation - Clayey SANDSTONE Undisturbed

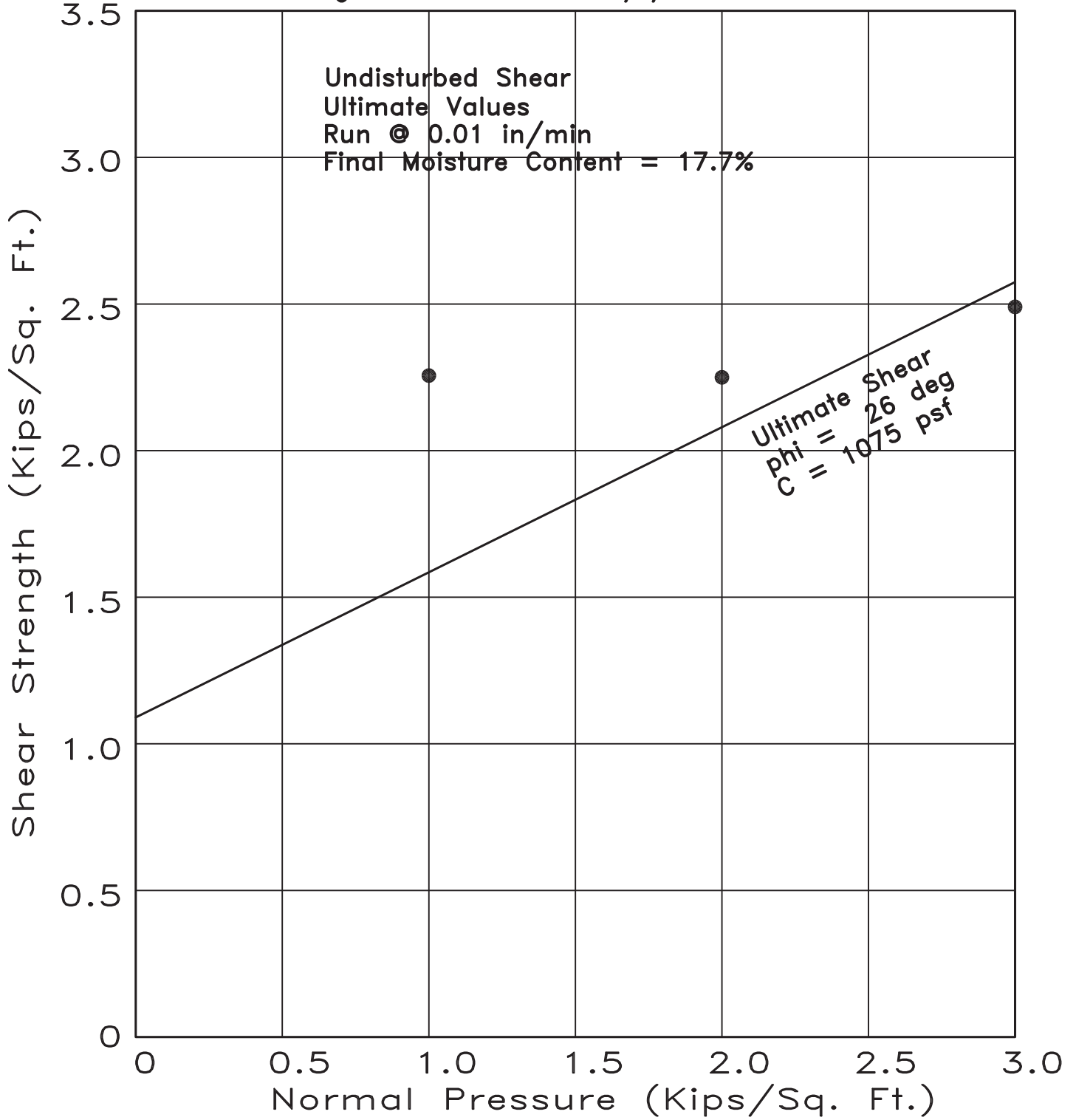

Project Tr. 060922 Skyline Ranch
 Excavation B53
 Depth 20 Feet



Geolabs - Westlake Village
GEOLOGY AND SOIL ENGINEERING

BY DS
 DATE _____ W.O. 8838

SHEARS 1K, 2K, & 3K NORMAL LOADS Undisturbed, Sat at 17.7 %

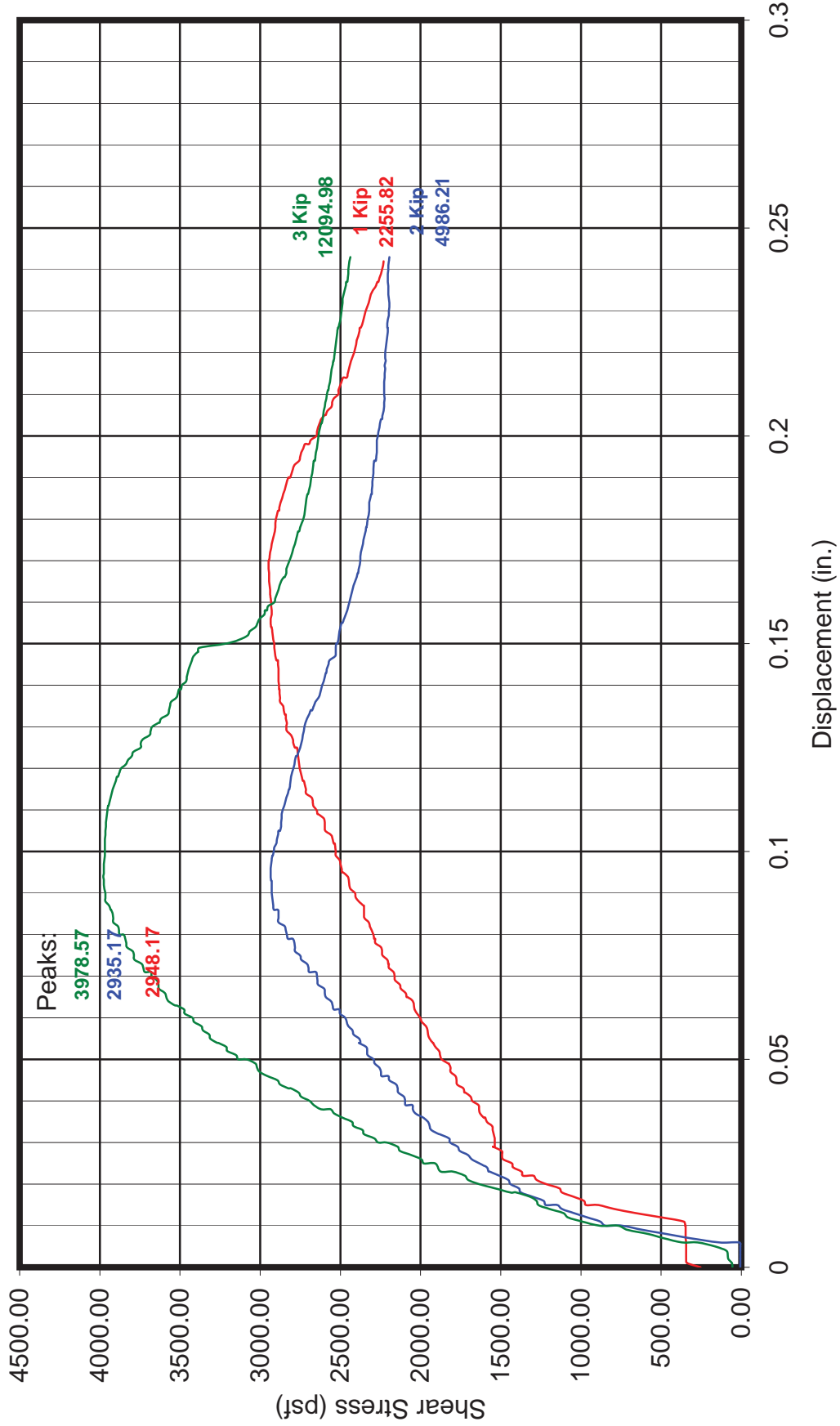

SHEAR TEST DIAGRAM

Material: **Landslide Debris - Sandstone** Undisturbed

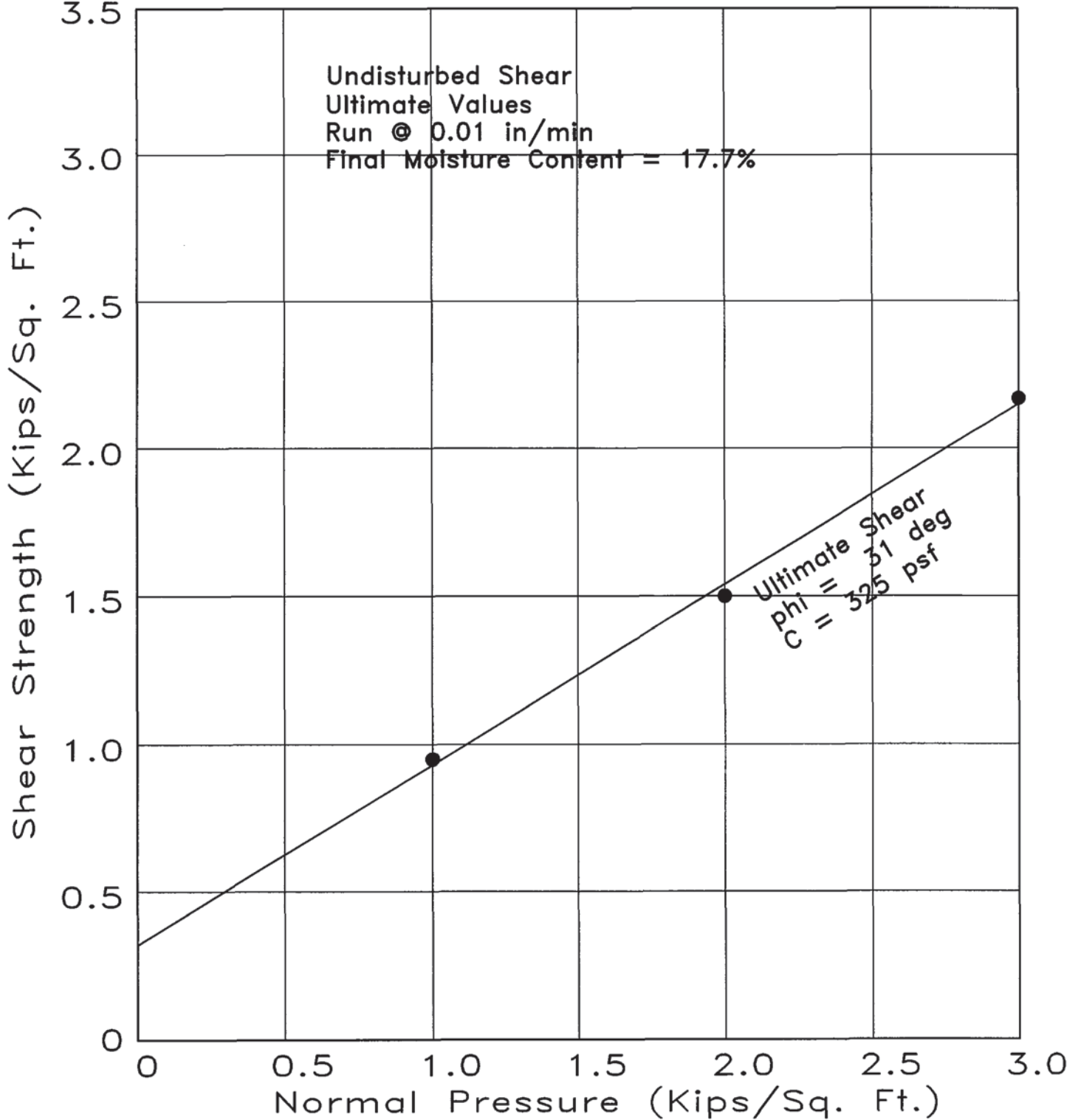

Project Tr. 060922 Skyline Ranch
Excavation B54
Depth 30 Feet



Geolabs - Westlake Village
GEOLOGY AND SOIL ENGINEERING

BY DS
DATE _____ W.O. 8838

Excavation: B54 Depth: 30 ft Displacement Rate: 0.0100 in/min

SHEARS 1K, 2K, & 3K NORMAL LOADS Undisturbed, Sat at 17.7 %

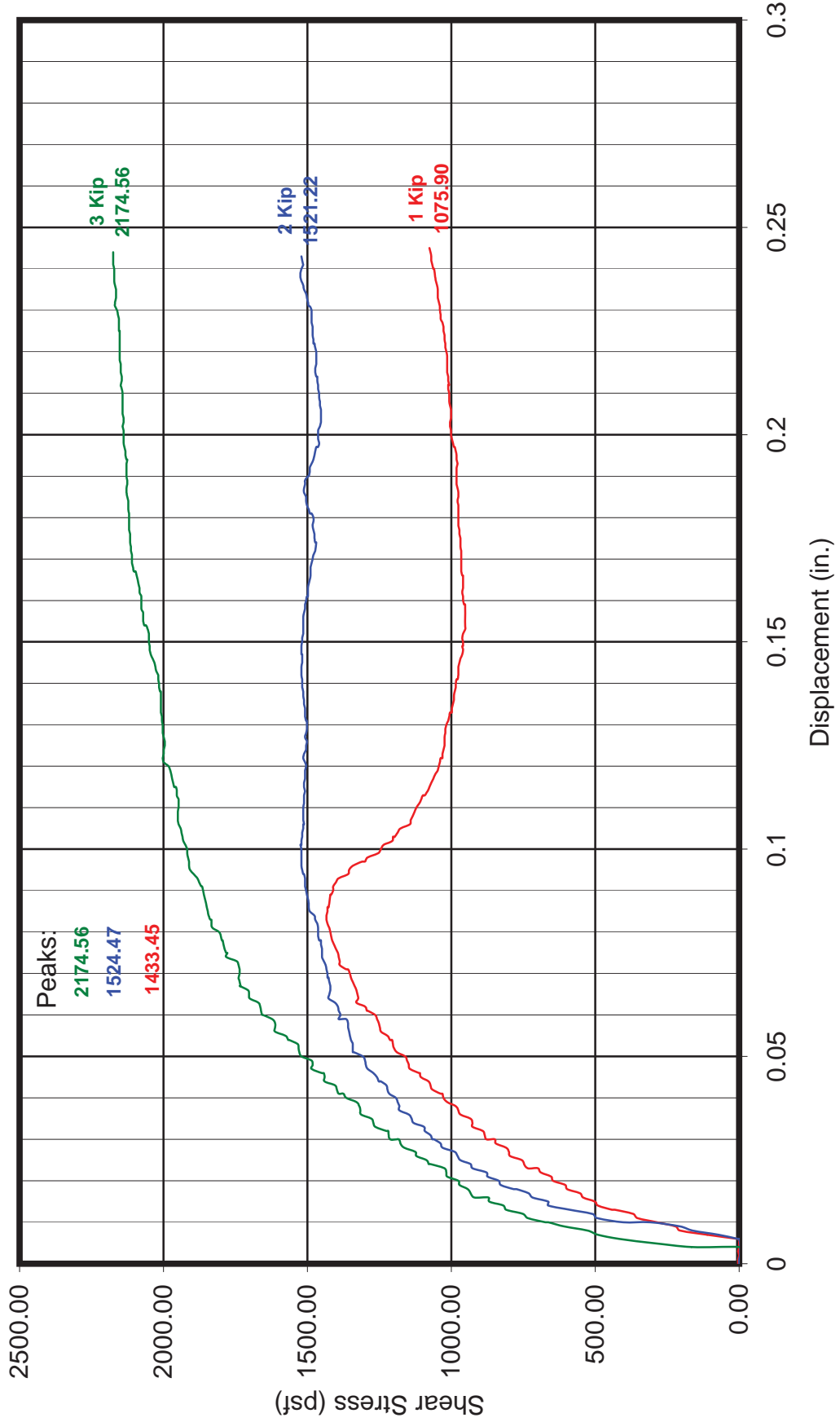

Excavation: B54 Depth: 30 ft

SHEAR TEST DIAGRAM

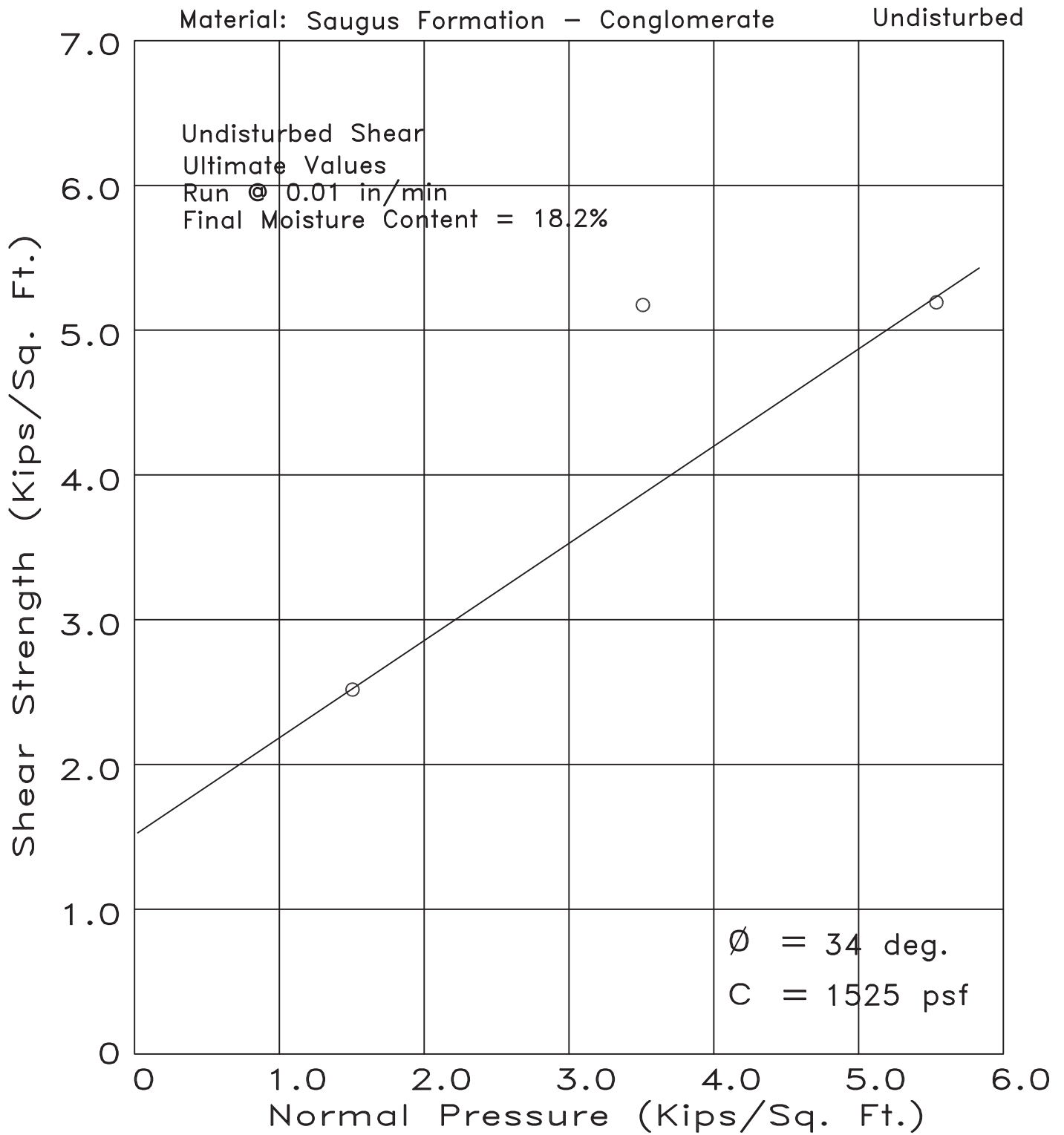

Project Tr. 060922 Skyline Ranch
Excavation B66
Depth 60 Feet



Geolabs - Westlake Village
GEOLOGY AND SOIL ENGINEERING

DATE _____ BY DS
SCALE _____ w.o. 8838

Excavation: B66 Depth: 60 ft Displacement Rate: 0.0100 in/min

SHEARS 1.5K, 3.5K, & 5.5K NORMAL LOADS Undisturbed, Sat at 18.2 %

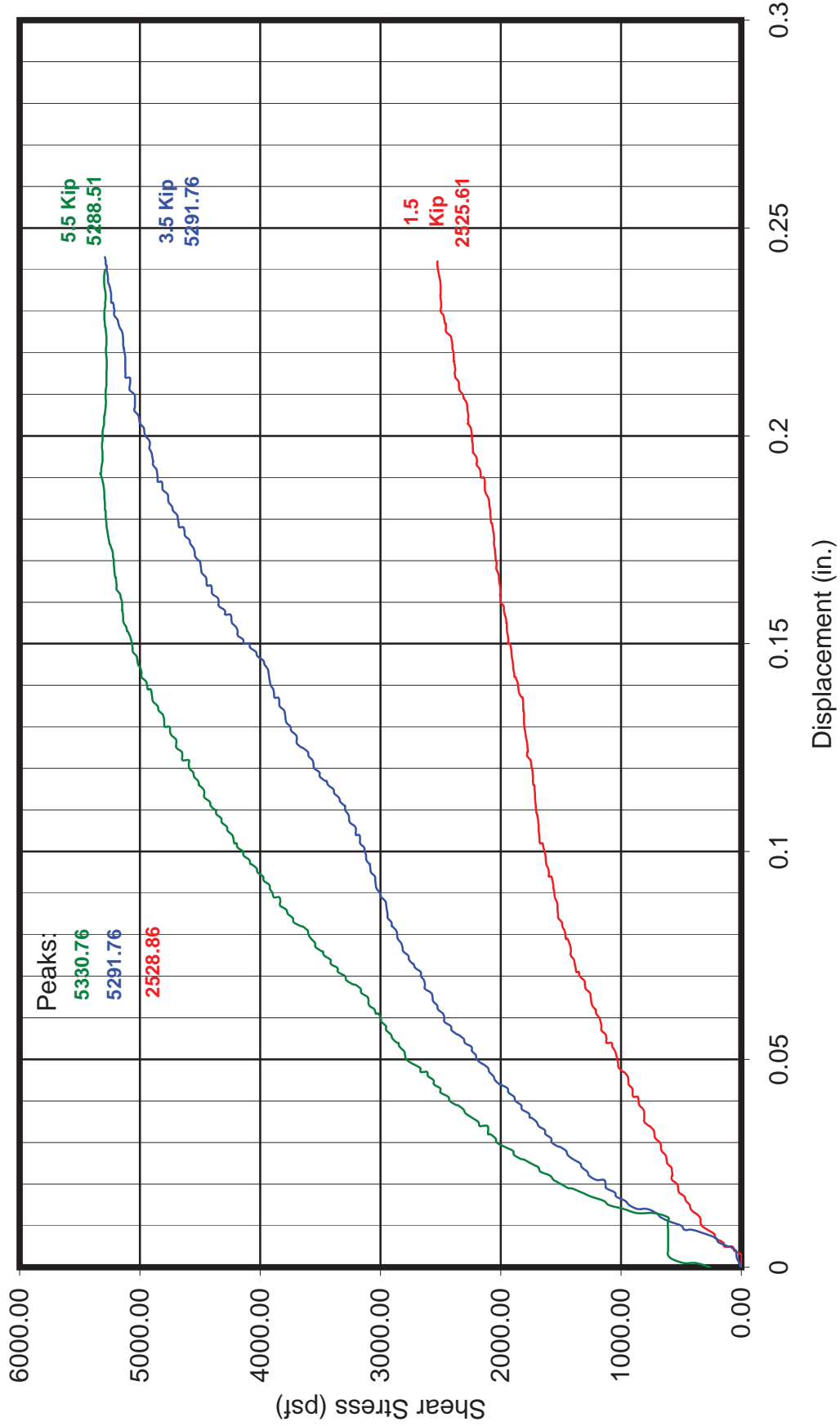

SHEAR TEST DIAGRAM

Material: Saugus Fm. - Sandy CONGLOMERATE

Undisturbed

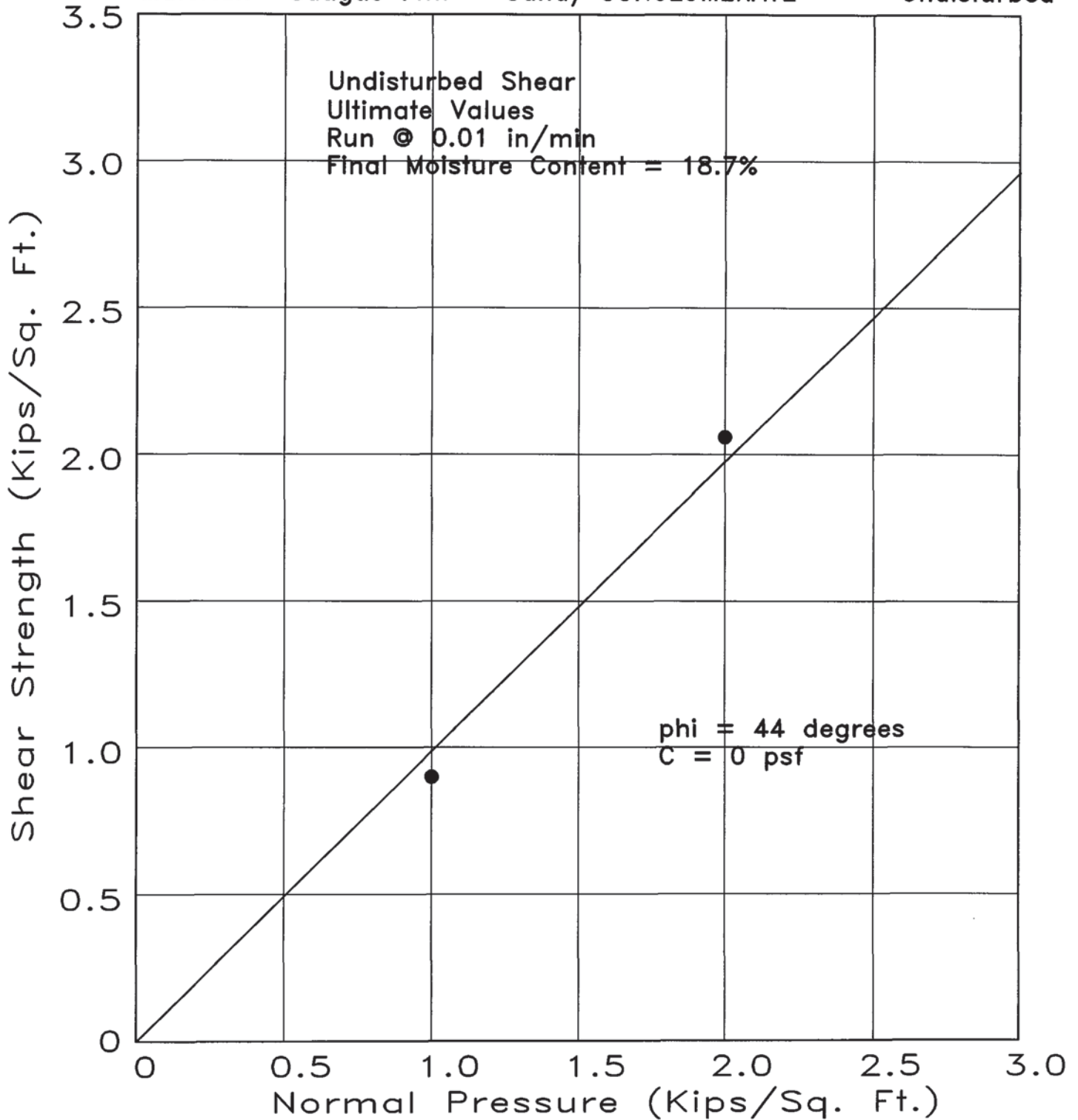

Project Tr. 060922 Skyline Ranch
Excavation B66
Depth 90 Feet



Geolabs - Westlake Village
GEOLOGY AND SOIL ENGINEERING

BY DS
DATE _____ W.O. 8838

Excavation: B66 Depth: 90 ft Displacement Rate: 0.0100 in/min

SHEARS 1K, 2K, & 3K NORMAL LOADS Undisturbed, Sat at 18.7 %

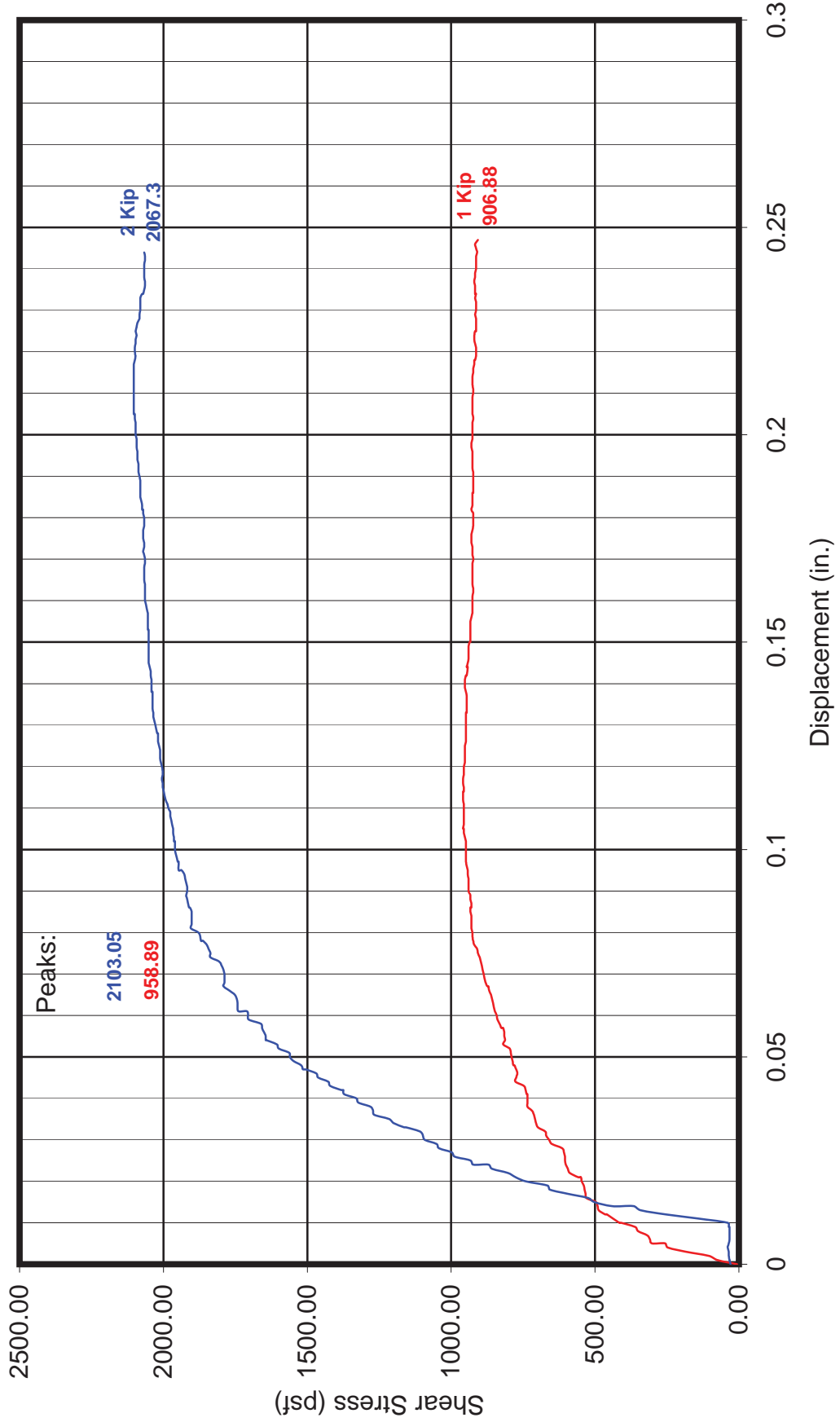

SHEAR TEST DIAGRAM

Material: Saugus Formation - Fine to coarse gr. SANDSTONE

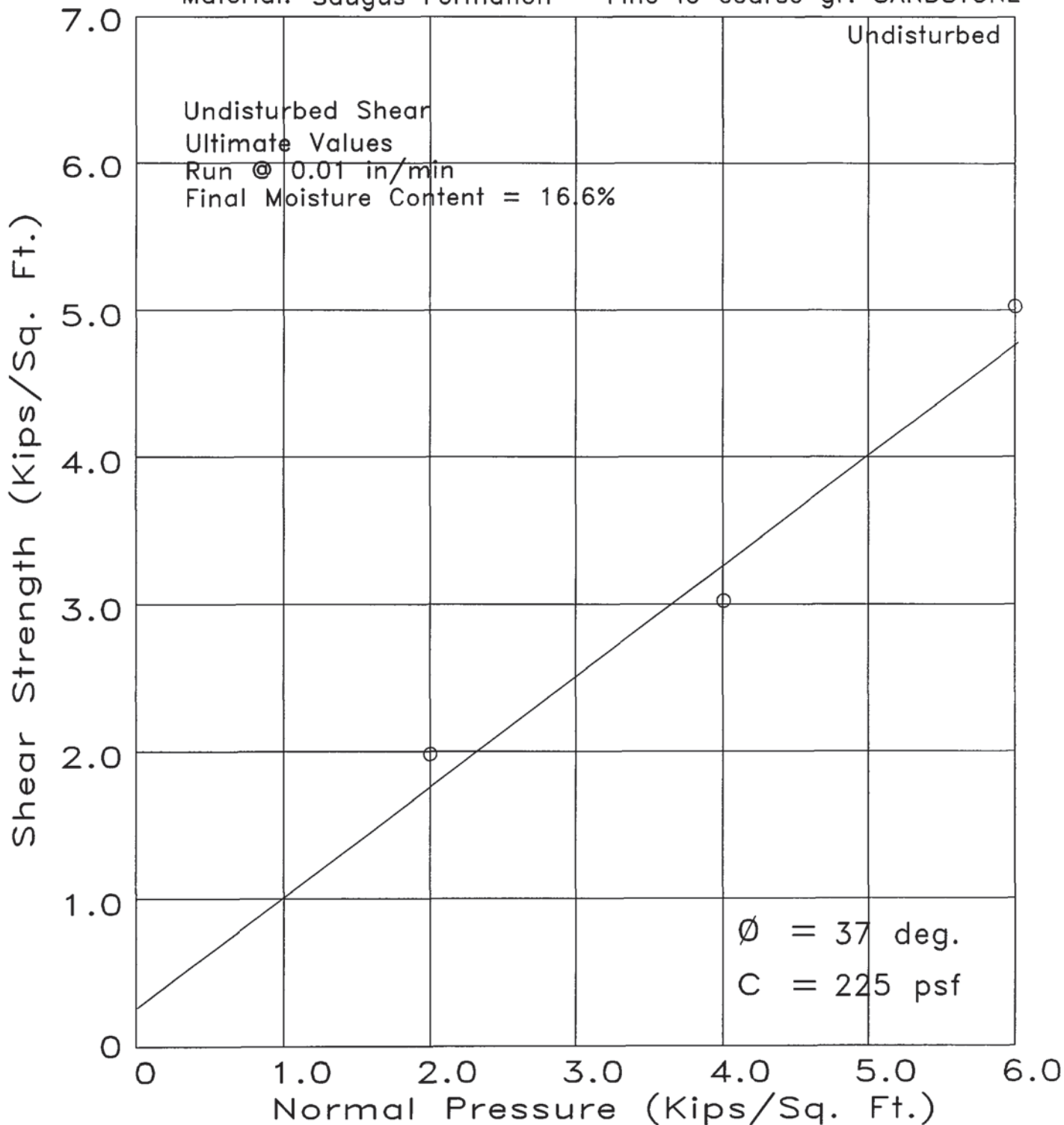

Project Tr. 060922 Skyline Ranch
Excavation B66
Depth 138 Feet



Geolabs - Westlake Village
GEOLOGY AND SOIL ENGINEERING

DATE _____ BY DS
SCALE _____ W.O. 8838

Excavation: B66 Depth: 138 ft Displacement Rate: 0.0100 in/min

SHEARS 2K, 4K, & 6K NORMAL LOADS Undisturbed, Sat at 16.6 %

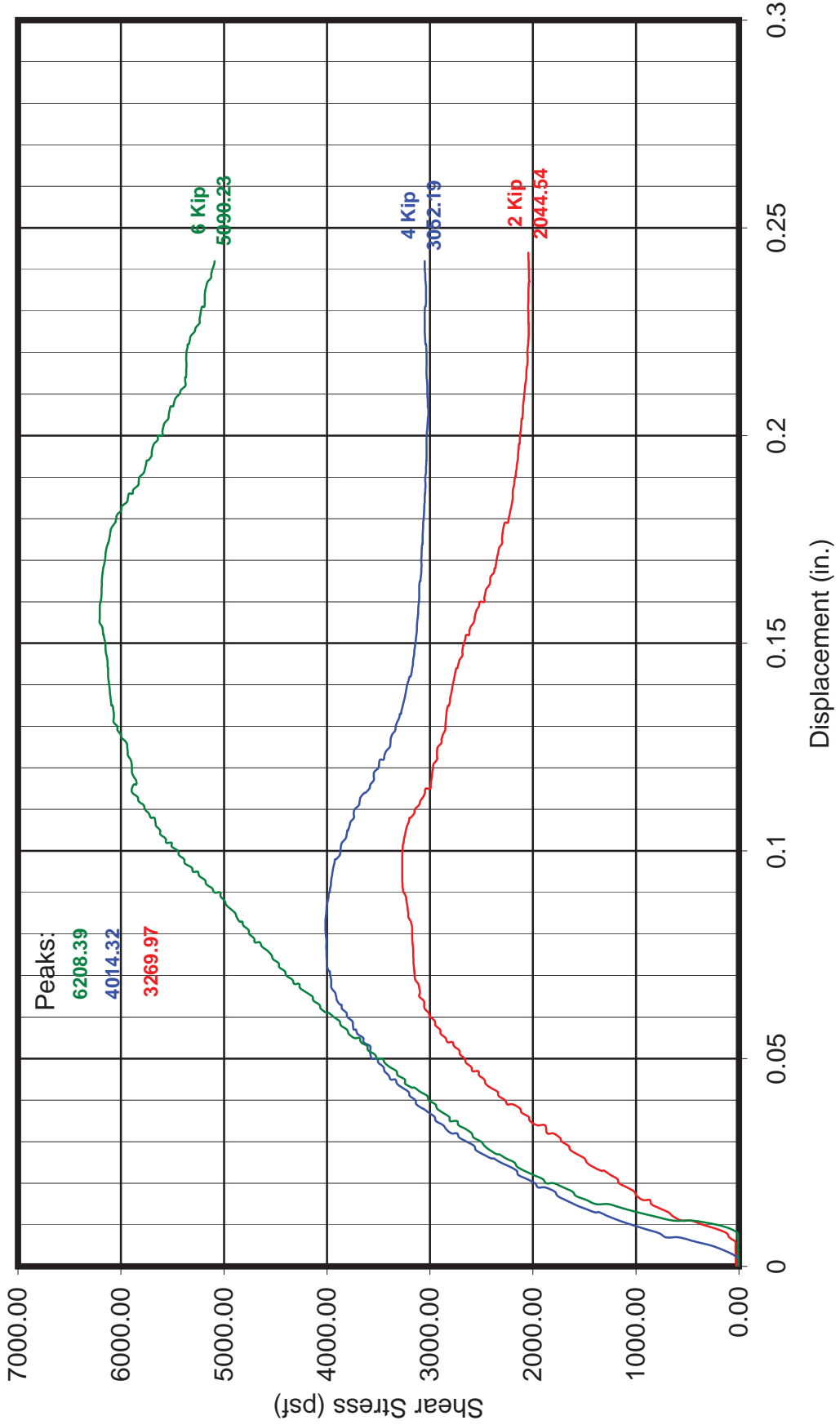

SHEAR TEST DIAGRAM

Material: Landslide Debris - Clayey SAND

Undisturbed

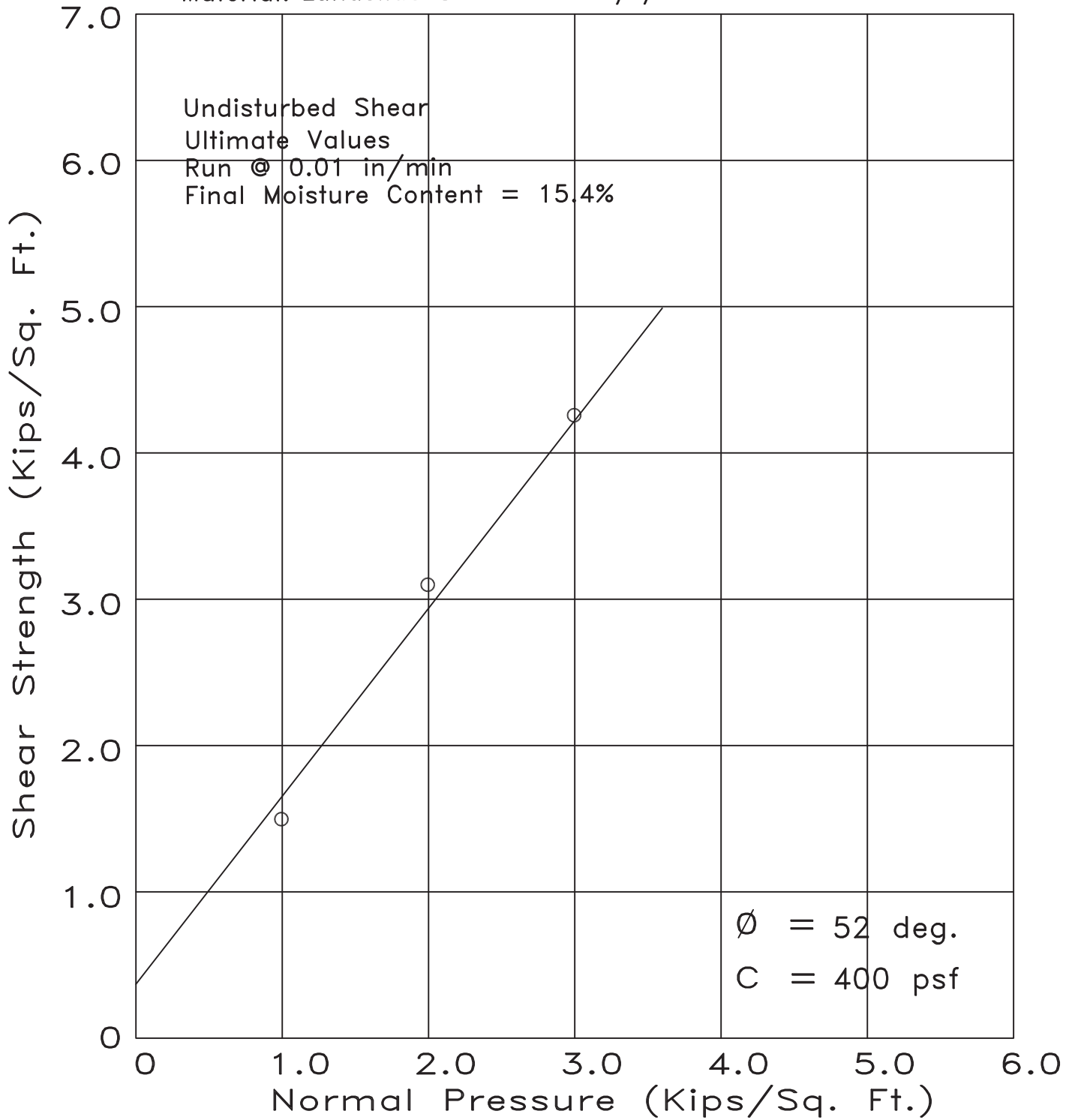

Project Tr. 060922 Skyline Ranch
Excavation B89
Depth 31 Feet



Geolabs - Westlake Village
GEOLOGY AND SOIL ENGINEERING

DATE _____ BY DS
SCALE _____ w.o. 8838

Excavation: B89

Depth: 31 ft

Sample Description: Tan clayey medium to coarse sand

Displacement Rate: 0.0100 in/min

SHEARS 1K, 2K, & 3K NORMAL LOADS Undisturbed, Sat at 15.40%

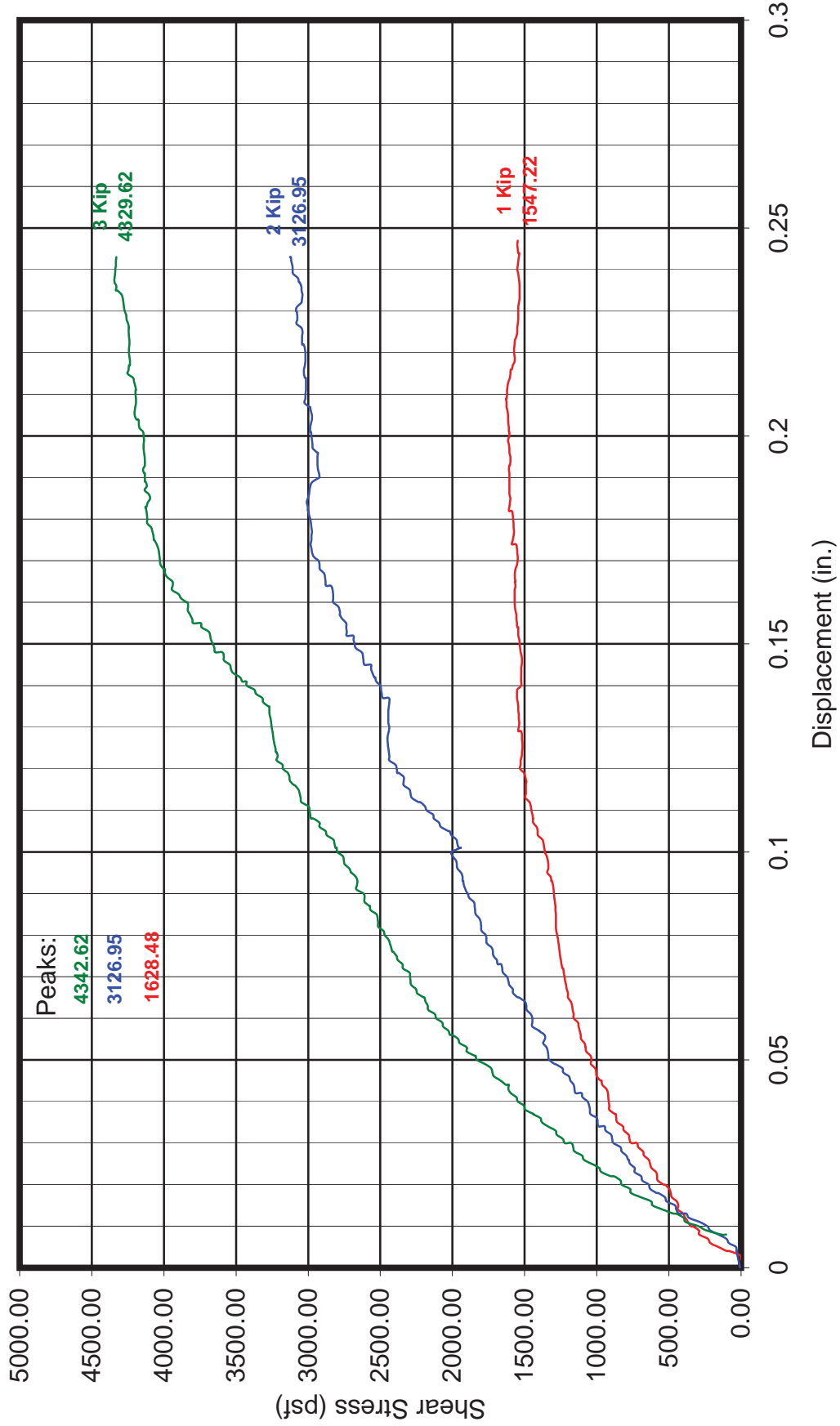

SHEAR TEST DIAGRAM

Material: **Landslide Debris - Sand** **Undisturbed**

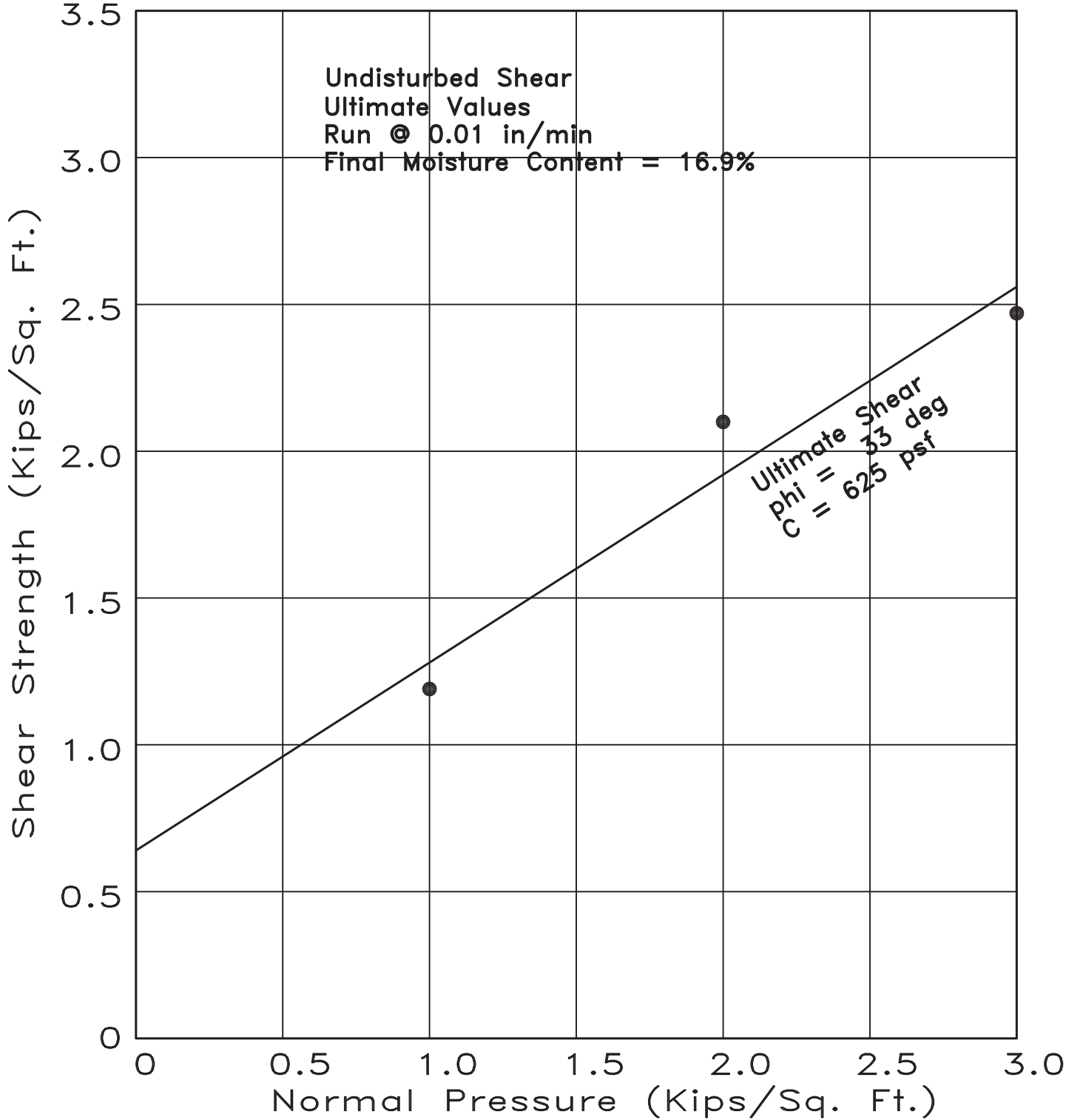

Project Tr. 060922 Skyline Ranch
 Excavation B90
 Depth 20 Feet



Geolabs - Westlake Village
GEOLOGY AND SOIL ENGINEERING

BY DS
 DATE _____ W.O. 8838

Excavation: B90 Depth: 20 ft Sample Description: Light brown silty fine to medium sandy clay Displacement Rate: 0.0100 in/min

SHEARS 1K, 2K, & 3K NORMAL LOADS Undisturbed, Sat at 16.90%

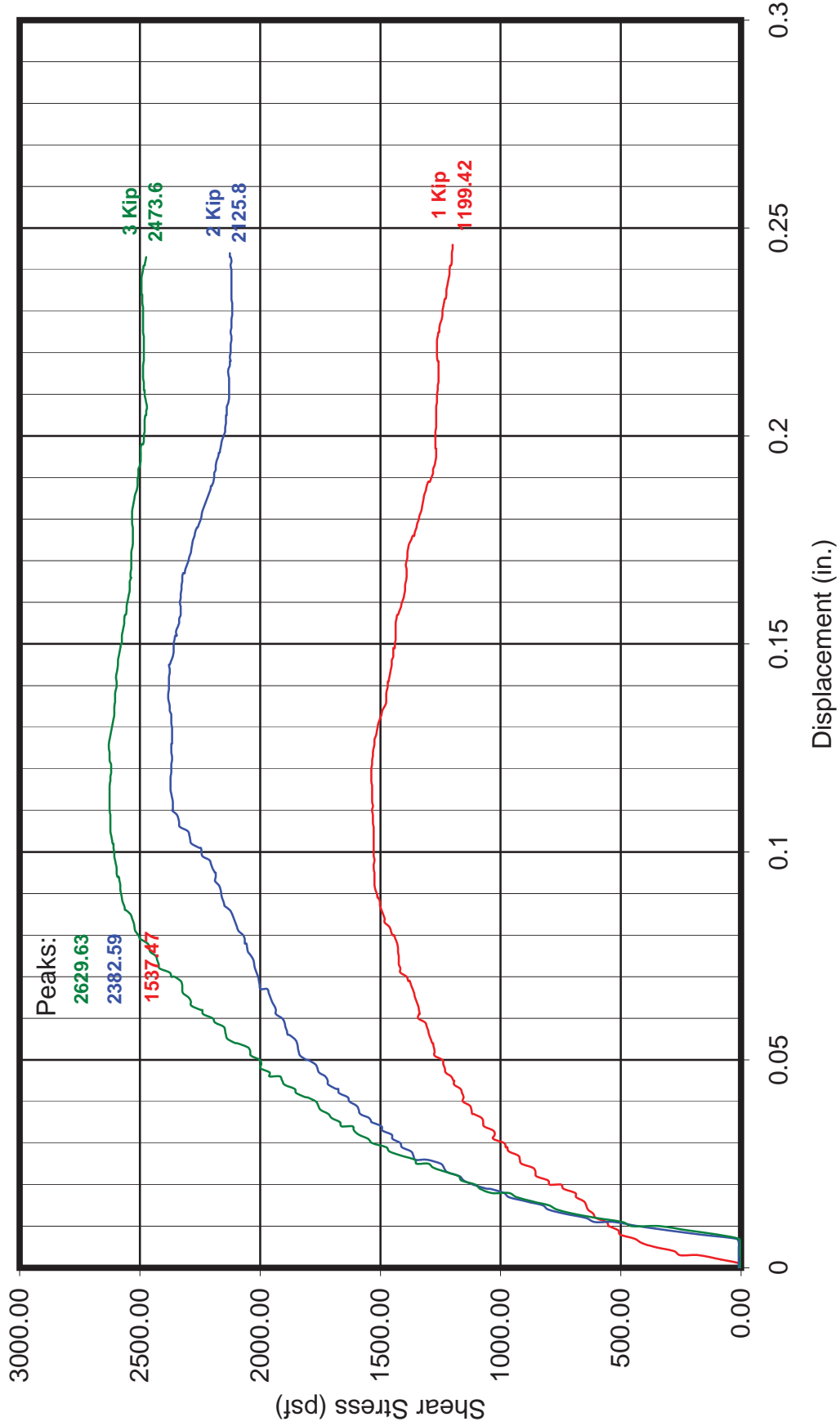

SHEAR TEST DIAGRAM

Material: Colluvium

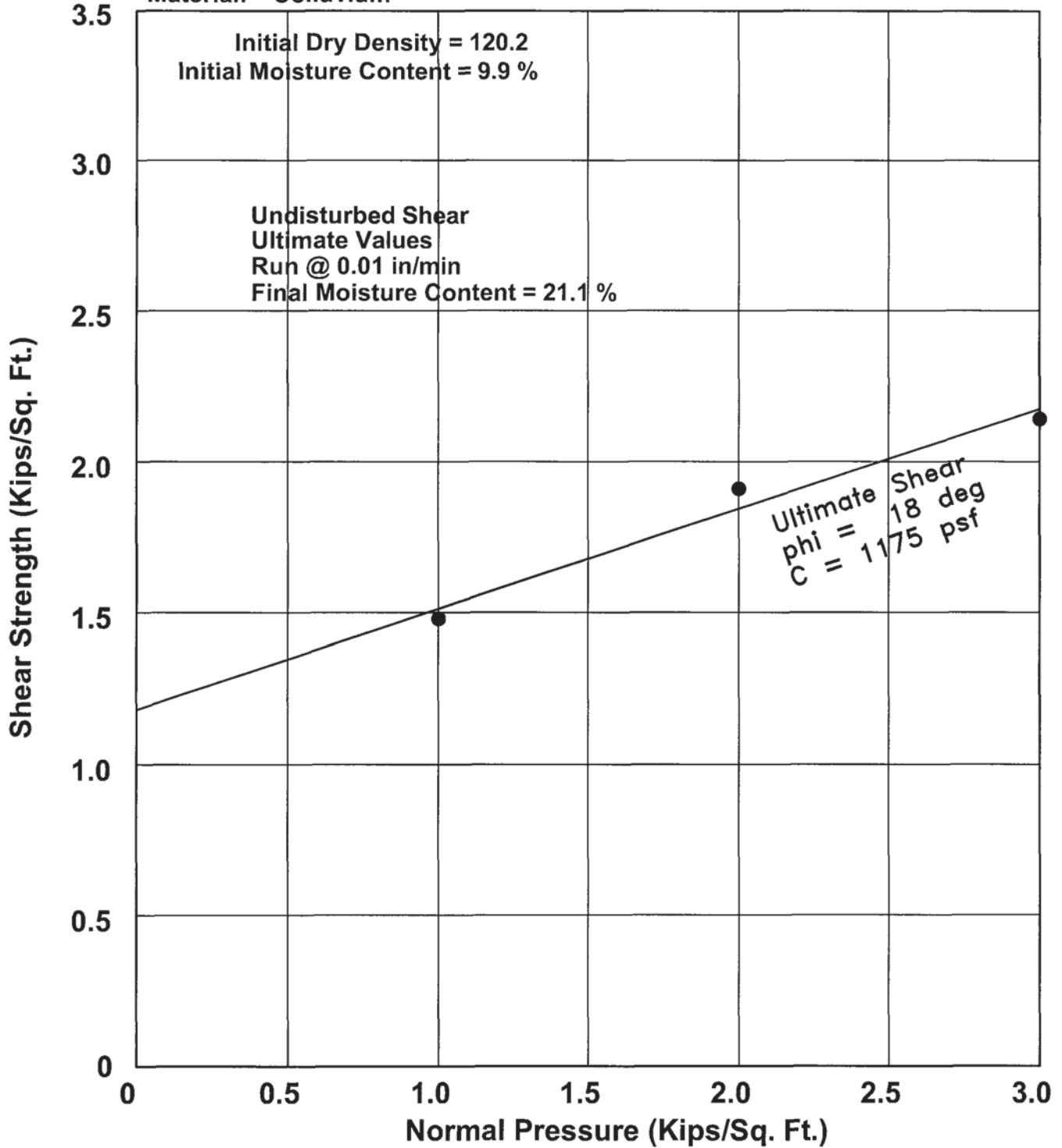

Project Pardee Homes - Skyline Ranch
Excavation TP214
Depth 1.5 feet



Geolabs - Westlake Village
GEOLOGY AND SOIL ENGINEERING

DATE 07/20/07 BY Mario Linares
W.O. 8838

PLATE Stp214

Excavation: TP214 Depth: 1 ft Displacement Rate: 0.0100 in/min

SHEARS 1K, 2K, & 3K NORMAL LOADS Undisturbed, Sat at 21.10%

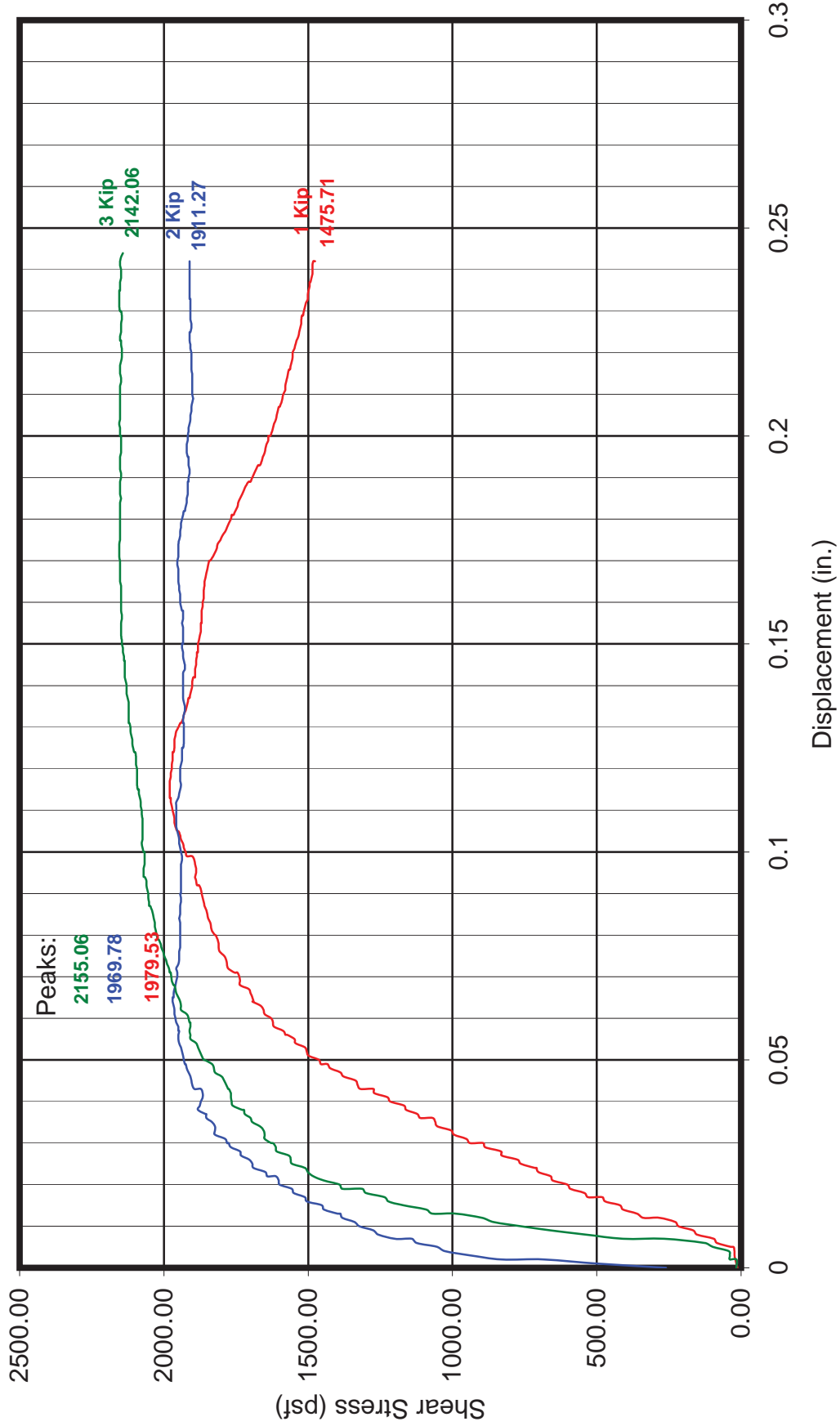

Excavation: TP214 Depth: 1 ft

SHEAR TEST DIAGRAM

Material: Colluvium

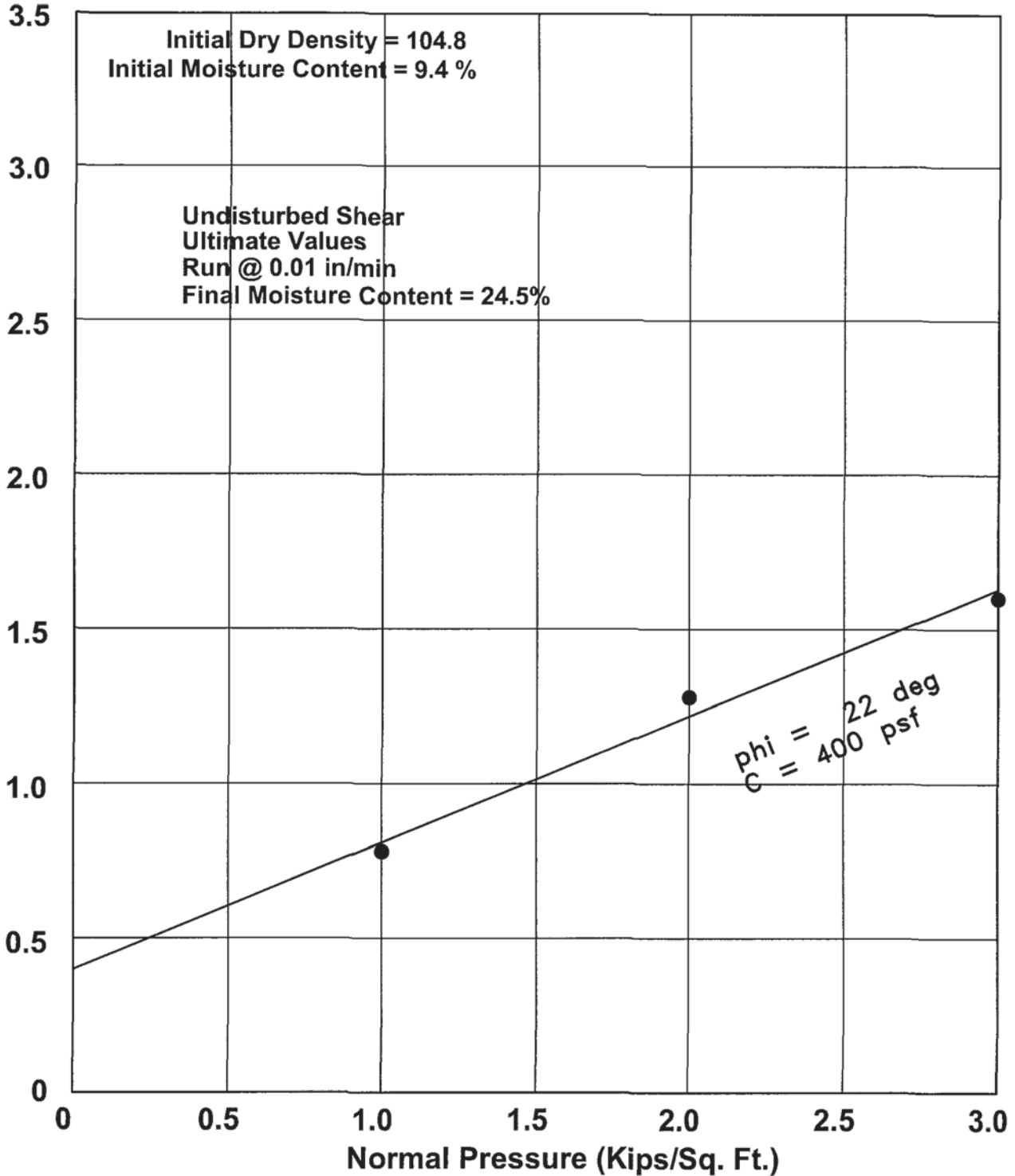

Project Pardee Homes - Skyline Ranch
Excavation TP216
Depth 1.5 feet



Geolabs - Westlake Village
GEOLOGY AND SOIL ENGINEERING

BY Mario Linares
DATE 07/20/07 W.O. 8838

PLATE **Stp216**

Excavation: TP216 Depth: 1 1/2 ft Displacement Rate: 0.0100 in/min

SHEARS 1K, 2K, & 3K NORMAL LOADS Undisturbed, Sat at 24.50%

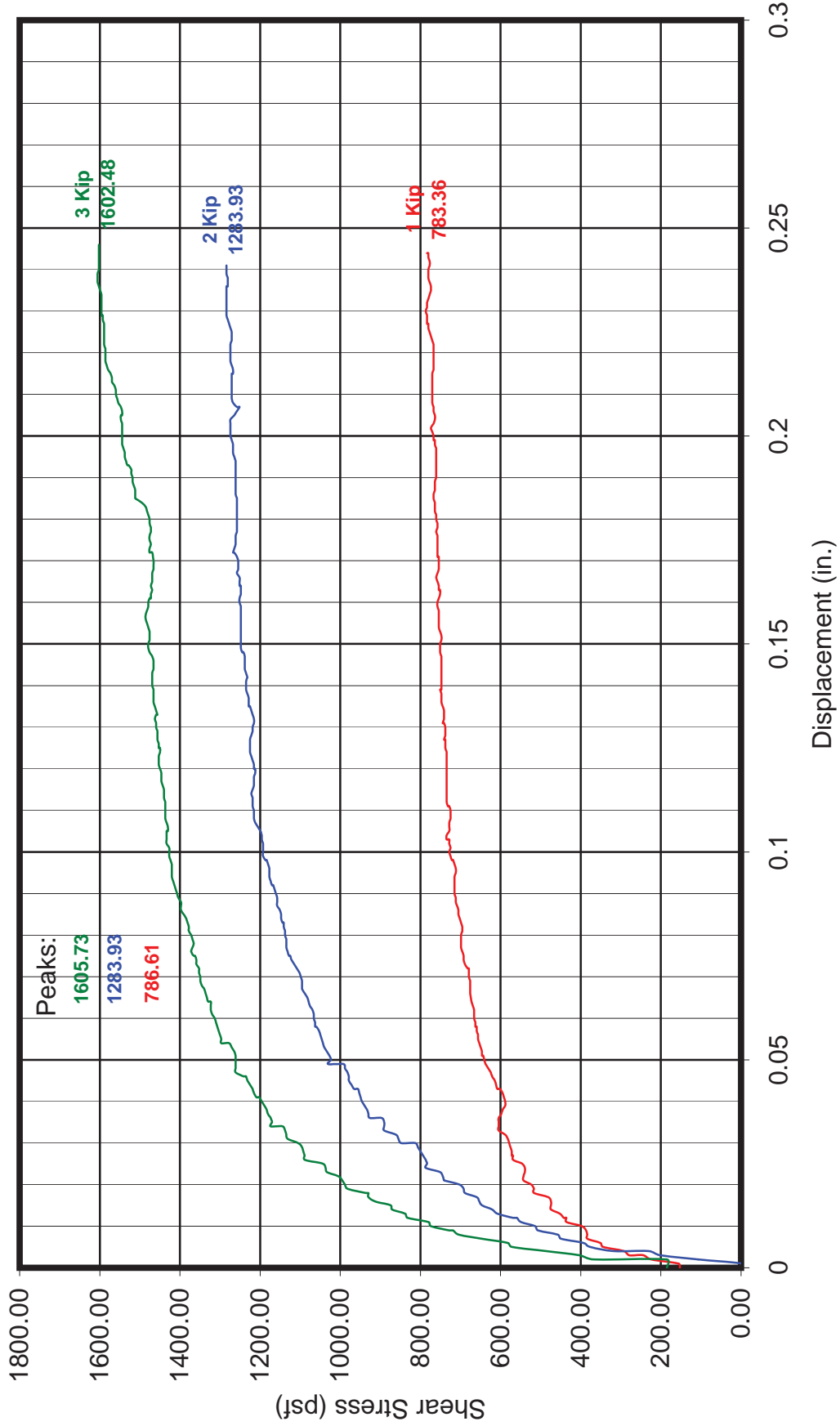

SHEAR TEST DIAGRAM

Material: Colluvium

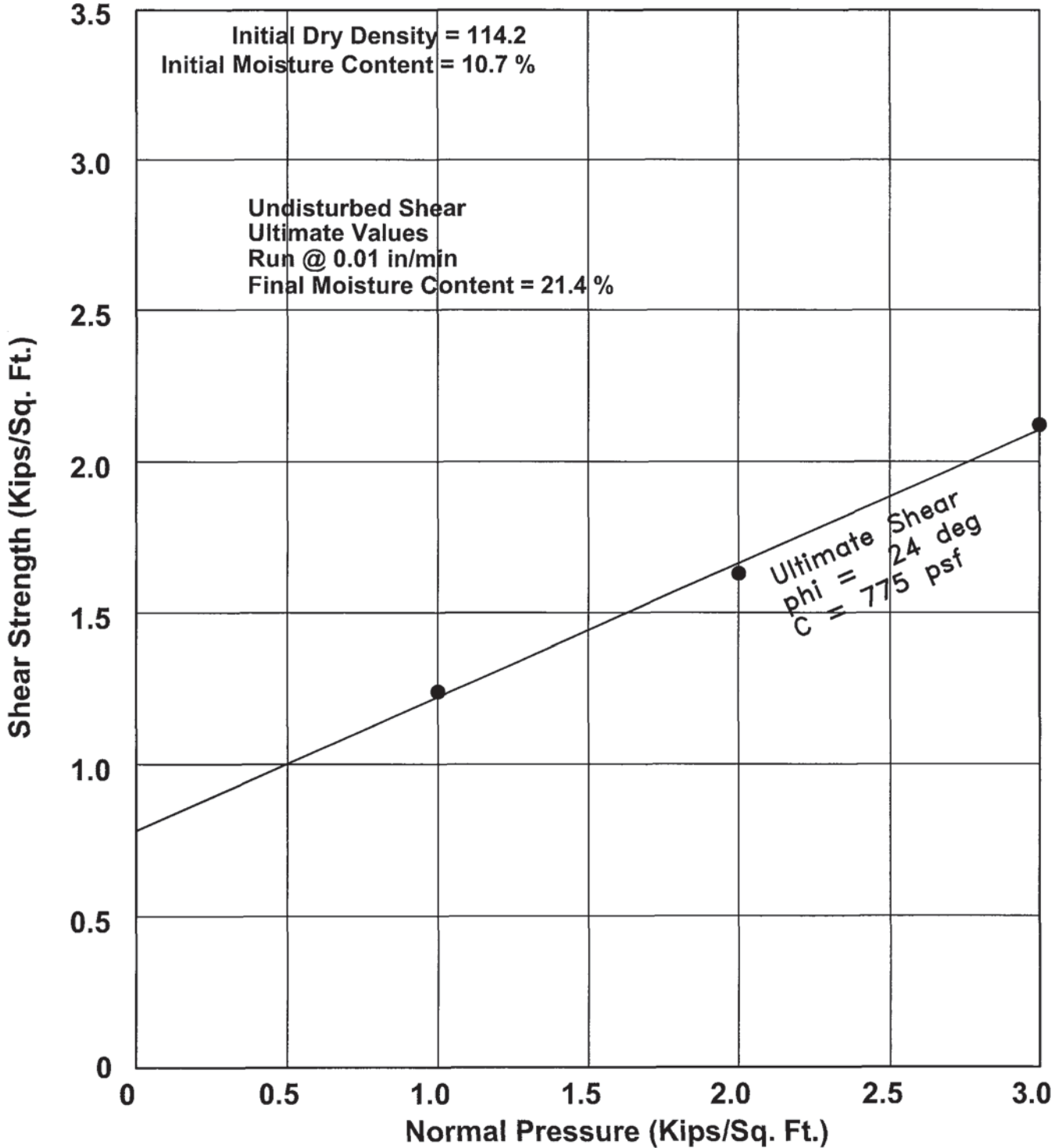

Project Pardee Homes - Skyline Ranch
Excavation TP219
Depth 2 feet



Geolabs - Westlake Village
GEOLOGY AND SOIL ENGINEERING

DATE 07/20/07 BY Mario Linares
W.O. 8838

PLATE Stp219

Excavation: TP219 Depth: 2 ft Displacement Rate: 0.0100 in/min

SHEARS 1K, 2K, & 3K NORMAL LOADS Undisturbed, Sat at 21.40%

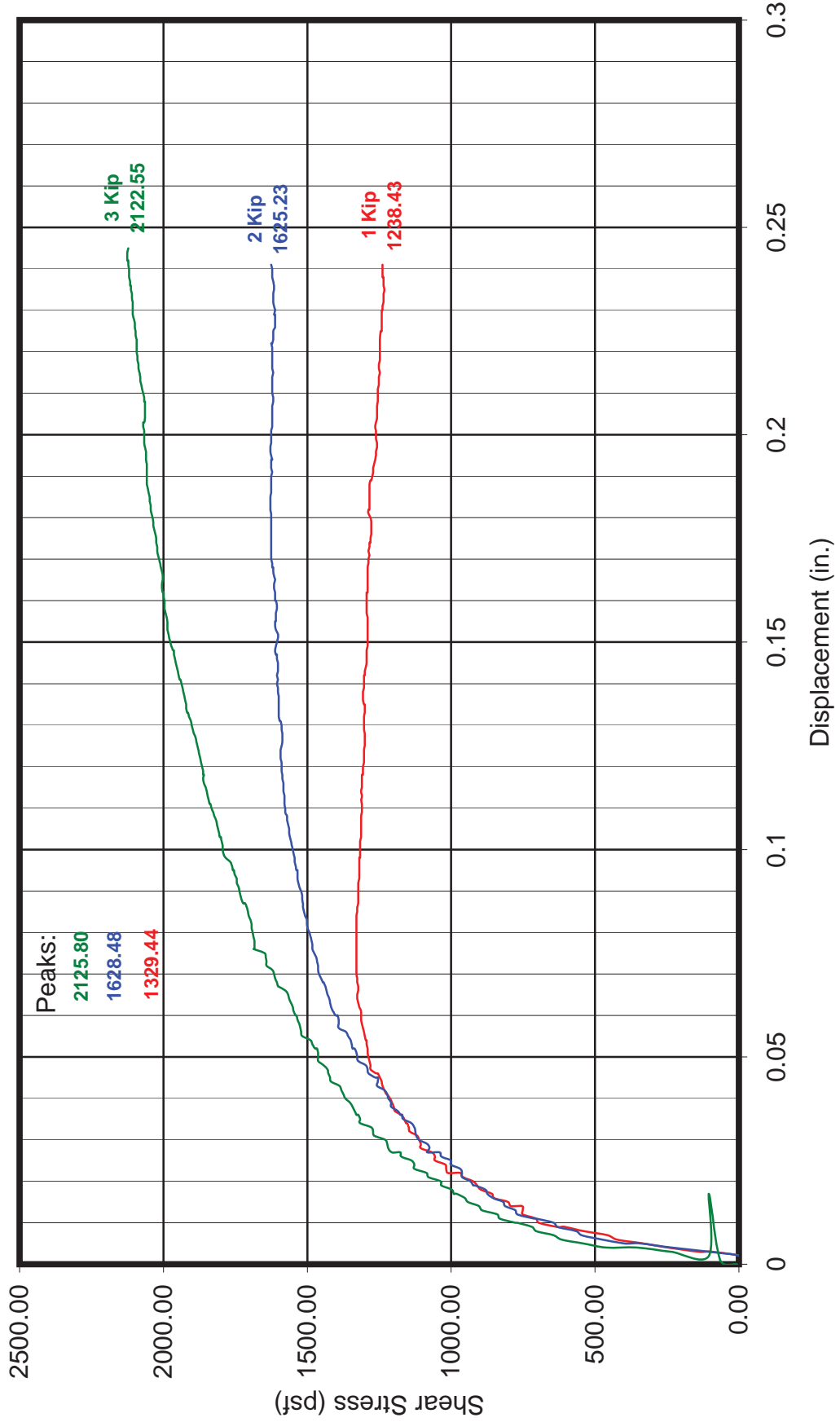

SHEAR TEST DIAGRAM

Material: Saugus Fm. - Sandy SILTSTONE (Remolded)

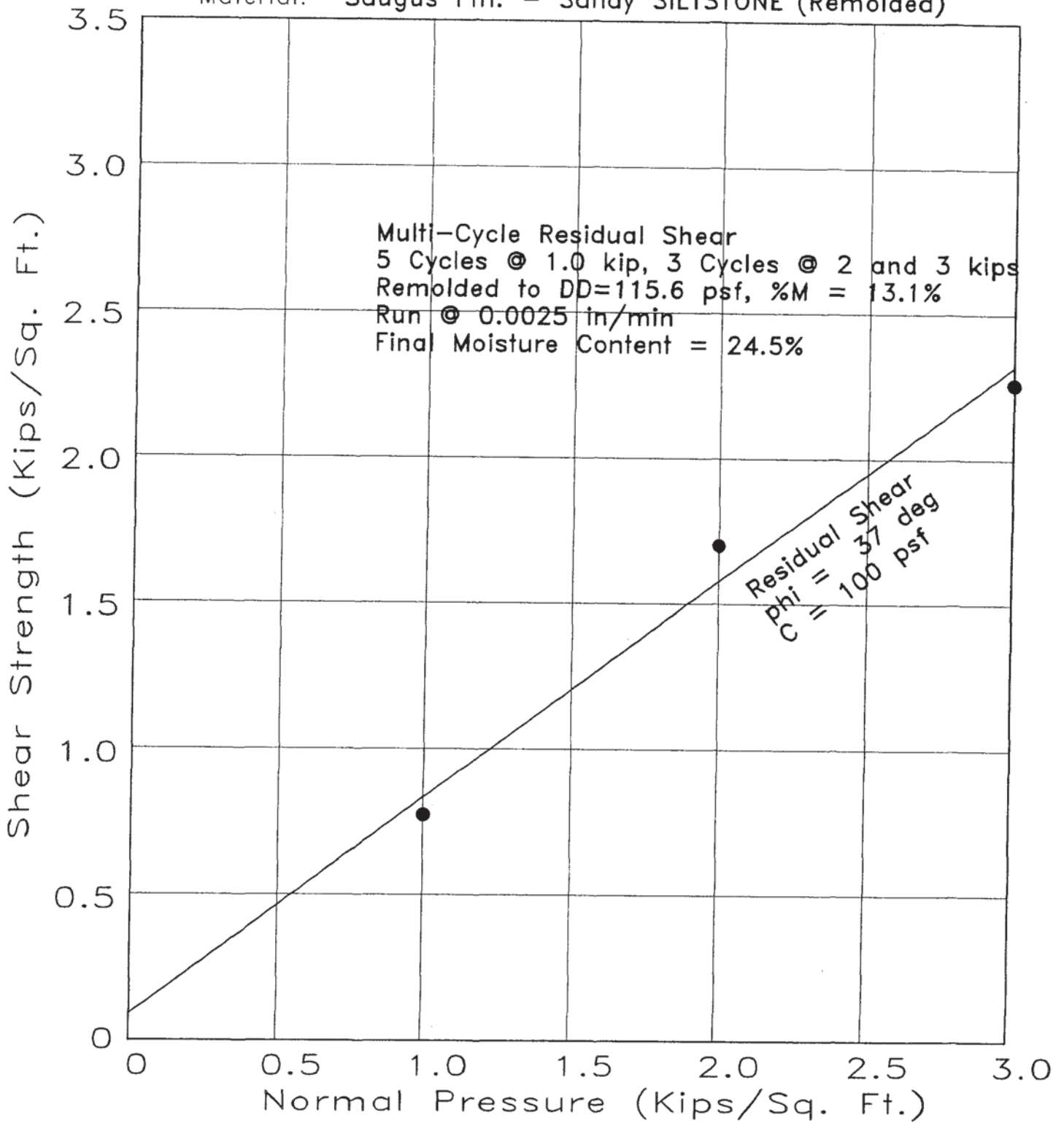

Project Skyline Ranch
 Excavation Boring 3
 Depth 21 Feet



Geolabs - Westlake Village
 GEOLOGY AND SOIL ENGINEERING

BY DS
 W.O. 8838

DATE _____

Excavation: B3 at 21 ft

W.O.: 8838

Displacement Rate: 0.0025 in/min

SHEARS 1K, 2K, & 3K NORMAL LOADS Remolded, sat at 24.5%

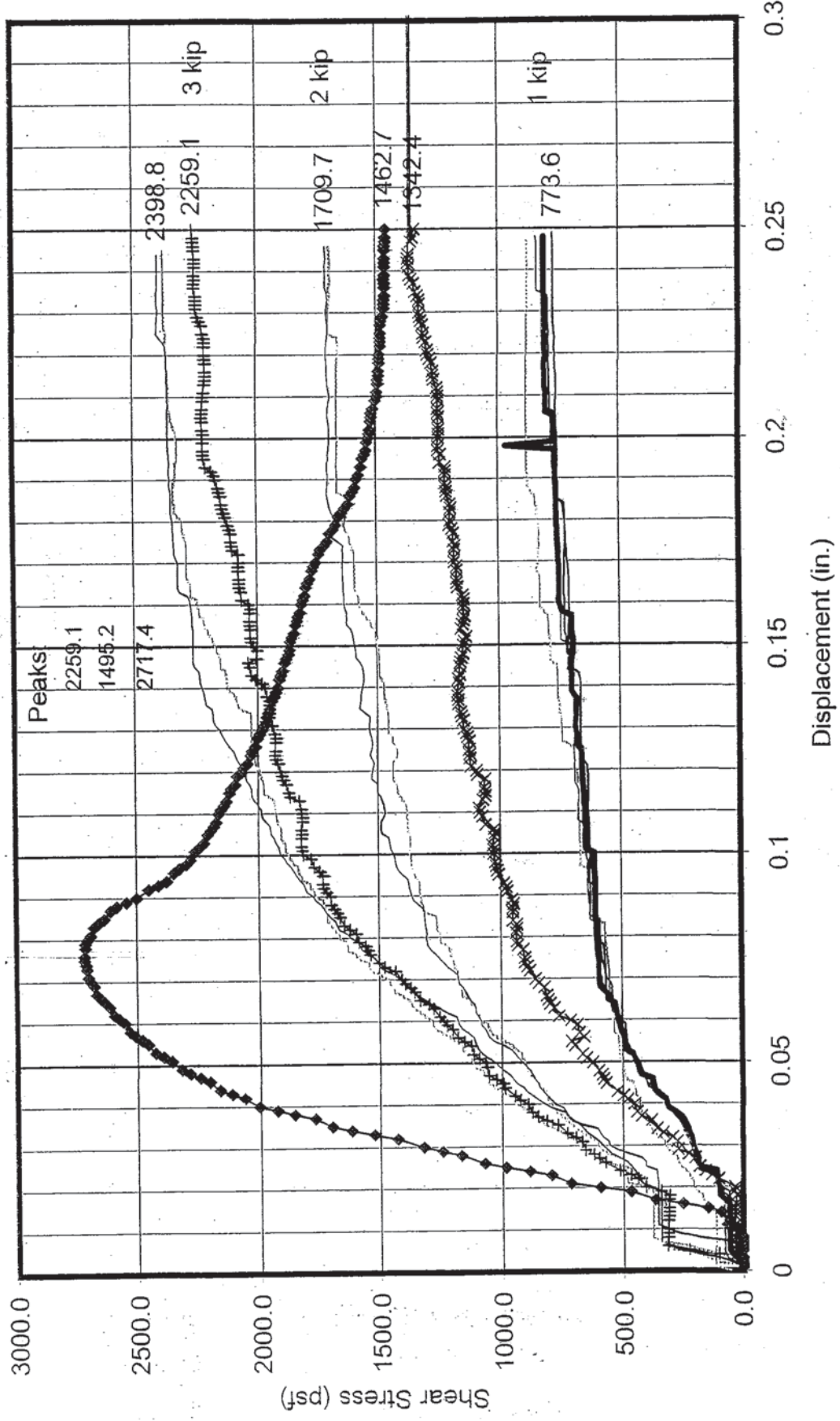

SHEAR TEST DIAGRAM

Material: Saugus Fm. - Red CLAYSTONE Undisturbed

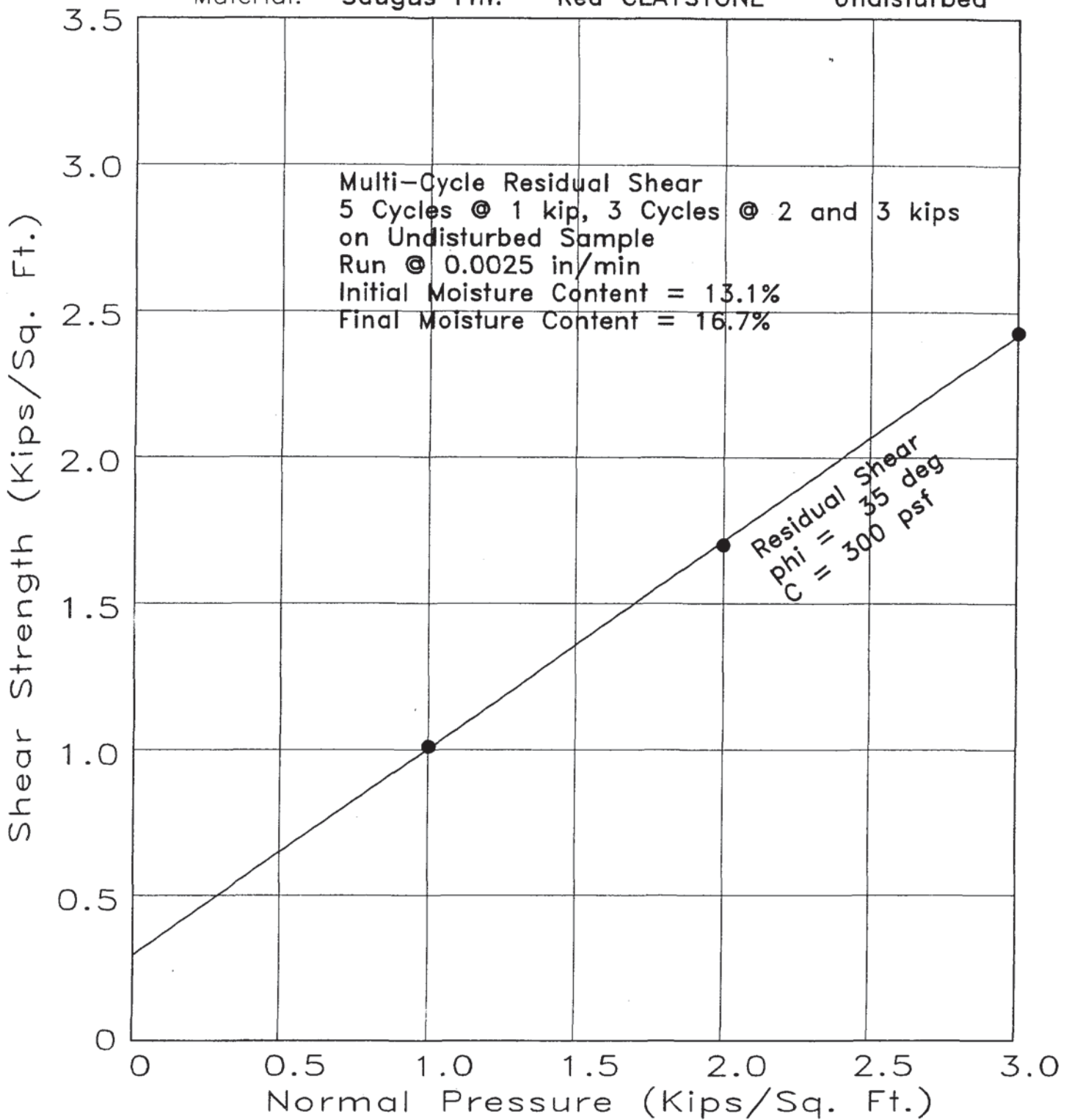

Project Skyline Ranch
Excavation B16
Depth 60 Feet



Geolabs - Westlake Village
GEOLOGY AND SOIL ENGINEERING

BY DS
DATE _____ W.O. 8838

Accumulative Shear Information

W.O.: 8838

Excavation: B16 at 60 ft
UN71 STURBCT

Displacement Rate: 0.0025 in/min

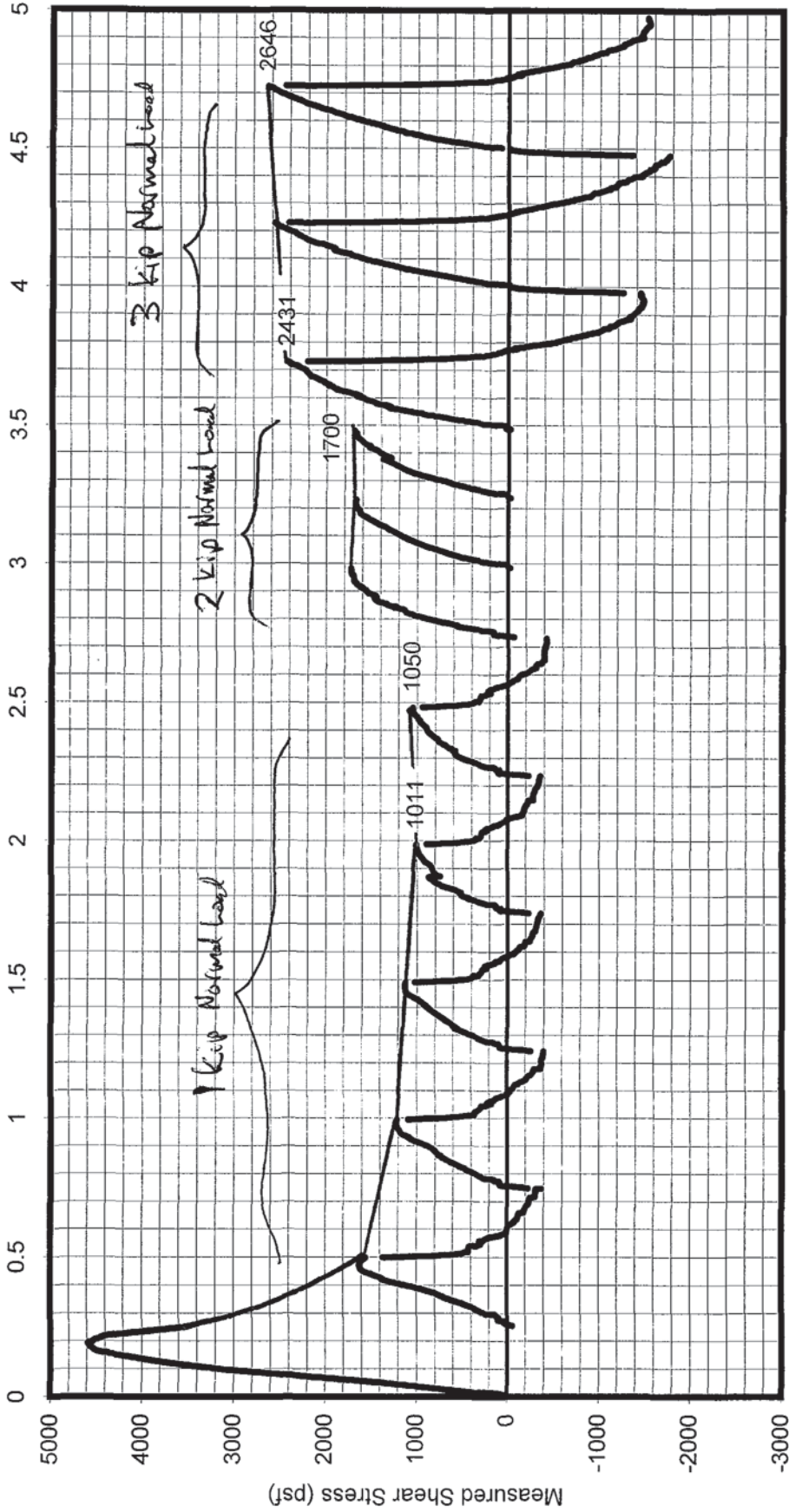

Note: After Initial Cycle, shear machine displaces sample 0.25 inches in the initial direction, then reverses and returns sample to the original position to begin the next cycle.

Shear Ring calibrated for initial direction only

SHEAR TEST DIAGRAM

Material: Saugus Formation - Sheared Claystone Remolded

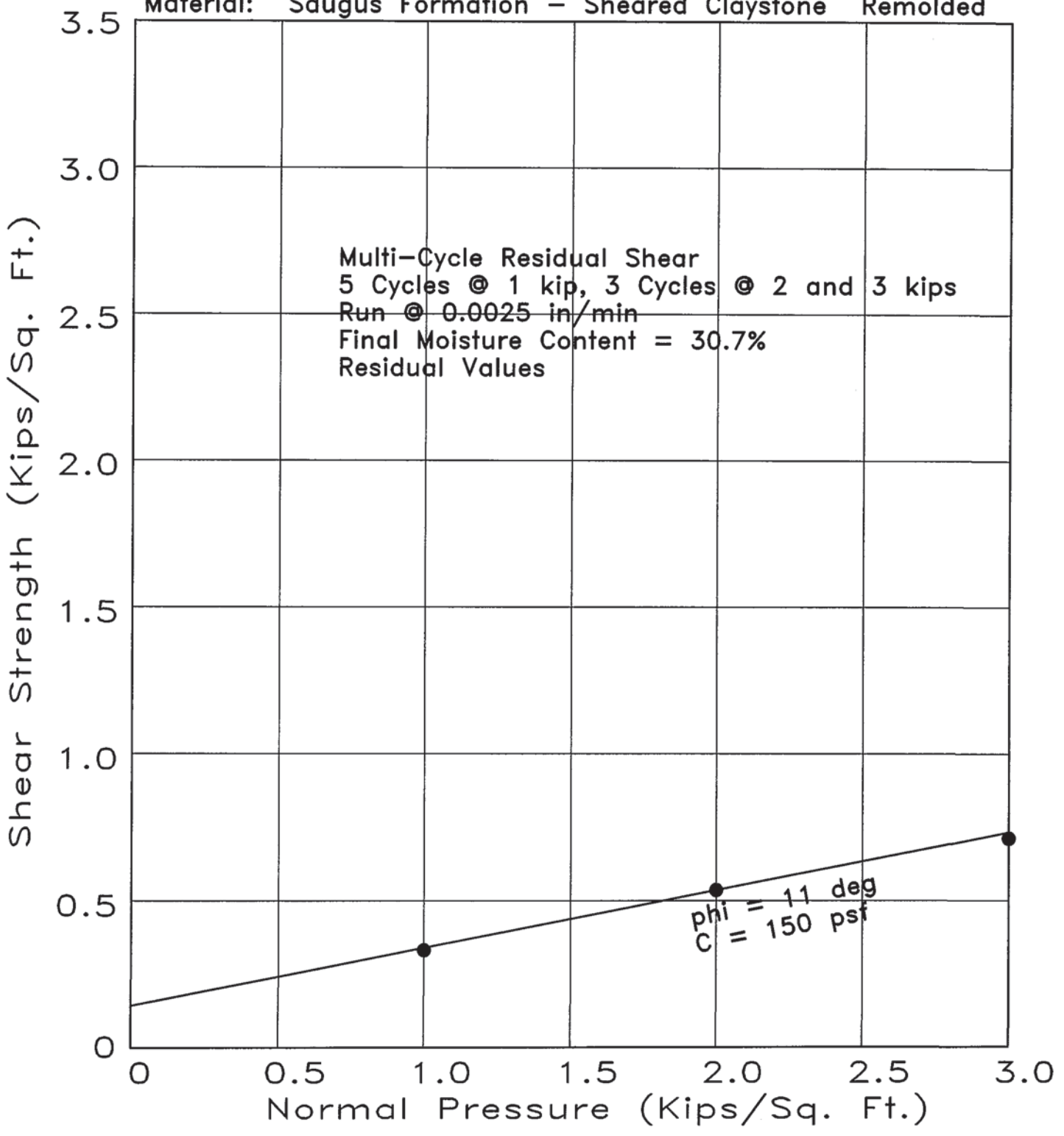

Project TTM 60922, Skyline Ranch
 Excavation Boring 17
 Depth 98 Feet



Geolabs - Westlake Village
 GEOLOGY AND SOIL ENGINEERING

BY DS
 DATE _____ W.O. 8838

Excavation: B17 at 98ft
W.O.: 8838

Accumulative Shear Information

Remolded to 108.3pcf at 21.1%, sat at 30.7%

Displacement Rate: 0.0025 in/min

Total Displacement (in)

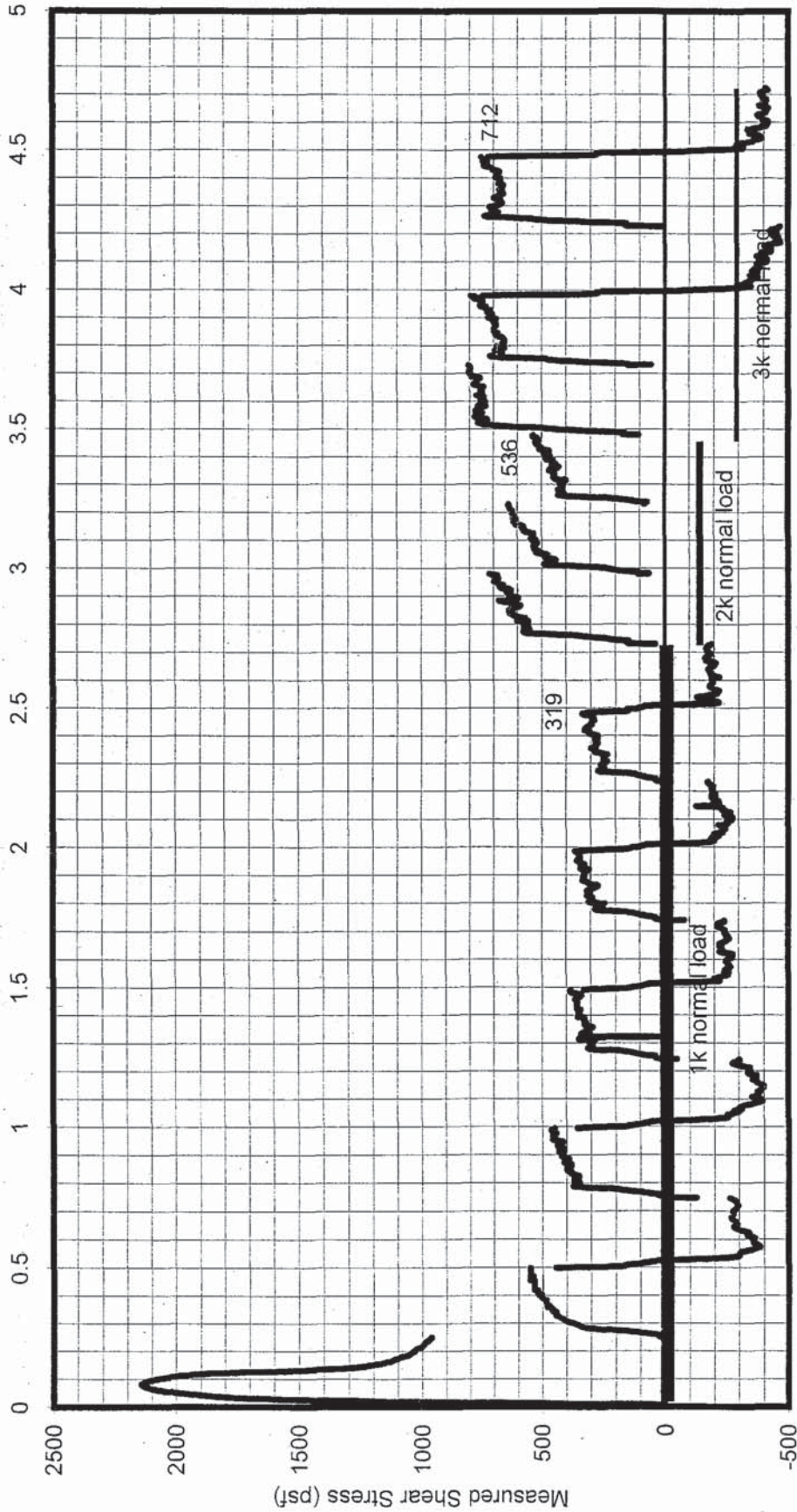

Note: After Initial Cycle, shear machine displaces sample 0.25 inches in the initial direction, then reverses and returns sample to the original position to begin the next cycle.

Shear Ring calibrated for initial direction only

SHEAR TEST DIAGRAM

Material: Saugus Fm. - Med. brn CLAYSTONE Remolded

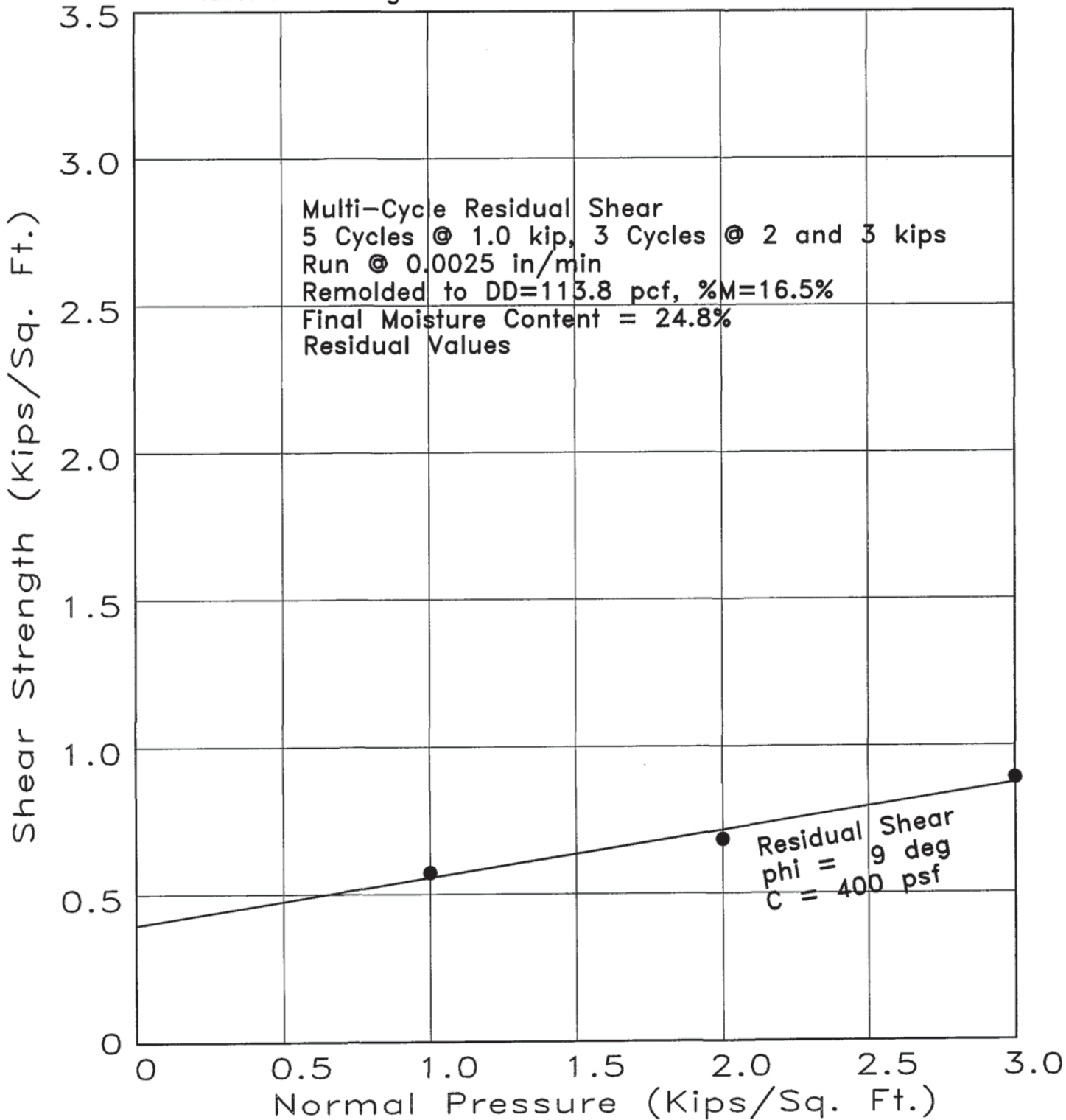

Project TTM 060922
 Excavation Boring 21
 Depth 48.5 Feet



Geolabs - Westlake Village
 GEOLOGY AND SOIL ENGINEERING

BY _____
 DATE _____ W.O. 8838

Accumulative Shear Information

W.O.: 8838

Excavation: B21 at 40.5' ft

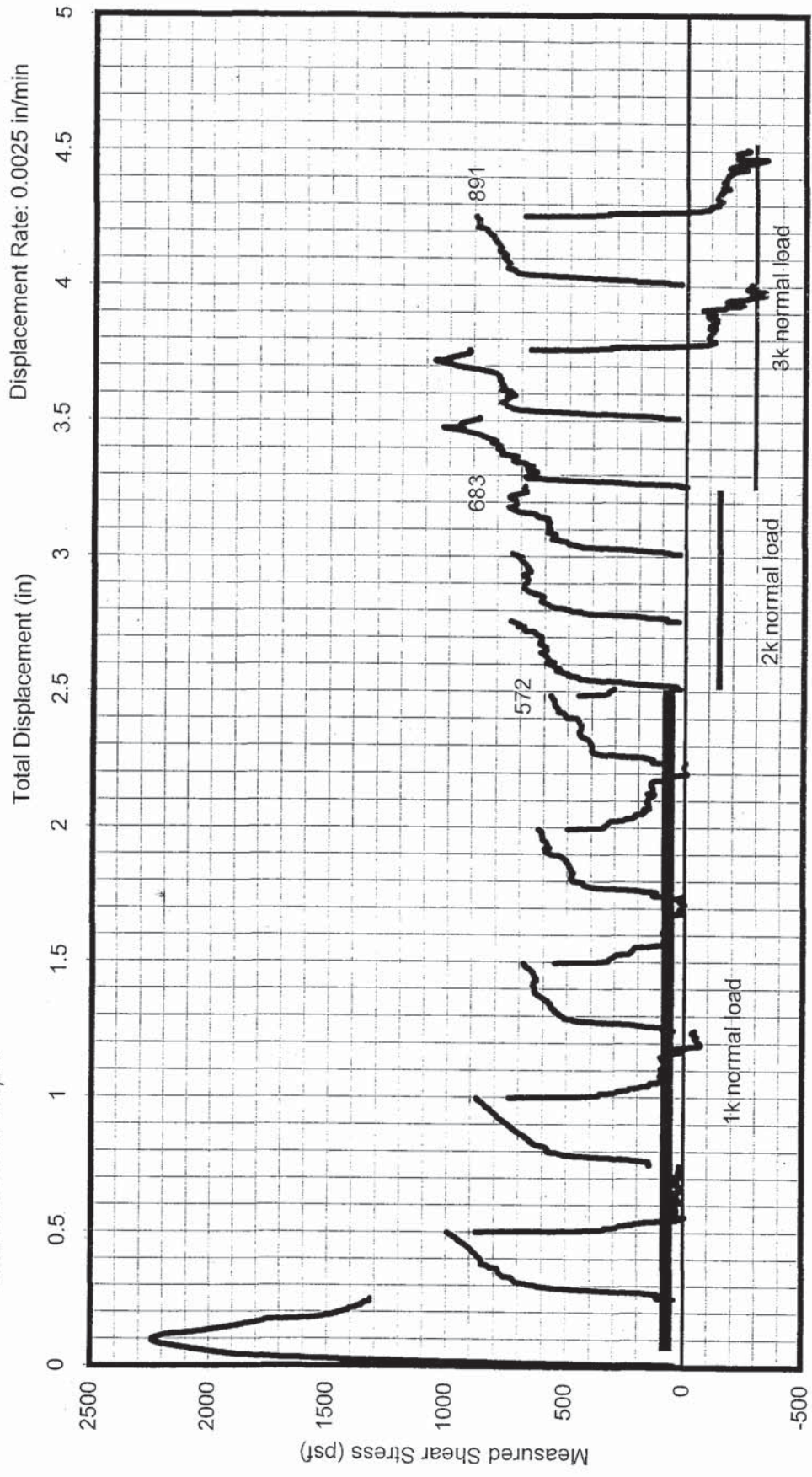

Note: After Initial Cycle, shear machine displaces sample 0.25 inches in the initial direction, then reverses and returns sample to the original position to begin the next cycle.

Shear Ring calibrated for initial direction only

SHEAR TEST DIAGRAM

Material: Saugus Formation-CLAYSTONE Presoaked, Undisturbed

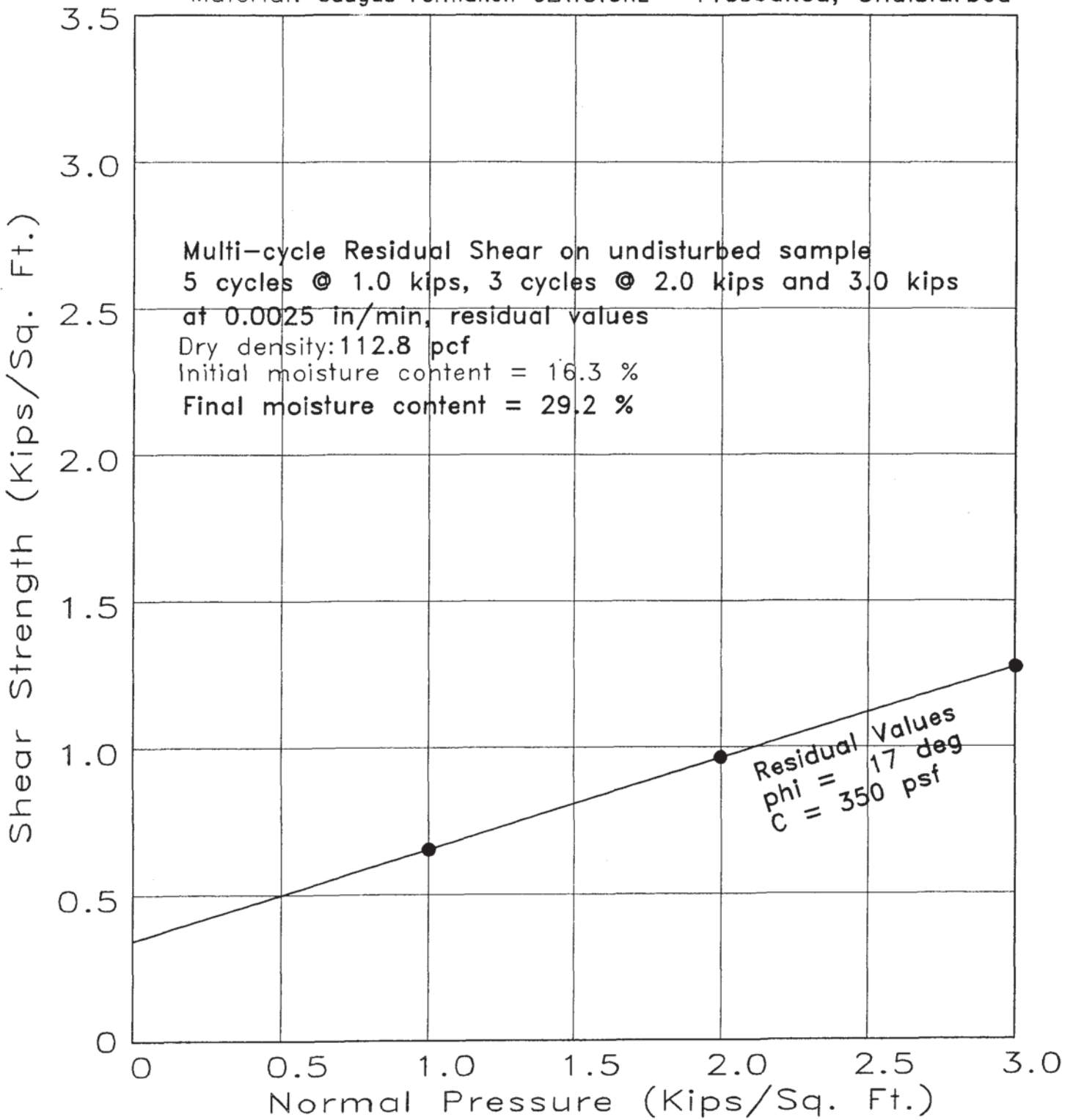

Project Skyline Ranch
 Excavation B23
 Depth 32'



Geolabs - Westlake Village
 GEOLOGY AND SOIL ENGINEERING

DATE 1/14/04 BY SD
 W.O. 8838

Accumulative Shear Information

W.O.: 8838

Excavation: B23 at 32 ft

Displacement Rate: 0.0025 in/min

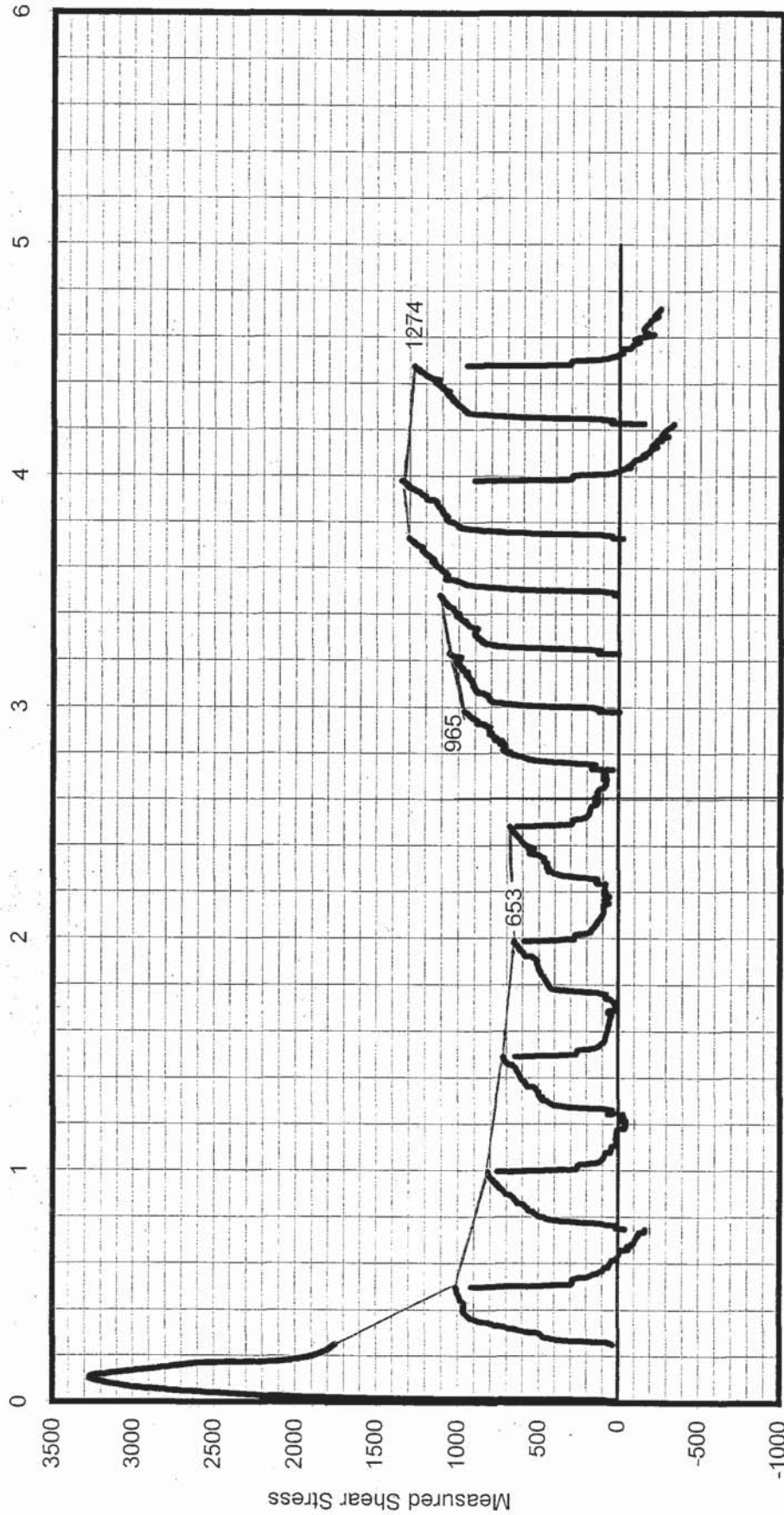

Note: After Initial Cycle, shear machine displaces sample 0.25 inches in the initial direction, then reverses and returns sample to the original position to begin the next cycle.

Shear Ring calibrated for initial direction only

SHEAR TEST DIAGRAM

Material: Saugus Fm. - Red CLAY Remolded

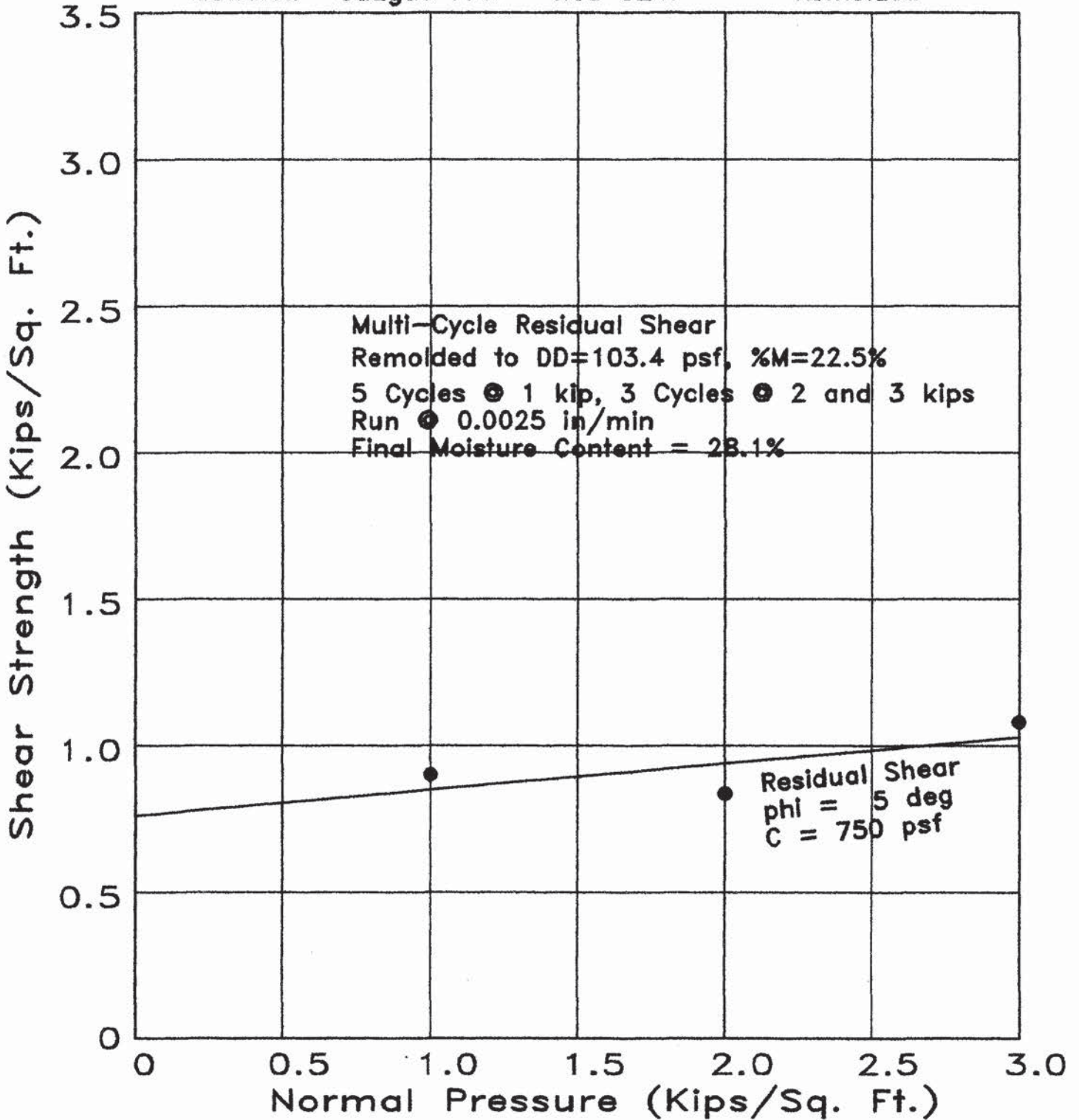

Project Skyline Ranch
 Excavation Boring 26
 Depth 53 Feet



Geolabs - Westlake Village
 GEOLOGY AND SOIL ENGINEERING

BY DS
 DATE _____ W.O. 8838

PLATE S26.53m

Accumulative Shear Information

W.O.: 8838

Excavation: B2~~5~~ at 53 ft

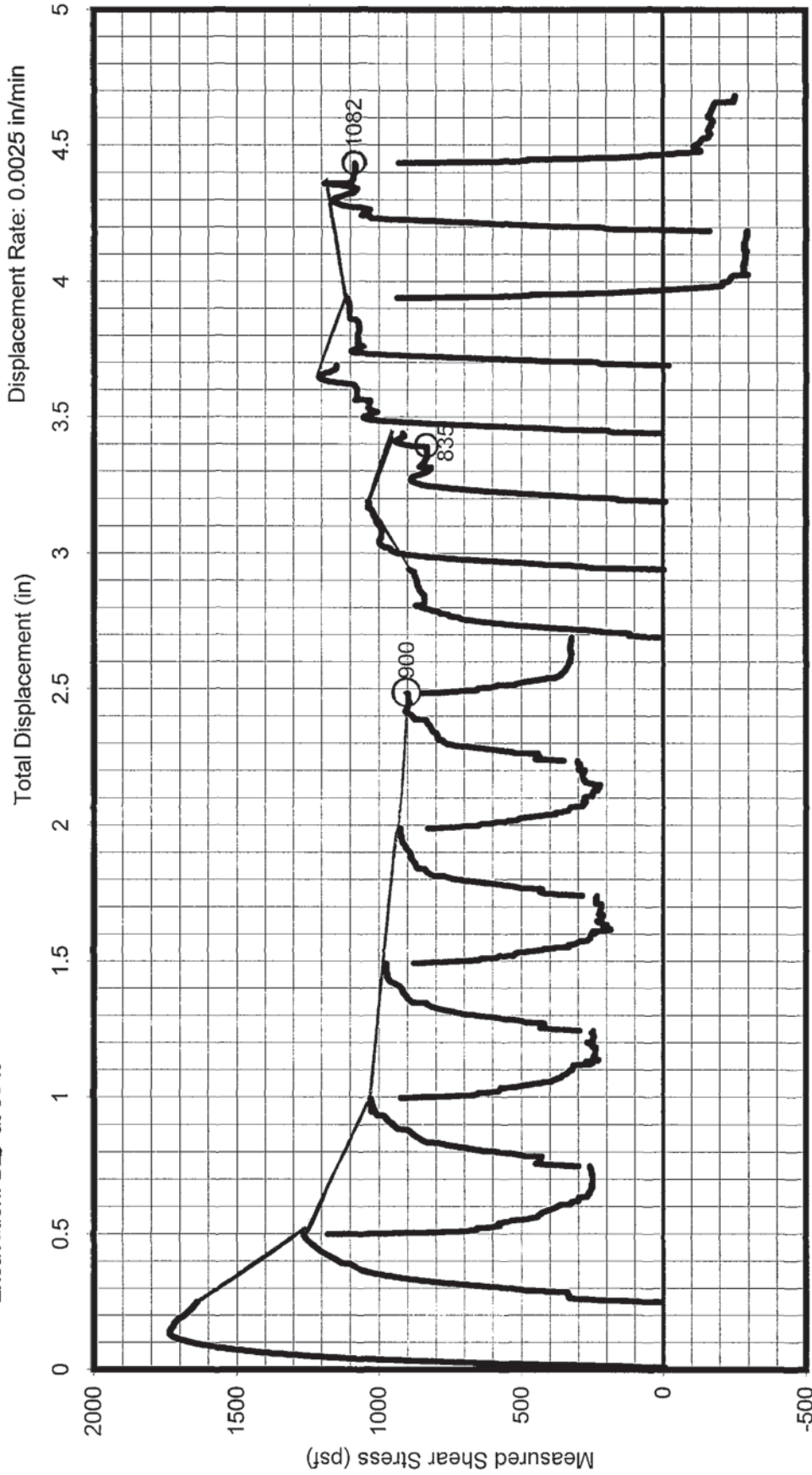

Note: After Initial Cycle, shear machine displaces sample 0.25 inches in the initial direction, then reverses and returns sample to the original position to begin the next cycle.

Shear Ring calibrated for initial direction only

SHEAR TEST DIAGRAM

Material: Saugus Fm. - Reddish brown silty CLAYSTONE

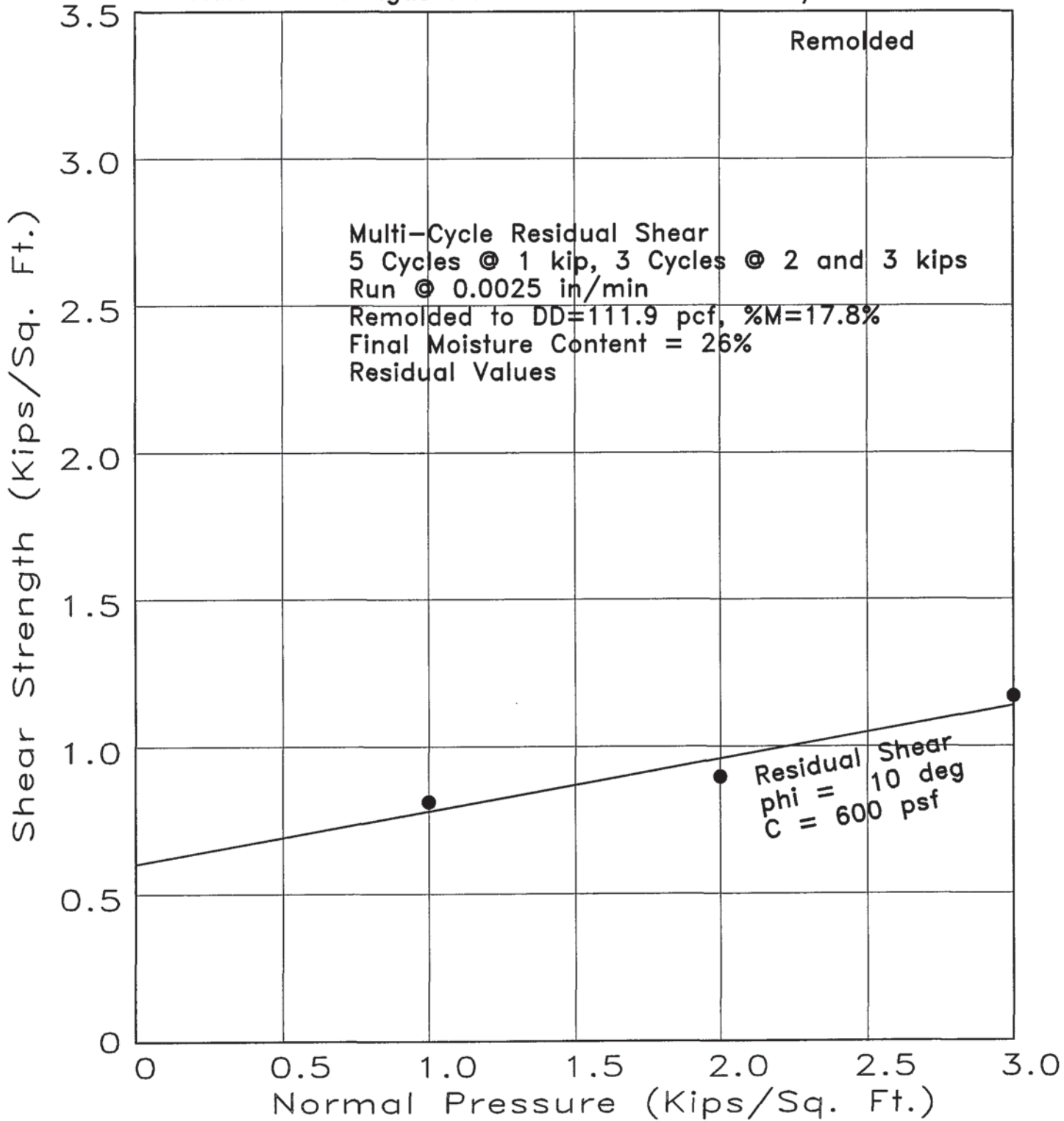

Project **TTM 060922**
 Excavation **Boring 26**
 Depth **53.5 Feet**



Geolabs - Westlake Village
 GEOLOGY AND SOIL ENGINEERING

BY
 W.O. **8838**
 DATE

Accumulative Shear Information

W.O.: 8838

Excavation: B26 at 53 ft

Displacement Rate: 0.0025 in/min

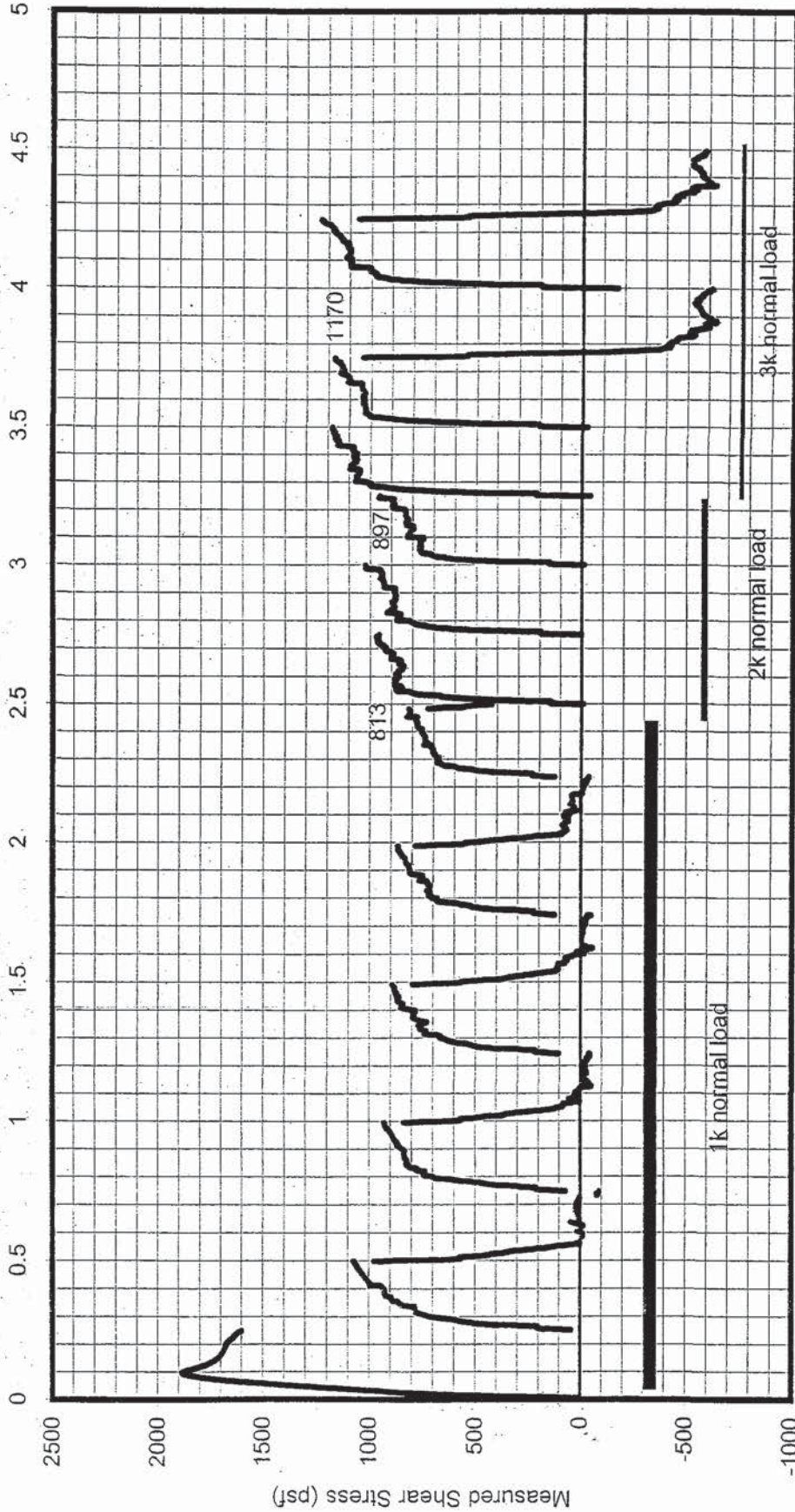

Note: After Initial Cycle, shear machine displaces sample 0.25 inches in the initial direction, then reverses and returns sample to the original position to begin the next cycle.

Shear Ring calibrated for initial direction only

SHEAR TEST DIAGRAM

Material: Saugus Fm. - Clayey SILT

Remolded

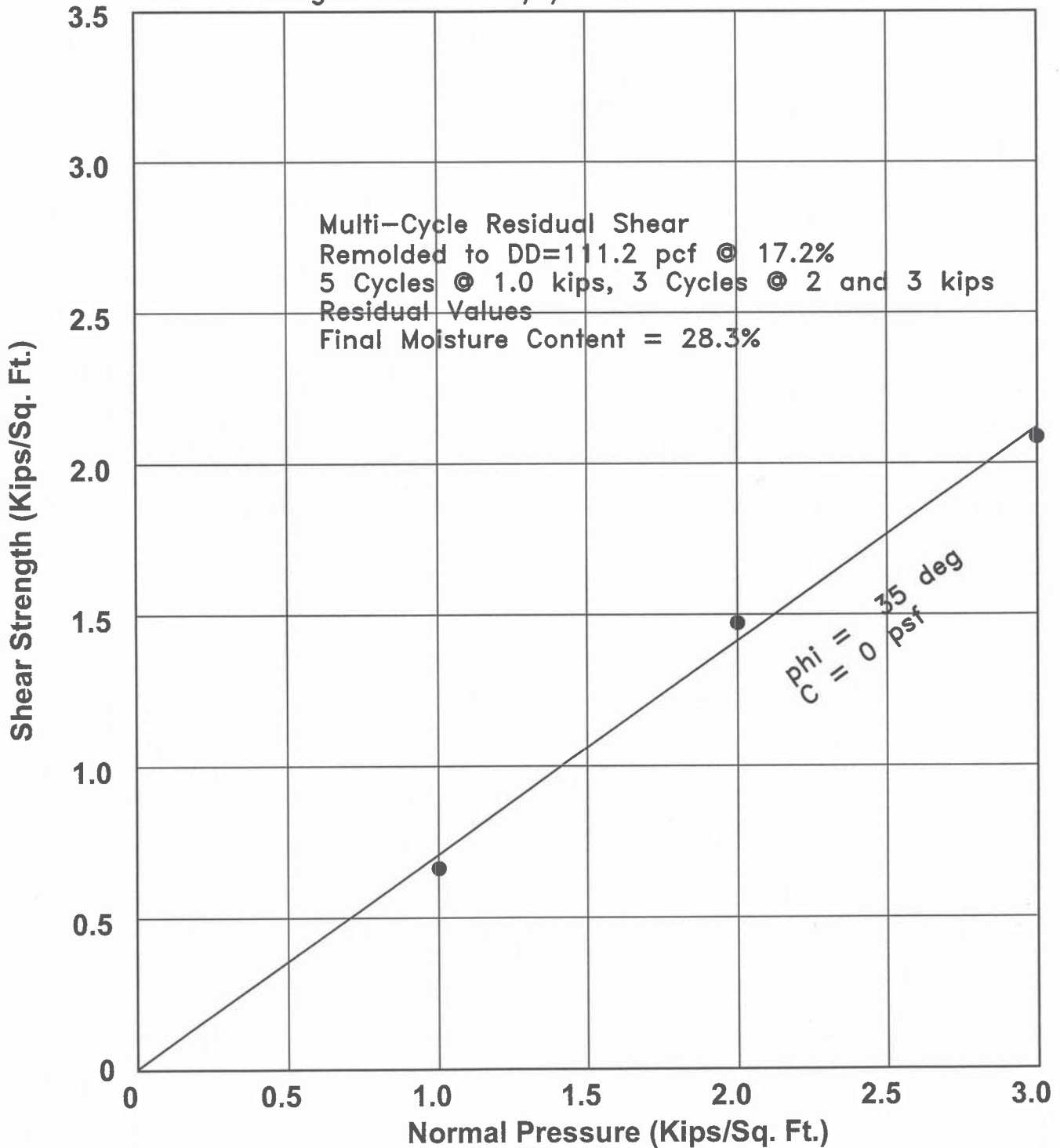

Project TTM 060922 Skyline Ranch
 Excavation Boring 28
 Depth 38 Feet



Geolabs - Westlake Village
 GEOLOGY AND SOIL ENGINEERING

BY DS
 DATE _____ W.O. 8838

PLATE S28.38m

Accumulative Shear Information

W.O.: 8838

Remolded to 111 pcf at 17.2%, sat at 28.3%

Excavation: B28 at 38 ft

Displacement Rate: 0.0025 in/min

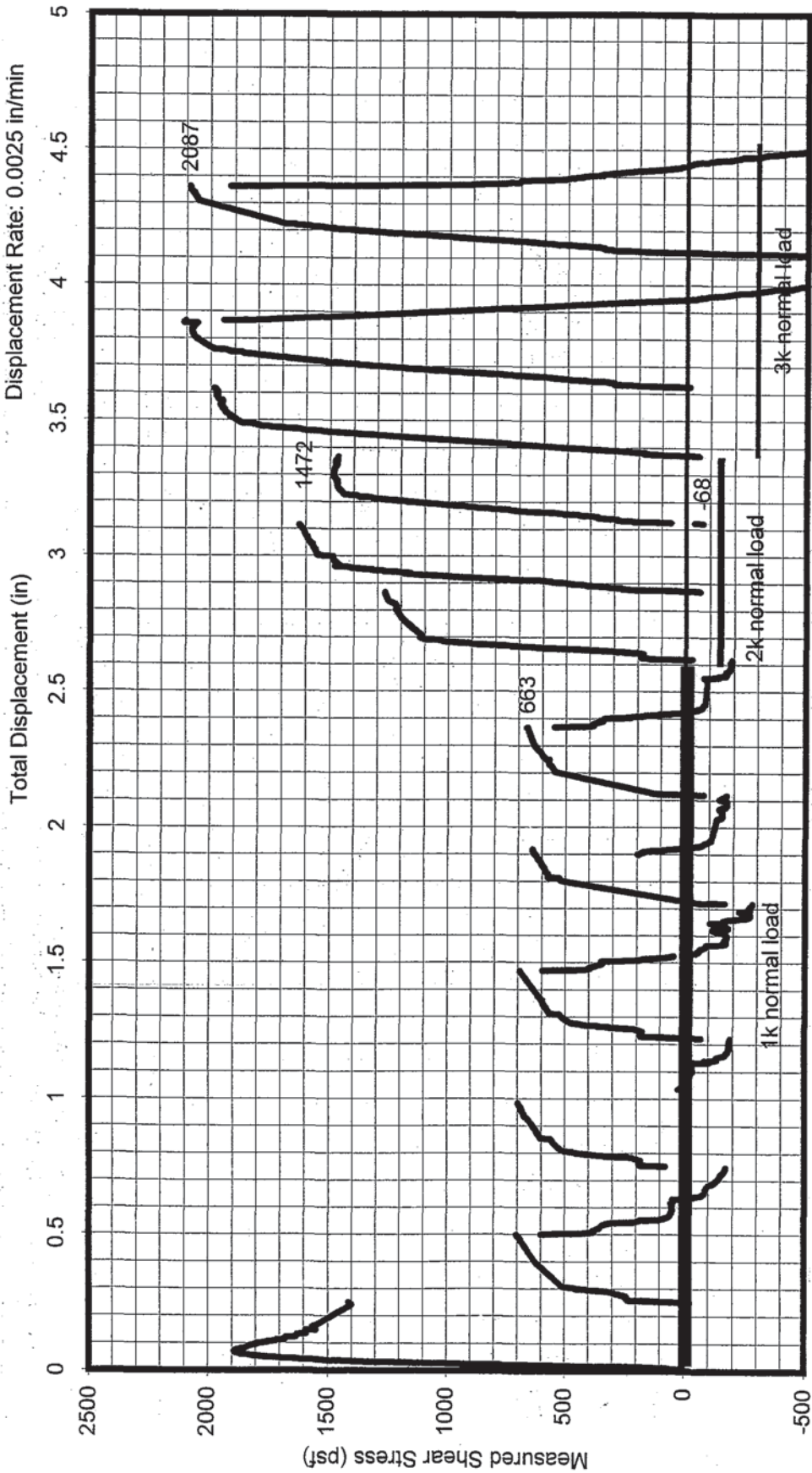

Note: After Initial Cycle, shear machine displaces sample 0.25 inches in the initial direction, then reverses and returns sample to the original position to begin the next cycle.

Shear Ring calibrated for initial direction only

SHEAR TEST DIAGRAM

Material: Saugus Fm. – Red brn CLAY Remolded

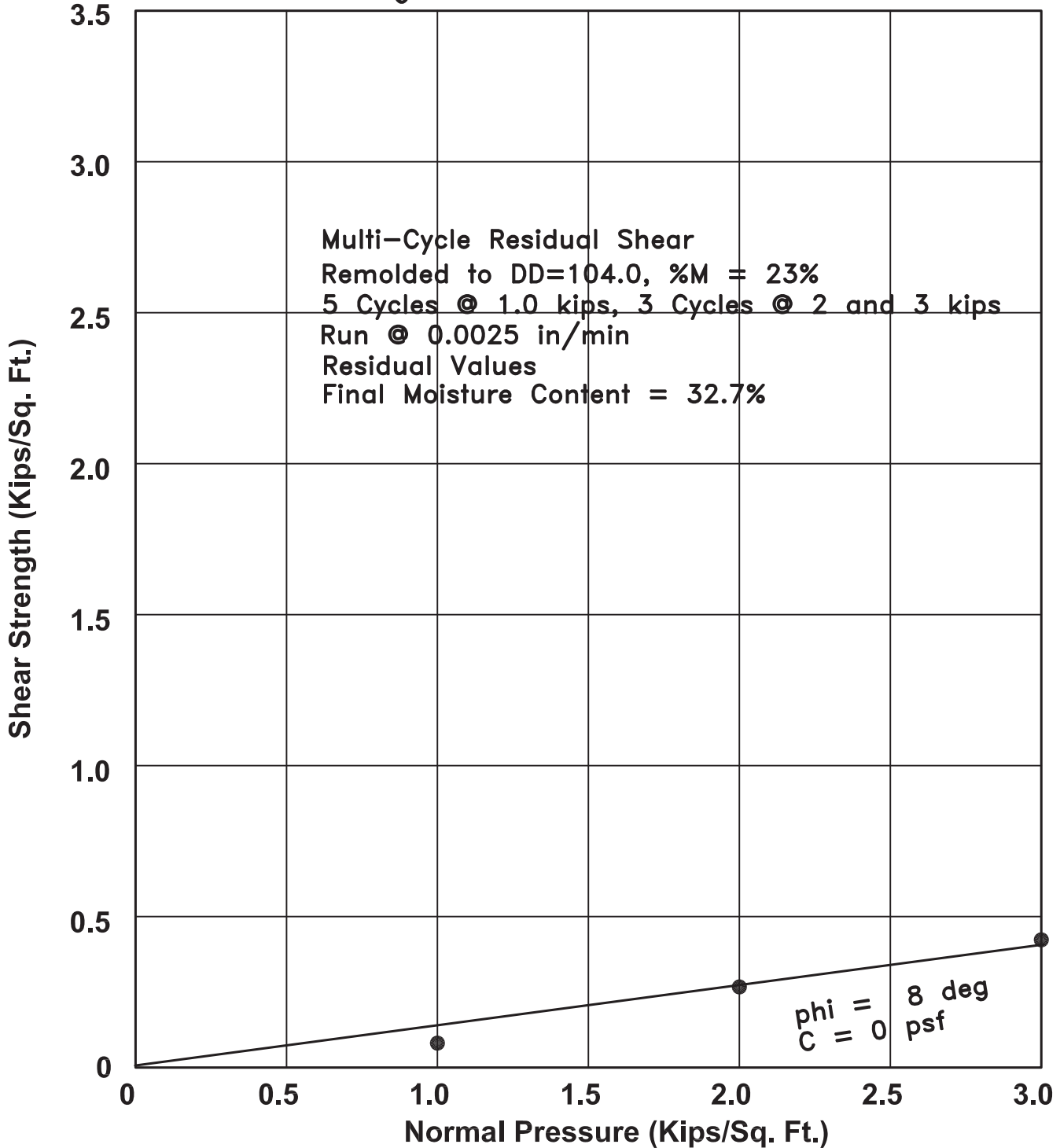

Project TTM 60922 Skyline Ranch
Excavation Boring 29
Depth 48.5 Feet



Geolabs – Westlake Village
GEOLOGY AND SOIL ENGINEERING

BY DS
DATE _____ W.O. 8838

Accumulative Shear Information
Remolded

W.O.: 8838

Excavation: B29 at 48.5 ft

Displacement Rate: 0.0025 in/min

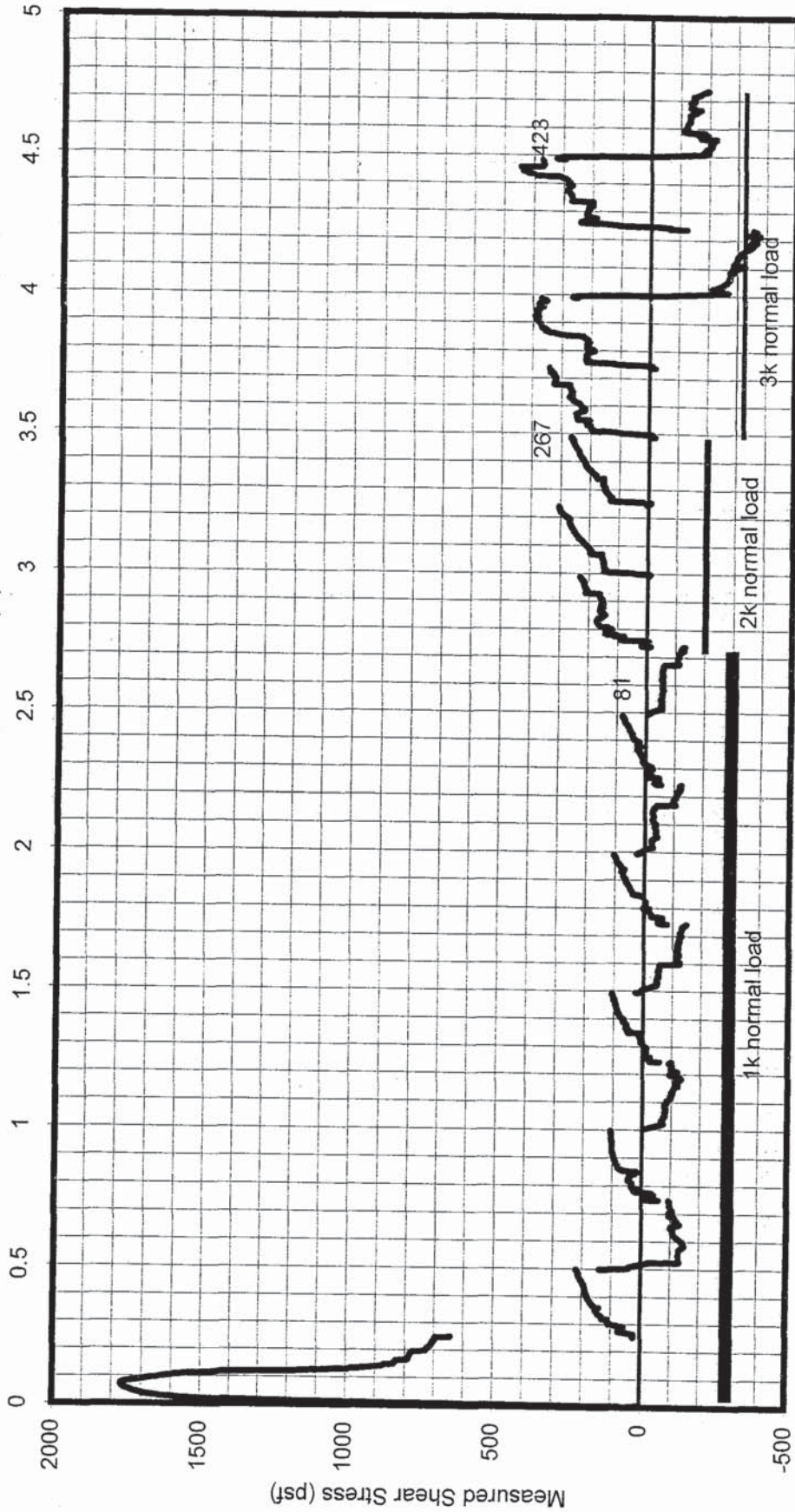

Note: After Initial Cycle, shear machine displaces sample 0.25 inches in the initial direction, then reverses and returns sample to the original position to begin the next cycle.

Shear Ring calibrated for initial direction only

SHEAR TEST DIAGRAM

Material: Saugus Fm. - Fine-gr. SANDSTONE Undisturbed

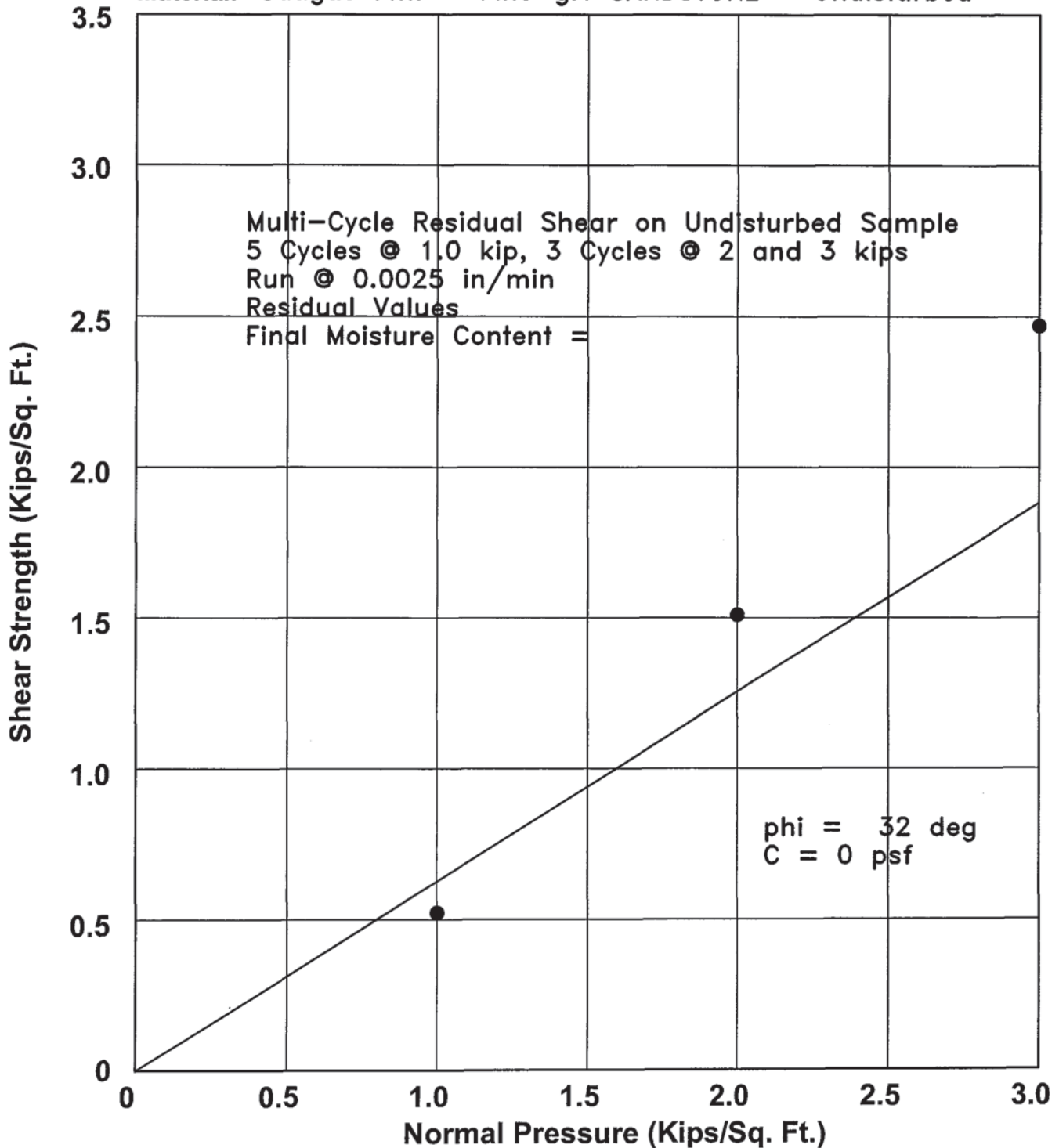

Project Skyline Ranch, TTM 060922
 Excavation Boring 29
 Depth 50 Feet



Geolabs - Westlake Village
 GEOLOGY AND SOIL ENGINEERING

BY DS
 DATE _____ W.O. 8838

PLATE S29.50m

Accumulative Shear Information

W.O.: 8838

Excavation: B29 at 50 ft

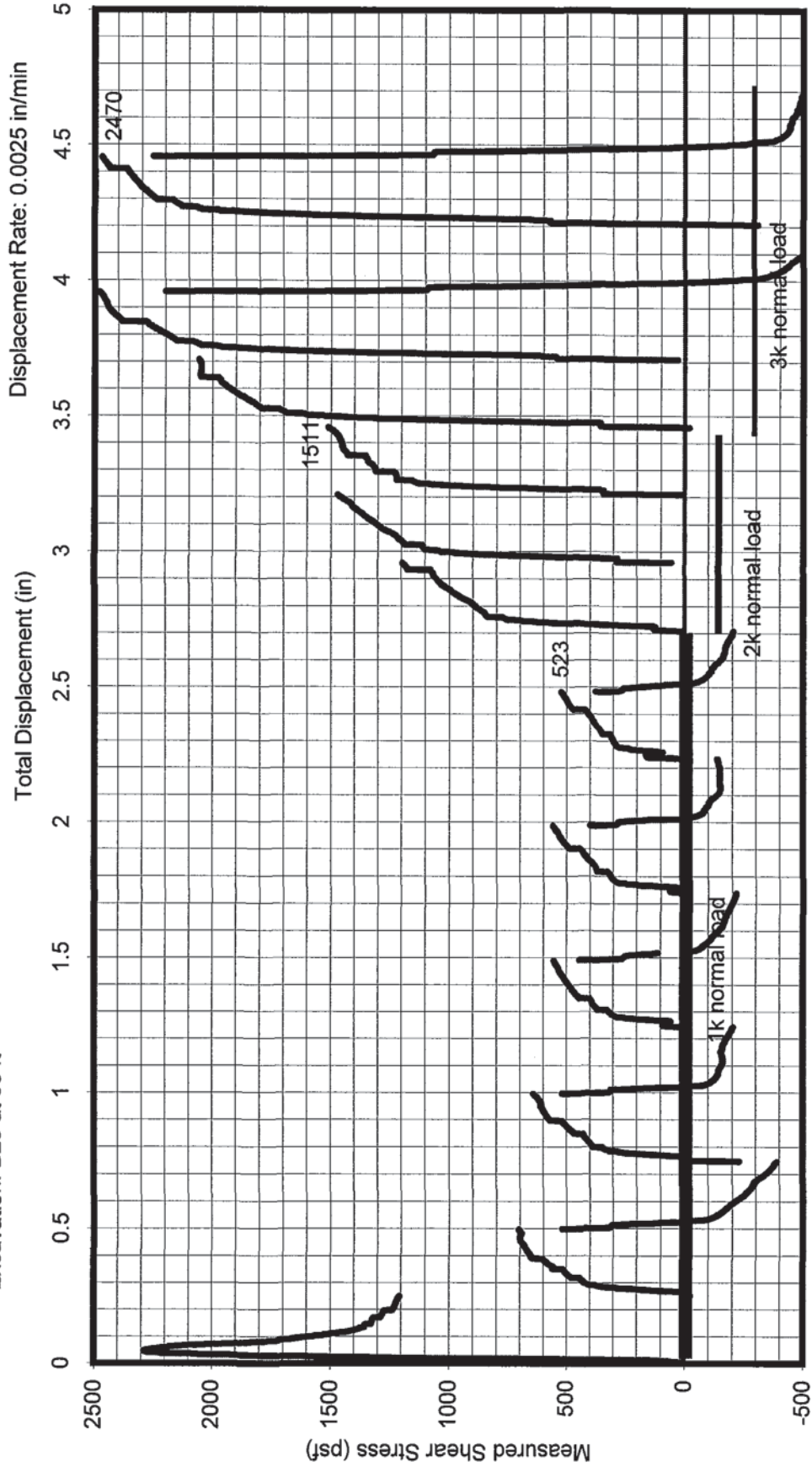

Note: After Initial Cycle, shear machine displaces sample 0.25 inches in the initial direction, then reverses and returns sample to the original position to begin the next cycle.

Shear Ring calibrated for initial direction only

SHEAR TEST DIAGRAM

Material: Mint Canyon Fm. - Silty v. fine-grained SANDSTONE

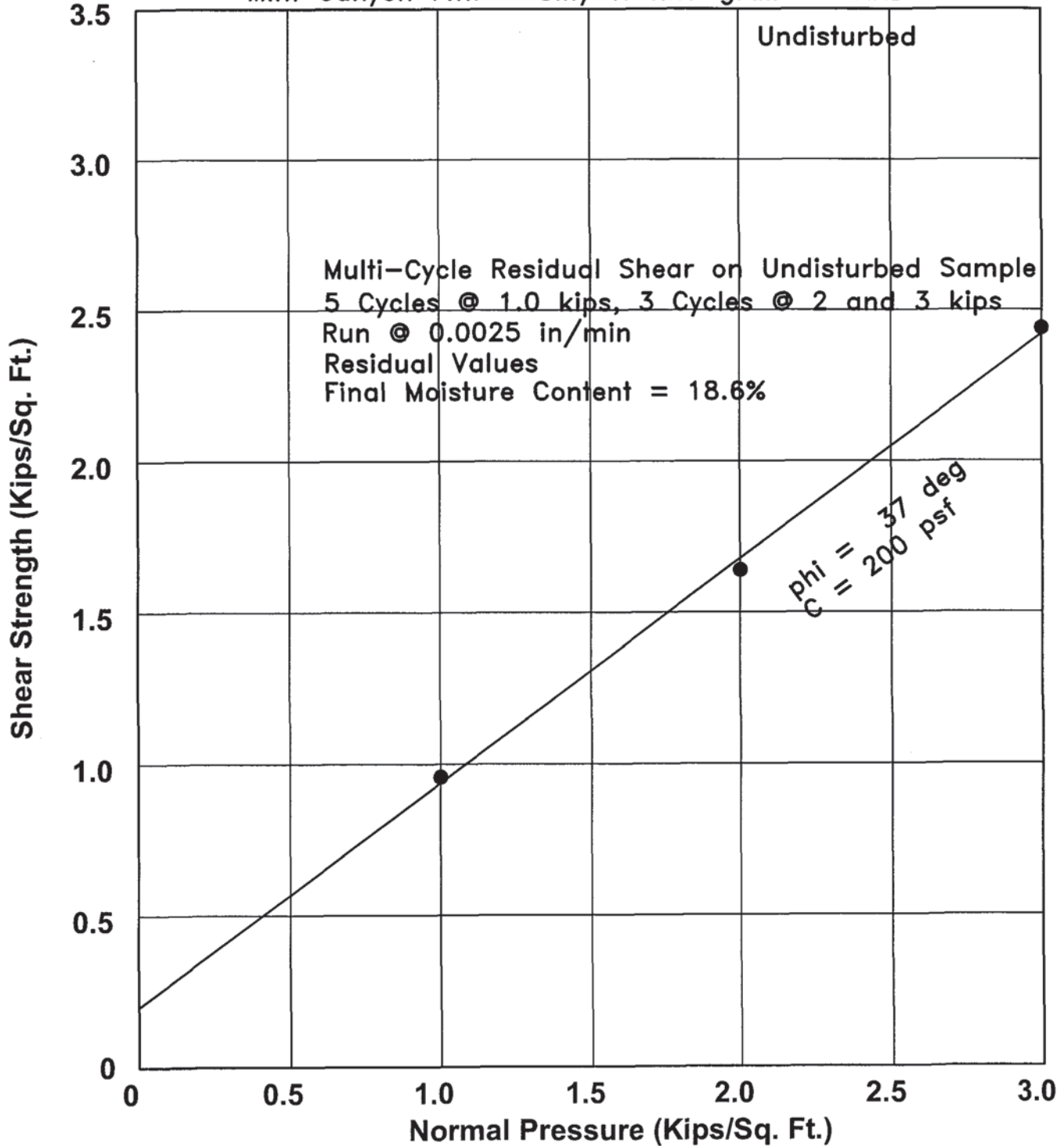

Project TTM 60922 Skyline Ranch
 Excavation Boring 38
 Depth 80 Feet



Geolabs - Westlake Village
 GEOLOGY AND SOIL ENGINEERING

BY DS
 DATE _____ W.O. 8838.001

PLATE S38.80m

Excavation: B38

Depth: 80 ft

Sample Description: Dark brown slightly clayey silty fine to medium sand

Displacement Rate: 0.0025 in/min

SHEARS
1K, 2K, & 3K NORMAL LOADS
 Undisturbed, Sat at ? %

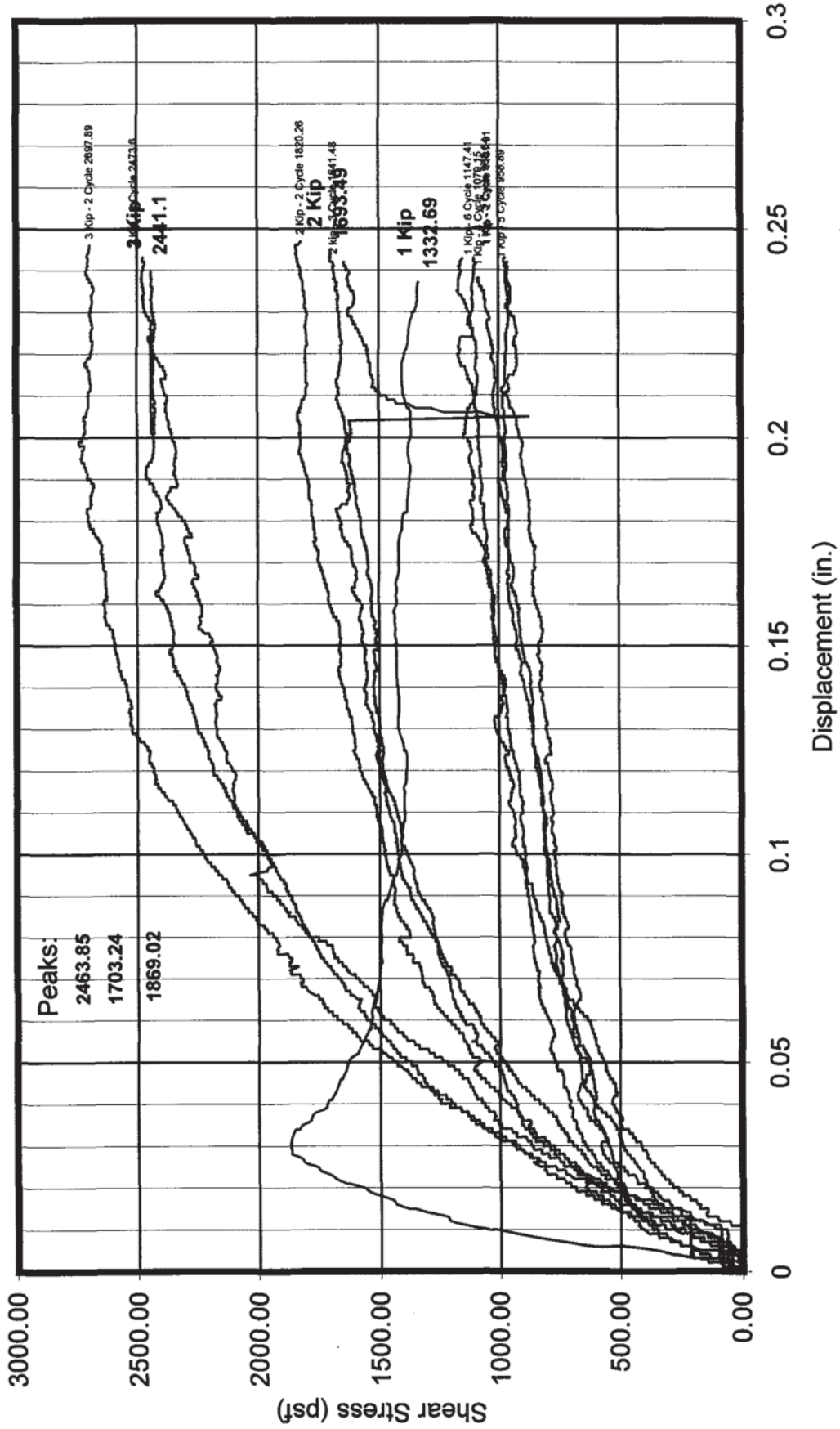

SHEAR TEST DIAGRAM

Material: Saugus Formation - Clayey SILTSTONE Remolded

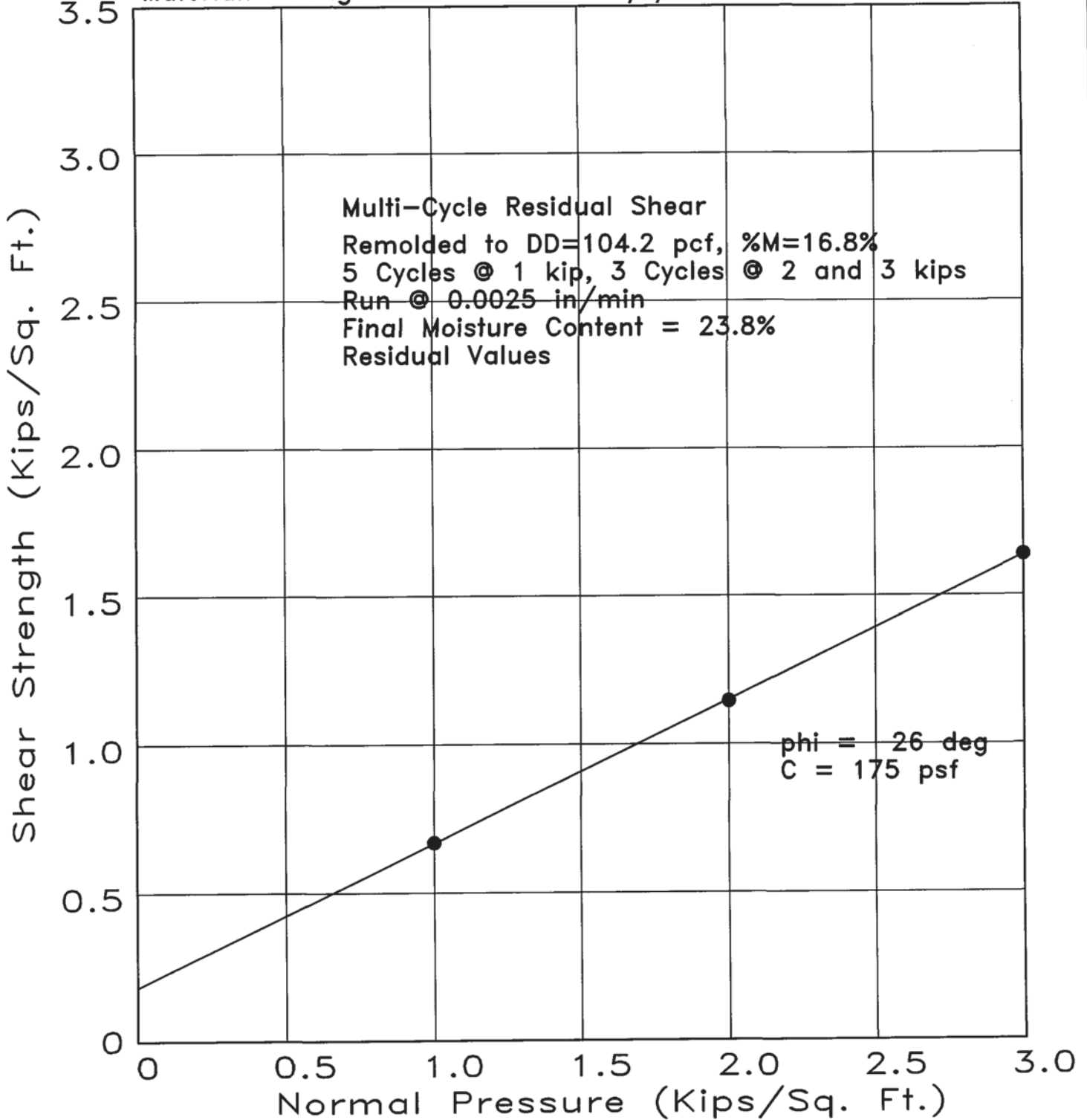

Project Tr. 60922, Skyline Ranch
 Excavation B39
 Depth 89 Feet



Geolabs - Westlake Village
 GEOLOGY AND SOIL ENGINEERING

BY DS
 DATE _____ W.O. 8838

Excavation: B39

Depth: 89 ft

Sample Description: Light brown fine sandy silty clay

Displacement Rate: 0.002500 in/min

SHEARS
1K, 2K, & 3K NORMAL LOADS
 Remolded, Sat at 23.8 %

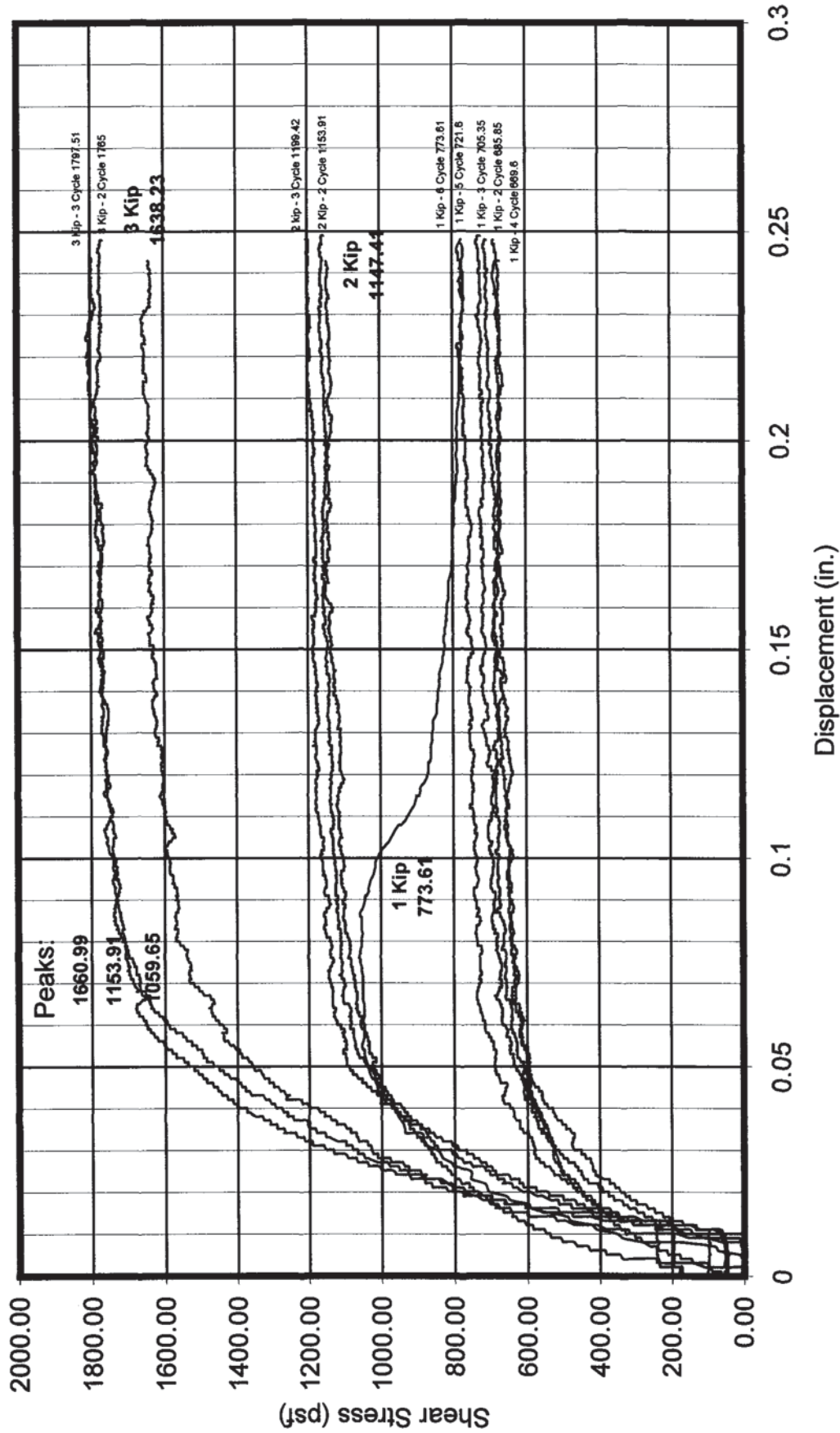

SHEAR TEST DIAGRAM

Material: Mint Canyon Formation - Sandy Claystone Remolded

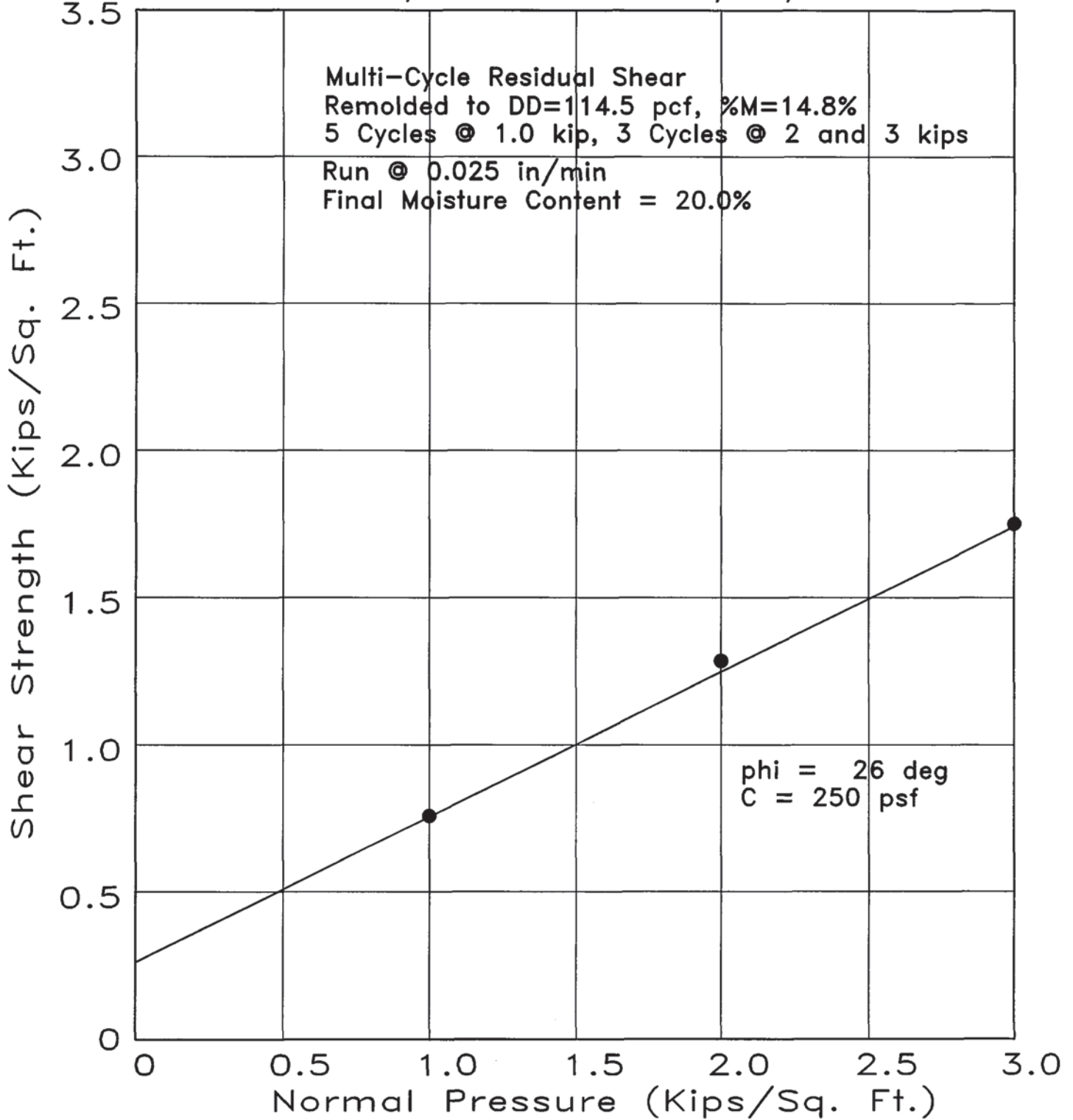

Project Tr. 060922 Skyline Ranch
 Excavation B40
 Depth 55 Feet



Geolabs - Westlake Village
 GEOLOGY AND SOIL ENGINEERING

BY DS
 DATE _____ W.O. 8838

Excavation: B40

Depth: 55 ft

Sample Description: Light gray fine sandy silty clay

Displacement Rate: 0.00250 in/min

SHEARS
1K, 2K, & 3K NORMAL LOADS
 Remolded, Sat at 20.0 %

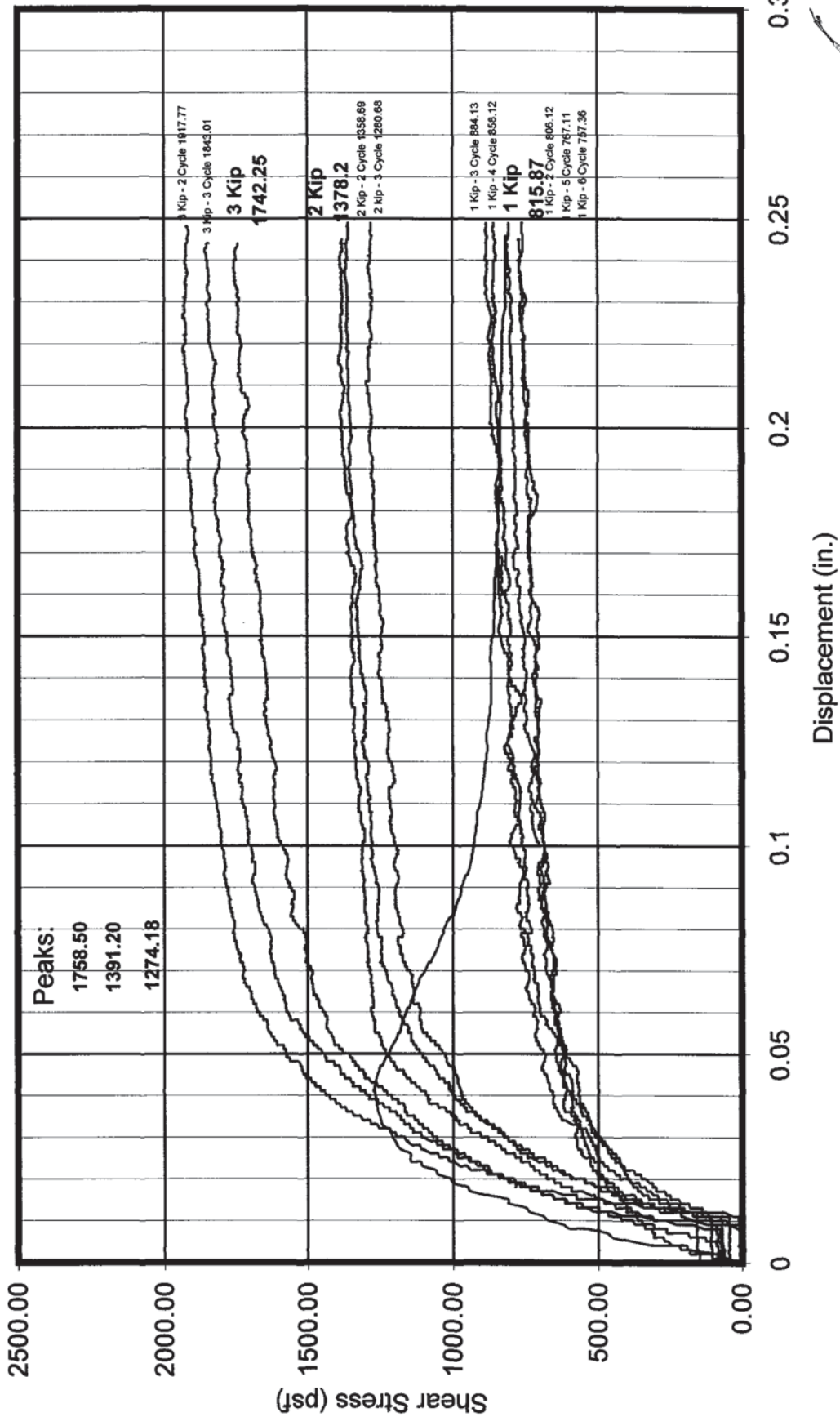

SHEAR TEST DIAGRAM

Material: Saugus Fm. - Reddish brown CLAYSTONE Remolded

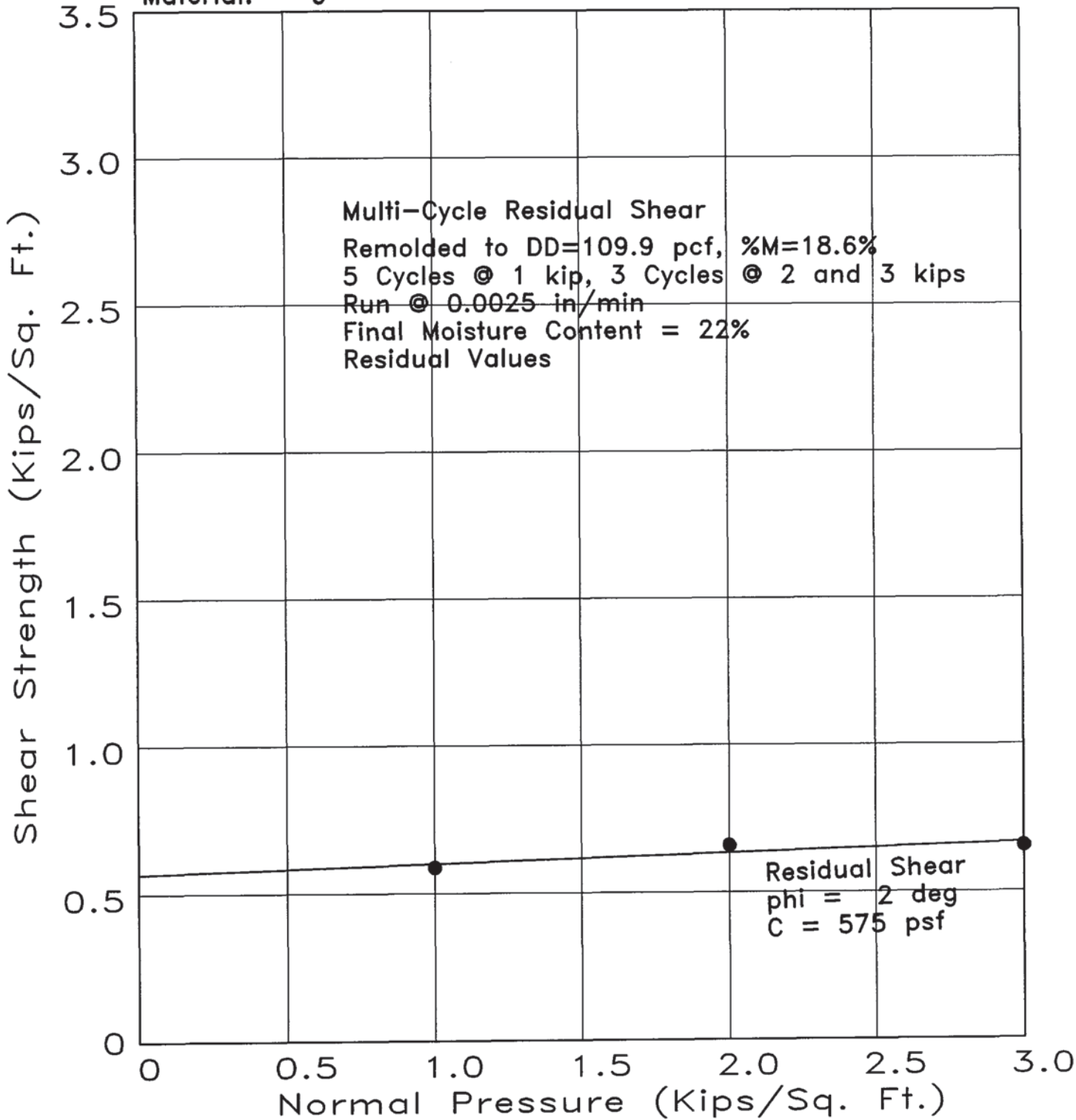

Project Tr. 60922, Skyline Ranch
 Excavation B46
 Depth 60.8 Feet



Geolabs - Westlake Village
 GEOLOGY AND SOIL ENGINEERING

BY DS
 DATE _____ W.O. 8838

Excavation: B46

Depth: 60 ft

Sample Description: Light reddish brown fine sandy silty clay

Displacement Rate: 0.00250 in/min

SHEARS 1K, 2K, & 3K NORMAL LOADS Remolded, Sat at ? %

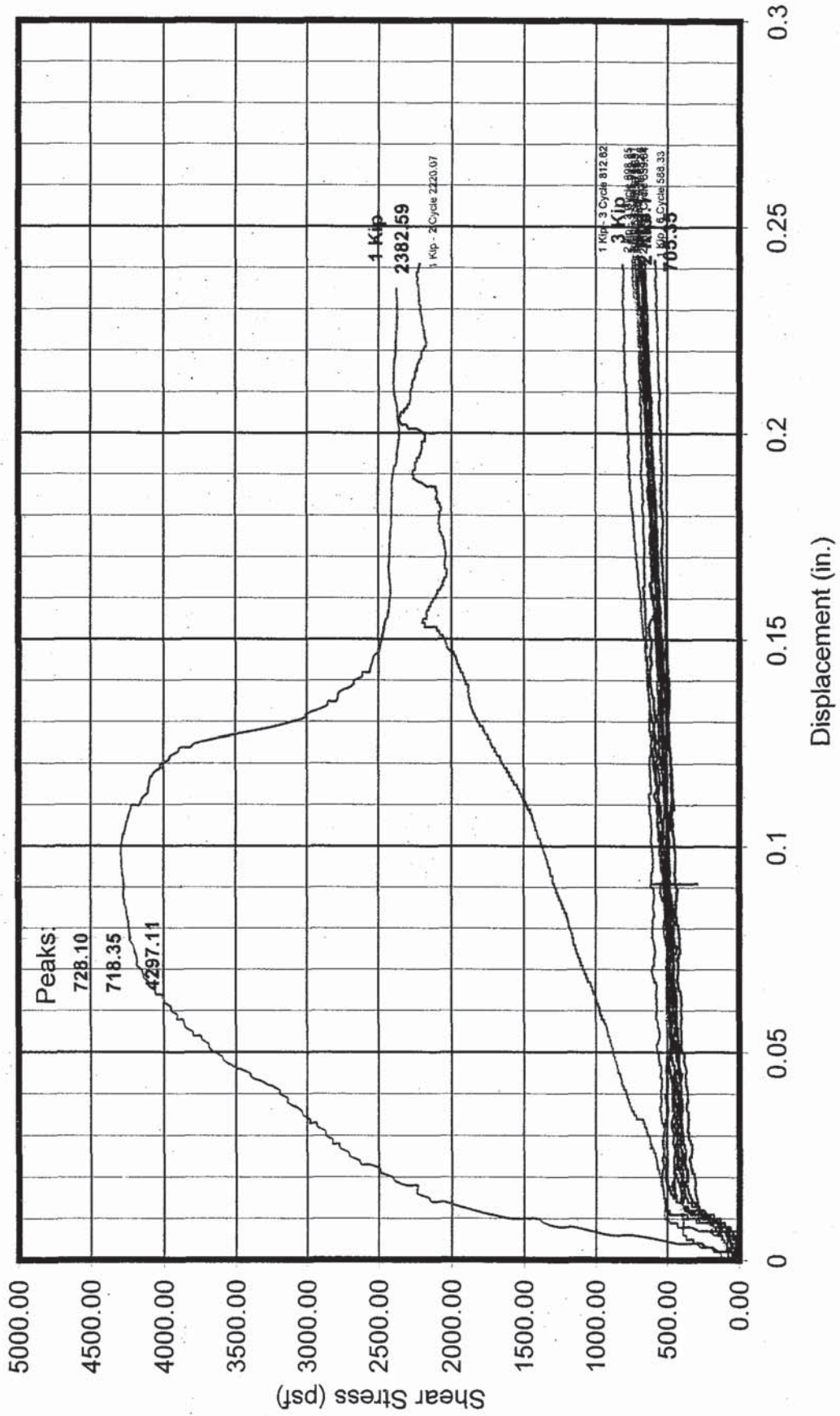

SHEAR TEST DIAGRAM

Material: Saugus Fm. - Brown sheared CLAYSTONE Undisturbed

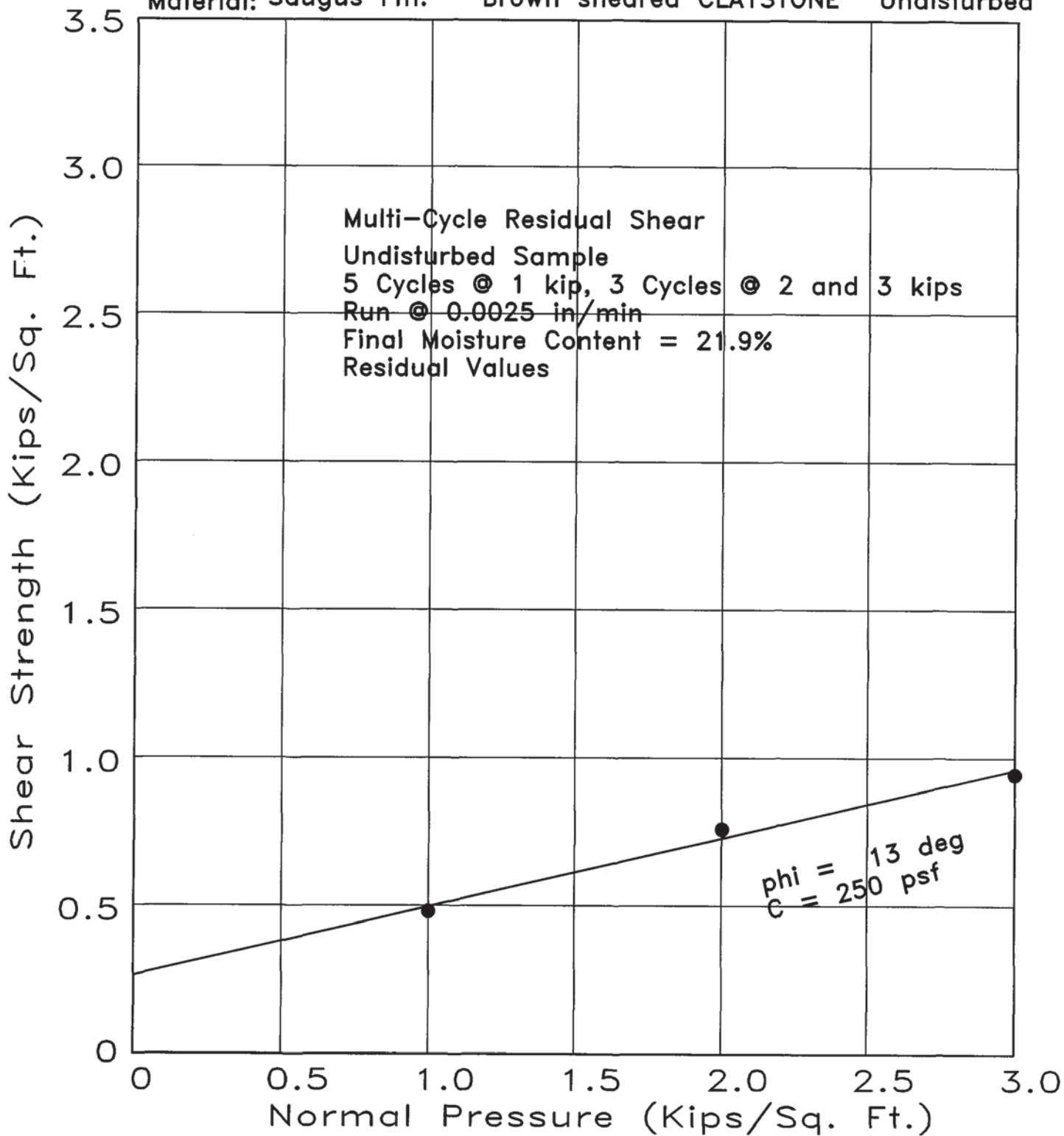

Project Tr. 60922, Skyline Ranch
Excavation B47
Depth 20 Feet



Geolabs - Westlake Village
GEOLOGY AND SOIL ENGINEERING

BY DS
DATE _____ W.O. 8838

Excavation: B47

Depth: 20 ft

Sample Description: Tan silty clay

Displacement Rate: 0.0025 in/min

SHEARS
1K, 2K, & 3K NORMAL LOADS
 Undisturbed, Sat at 21.9 %

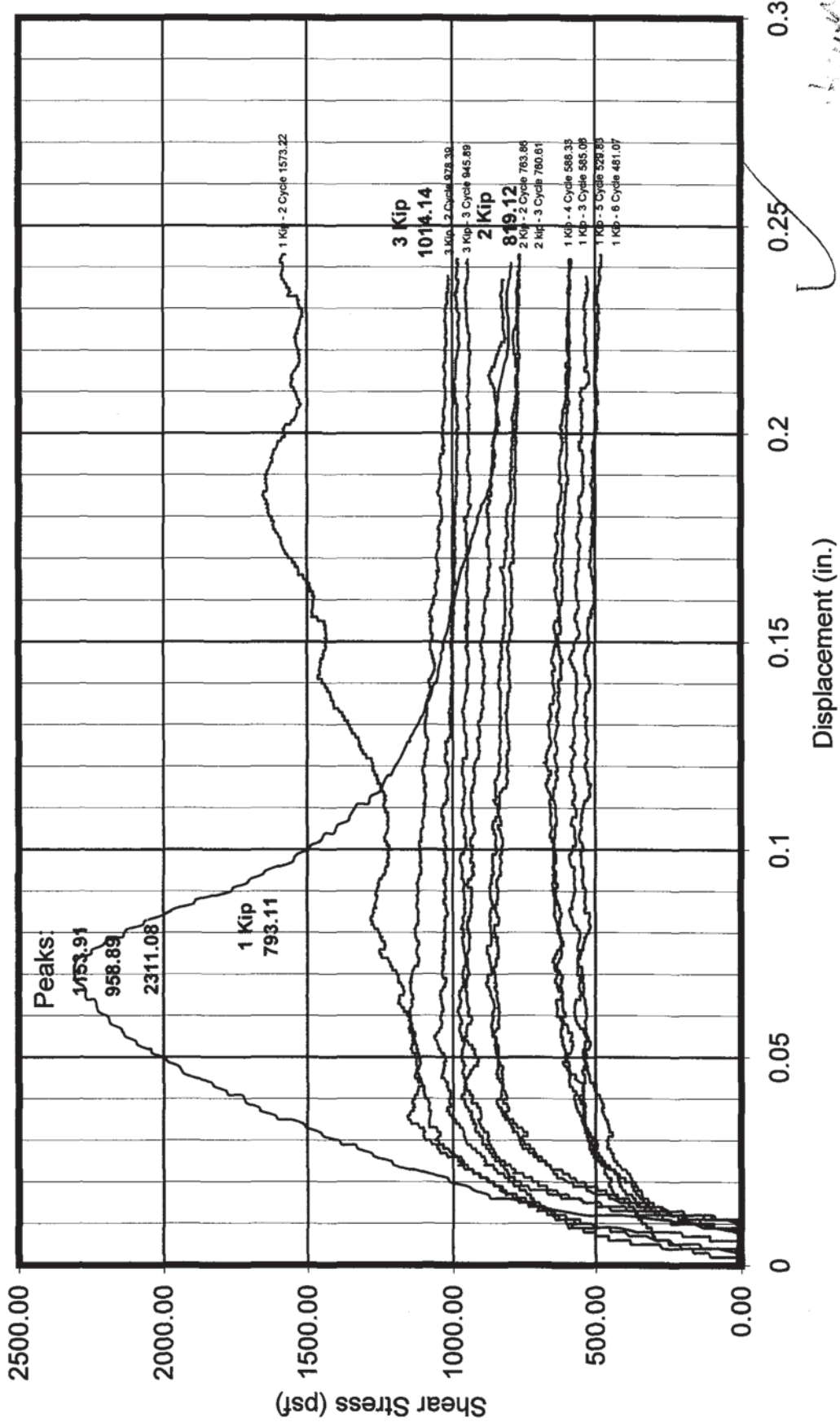

SHEAR TEST DIAGRAM

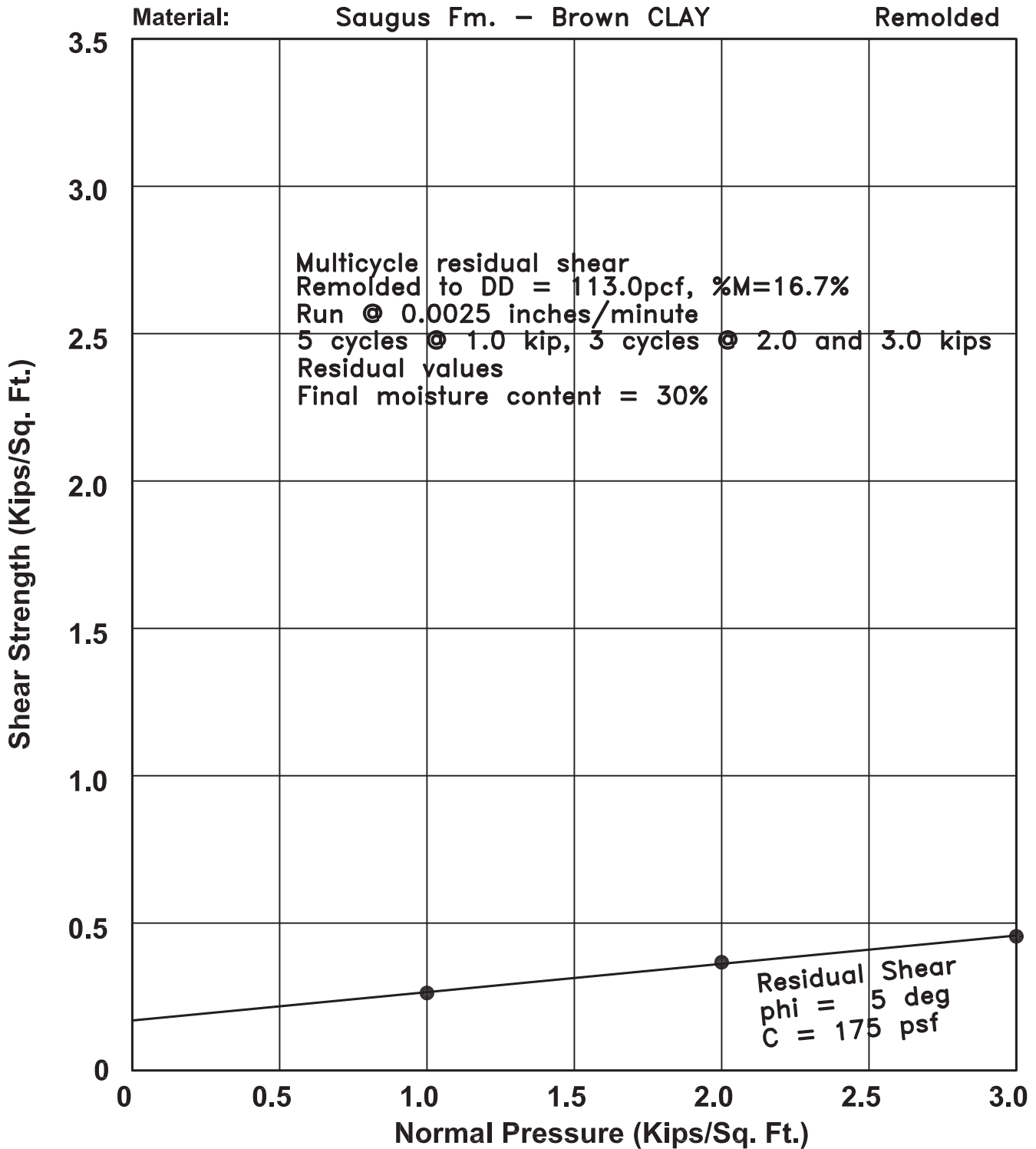

Project Skyline Ranch
 Excavation B47
 Depth 87.5'



Geolabs – Westlake Village
 GEOLOGY AND SOIL ENGINEERING

BY AJH
 DATE _____ W.O. 8838

Excavation: B47 Depth: 87 ft Sample Description: 113.0pcf @ 16.7% Displacement Rate: 0.0025 in/min

SHEARS 1K, 2K, & 3K NORMAL LOADS Remolded, Sat at 30.0 %

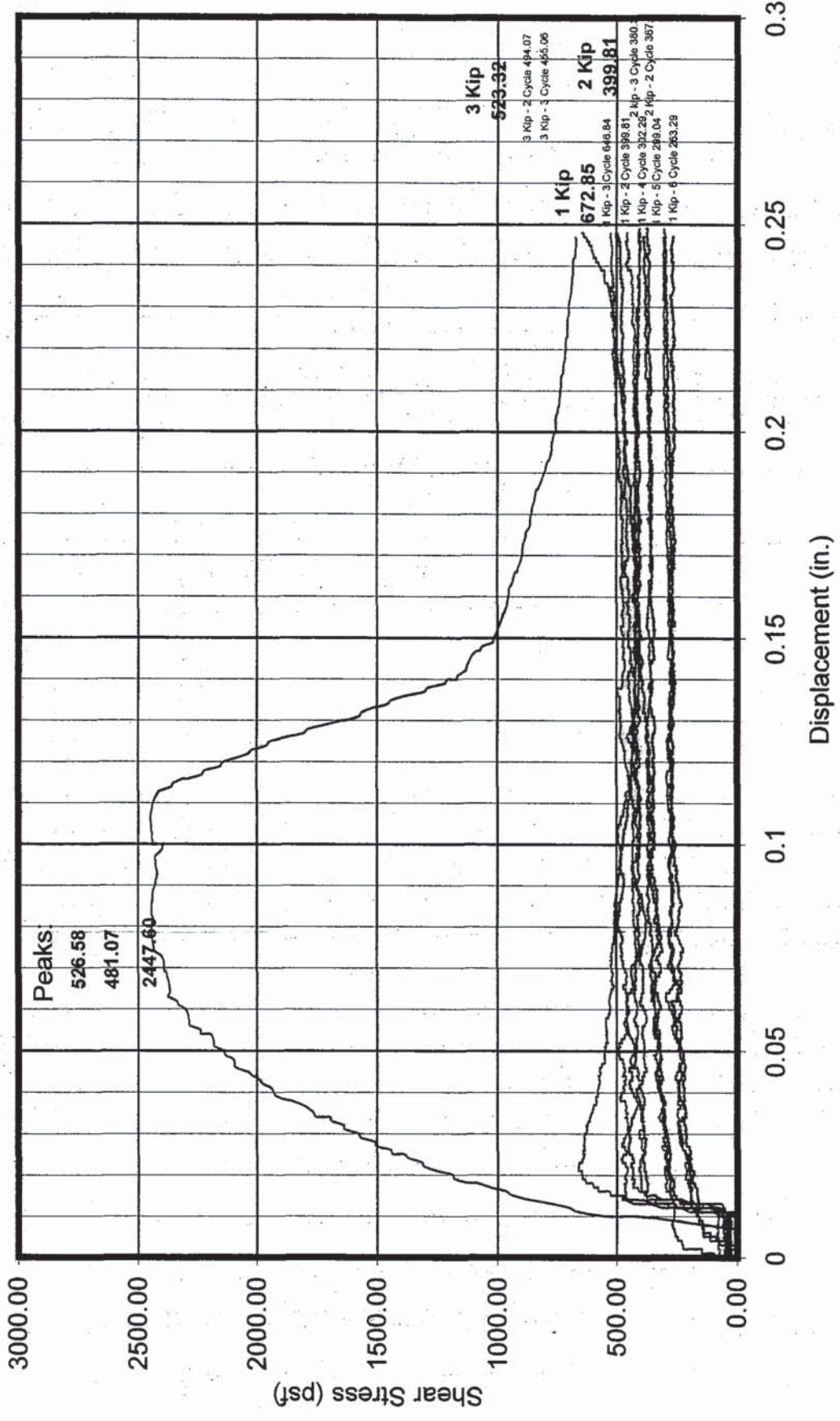

SHEAR TEST DIAGRAM

Material: Saugus Fm. – Light brown silty CLAY Undisturbed

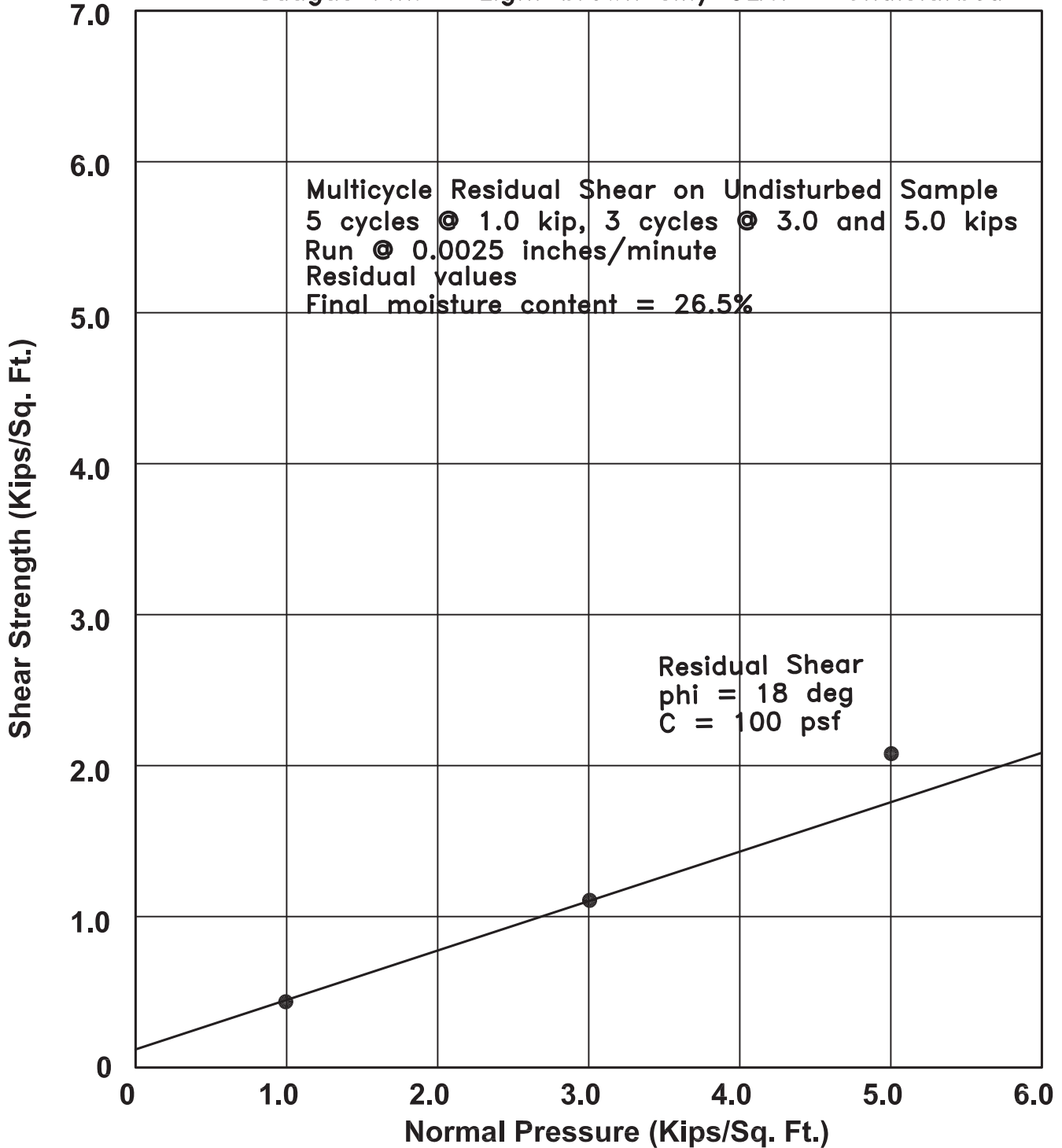

Project Skyline Ranch
 Excavation B48
 Depth 96'



Geolabs – Westlake Village
 GEOLOGY AND SOIL ENGINEERING

BY AJH
 DATE _____ W.O. 8838

Excavation: B48

Depth: 96 ft

Sample Description: Light brown silty clay

Displacement Rate: 0.0025 in/min

SHEARS 1K, 3K, & 5K NORMAL LOADS Undisturbed, Sat at 26.5 %

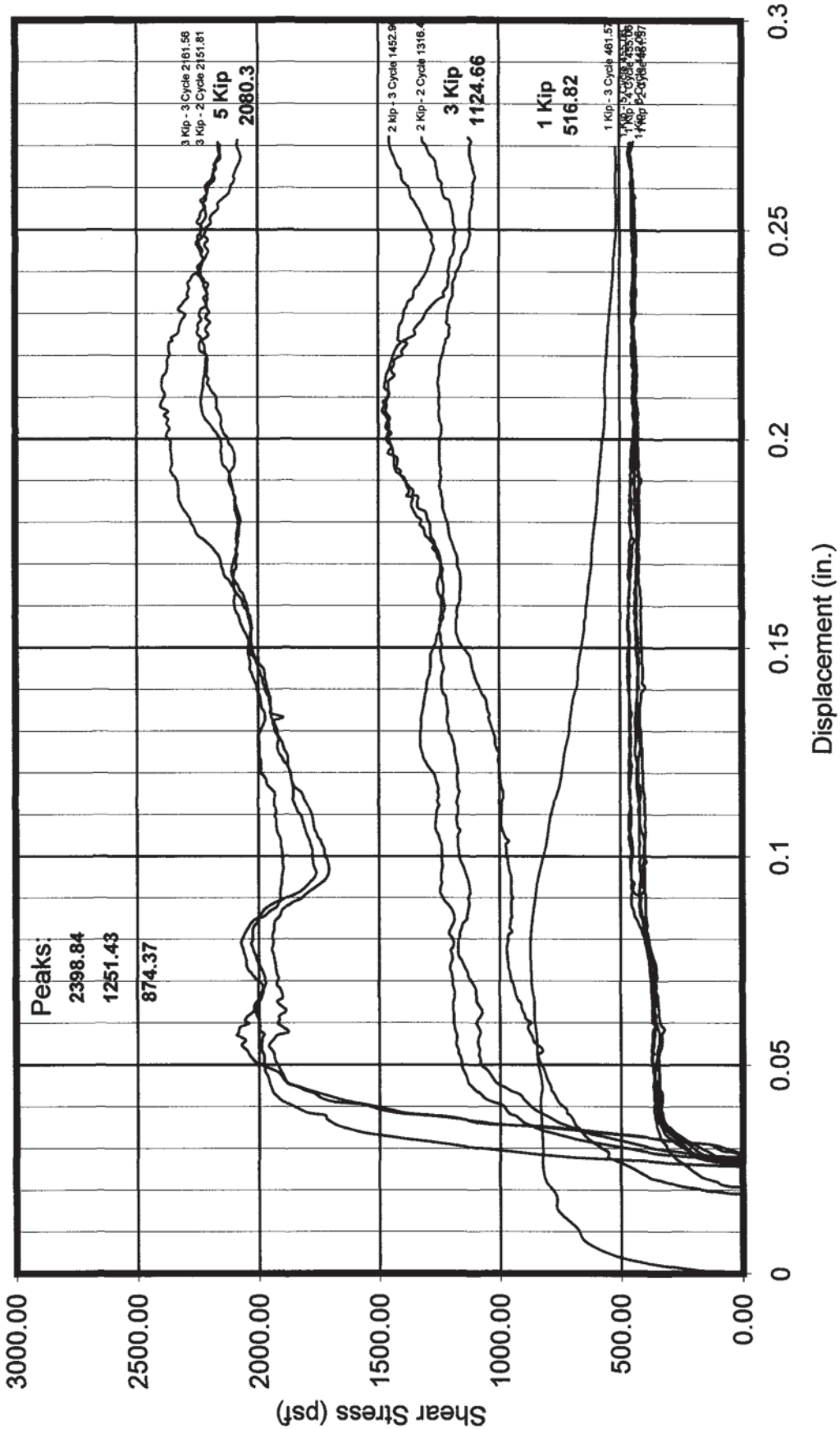

SHEAR TEST DIAGRAM

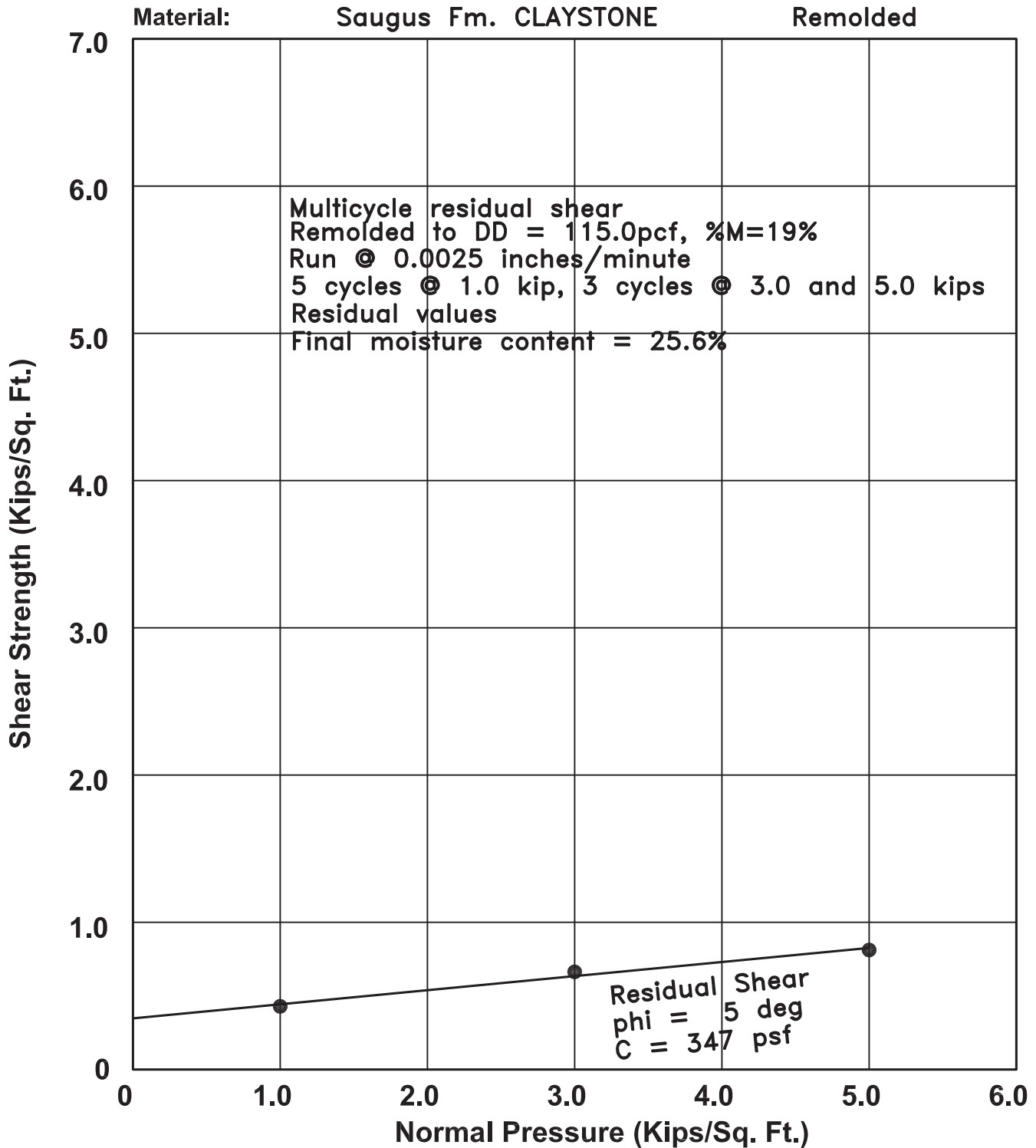

Project Skyline Ranch
 Excavation B48
 Depth 97'



Geolabs - Westlake Village
 GEOLOGY AND SOIL ENGINEERING

BY AJH
 DATE _____ W.O. 8838

Excavation: B48

Depth: 97 ft

Sample Description: Light brown silty clay

Displacement Rate: 0.0025 in/min

SHEARS
1K, 3K, & 5K NORMAL LOADS
Remolded, Sat at 25.6 %

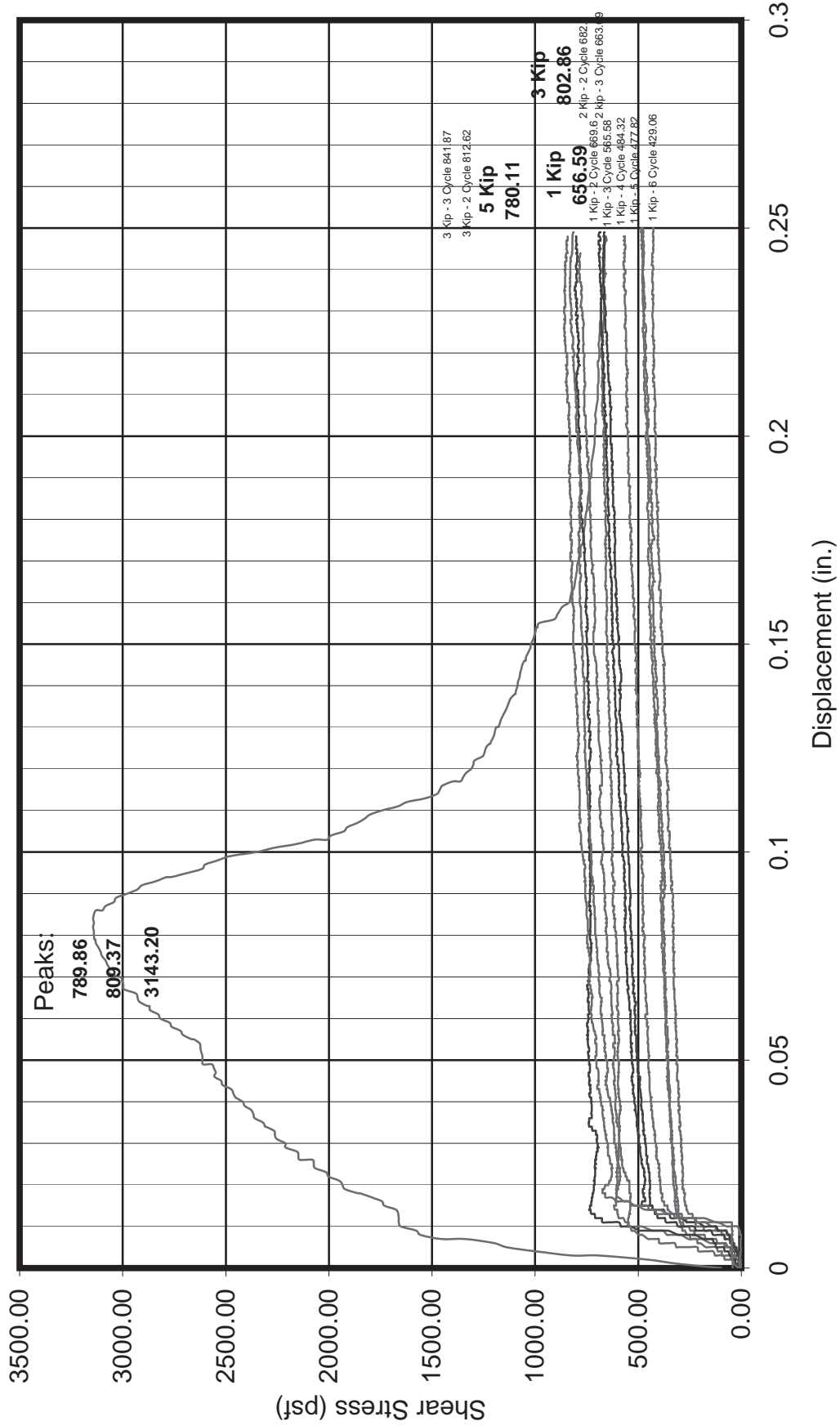

SHEAR TEST DIAGRAM

Material: Saugus Fm. - Brown sheared CLAYSTONE Undisturbed

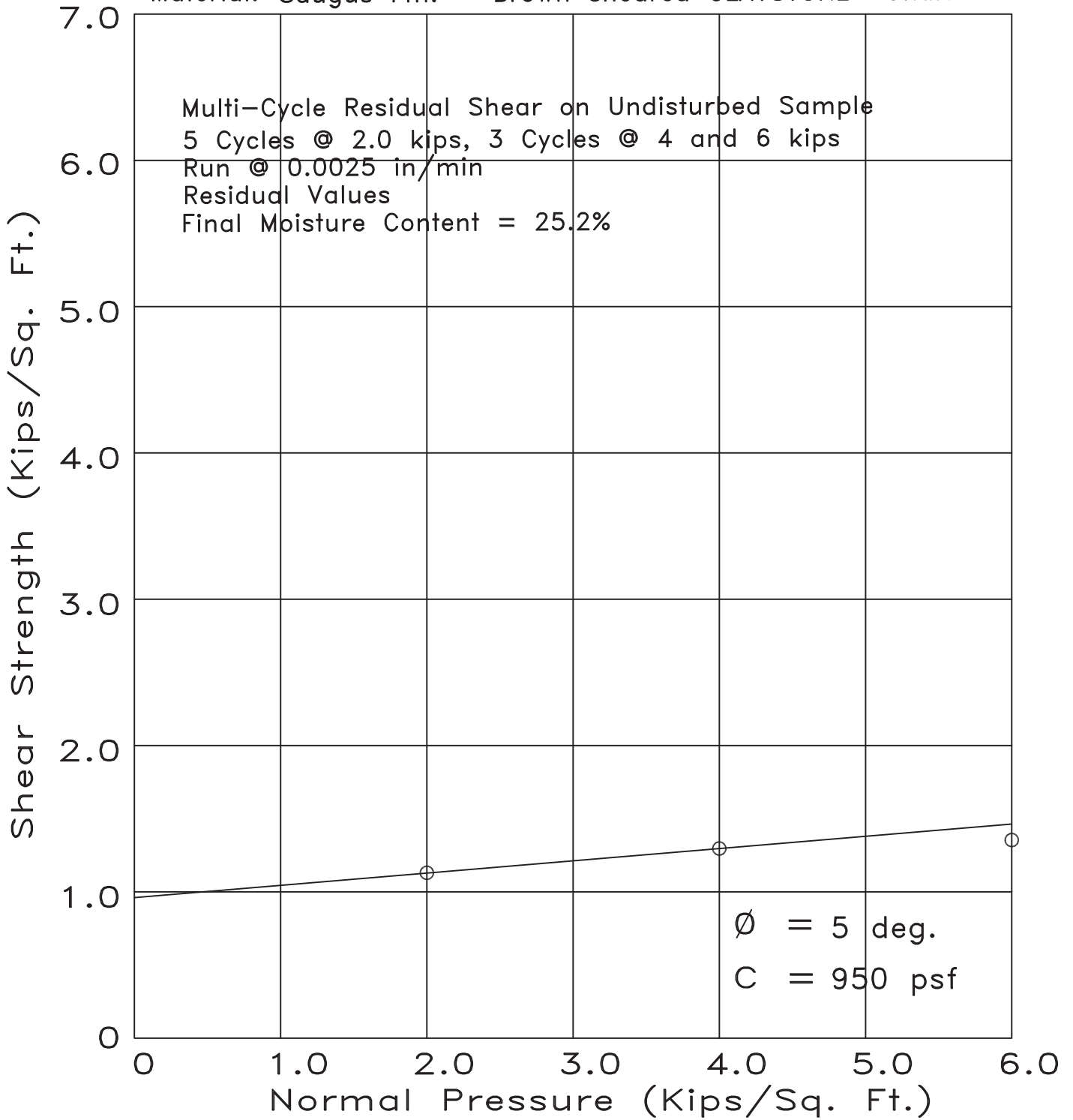

Project Tr. 060922 Skyline Ranch
 Excavation B48
 Depth 120 Feet



Geolabs - Westlake Village
 GEOLOGY AND SOIL ENGINEERING

DATE _____ BY _____
 SCALE _____ w.o. 8838

Excavation: B48

Depth: 120 ft

Sample Description: Brown CLAYSTONE

Displacement Rate: 0.0025 in/min

SHEARS 2K, 4K, & 6K NORMAL LOADS Undisturbed, Sat at 25.2 %

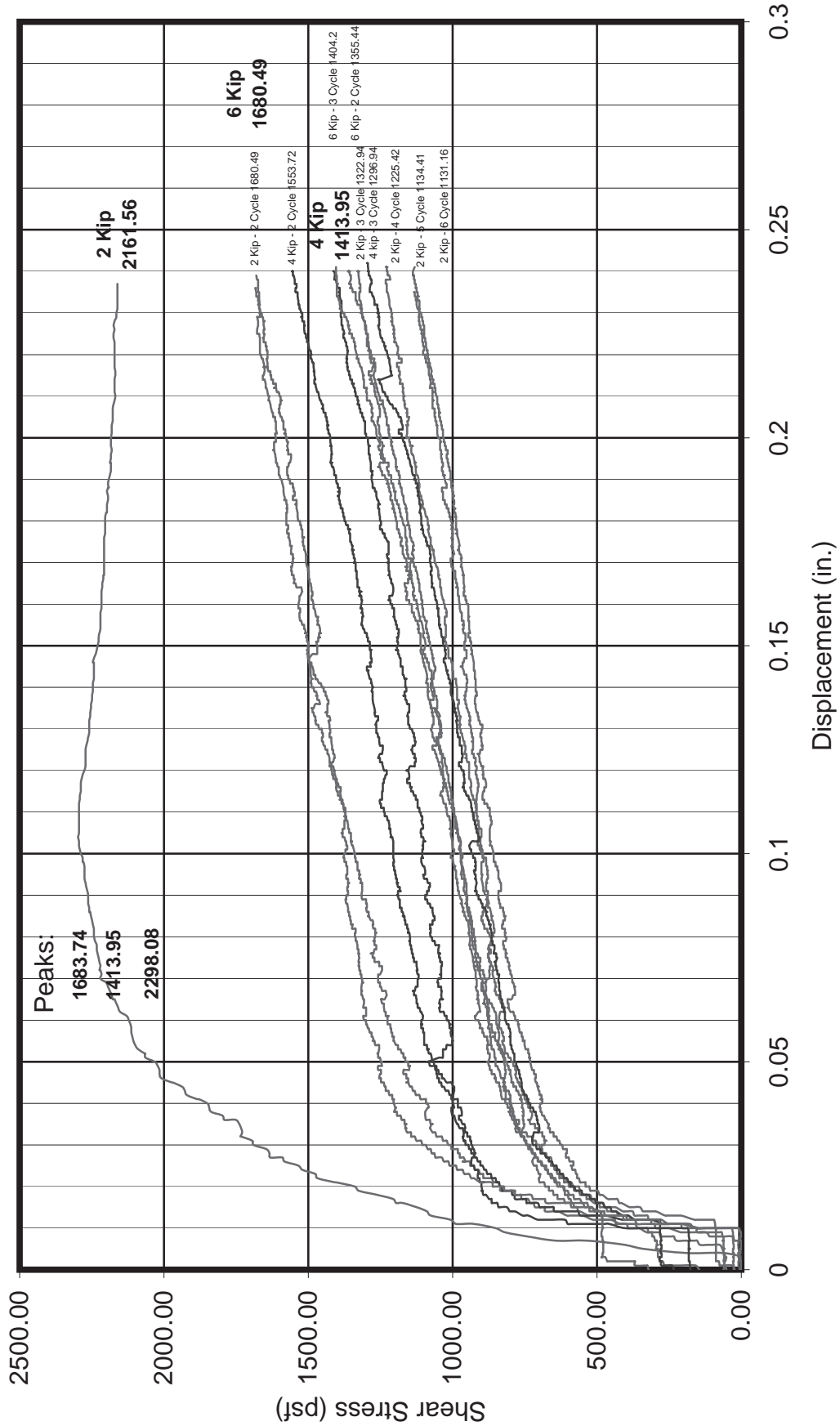

SHEAR TEST DIAGRAM

Material: Saugus Fm. – Clayey SANDSTONE Undisturbed

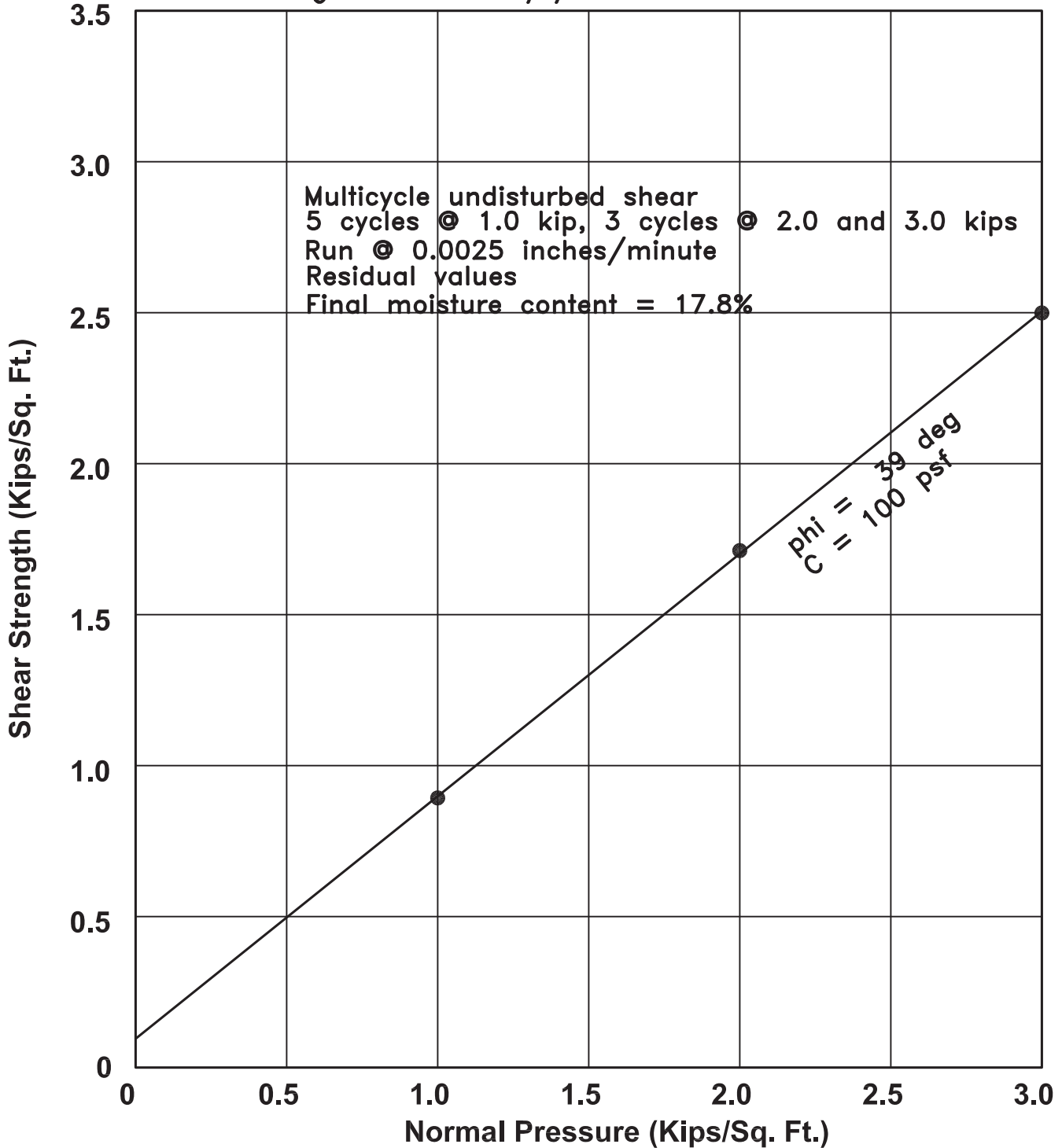

Project Skyline Ranch
 Excavation B49
 Depth 50'



Geolabs – Westlake Village
 GEOLOGY AND SOIL ENGINEERING

BY AJH
 DATE _____ W.O. 8838

Excavation: B49

Depth: 50 ft

Sample Description: Light brown fine sandy silty clay

Displacement Rate: 0.0025 in/min

SHEARS
1K, 2K, & 3K NORMAL LOADS
Undisturbed, Sat at 17.8 %

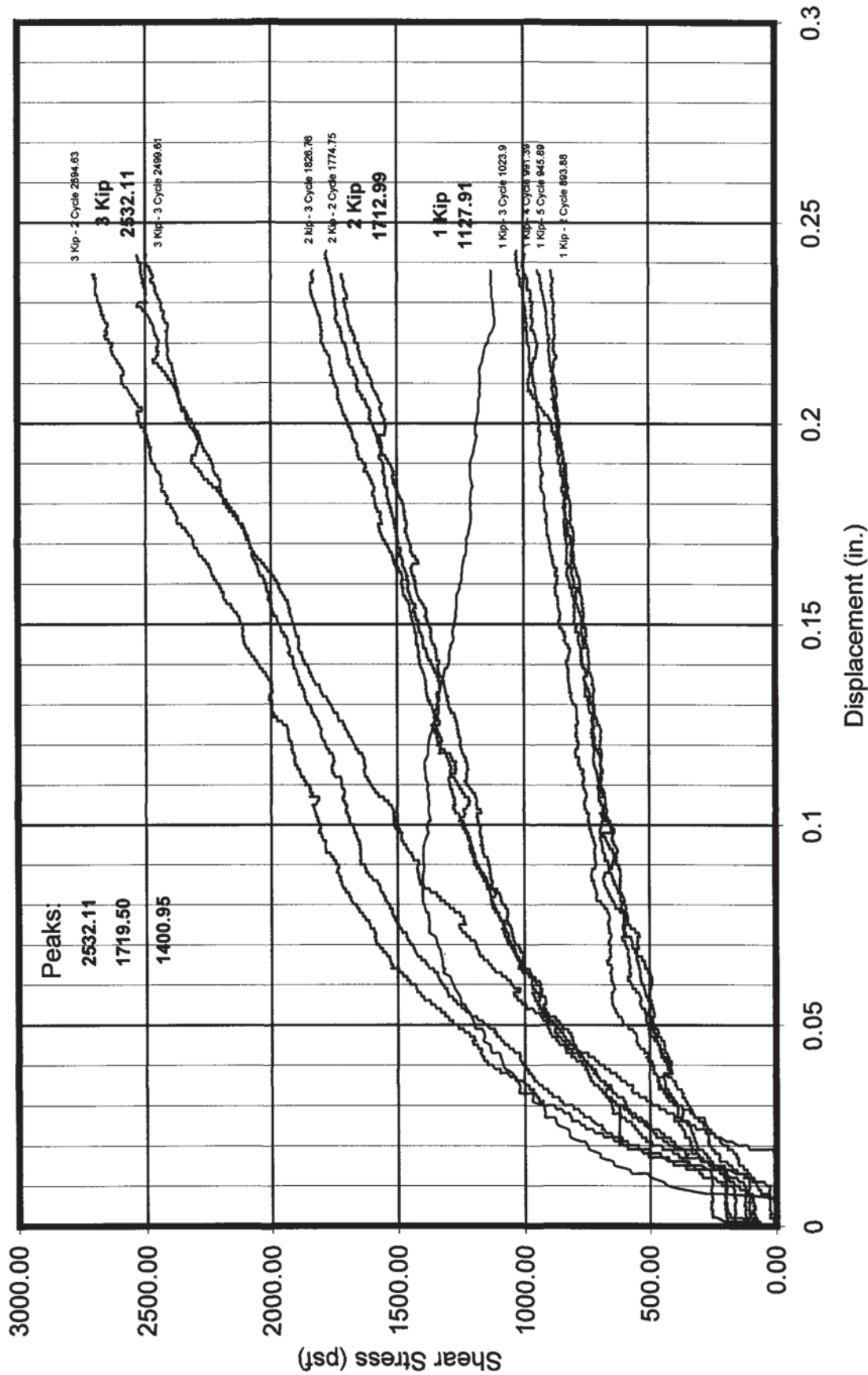

SHEAR TEST DIAGRAM

Material: Mint Canyon Fm. - Clayey fine-gr. SANDSTONE Remolded

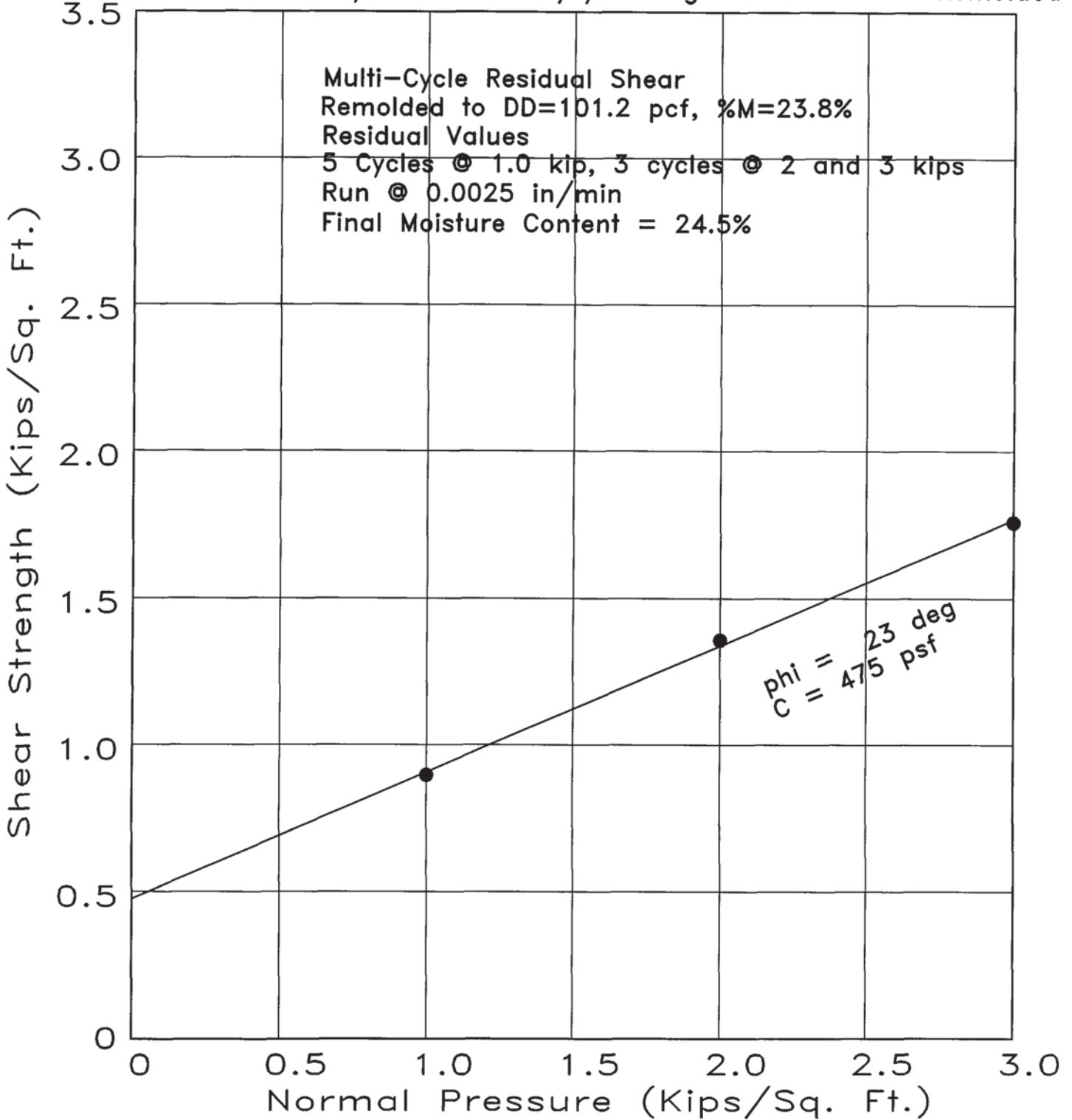

Project Tr. 060922 Skyline Ranch
 Excavation B50
 Depth 39 Feet



Geolabs - Westlake Village
 GEOLOGY AND SOIL ENGINEERING

BY DS
 DATE _____ W.O. 8838

Excavation: B50

Depth: 39 ft

Sample Description:

Displacement Rate: 0.00250 in/min

SHEARS
1K, 2K, & 3K NORMAL LOADS
 Remolded, Sat at 24.5 %

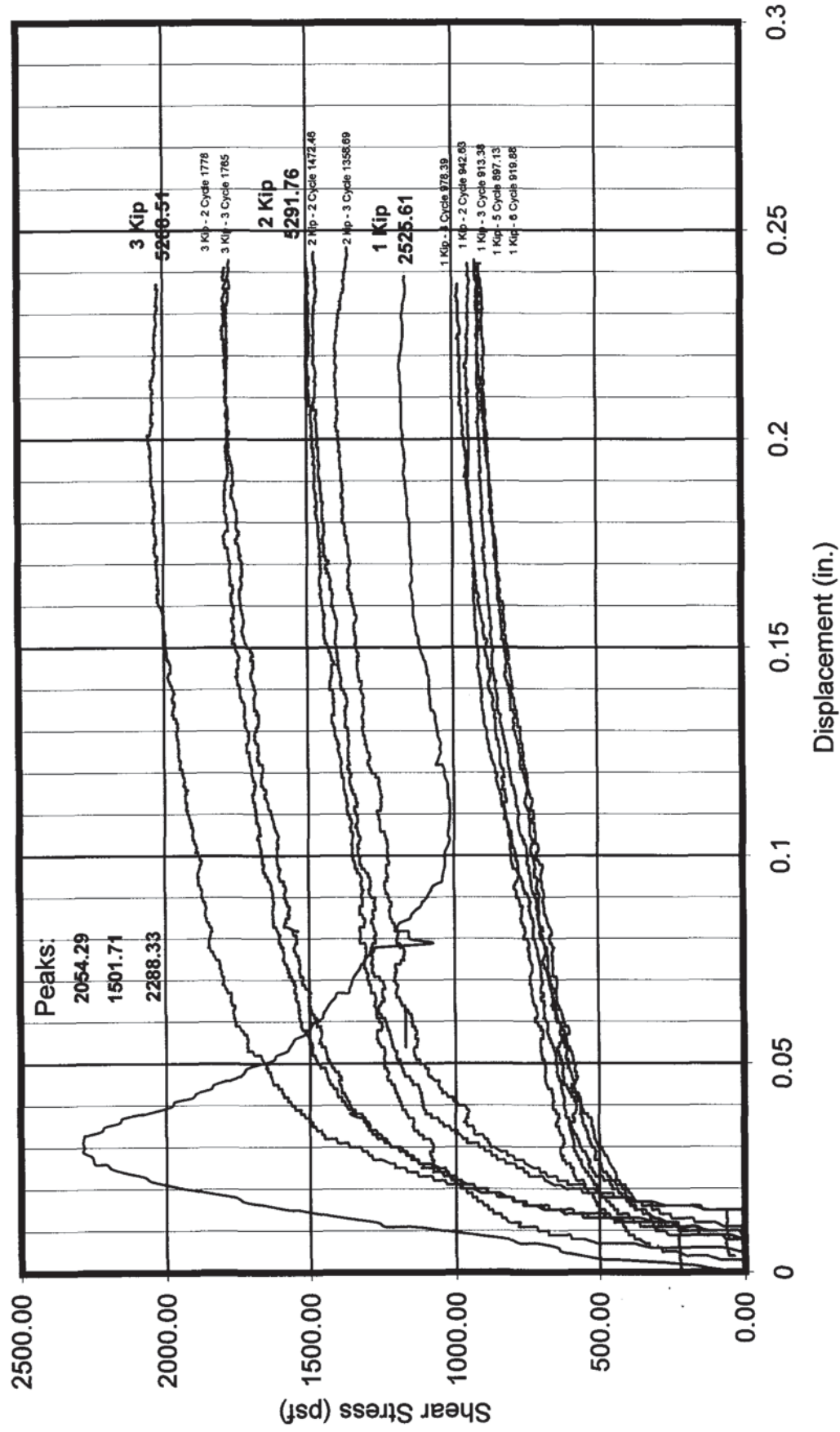

SHEAR TEST DIAGRAM

Material: Landslide Plane - Reddish brown CLAY Remolded

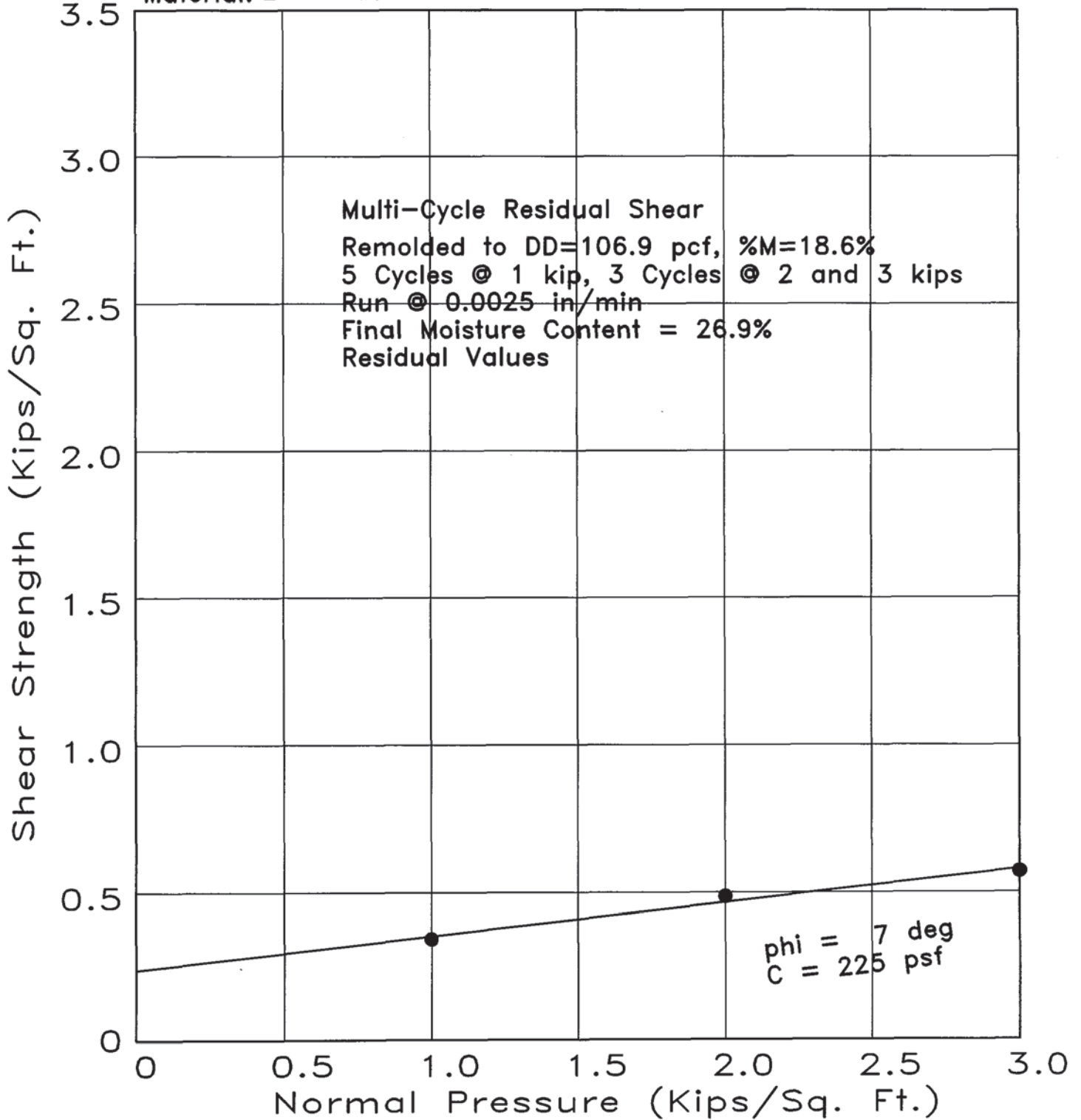

Project Tr. 60922, Skyline Ranch
 Excavation B51
 Depth 29.3 Feet



Geolabs - Westlake Village
 GEOLOGY AND SOIL ENGINEERING

BY DS
 DATE _____ W.O. 8838

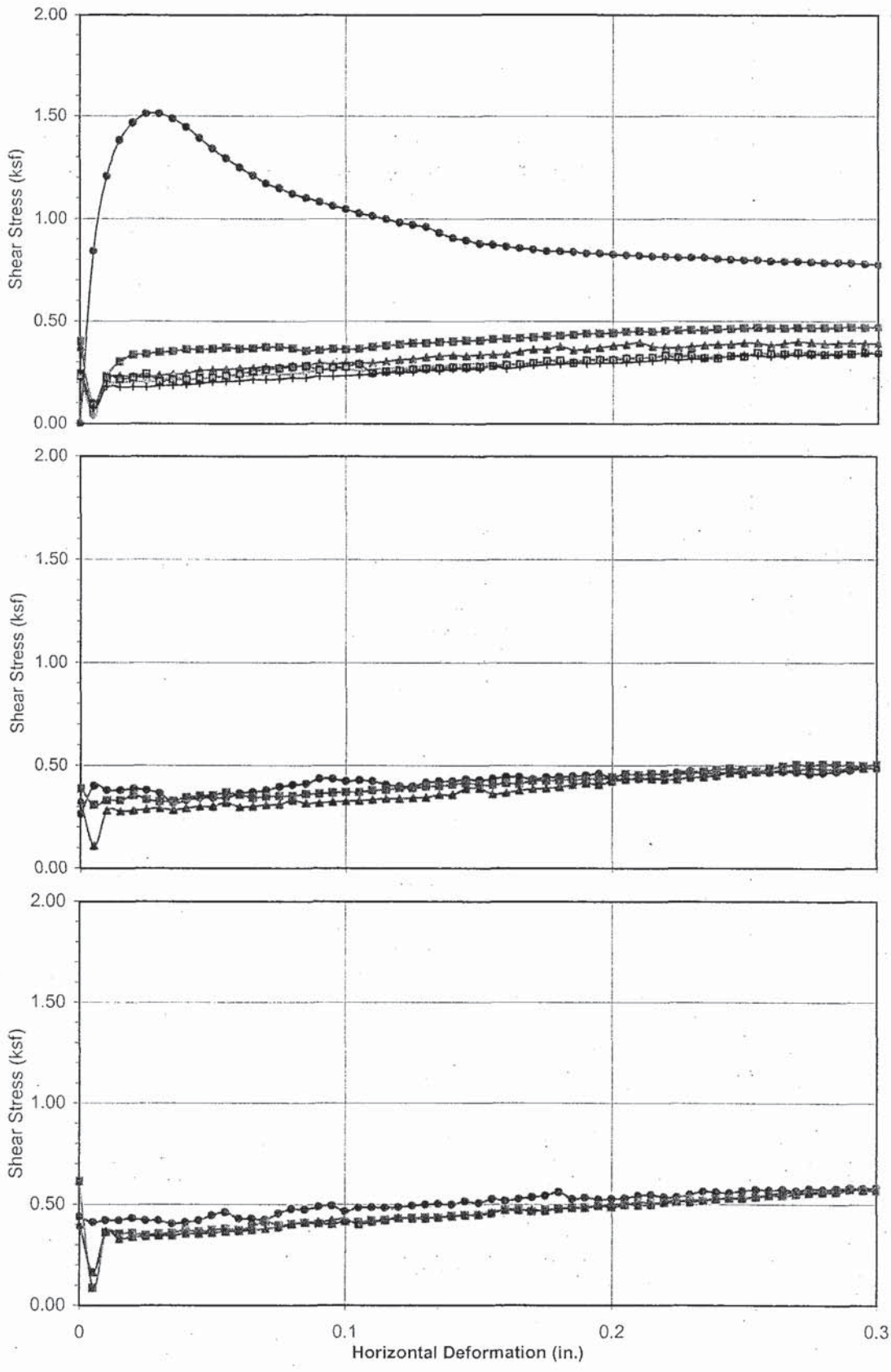

Normal Stress (ksf)	
1.00	
Shear Stress @ End of Pass (ksf)	
Forward Pass No.	Shear Stress (ksf)
● 1	0.776
■ 2	0.471
▲ 3	0.390
◆ 4	0.346
+ 5	0.340
□ 6	0.343

Normal Stress (ksf)	
2.00	
Shear Stress @ End of Pass (ksf)	
Forward Pass No.	Shear Stress (ksf)
● 7	0.486
■ 8	0.508
▲ 9	0.489

Normal Stress (ksf)	
3.00	
Shear Stress @ End of Pass (ksf)	
Forward Pass No.	Shear Stress (ksf)
● 10	0.583
■ 11	0.571
▲ 12	0.571

Pass 1 0.01"/min
Pass 2-12 0.0025"/min

DIRECT SHEAR TEST RESULTS
Consolidated Drained - ASTM D 3080



Boring No.: 51
Sample No.: N/A
Depth (ft): 29.3
Soil Type: Remold
Soil Description: Reddish Brown Lean Clay (CL)

Project No.: 8838.002

Skyline Ranch

09-06

SHEAR TEST DIAGRAM

Material: Saugus Formation - Brown CLAYSTONE

Remolded

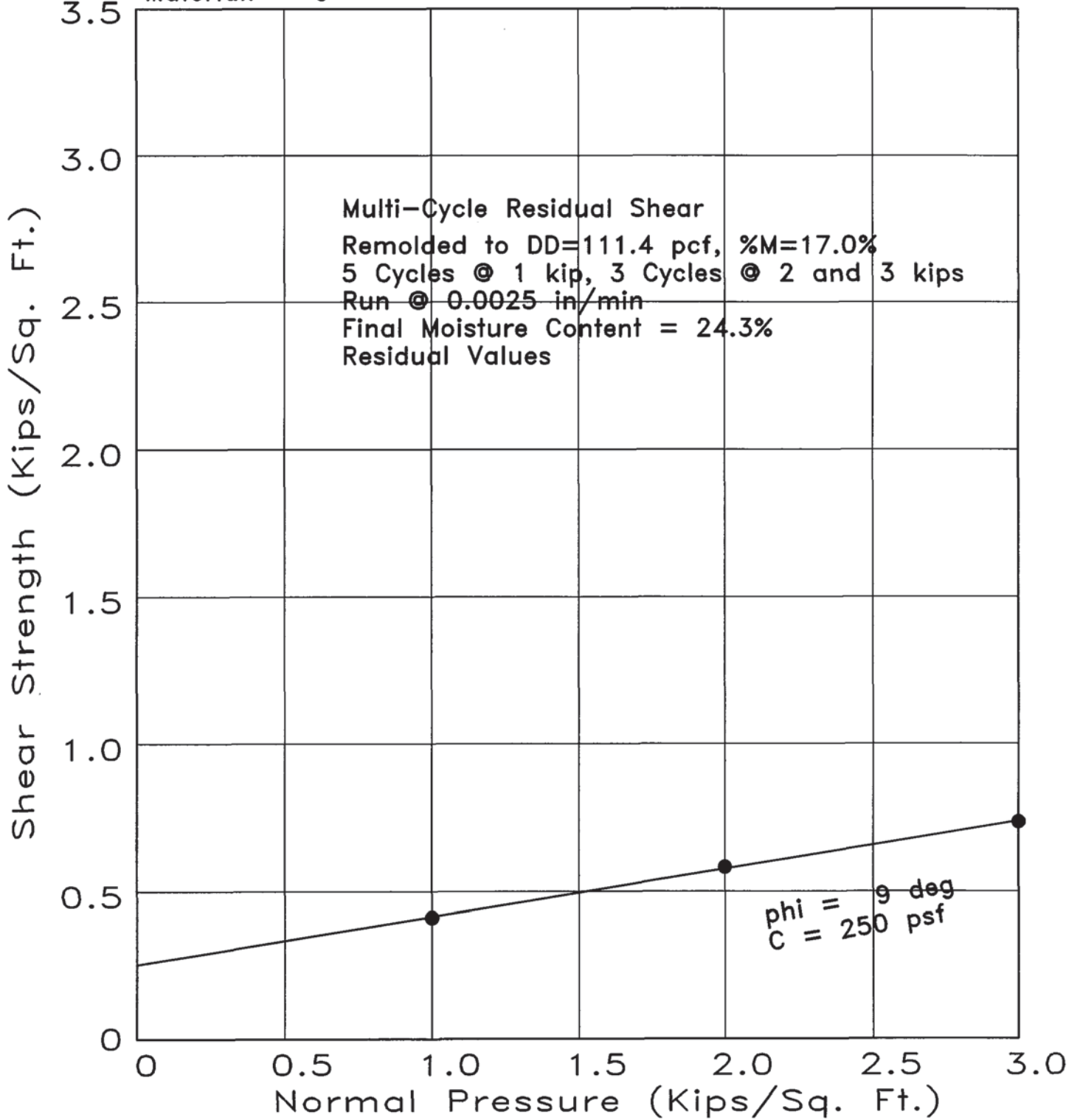

Project Tr. 60922, Skyline Ranch
 Excavation B53
 Depth 30 Feet



Geolabs - Westlake Village
 GEOLOGY AND SOIL ENGINEERING

BY DS
 DATE _____ W.O. 8838

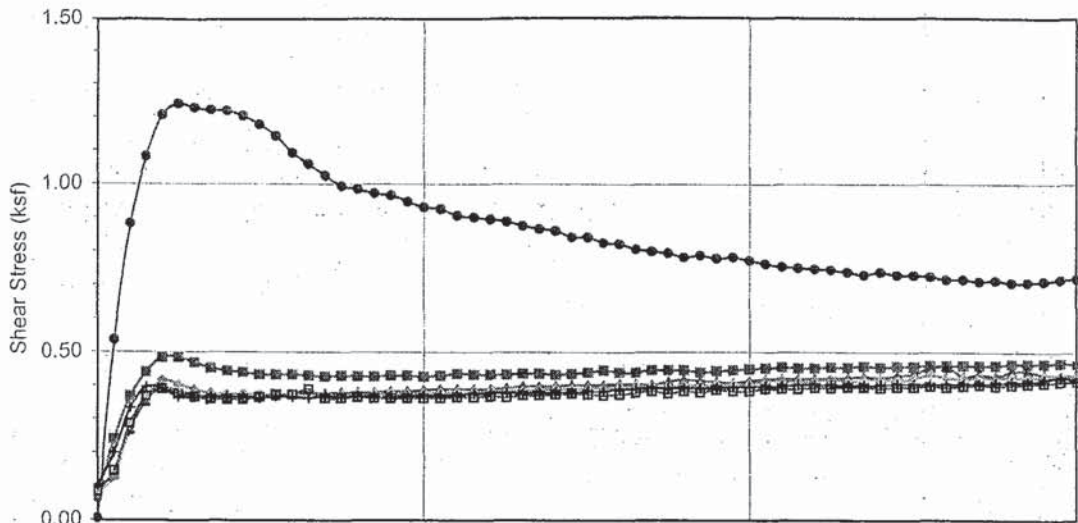

Normal Stress (ksf)	
1.00	
Shear Stress @ End of Pass (ksf)	
Forward Pass No.	Shear Stress (ksf)
● 1	0.720
■ 2	0.465
▲ 3	0.430
◆ 4	0.430
+ 5	0.415
□ 6	0.412

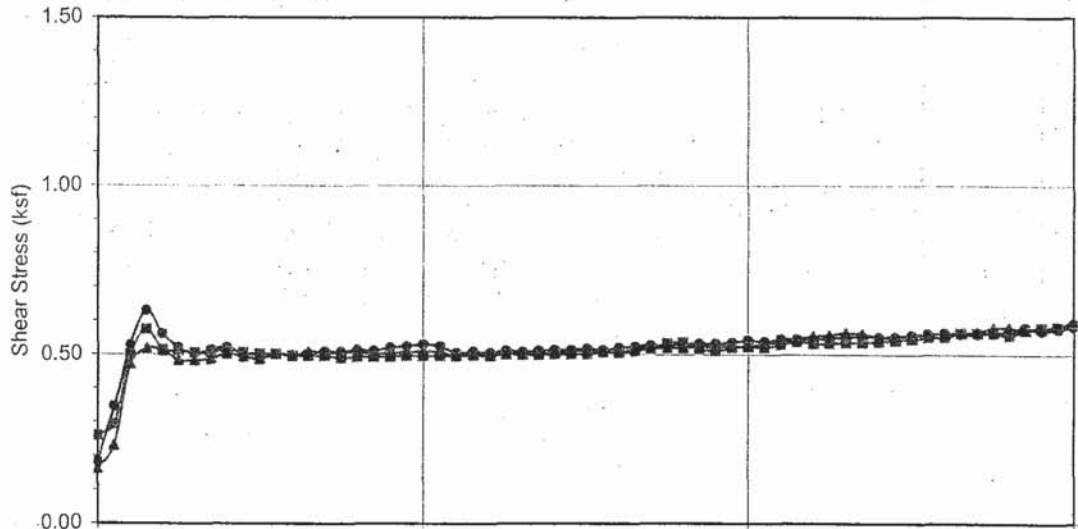

Normal Stress (ksf)	
2.00	
Shear Stress @ End of Pass (ksf)	
Forward Pass No.	Shear Stress (ksf)
● 7	0.583
■ 8	0.592
▲ 9	0.599

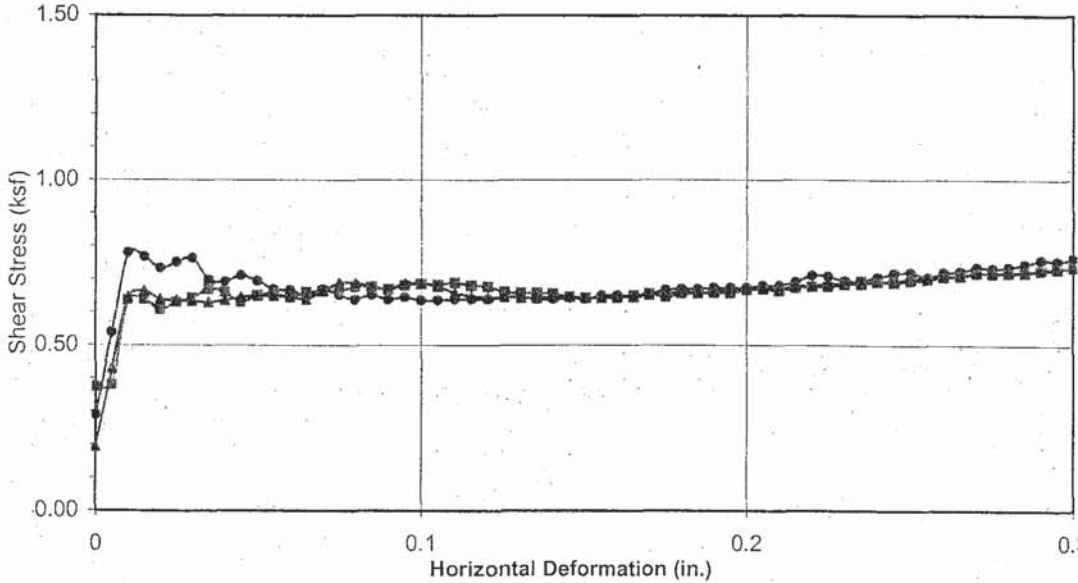

Normal Stress (ksf)	
3.00	
Shear Stress @ End of Pass (ksf)	
Forward Pass No.	Shear Stress (ksf)
● 10	0.764
■ 11	0.736
▲ 12	0.736
Pass 1	0.01"/min
Pass 2-12	0.0025"/min

DIRECT SHEAR TEST RESULTS
Consolidated Drained - ASTM D 3080



Boring No.: 53
 Sample No.: N/A
 Depth (ft): 30
 Soil Type: Remold
 Soil Description: Reddish Brown Lean Clay (CL)

Project No.: 8838.002

Skyline Ranch

09-06

SHEAR TEST DIAGRAM

Material: **Landslide Shear - CLAY**

Remolded

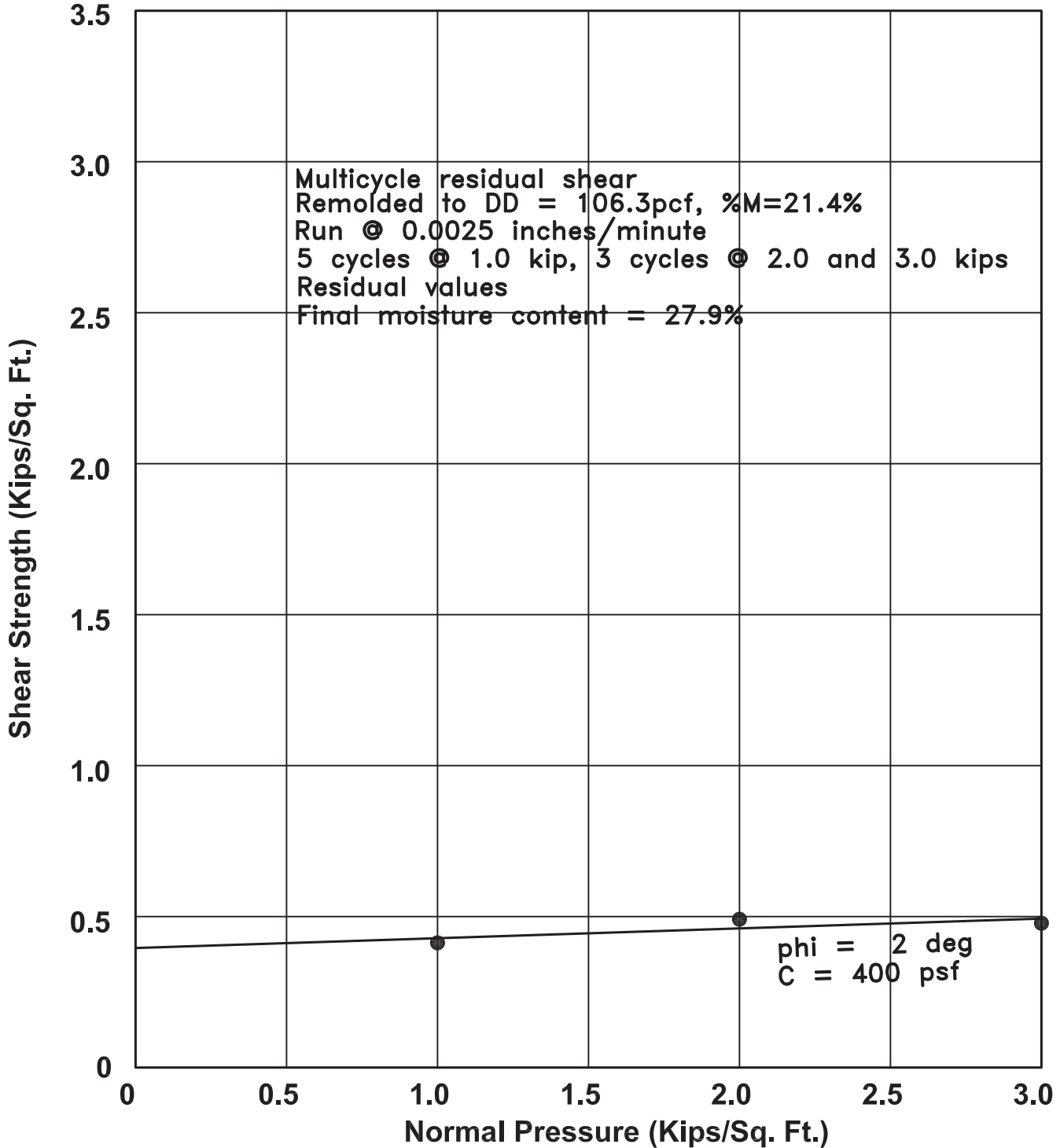

Project Skyline Ranch
 Excavation B54
 Depth 56.5'



Geolabs - Westlake Village
 GEOLOGY AND SOIL ENGINEERING

BY AJH
 DATE _____ W.O. 8838

Excavation: B54 Depth: 56 ft Sample Description: Light reddish brown silty clay Displacement Rate: 0.0025 in/min

SHEARS
1K, 2K, & 3K NORMAL LOADS
Remolded, Sat at 27.9 %

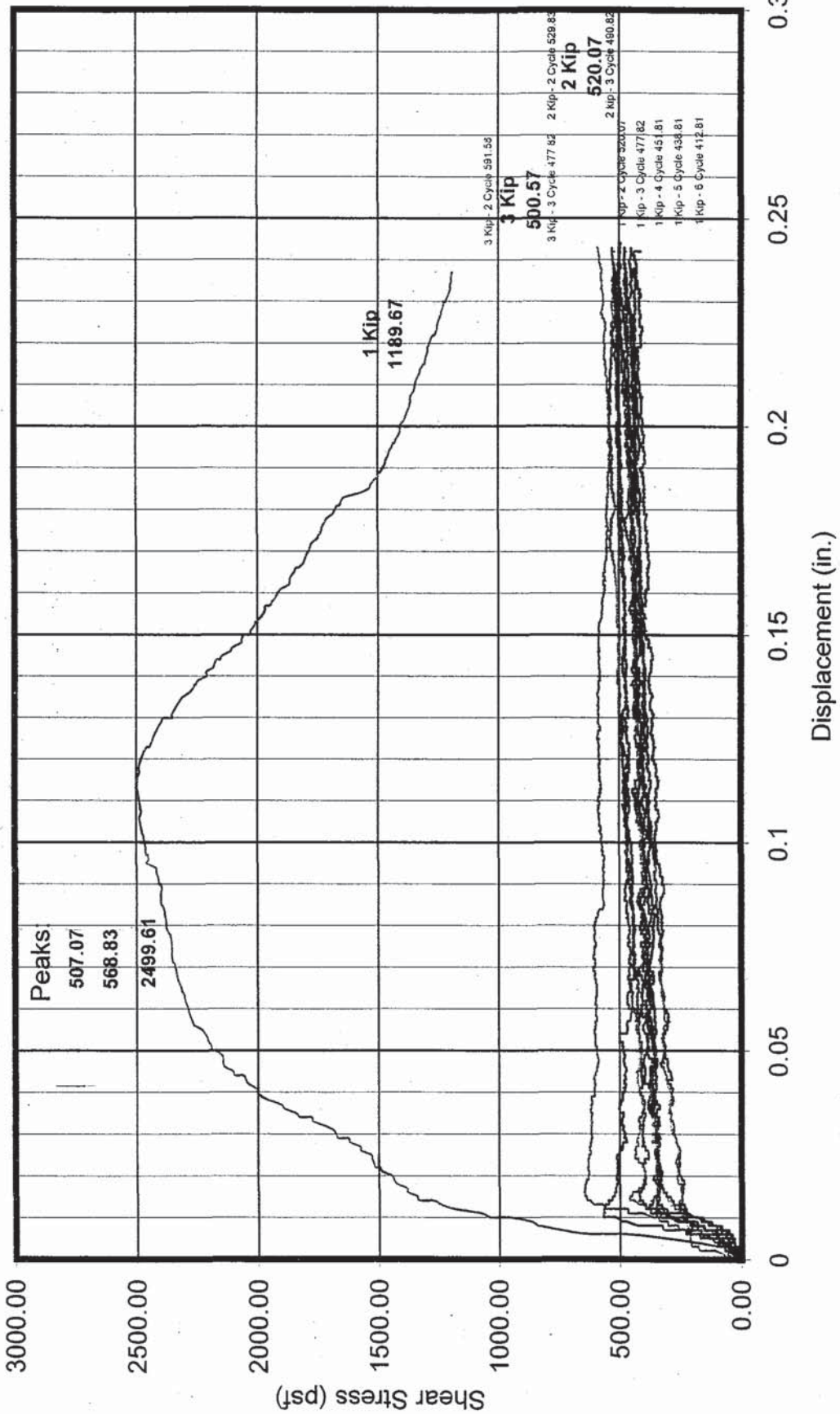

SHEAR TEST DIAGRAM

Material: Saugus Fm. – Silty CLAYSTONE

Undisturbed

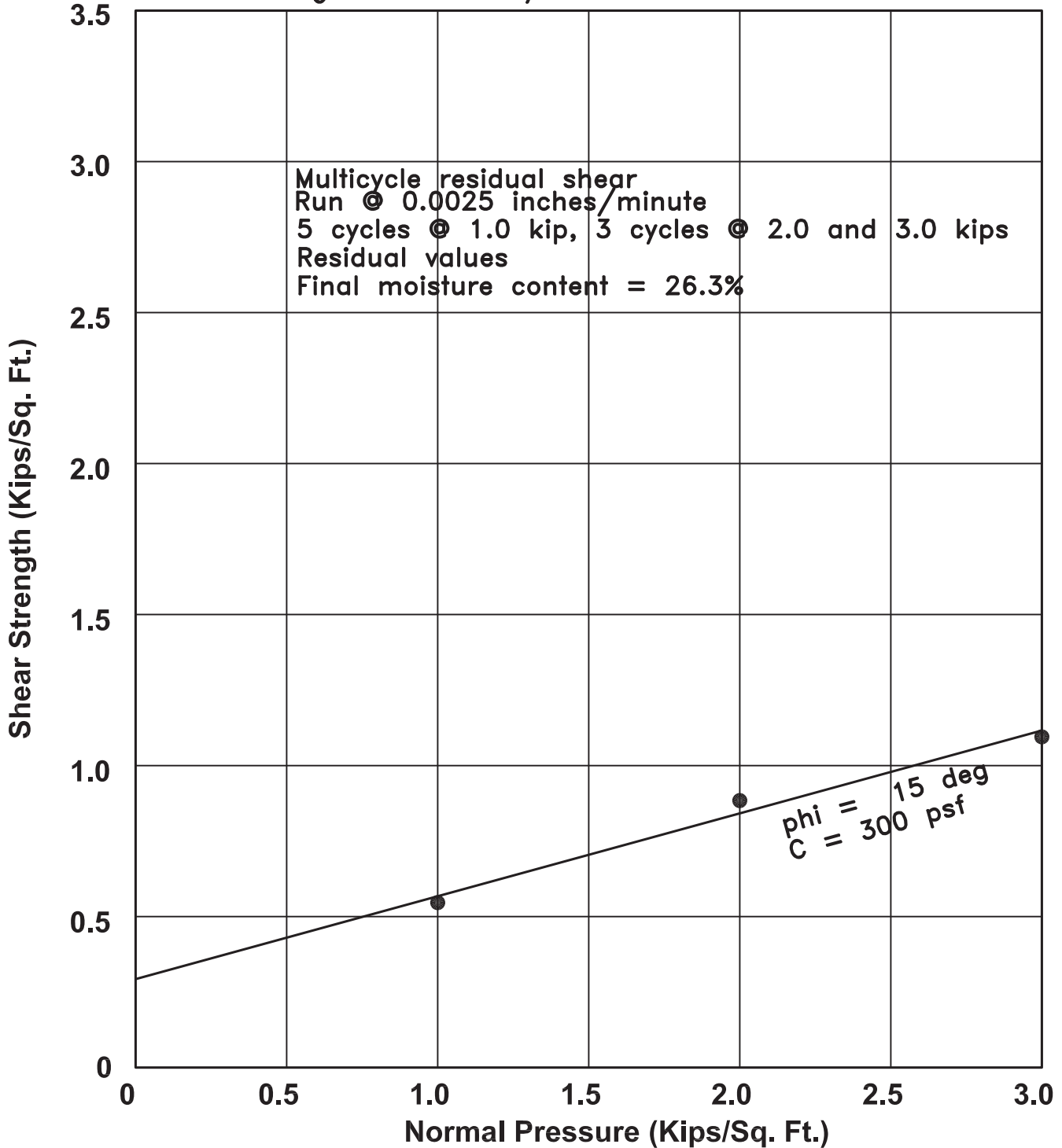

Project Skyline Ranch
 Excavation B62
 Depth 50'



Geolabs – Westlake Village
 GEOLOGY AND SOIL ENGINEERING

BY AJH
 DATE _____ W.O. 8838

Excavation: B62

Depth: 50 ft

Sample Description: Light yellowish brown fine sandy silty clay

Displacement Rate: 0.0025 in/min

SHEARS
1K, 2K, & 3K NORMAL LOADS
 Undisturbed, Sat at 26.3 %

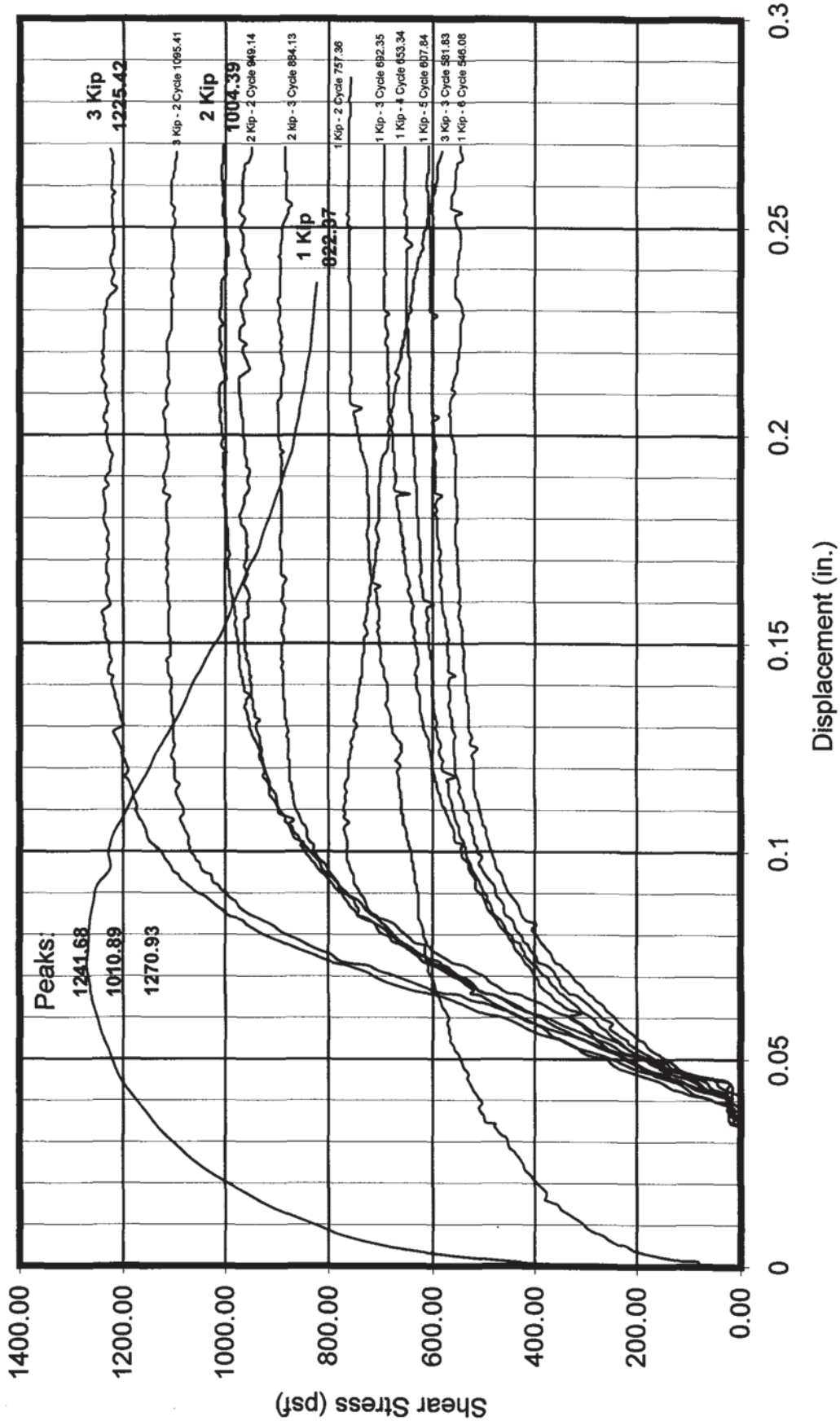

SHEAR TEST DIAGRAM

Material: Saugus Fm. - Silty Sandstone

Undisturbed

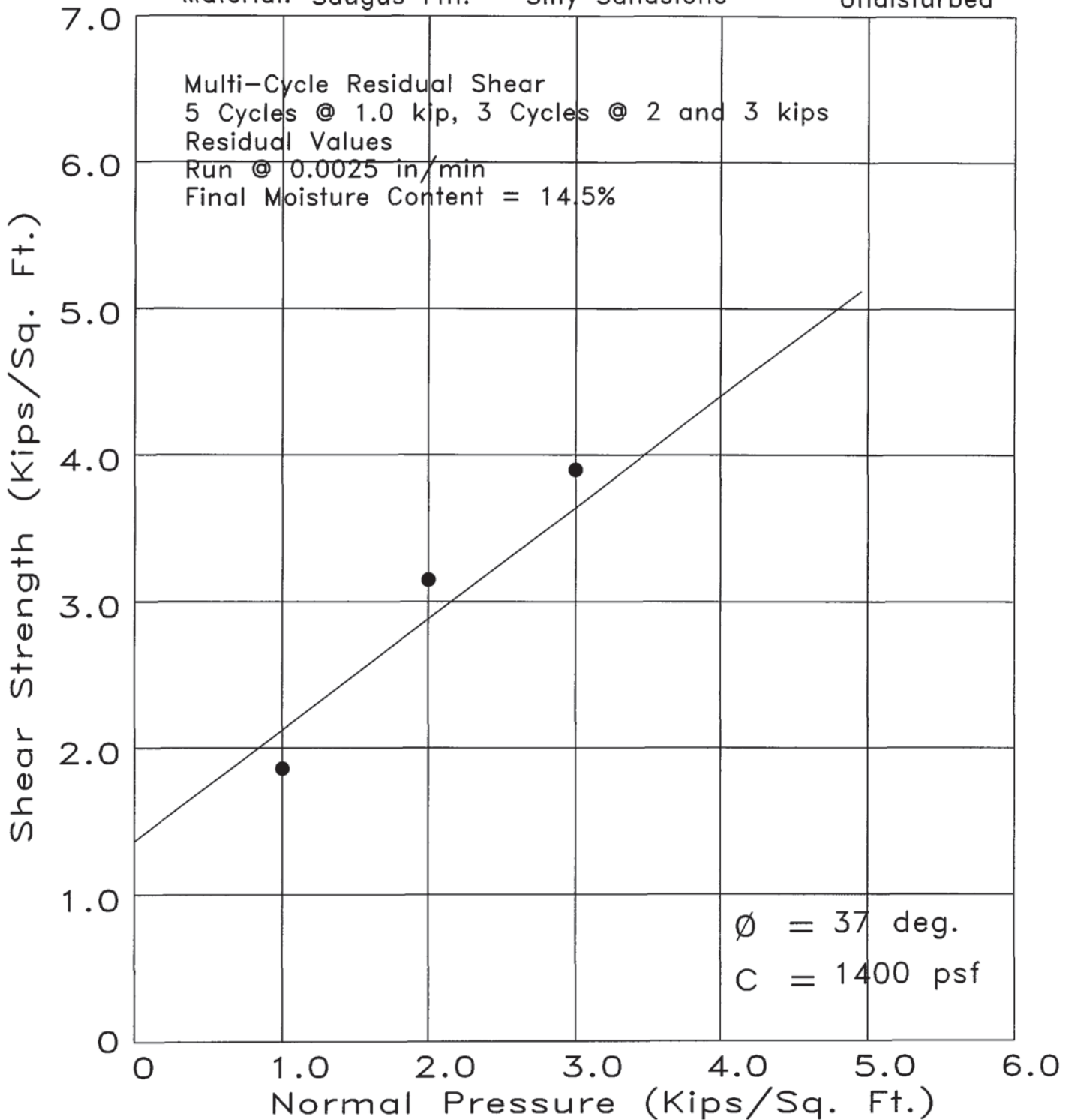

Project Tr. 060922 Skyline Ranch
 Excavation B66
 Depth 30 Feet



Geolabs - Westlake Village
 GEOLOGY AND SOIL ENGINEERING

DATE _____ BY DS
 SCALE _____ W.O. 8838

Excavation: B66

Depth: 30 ft

Sample Description: Graylish Clayed Silty f-c Sand

Displacement Rate: 0.0025 in/min

SHEARS
1K, 2K, & 3K NORMAL LOADS
Undisturbed, Sat at 14.5 %

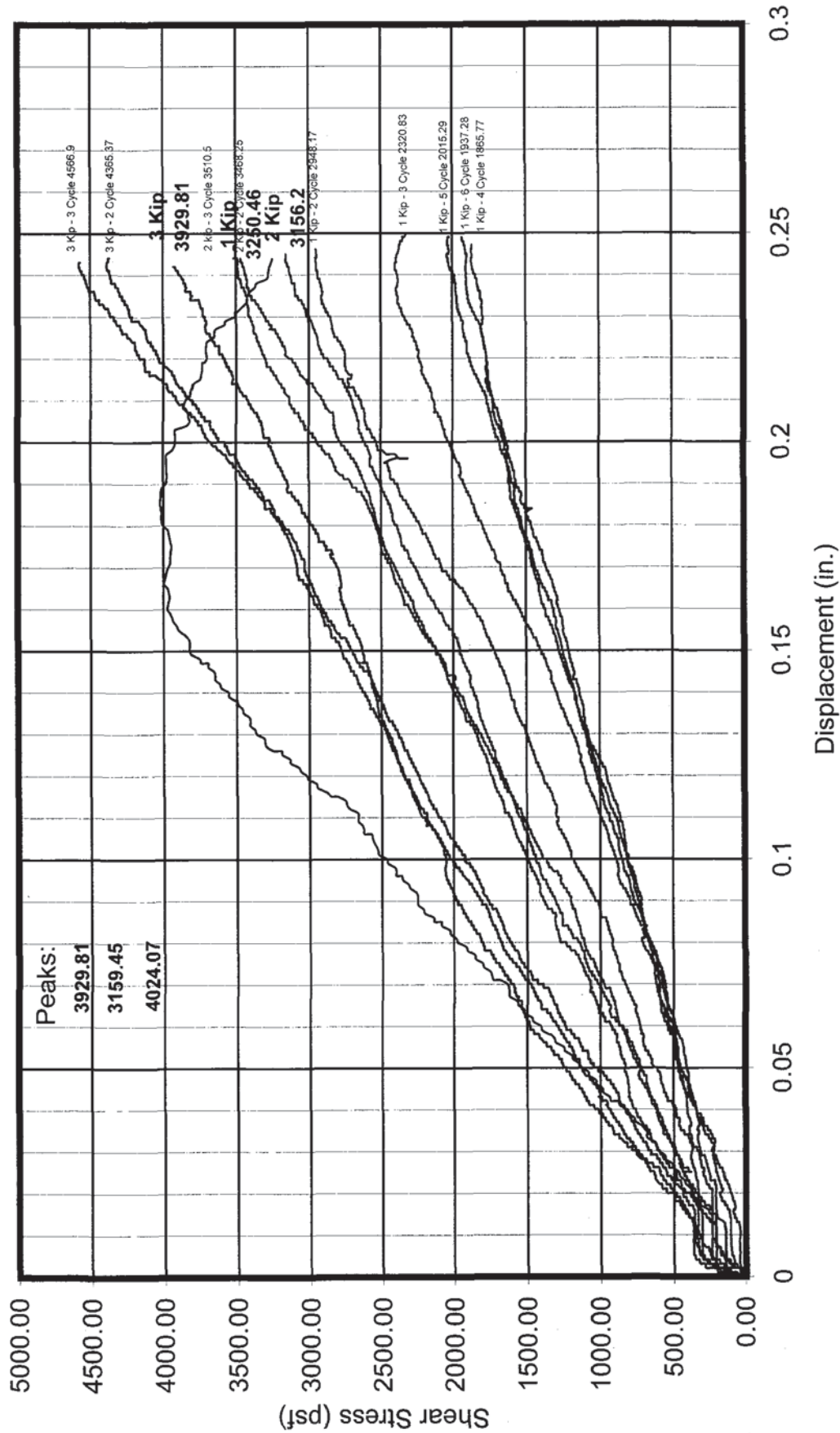

SHEAR TEST DIAGRAM

Material: Saugus Fm. - Yel-brn. sheared CLAYSTONE Remolded

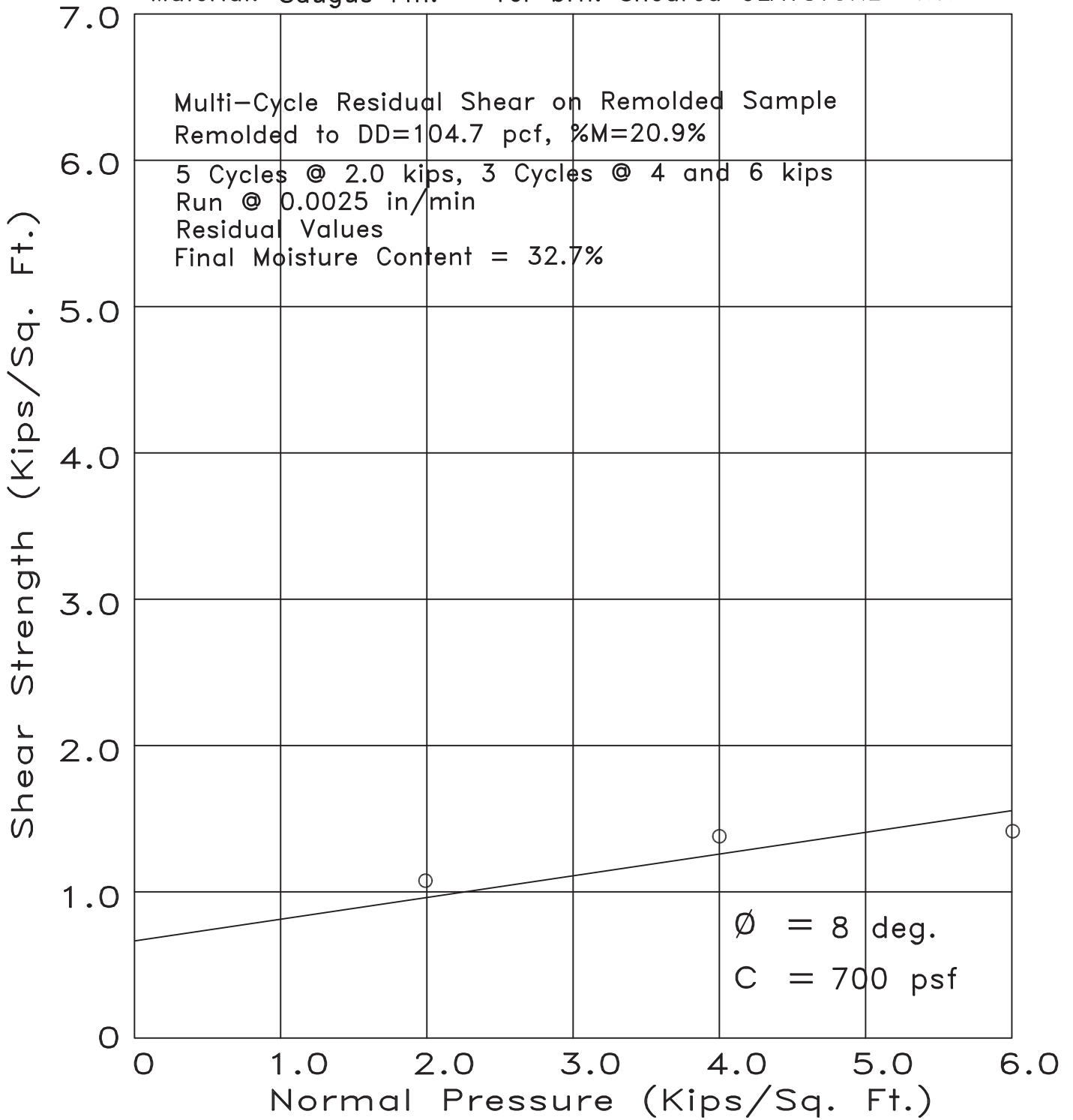

Project Tr. 060922 Skyline Ranch
Excavation B66
Depth 124.5 Feet



Geolabs - Westlake Village
GEOLOGY AND SOIL ENGINEERING

DATE _____ BY _____
SCALE _____ w.o. 8838

Excavation: B66

Depth: 124 ft

Sample Description: Yellowish brown CLAYSTONE

Displacement Rate: 0.0025 in/min

SHEARS
2K, 4K, & 6K NORMAL LOADS
Remolded, Sat at 20.9%

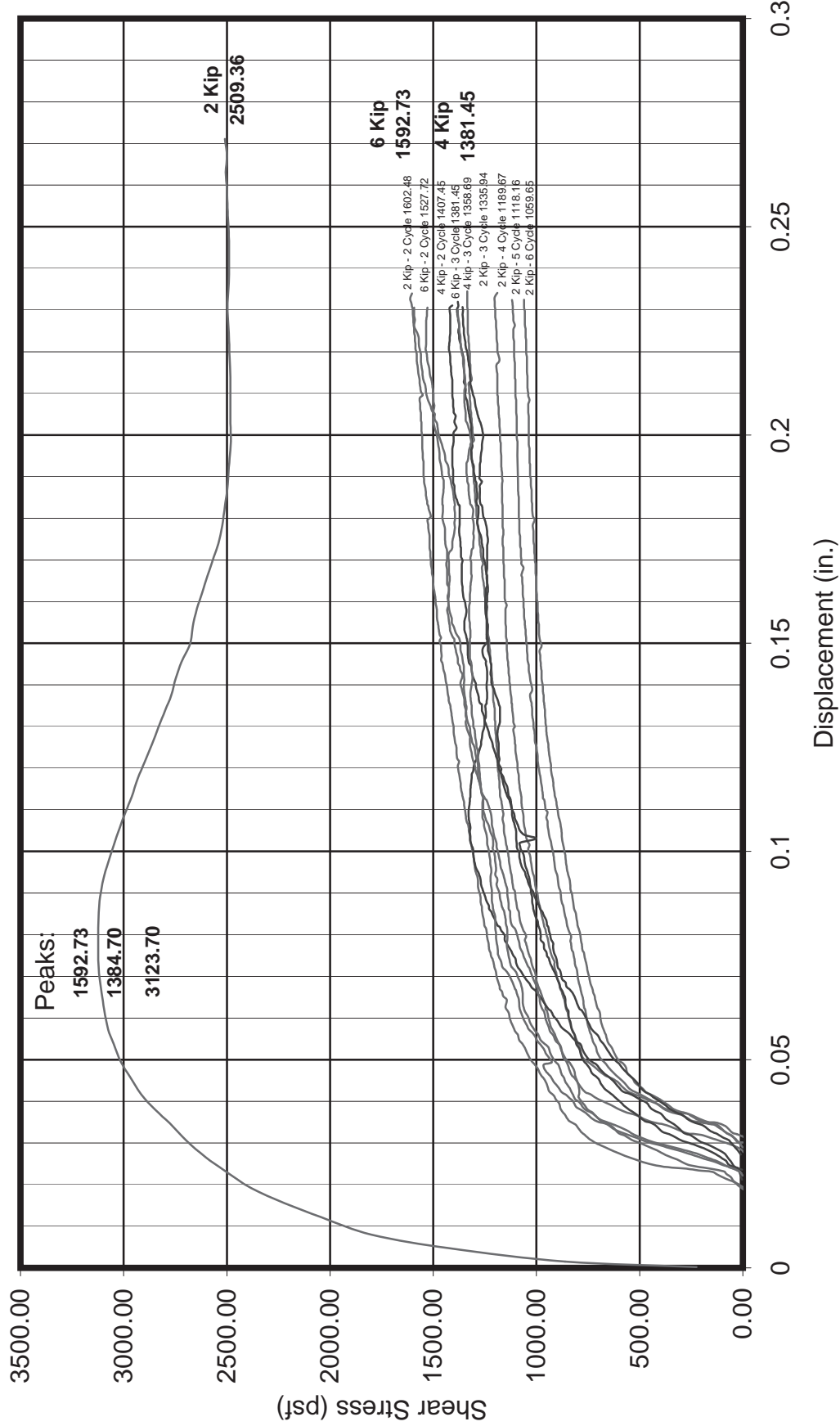

SHEAR TEST DIAGRAM

Material: Saugus Fm. - Sandy SILTSTONE Undisturbed

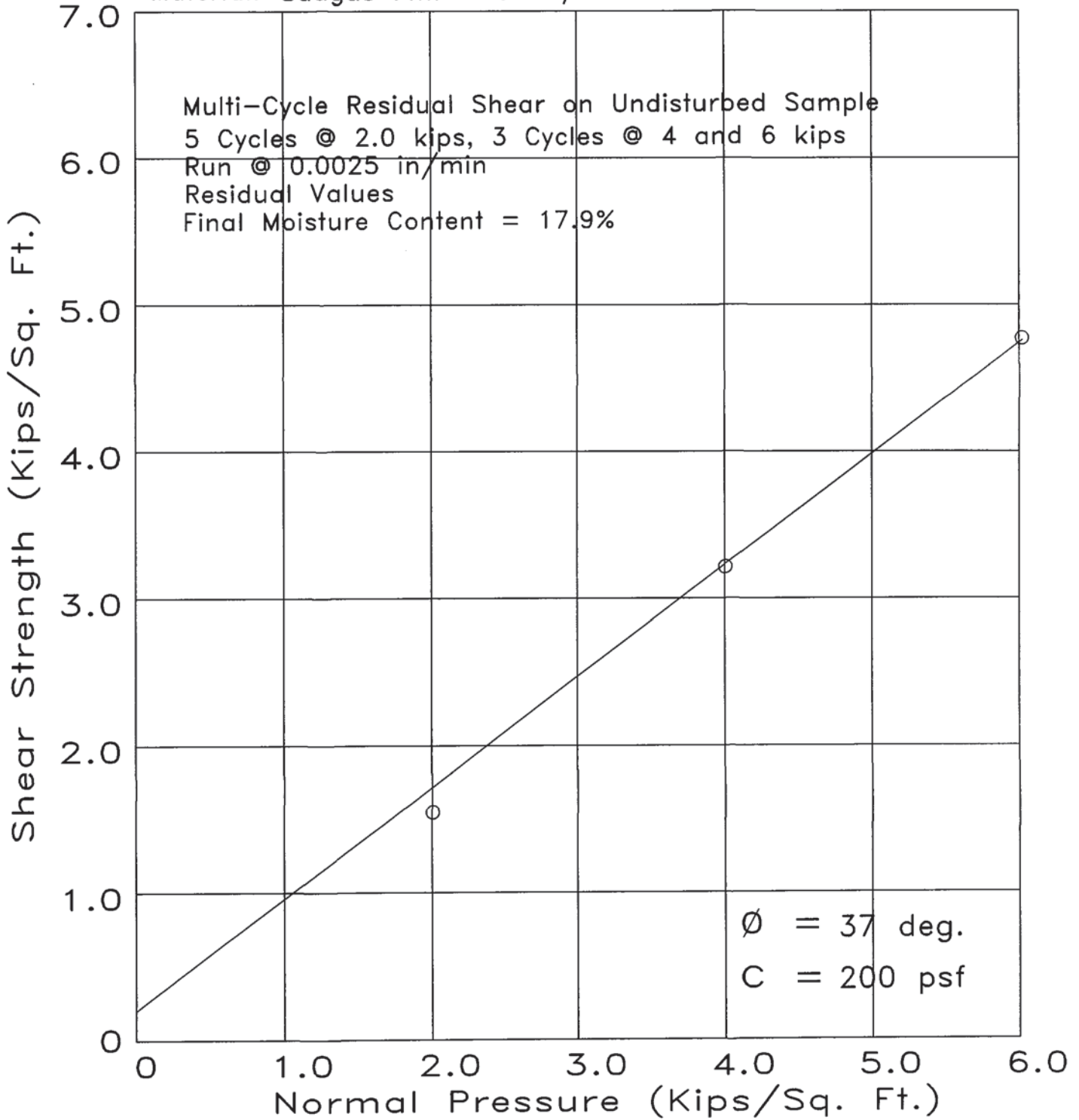

Project Tr. 060922 Skyline Ranch
 Excavation B78
 Depth 100 Feet



Geolabs - Westlake Village
 GEOLGY AND SOIL ENGINEERING

DATE _____ BY _____
 SCALE _____ w.o. 8838

Excavation: B78

Depth: 100 ft

Sample Description: Sandy SILTSTONE

Displacement Rate: 0.0025 in/min

SHEARS
2K, 4K, & 6K NORMAL LOADS
Undisturbed, Sat at 17.9 %

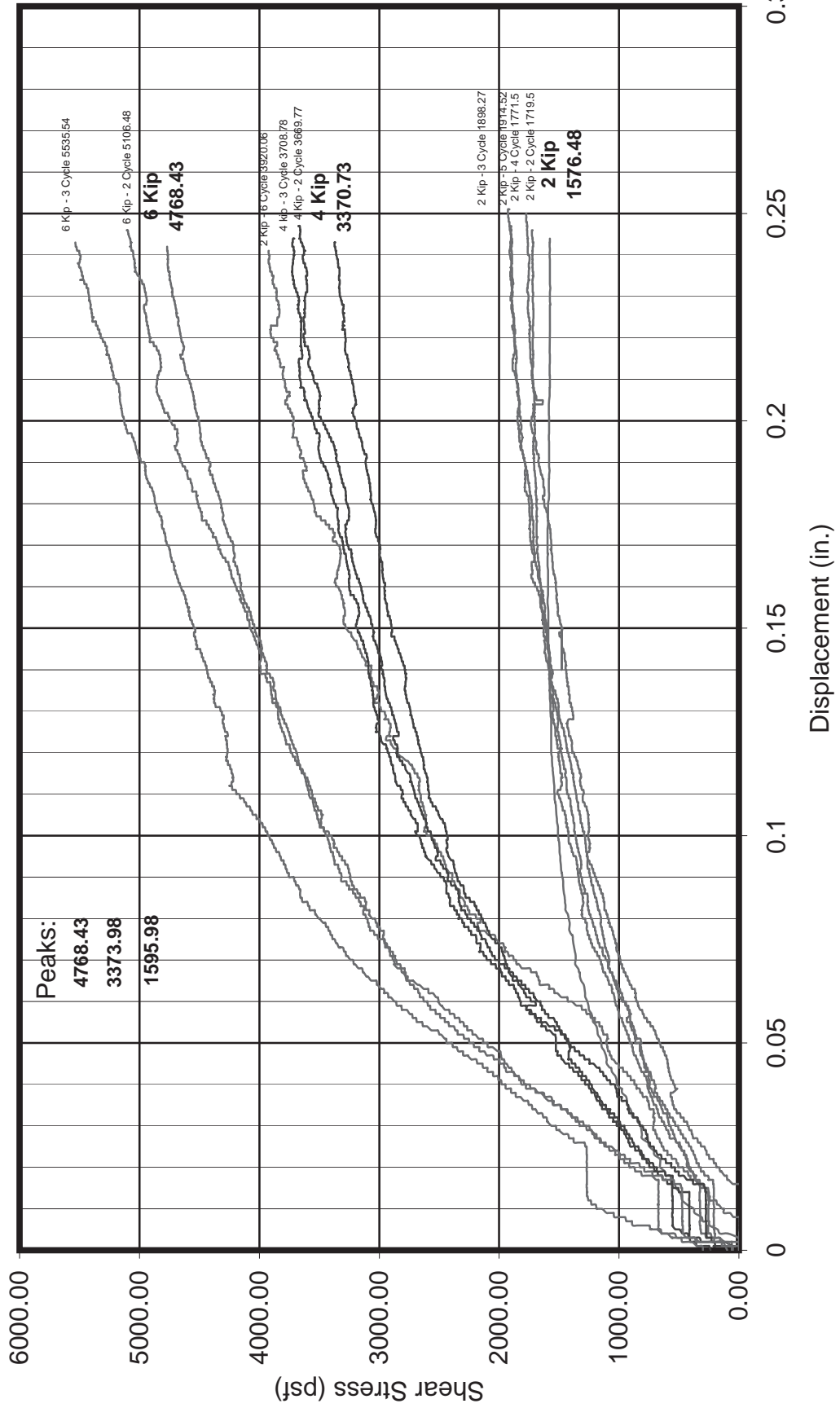

SHEAR TEST DIAGRAM

Material: Saugus Formation - Silty CLAYSTONE Undisturbed

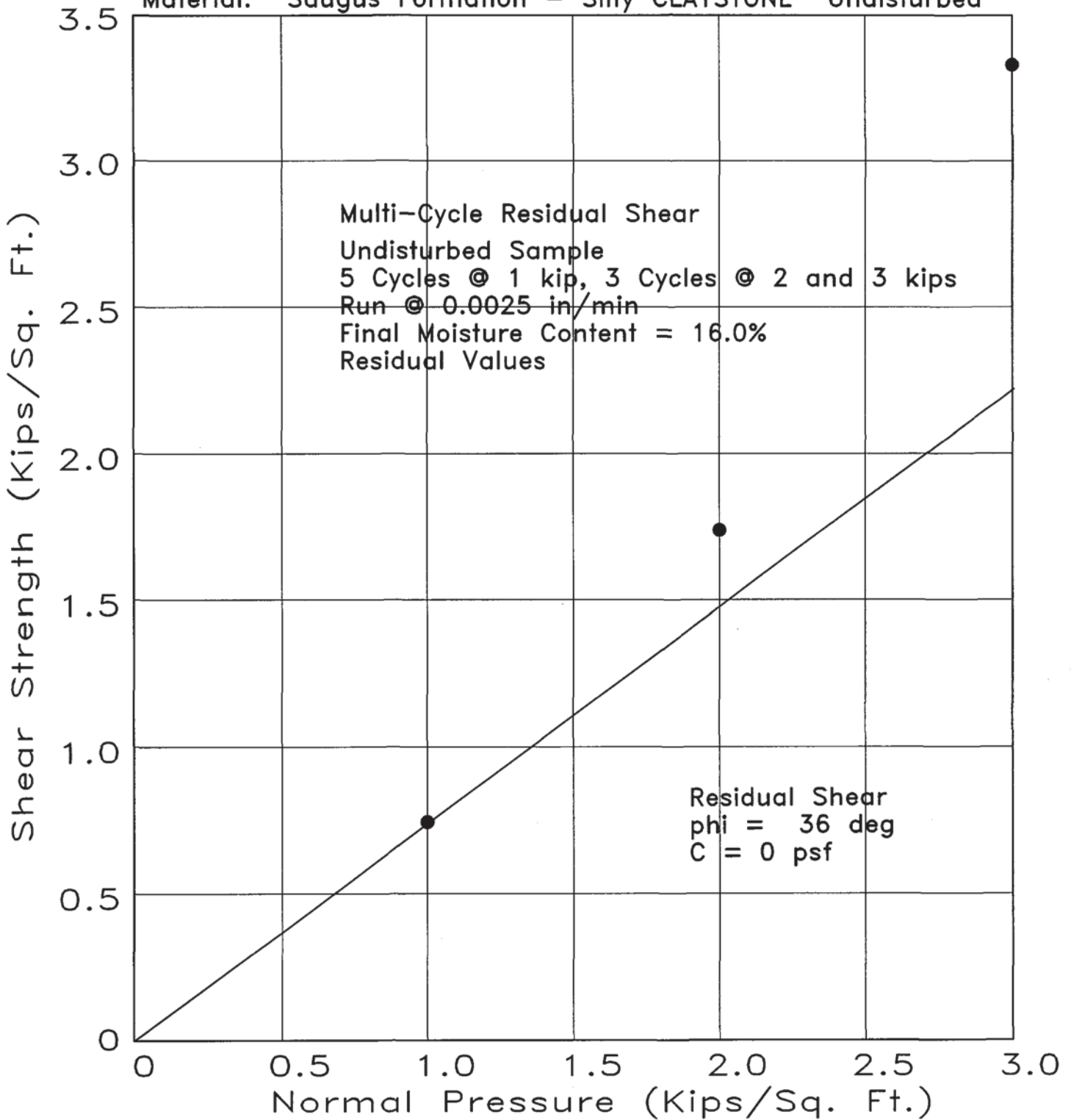

Project Tr. 60922, Skyline Ranch
Excavation B79
Depth 40 Feet



Geolabs - Westlake Village
GEOLOGY AND SOIL ENGINEERING

BY DS
DATE _____ W.O. 8838

Excavation: B79

Depth: 40 ft

Sample Description: Light Brown Fine Sand Silty Clay

Displacement Rate: 0.0025 in/min

SHEARS
1K, 3K, & 5K NORMAL LOADS
Undisturbed, Sat at 16.0 %

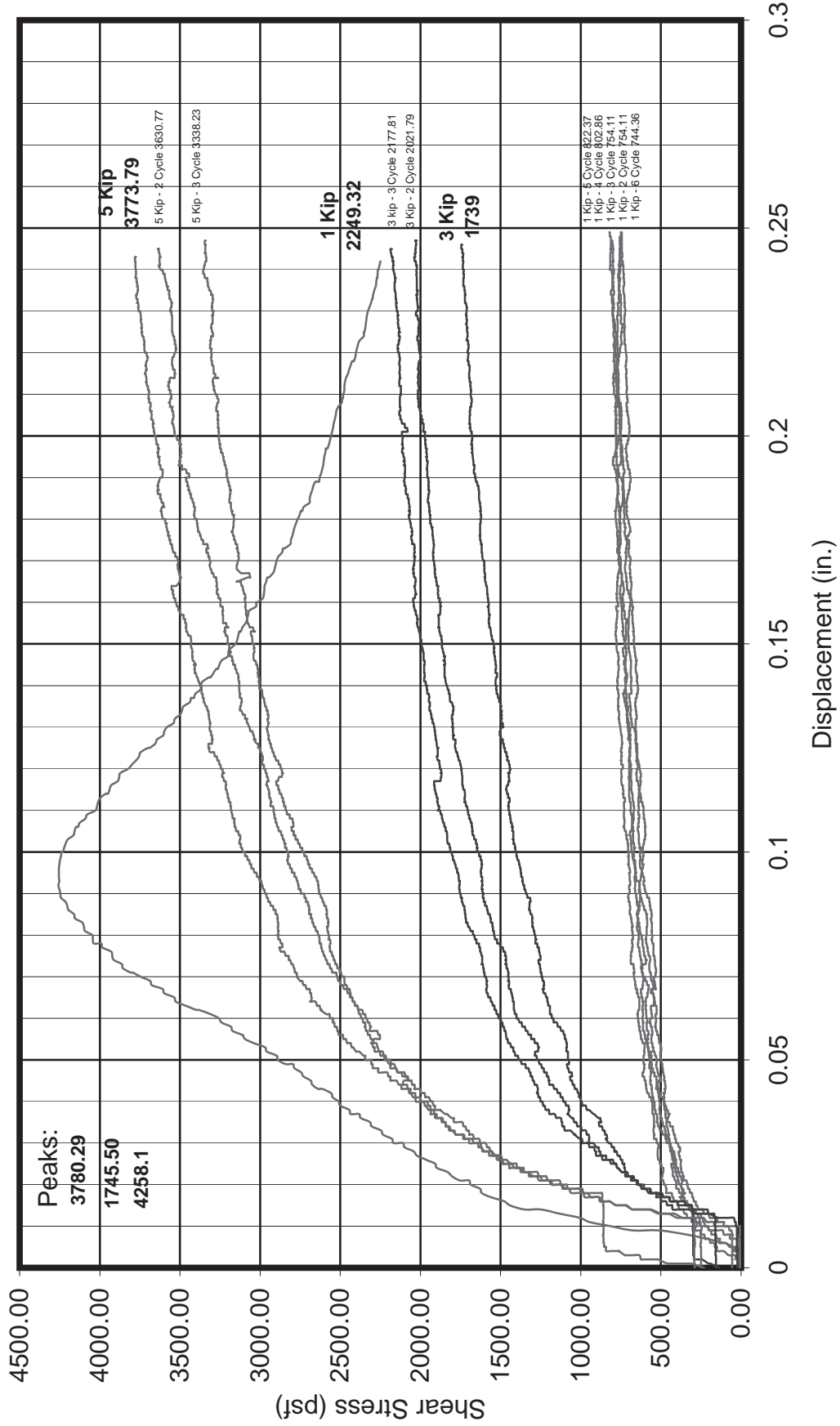

SHEAR TEST DIAGRAM

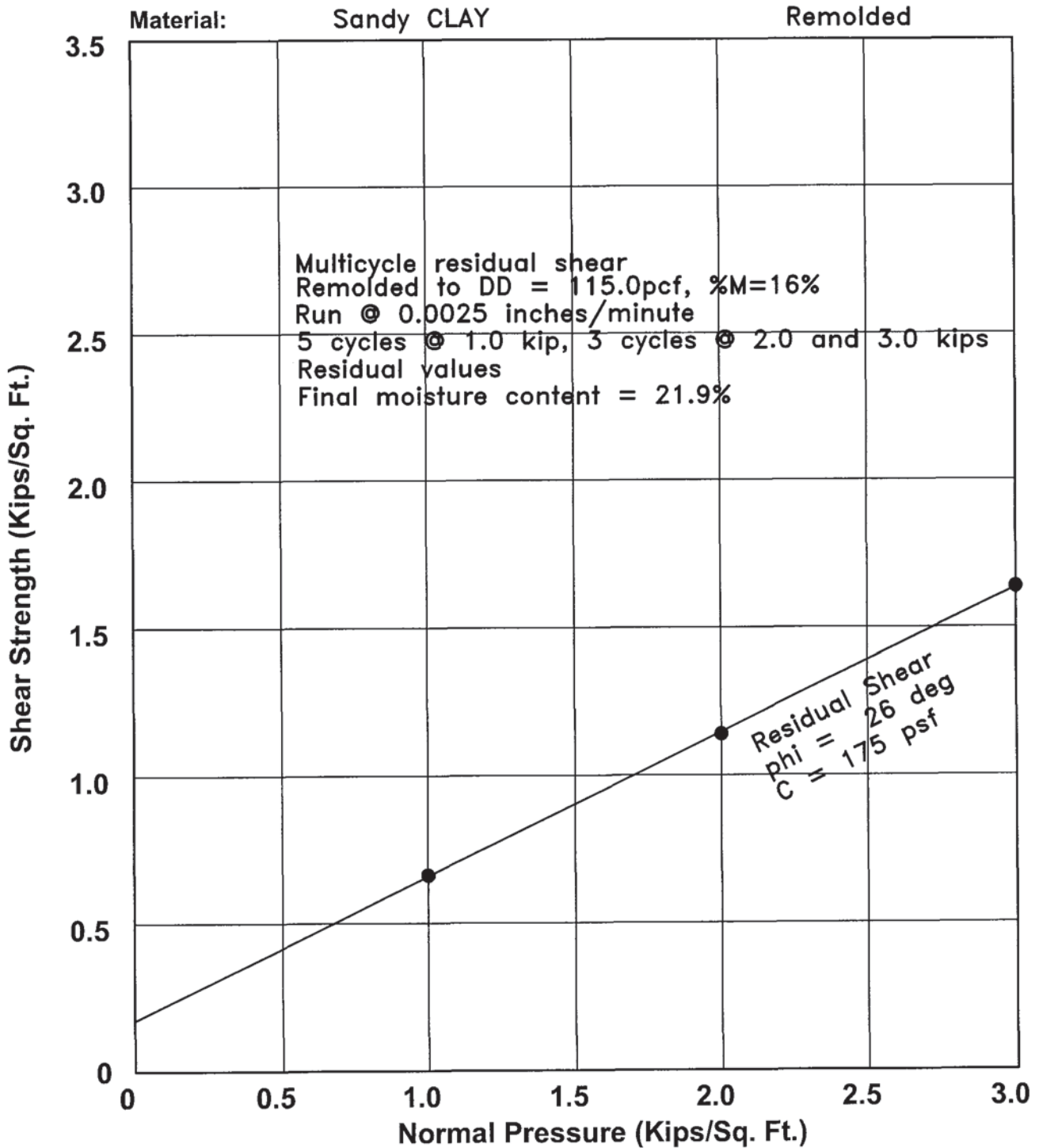

Project Skyline Ranch
 Excavation TP168
 Depth 3.5-5.5'



Geolabs - Westlake Village
 GEOLOGY AND SOIL ENGINEERING

BY AJH
 DATE _____ W.O. 8838

Excavation: TP168

Depth: 3.5-5.5 ft

Sample Description:

Displacement Rate: 0.0025 in/min

SHEARS 1K, 2K, & 3K NORMAL LOADS 93% remolded, Sat at 21.9 %

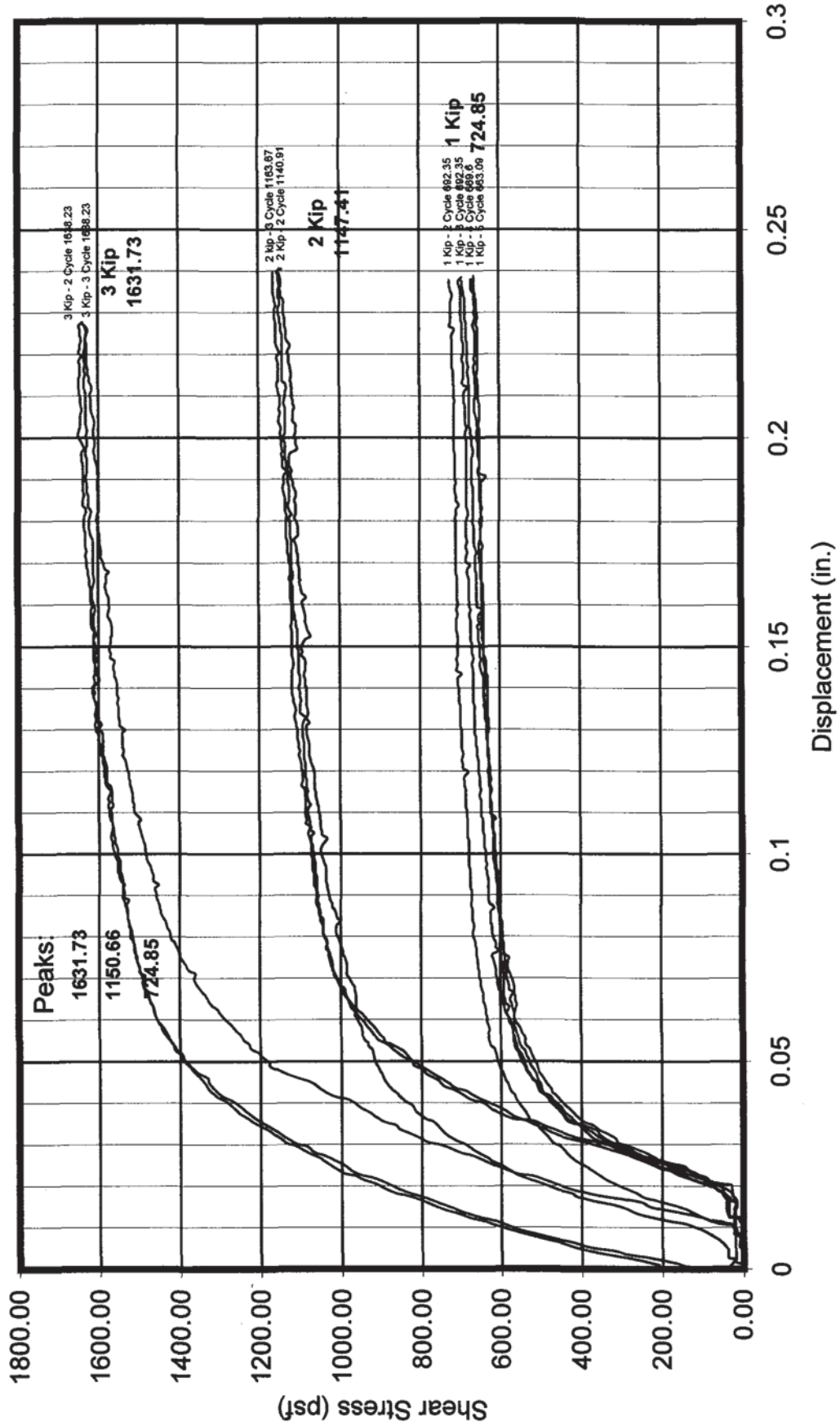

SHEAR TEST DIAGRAM

Material: Fill

Presoaked, Remolded to 90%

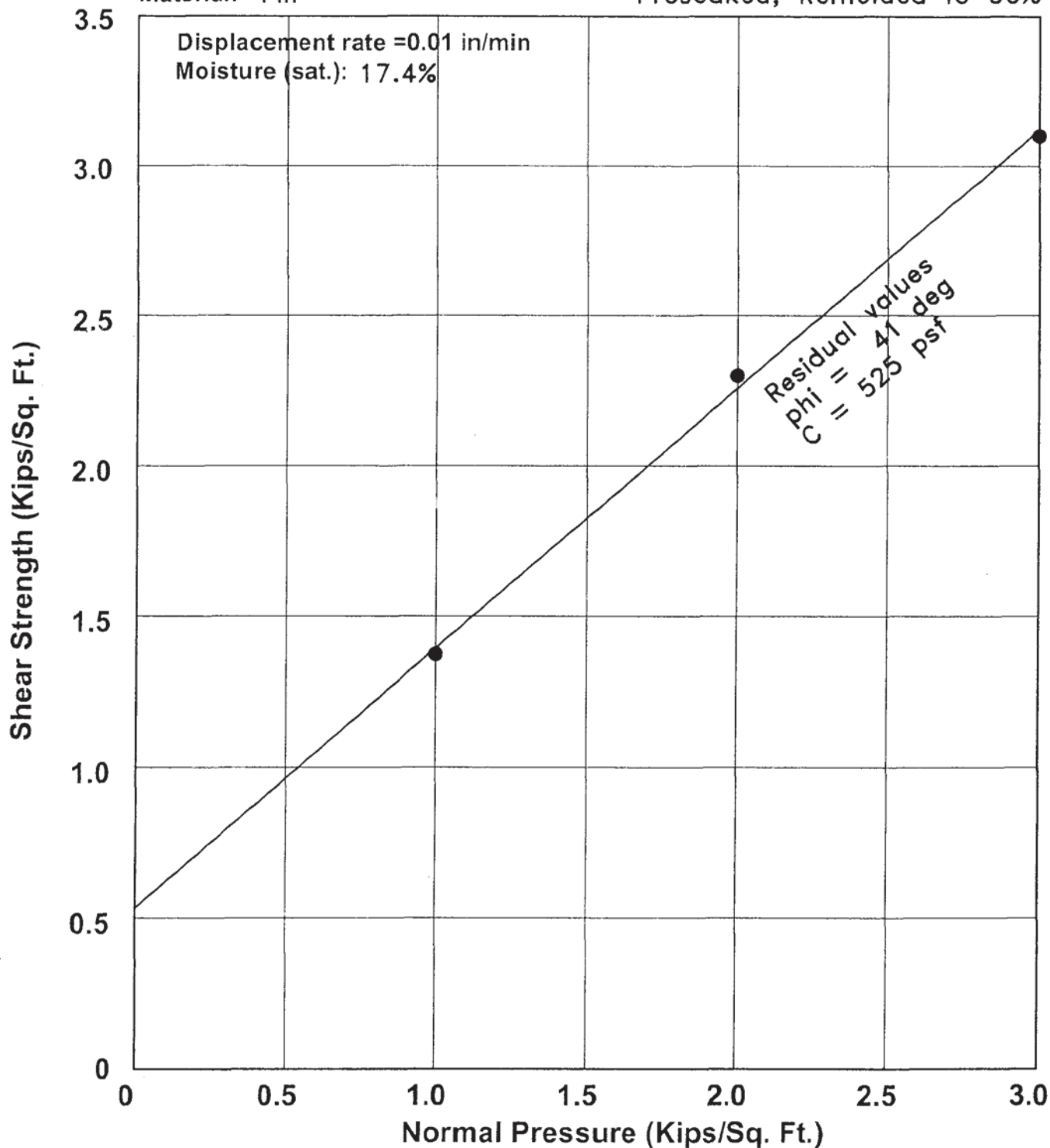

Project Skyline Ranch
Excavation B1(1995)
Depth 15'



Geolabs - Westlake Village
GEOLOGY AND SOIL ENGINEERING

DATE 12/19/95 BY SD
W.O. 8838

SHEAR TEST DIAGRAM

Material: Fill Presoaked, Remolded to 90%

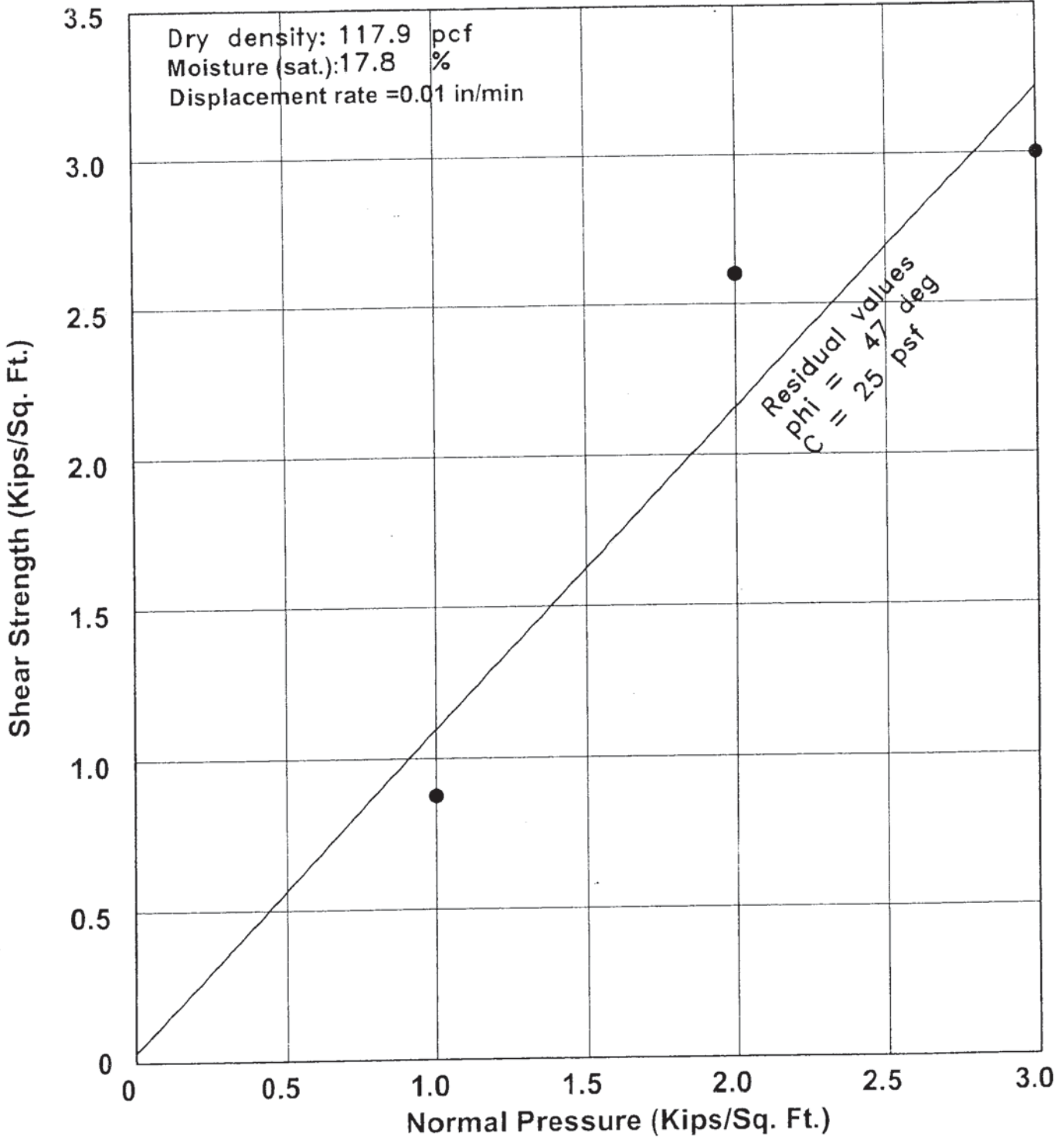

Project Skyline Ranch
 Excavation B1(1995)
 Depth 35'



Geolabs - Westlake Village
 GEOLOGY AND SOIL ENGINEERING

DATE 1/2/96 BY SD
 W.O. 8838

SHEAR TEST DIAGRAM

Material: Fill Presoaked, Remolded to 90%

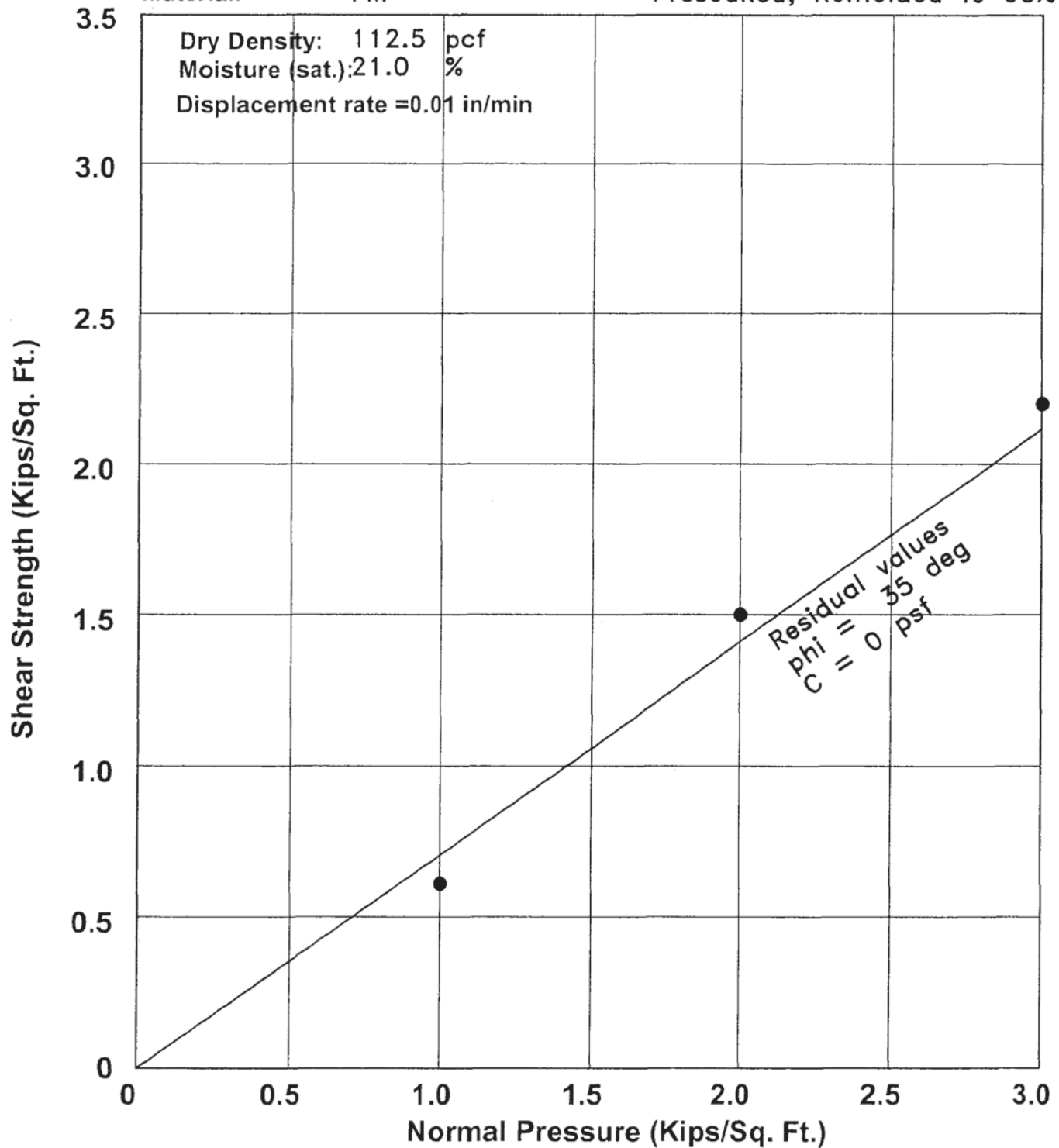

Project Skyline Ranch
 Excavation B1(1995)
 Depth 72'



Geolabs - Westlake Village
 GEOLOGY AND SOIL ENGINEERING

BY SD
 DATE 1/2/96 W.O. 8838

SHEAR TEST DIAGRAM

Material: Fill

Presoaked, Undisturbed

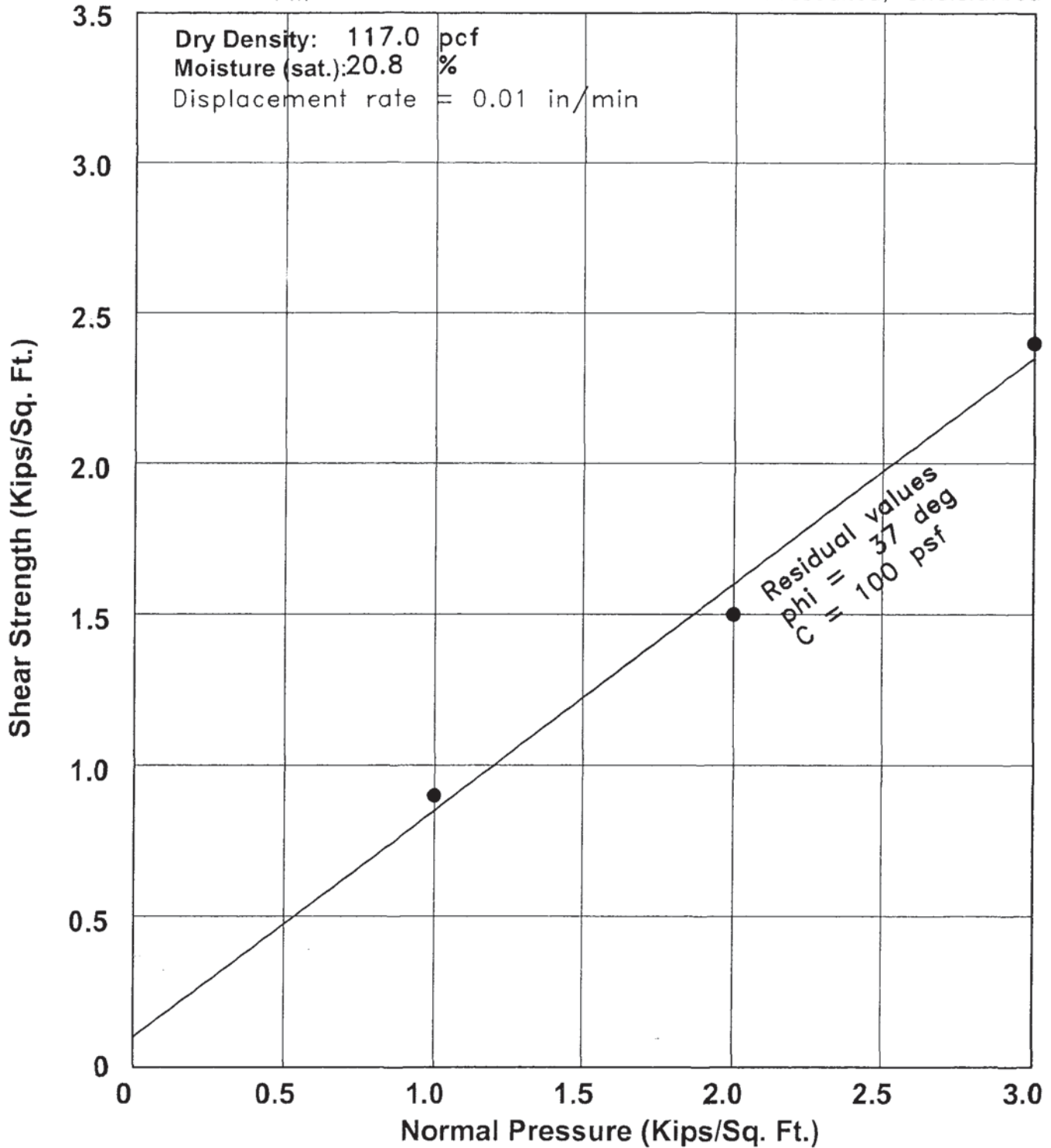

Project Skyline Ranch
 Excavation B11(1995)
 Depth 40'



Geolabs - Westlake Village
 GEOLOGY AND SOIL ENGINEERING

DATE 1/2/96 BY SD
 W.O. 8838

SHEAR TEST DIAGRAM

Material: Silty SAND (Saugus Fm.)

Remolded

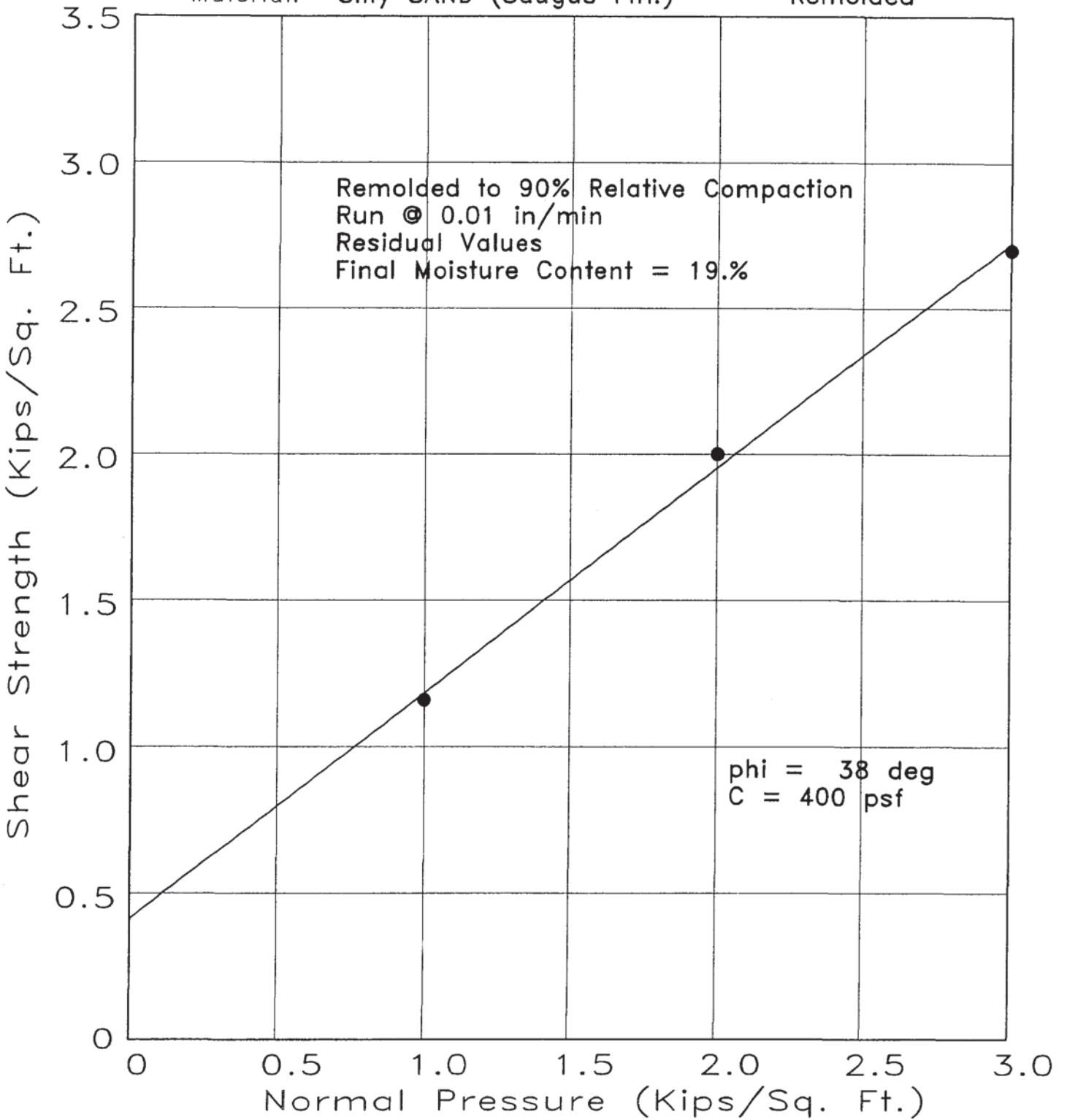

Project Skyline Ranch
Excavation Boring 3
Depth 0-5 Feet



Geolabs - Westlake Village
GEOLOGY AND SOIL ENGINEERING

DATE _____ BY DS
W.O. 8838

Excavation: B3 at 5 ft

W.O.: 8838

Displacement Rate: 0.01 in/min

SHEARS 1K, 2K, & 3K NORMAL LOADS

Remolded to 90% of 127 pcf at 8.8%, sat at 19%

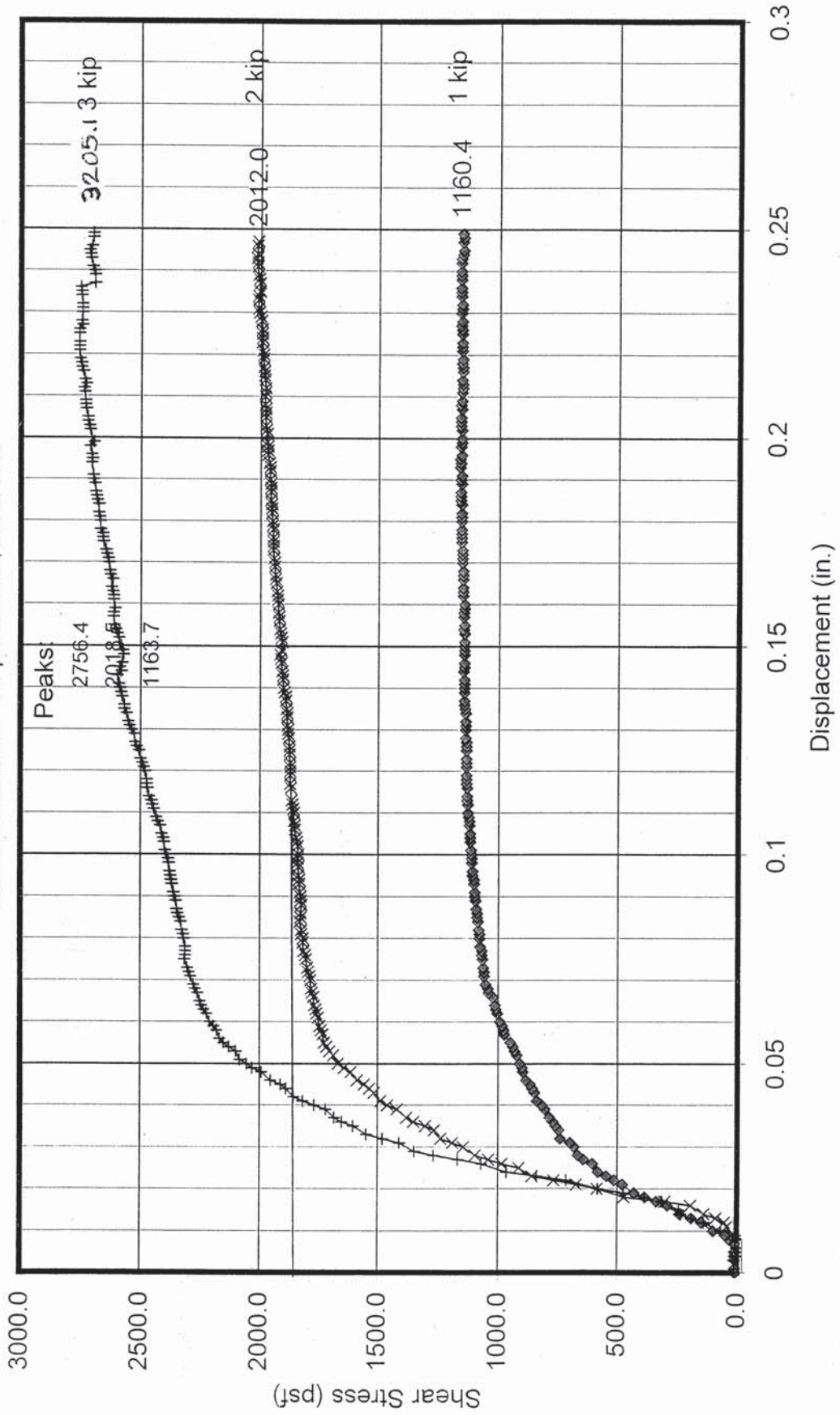

SHEAR TEST DIAGRAM

Material: **Fill**

Presoaked, Remolded to 90%

Dry density: **118.8 pcf**
 Moisture (sat.): **18.3 %**
 Displacement rate = **0.01 in/min**

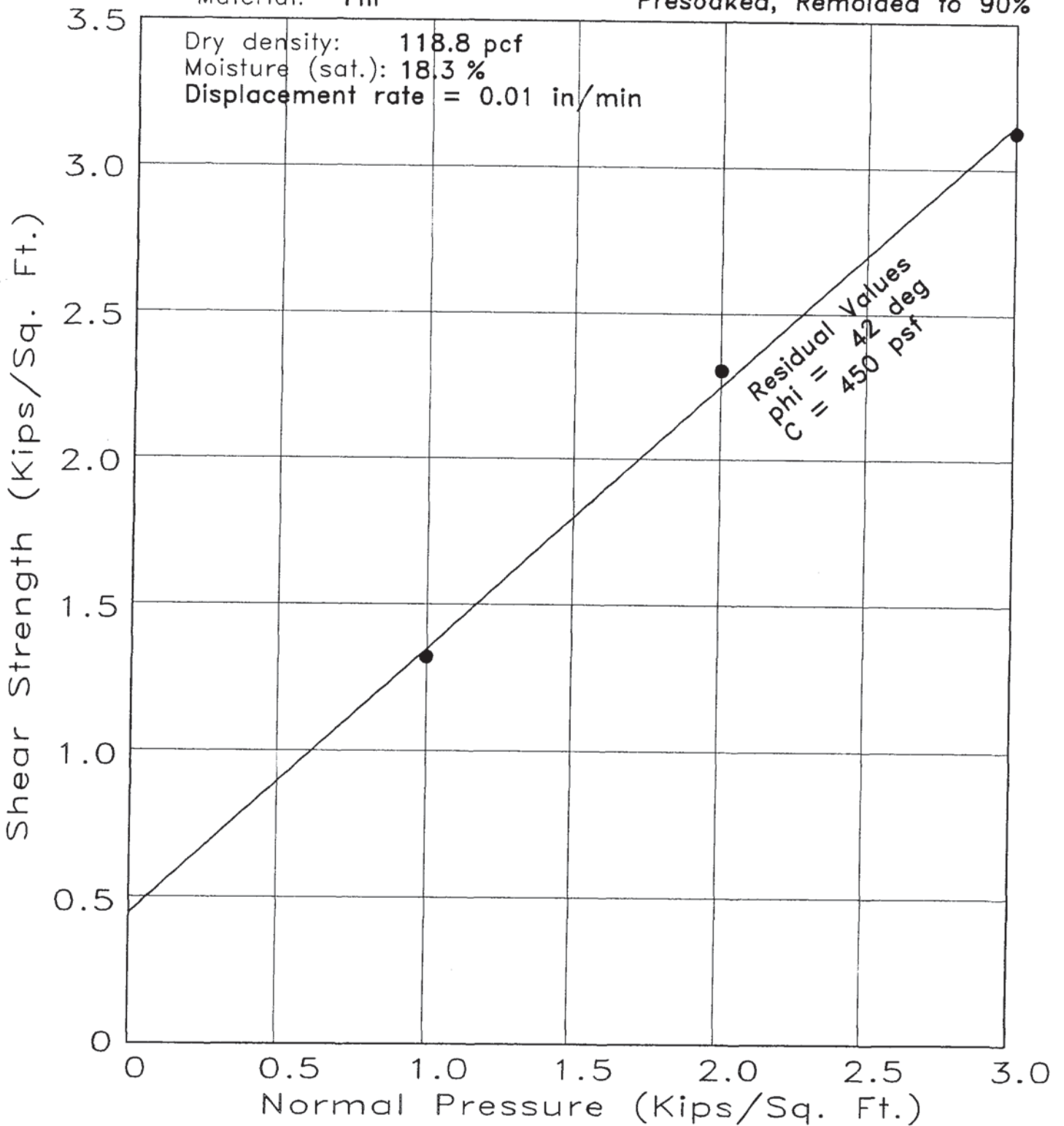

Project Skyline Ranch
 Excavation B3
 Depth 38'

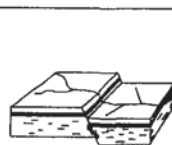

Geolabs - Westlake Village
 GEOLOGY AND SOIL ENGINEERING

DATE 1/14/04 BY SD
 W.O. 8838

Excavation: B3 at 38 ft

W.O.: 8838

Displacement Rate: 0.01 in/min

SHEARS 1K, 2K, & 3K NORMAL LOADS

Remolded to 90% of 132 pcf at 9.6%, sat at 18.3%

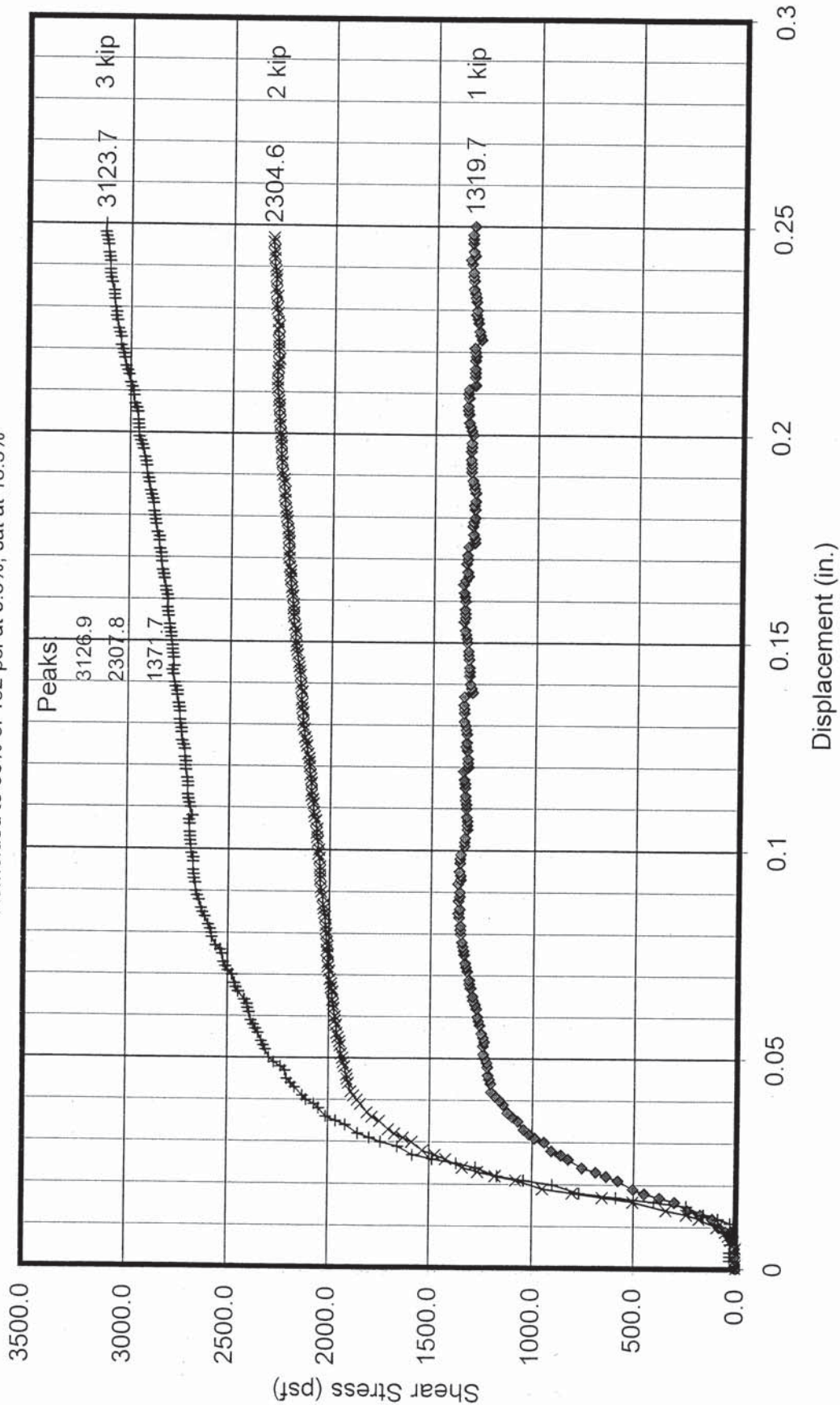

SHEAR TEST DIAGRAM

Material: Saugus Fm. - SANDSTONE

Remolded

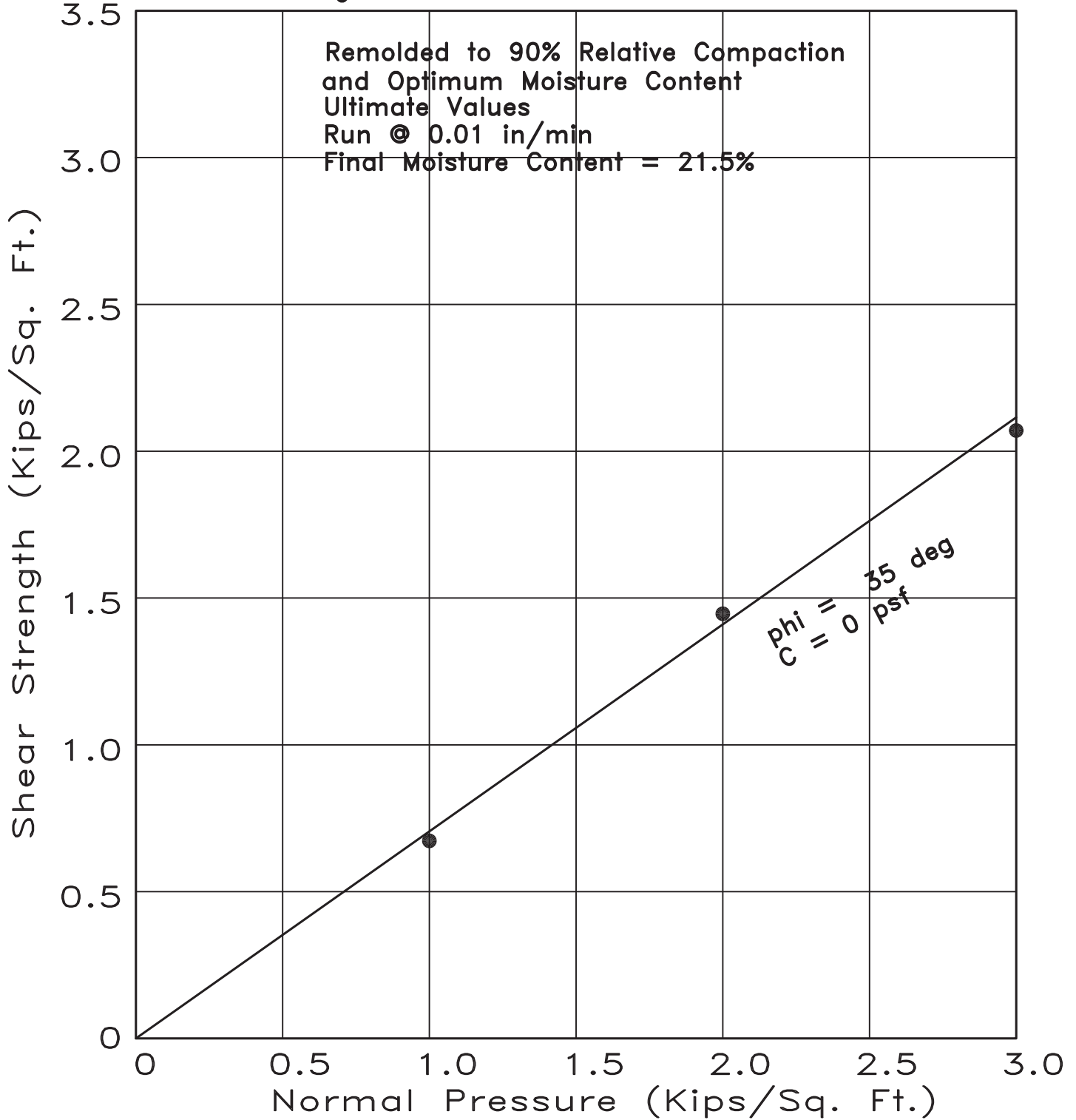

Project Tr. 060922 Skyline Ranch
Excavation B9
Depth 15 feet



Geolabs - Westlake Village
GEOLOGY AND SOIL ENGINEERING

BY DS
DATE _____ W.O. 8838

Excavation: B9 at 15 ft

W.O.: 8838

SHEARS 1K, 2K, & 3K NORMAL LOADS

Displacement Rate: 0.01 in/min

Remolded to 90% of 124pcf at 11% mst, sat at 21.5%

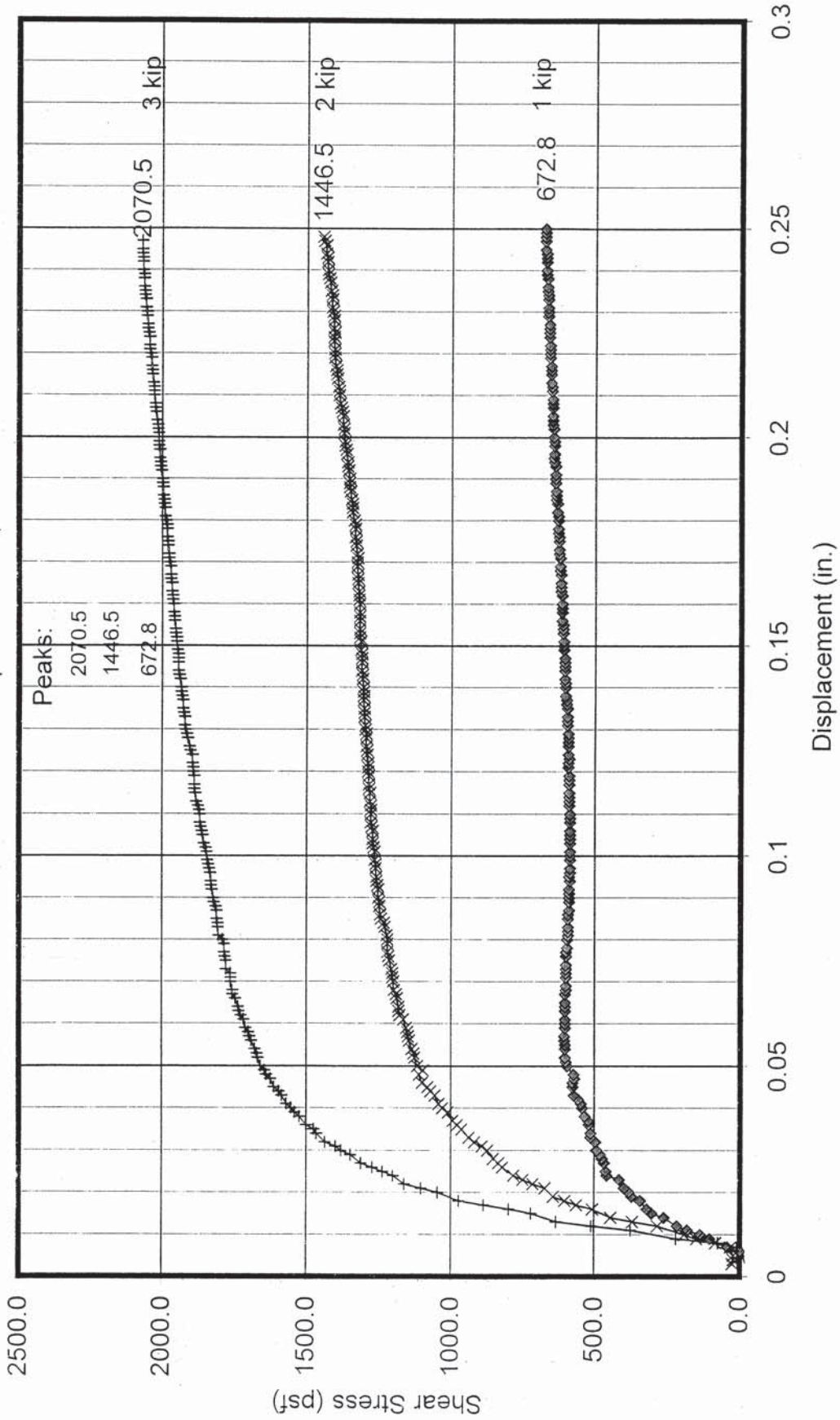

SHEAR TEST DIAGRAM

Material: Med. brown clayey silty SAND (TQs) Remolded

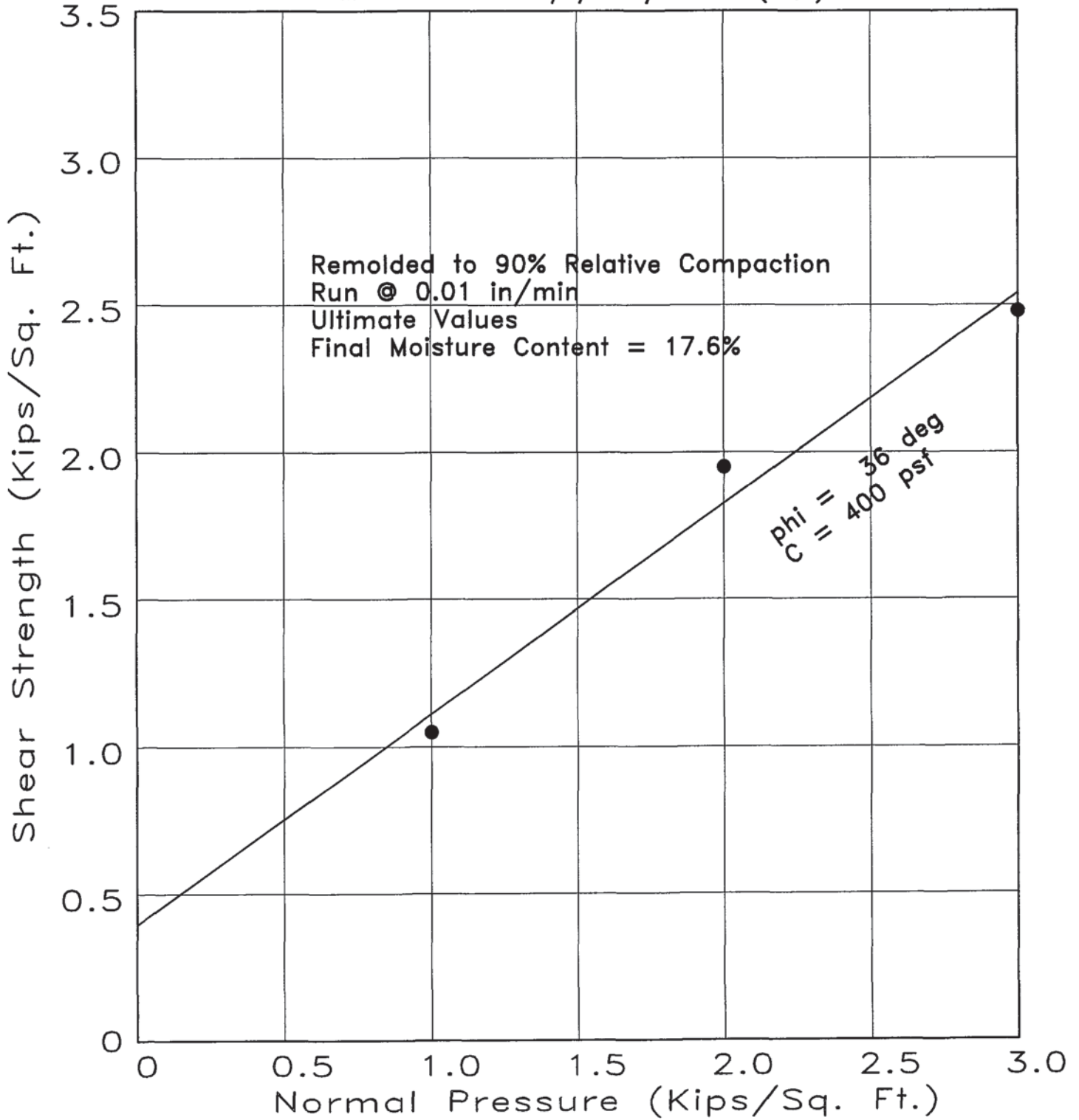

Project TTM 060922
Excavation Boring 10
Depth 20 Feet



Geolabs - Westlake Village
GEOLOGY AND SOIL ENGINEERING

BY _____
DATE _____ W.O. **8838**

Excavation: B10 at 20 ft

W.O.: 8838

SHEARS 1K, 2K, & 3K NORMAL LOADS Remolded to 90% at 7% mst, sat at 17.6%

Displacement Rate: 0.01 in/min

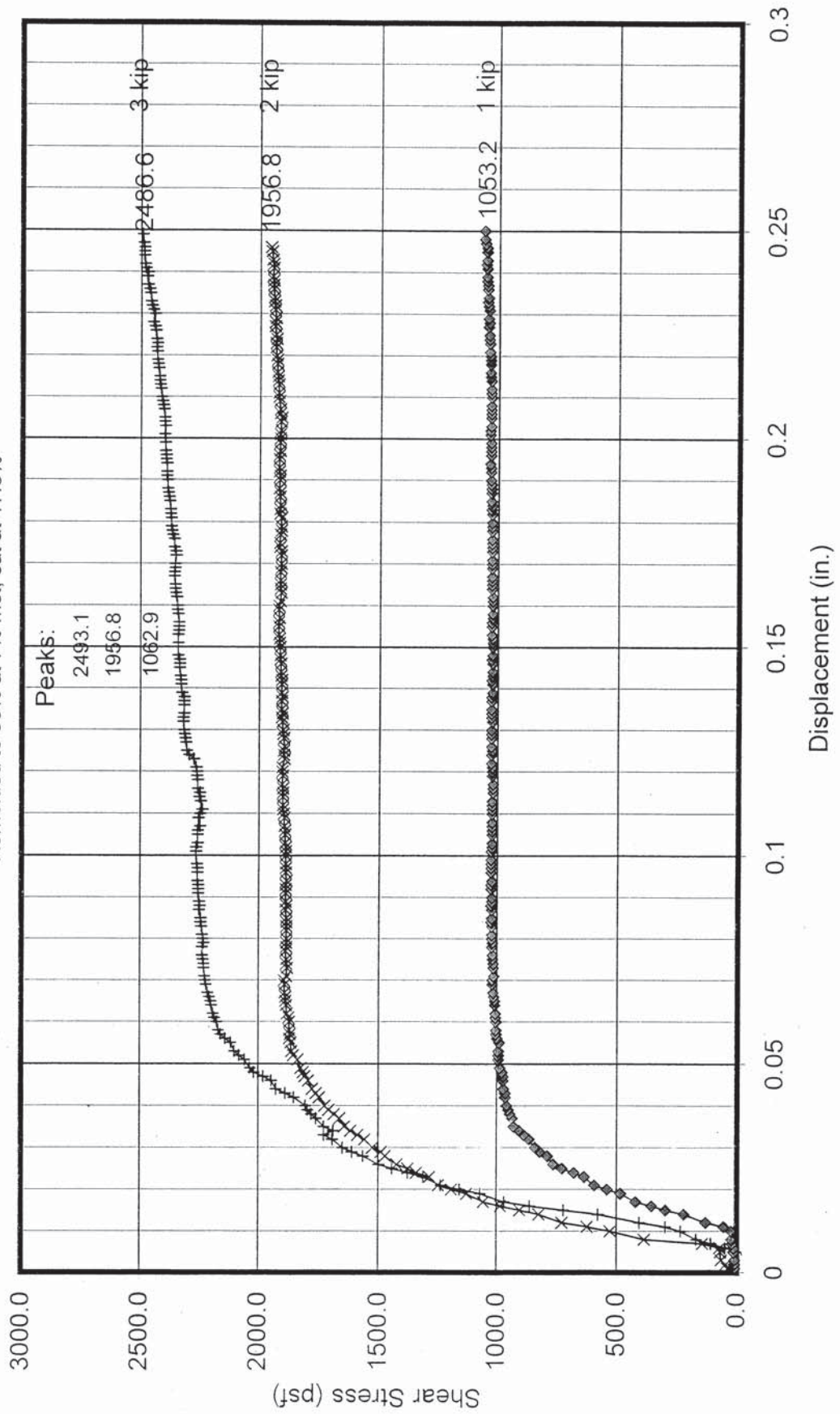

SHEAR TEST DIAGRAM

Material: Tan silty clayey SAND w/ gr. (TQs)

Remolded

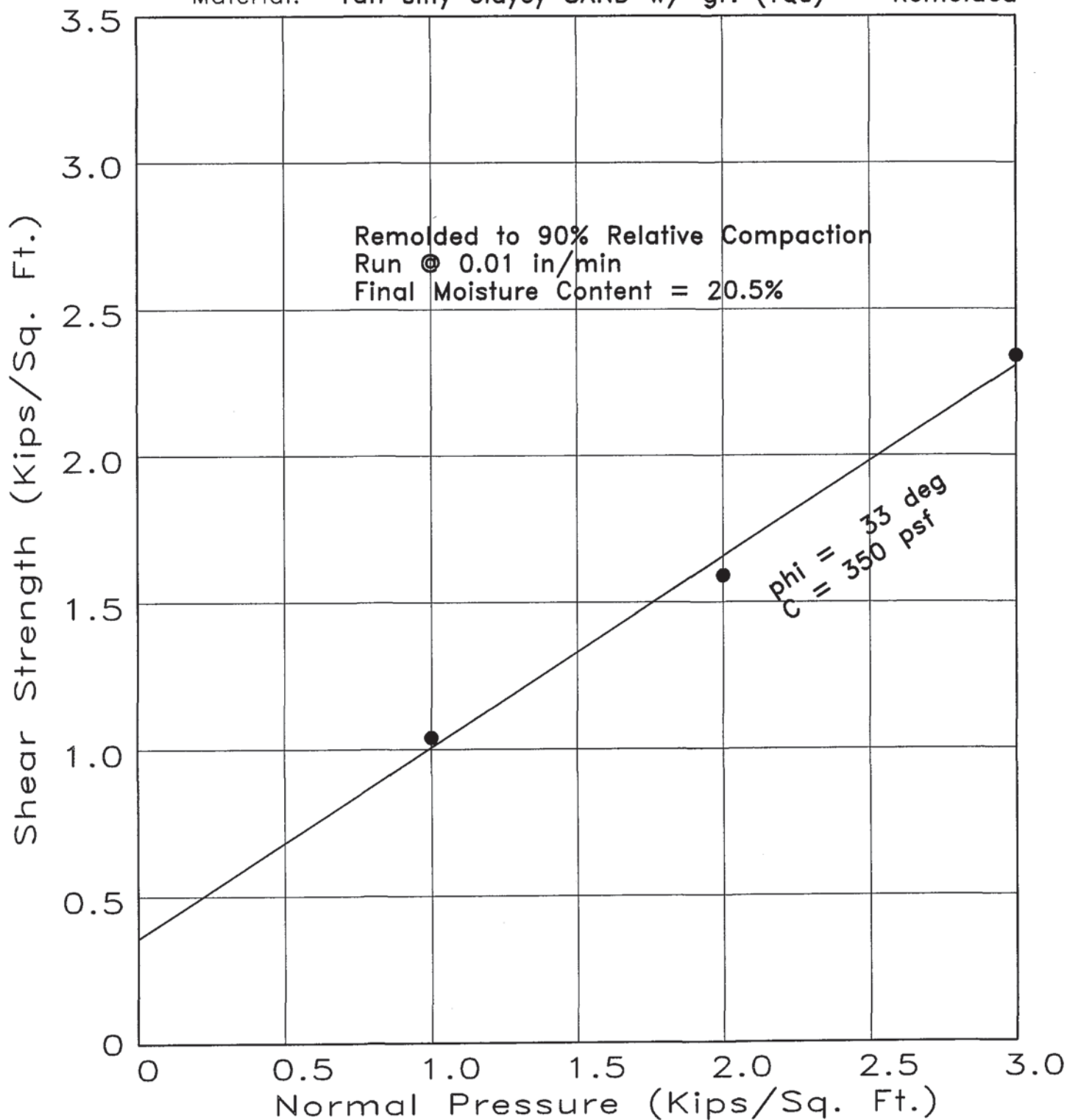

Project TTM 060922
Excavation Boring 19
Depth 15 Feet



Geolabs - Westlake Village
GEOLOGY AND SOIL ENGINEERING

BY _____
DATE _____ W.O. 8838

Excavation: B19 at 15 ft

W.O.: 8838

SHEARS

Displacement Rate: 0.01 in/min

1K, 2K, & 3K NORMAL LOADS

Remolded to 90% of 124pcf at 11% mst, sat at 20.5%

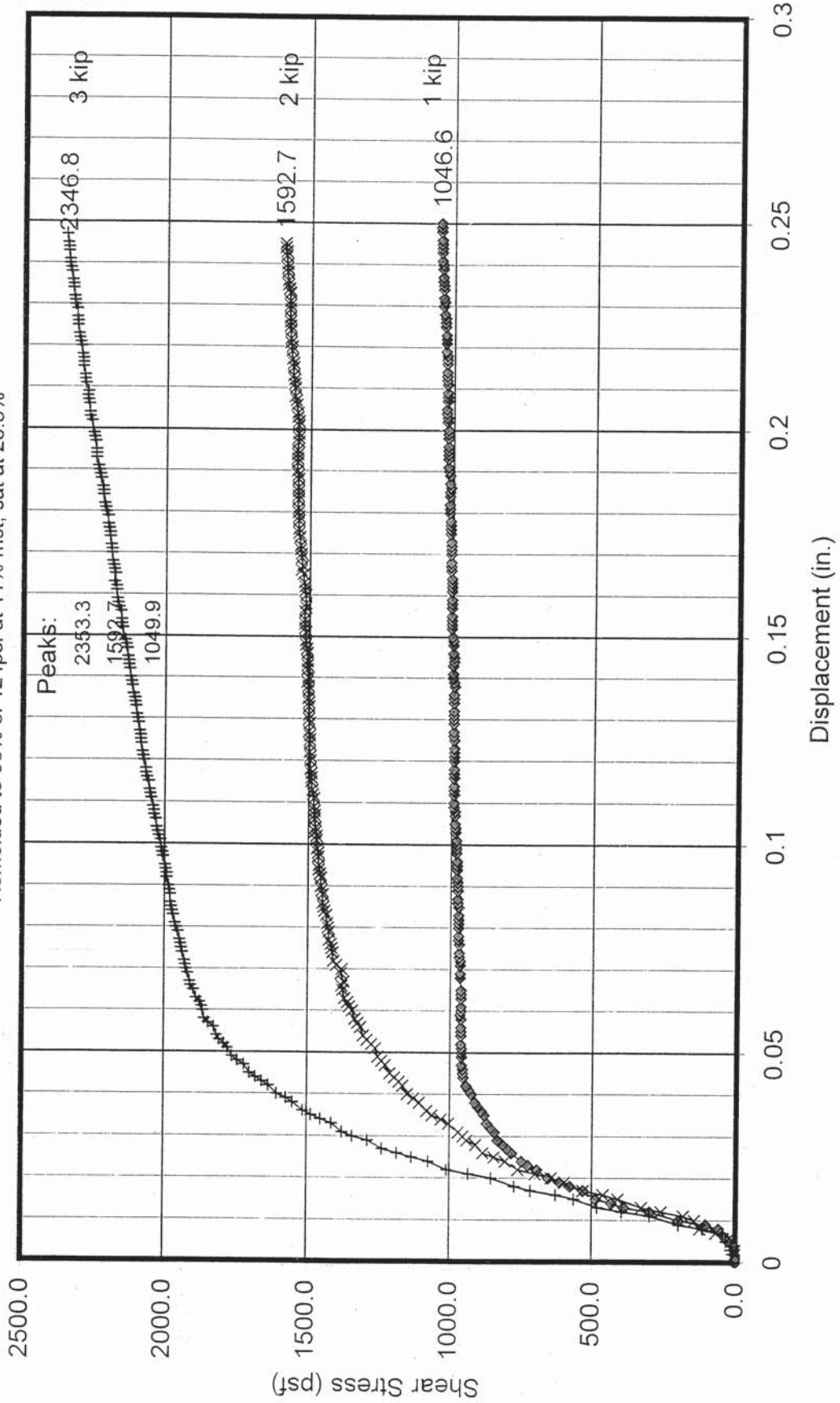

SHEAR TEST DIAGRAM

Material: Saugus Fm. - Reddish brn. clayey SAND Remolded

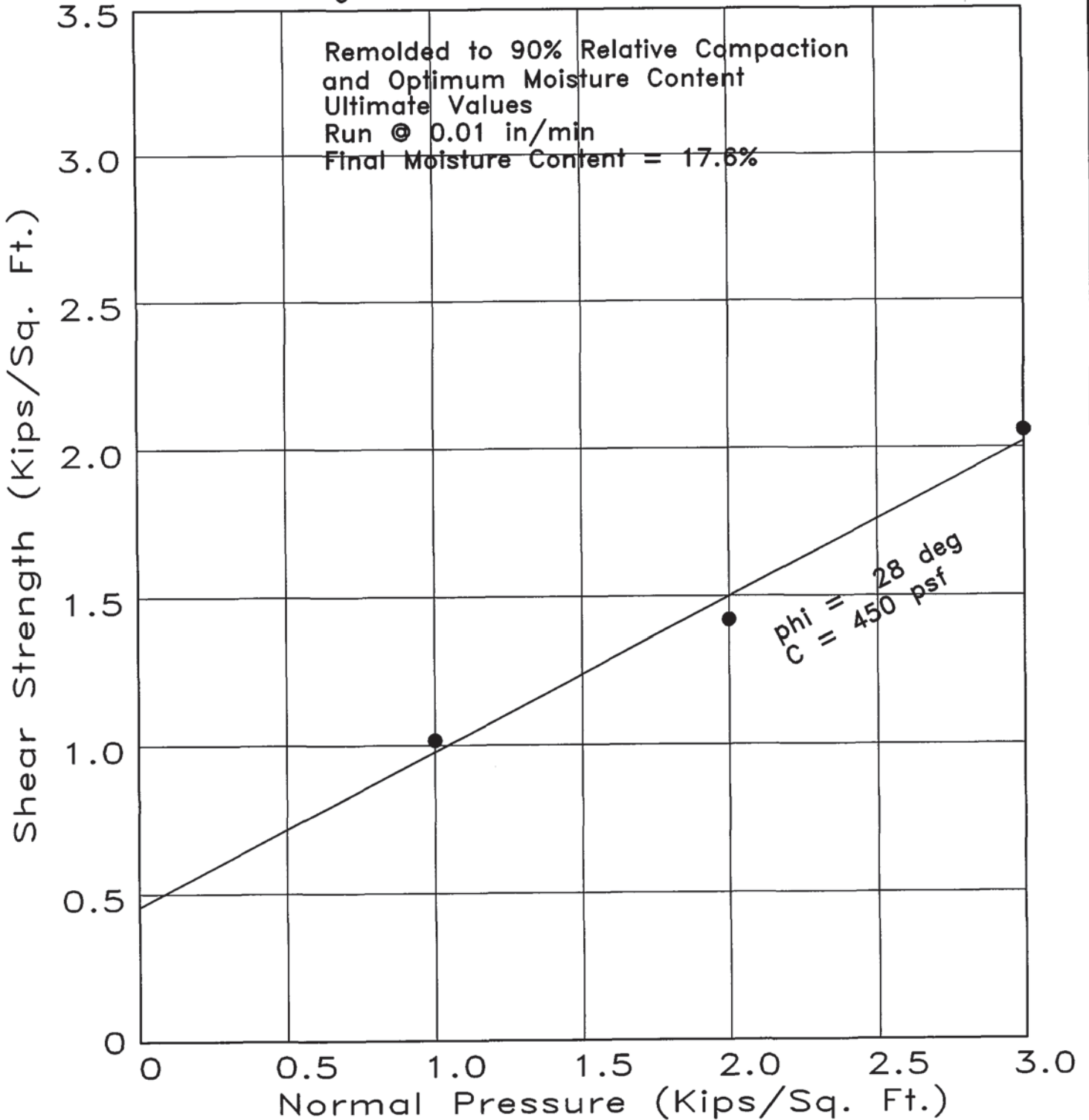

Project Tr. 060922 Skyline Ranch
 Excavation B39
 Depth 0 - 3 Feet



Geolabs - Westlake Village
 GEOLOGY AND SOIL ENGINEERING

BY DS
 DATE _____ W.O. 8838

Excavation: B39 Depth: 31 ft Sample Description: Reddish brown silty clayey fine to medium sand Displacement Rate: 0.0100 in/min

SHEARS 1K, 2K, & 3K NORMAL LOADS Remolded, Sat at 17.3 %

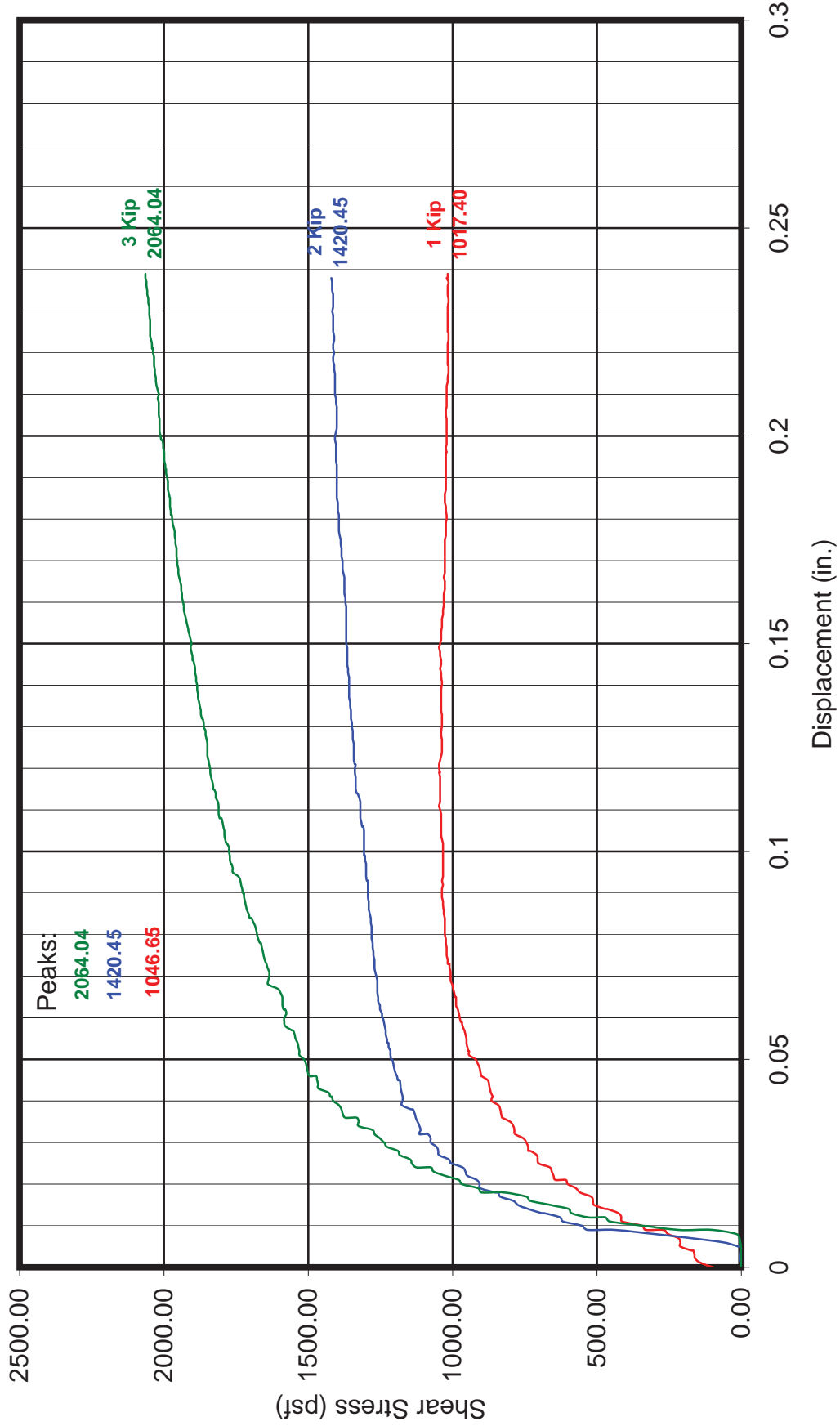

APPENDIX D

Slope Stability Analysis

Index

<u>Section</u>		<u>Page</u>
1.0	Approach.....	D-2
2.0	Design Shear Strength.....	D-2
3.0	Presentation of Analyses and Results.....	D-3

Tables

D-1	Design Shear Strength Parameters For Slope Stability Analyses.....	D-2
D-2	Summary of Slope Stability Analyses.....	D-3

Figures

Stability Analyses; gross; static and pseudostatic
Surficial Stability Calculations

APPENDIX D

Slope Stability Analyses

1.0 Approach

- Slope stability analyses were conducted using the computer program Slope W. The Modified Bishop's Method was used to analyze rotational failure modes, and the Janbu and Spencer Method was used to analyze translational failure modes. A coefficient of horizontal acceleration of 0.15g (FS of 1.1) was used to evaluate the pseudostatic stability analyses.
- After a review of the latest bulk grading plan and based on our supplemental investigation and review, twenty five cross-sections (1-1' through 3-3', 5-5', 7-7' through 15-15', 17-17' through 24-24', 28-28', 29-29', 32-32', and 34-34') were considered representative and critical with regards slope stability analysis.

2.0 Design Shear Strength

As discussed within the text of this report, direct shear testing was previously performed and shear strength values for the onsite soils were previously determined during previous site investigations and reviews for the subject site by GWV. The direct shear testing and shear strength values utilized were previously reviewed and accepted by the county of Los Angeles GMED. The previous test results are included for reference in this report. The previous direct shear testing was utilized to previously develop composite plots to determine the appropriate shear strength values to use for the on site soils. Composite plots for residual strengths were developed for the artificial fills, Saugus Formation bedrock and Mint Canyon Formation Bedrock for coarse grained and fine grained bedding conditions. The parameters used in the slope stability analysis are presented in Table D-1.

TABLE D-1
Design Shear Strength Parameters for Slope Stability Analyses

Material Type	Cohesion (psf)	Angle of Internal Friction (degrees)
Engineered Fill	200	33
Alluvium/Colluvium	0	30
Landslide Debris	0	20
Landslide Slide Plane	150	9
Saugus Formation Across-Bedding Strength	225	40
Mint Canyon and Saugus Fm Along-Bedding Strength, Coarse-grained Lithologies	100	25
Saugus Formation Along-Bedding, Fine-grained Unsheared	150	17
Saugus Formation Along-Bedding, Fine-grained	150	11
Mint Canyon Formation Across-Bedding Strength.	200	40
Mint Canyon Formation Along-Bedding, Fine-grained Unsheared	150	17

TABLE D-2
Summary of Slope Stability Analyses

No	Cross-Section	Reference	Condition	Factor of Safety	Remarks

Section 1 SSA for Skyline Ranch Development project.gsz

Section 1 SSA for Skyline Ranch Development project.gsz Run By: Dr. Alexander Bykovtsev, Ph.D., P.E. 3/18/2016 7:21:35 PM

Name: TQs150 psf-17° bedding 3-10°
 Model: Anisotropic Fn.
 Unit Weight: 120 pcf
 Cohesion: 225 psf
 Phi: 40 °
 Phi-Anisotropic Strength Fn.: TQs 17° A-bedding 3-10°
 C-Anisotropic Strength Fn.: TQs 150psf A-bedding 3-10°

Static - Circular

Materials

- TQs150 psf-17° bedding 3-10°
- Fill
- TQs 150 psf-11° bedding 3-10°

Key 40 Feet Wide by 20 feet Deep 2H:1V Backcut

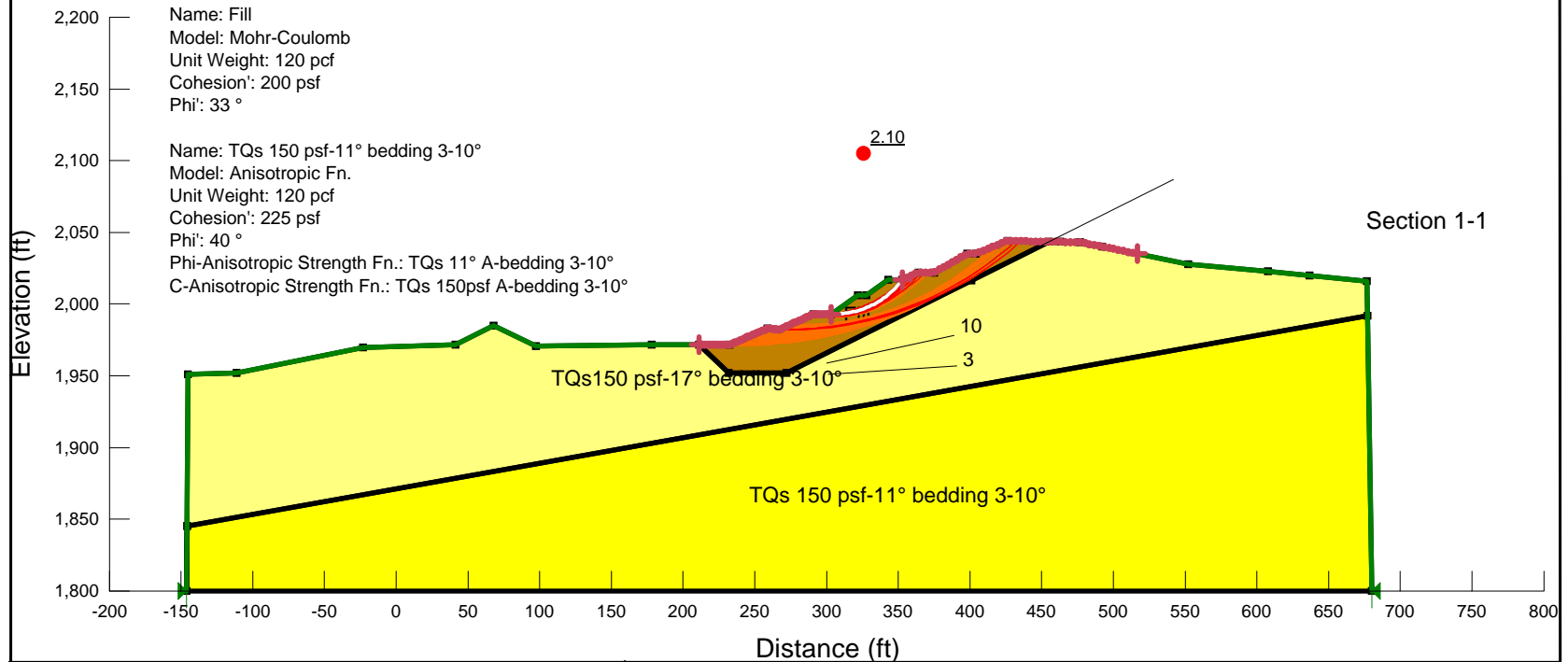

LGC Valley, Inc

GEOTECHNICAL CONSULTING

28532 Constellation Road, Valencia, CA 91355
 Phone 661-702-8474, Fax 661-702-8475

**Skyline Ranch
 Development project, Tract 60922
 Los Angeles CA**

Project No: **153035-01**
 Engineer: **BAS**
 Date: **March 2016**

1 - Circular Mode of Failure Static

Report generated using GeoStudio 2012. Copyright © 1991-2016 GEO-SLOPE International Ltd.

File Information

File Version: 8.15
 Title: Static Slope Stability Analyses for Skyline Ranch Development project, Tract 60922, Los Angeles CA
 Comments: Run By: Dr. Alexander Bykovtsev, Ph.D., P.E.
 Last Edited By: Alexander Bykovtsec
 Revision Number: 60
 Date: 3/18/2016
 Time: 7:21:35 PM
 Tool Version: 8.15.5.11777
 File Name: Section 1 SSA for Skyline Ranch Development project.gsz
 Directory: P:\FINAL PROJECTS\PARDEE\Skyline Ranch\SLOPE RESULTS\Section 1-1 results\Latest Update 3-18-16\
 Last Solved Date: 3/18/2016
 Last Solved Time: 7:23:50 PM

Project Settings

Length(L) Units: Feet
 Time(t) Units: Seconds
 Force(F) Units: Pounds
 Pressure(p) Units: psf
 Strength Units: psf
 Unit Weight of Water: 62.4 pcf
 View: 2D
 Element Thickness: 1

Analysis Settings

1 - Circular Mode of Failure Static

Kind: SLOPE/W
 Method: Bishop
 Settings
 PWP Conditions Source: (none)
 Slip Surface
 Direction of movement: Right to Left
 Use Passive Mode: No
 Slip Surface Option: Entry and Exit
 Critical slip surfaces saved: 10
 Resisting Side Maximum Convex Angle: 1 °
 Driving Side Maximum Convex Angle: 5 °
 Optimize Critical Slip Surface Location: No
 Tension Crack
 Tension Crack Option: (none)

file:///P:/FINAL%20PROJECTS/PARDEE/Skyline%20Ranch/SLOPE%20RESULTS/Sect... 3/18/2016

F of S Distribution
 F of S Calculation Option: Constant
 Advanced
 Number of Slices: 30
 F of S Tolerance: 0.01
 Minimum Slip Surface Depth: 0.1 ft

Materials

TQs150 psf-17° bedding 3-10°

Model: Anisotropic Fn.
 Unit Weight: 120 pcf
 Cohesion': 225 psf
 Phi': 40 °
 Phi-Anisotropic Strength Fn.: TQs 17° A-bedding 3-10°
 C-Anisotropic Strength Fn.: TQs 150psf A-bedding 3-10°
 Phi-B: 0 °

Fill

Model: Mohr-Coulomb
 Unit Weight: 120 pcf
 Cohesion': 200 psf
 Phi': 33 °
 Phi-B: 0 °

TQs 150 psf-11° bedding 3-10°

Model: Anisotropic Fn.
 Unit Weight: 120 pcf
 Cohesion': 225 psf
 Phi': 40 °
 Phi-Anisotropic Strength Fn.: TQs 11° A-bedding 3-10°
 C-Anisotropic Strength Fn.: TQs 150psf A-bedding 3-10°
 Phi-B: 0 °

Slip Surface Entry and Exit

Left Projection: Range
 Left-Zone Left Coordinate: (211,0268, 1,971.6364) ft
 Left-Zone Right Coordinate: (303, 1,993) ft
 Left-Zone Increment: 50
 Right Projection: Range
 Right-Zone Left Coordinate: (353, 2,017) ft
 Right-Zone Right Coordinate: (517, 2,035) ft
 Right-Zone Increment: 50
 Radius Increments: 8

Slip Surface Limits

file:///P:/FINAL%20PROJECTS/PARDEE/Skyline%20Ranch/SLOPE%20RESULTS/Sect... 3/18/2016

Left Coordinate: (-146, 1,800.0439) ft
 Right Coordinate: (680, 1,800) ft

Seismic Coefficients

Horz Seismic Coef.: 0
 Vert Seismic Coef.: 0

Anisotropic Strength Functions

TQs 17° A-bedding 3-10°

Model: Spline Data Point Function
 Function: Modifier Factor vs. Inclination
 Curve Fit to Data: 100 %
 Segment Curvature: 0 %
 Y-Intercept: 1
 Data Points: Inclination (°), Modifier Factor
 Data Point: (-90, 1)
 Data Point: (2.9, 1)
 Data Point: (3, 0.425)
 Data Point: (10, 0.425)
 Data Point: (10.1, 1)

TQs 11° A-bedding 3-10°

Model: Spline Data Point Function
 Function: Modifier Factor vs. Inclination
 Curve Fit to Data: 100 %
 Segment Curvature: 0 %
 Y-Intercept: 1
 Data Points: Inclination (°), Modifier Factor
 Data Point: (-90, 1)
 Data Point: (2.9, 1)
 Data Point: (3, 0.275)
 Data Point: (10, 0.275)
 Data Point: (10.1, 1)

TQs 150psf A-bedding 3-10°

Model: Spline Data Point Function
 Function: Modifier Factor vs. Inclination
 Curve Fit to Data: 100 %
 Segment Curvature: 0 %
 Y-Intercept: 1
 Data Points: Inclination (°), Modifier Factor
 Data Point: (-90, 1)
 Data Point: (2.9, 1)
 Data Point: (3, 0.667)
 Data Point: (10, 0.667)
 Data Point: (10.1, 1)

Points

	X (ft)	Y (ft)
Point 1	-145.2287	1,950.7886
Point 2	-111.3064	1,951.8013
Point 3	-22.9567	1,969.775
Point 4	41.3437	1,971.547
Point 5	68.1778	1,984.9641
Point 6	97.5433	1,970.5344
Point 7	178.0454	1,971.547
Point 8	232.4729	1,971.547
Point 9	259	1,983
Point 10	267	1,982
Point 11	291	1,993
Point 12	303	1,993
Point 13	322	2,006
Point 14	328	2,006
Point 15	343	2,017
Point 16	353	2,017
Point 17	364	2,022
Point 18	375	2,022
Point 19	398	2,035
Point 20	404	2,035
Point 21	426	2,044
Point 22	477	2,043
Point 23	492	2,040
Point 24	552	2,028
Point 25	680	1,800
Point 26	-146	1,800.0439
Point 27	677	1,992
Point 28	608	2,022.624
Point 29	636.787	2,019.9606
Point 30	676.6631	2,016.0286
Point 31	-145.6611	1,845.0183
Point 32	210.9608	1,971.6367
Point 33	232	1,952
Point 34	272	1,952
Point 35	401.1176	2,016.6763
Point 36	455.0038	2,043.5159
Point 37	463	2,043.2745

Regions

	Material	Points	Area (ft²)
Region 1	TQs150 psf-17° bedding 3-10°	1,26,31,27,30,29,28,24,23,22,37,36,35,34,33,32,7,6,5,4,3,2	58,736
Region 2	TQs 150 psf-11° bedding 3-10°	27,31,26,25	97,770
Region 3	Fill	32,33,34,35,36,21,20,19,18,17,16,15,14,13,12,11,10,9,8	5,214.9

Current Slip Surface

Slip Surface: 22,954
 F of S: 2.10
 Volume: 371.63793 ft³
 Weight: 44,596.551 lbs
 Resisting Moment: 2,328,266.1 lbs-ft
 Activating Moment: 1,107,249.6 lbs-ft
 F of S Rank (Analysis): 1 of 23,409 slip surfaces
 F of S Rank (Query): 1 of 150 slip surfaces
 Exit: (303, 1,993) ft
 Entry: (353, 2,017) ft
 Radius: 60.246339 ft
 Center: (304.85548, 2,053.2178) ft

Slip Slices

	X (ft)	Y (ft)	PWP (psf)	Base Normal Stress (psf)	Frictional Strength (psf)	Cohesive Strength (psf)
Slice 1	303.86364	1,992.9858	0	74.55838	48.418778	200
Slice 2	305.59091	1,992.9821	0	212.91373	138.26779	200
Slice 3	307.31818	1,993.028	0	342.97346	222.72957	200
Slice 4	309.04545	1,993.1235	0	464.91976	301.92242	200
Slice 5	310.77273	1,993.269	0	578.90446	375.94495	200
Slice 6	312.5	1,993.4647	0	685.0512	444.87745	200
Slice 7	314.22727	1,993.7112	0	783.45705	508.78295	200
Slice 8	315.95455	1,994.0091	0	874.19372	567.70804	200
Slice 9	317.68182	1,994.3592	0	957.30844	621.68337	200
Slice 10	319.40909	1,994.7625	0	1,032.8244	670.72401	200
Slice						

11	321.13636	1,995.2199	0	1,100.7409	714.82947	200
Slice 12	322.75	1,995.6957	0	1,101.3087	715.19823	200
Slice 13	324.25	1,996.184	0	1,036.8746	673.35424	200
Slice 14	325.75	1,996.7164	0	968.45093	628.91939	200
Slice 15	327.25	1,997.2941	0	896.01174	581.87683	200
Slice 16	328.83333	1,997.956	0	879.68058	571.27125	200
Slice 17	330.5	1,998.7097	0	917.08595	595.56258	200
Slice 18	332.16667	1,999.5256	0	946.75549	614.8302	200
Slice 19	333.83333	2,000.4068	0	968.5074	628.95606	200
Slice 20	335.5	2,001.3564	0	982.12499	637.79942	200
Slice 21	337.16667	2,002.3785	0	987.35215	641.19398	200
Slice 22	338.83333	2,003.4774	0	983.88772	638.94416	200
Slice 23	340.5	2,004.6583	0	971.37841	630.82052	200
Slice 24	342.16667	2,005.9275	0	949.40982	616.55395	200
Slice 25	343.83333	2,007.2922	0	859.37479	558.08452	200
Slice 26	345.5	2,008.7614	0	703.44824	456.82463	200
Slice 27	347.16667	2,010.3457	0	540.31814	350.8867	200
Slice 28	348.83333	2,012.0585	0	369.67235	240.06803	200
Slice 29	350.5	2,013.9168	0	191.19188	124.16146	200
Slice 30	352.16667	2,015.9423	0	4.5775828	2.972717	200

Section 1 SSA for Skyline Ranch Development project.gsz

Section 1 SSA for Skyline Ranch Development project.gsz Run By: Dr. Alexander Bykovtsev, Ph.D., P.E. 3/18/2016 7:21:35 PM

Name: TQs150 psf-17° bedding 3-10°
 Model: Anisotropic Fn.
 Unit Weight: 120 pcf
 Cohesion: 225 psf
 Phi: 40 °
 Phi-Anisotropic Strength Fn.: TQs 17° A-bedding 3-10°
 C-Anisotropic Strength Fn.: TQs 150psf A-bedding 3-10°

Seismic Load
 Horizontal: 0.15
 Vertical: 0.0

Materials	
	TQs150 psf-17° bedding 3-10°
	Fill
	TQs 150 psf-11° bedding 3-10°

Pseudostatic - Circular

Key 40 Feet Wide by 20 feet Deep 2H:1V Backcut

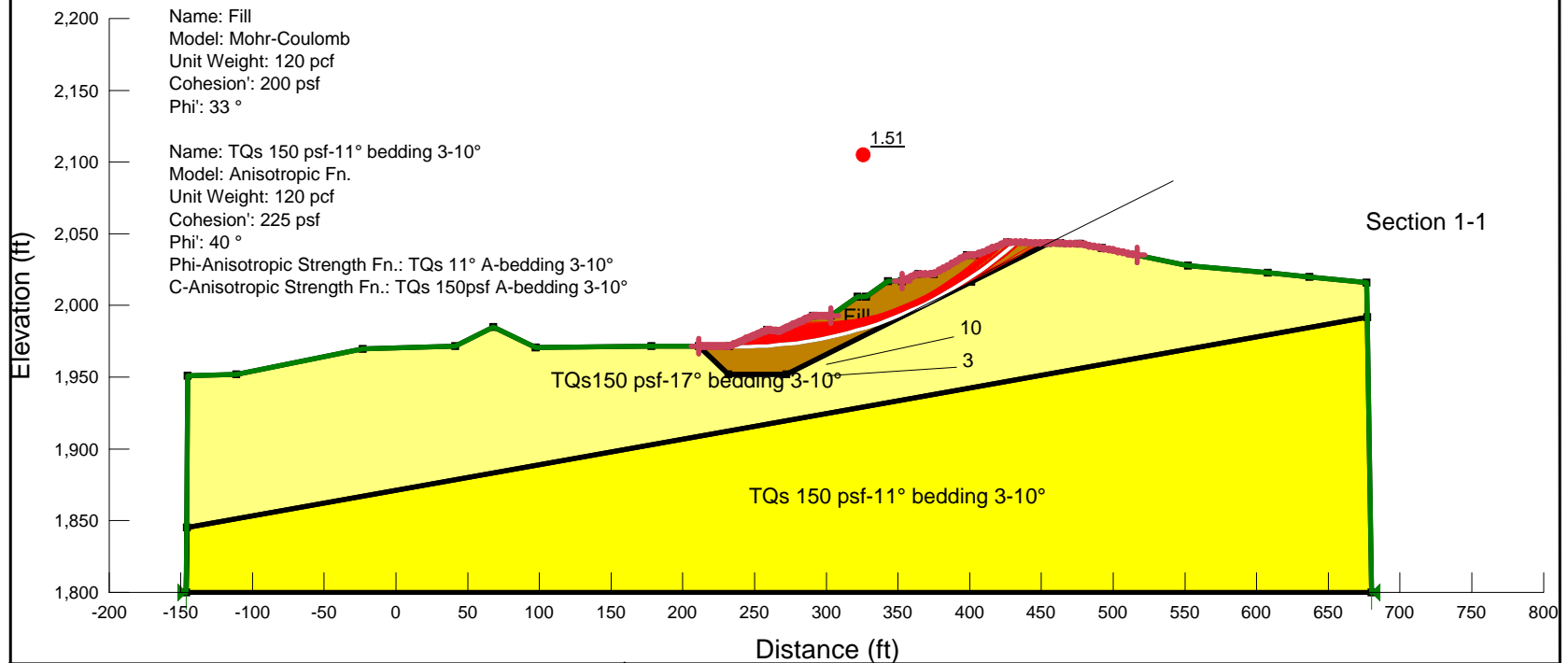

LGC Valley, Inc
 GEOTECHNICAL CONSULTING
 28532 Constellation Road, Valencia, CA 91355
 Phone 661-702-8474, Fax 661-702-8475

Skyline Ranch
 Development project, Tract 60922
 Los Angeles CA

Project No: 153035-01
 Engineer: BAS
 Date: March 2016

1 - Circular Mode of Failure

Report generated using GeoStudio 2012. Copyright © 1991-2016 GEO-SLOPE International Ltd.

File Information

File Version: 8.15
 Title: Static Slope Stability Analyses for Skyline Ranch Development project, Tract 60922, Los Angeles CA
 Comments: Run By: Dr. Alexander Bykovtsev, Ph.D., P.E.
 Last Edited By: Alexander Bykovtsev
 Revision Number: 60
 Date: 3/18/2016
 Time: 7:21:35 PM
 Tool Version: 8.15.5.11777
 File Name: Section 1 SSA for Skyline Ranch Development project.gsz
 Directory: P:\FINAL PROJECTS\PARDEE\Skyline Ranch\SLOPE RESULTS\Section 1-1 results\Latest Update 3-18-16\
 Last Solved Date: 3/18/2016
 Last Solved Time: 7:21:46 PM

Project Settings

Length(L) Units: Feet
 Time(t) Units: Seconds
 Force(F) Units: Pounds
 Pressure(p) Units: psf
 Strength Units: psf
 Unit Weight of Water: 62.4 pcf
 View: 2D
 Element Thickness: 1

Analysis Settings

1 - Circular Mode of Failure

Kind: SLOPE/W
 Method: Bishop
 Settings
 PWP Conditions Source: (none)
 Slip Surface
 Direction of movement: Right to Left
 Use Passive Mode: No
 Slip Surface Option: Entry and Exit
 Critical slip surfaces saved: 10
 Resisting Side Maximum Convex Angle: 1 °
 Driving Side Maximum Convex Angle: 5 °
 Optimize Critical Slip Surface Location: No
 Tension Crack
 Tension Crack Option: (none)

file:///P:/FINAL%20PROJECTS/PARDEE/Skyline%20Ranch/SLOPE%20RESULTS/Sect... 3/18/2016

F of S Distribution
 F of S Calculation Option: Constant
 Advanced
 Number of Slices: 30
 F of S Tolerance: 0.01
 Minimum Slip Surface Depth: 0.1 ft

Materials

TQs150 psf-17° bedding 3-10°

Model: Anisotropic Fn.
 Unit Weight: 120 pcf
 Cohesion': 225 psf
 Phi': 40 °
 Phi-Anisotropic Strength Fn.: TQs 17° A-bedding 3-10°
 C-Anisotropic Strength Fn.: TQs 150psf A-bedding 3-10°
 Phi-B: 0 °

Fill

Model: Mohr-Coulomb
 Unit Weight: 120 pcf
 Cohesion': 200 psf
 Phi': 33 °
 Phi-B: 0 °

TQs 150 psf-11° bedding 3-10°

Model: Anisotropic Fn.
 Unit Weight: 120 pcf
 Cohesion': 225 psf
 Phi': 40 °
 Phi-Anisotropic Strength Fn.: TQs 11° A-bedding 3-10°
 C-Anisotropic Strength Fn.: TQs 150psf A-bedding 3-10°
 Phi-B: 0 °

Slip Surface Entry and Exit

Left Projection: Range
 Left-Zone Left Coordinate: (211,0268, 1,971.6364) ft
 Left-Zone Right Coordinate: (303, 1,993) ft
 Left-Zone Increment: 50
 Right Projection: Range
 Right-Zone Left Coordinate: (353, 2,017) ft
 Right-Zone Right Coordinate: (517, 2,035) ft
 Right-Zone Increment: 50
 Radius Increments: 8

Slip Surface Limits

file:///P:/FINAL%20PROJECTS/PARDEE/Skyline%20Ranch/SLOPE%20RESULTS/Sect... 3/18/2016

Left Coordinate: (-146, 1,800.0439) ft
 Right Coordinate: (680, 1,800) ft

Seismic Coefficients

Horz Seismic Coef.: 0.15
 Vert Seismic Coef.: 0

Anisotropic Strength Functions

TQs 17° A-bedding 3-10°

Model: Spline Data Point Function
 Function: Modifier Factor vs. Inclination
 Curve Fit to Data: 100 %
 Segment Curvature: 0 %
 Y-Intercept: 1
 Data Points: Inclination (°), Modifier Factor
 Data Point: (-90, 1)
 Data Point: (2.9, 1)
 Data Point: (3, 0.425)
 Data Point: (10, 0.425)
 Data Point: (10.1, 1)

TQs 11° A-bedding 3-10°

Model: Spline Data Point Function
 Function: Modifier Factor vs. Inclination
 Curve Fit to Data: 100 %
 Segment Curvature: 0 %
 Y-Intercept: 1
 Data Points: Inclination (°), Modifier Factor
 Data Point: (-90, 1)
 Data Point: (2.9, 1)
 Data Point: (3, 0.275)
 Data Point: (10, 0.275)
 Data Point: (10.1, 1)

TQs 150psf A-bedding 3-10°

Model: Spline Data Point Function
 Function: Modifier Factor vs. Inclination
 Curve Fit to Data: 100 %
 Segment Curvature: 0 %
 Y-Intercept: 1
 Data Points: Inclination (°), Modifier Factor
 Data Point: (-90, 1)
 Data Point: (2.9, 1)
 Data Point: (3, 0.667)
 Data Point: (10, 0.667)
 Data Point: (10.1, 1)

Points

	X (ft)	Y (ft)
Point 1	-145.2287	1,950.7886
Point 2	-111.3064	1,951.8013
Point 3	-22.9567	1,969.775
Point 4	41.3437	1,971.547
Point 5	68.1778	1,984.9641
Point 6	97.5433	1,970.5344
Point 7	178.0454	1,971.547
Point 8	232.4729	1,971.547
Point 9	259	1,983
Point 10	267	1,982
Point 11	291	1,993
Point 12	303	1,993
Point 13	322	2,006
Point 14	328	2,006
Point 15	343	2,017
Point 16	353	2,017
Point 17	364	2,022
Point 18	375	2,022
Point 19	398	2,035
Point 20	404	2,035
Point 21	426	2,044
Point 22	477	2,043
Point 23	492	2,040
Point 24	552	2,028
Point 25	680	1,800
Point 26	-146	1,800.0439
Point 27	677	1,992
Point 28	608	2,022.624
Point 29	636.787	2,019.9606
Point 30	676.6631	2,016.0286
Point 31	-145.6611	1,845.0183
Point 32	210.9608	1,971.6367
Point 33	232	1,952
Point 34	272	1,952
Point 35	401.1176	2,016.6763
Point 36	455.0038	2,043.5159
Point 37	463	2,043.2745

Regions

	Material	Points	Area (ft²)
Region 1	TQs150 psf-17° bedding 3-10°	1,26,31,27,30,29,28,24,23,22,37,36,35,34,33,32,7,6,5,4,3,2	58,736
Region 2	TQs 150 psf-11° bedding 3-10°	27,31,26,25	97,770
Region 3	Fill	32,33,34,35,36,21,20,19,18,17,16,15,14,13,12,11,10,9,8	5,214.9

Current Slip Surface

Slip Surface: 5,277
 F of S: 1.51
 Volume: 3,086.1029 ft³
 Weight: 370,332.35 lbs
 Resisting Moment: 74,997,061 lbs-ft
 Activating Moment: 49,709,909 lbs-ft
 F of S Rank (Analysis): 1 of 23,409 slip surfaces
 F of S Rank (Query): 1 of 150 slip surfaces
 Exit: (232.32332, 1,971.5476) ft
 Entry: (432.26416, 2,043.8954) ft
 Radius: 285.7636 ft
 Center: (242.04047, 2,257.146) ft

Slip Slices

	X (ft)	Y (ft)	PWP (psf)	Base Normal Stress (psf)	Frictional Strength (psf)	Cohesive Strength (psf)
Slice 1	232.39811	1,971.5451	0	4.8038766	3.1196739	200
Slice 2	235.78879	1,971.47	0	185.67664	120.57982	200
Slice 3	242.42056	1,971.4019	0	532.32194	345.69391	200
Slice 4	249.05234	1,971.4877	0	853.83964	554.48994	200
Slice 5	255.68411	1,971.7276	0	1,150.9264	747.42036	200
Slice 6	263	1,972.1803	0	1,190.9856	773.4351	200
Slice 7	270	1,972.7694	0	1,208.5872	784.8657	200
Slice 8	276	1,973.4235	0	1,434.5486	931.60676	200
Slice 9	282	1,974.2062	0	1,641.9022	1,066.2638	200
Slice 10	288	1,975.1188	0	1,830.9429	1,189.0282	200
Slice						



11	294	1,976.1625	0	1,849.0788	1,200.8058	200
Slice 12	300	1,977.3386	0	1,700.5592	1,104.356	200
Slice 13	306.16667	1,978.6893	0	1,771.4753	1,150.4095	200
Slice 14	312.5	1,980.2243	0	2,054.7249	1,334.354	200
Slice 15	318.83333	1,981.9135	0	2,315.7619	1,503.8734	200
Slice 16	325	1,983.7073	0	2,331.0314	1,513.7895	200
Slice 17	331.75	1,985.8575	0	2,366.9524	1,537.1169	200
Slice 18	339.25	1,988.4542	0	2,637.5113	1,712.8198	200
Slice 19	345.5	1,990.782	0	2,652.0503	1,722.2616	200
Slice 20	350.5	1,992.7787	0	2,424.7357	1,574.6418	200
Slice 21	355.75	1,994.9972	0	2,303.5164	1,495.9211	200
Slice 22	361.25	1,997.4524	0	2,284.3097	1,483.4481	200
Slice 23	366.75	2,000.0487	0	2,126.6283	1,381.0485	200
Slice 24	372.25	2,002.7904	0	1,833.9241	1,190.9642	200
Slice 25	378.83333	2,006.2885	0	1,679.5919	1,090.7397	200
Slice 26	386.5	2,010.6251	0	1,651.5099	1,072.5031	200
Slice 27	394.16667	2,015.2825	0	1,592.4049	1,034.1198	200
Slice 28	401	2,019.7019	0	1,356.7933	881.11185	200
Slice 29	407.66667	2,024.3187	0	1,047.3923	680.1845	200
Slice 30	415	2,029.7155	0	809.05486	525.40637	200
Slice 31	422.33333	2,035.4864	0	543.86506	353.1901	200
Slice 32	429.13208	2,041.1821	0	158.28261	102.78993	200

Section 1 SSA for Skyline Ranch Development project.gsz

Section 1 SSA for Skyline Ranch Development project.gsz Run By: Dr. Alexander Bykovtsev, Ph.D., P.E. 3/18/2016 7:21:35 PM

Name: TQs150 psf-17° bedding 3-10°
 Model: Anisotropic Fn.
 Unit Weight: 120 pcf
 Cohesion: 225 psf
 Phi: 40 °
 Phi-Anisotropic Strength Fn.: TQs 17° A-bedding 3-10°
 C-Anisotropic Strength Fn.: TQs 150psf A-bedding 3-10°

Static - Translational

Materials	
	TQs150 psf-17° bedding 3-10°
	Fill
	TQs 150 psf-11° bedding 3-10°

Key 40 Feet Wide by 20 feet Deep 2H:1V Backcut

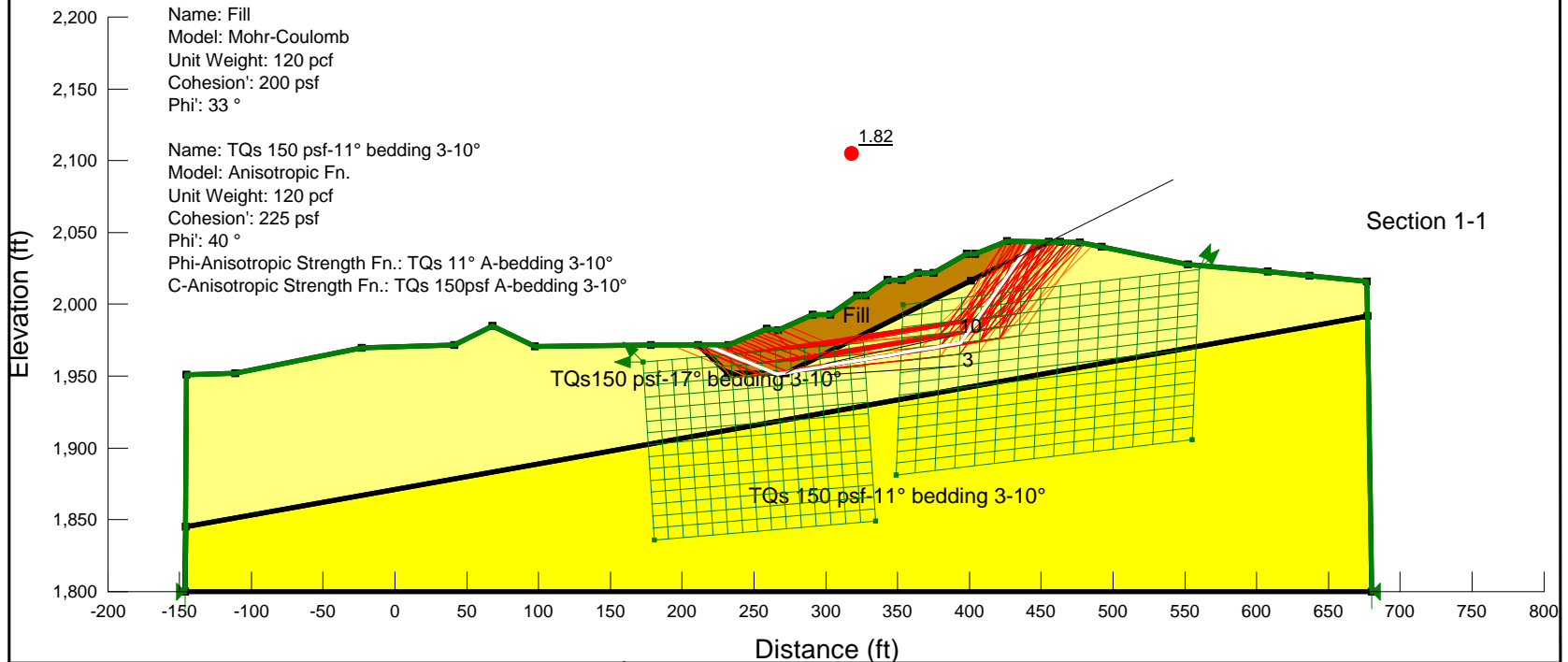

	LGC Valley, Inc
	GEOTECHNICAL CONSULTING
	28532 Constellation Road, Valencia, CA 91355 Phone 661-702-8474, Fax 661-702-8475

Skyline Ranch
Development project, Tract 60922
Los Angeles CA

Project No:	153035-01
Engineer:	BAS
Date:	March 2016

2 - Translational Static

Report generated using GeoStudio 2012. Copyright © 1991-2016 GEO-SLOPE International Ltd.

File Information

File Version: 8.15
 Title: Static Slope Stability Analyses for Skyline Ranch Development project, Tract 60922, Los Angeles CA
 Comments: Run By: Dr. Alexander Bykovtsev, Ph.D., P.E.
 Last Edited By: Alexander Bykovtsev
 Revision Number: 60
 Date: 3/18/2016
 Time: 7:21:35 PM
 Tool Version: 8.15.5.11777
 File Name: Section 1 SSA for Skyline Ranch Development project.gsz
 Directory: P:\FINAL PROJECTS\PARDEE\Skyline Ranch\SLOPE RESULTS\Section 1-1 results\Latest Update 3-18-16\
 Last Solved Date: 3/18/2016
 Last Solved Time: 7:26:40 PM

Project Settings

Length(L) Units: Feet
 Time(t) Units: Seconds
 Force(F) Units: Pounds
 Pressure(p) Units: psf
 Strength Units: psf
 Unit Weight of Water: 62.4 pcf
 View: 2D
 Element Thickness: 1

Analysis Settings

2 - Translational Static

Kind: SLOPE/W
 Method: Janbu
 Settings
 PWP Conditions Source: (none)
 Slip Surface
 Direction of movement: Right to Left
 Use Passive Mode: No
 Slip Surface Option: Block
 Critical slip surfaces saved: 10
 Resisting Side Maximum Convex Angle: 1 °
 Driving Side Maximum Convex Angle: 5 °
 Restrict Block Crossing: No
 Optimize Critical Slip Surface Location: Yes
 Critical Slip Surface Optimizations

file:///P:/FINAL%20PROJECTS/PARDEE/Skyline%20Ranch/SLOPE%20RESULTS/Sect... 3/18/2016

Maximum Iterations: 2,000
 Convergence Tolerance: 1e-007
 Starting Points: 8
 Ending Points: 16
 Complete Passes per Insertion: 1
 Tension Crack
 Tension Crack Option: (none)
 F of S Distribution
 F of S Calculation Option: Constant
 Advanced
 Number of Slices: 30
 F of S Tolerance: 0.01
 Minimum Slip Surface Depth: 0.1 ft

Materials

TQs150 psf-17° bedding 3-10°

Model: Anisotropic Fn.
 Unit Weight: 120 pcf
 Cohesion': 225 psf
 Phi': 40 °
 Phi-Anisotropic Strength Fn.: TQs 17° A-bedding 3-10°
 C-Anisotropic Strength Fn.: TQs 150psf A-bedding 3-10°
 Phi-B: 0 °

Fill

Model: Mohr-Coulomb
 Unit Weight: 120 pcf
 Cohesion': 200 psf
 Phi': 33 °
 Phi-B: 0 °

TQs 150 psf-11° bedding 3-10°

Model: Anisotropic Fn.
 Unit Weight: 120 pcf
 Cohesion': 225 psf
 Phi': 40 °
 Phi-Anisotropic Strength Fn.: TQs 11° A-bedding 3-10°
 C-Anisotropic Strength Fn.: TQs 150psf A-bedding 3-10°
 Phi-B: 0 °

Slip Surface Limits

Left Coordinate: (-146, 1,800.0439) ft
 Right Coordinate: (680, 1,800) ft

Slip Surface Block

file:///P:/FINAL%20PROJECTS/PARDEE/Skyline%20Ranch/SLOPE%20RESULTS/Sect... 3/18/2016

Left Grid

Upper Left: (172.7791, 1,959.785) ft
 Lower Left: (180.8055, 1,835.8451) ft
 Lower Right: (334.4512, 1,849.3658) ft
 X Increments: 15
 Y Increments: 15
 Starting Angle: 135 °
 Ending Angle: 180 °
 Angle Increments: 2

Right Grid

Upper Left: (353.639, 1,999.7263) ft
 Lower Left: (348.7613, 1,881.1947) ft
 Lower Right: (555.0728, 1,905.9035) ft
 X Increments: 15
 Y Increments: 15
 Starting Angle: 45 °
 Ending Angle: 65 °
 Angle Increments: 2

Seismic Coefficients

Horz Seismic Coef.: 0
 Vert Seismic Coef.: 0

Anisotropic Strength Functions

TQs 17° A-bedding 3-10°

Model: Spline Data Point Function
 Function: Modifier Factor vs. Inclination
 Curve Fit to Data: 100 %
 Segment Curvature: 0 %
 Y-Intercept: 1
 Data Points: Inclination (°), Modifier Factor
 Data Point: (-90, 1)
 Data Point: (2.9, 1)
 Data Point: (3, 0.425)
 Data Point: (10, 0.425)
 Data Point: (10.1, 1)

TQs 11° A-bedding 3-10°

Model: Spline Data Point Function
 Function: Modifier Factor vs. Inclination
 Curve Fit to Data: 100 %
 Segment Curvature: 0 %
 Y-Intercept: 1
 Data Points: Inclination (°), Modifier Factor
 Data Point: (-90, 1)
 Data Point: (2.9, 1)
 Data Point: (3, 0.275)

Data Point: (10, 0.275)
 Data Point: (10.1, 1)

TQs 150psf A-bedding 3-10°

Model: Spline Data Point Function
 Function: Modifier Factor vs. Inclination
 Curve Fit to Data: 100 %
 Segment Curvature: 0 %
 Y-Intercept: 1
 Data Points: Inclination (°), Modifier Factor
 Data Point: (-90, 1)
 Data Point: (2.9, 1)
 Data Point: (3, 0.667)
 Data Point: (10, 0.667)
 Data Point: (10.1, 1)

Points

	X (ft)	Y (ft)
Point 1	-145.2287	1,950.7886
Point 2	-111.3064	1,951.8013
Point 3	-22.9567	1,969.775
Point 4	41.3437	1,971.547
Point 5	68.1778	1,984.9641
Point 6	97.5433	1,970.5344
Point 7	178.0454	1,971.547
Point 8	232.4729	1,971.547
Point 9	259	1,983
Point 10	267	1,982
Point 11	291	1,993
Point 12	303	1,993
Point 13	322	2,006
Point 14	328	2,006
Point 15	343	2,017
Point 16	353	2,017
Point 17	364	2,022
Point 18	375	2,022
Point 19	398	2,035
Point 20	404	2,035
Point 21	426	2,044
Point 22	477	2,043
Point 23	492	2,040
Point 24	552	2,028
Point 25	680	1,800
Point 26	-146	1,800.0439
Point 27	677	1,992

Point 28	608	2,022.624
Point 29	636.787	2,019.9606
Point 30	676.6631	2,016.0286
Point 31	-145.6611	1,845.0183
Point 32	210.9608	1,971.6367
Point 33	232	1,952
Point 34	272	1,952
Point 35	401.1176	2,016.6763
Point 36	455.0038	2,043.5159
Point 37	463	2,043.2745

Regions

	Material	Points	Area (ft²)
Region 1	TQs150 psf-17° bedding 3-10°	1,26,31,27,30,29,28,24,23,22,37,36,35,34,33,32,7,6,5,4,3,2	58,736
Region 2	TQs 150 psf-11° bedding 3-10°	27,31,26,25	97,770
Region 3	Fill	32,33,34,35,36,21,20,19,18,17,16,15,14,13,12,11,10,9,8	5,214.9

Current Slip Surface

Slip Surface: 589,825
 F of S: 1.82
 Volume: 8,033.6946 ft³
 Weight: 964,043.36 lbs
 Resisting Force: 408,149.68 lbs
 Activating Force: 224,373.76 lbs
 F of S Rank (Analysis): 1 of 589,825 slip surfaces
 F of S Rank (Query): 1 of 150 slip surfaces
 Exit: (217.1762, 1,971.6108) ft
 Entry: (443.07401, 2,043.715) ft
 Radius: 121.28783 ft
 Center: (312.86392, 2,061.7411) ft

Slip Slices

	X (ft)	Y (ft)	PWP (psf)	Base Normal Stress (psf)	Frictional Strength (psf)	Cohesive Strength (psf)
Slice 1	221.00038	1,970.0268	0	274.47961	178.24915	200
Slice 2	228.64873	1,966.8587	0	716.28741	465.16248	200
Slice 3	235.78879	1,963.9012	0	1,332.3626	865.2464	200
Slice						

4	242.42056	1,961.1542	0	2,122.7053	1,378.5009	200
Slice 5	249.05234	1,958.4073	0	2,913.0479	1,891.7554	200
Slice 6	255.68411	1,955.6603	0	3,703.3905	2,405.0099	200
Slice 7	261.76041	1,953.1434	0	4,211.0296	2,734.6746	200
Slice 8	265.27876	1,951.6861	0	4,594.5443	3,855.2804	225
Slice 9	266.51835	1,951.454	0	3,556.8443	1,087.4364	150.075
Slice 10	268.36498	1,951.7679	0	3,586.1793	1,096.405	150.075
Slice 11	271.44815	1,952.2921	0	3,573.515	2,320.6678	200
Slice 12	277.62475	1,953.3422	0	3,897.6348	1,191.6266	150.075
Slice 13	286.54158	1,954.8582	0	4,197.5552	1,283.3214	150.075
Slice 14	294	1,956.1262	0	4,288.0144	1,310.9776	150.075
Slice 15	300	1,957.1463	0	4,169.0125	1,274.595	150.075
Slice 16	306.16667	1,958.1947	0	4,299.4673	1,314.4791	150.075
Slice 17	312.5	1,959.2715	0	4,679.379	1,430.6297	150.075
Slice 18	318.83333	1,960.3482	0	5,059.2906	1,546.7804	150.075
Slice 19	325	1,961.3966	0	5,189.7455	1,586.6644	150.075
Slice 20	331.75	1,962.5442	0	5,376.6821	1,643.8167	150.075
Slice 21	339.25	1,963.8193	0	5,869.5573	1,794.5038	150.075
Slice 22	348	1,965.3069	0	6,016.8266	1,839.5285	150.075
Slice 23	358.5	1,967.0921	0	6,100.2222	1,865.0251	150.075
Slice 24	369.5	1,968.9622	0	6,173.7008	1,887.4898	150.075
Slice 25	379.65015	1,970.6879	0	6,279.0077	1,919.6853	150.075
Slice 26	388.95044	1,972.269	0	6,707.7916	2,050.7777	150.075
Slice 27	395.80029	1,976.2011	0	4,053.6249	3,401.3952	225

Slice 28	399.5588	1,981.5689	0	3,755.5039	3,151.2419	225
Slice 29	402.5588	1,985.8533	0	3,445.814	2,891.3813	225
Slice 30	407.66667	1,993.1481	0	3,026.9528	2,539.915	225
Slice 31	415	2,003.6212	0	2,486.7804	2,086.6565	225
Slice 32	422.33333	2,014.0943	0	1,946.608	1,633.398	225
Slice 33	431.23558	2,026.808	0	1,129.7361	947.96114	225
Slice 34	439.77259	2,039.0001	0	274.70357	178.39458	200

Section 1 SSA for Skyline Ranch Development project.gsz

Section 1 SSA for Skyline Ranch Development project.gsz Run By: Dr. Alexander Bykovtsev, Ph.D., P.E. 3/18/2016 7:21:35 PM

Name: TQs150 psf-17° bedding 3-10°
 Model: Anisotropic Fn.
 Unit Weight: 120 pcf
 Cohesion: 225 psf
 Phi: 40 °
 Phi-Anisotropic Strength Fn.: TQs 17° A-bedding 3-10°
 C-Anisotropic Strength Fn.: TQs 150psf A-bedding 3-10°

Seismic Load
 Horizontal: 0.15
 Vertical: 0.0

Materials	
	TQs150 psf-17° bedding 3-10°
	Fill
	TQs 150 psf-11° bedding 3-10°

Pseudostatic - Translational

Key 40 Feet Wide by 20 feet Deep 2H:1V Backcut

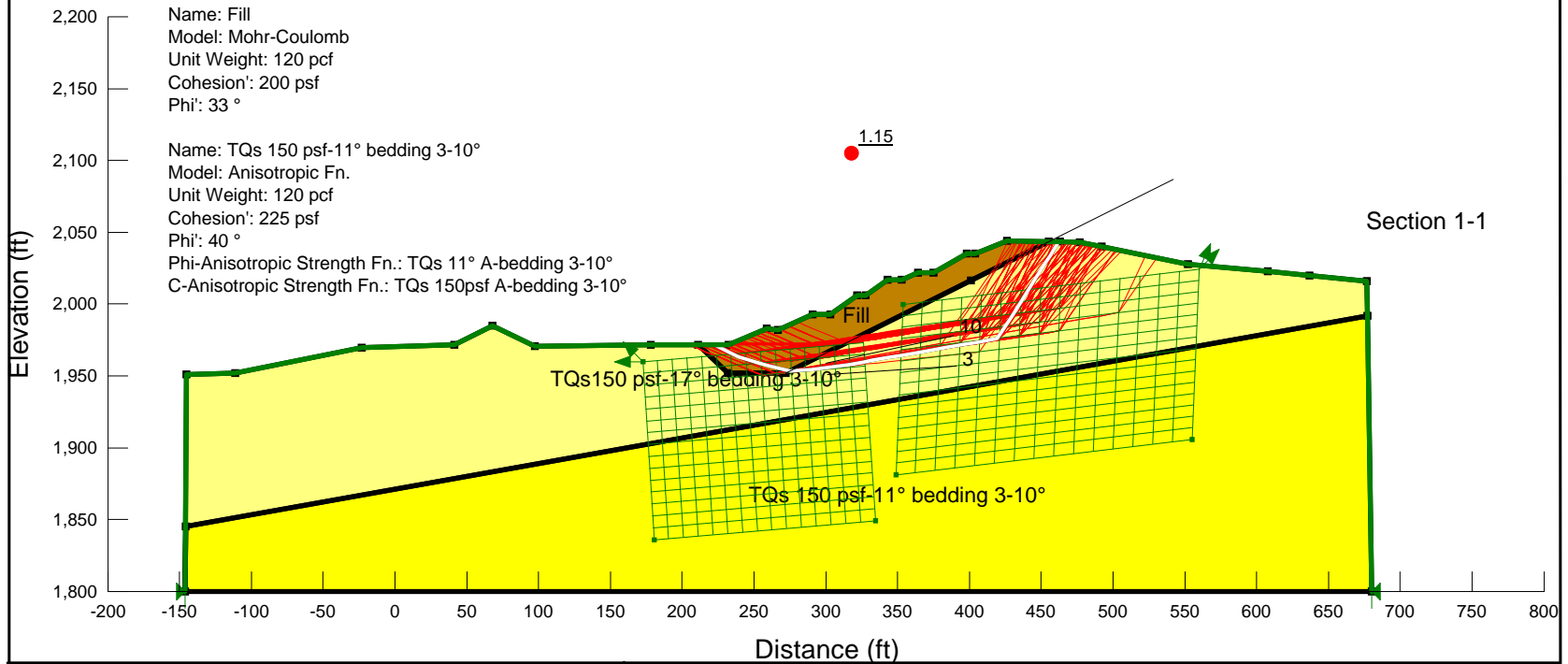

LGC Valley, Inc
 GEOTECHNICAL CONSULTING
 28532 Constellation Road, Valencia, CA 91355
 Phone 661-702-8474, Fax 661-702-8475

Skyline Ranch
 Development project, Tract 60922
 Los Angeles CA

Project No: 153035-01
 Engineer: BAS
 Date: March 2016

2 - Translational

Report generated using GeoStudio 2012. Copyright © 1991-2016 GEO-SLOPE International Ltd.

File Information

File Version: 8.15
 Title: Static Slope Stability Analyses for Skyline Ranch Development project, Tract 60922, Los Angeles CA
 Comments: Run By: Dr. Alexander Bykovtsev, Ph.D., P.E.
 Last Edited By: Alexander Bykovtsev
 Revision Number: 60
 Date: 3/18/2016
 Time: 7:21:35 PM
 Tool Version: 8.15.5.11777
 File Name: Section 1 SSA for Skyline Ranch Development project.gsz
 Directory: P:\FINAL PROJECTS\PARDEE\Skyline Ranch\SLOPE RESULTS\Section 1-1 results\Latest Update 3-18-16\
 Last Solved Date: 3/18/2016
 Last Solved Time: 7:23:50 PM

Project Settings

Length(L) Units: Feet
 Time(t) Units: Seconds
 Force(F) Units: Pounds
 Pressure(p) Units: psf
 Strength Units: psf
 Unit Weight of Water: 62.4 pcf
 View: 2D
 Element Thickness: 1

Analysis Settings

2 - Translational

Kind: SLOPE/W
 Method: Janbu
 Settings
 PWP Conditions Source: (none)
 Slip Surface
 Direction of movement: Right to Left
 Use Passive Mode: No
 Slip Surface Option: Block
 Critical slip surfaces saved: 10
 Resisting Side Maximum Convex Angle: 1 °
 Driving Side Maximum Convex Angle: 5 °
 Restrict Block Crossing: No
 Optimize Critical Slip Surface Location: Yes
 Critical Slip Surface Optimizations

file:///P:/FINAL%20PROJECTS/PARDEE/Skyline%20Ranch/SLOPE%20RESULTS/Sect... 3/18/2016

Maximum Iterations: 2,000
 Convergence Tolerance: 1e-007
 Starting Points: 8
 Ending Points: 16
 Complete Passes per Insertion: 1
 Tension Crack
 Tension Crack Option: (none)
 F of S Distribution
 F of S Calculation Option: Constant
 Advanced
 Number of Slices: 30
 F of S Tolerance: 0.01
 Minimum Slip Surface Depth: 0.1 ft

Materials

TQs150 psf-17° bedding 3-10°

Model: Anisotropic Fn.
 Unit Weight: 120 pcf
 Cohesion': 225 psf
 Phi': 40 °
 Phi-Anisotropic Strength Fn.: TQs 17° A-bedding 3-10°
 C-Anisotropic Strength Fn.: TQs 150psf A-bedding 3-10°
 Phi-B: 0 °

Fill

Model: Mohr-Coulomb
 Unit Weight: 120 pcf
 Cohesion': 200 psf
 Phi': 33 °
 Phi-B: 0 °

TQs 150 psf-11° bedding 3-10°

Model: Anisotropic Fn.
 Unit Weight: 120 pcf
 Cohesion': 225 psf
 Phi': 40 °
 Phi-Anisotropic Strength Fn.: TQs 11° A-bedding 3-10°
 C-Anisotropic Strength Fn.: TQs 150psf A-bedding 3-10°
 Phi-B: 0 °

Slip Surface Limits

Left Coordinate: (-146, 1,800.0439) ft
 Right Coordinate: (680, 1,800) ft

Slip Surface Block

file:///P:/FINAL%20PROJECTS/PARDEE/Skyline%20Ranch/SLOPE%20RESULTS/Sect... 3/18/2016

Left Grid

Upper Left: (172.7791, 1,959.785) ft
 Lower Left: (180.8055, 1,835.8451) ft
 Lower Right: (334.4512, 1,849.3658) ft
 X Increments: 15
 Y Increments: 15
 Starting Angle: 135 °
 Ending Angle: 180 °
 Angle Increments: 2

Right Grid

Upper Left: (353.639, 1,999.7263) ft
 Lower Left: (348.7613, 1,881.1947) ft
 Lower Right: (555.0728, 1,905.9035) ft
 X Increments: 15
 Y Increments: 15
 Starting Angle: 45 °
 Ending Angle: 65 °
 Angle Increments: 2

Seismic Coefficients

Horz Seismic Coef.: 0.15
 Vert Seismic Coef.: 0

Anisotropic Strength Functions

TQs 17° A-bedding 3-10°

Model: Spline Data Point Function
 Function: Modifier Factor vs. Inclination
 Curve Fit to Data: 100 %
 Segment Curvature: 0 %
 Y-Intercept: 1
 Data Points: Inclination (°), Modifier Factor
 Data Point: (-90, 1)
 Data Point: (2.9, 1)
 Data Point: (3, 0.425)
 Data Point: (10, 0.425)
 Data Point: (10.1, 1)

TQs 11° A-bedding 3-10°

Model: Spline Data Point Function
 Function: Modifier Factor vs. Inclination
 Curve Fit to Data: 100 %
 Segment Curvature: 0 %
 Y-Intercept: 1
 Data Points: Inclination (°), Modifier Factor
 Data Point: (-90, 1)
 Data Point: (2.9, 1)
 Data Point: (3, 0.275)

Data Point: (10, 0.275)
 Data Point: (10.1, 1)

TQs 150psf A-bedding 3-10°

Model: Spline Data Point Function
 Function: Modifier Factor vs. Inclination
 Curve Fit to Data: 100 %
 Segment Curvature: 0 %
 Y-Intercept: 1
 Data Points: Inclination (°), Modifier Factor
 Data Point: (-90, 1)
 Data Point: (2.9, 1)
 Data Point: (3, 0.667)
 Data Point: (10, 0.667)
 Data Point: (10.1, 1)

Points

	X (ft)	Y (ft)
Point 1	-145.2287	1,950.7886
Point 2	-111.3064	1,951.8013
Point 3	-22.9567	1,969.775
Point 4	41.3437	1,971.547
Point 5	68.1778	1,984.9641
Point 6	97.5433	1,970.5344
Point 7	178.0454	1,971.547
Point 8	232.4729	1,971.547
Point 9	259	1,983
Point 10	267	1,982
Point 11	291	1,993
Point 12	303	1,993
Point 13	322	2,006
Point 14	328	2,006
Point 15	343	2,017
Point 16	353	2,017
Point 17	364	2,022
Point 18	375	2,022
Point 19	398	2,035
Point 20	404	2,035
Point 21	426	2,044
Point 22	477	2,043
Point 23	492	2,040
Point 24	552	2,028
Point 25	680	1,800
Point 26	-146	1,800.0439
Point 27	677	1,992

Point 28	608	2,022.624
Point 29	636.787	2,019.9606
Point 30	676.6631	2,016.0286
Point 31	-145.6611	1,845.0183
Point 32	210.9608	1,971.6367
Point 33	232	1,952
Point 34	272	1,952
Point 35	401.1176	2,016.6763
Point 36	455.0038	2,043.5159
Point 37	463	2,043.2745

Regions

	Material	Points	Area (ft²)
Region 1	TQs150 psf-17° bedding 3-10°	1,26,31,27,30,29,28,24,23,22,37,36,35,34,33,32,7,6,5,4,3,2	58,736
Region 2	TQs 150 psf-11° bedding 3-10°	27,31,26,25	97,770
Region 3	Fill	32,33,34,35,36,21,20,19,18,17,16,15,14,13,12,11,10,9,8	5,214.9

Current Slip Surface

Slip Surface: 589,825
 F of S: 1.15
 Volume: 9,608.0564 ft³
 Weight: 1,152,966.8 lbs
 Resisting Force: 445,071.18 lbs
 Activating Force: 387,160.56 lbs
 F of S Rank (Analysis): 1 of 589,825 slip surfaces
 F of S Rank (Query): 1 of 150 slip surfaces
 Exit: (222.57809, 1,971.5883) ft
 Entry: (462.00622, 2,043.3045) ft
 Radius: 124.67095 ft
 Center: (327.21648, 2,061.0703) ft

Slip Slices

	X (ft)	Y (ft)	PWP (psf)	Base Normal Stress (psf)	Frictional Strength (psf)	Cohesive Strength (psf)
Slice 1	227.52549	1,969.0876	0	538.25891	349.54942	200
Slice 2	235.8569	1,964.8765	0	1,485.9458	964.98447	200
Slice 3	242.46355	1,962.1795	0	2,047.4326	1,329.6183	200
Slice						

4	248.90885	1,960.2063	0	2,736.9081	1,777.3689	200
Slice 5	255.56575	1,958.3889	0	3,261.221	2,117.8617	200
Slice 6	263	1,956.5904	0	3,647.5504	2,368.7469	200
Slice 7	271.0835	1,954.6349	0	4,109.7149	2,668.8801	200
Slice 8	278.93486	1,953.8491	0	3,971.1117	1,214.0907	150.075
Slice 9	286.40281	1,954.2498	0	4,328.6894	1,323.4132	150.075
Slice 10	290.55145	1,954.5027	0	4,436.6505	1,356.4202	150.075
Slice 11	294	1,954.9211	0	4,411.9093	1,348.856	150.075
Slice 12	300	1,955.649	0	4,327.2766	1,322.9812	150.075
Slice 13	306.3637	1,956.4211	0	4,505.0923	1,377.3449	150.075
Slice 14	312.79555	1,957.3661	0	4,833.5532	1,477.7655	150.075
Slice 15	318.93185	1,958.4398	0	5,191.9174	1,587.3285	150.075
Slice 16	325	1,959.5016	0	5,310.8968	1,623.7041	150.075
Slice 17	329.7626	1,960.335	0	5,363.5609	1,639.8051	150.075
Slice 18	337.2626	1,961.6505	0	5,842.5533	1,786.2478	150.075
Slice 19	348	1,963.5354	0	6,108.8792	1,867.6718	150.075
Slice 20	355.7575	1,964.8971	0	6,096.4554	1,863.8735	150.075
Slice 21	361.2575	1,965.8572	0	6,276.4255	1,918.8958	150.075
Slice 22	365.8371	1,966.652	0	6,328.2517	1,934.7407	150.075
Slice 23	371.3371	1,967.6155	0	6,213.5901	1,899.6851	150.075
Slice 24	379.8241	1,969.1092	0	6,354.962	1,942.9069	150.075
Slice 25	389.4723	1,970.8072	0	6,785.5288	2,074.5443	150.075
Slice 26	396.1482	1,971.9824	0	7,083.079	2,165.5146	150.075
Slice 27	399.5588	1,972.5833	0	7,134.1938	2,181.1419	150.075

Slice 28	402.5588	1,973.1118	0	7,073.6011	2,162.6169	150.075
Slice 29	407.85307	1,974.0444	0	7,147.3875	2,185.1757	150.075
Slice 30	415.55923	1,975.402	0	7,353.1779	2,248.0921	150.075
Slice 31	422.70615	1,981.1723	0	3,331.9642	2,795.8499	225
Slice 32	427.54145	1,988.6466	0	2,984.3264	2,504.1472	225
Slice 33	433.2698	1,997.6163	0	2,446.5865	2,052.9298	225
Slice 34	442.2522	2,011.8137	0	1,634.576	1,371.5722	225
Slice 35	451.02575	2,025.6884	0	858.03091	719.97342	225
Slice 36	455.5827	2,032.8642	0	451.85408	379.15059	225
Slice 37	459.08391	2,038.5402	0	121.0361	101.56135	225

Section 1 SSA for Skyline Ranch Development project.gsz

Section 1 SSA for Skyline Ranch Development project.gsz Run By: Dr. Alexander Bykovtsev, Ph.D., P.E. 3/18/2016 7:21:35 PM

Materials

- TQs150 psf-17° bedding 3-10°
- TQs 150 psf-11° bedding 3-10°

Temporary 2H:1V Backcut Analysis

Key 40 Feet Wide by 20 feet Deep 2H:1V Backcut

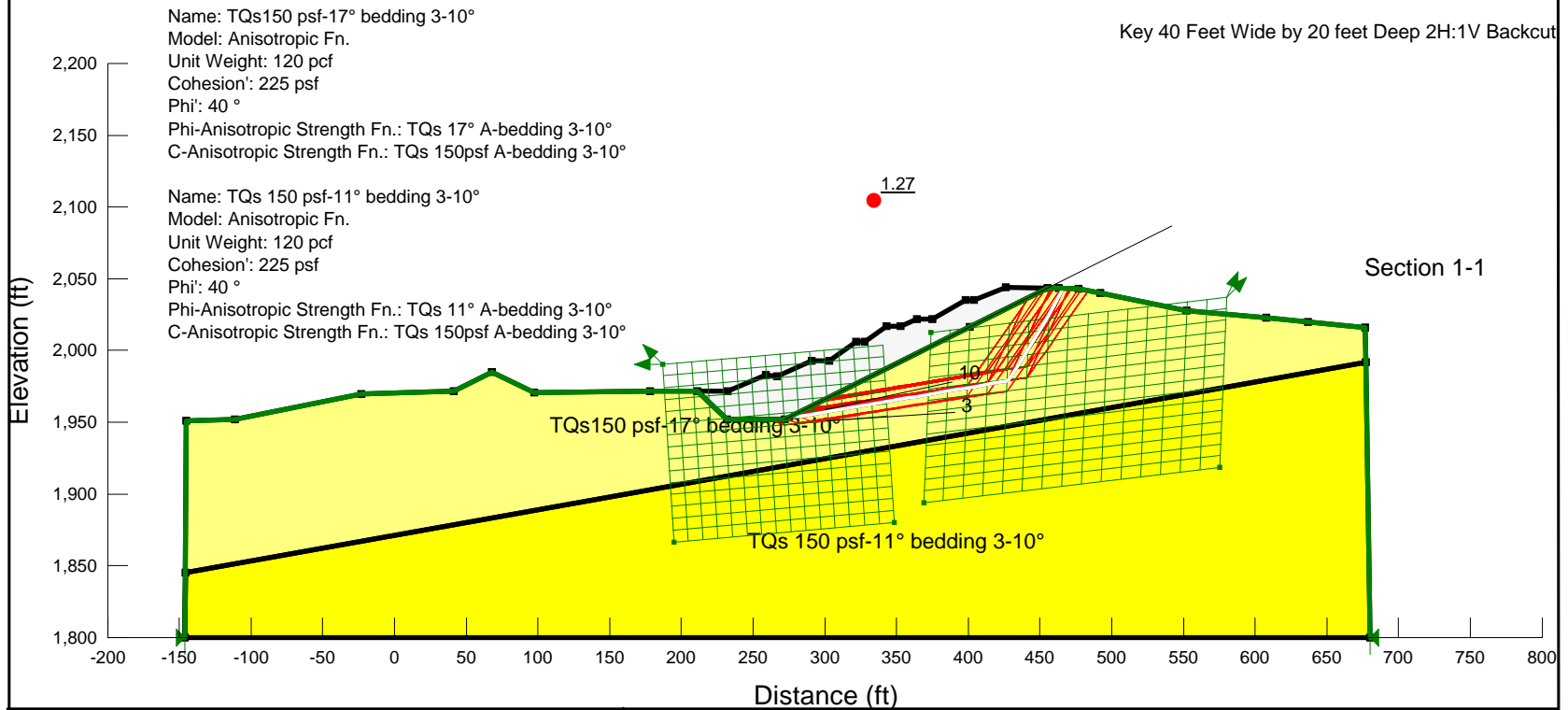

LGC Valley, Inc
 GEOTECHNICAL CONSULTING
 28532 Constellation Road, Valencia, CA 91355
 Phone 661-702-8474, Fax 661-702-8475

Skyline Ranch
Development project, Tract 60922
Los Angeles CA

Project No: **153035-01**
 Engineer: **BAS**
 Date: **March 2016**

Temp analysis

Report generated using GeoStudio 2012. Copyright © 1991-2016 GEO-SLOPE International Ltd.

File Information

File Version: 8.15
 Title: *Static Slope Stability Analyses for Skyline Ranch Development project, Tract 60922, Los Angeles CA*
 Comments: Run By: Dr. Alexander Bykovtsev, Ph.D., P.E.
 Last Edited By: Alexander Bykovtsev
 Revision Number: 60
 Date: 3/18/2016
 Time: 7:21:35 PM
 Tool Version: 8.15.5.11777
 File Name: Section 1 SSA for Skyline Ranch Development project.gsz
 Directory: P:\FINAL PROJECTS\PARDEE\Skyline Ranch\SLOPE RESULTS\Section 1-1 results\Latest Update 3-18-16\
 Last Solved Date: 3/18/2016
 Last Solved Time: 7:27:52 PM

Project Settings

Length(L) Units: Feet
 Time(t) Units: Seconds
 Force(F) Units: Pounds
 Pressure(p) Units: psf
 Strength Units: psf
 Unit Weight of Water: 62.4 pcf
 View: 2D
 Element Thickness: 1

Analysis Settings

Temp analysis

Kind: SLOPE/W
 Method: Janbu
 Settings
 PWP Conditions Source: (none)
 Slip Surface
 Direction of movement: Right to Left
 Use Passive Mode: No
 Slip Surface Option: Block
 Critical slip surfaces saved: 10
 Resisting Side Maximum Convex Angle: 1 °
 Driving Side Maximum Convex Angle: 5 °
 Restrict Block Crossing: No
 Optimize Critical Slip Surface Location: Yes
 Critical Slip Surface Optimizations

file:///P:/FINAL%20PROJECTS/PARDEE/Skyline%20Ranch/SLOPE%20RESULTS/Sect... 3/18/2016

Maximum Iterations: 2,000
 Convergence Tolerance: 1e-007
 Starting Points: 8
 Ending Points: 16
 Complete Passes per Insertion: 1
 Tension Crack
 Tension Crack Option: (none)
 F of S Distribution
 F of S Calculation Option: Constant
 Advanced
 Number of Slices: 30
 F of S Tolerance: 0.01
 Minimum Slip Surface Depth: 0.1 ft

Materials

TQs150 psf-17° bedding 3-10°

Model: Anisotropic Fn.
 Unit Weight: 120 pcf
 Cohesion': 225 psf
 Phi': 40 °
 Phi-Anisotropic Strength Fn.: TQs 17° A-bedding 3-10°
 C-Anisotropic Strength Fn.: TQs 150psf A-bedding 3-10°
 Phi-B: 0 °

TQs 150 psf-11° bedding 3-10°

Model: Anisotropic Fn.
 Unit Weight: 120 pcf
 Cohesion': 225 psf
 Phi': 40 °
 Phi-Anisotropic Strength Fn.: TQs 11° A-bedding 3-10°
 C-Anisotropic Strength Fn.: TQs 150psf A-bedding 3-10°
 Phi-B: 0 °

Slip Surface Limits

Left Coordinate: (-146, 1,800.0439) ft
 Right Coordinate: (680, 1,800) ft

Slip Surface Block

Left Grid
 Upper Left: (186.8493, 1,990.3033) ft
 Lower Left: (194.8757, 1,866.3634) ft
 Lower Right: (348.5214, 1,879.8841) ft
 X Increments: 15
 Y Increments: 15
 Starting Angle: 135 °

file:///P:/FINAL%20PROJECTS/PARDEE/Skyline%20Ranch/SLOPE%20RESULTS/Sect... 3/18/2016

Ending Angle: 180 °
 Angle Increments: 2
 Right Grid
 Upper Left: (374.0506, 2,012.4093) ft
 Lower Left: (369.1729, 1,893.8777) ft
 Lower Right: (575.4844, 1,918.5865) ft
 X Increments: 15
 Y Increments: 15
 Starting Angle: 45 °
 Ending Angle: 65 °
 Angle Increments: 2

Seismic Coefficients

Horz Seismic Coef.: 0
 Vert Seismic Coef.: 0

Anisotropic Strength Functions

TQs 17° A-bedding 3-10°

Model: Spline Data Point Function
 Function: Modifier Factor vs. Inclination
 Curve Fit to Data: 100 %
 Segment Curvature: 0 %
 Y-Intercept: 1
 Data Points: Inclination (°), Modifier Factor
 Data Point: (-90, 1)
 Data Point: (2.9, 1)
 Data Point: (3, 0.425)
 Data Point: (10, 0.425)
 Data Point: (10.1, 1)

TQs 11° A-bedding 3-10°

Model: Spline Data Point Function
 Function: Modifier Factor vs. Inclination
 Curve Fit to Data: 100 %
 Segment Curvature: 0 %
 Y-Intercept: 1
 Data Points: Inclination (°), Modifier Factor
 Data Point: (-90, 1)
 Data Point: (2.9, 1)
 Data Point: (3, 0.275)
 Data Point: (10, 0.275)
 Data Point: (10.1, 1)

TQs 150psf A-bedding 3-10°

Model: Spline Data Point Function
 Function: Modifier Factor vs. Inclination
 Curve Fit to Data: 100 %

Segment Curvature: 0 %
 Y-Intercept: 1
 Data Points: Inclination (°), Modifier Factor
 Data Point: (-90, 1)
 Data Point: (2.9, 1)
 Data Point: (3, 0.667)
 Data Point: (10, 0.667)
 Data Point: (10.1, 1)

Points

	X (ft)	Y (ft)
Point 1	-145.2287	1,950.7886
Point 2	-111.3064	1,951.8013
Point 3	-22.9567	1,969.775
Point 4	41.3437	1,971.547
Point 5	68.1778	1,984.9641
Point 6	97.5433	1,970.5344
Point 7	178.0454	1,971.547
Point 8	232.4729	1,971.547
Point 9	259	1,983
Point 10	267	1,982
Point 11	291	1,993
Point 12	303	1,993
Point 13	322	2,006
Point 14	328	2,006
Point 15	343	2,017
Point 16	353	2,017
Point 17	364	2,022
Point 18	375	2,022
Point 19	398	2,035
Point 20	404	2,035
Point 21	426	2,044
Point 22	477	2,043
Point 23	492	2,040
Point 24	552	2,028
Point 25	680	1,800
Point 26	-146	1,800.0439
Point 27	677	1,992
Point 28	608	2,022.624
Point 29	636.787	2,019.9606
Point 30	676.6631	2,016.0286
Point 31	-145.6611	1,845.0183
Point 32	210.9608	1,971.6367
Point 33	232	1,952

Point 34	272	1,952
Point 35	401.1176	2,016.6763
Point 36	455.0038	2,043.5159
Point 37	463	2,043.2745

Regions

	Material	Points	Area (ft²)
Region 1	TQs150 psf-17° bedding 3-10°	1,26,31,27,30,29,28,24,23,22,37,36,35,34,33,32,7,6,5,4,3,2	58,736
Region 2	TQs 150 psf-11° bedding 3-10°	27,31,26,25	97,770
Region 3		32,33,34,35,36,21,20,19,18,17,16,15,14,13,12,11,10,9,8	5,214.9

Current Slip Surface

Slip Surface: 589,825
 F of S: 1.27
 Volume: 5,059.0396 ft³
 Weight: 607,084.75 lbs
 Resisting Force: 218,933.38 lbs
 Activating Force: 172,505.5 lbs
 F of S Rank (Analysis): 1 of 589,825 slip surfaces
 F of S Rank (Query): 1 of 150 slip surfaces
 Exit: (275.89795, 1,953.9525) ft
 Entry: (466.08324, 2,043.214) ft
 Radius: 119.43656 ft
 Center: (341.63839, 2,065.7323) ft

Slip Slices

	X (ft)	Y (ft)	PWP (psf)	Base Normal Stress (psf)	Frictional Strength (psf)	Cohesive Strength (psf)
Slice 1	280.20112	1,954.1799	0	222.33282	67.973963	150.075
Slice 2	287.75215	1,954.9383	0	553.25236	169.14622	150.075
Slice 3	294	1,955.9601	0	796.64195	243.55789	150.075
Slice 4	300	1,956.9412	0	1,030.3764	315.01767	150.075
Slice 5	303.91375	1,957.5813	0	1,182.8394	361.63028	150.075
Slice 6	307.68958	1,958.2219	0	1,323.8508	404.7418	150.075
Slice	313.41375	1,959.2044	0	1,541.074	471.15359	150.075

7						
Slice 8	319.13792	1,960.1869	0	1,758.2971	537.56538	150.075
Slice 9	325	1,961.1931	0	1,980.754	605.57727	150.075
Slice 10	329.2863	1,961.9288	0	2,143.4124	655.30693	150.075
Slice 11	333.38405	1,962.6438	0	2,294.8967	701.62033	150.075
Slice 12	339.00695	1,963.6324	0	2,505.3802	765.97159	150.075
Slice 13	342.4092	1,964.2307	0	2,632.4166	804.81051	150.075
Slice 14	345.5	1,964.7753	0	2,747.9594	840.1355	150.075
Slice 15	350.5	1,965.6564	0	2,934.8736	897.28089	150.075
Slice 16	353.2898	1,966.1479	0	3,039.1642	929.16574	150.075
Slice 17	356.1847	1,966.6397	0	3,155.4235	964.70976	150.075
Slice 18	361.3949	1,967.521	0	3,354.7501	1,025.65	150.075
Slice 19	366.59758	1,968.401	0	3,553.7889	1,086.5023	150.075
Slice 20	371.79273	1,969.2798	0	3,752.5398	1,147.2666	150.075
Slice 21	374.69515	1,969.7677	0	3,874.1769	1,184.4547	150.075
Slice 22	377.1457	1,970.1573	0	3,971.0284	1,214.0652	150.075
Slice 23	382.11708	1,970.992	0	4,145.5471	1,267.4209	150.075
Slice 24	387.76842	1,971.9792	0	4,357.8757	1,332.3363	150.075
Slice 25	394.29705	1,973.1246	0	4,601.0263	1,406.6749	150.075
Slice 26	399.5588	1,974.0508	0	4,797.8466	1,466.8489	150.075
Slice 27	402.5588	1,974.5788	0	4,909.5944	1,501.0136	150.075
Slice 28	407.6021	1,975.4666	0	5,096.5996	1,558.1869	150.075
Slice 29	414.90315	1,976.7497	0	5,368.2739	1,641.246	150.075
Slice 30	422.30105	1,978.0479	0	5,643.0781	1,725.2621	150.075

Slice 31	426.8846	1,978.8523	0	5,813.3397	1,777.3163	150.075
Slice 32	430.24115	1,982.7815	0	2,760.7432	2,316.5386	225
Slice 33	436.57968	1,992.7561	0	2,288.3586	1,920.1608	225
Slice 34	444.31282	2,005.1572	0	1,789.5532	1,501.6134	225
Slice 35	450.409	2,015.1574	0	1,331.6835	1,117.4151	225
Slice 36	453.8212	2,021.0908	0	1,051.4295	882.2541	225
Slice 37	459.0019	2,030.4379	0	564.68967	473.83089	225
Slice 38	464.54162	2,040.4327	0	8.4914039	7.1251339	225

Section 2-2 SSA for Skyline Ranch3to1.gsz

Section 2-2

Section 2-2 SSA for Skyline Ranch3to1.gsz Run By: Dr. Alexander Bykovtsev, Ph.D., P.E. 3/19/2016 1:57:45 PM

Name: TQs (150 psf/17° - A-Bed 6-11°)
 Model: Anisotropic Fn.
 Unit Weight: 120 pcf
 Cohesion: 225 psf
 Phi: 40°
 Phi-Anisotropic Strength Fn.: 17° - A-Bed 6-11°
 C-Anisotropic Strength Fn.: 150 psf - A-Bed 6-11° (TQs)

Keyway 75' wide by 30' deep
 3H:1V Backcut

1.832

Name: Tmc (100 psf/25° - A-Bed 4-8°)
 Model: Anisotropic Fn.
 Unit Weight: 120 pcf
 Cohesion: 200 psf
 Phi: 40°
 Phi-Anisotropic Strength Fn.: 25° - A-Bed 4-8°
 C-Anisotropic Strength Fn.: 100 psf - A-Bed 4-8°

Name: Fill
 Model: Mohr-Coulomb
 Unit Weight: 120 pcf
 Cohesion: 200 psf
 Phi: 33°

Name: Along Bedding Shear
 Model: Mohr-Coulomb
 Unit Weight: 120 pcf
 Cohesion: 150 psf
 Phi: 11°

Name: Tmc (150 psf/17° - A-Bed 4-8°)
 Model: Anisotropic Fn.
 Unit Weight: 120 pcf
 Cohesion: 200 psf
 Phi: 40°
 Phi-Anisotropic Strength Fn.: 150 psf - A-Bed 4-8°
 C-Anisotropic Strength Fn.: 17° - A-Bed 4-8°

Materials

- TQs (150 psf/17° - A-Bed 6-11°)
- Tmc (100 psf/25° - A-Bed 4-8°)
- Fill
- Along Bedding Shear
- Tmc (150 psf/17° - A-Bed 4-8°)

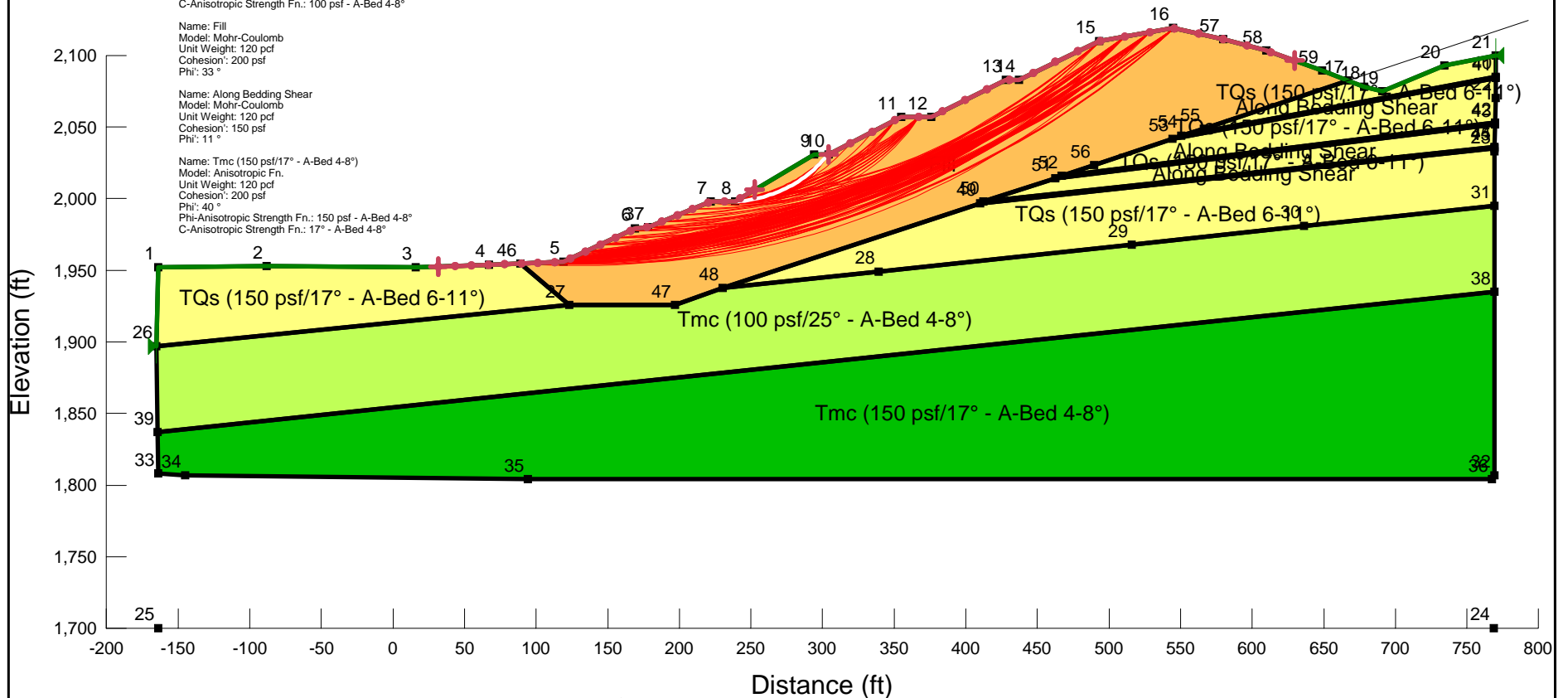

LGC Valley, Inc

GEOTECHNICAL CONSULTING

28532 Constellation Road, Valencia, CA 91355
 Phone 661-702-8474, Fax 661-702-8475

Skyline Ranch
 Development project, Tract 60922
 Los Angeles CA

Project No: **153035-01**
 Engineer: **BAS**
 Date: **March 2016**

4 - Circular Mode of Failure Static

Report generated using GeoStudio 2012. Copyright © 1991-2016 GEO-SLOPE International Ltd.

File Information

File Version: 8.15
 Title: Static Slope Stability Analyses for Skyline Ranch Development project, Tract 60922, Los Angeles CA
 Comments: Run By: Dr. Alexander Bykovtsev, Ph.D., P.E.
 Last Edited By: Alexander Bykovtsec
 Revision Number: 91
 Date: 3/19/2016
 Time: 1:57:45 PM
 Tool Version: 8.15.5.11777
 File Name: Section 2-2 SSA for Skyline Ranch3to1.gsz
 Directory: P:\FINAL PROJECTS\PARDEE\Skyline Ranch\SLOPE RESULTS\Section 2-2 results\Latest Update 3-19-16\
 Last Solved Date: 3/19/2016
 Last Solved Time: 1:59:52 PM

Project Settings

Length(L) Units: Feet
 Time(t) Units: Seconds
 Force(F) Units: Pounds
 Pressure(p) Units: psf
 Strength Units: psf
 Unit Weight of Water: 62.4 pcf
 View: 2D
 Element Thickness: 1

Analysis Settings

4 - Circular Mode of Failure Static

Kind: SLOPE/W
 Method: Bishop
 Settings
 PWP Conditions Source: (none)
 Slip Surface
 Direction of movement: Right to Left
 Use Passive Mode: No
 Slip Surface Option: Entry and Exit
 Critical slip surfaces saved: 10
 Resisting Side Maximum Convex Angle: 1 °
 Driving Side Maximum Convex Angle: 5 °
 Optimize Critical Slip Surface Location: No
 Tension Crack
 Tension Crack Option: (none)
 F of S Distribution
 F of S Calculation Option: Constant
 Advanced
 Number of Slices: 30
 F of S Tolerance: 0.01
 Minimum Slip Surface Depth: 0.1 ft

file:///P:/FINAL%20PROJECTS/PARDEE/Skyline%20Ranch/SLOPE%20RESULTS/Sect... 3/19/2016

Materials

TQs (150 psf/17° - A-Bed 6-11°)

Model: Anisotropic Fn.
 Unit Weight: 120 pcf
 Cohesion: 225 psf
 Phi': 40 °
 Phi-Anisotropic Strength Fn.: 17° - A-Bed 6-11°
 C-Anisotropic Strength Fn.: 150 psf - A-Bed 6-11° (TQs)
 Phi-B: 0 °

Tmc (100 psf/25° - A-Bed 4-8°)

Model: Anisotropic Fn.
 Unit Weight: 120 pcf
 Cohesion: 200 psf
 Phi': 40 °
 Phi-Anisotropic Strength Fn.: 25° - A-Bed 4-8°
 C-Anisotropic Strength Fn.: 100 psf - A-Bed 4-8°
 Phi-B: 0 °

Fill

Model: Mohr-Coulomb
 Unit Weight: 120 pcf
 Cohesion: 200 psf
 Phi': 33 °
 Phi-B: 0 °

Along Bedding Shear

Model: Mohr-Coulomb
 Unit Weight: 120 pcf
 Cohesion: 150 psf
 Phi': 11 °
 Phi-B: 0 °

Tmc (150 psf/17° - A-Bed 4-8°)

Model: Anisotropic Fn.
 Unit Weight: 120 pcf
 Cohesion: 200 psf
 Phi': 40 °
 Phi-Anisotropic Strength Fn.: 150 psf - A-Bed 4-8°
 C-Anisotropic Strength Fn.: 17° - A-Bed 4-8°
 Phi-B: 0 °

Slip Surface Entry and Exit

Left Projection: Range
 Left-Zone Left Coordinate: (31.8656, 1,952.6222) ft
 Left-Zone Right Coordinate: (252.5368, 2,006.1221) ft
 Left-Zone Increment: 20
 Right Projection: Range
 Right-Zone Left Coordinate: (304, 2,031) ft
 Right-Zone Right Coordinate: (629.4414, 2,096.335) ft
 Right-Zone Increment: 20

file:///P:/FINAL%20PROJECTS/PARDEE/Skyline%20Ranch/SLOPE%20RESULTS/Sect... 3/19/2016

Radius Increments: 20

Slip Surface Limits

Left Coordinate: (-165, 1,897) ft
 Right Coordinate: (770, 2,100) ft

Seismic Coefficients

Horz Seismic Coef.: 0
 Vert Seismic Coef.: 0

Anisotropic Strength Functions

25° - A-Bed 4-8°

Model: Spline Data Point Function
 Function: Modifier Factor vs. Inclination
 Curve Fit to Data: 100 %
 Segment Curvature: 0 %
 Y-Intercept: 1
 Data Points: Inclination (°), Modifier Factor
 Data Point: (-90, 1)
 Data Point: (3.9, 1)
 Data Point: (4, 0.625)
 Data Point: (8, 0.625)
 Data Point: (8.1, 1)

100 psf - A-Bed 4-8°

Model: Spline Data Point Function
 Function: Modifier Factor vs. Inclination
 Curve Fit to Data: 100 %
 Segment Curvature: 0 %
 Y-Intercept: 1
 Data Points: Inclination (°), Modifier Factor
 Data Point: (-90, 1)
 Data Point: (3.9, 1)
 Data Point: (4, 0.5)
 Data Point: (8, 0.5)
 Data Point: (8.1, 1)

17° - A-Bed 4-8°

Model: Spline Data Point Function
 Function: Modifier Factor vs. Inclination
 Curve Fit to Data: 100 %
 Segment Curvature: 0 %
 Y-Intercept: 1
 Data Points: Inclination (°), Modifier Factor
 Data Point: (-90, 1)
 Data Point: (3.9, 1)
 Data Point: (4, 0.425)
 Data Point: (8, 0.425)
 Data Point: (8.1, 1)

150 psf - A-Bed 4-8°

Model: Spline Data Point Function
 Function: Modifier Factor vs. Inclination
 Curve Fit to Data: 100 %
 Segment Curvature: 0 %
 Y-Intercept: 1
 Data Points: Inclination (°), Modifier Factor
 Data Point: (-90, 1)
 Data Point: (3.9, 1)
 Data Point: (4, 0.75)
 Data Point: (8, 0.75)
 Data Point: (8.1, 1)

17° - A-Bed 6-11°

Model: Spline Data Point Function
 Function: Modifier Factor vs. Inclination
 Curve Fit to Data: 100 %
 Segment Curvature: 0 %
 Y-Intercept: 1
 Data Points: Inclination (°), Modifier Factor
 Data Point: (-90, 1)
 Data Point: (5.9, 1)
 Data Point: (6, 0.425)
 Data Point: (11, 0.425)
 Data Point: (11.1, 1)

150 psf - A-Bed 6-11° (TQs)

Model: Spline Data Point Function
 Function: Modifier Factor vs. Inclination
 Curve Fit to Data: 100 %
 Segment Curvature: 0 %
 Y-Intercept: 1
 Data Points: Inclination (°), Modifier Factor
 Data Point: (-90, 1)
 Data Point: (5.9, 1)
 Data Point: (6, 0.667)
 Data Point: (11, 0.667)
 Data Point: (11.1, 1)

Points

	X (ft)	Y (ft)
Point 1	-164	1,952
Point 2	-88	1,953
Point 3	16	1,952
Point 4	67	1,954
Point 5	119	1,956
Point 6	169	1,979
Point 7	222	1,998
Point 8	239	1,998
Point 9	294	2,031
Point 10	304	2,031

Point 11	355	2,057
Point 12	376	2,057
Point 13	428	2,083
Point 14	437	2,083
Point 15	493	2,110
Point 16	545	2,119
Point 17	666.7794	2,082.2835
Point 18	678	2,078
Point 19	691	2,075
Point 20	734	2,093
Point 21	770	2,100
Point 22	770	2,070
Point 23	769	2,033
Point 24	768.9132	1,700.0035
Point 25	-164	1,700
Point 26	-165	1,897
Point 27	123	1,926
Point 28	339	1,949
Point 29	516	1,968
Point 30	636	1,981
Point 31	769	1,995
Point 32	769	1,807
Point 33	-164	1,808
Point 34	-145.1146	1,807
Point 35	94.3981	1,804.0495
Point 36	767.2671	1,804.0495
Point 37	178	1,980
Point 38	769	1,935
Point 39	-164.3258	1,837
Point 40	770	2,085
Point 41	770	2,084
Point 42	769.5405	2,053
Point 43	769.5135	2,052
Point 44	769.0811	2,036
Point 45	769.0541	2,035
Point 46	89	1,954.8462
Point 47	197	1,926
Point 48	230.4185	1,937.6441
Point 49	410.1571	1,996.9191
Point 50	412.2316	1,997.8289
Point 51	462.5895	2,014.3399
Point 52	467.0781	2,015.9473
Point 53	544.2511	2,041.6026
Point 54	550.5628	2,043.7746
Point 55	566.1504	2,048.8086
Point 56	489.5416	2,023.5144
Point 57	579.8545	2,111.4639
Point 58	609.9957	2,103.2729

648.9076 | 2,089.3897

Regions

	Material	Points	Area (ft²)
Region 1	Tmc (100 psf/25° - A-Bed 4-8°)	26,39,38,31,30,29,28,48,47,27	55,091
Region 2	Tmc (150 psf/17° - A-Bed 4-8°)	33,34,35,36,32,38,39	76,059
Region 3	TQs (150 psf/17° - A-Bed 6-11°)	40,21,20,19,18,17,55,54	2,168.2
Region 4	TQs (150 psf/17° - A-Bed 6-11°)	43,51,50,44	4,432.1
Region 5	TQs (150 psf/17° - A-Bed 6-11°)	22,41,53,56,52,42	5,946.6
Region 6	Fill	46,27,47,48,49,50,51,52,56,53,54,55,17,59,58,57,16,15,14,13,12,11,10,9,8,7,37,6,5	34,644
Region 7	Along Bedding Shear	45,44,50,49	301.67
Region 8	Along Bedding Shear	43,42,52,51	312.89
Region 9	Along Bedding Shear	41,40,54,53	221.08
Region 10	TQs (150 psf/17° - A-Bed 6-11°)	4,3,2,1,26,27,46	11,437
Region 11	TQs (150 psf/17° - A-Bed 6-11°)	28,29,30,31,23,45,49,48	18,001

Current Slip Surface

Slip Surface: 7,946
 F of S: 1.832
 Volume: 543.16781 ft³
 Weight: 65,180.137 lbs

Resisting Moment: 4,799,852.3 lbs-ft
 Activating Moment: 2,619,923.8 lbs-ft
 F of S Rank (Analysis): 1 of 9,261 slip surfaces
 F of S Rank (Query): 1 of 150 slip surfaces
 Exit: (239.1067, 1,998.064) ft
 Entry: (304, 2,031) ft
 Radius: 89.387113 ft
 Center: (234.60159, 2,087.3375) ft

Slip Slices

	X (ft)	Y (ft)	PWP (psf)	Base Normal Stress (psf)	Frictional Strength (psf)	Cohesive Strength (psf)
Slice 1	240.20456	1,998.133	0	62.539406	40.613565	200
Slice 2	242.40029	1,998.2981	0	193.51301	125.66882	200
Slice 3	244.59603	1,998.5178	0	315.94516	205.17719	200
Slice 4	246.79176	1,998.7925	0	429.97298	279.22772	200
Slice 5	248.98749	1,999.1227	0	535.71219	347.89556	200
Slice 6	251.18322	1,999.509	0	633.2582	411.24268	200
Slice 7	253.37896	1,999.9521	0	722.68698	469.31841	200
Slice 8	255.57469	2,000.4531	0	804.0557	522.15988	200
Slice 9	257.77042	2,001.0127	0	877.40319	569.79229	200
Slice 10	259.96615	2,001.6323	0	942.75018	612.22913	200
Slice 11	262.16188	2,002.3131	0	1,000.0994	649.47215	200
Slice 12	264.35762	2,003.0566	0	1,049.4355	681.51136	200
Slice 13	266.55335	2,003.8644	0	1,090.7245	708.32477	200
Slice 14	268.74908	2,004.7385	0	1,123.9137	729.87809	200
Slice 15	270.94481	2,005.681	0	1,148.9306	746.12423	200
Slice 16	273.14054	2,006.6943	0	1,165.6819	757.00269	200
Slice 17	275.33628	2,007.7811	0	1,174.0526	762.4387	200
Slice 18	277.53201	2,008.9445	0	1,173.9042	762.34231	200
Slice 19	279.72774	2,010.1879	0	1,165.0727	756.60709	200
Slice 20	281.92347	2,011.5152	0	1,147.3667	745.10867	200
Slice 21	284.11921	2,012.9311	0	1,120.5643	727.70297	200
Slice 22	286.31494	2,014.4405	0	1,084.41	704.22409	200
Slice 23	288.51067	2,016.0496	0	1,038.6108	674.48171	200
Slice 24	290.7064	2,017.7651	0	982.83131	638.25812	200
Slice						

25	292.90213	2,019.5953	0	916.68871	595.30461	200
Slice 26	295	2,021.457	0	789.31563	512.58756	200
Slice 27	297	2,023.3489	0	603.66807	392.02663	200
Slice 28	299	2,025.3632	0	411.83945	267.45167	200
Slice 29	301	2,027.5122	0	213.72464	138.7944	200
Slice 30	303	2,029.811	0	9.2567889	6.011429	200

Section 2-2 SSA for Skyline Ranch3to1.gsz

Section 2-2

Section 2-2 SSA for Skyline Ranch3to1.gsz Run By: Dr. Alexander Bykovtsev, Ph.D., P.E. 3/19/2016 1:57:45 PM

Name: TQs (150 psf/17° - A-Bed 6-11°)
 Model: Anisotropic Fn.
 Unit Weight: 120 pcf
 Cohesion: 225 psf
 Phi: 40°
 Phi-Anisotropic Strength Fn.: 17° - A-Bed 6-11°
 C-Anisotropic Strength Fn.: 150 psf - A-Bed 6-11° (TQs)

Name: Tmc (100 psf/25° - A-Bed 4-8°)
 Model: Anisotropic Fn.
 Unit Weight: 120 pcf
 Cohesion: 200 psf
 Phi: 40°
 Phi-Anisotropic Strength Fn.: 25° - A-Bed 4-8°
 C-Anisotropic Strength Fn.: 100 psf - A-Bed 4-8°

Name: Fill
 Model: Mohr-Coulomb
 Unit Weight: 120 pcf
 Cohesion: 200 psf
 Phi: 33°

Name: Along Bedding Shear
 Model: Mohr-Coulomb
 Unit Weight: 120 pcf
 Cohesion: 150 psf
 Phi: 11°

Name: Tmc (150 psf/17° - A-Bed 4-8°)
 Model: Anisotropic Fn.
 Unit Weight: 120 pcf
 Cohesion: 200 psf
 Phi: 40°
 Phi-Anisotropic Strength Fn.: 150 psf - A-Bed 4-8°
 C-Anisotropic Strength Fn.: 17° - A-Bed 4-8°

Keyway 75' wide by 30' deep
 3H:1V Backcut

1.321

Seismic Load
 Horizontal: 0.15
 Vertical: 0.00

- Materials
- TQs (150 psf/17° - A-Bed 6-11°)
 - Tmc (100 psf/25° - A-Bed 4-8°)
 - Fill
 - Along Bedding Shear
 - Tmc (150 psf/17° - A-Bed 4-8°)

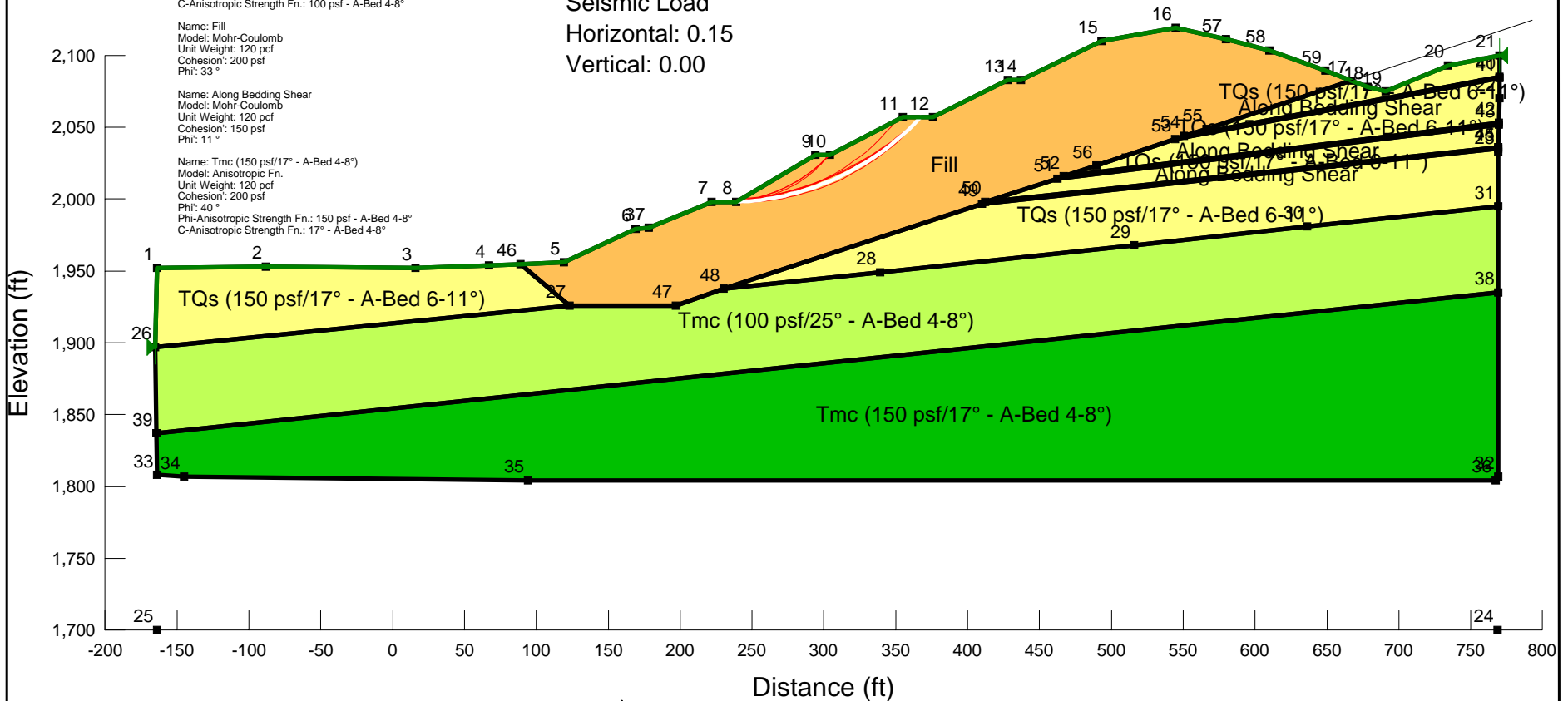

LGC Valley, Inc
 GEOTECHNICAL CONSULTING
 28532 Constellation Road, Valencia, CA 91355
 Phone 661-702-8474, Fax 661-702-8475

Skyline Ranch
 Development project, Tract 60922
 Los Angeles CA

Project No: **153035-01**
 Engineer: **BAS**
 Date: **March 2016**

1 - Circular Mode of Failure Seismic

Report generated using GeoStudio 2012. Copyright © 1991-2016 GEO-SLOPE International Ltd.

File Information

File Version: 8.15
 Title: Static Slope Stability Analyses for Skyline Ranch Development project, Tract 60922, Los Angeles CA
 Comments: Run By: Dr. Alexander Bykovtsev, Ph.D., P.E.
 Last Edited By: Alexander Bykovtsev
 Revision Number: 91
 Date: 3/19/2016
 Time: 1:57:45 PM
 Tool Version: 8.15.5.11777
 File Name: Section 2-2 SSA for Skyline Ranch3to1.gsz
 Directory: P:\FINAL PROJECTS\PARDEE\Skyline Ranch\SLOPE RESULTS\Section 2-2 results\Latest Update 3-19-16\
 Last Solved Date: 3/19/2016
 Last Solved Time: 2:00:20 PM

Project Settings

Length(L) Units: Feet
 Time(t) Units: Seconds
 Force(F) Units: Pounds
 Pressure(p) Units: psf
 Strength Units: psf
 Unit Weight of Water: 62.4 pcf
 View: 2D
 Element Thickness: 1

Analysis Settings

1 - Circular Mode of Failure Seismic

Kind: SLOPE/W
 Parent: 4 - Circular Mode of Failure Static
 Method: Bishop
 Settings
 PWP Conditions Source: (none)
 Initial Slip Surface Source: Parent Analysis
 Slip Surface
 Direction of movement: Right to Left
 Use Passive Mode: No
 Slip Surface Option: Critical Slip Surfaces from Other
 Critical slip surfaces saved: 1
 Resisting Side Maximum Convex Angle: 1 °
 Driving Side Maximum Convex Angle: 5 °
 Optimize Critical Slip Surface Location: No
 Tension Crack
 Tension Crack Option: (none)
 F of S Distribution
 F of S Calculation Option: Constant
 Advanced
 Number of Slices: 30

file:///P:/FINAL%20PROJECTS/PARDEE/Skyline%20Ranch/SLOPE%20RESULTS/Sect... 3/19/2016

F of S Tolerance: 0.01
 Minimum Slip Surface Depth: 0.1 ft

Materials

TQs (150 psf/17° - A-Bed 6-11°)

Model: Anisotropic Fn.
 Unit Weight: 120 pcf
 Cohesion: 225 psf
 Phi: 40 °
 Phi-Anisotropic Strength Fn.: 17° - A-Bed 6-11°
 C-Anisotropic Strength Fn.: 150 psf - A-Bed 6-11° (TQs)
 Phi-B: 0 °

Tmc (100 psf/25° - A-Bed 4-8°)

Model: Anisotropic Fn.
 Unit Weight: 120 pcf
 Cohesion: 200 psf
 Phi: 40 °
 Phi-Anisotropic Strength Fn.: 25° - A-Bed 4-8°
 C-Anisotropic Strength Fn.: 100 psf - A-Bed 4-8°
 Phi-B: 0 °

Fill

Model: Mohr-Coulomb
 Unit Weight: 120 pcf
 Cohesion: 200 psf
 Phi: 33 °
 Phi-B: 0 °

Along Bedding Shear

Model: Mohr-Coulomb
 Unit Weight: 120 pcf
 Cohesion: 150 psf
 Phi: 11 °
 Phi-B: 0 °

Tmc (150 psf/17° - A-Bed 4-8°)

Model: Anisotropic Fn.
 Unit Weight: 120 pcf
 Cohesion: 200 psf
 Phi: 40 °
 Phi-Anisotropic Strength Fn.: 150 psf - A-Bed 4-8°
 C-Anisotropic Strength Fn.: 17° - A-Bed 4-8°
 Phi-B: 0 °

Slip Surface Limits

Left Coordinate: (-165, 1,897) ft
 Right Coordinate: (770, 2,100) ft

Seismic Coefficients

file:///P:/FINAL%20PROJECTS/PARDEE/Skyline%20Ranch/SLOPE%20RESULTS/Sect... 3/19/2016

Horz Seismic Coef.: 0.15
 Vert Seismic Coef.: 0

Anisotropic Strength Functions

25° - A-Bed 4-8°

Model: Spline Data Point Function
 Function: Modifier Factor vs. Inclination
 Curve Fit to Data: 100 %
 Segment Curvature: 0 %
 Y-Intercept: 1
 Data Points: Inclination (°), Modifier Factor
 Data Point: (-90, 1)
 Data Point: (3.9, 1)
 Data Point: (4, 0.625)
 Data Point: (8, 0.625)
 Data Point: (8.1, 1)

100 psf - A-Bed 4-8°

Model: Spline Data Point Function
 Function: Modifier Factor vs. Inclination
 Curve Fit to Data: 100 %
 Segment Curvature: 0 %
 Y-Intercept: 1
 Data Points: Inclination (°), Modifier Factor
 Data Point: (-90, 1)
 Data Point: (3.9, 1)
 Data Point: (4, 0.5)
 Data Point: (8, 0.5)
 Data Point: (8.1, 1)

17° - A-Bed 4-8°

Model: Spline Data Point Function
 Function: Modifier Factor vs. Inclination
 Curve Fit to Data: 100 %
 Segment Curvature: 0 %
 Y-Intercept: 1
 Data Points: Inclination (°), Modifier Factor
 Data Point: (-90, 1)
 Data Point: (3.9, 1)
 Data Point: (4, 0.425)
 Data Point: (8, 0.425)
 Data Point: (8.1, 1)

150 psf - A-Bed 4-8°

Model: Spline Data Point Function
 Function: Modifier Factor vs. Inclination
 Curve Fit to Data: 100 %
 Segment Curvature: 0 %
 Y-Intercept: 1
 Data Points: Inclination (°), Modifier Factor
 Data Point: (-90, 1)
 Data Point: (3.9, 1)
 Data Point: (4, 0.75)

Data Point: (8, 0.75)
 Data Point: (8.1, 1)

17° - A-Bed 6-11°

Model: Spline Data Point Function
 Function: Modifier Factor vs. Inclination
 Curve Fit to Data: 100 %
 Segment Curvature: 0 %
 Y-Intercept: 1
 Data Points: Inclination (°), Modifier Factor
 Data Point: (-90, 1)
 Data Point: (5.9, 1)
 Data Point: (6, 0.425)
 Data Point: (11, 0.425)
 Data Point: (11.1, 1)

150 psf - A-Bed 6-11° (TQs)

Model: Spline Data Point Function
 Function: Modifier Factor vs. Inclination
 Curve Fit to Data: 100 %
 Segment Curvature: 0 %
 Y-Intercept: 1
 Data Points: Inclination (°), Modifier Factor
 Data Point: (-90, 1)
 Data Point: (5.9, 1)
 Data Point: (6, 0.667)
 Data Point: (11, 0.667)
 Data Point: (11.1, 1)

Points

	X (ft)	Y (ft)
Point 1	-164	1,952
Point 2	-88	1,953
Point 3	16	1,952
Point 4	67	1,954
Point 5	119	1,956
Point 6	169	1,979
Point 7	222	1,998
Point 8	239	1,998
Point 9	294	2,031
Point 10	304	2,031
Point 11	355	2,057
Point 12	376	2,057
Point 13	428	2,083
Point 14	437	2,083
Point 15	493	2,110
Point 16	545	2,119
Point 17	666.7794	2,082.2835
Point 18	678	2,078
Point 19	691	2,075
Point 20	734	2,093

Point 21	770	2,100
Point 22	770	2,070
Point 23	769	2,033
Point 24	768.9132	1,700.0035
Point 25	-164	1,700
Point 26	-165	1,897
Point 27	123	1,926
Point 28	339	1,949
Point 29	516	1,968
Point 30	636	1,981
Point 31	769	1,995
Point 32	769	1,807
Point 33	-164	1,808
Point 34	-145.1146	1,807
Point 35	94.3981	1,804.0495
Point 36	767.2671	1,804.0495
Point 37	178	1,980
Point 38	769	1,935
Point 39	-164.3258	1,837
Point 40	770	2,085
Point 41	770	2,084
Point 42	769.5405	2,053
Point 43	769.5135	2,052
Point 44	769.0811	2,036
Point 45	769.0541	2,035
Point 46	89	1,954.8462
Point 47	197	1,926
Point 48	230.4185	1,937.6441
Point 49	410.1571	1,996.9191
Point 50	412.2316	1,997.8289
Point 51	462.5895	2,014.3399
Point 52	467.0781	2,015.9473
Point 53	544.2511	2,041.6026
Point 54	550.5628	2,043.7746
Point 55	566.1504	2,048.8086
Point 56	489.5416	2,023.5144
Point 57	579.8545	2,111.4639
Point 58	609.9957	2,103.2729
Point 59	648.9076	2,089.3897

Regions

	Material	Points	Area (ft ²)
Region 1	Tmc (100 psf/25° - A-Bed 4-8°)	26,39,38,31,30,29,28,48,47,27	55,091

Region 2	Tmc (150 psf/17° - A-Bed 4-8°)	33,34,35,36,32,38,39	76,059
Region 3	TQs (150 psf/17° - A-Bed 6-11°)	40,21,20,19,18,17,55,54	2,168.2
Region 4	TQs (150 psf/17° - A-Bed 6-11°)	43,51,50,44	4,432.1
Region 5	TQs (150 psf/17° - A-Bed 6-11°)	22,41,53,56,52,42	5,946.6
Region 6	Fill	46,27,47,48,49,50,51,52,56,53,54,55,17,59,58,57,16,15,14,13,12,11,10,9,8,7,37,6,5	34,644
Region 7	Along Bedding Shear	45,44,50,49	301.67
Region 8	Along Bedding Shear	43,42,52,51	312.89
Region 9	Along Bedding Shear	41,40,54,53	221.08
Region 10	TQs (150 psf/17° - A-Bed 6-11°)	4,3,2,1,26,27,46	11,437
Region 11	TQs (150 psf/17° - A-Bed 6-11°)	28,29,30,31,23,45,49,48	18,001

Current Slip Surface

Slip Surface: 2
 F of S: 1.321
 Volume: 1,851.0584 ft³
 Weight: 222,127.01 lbs
 Resisting Moment: 28,600,673 lbs-ft
 Activating Moment: 21,649,163 lbs-ft
 F of S Rank (Analysis): 1 of 10 slip surfaces
 F of S Rank (Query): 1 of 10 slip surfaces
 Exit: (239.21672, 1,998.13) ft
 Entry: (367.32804, 2,057) ft
 Radius: 184.08184 ft
 Center: (232.26902, 2,182.0807) ft

Slip Slices

	X (ft)	Y (ft)	PWP	Base Normal Stress	Frictional Strength	Cohesive Strength
--	--------	--------	-----	--------------------	---------------------	-------------------

			(psf)	(psf)	(psf)	(psf)
Slice 1	241.32377	1,998.2338	0	128.70966	83.585032	200
Slice 2	245.53787	1,998.4899	0	387.30497	251.51879	200
Slice 3	249.75196	1,998.8432	0	629.12239	408.55685	200
Slice 4	253.96606	1,999.2943	0	854.57794	554.9694	200
Slice 5	258.18016	1,999.844	0	1,064.0426	690.99734	200
Slice 6	262.39426	2,000.4932	0	1,257.8436	816.85318	200
Slice 7	266.60836	2,001.2428	0	1,436.2692	932.72414	200
Slice 8	270.82246	2,002.0943	0	1,599.5702	1,038.7731	200
Slice 9	275.03656	2,003.049	0	1,747.9625	1,135.1401	200
Slice 10	279.25065	2,004.1085	0	1,881.6283	1,221.9437	200
Slice 11	283.46475	2,005.2749	0	2,000.7189	1,299.282	200
Slice 12	287.67885	2,006.5501	0	2,105.3534	1,367.2325	200
Slice 13	291.89295	2,007.9367	0	2,195.6224	1,425.8539	200
Slice 14	296.5	2,009.589	0	2,125.1111	1,380.0633	200
Slice 15	301.5	2,011.5348	0	1,896.9811	1,231.9139	200
Slice 16	306.125	2,013.4805	0	1,783.2109	1,158.0307	200
Slice 17	310.375	2,015.4072	0	1,781.1482	1,156.6911	200
Slice 18	314.625	2,017.4661	0	1,765.4727	1,146.5114	200
Slice 19	318.875	2,019.6623	0	1,736.1197	1,127.4493	200
Slice 20	323.125	2,022.0015	0	1,692.9992	1,099.4465	200
Slice 21	327.375	2,024.4901	0	1,635.9933	1,062.4265	200
Slice 22	331.625	2,027.1351	0	1,564.9579	1,016.2955	200
Slice 23	335.875	2,029.9449	0	1,479.7193	960.94094	200
Slice 24	340.125	2,032.9287	0	1,380.076	896.23183	200
Slice 25	344.375	2,036.0972	0	1,265.7974	822.01843	200
Slice 26	348.625	2,039.4627	0	1,136.6235	738.13195	200
Slice 27	352.875	2,043.0397	0	992.26701	644.38573	200
Slice 28	357.05467	2,046.7779	0	748.80095	486.27702	200
Slice 29	361.16402	2,050.6885	0	411.38932	267.15935	200
Slice	365.27337	2,054.8521	0	66.049525	42.893063	200

30						
----	--	--	--	--	--	--

Section 2-2 SSA for Skyline Ranch3to1.gsz

Section 2-2

Section 2-2 SSA for Skyline Ranch3to1.gsz Run By: Dr. Alexander Bykovtsev, Ph.D., P.E. 3/19/2016 1:57:45 PM

Name: TQs (150 psf/17° - A-Bed 6-11°)
 Model: Anisotropic Fn.
 Unit Weight: 120 pcf
 Cohesion: 225 psf
 Phi: 40°
 Phi-Anisotropic Strength Fn.: 17° - A-Bed 6-11°
 C-Anisotropic Strength Fn.: 150 psf - A-Bed 6-11° (TQs)

Keyway 75' wide by 30' deep
 3H:1V Backcut
 Static-Translational

- Materials
- TQs (150 psf/17° - A-Bed 6-11°)
 - Tmc (100 psf/25° - A-Bed 4-8°)
 - Fill
 - Along Bedding Shear
 - Tmc (150 psf/17° - A-Bed 4-8°)

Name: Tmc (100 psf/25° - A-Bed 4-8°)
 Model: Anisotropic Fn.
 Unit Weight: 120 pcf
 Cohesion: 200 psf
 Phi: 40°
 Phi-Anisotropic Strength Fn.: 25° - A-Bed 4-8°
 C-Anisotropic Strength Fn.: 100 psf - A-Bed 4-8°

Name: Fill
 Model: Mohr-Coulomb
 Unit Weight: 120 pcf
 Cohesion: 200 psf
 Phi: 33°

Name: Along Bedding Shear
 Model: Mohr-Coulomb
 Unit Weight: 120 pcf
 Cohesion: 150 psf
 Phi: 11°

Name: Tmc (150 psf/17° - A-Bed 4-8°)
 Model: Anisotropic Fn.
 Unit Weight: 120 pcf
 Cohesion: 200 psf
 Phi: 40°
 Phi-Anisotropic Strength Fn.: 150 psf - A-Bed 4-8°
 C-Anisotropic Strength Fn.: 17° - A-Bed 4-8°

1.531

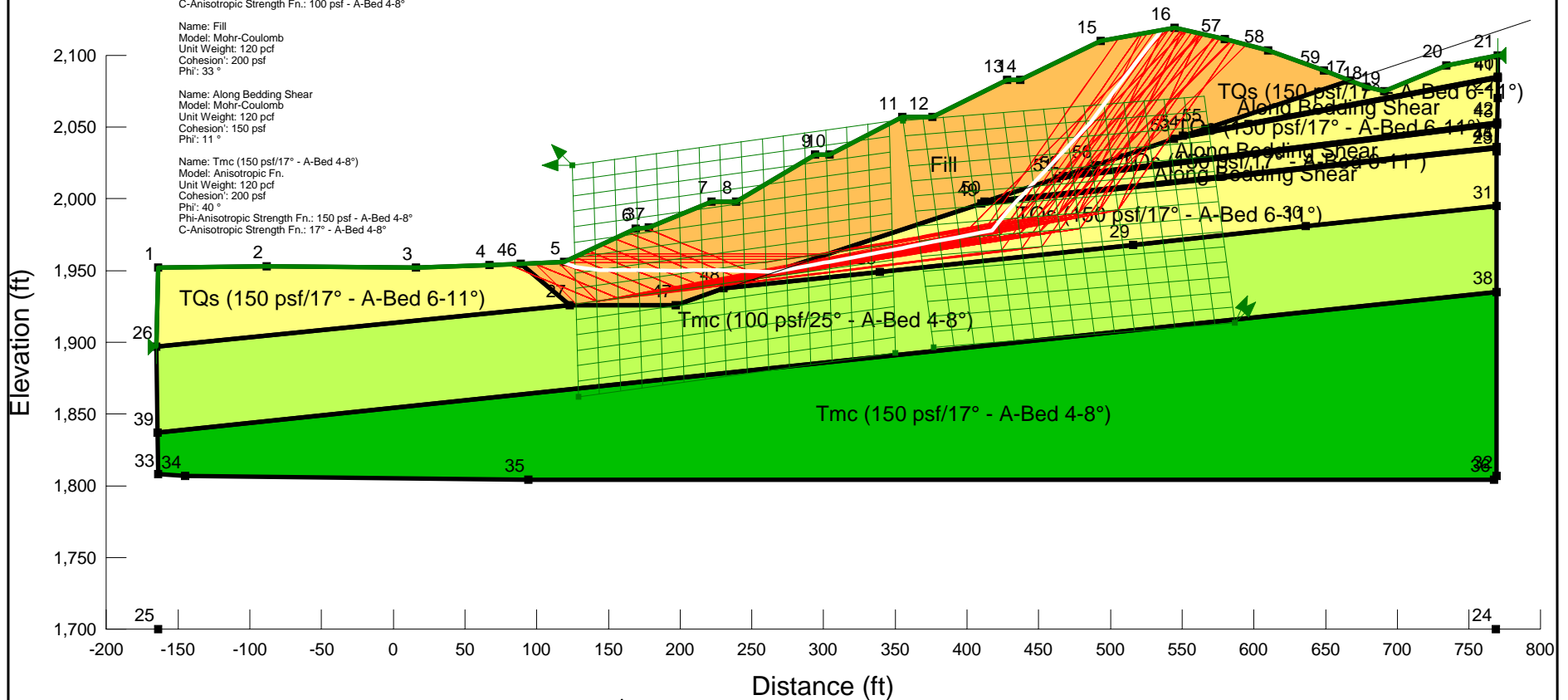

LGC Valley, Inc
 GEOTECHNICAL CONSULTING
 28532 Constellation Road, Valencia, CA 91355
 Phone 661-702-8474, Fax 661-702-8475

Skyline Ranch
 Development project, Tract 60922
 Los Angeles CA

Project No: **153035-01**
 Engineer: **BAS**
 Date: **March 2016**

3 - Translational Static

Report generated using GeoStudio 2012. Copyright © 1991-2016 GEO-SLOPE International Ltd.

File Information

File Version: 8.15
 Title: Static Slope Stability Analyses for Skyline Ranch Development project, Tract 60922, Los Angeles CA
 Comments: Run By: Dr. Alexander Bykovtsev, Ph.D., P.E.
 Last Edited By: Alexander Bykovtsec
 Revision Number: 91
 Date: 3/19/2016
 Time: 1:57:45 PM
 Tool Version: 8.15.5.11777
 File Name: Section 2-2 SSA for Skyline Ranch3to1.gsz
 Directory: P:\FINAL PROJECTS\PARDEE\Skyline Ranch\SLOPE RESULTS\Section 2-2 results\Latest Update 3-19-16\
 Last Solved Date: 3/19/2016
 Last Solved Time: 1:59:57 PM

Project Settings

Length(L) Units: Feet
 Time(t) Units: Seconds
 Force(F) Units: Pounds
 Pressure(p) Units: psf
 Strength Units: psf
 Unit Weight of Water: 62.4 pcf
 View: 2D
 Element Thickness: 1

Analysis Settings

3 - Translational Static

Kind: SLOPE/W
 Method: Janbu
 Settings
 PWP Conditions Source: (none)
 Slip Surface
 Direction of movement: Right to Left
 Use Passive Mode: No
 Slip Surface Option: Block
 Critical slip surfaces saved: 1
 Resisting Side Maximum Convex Angle: 1 °
 Driving Side Maximum Convex Angle: 5 °
 Restrict Block Crossing: No
 Optimize Critical Slip Surface Location: Yes
 Critical Slip Surface Optimizations
 Maximum Iterations: 2,000
 Convergence Tolerance: 1e-007
 Starting Points: 8
 Ending Points: 16
 Complete Passes per Insertion: 1
 Tension Crack

file:///P:/FINAL%20PROJECTS/PARDEE/Skyline%20Ranch/SLOPE%20RESULTS/Sect... 3/19/2016

Tension Crack Option: (none)
 F of S Distribution
 F of S Calculation Option: Constant
 Advanced
 Number of Slices: 30
 F of S Tolerance: 0.01
 Minimum Slip Surface Depth: 0.1 ft

Materials

TQs (150 psf/17° - A-Bed 6-11°)

Model: Anisotropic Fn.
 Unit Weight: 120 pcf
 Cohesion: 225 psf
 Phi': 40 °
 Phi-Anisotropic Strength Fn.: 17° - A-Bed 6-11°
 C-Anisotropic Strength Fn.: 150 psf - A-Bed 6-11° (TQs)
 Phi-B: 0 °

Tmc (100 psf/25° - A-Bed 4-8°)

Model: Anisotropic Fn.
 Unit Weight: 120 pcf
 Cohesion: 200 psf
 Phi': 40 °
 Phi-Anisotropic Strength Fn.: 25° - A-Bed 4-8°
 C-Anisotropic Strength Fn.: 100 psf - A-Bed 4-8°
 Phi-B: 0 °

Fill

Model: Mohr-Coulomb
 Unit Weight: 120 pcf
 Cohesion: 200 psf
 Phi': 33 °
 Phi-B: 0 °

Along Bedding Shear

Model: Mohr-Coulomb
 Unit Weight: 120 pcf
 Cohesion: 150 psf
 Phi': 11 °
 Phi-B: 0 °

Tmc (150 psf/17° - A-Bed 4-8°)

Model: Anisotropic Fn.
 Unit Weight: 120 pcf
 Cohesion: 200 psf
 Phi': 40 °
 Phi-Anisotropic Strength Fn.: 150 psf - A-Bed 4-8°
 C-Anisotropic Strength Fn.: 17° - A-Bed 4-8°
 Phi-B: 0 °

Slip Surface Limits

Left Coordinate: (-165, 1,897) ft

file:///P:/FINAL%20PROJECTS/PARDEE/Skyline%20Ranch/SLOPE%20RESULTS/Sect... 3/19/2016

Right Coordinate: (770, 2,100) ft

Slip Surface Block

Left Grid

Upper Left: (125.0302, 2,023.3206) ft
Lower Left: (129.0839, 1,862.0217) ft
Lower Right: (349.907, 1,892.6963) ft
X Increments: 15
Y Increments: 15
Starting Angle: 135 °
Ending Angle: 180 °
Angle Increments: 2

Right Grid

Upper Left: (355.4686, 2,054.561) ft
Lower Left: (376.786, 1,896.4962) ft
Lower Right: (586.6277, 1,913.5323) ft
X Increments: 15
Y Increments: 15
Starting Angle: 45 °
Ending Angle: 65 °
Angle Increments: 2

Seismic Coefficients

Horz Seismic Coef.: 0
Vert Seismic Coef.: 0

Anisotropic Strength Functions

25° - A-Bed 4-8°

Model: Spline Data Point Function
Function: Modifier Factor vs. Inclination
Curve Fit to Data: 100 %
Segment Curvature: 0 %

Y-Intercept: 1

Data Points: Inclination (°), Modifier Factor

Data Point: (-90, 1)
Data Point: (3.9, 1)
Data Point: (4, 0.625)
Data Point: (8, 0.625)
Data Point: (8.1, 1)

100 psf - A-Bed 4-8°

Model: Spline Data Point Function
Function: Modifier Factor vs. Inclination
Curve Fit to Data: 100 %
Segment Curvature: 0 %

Y-Intercept: 1

Data Points: Inclination (°), Modifier Factor

Data Point: (-90, 1)
Data Point: (3.9, 1)
Data Point: (4, 0.5)

Data Point: (8, 0.5)
Data Point: (8.1, 1)

17° - A-Bed 4-8°

Model: Spline Data Point Function
Function: Modifier Factor vs. Inclination
Curve Fit to Data: 100 %
Segment Curvature: 0 %

Y-Intercept: 1

Data Points: Inclination (°), Modifier Factor

Data Point: (-90, 1)
Data Point: (3.9, 1)
Data Point: (4, 0.425)
Data Point: (8, 0.425)
Data Point: (8.1, 1)

150 psf - A-Bed 4-8°

Model: Spline Data Point Function
Function: Modifier Factor vs. Inclination
Curve Fit to Data: 100 %
Segment Curvature: 0 %

Y-Intercept: 1

Data Points: Inclination (°), Modifier Factor

Data Point: (-90, 1)
Data Point: (3.9, 1)
Data Point: (4, 0.75)
Data Point: (8, 0.75)
Data Point: (8.1, 1)

17° - A-Bed 6-11°

Model: Spline Data Point Function
Function: Modifier Factor vs. Inclination
Curve Fit to Data: 100 %
Segment Curvature: 0 %

Y-Intercept: 1

Data Points: Inclination (°), Modifier Factor

Data Point: (-90, 1)
Data Point: (5.9, 1)
Data Point: (6, 0.425)
Data Point: (11, 0.425)
Data Point: (11.1, 1)

150 psf - A-Bed 6-11° (TQs)

Model: Spline Data Point Function
Function: Modifier Factor vs. Inclination
Curve Fit to Data: 100 %
Segment Curvature: 0 %

Y-Intercept: 1

Data Points: Inclination (°), Modifier Factor

Data Point: (-90, 1)
Data Point: (5.9, 1)
Data Point: (6, 0.667)
Data Point: (11, 0.667)
Data Point: (11.1, 1)

Points

	X (ft)	Y (ft)
Point 1	-164	1,952
Point 2	-88	1,953
Point 3	16	1,952
Point 4	67	1,954
Point 5	119	1,956
Point 6	169	1,979
Point 7	222	1,998
Point 8	239	1,998
Point 9	294	2,031
Point 10	304	2,031
Point 11	355	2,057
Point 12	376	2,057
Point 13	428	2,083
Point 14	437	2,083
Point 15	493	2,110
Point 16	545	2,119
Point 17	666.7794	2,082.2835
Point 18	678	2,078
Point 19	691	2,075
Point 20	734	2,093
Point 21	770	2,100
Point 22	770	2,070
Point 23	769	2,033
Point 24	768.9132	1,700.0035
Point 25	-164	1,700
Point 26	-165	1,897
Point 27	123	1,926
Point 28	339	1,949
Point 29	516	1,968
Point 30	636	1,981
Point 31	769	1,995
Point 32	769	1,807
Point 33	-164	1,808
Point 34	-145.1146	1,807
Point 35	94.3981	1,804.0495
Point 36	767.2671	1,804.0495
Point 37	178	1,980
Point 38	769	1,935
Point 39	-164.3258	1,837
Point 40	770	2,085
Point 41	770	2,084
Point 42	769.5405	2,053
Point 43	769.5135	2,052
Point 44	769.0811	2,036

Point 45	769.0541	2,035
Point 46	89	1,954.8462
Point 47	197	1,926
Point 48	230.4185	1,937.6441
Point 49	410.1571	1,996.9191
Point 50	412.2316	1,997.8289
Point 51	462.5895	2,014.3399
Point 52	467.0781	2,015.9473
Point 53	544.2511	2,041.6026
Point 54	550.5628	2,043.7746
Point 55	566.1504	2,048.8086
Point 56	489.5416	2,023.5144
Point 57	579.8545	2,111.4639
Point 58	609.9957	2,103.2729
Point 59	648.9076	2,089.3897

Regions

	Material	Points	Area (ft ²)
Region 1	Tmc (100 psf/25° - A-Bed 4-8°)	26,39,38,31,30,29,28,48,47,27	55,091
Region 2	Tmc (150 psf/17° - A-Bed 4-8°)	33,34,35,36,32,38,39	76,059
Region 3	TQs (150 psf/17° - A-Bed 6-11°)	40,21,20,19,18,17,55,54	2,168.2
Region 4	TQs (150 psf/17° - A-Bed 6-11°)	43,51,50,44	4,432.1
Region 5	TQs (150 psf/17° - A-Bed 6-11°)	22,41,53,56,52,42	5,946.6
Region 6	Fill	46,27,47,48,49,50,51,52,56,53,54,55,17,59,58,57,16,15,14,13,12,11,10,9,8,7,37,6,5	34,644
Region 7	Along Bedding Shear	45,44,50,49	301.67
Region 8	Along Bedding Shear	43,42,52,51	312.89
Region	Along Bedding	41,40,54,53	221.08

9	Shear		
Region 10	TQs (150 psf/17° - A-Bed 6-11")	4,3,2,1,26,27,46	11,437
Region 11	TQs (150 psf/17° - A-Bed 6-11")	28,29,30,31,23,45,49,48	18,001

Current Slip Surface

Slip Surface: 589,825
 F of S: 1.531
 Volume: 24,302.696 ft³
 Weight: 2,916,323.5 lbs
 Resisting Force: 1,276,401.8 lbs
 Activating Force: 833,720.78 lbs
 F of S Rank (Analysis): 1 of 589,825 slip surfaces
 F of S Rank (Query): 1 of 150 slip surfaces
 Exit: (118.50469, 1,955.9809) ft
 Entry: (535.60985, 2,117.3748) ft
 Radius: 239.92928 ft
 Center: (310.4629, 2,152.4703) ft

Slip Slices

	X (ft)	Y (ft)	PWP (psf)	Base Normal Stress (psf)	Frictional Strength (psf)	Cohesive Strength (psf)
Slice 1	118.75234	1,955.8812	0	79.006332	51.307312	200
Slice 2	122.93465	1,954.1958	0	585.88929	380.48096	200
Slice 3	135.2265	1,951.4429	0	1,552.3394	1,008.101	200
Slice 4	149.93777	1,950.3077	0	2,385.1008	1,548.9026	200
Slice 5	162.64593	1,950.3718	0	3,077.4165	1,998.4976	200
Slice 6	172.1009	1,950.4195	0	3,462.9574	2,248.8708	200
Slice 7	176.6009	1,950.4119	0	3,559.1833	2,311.3607	200
Slice 8	186.93385	1,950.2395	0	4,040.4897	2,623.9247	200
Slice 9	202.40078	1,950.18	0	4,746.9814	3,082.7258	200
Slice 10	215.46693	1,950.3591	0	5,363.3454	3,482.9972	200
Slice 11	224.52565	1,950.4833	0	5,667.3964	3,680.4503	200
Slice 12	233.02565	1,950.2899	0	5,824.1048	3,782.2179	200
Slice 13	245.51421	1,949.8132	0	6,358.9534	4,129.5526	200
Slice 14	258.58301	1,949.3144	0	7,376.1692	4,790.1403	200
Slice 15	272.3532	1,950.398	0	7,808.5001	2,387.298	150.075
Slice 16	286.7844	1,953.0657	0	8,501.9262	2,599.2997	150.075
Slice	297.1771	1,954.9869	0	8,780.662	2,684.5178	150.075

17						
Slice 18	302.1771	1,955.9102	0	8,674.7067	2,652.124	150.075
Slice 19	312.2465	1,957.7664	0	8,946.4951	2,735.218	150.075
Slice 20	329.11975	1,960.9288	0	9,564.5257	2,924.169	150.075
Slice 21	346.37325	1,964.2133	0	10,201.76	3,118.9911	150.075
Slice 22	356.6918	1,966.1776	0	10,483.14	3,205.0174	150.075
Slice 23	367.1918	1,968.1923	0	10,246.52	3,132.6755	150.075
Slice 24	384.53927	1,971.5257	0	10,354.724	3,165.7567	150.075
Slice 25	401.61782	1,974.8075	0	10,962.394	3,351.5403	150.075
Slice 26	411.19435	1,976.6478	0	11,303.136	3,455.7155	150.075
Slice 27	414.8498	1,977.3502	0	11,433.2	3,495.4802	150.075
Slice 28	422.734	1,984.3333	0	6,785.5505	5,693.7529	225
Slice 29	429.38355	1,992.5158	0	6,387.2073	5,359.5033	225
Slice 30	433.31329	1,996.9323	0	6,430.3184	5,395.6778	225
Slice 31	436.22971	2,000.0409	0	8,680.9026	1,687.3965	150
Slice 32	436.79997	2,000.6487	0	6,148.3956	5,159.1165	225
Slice 33	440.44695	2,004.536	0	5,979.5817	5,017.4648	225
Slice 34	451.28935	2,016.0929	0	6,010.2067	3,903.0739	200
Slice 35	465.39438	2,031.196	0	5,306.5622	3,446.1218	200
Slice 36	478.81353	2,045.6365	0	4,649.0419	3,019.1231	200
Slice 37	489.26155	2,057.7149	0	3,801.5812	2,468.7757	200
Slice 38	499.0757	2,070.4684	0	3,034.7025	1,970.7589	200
Slice 39	511.2271	2,086.2591	0	1,974.367	1,282.1689	200
Slice 40	526.45632	2,105.7646	0	675.869	438.91446	200

Section 2-2 SSA for Skyline Ranch3to1.gsz

Section 2-2

Section 2-2 SSA for Skyline Ranch3to1.gsz Run By: Dr. Alexander Bykovtsev, Ph.D., P.E. 3/19/2016 1:57:45 PM

Name: TQs (150 psf/17° - A-Bed 6-11°)
 Model: Anisotropic Fn.
 Unit Weight: 120 pcf
 Cohesion: 225 psf
 Phi: 40°
 Phi-Anisotropic Strength Fn.: 17° - A-Bed 6-11°
 C-Anisotropic Strength Fn.: 150 psf - A-Bed 6-11° (TQs)

Name: Tmc (100 psf/25° - A-Bed 4-8°)
 Model: Anisotropic Fn.
 Unit Weight: 120 pcf
 Cohesion: 200 psf
 Phi: 40°
 Phi-Anisotropic Strength Fn.: 25° - A-Bed 4-8°
 C-Anisotropic Strength Fn.: 100 psf - A-Bed 4-8°

Name: Fill
 Model: Mohr-Coulomb
 Unit Weight: 120 pcf
 Cohesion: 200 psf
 Phi: 33°

Name: Along Bedding Shear
 Model: Mohr-Coulomb
 Unit Weight: 120 pcf
 Cohesion: 150 psf
 Phi: 11°

Name: Tmc (150 psf/17° - A-Bed 4-8°)
 Model: Anisotropic Fn.
 Unit Weight: 120 pcf
 Cohesion: 200 psf
 Phi: 40°
 Phi-Anisotropic Strength Fn.: 150 psf - A-Bed 4-8°
 C-Anisotropic Strength Fn.: 17° - A-Bed 4-8°

Keyway 75' wide by 30' deep
 3H:1V Backcut

1.169

Seismic Load
 Horizontal: 0.15
 Vertical: 0.00

Materials

- TQs (150 psf/17° - A-Bed 6-11°)
- Tmc (100 psf/25° - A-Bed 4-8°)
- Fill
- Along Bedding Shear
- Tmc (150 psf/17° - A-Bed 4-8°)

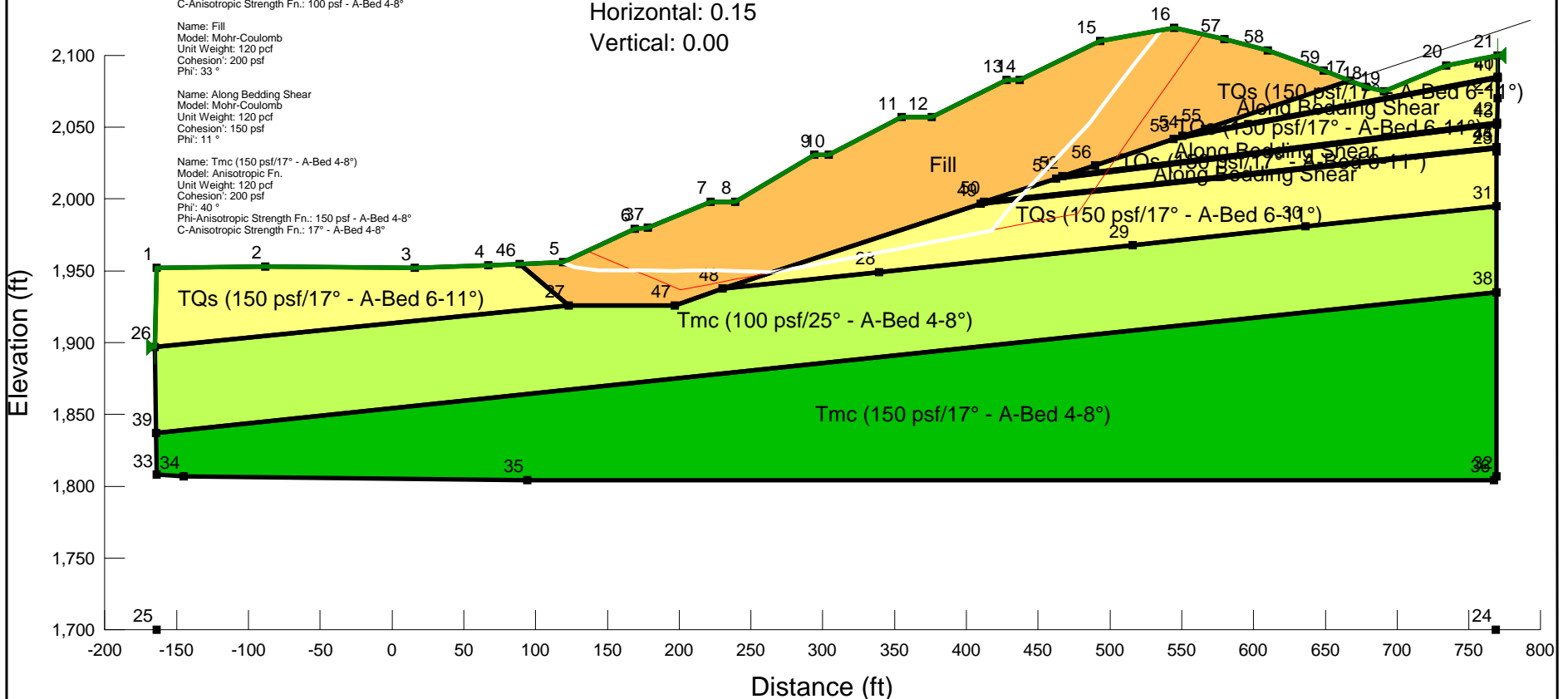

LGC Valley, Inc
 GEOTECHNICAL CONSULTING
 28532 Constellation Road, Valencia, CA 91355
 Phone 661-702-8474, Fax 661-702-8475

Skyline Ranch
 Development project, Tract 60922
 Los Angeles CA

Project No: **153035-01**
 Engineer: **BAS**
 Date: **March 2016**

2 - Translational Seismic

Report generated using GeoStudio 2012. Copyright © 1991-2016 GEO-SLOPE International Ltd.

File Information

File Version: 8.15
 Title: Static Slope Stability Analyses for Skyline Ranch Development project, Tract 60922, Los Angeles CA
 Comments: Run By: Dr. Alexander Bykovtsev, Ph.D., P.E.
 Last Edited By: Alexander Bykovtsev
 Revision Number: 91
 Date: 3/19/2016
 Time: 1:57:45 PM
 Tool Version: 8.15.5.11777
 File Name: Section 2-2 SSA for Skyline Ranch3to1.gsz
 Directory: P:\FINAL PROJECTS\PARDEE\Skyline Ranch\SLOPE RESULTS\Section 2-2 results\Latest Update 3-19-16\
 Last Solved Date: 3/19/2016
 Last Solved Time: 2:00:22 PM

Project Settings

Length(L) Units: Feet
 Time(t) Units: Seconds
 Force(F) Units: Pounds
 Pressure(p) Units: psf
 Strength Units: psf
 Unit Weight of Water: 62.4 pcf
 View: 2D
 Element Thickness: 1

Analysis Settings

2 - Translational Seismic

Kind: SLOPE/W
 Parent: 3 - Translational Static
 Method: Spencer
 Settings
 PWP Conditions Source: (none)
 Initial Slip Surface Source: Parent Analysis
 Slip Surface
 Direction of movement: Right to Left
 Use Passive Mode: No
 Slip Surface Option: Critical Slip Surfaces from Other
 Critical slip surfaces saved: 10
 Resisting Side Maximum Convex Angle: 1 °
 Driving Side Maximum Convex Angle: 5 °
 Optimize Critical Slip Surface Location: Yes
 Critical Slip Surface Optimizations
 Maximum Iterations: 2,000
 Convergence Tolerance: 1e-007
 Starting Points: 8
 Ending Points: 16
 Complete Passes per Insertion: 1

file:///P:/FINAL%20PROJECTS/PARDEE/Skyline%20Ranch/SLOPE%20RESULTS/Sect... 3/19/2016

Tension Crack
 Tension Crack Option: (none)
 F of S Distribution
 F of S Calculation Option: Constant
 Advanced
 Number of Slices: 30
 F of S Tolerance: 0.01
 Minimum Slip Surface Depth: 0.1 ft
 Search Method: Root Finder
 Tolerable difference between starting and converged F of S: 3
 Maximum iterations to calculate converged lambda: 20
 Max Absolute Lambda: 2

Materials

TQs (150 psf/17° - A-Bed 6-11°)

Model: Anisotropic Fn.
 Unit Weight: 120 pcf
 Cohesion: 225 psf
 Phi: 40 °
 Phi-Anisotropic Strength Fn.: 17° - A-Bed 6-11°
 C-Anisotropic Strength Fn.: 150 psf - A-Bed 6-11° (TQs)
 Phi-B: 0 °

Tmc (100 psf/25° - A-Bed 4-8°)

Model: Anisotropic Fn.
 Unit Weight: 120 pcf
 Cohesion: 200 psf
 Phi: 40 °
 Phi-Anisotropic Strength Fn.: 25° - A-Bed 4-8°
 C-Anisotropic Strength Fn.: 100 psf - A-Bed 4-8°
 Phi-B: 0 °

Fill

Model: Mohr-Coulomb
 Unit Weight: 120 pcf
 Cohesion: 200 psf
 Phi: 33 °
 Phi-B: 0 °

Along Bedding Shear

Model: Mohr-Coulomb
 Unit Weight: 120 pcf
 Cohesion: 150 psf
 Phi: 11 °
 Phi-B: 0 °

Tmc (150 psf/17° - A-Bed 4-8°)

Model: Anisotropic Fn.
 Unit Weight: 120 pcf
 Cohesion: 200 psf
 Phi: 40 °
 Phi-Anisotropic Strength Fn.: 150 psf - A-Bed 4-8°
 C-Anisotropic Strength Fn.: 17° - A-Bed 4-8°

file:///P:/FINAL%20PROJECTS/PARDEE/Skyline%20Ranch/SLOPE%20RESULTS/Sect... 3/19/2016

Phi-B: 0 °

Slip Surface Limits

Left Coordinate: (-165, 1,897) ft
 Right Coordinate: (770, 2,100) ft

Seismic Coefficients

Horz Seismic Coef.: 0.15
 Vert Seismic Coef.: 0

Anisotropic Strength Functions

25° - A-Bed 4-8°

Model: Spline Data Point Function
 Function: Modifier Factor vs. Inclination
 Curve Fit to Data: 100 %
 Segment Curvature: 0 %
 Y-Intercept: 1
 Data Points: Inclination (°), Modifier Factor
 Data Point: (-90, 1)
 Data Point: (3.9, 1)
 Data Point: (4, 0.625)
 Data Point: (8, 0.625)
 Data Point: (8.1, 1)

100 psf - A-Bed 4-8°

Model: Spline Data Point Function
 Function: Modifier Factor vs. Inclination
 Curve Fit to Data: 100 %
 Segment Curvature: 0 %
 Y-Intercept: 1
 Data Points: Inclination (°), Modifier Factor
 Data Point: (-90, 1)
 Data Point: (3.9, 1)
 Data Point: (4, 0.5)
 Data Point: (8, 0.5)
 Data Point: (8.1, 1)

17° - A-Bed 4-8°

Model: Spline Data Point Function
 Function: Modifier Factor vs. Inclination
 Curve Fit to Data: 100 %
 Segment Curvature: 0 %
 Y-Intercept: 1
 Data Points: Inclination (°), Modifier Factor
 Data Point: (-90, 1)
 Data Point: (3.9, 1)
 Data Point: (4, 0.425)
 Data Point: (8, 0.425)
 Data Point: (8.1, 1)

150 psf - A-Bed 4-8°

Model: Spline Data Point Function
 Function: Modifier Factor vs. Inclination
 Curve Fit to Data: 100 %
 Segment Curvature: 0 %
 Y-Intercept: 1
 Data Points: Inclination (°), Modifier Factor
 Data Point: (-90, 1)
 Data Point: (3.9, 1)
 Data Point: (4, 0.75)
 Data Point: (8, 0.75)
 Data Point: (8.1, 1)

17° - A-Bed 6-11°

Model: Spline Data Point Function
 Function: Modifier Factor vs. Inclination
 Curve Fit to Data: 100 %
 Segment Curvature: 0 %
 Y-Intercept: 1
 Data Points: Inclination (°), Modifier Factor
 Data Point: (-90, 1)
 Data Point: (5.9, 1)
 Data Point: (6, 0.425)
 Data Point: (11, 0.425)
 Data Point: (11.1, 1)

150 psf - A-Bed 6-11° (TQs)

Model: Spline Data Point Function
 Function: Modifier Factor vs. Inclination
 Curve Fit to Data: 100 %
 Segment Curvature: 0 %
 Y-Intercept: 1
 Data Points: Inclination (°), Modifier Factor
 Data Point: (-90, 1)
 Data Point: (5.9, 1)
 Data Point: (6, 0.667)
 Data Point: (11, 0.667)
 Data Point: (11.1, 1)

Points

	X (ft)	Y (ft)
Point 1	-164	1,952
Point 2	-88	1,953
Point 3	16	1,952
Point 4	67	1,954
Point 5	119	1,956
Point 6	169	1,979
Point 7	222	1,998
Point 8	239	1,998
Point 9	294	2,031
Point 10	304	2,031

Point 11	355	2,057
Point 12	376	2,057
Point 13	428	2,083
Point 14	437	2,083
Point 15	493	2,110
Point 16	545	2,119
Point 17	666.7794	2,082.2835
Point 18	678	2,078
Point 19	691	2,075
Point 20	734	2,093
Point 21	770	2,100
Point 22	770	2,070
Point 23	769	2,033
Point 24	768.9132	1,700.0035
Point 25	-164	1,700
Point 26	-165	1,897
Point 27	123	1,926
Point 28	339	1,949
Point 29	516	1,968
Point 30	636	1,981
Point 31	769	1,995
Point 32	769	1,807
Point 33	-164	1,808
Point 34	-145.1146	1,807
Point 35	94.3981	1,804.0495
Point 36	767.2671	1,804.0495
Point 37	178	1,980
Point 38	769	1,935
Point 39	-164.3258	1,837
Point 40	770	2,085
Point 41	770	2,084
Point 42	769.5405	2,053
Point 43	769.5135	2,052
Point 44	769.0811	2,036
Point 45	769.0541	2,035
Point 46	89	1,954.8462
Point 47	197	1,926
Point 48	230.4185	1,937.6441
Point 49	410.1571	1,996.9191
Point 50	412.2316	1,997.8289
Point 51	462.5895	2,014.3399
Point 52	467.0781	2,015.9473
Point 53	544.2511	2,041.6026
Point 54	550.5628	2,043.7746
Point 55	566.1504	2,048.8086
Point 56	489.5416	2,023.5144
Point 57	579.8545	2,111.4639
Point 58	609.9957	2,103.2729

	648.9076	2,089.3897
--	----------	------------

Regions

	Material	Points	Area (ft²)
Region 1	Tmc (100 psf/25° - A-Bed 4-8°)	26,39,38,31,30,29,28,48,47,27	55,091
Region 2	Tmc (150 psf/17° - A-Bed 4-8°)	33,34,35,36,32,38,39	76,059
Region 3	TQs (150 psf/17° - A-Bed 6-11°)	40,21,20,19,18,17,55,54	2,168.2
Region 4	TQs (150 psf/17° - A-Bed 6-11°)	43,51,50,44	4,432.1
Region 5	TQs (150 psf/17° - A-Bed 6-11°)	22,41,53,56,52,42	5,946.6
Region 6	Fill	46,27,47,48,49,50,51,52,56,53,54,55,17,59,58,57,16,15,14,13,12,11,10,9,8,7,37,6,5	34,644
Region 7	Along Bedding Shear	45,44,50,49	301.67
Region 8	Along Bedding Shear	43,42,52,51	312.89
Region 9	Along Bedding Shear	41,40,54,53	221.08
Region 10	TQs (150 psf/17° - A-Bed 6-11°)	4,3,2,1,26,27,46	11,437
Region 11	TQs (150 psf/17° - A-Bed 6-11°)	28,29,30,31,23,45,49,48	18,001

Current Slip Surface

Slip Surface: 3
 F of S: 1.169
 Volume: 24,302.696 ft³
 Weight: 2,916,323.5 lbs

Resisting Moment: 2.8664325e+008 lbs-ft
 Activating Moment: 2.461686e+008 lbs-ft
 Resisting Force: 1,289,478.8 lbs
 Activating Force: 1,099,408.3 lbs
 F of S Rank (Analysis): 1 of 3 slip surfaces
 F of S Rank (Query): 1 of 3 slip surfaces
 Exit: (118.50469, 1,955.9809) ft
 Entry: (535.60985, 2,117.3748) ft
 Radius: 239.92928 ft
 Center: (310.4629, 2,152.4703) ft

Slip Slices

	X (ft)	Y (ft)	PWP (psf)	Base Normal Stress (psf)	Frictional Strength (psf)	Cohesive Strength (psf)
Slice 1	118.75234	1,955.8811	0	406.7871	264.17063	200
Slice 2	122.93465	1,954.1958	0	1,456.1212	945.61619	200
Slice 3	135.2265	1,951.4429	0	2,392.984	1,554.022	200
Slice 4	149.93777	1,950.3077	0	3,088.6657	2,005.8029	200
Slice 5	162.64593	1,950.3718	0	3,954.1748	2,567.8711	200
Slice 6	172.1009	1,950.4195	0	4,436.1651	2,880.8793	200
Slice 7	176.6009	1,950.4119	0	4,652.8257	3,021.5804	200
Slice 8	186.93385	1,950.2395	0	5,266.9634	3,420.406	200
Slice 9	202.40078	1,950.18	0	5,992.5673	3,891.6187	200
Slice 10	215.46693	1,950.3591	0	6,757.0076	4,388.052	200
Slice 11	224.52565	1,950.4833	0	7,134.1034	4,632.9409	200
Slice 12	233.02565	1,950.2899	0	7,703.9564	5,003.0078	200
Slice 13	245.51421	1,949.8132	0	8,400.7856	5,455.5339	200
Slice 14	258.58301	1,949.3144	0	9,726.0687	6,316.1829	200
Slice 15	272.3532	1,950.398	0	7,483.0193	2,287.7886	150.075
Slice 16	286.7844	1,953.0657	0	8,142.8478	2,489.5184	150.075
Slice 17	297.1771	1,954.9869	0	8,408.0784	2,570.6075	150.075
Slice 18	302.1771	1,955.9102	0	8,309.5904	2,540.4967	150.075
Slice 19	312.2465	1,957.7664	0	8,568.2817	2,619.5866	150.075
Slice 20	329.11975	1,960.9288	0	9,126.865	2,790.3627	150.075
Slice 21	346.37325	1,964.2133	0	9,731.4474	2,975.202	150.075
Slice 22	356.6918	1,966.1776	0	9,998.4082	3,056.8202	150.075
Slice 23	367.1918	1,968.1923	0	9,764.5482	2,985.322	150.075
Slice	384.53927	1,971.5257	0	9,867.1102	3,016.6783	150.075

24						
Slice 25	401.61782	1,974.8075	0	10,443.095	3,192.7747	150.075
Slice 26	411.19435	1,976.6478	0	10,766.07	3,291.5179	150.075
Slice 27	414.8498	1,977.3502	0	10,889.354	3,329.2095	150.075
Slice 28	422.734	1,984.3333	0	4,983.9929	4,182.0666	225
Slice 29	429.38355	1,992.5158	0	4,692.0303	3,937.0809	225
Slice 30	433.31329	1,996.9323	0	4,922.4232	4,130.4035	225
Slice 31	436.22971	2,000.0409	0	5,824.6994	1,132.2069	150
Slice 32	436.79997	2,000.6487	0	4,707.3255	3,949.9151	225
Slice 33	440.44695	2,004.536	0	4,578.5221	3,841.8362	225
Slice 34	451.28935	2,016.0929	0	4,445.4702	2,886.9221	200
Slice 35	465.39438	2,031.196	0	3,916.2068	2,543.2145	200
Slice 36	478.81353	2,045.6365	0	3,432.8164	2,229.297	200
Slice 37	489.26155	2,057.7149	0	2,663.6924	1,729.8221	200
Slice 38	499.0757	2,070.4684	0	2,128.0008	1,381.9399	200
Slice 39	511.2271	2,086.2591	0	1,387.3195	900.93583	200
Slice 40	526.45632	2,105.7646	0	484.18537	314.43365	200

Section 2-2 SSA for Skyline Ranch3to1.gsz

Section 2-2

Section 2-2 SSA for Skyline Ranch3to1.gsz Run By: Dr. Alexander Bykovtsev, Ph.D., P.E. 3/19/2016 2:13:34 PM

Keyway 75' wide by 30' deep
3H:1V Backcut

Temporary 3H:1V Backcut

Materials

- TQs (150 psf/17° - A-Bed 6-11°)
- Tmc (100 psf/25° - A-Bed 4-8°)
- Along Bedding Shear
- Tmc (150 psf/17° - A-Bed 4-8°)

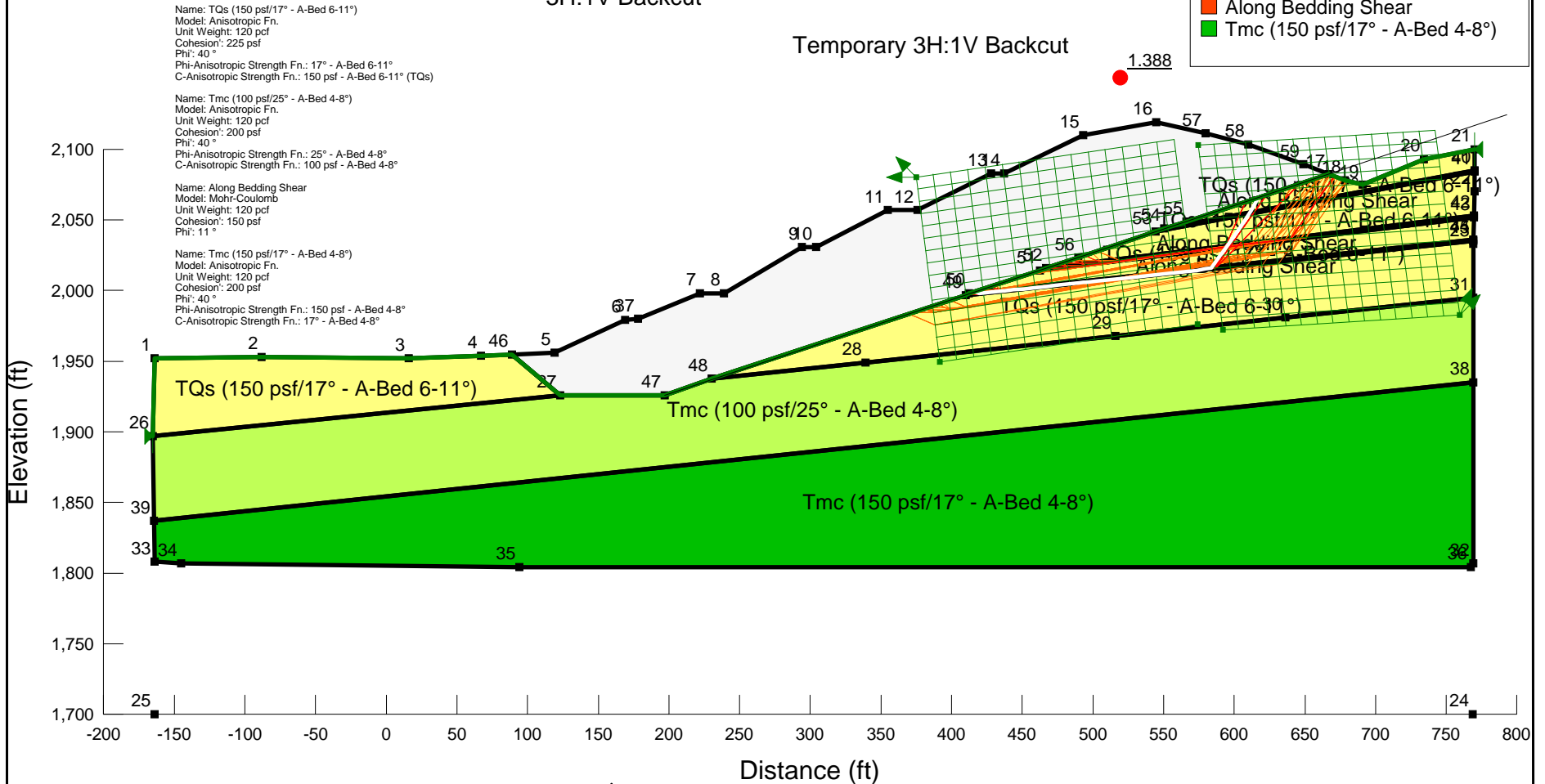

Name: TQs (150 psf/17° - A-Bed 6-11°)
Model: Anisotropic Fn.
Unit Weight: 120 pcf
Cohesion: 225 psf
Phi: 40°
Phi-Anisotropic Strength Fn.: 17° - A-Bed 6-11°
C-Anisotropic Strength Fn.: 150 psf - A-Bed 6-11° (TQs)

Name: Tmc (100 psf/25° - A-Bed 4-8°)
Model: Anisotropic Fn.
Unit Weight: 120 pcf
Cohesion: 200 psf
Phi: 40°
Phi-Anisotropic Strength Fn.: 25° - A-Bed 4-8°
C-Anisotropic Strength Fn.: 100 psf - A-Bed 4-8°

Name: Along Bedding Shear
Model: Mohr-Coulomb
Unit Weight: 120 pcf
Cohesion: 150 psf
Phi: 11°

Name: Tmc (150 psf/17° - A-Bed 4-8°)
Model: Anisotropic Fn.
Unit Weight: 120 pcf
Cohesion: 200 psf
Phi: 40°
Phi-Anisotropic Strength Fn.: 150 psf - A-Bed 4-8°
C-Anisotropic Strength Fn.: 17° - A-Bed 4-8°



LGC Valley, Inc
GEOTECHNICAL CONSULTING
28532 Constellation Road, Valencia, CA 91355
Phone 661-702-8474, Fax 661-702-8475

Skyline Ranch
Development project, Tract 60922
Los Angeles CA

Project No: **153035-01**
Engineer: **BAS**
Date: **March 2016**

5 - Translational Temporary

Report generated using GeoStudio 2012. Copyright © 1991-2016 GEO-SLOPE International Ltd.

File Information

File Version: 8.15
 Title: Static Slope Stability Analyses for Skyline Ranch Development project, Tract 60922, Los Angeles CA
 Comments: Run By: Dr. Alexander Bykovtsev, Ph.D., P.E.
 Last Edited By: Alexander Bykovtsec
 Revision Number: 94
 Date: 3/19/2016
 Time: 2:13:34 PM
 Tool Version: 8.15.5.11777
 File Name: Section 2-2 SSA for Skyline Ranch3to1.gsz
 Directory: P:\FINAL PROJECTS\PARDEE\Skyline Ranch\SLOPE RESULTS\Section 2-2 results\Latest Update 3-19-16\
 Last Solved Date: 3/19/2016
 Last Solved Time: 2:15:32 PM

Project Settings

Length(L) Units: Feet
 Time(t) Units: Seconds
 Force(F) Units: Pounds
 Pressure(p) Units: psf
 Strength Units: psf
 Unit Weight of Water: 62.4 pcf
 View: 2D
 Element Thickness: 1

Analysis Settings

5 - Translational Temporary

Kind: SLOPE/W
 Method: Janbu
 Settings
 PWP Conditions Source: (none)
 Slip Surface
 Direction of movement: Right to Left
 Use Passive Mode: No
 Slip Surface Option: Block
 Critical slip surfaces saved: 1
 Resisting Side Maximum Convex Angle: 1 °
 Driving Side Maximum Convex Angle: 5 °
 Restrict Block Crossing: No
 Optimize Critical Slip Surface Location: Yes
 Critical Slip Surface Optimizations
 Maximum Iterations: 2,000
 Convergence Tolerance: 1e-007
 Starting Points: 8
 Ending Points: 16
 Complete Passes per Insertion: 1
 Tension Crack

file:///P:/FINAL%20PROJECTS/PARDEE/Skyline%20Ranch/SLOPE%20RESULTS/Sect... 3/19/2016

Tension Crack Option: (none)
 F of S Distribution
 F of S Calculation Option: Constant
 Advanced
 Number of Slices: 30
 F of S Tolerance: 0.01
 Minimum Slip Surface Depth: 0.1 ft

Materials

TQs (150 psf/17° - A-Bed 6-11°)

Model: Anisotropic Fn.
 Unit Weight: 120 pcf
 Cohesion: 225 psf
 Phi: 40 °
 Phi-Anisotropic Strength Fn.: 17° - A-Bed 6-11°
 C-Anisotropic Strength Fn.: 150 psf - A-Bed 6-11° (TQs)
 Phi-B: 0 °

Tmc (100 psf/25° - A-Bed 4-8°)

Model: Anisotropic Fn.
 Unit Weight: 120 pcf
 Cohesion: 200 psf
 Phi: 40 °
 Phi-Anisotropic Strength Fn.: 25° - A-Bed 4-8°
 C-Anisotropic Strength Fn.: 100 psf - A-Bed 4-8°
 Phi-B: 0 °

Along Bedding Shear

Model: Mohr-Coulomb
 Unit Weight: 120 pcf
 Cohesion: 150 psf
 Phi: 11 °
 Phi-B: 0 °

Tmc (150 psf/17° - A-Bed 4-8°)

Model: Anisotropic Fn.
 Unit Weight: 120 pcf
 Cohesion: 200 psf
 Phi: 40 °
 Phi-Anisotropic Strength Fn.: 150 psf - A-Bed 4-8°
 C-Anisotropic Strength Fn.: 17° - A-Bed 4-8°
 Phi-B: 0 °

Slip Surface Limits

Left Coordinate: (-165, 1,897) ft
 Right Coordinate: (770, 2,100) ft

Slip Surface Block

Left Grid
 Upper Left: (375.131, 2,080.4026) ft

file:///P:/FINAL%20PROJECTS/PARDEE/Skyline%20Ranch/SLOPE%20RESULTS/Sect... 3/19/2016

Lower Left: (391.5828, 1,949.63) ft
 Lower Right: (574.0478, 1,976.1582) ft
 X Increments: 15
 Y Increments: 15
 Starting Angle: 135 °
 Ending Angle: 180 °
 Angle Increments: 2

Right Grid

Upper Left: (574.5182, 2,103.0179) ft
 Lower Left: (592.2047, 1,972.2456) ft
 Lower Right: (759.7473, 1,982.8533) ft
 X Increments: 15
 Y Increments: 15
 Starting Angle: 45 °
 Ending Angle: 65 °
 Angle Increments: 2

Seismic Coefficients

Horz Seismic Coef.: 0
 Vert Seismic Coef.: 0

Anisotropic Strength Functions

25° - A-Bed 4-8°

Model: Spline Data Point Function
 Function: Modifier Factor vs. Inclination
 Curve Fit to Data: 100 %
 Segment Curvature: 0 %
 Y-Intercept: 1
 Data Points: Inclination (°), Modifier Factor
 Data Point: (-90, 1)
 Data Point: (3.9, 1)
 Data Point: (4, 0.625)
 Data Point: (8, 0.625)
 Data Point: (8.1, 1)

100 psf - A-Bed 4-8°

Model: Spline Data Point Function
 Function: Modifier Factor vs. Inclination
 Curve Fit to Data: 100 %
 Segment Curvature: 0 %
 Y-Intercept: 1
 Data Points: Inclination (°), Modifier Factor
 Data Point: (-90, 1)
 Data Point: (3.9, 1)
 Data Point: (4, 0.5)
 Data Point: (8, 0.5)
 Data Point: (8.1, 1)

17° - A-Bed 4-8°

Model: Spline Data Point Function
 Function: Modifier Factor vs. Inclination
 Curve Fit to Data: 100 %

Segment Curvature: 0 %
 Y-Intercept: 1
 Data Points: Inclination (°), Modifier Factor
 Data Point: (-90, 1)
 Data Point: (3.9, 1)
 Data Point: (4, 0.425)
 Data Point: (8, 0.425)
 Data Point: (8.1, 1)

150 psf - A-Bed 4-8°

Model: Spline Data Point Function
 Function: Modifier Factor vs. Inclination
 Curve Fit to Data: 100 %
 Segment Curvature: 0 %
 Y-Intercept: 1
 Data Points: Inclination (°), Modifier Factor
 Data Point: (-90, 1)
 Data Point: (3.9, 1)
 Data Point: (4, 0.75)
 Data Point: (8, 0.75)
 Data Point: (8.1, 1)

17° - A-Bed 6-11°

Model: Spline Data Point Function
 Function: Modifier Factor vs. Inclination
 Curve Fit to Data: 100 %
 Segment Curvature: 0 %
 Y-Intercept: 1
 Data Points: Inclination (°), Modifier Factor
 Data Point: (-90, 1)
 Data Point: (5.9, 1)
 Data Point: (6, 0.425)
 Data Point: (11, 0.425)
 Data Point: (11.1, 1)

150 psf - A-Bed 6-11° (TQs)

Model: Spline Data Point Function
 Function: Modifier Factor vs. Inclination
 Curve Fit to Data: 100 %
 Segment Curvature: 0 %
 Y-Intercept: 1
 Data Points: Inclination (°), Modifier Factor
 Data Point: (-90, 1)
 Data Point: (5.9, 1)
 Data Point: (6, 0.667)
 Data Point: (11, 0.667)
 Data Point: (11.1, 1)

Points

	X (ft)	Y (ft)
Point 1	-164	1,952
Point 2	-88	1,953
Point 3	16	1,952

Point 4	67	1,954
Point 5	119	1,956
Point 6	169	1,979
Point 7	222	1,998
Point 8	239	1,998
Point 9	294	2,031
Point 10	304	2,031
Point 11	355	2,057
Point 12	376	2,057
Point 13	428	2,083
Point 14	437	2,083
Point 15	493	2,110
Point 16	545	2,119
Point 17	666.7794	2,082.2835
Point 18	678	2,078
Point 19	691	2,075
Point 20	734	2,093
Point 21	770	2,100
Point 22	770	2,070
Point 23	769	2,033
Point 24	768.9132	1,700.0035
Point 25	-164	1,700
Point 26	-165	1,897
Point 27	123	1,926
Point 28	339	1,949
Point 29	516	1,968
Point 30	636	1,981
Point 31	769	1,995
Point 32	769	1,807
Point 33	-164	1,808
Point 34	-145.1146	1,807
Point 35	94.3981	1,804.0495
Point 36	767.2671	1,804.0495
Point 37	178	1,980
Point 38	769	1,935
Point 39	-164.3258	1,837
Point 40	770	2,085
Point 41	770	2,084
Point 42	769.5405	2,053
Point 43	769.5135	2,052
Point 44	769.0811	2,036
Point 45	769.0541	2,035
Point 46	89	1,954.8462
Point 47	197	1,926
Point 48	230.4185	1,937.6441
Point 49	410.1571	1,996.9191
Point 50	412.2316	1,997.8289
Point 51	462.5895	2,014.3399

	467.0781	2,015.9473
Point 53	544.2511	2,041.6026
Point 54	550.5628	2,043.7746
Point 55	566.1504	2,048.8086
Point 56	489.5416	2,023.5144
Point 57	579.8545	2,111.4639
Point 58	609.9957	2,103.2729
Point 59	648.9076	2,089.3897

Regions

	Material	Points	Area (ft ²)
Region 1	Tmc (100 psf/25° - A-Bed 4-8°)	26,39,38,31,30,29,28,48,47,27	55,091
Region 2	Tmc (150 psf/17° - A-Bed 4-8°)	33,34,35,36,32,38,39	76,059
Region 3	TQs (150 psf/17° - A-Bed 6-11°)	40,21,20,19,18,17,55,54	2,168.2
Region 4	TQs (150 psf/17° - A-Bed 6-11°)	43,51,50,44	4,432.1
Region 5	TQs (150 psf/17° - A-Bed 6-11°)	22,41,53,56,52,42	5,946.6
Region 6		46,27,47,48,49,50,51,52,56,53,54,55,17,59,58,57,16,15,14,13,12,11,10,9,8,7,37,6,5	34,644
Region 7	Along Bedding Shear	45,44,50,49	301.67
Region 8	Along Bedding Shear	43,42,52,51	312.89
Region 9	Along Bedding Shear	41,40,54,53	221.08
Region 10	TQs (150 psf/17° - A-Bed 6-11°)	4,3,2,1,26,27,46	11,437
Region 11	TQs (150 psf/17° - A-Bed 6-	28,29,30,31,23,45,49,48	18,001

11°	
-----	--

Current Slip Surface

Slip Surface: 589,825
 F of S: 1.388
 Volume: 4,095.293 ft³
 Weight: 491,435.16 lbs
 Resisting Force: 143,521.09 lbs
 Activating Force: 103,406.68 lbs
 F of S Rank (Analysis): 1 of 589,825 slip surfaces
 F of S Rank (Query): 1 of 150 slip surfaces
 Exit: (416.21173, 1,999.1339) ft
 Entry: (617.00763, 2,065.7266) ft
 Radius: 104.08933 ft
 Center: (503.9407, 2,084.4457) ft

Slip Slices

	X (ft)	Y (ft)	PWP (psf)	Base Normal Stress (psf)	Frictional Strength (psf)	Cohesive Strength (psf)
Slice 1	417.32814	1,998.8137	0	155.68729	130.63715	225
Slice 2	419.01703	1,998.3293	0	247.78936	48.165373	150
Slice 3	423.79475	1,998.553	0	353.54758	68.722687	150
Slice 4	432.0779	1,999.3171	0	584.77313	113.66838	150
Slice 5	436.5779	1,999.7374	0	707.29512	137.48424	150
Slice 6	440.44925	2,000.1417	0	809.60325	157.37093	150
Slice 7	447.60312	2,000.9009	0	996.42984	193.68634	150
Slice 8	455.01238	2,001.6989	0	1,189.2822	231.17303	150
Slice 9	460.65325	2,002.3022	0	1,337.2345	259.93205	150
Slice 10	464.8338	2,002.7434	0	1,455.1793	282.8582	150
Slice 11	470.22625	2,003.3125	0	1,608.3354	312.62874	150
Slice 12	477.4162	2,004.072	0	1,804.8717	350.83152	150
Slice 13	485.4998	2,004.9265	0	2,025.8265	393.78078	150
Slice 14	491.2708	2,005.5366	0	2,182.2935	424.19488	150
Slice 15	494.20165	2,005.8465	0	2,260.242	439.34655	150
Slice 16	499.07477	2,006.3616	0	2,389.8465	464.5391	150
Slice 17	506.4177	2,007.1379	0	2,585.1379	502.4999	150
Slice 18	513.76063	2,007.9142	0	2,780.4293	540.46071	150
Slice 19	520.39385	2,008.6166	0	2,956.5112	574.68757	150
Slice 20	526.31735	2,009.2451	0	3,113.7724	605.25605	150
Slice						

21	532.2352	2,009.8737	0	3,270.6692	635.75368	150
Slice 22	539.7212	2,010.6708	0	3,468.9172	674.28921	150
Slice 23	544.62555	2,011.1936	0	3,599.4283	699.65799	150
Slice 24	547.7814	2,011.53	0	3,688.0625	716.88672	150
Slice 25	554.07528	2,012.2008	0	3,856.0364	749.53755	150
Slice 26	561.10023	2,012.9496	0	4,035.7494	784.47021	150
Slice 27	565.38155	2,013.4063	0	4,144.964	805.69939	150
Slice 28	570.0094	2,013.9014	0	4,267.5554	829.52874	150
Slice 29	576.86145	2,014.869	0	4,367.2022	848.89811	150
Slice 30	581.77095	2,015.779	0	4,451.7981	865.3419	150
Slice 31	586.32661	2,019.7328	0	2,235.1996	1,875.5552	225
Slice 32	591.59119	2,026.9111	0	1,877.8913	1,575.7379	225
Slice 33	594.63212	2,031.0574	0	2,620.6467	509.40211	150
Slice 34	595.53539	2,032.289	0	1,610.1971	1,351.1158	225
Slice 35	599.51625	2,038.0847	0	1,262.453	1,059.3238	225
Slice 36	606.50255	2,048.3462	0	757.45992	635.58434	225
Slice 37	610.18033	2,053.7481	0	491.6179	412.51639	225
Slice 38	610.7515	2,054.587	0	770.44213	149.75878	150
Slice 39	611.52332	2,055.7207	0	394.54208	331.06012	225
Slice 40	614.45811	2,061.0066	0	78.002255	65.451663	225

Section 3 SSA A for Skyline Ranch Development project.gsz

Section 3 SSA A for Skyline Ranch Development project.gsz Run By: Dr. Alexander Bykovtsev, Ph.D., P.E. 3/19/2016 4:54:49 PM

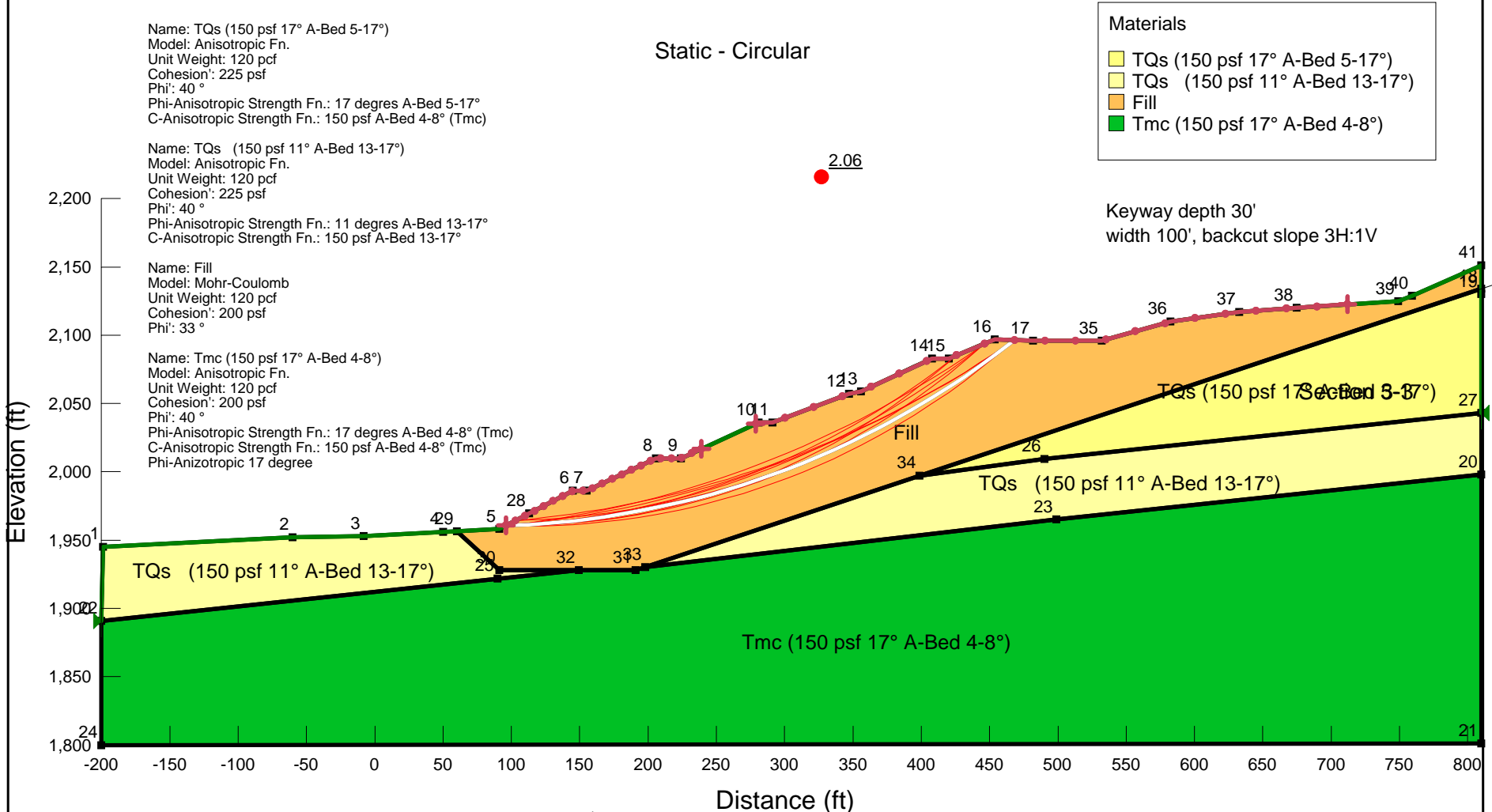

LGC Valley, Inc
 GEOTECHNICAL CONSULTING
 28532 Constellation Road, Valencia, CA 91355
 Phone 661-702-8474, Fax 661-702-8475

Skyline Ranch
 Development project, Tract 60922
 Los Angeles CA

Project No: **153035-01**
 Engineer: **BAS**
 Date: **March 2016**

1 - Circular Mode of Failure

Report generated using GeoStudio 2012. Copyright © 1991-2016 GEO-SLOPE International Ltd.

File Information

File Version: 8.15
 Title: Static Slope Stability Analyses for Skyline Ranch Development project, Tract 60922, Los Angeles CA
 Comments: Run By: Dr. Alexander Bykovtsev, Ph.D., P.E.
 Last Edited By: Alexander Bykovtsec
 Revision Number: 87
 Date: 3/19/2016
 Time: 4:54:49 PM
 Tool Version: 8.15.5.11777
 File Name: Section 3 SSA A for Skyline Ranch Development project.gsz
 Directory: P:\FINAL PROJECTS\PARDEE\Skyline Ranch\SLOPE RESULTS\Section 3-3 results\Latest update 3-19-16\
 Last Solved Date: 3/19/2016
 Last Solved Time: 4:55:45 PM

Project Settings

Length(L) Units: Feet
 Time(t) Units: Seconds
 Force(F) Units: Pounds
 Pressure(p) Units: psf
 Strength Units: psf
 Unit Weight of Water: 62.4 pcf
 View: 2D
 Element Thickness: 1

Analysis Settings

1 - Circular Mode of Failure

Kind: SLOPE/W
 Method: Bishop
 Settings
 PWP Conditions Source: (none)
 Slip Surface
 Direction of movement: Right to Left
 Use Passive Mode: No
 Slip Surface Option: Entry and Exit
 Critical slip surfaces saved: 1
 Resisting Side Maximum Convex Angle: 1 °
 Driving Side Maximum Convex Angle: 5 °
 Optimize Critical Slip Surface Location: No
 Tension Crack
 Tension Crack Option: (none)
 F of S Distribution
 F of S Calculation Option: Constant
 Advanced
 Number of Slices: 30
 F of S Tolerance: 0.01
 Minimum Slip Surface Depth: 0.1 ft

file:///P:/FINAL%20PROJECTS/PARDEE/Skyline%20Ranch/SLOPE%20RESULTS/Sect... 3/19/2016

Materials

TQs (150 psf 17° A-Bed 5-17°)

Model: Anisotropic Fn.
 Unit Weight: 120 pcf
 Cohesion: 225 psf
 Phi: 40 °
 Phi-Anisotropic Strength Fn.: 17 degrees A-Bed 5-17°
 C-Anisotropic Strength Fn.: 150 psf A-Bed 4-8° (Tmc)
 Phi-B: 0 °

TQs (150 psf 11° A-Bed 13-17°)

Model: Anisotropic Fn.
 Unit Weight: 120 pcf
 Cohesion: 225 psf
 Phi: 40 °
 Phi-Anisotropic Strength Fn.: 11 degrees A-Bed 13-17°
 C-Anisotropic Strength Fn.: 150 psf A-Bed 13-17°
 Phi-B: 0 °

Fill

Model: Mohr-Coulomb
 Unit Weight: 120 pcf
 Cohesion: 200 psf
 Phi: 33 °
 Phi-B: 0 °

Tmc (150 psf 17° A-Bed 4-8°)

Model: Anisotropic Fn.
 Unit Weight: 120 pcf
 Cohesion: 200 psf
 Phi: 40 °
 Phi-Anisotropic Strength Fn.: 17 degrees A-Bed 4-8° (Tmc)
 C-Anisotropic Strength Fn.: 150 psf A-Bed 4-8° (Tmc)
 Phi-B: 0 °

Slip Surface Entry and Exit

Left Projection: Range
 Left-Zone Left Coordinate: (96.0789, 1,960.6335) ft
 Left-Zone Right Coordinate: (239, 2,016.8421) ft
 Left-Zone Increment: 20
 Right Projection: Range
 Right-Zone Left Coordinate: (278.8077, 2,035) ft
 Right-Zone Right Coordinate: (711.9752, 2,122.4976) ft
 Right-Zone Increment: 20
 Radius Increments: 20

Slip Surface Limits

Left Coordinate: (-200, 1,891) ft
 Right Coordinate: (810.0186, 2,043.084) ft

file:///P:/FINAL%20PROJECTS/PARDEE/Skyline%20Ranch/SLOPE%20RESULTS/Sect... 3/19/2016

Seismic Coefficients

Horz Seismic Coef.: 0
Vert Seismic Coef.: 0

Anisotropic Strength Functions

17 degrees A-Bed 5-17°

Model: Spline Data Point Function
Function: Modifier Factor vs. Inclination
Curve Fit to Data: 100 %
Segment Curvature: 0 %
Y-Intercept: 1
Data Points: Inclination (°), Modifier Factor
Data Point: (-90, 1)
Data Point: (4.9, 1)
Data Point: (5, 0.425)
Data Point: (17, 0.425)
Data Point: (17.1, 1)

150 psf A-Bed 4-8° (Tmc)

Model: Spline Data Point Function
Function: Modifier Factor vs. Inclination
Curve Fit to Data: 100 %
Segment Curvature: 0 %
Y-Intercept: 1
Data Points: Inclination (°), Modifier Factor
Data Point: (-90, 1)
Data Point: (3.9, 1)
Data Point: (4, 0.75)
Data Point: (8, 0.75)
Data Point: (8.1, 1)

11 degrees A-Bed 13-17°

Model: Spline Data Point Function
Function: Modifier Factor vs. Inclination
Curve Fit to Data: 100 %
Segment Curvature: 0 %
Y-Intercept: 1
Data Points: Inclination (°), Modifier Factor
Data Point: (-90, 1)
Data Point: (12.9, 1)
Data Point: (13, 0.275)
Data Point: (17, 0.275)
Data Point: (17.1, 1)

150 psf A-Bed 13-17°

Model: Spline Data Point Function
Function: Modifier Factor vs. Inclination
Curve Fit to Data: 100 %
Segment Curvature: 0 %
Y-Intercept: 1
Data Points: Inclination (°), Modifier Factor
Data Point: (-90, 1)

Data Point: (12.9, 1)
Data Point: (13, 0.667)
Data Point: (17, 0.667)
Data Point: (17.1, 1)

17 degrees A-Bed 4-8° (Tmc)

Model: Spline Data Point Function
Function: Modifier Factor vs. Inclination
Curve Fit to Data: 100 %
Segment Curvature: 0 %
Y-Intercept: 1
Data Points: Inclination (°), Modifier Factor
Data Point: (-90, 1)
Data Point: (3.9, 1)
Data Point: (4, 0.425)
Data Point: (8, 0.425)
Data Point: (8.1, 1)

Points

	X (ft)	Y (ft)
Point 1	-199	1,945
Point 2	-60	1,952
Point 3	-8	1,953
Point 4	50	1,956
Point 5	91	1,958
Point 6	145	1,986
Point 7	155	1,986
Point 8	206	2,010
Point 9	224	2,010
Point 10	281	2,036
Point 11	291	2,036
Point 12	347	2,057
Point 13	356	2,059
Point 14	408	2,083
Point 15	420	2,083
Point 16	454	2,097
Point 17	482	2,096
Point 18	810	2,134
Point 19	810	2,130
Point 20	810	1,998
Point 21	810	1,801
Point 22	-200	1,891
Point 23	499	1,965
Point 24	-200	1,800
Point 25	89.9947	1,921.9873
Point 26	490.0406	2,009.3202
Point 27	810.0186	2,043.084
Point 28	113	1,969.4074
Point 29	60	1,956.4878
Point 30	91	1,928

Point 31	191	1,928
Point 32	149.5	1,928
Point 33	198.129	1,930.307
Point 34	398.5487	1,997.0656
Point 35	532	2,096
Point 36	582.4244	2,110.0118
Point 37	632.8615	2,116.9809
Point 38	674.6211	2,119.9729
Point 39	749	2,125
Point 40	759	2,129
Point 41	810	2,151

Regions

	Material	Points	Area (ft²)
Region 1	TQs (150 psf 17° A-Bed 5-17")	18,34,26,27,19	18,289
Region 2	Tmc (150 psf 17° A-Bed 4-8")	20,23,33,31,32,22,24,21	1.4487e+005
Region 3	Fill	29,30,32,31,33,34,18,41,40,39,38,37,36,35,17,16,15,14,13,12,11,10,9,8,7,6,28,5	40,344
Region 4	TQs (150 psf 11° A-Bed 13-17")	26,34,33,23,20,27	22,901
Region 5	TQs (150 psf 11° A-Bed 13-17")	4,3,2,1,22,32,30,29	12,840

Current Slip Surface

Slip Surface: 194
 F of S: 2.06
 Volume: 10,364.018 ft³
 Weight: 1,243,682.1 lbs
 Resisting Moment: 5.37939e+008 lbs-ft
 Activating Moment: 2.6067294e+008 lbs-ft
 F of S Rank (Analysis): 1 of 9,261 slip surfaces
 F of S Rank (Query): 1 of 10 slip surfaces
 Exit: (96.078899, 1,960.6335) ft
 Entry: (468.13688, 2,096.4951) ft
 Radius: 631.47933 ft
 Center: (76.432745, 2,591.8071) ft

Slip Slices

	X (ft)	Y (ft)	PWP (psf)	Base Normal Stress (psf)	Frictional Strength (psf)	Cohesive Strength (psf)
Slice 1	104.53945	1,961.0105	0	470.29476	305.41299	200

Slice 2	118.33333	1,961.7421	0	1,219.7448	792.11152	200
Slice 3	129	1,962.5424	0	1,764.9248	1,146.1555	200
Slice 4	139.66667	1,963.5247	0	2,283.2049	1,482.7306	200
Slice 5	150	1,964.648	0	2,460.1684	1,597.652	200
Slice 6	161.375	1,966.0999	0	2,622.9322	1,703.3521	200
Slice 7	174.125	1,967.9636	0	3,077.6916	1,998.6763	200
Slice 8	186.875	1,970.0944	0	3,496.2271	2,270.4764	200
Slice 9	199.625	1,972.495	0	3,878.7919	2,518.9169	200
Slice 10	215	1,975.7875	0	3,814.0161	2,476.851	200
Slice 11	229.7	1,979.2382	0	3,689.0343	2,395.6869	200
Slice 12	241.1	1,982.204	0	3,913.0786	2,541.183	200
Slice 13	252.5	1,985.3987	0	4,109.0028	2,668.4176	200
Slice 14	263.9	1,988.8258	0	4,276.8074	2,777.3912	200
Slice 15	275.3	1,992.4893	0	4,416.4619	2,868.0839	200
Slice 16	286	1,996.1398	0	4,276.2159	2,777.007	200
Slice 17	296.6	1,999.9822	0	4,062.9669	2,638.5216	200
Slice 18	307.8	2,004.2707	0	4,026.887	2,615.091	200
Slice 19	319	2,008.8059	0	3,964.4719	2,574.5581	200
Slice 20	330.2	2,013.5936	0	3,875.5695	2,516.8242	200
Slice 21	341.4	2,018.6401	0	3,759.9991	2,441.772	200
Slice 22	351.5	2,023.4066	0	3,562.3993	2,313.4491	200
Slice 23	362.5	2,028.8875	0	3,383.727	2,197.418	200
Slice 24	375.5	2,035.6863	0	3,272.3663	2,125.0995	200
Slice 25	388.5	2,042.877	0	3,121.797	2,027.3187	200
Slice 26	401.5	2,050.4755	0	2,931.4212	1,903.6872	200
Slice 27	414	2,058.1742	0	2,433.8469	1,580.5586	200
Slice 28	425.66667	2,065.7315	0	1,892.9113	1,229.271	200
Slice 29	437	2,073.4349	0	1,575.8757	1,023.3856	200
Slice 30	448.33333	2,081.5063	0	1,227.4638	797.12432	200
Slice 31	461.06844	2,091.0656	0	489.3096	317.76137	200

Section 3 SSA A for Skyline Ranch Development project.gsz

Section 3 SSA A for Skyline Ranch Development project.gsz Run By: Dr. Alexander Bykovtsev, Ph.D., P.E. 3/19/2016 4:54:49 PM

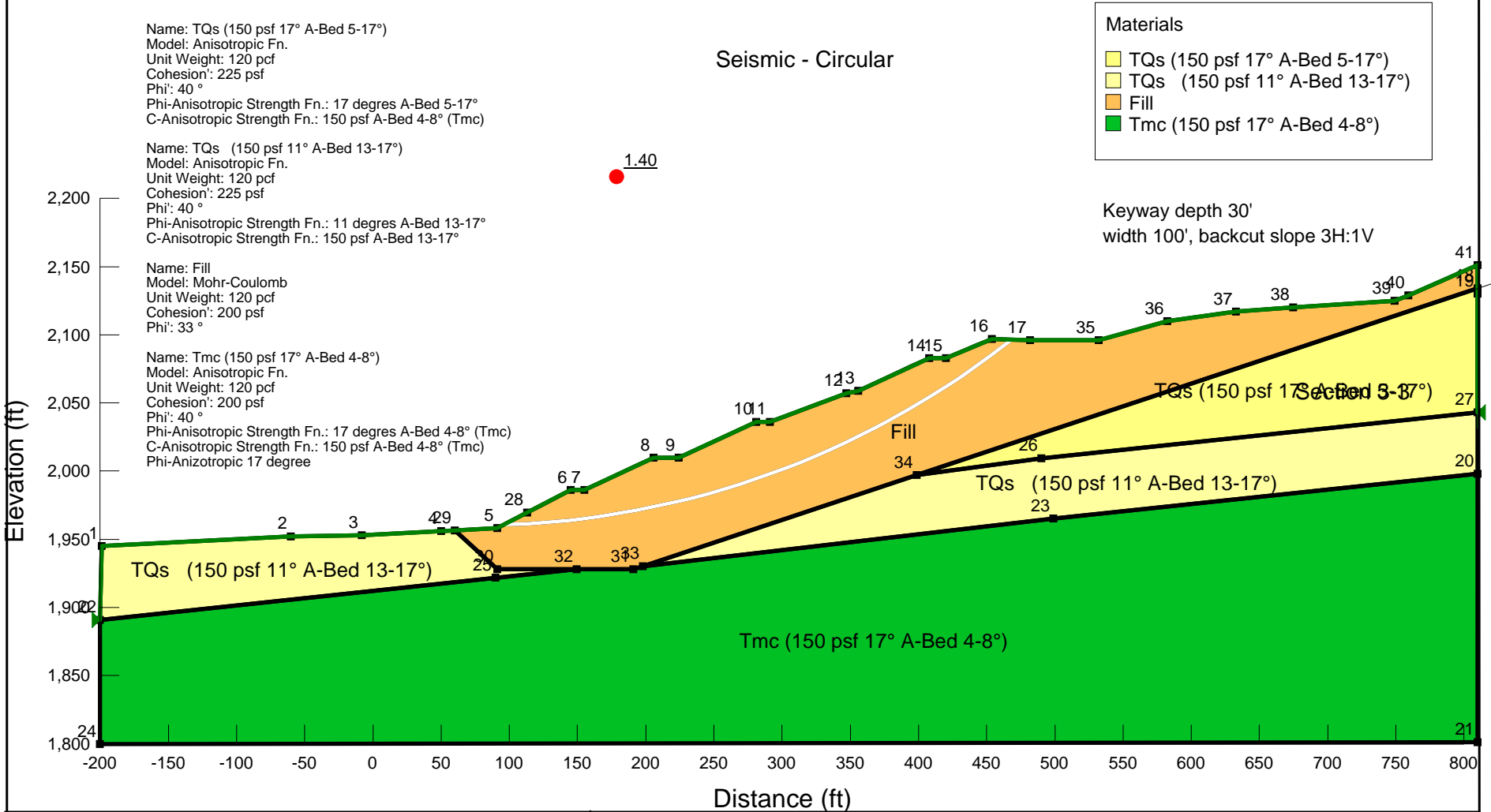

	<p>LGC Valley, Inc GEOTECHNICAL CONSULTING 28532 Constellation Road, Valencia, CA 91355 Phone 661-702-8474, Fax 661-702-8475</p>	<p>Skyline Ranch Development project, Tract 60922 Los Angeles CA</p>	<p>Project No: 153035-01 Engineer: BAS Date: March 2016</p>
--	--	---	--

1 - Circular Mode of Failure Seismic

Report generated using GeoStudio 2012. Copyright © 1991-2016 GEO-SLOPE International Ltd.

File Information

File Version: 8.15
 Title: Static Slope Stability Analyses for Skyline Ranch Development project, Tract 60922, Los Angeles CA
 Comments: Run By: Dr. Alexander Bykovtsev, Ph.D., P.E.
 Last Edited By: Alexander Bykovtsec
 Revision Number: 87
 Date: 3/19/2016
 Time: 4:54:49 PM
 Tool Version: 8.15.5.11777
 File Name: Section 3 SSA A for Skyline Ranch Development project.gsz
 Directory: P:\FINAL PROJECTS\PARDEE\Skyline Ranch\SLOPE RESULTS\Section 3-3 results\Latest update 3-19-16\
 Last Solved Date: 3/19/2016
 Last Solved Time: 5:02:01 PM

Project Settings

Length(L) Units: Feet
 Time(t) Units: Seconds
 Force(F) Units: Pounds
 Pressure(p) Units: psf
 Strength Units: psf
 Unit Weight of Water: 62.4 pcf
 View: 2D
 Element Thickness: 1

Analysis Settings

1 - Circular Mode of Failure Seismic

Kind: SLOPE/W
 Parent: 1 - Circular Mode of Failure
 Method: Bishop
 Settings
 PWP Conditions Source: (none)
 Initial Slip Surface Source: Parent Analysis
 Slip Surface
 Direction of movement: Right to Left
 Use Passive Mode: No
 Slip Surface Option: Critical Slip Surfaces from Other
 Critical slip surfaces saved: 1
 Resisting Side Maximum Convex Angle: 1 °
 Driving Side Maximum Convex Angle: 5 °
 Optimize Critical Slip Surface Location: No
 Tension Crack
 Tension Crack Option: (none)
 F of S Distribution
 F of S Calculation Option: Constant
 Advanced
 Number of Slices: 30
 F of S Tolerance: 0.01

file:///P:/FINAL%20PROJECTS/PARDEE/Skyline%20Ranch/SLOPE%20RESULTS/Sect... 3/19/2016

Minimum Slip Surface Depth: 0.1 ft

Materials

TQs (150 psf 17° A-Bed 5-17°)

Model: Anisotropic Fn.
 Unit Weight: 120 pcf
 Cohesion': 225 psf
 Phi': 40 °
 Phi-Anisotropic Strength Fn.: 17 degrees A-Bed 5-17°
 C-Anisotropic Strength Fn.: 150 psf A-Bed 4-8° (Tmc)
 Phi-B: 0 °

TQs (150 psf 11° A-Bed 13-17°)

Model: Anisotropic Fn.
 Unit Weight: 120 pcf
 Cohesion': 225 psf
 Phi': 40 °
 Phi-Anisotropic Strength Fn.: 11 degrees A-Bed 13-17°
 C-Anisotropic Strength Fn.: 150 psf A-Bed 13-17°
 Phi-B: 0 °

Fill

Model: Mohr-Coulomb
 Unit Weight: 120 pcf
 Cohesion': 200 psf
 Phi': 33 °
 Phi-B: 0 °

Tmc (150 psf 17° A-Bed 4-8°)

Model: Anisotropic Fn.
 Unit Weight: 120 pcf
 Cohesion': 200 psf
 Phi': 40 °
 Phi-Anisotropic Strength Fn.: 17 degrees A-Bed 4-8° (Tmc)
 C-Anisotropic Strength Fn.: 150 psf A-Bed 4-8° (Tmc)
 Phi-B: 0 °

Slip Surface Limits

Left Coordinate: (-200, 1,891) ft
 Right Coordinate: (810.0186, 2,043.084) ft

Seismic Coefficients

Horz Seismic Coef.: 0.15
 Vert Seismic Coef.: 0

Anisotropic Strength Functions

17 degrees A-Bed 5-17°

Model: Spline Data Point Function
 Function: Modifier Factor vs. Inclination

file:///P:/FINAL%20PROJECTS/PARDEE/Skyline%20Ranch/SLOPE%20RESULTS/Sect... 3/19/2016

Curve Fit to Data: 100 %
 Segment Curvature: 0 %
 Y-Intercept: 1
 Data Points: Inclination (*), Modifier Factor
 Data Point: (-90, 1)
 Data Point: (4.9, 1)
 Data Point: (5, 0.425)
 Data Point: (17, 0.425)
 Data Point: (17.1, 1)

150 psf A-Bed 4-8° (Tmc)

Model: Spline Data Point Function
 Function: Modifier Factor vs. Inclination
 Curve Fit to Data: 100 %
 Segment Curvature: 0 %
 Y-Intercept: 1
 Data Points: Inclination (*), Modifier Factor
 Data Point: (-90, 1)
 Data Point: (3.9, 1)
 Data Point: (4, 0.75)
 Data Point: (8, 0.75)
 Data Point: (8.1, 1)

11 degrees A-Bed 13-17°

Model: Spline Data Point Function
 Function: Modifier Factor vs. Inclination
 Curve Fit to Data: 100 %
 Segment Curvature: 0 %
 Y-Intercept: 1
 Data Points: Inclination (*), Modifier Factor
 Data Point: (-90, 1)
 Data Point: (12.9, 1)
 Data Point: (13, 0.275)
 Data Point: (17, 0.275)
 Data Point: (17.1, 1)

150 psf A-Bed 13-17°

Model: Spline Data Point Function
 Function: Modifier Factor vs. Inclination
 Curve Fit to Data: 100 %
 Segment Curvature: 0 %
 Y-Intercept: 1
 Data Points: Inclination (*), Modifier Factor
 Data Point: (-90, 1)
 Data Point: (12.9, 1)
 Data Point: (13, 0.667)
 Data Point: (17, 0.667)
 Data Point: (17.1, 1)

17 degrees A-Bed 4-8° (Tmc)

Model: Spline Data Point Function
 Function: Modifier Factor vs. Inclination
 Curve Fit to Data: 100 %
 Segment Curvature: 0 %
 Y-Intercept: 1
 Data Points: Inclination (*), Modifier Factor
 Data Point: (-90, 1)

Data Point: (3.9, 1)
 Data Point: (4, 0.425)
 Data Point: (8, 0.425)
 Data Point: (8.1, 1)

Points

	X (ft)	Y (ft)
Point 1	-199	1,945
Point 2	-60	1,952
Point 3	-8	1,953
Point 4	50	1,956
Point 5	91	1,958
Point 6	145	1,986
Point 7	155	1,986
Point 8	206	2,010
Point 9	224	2,010
Point 10	281	2,036
Point 11	291	2,036
Point 12	347	2,057
Point 13	356	2,059
Point 14	408	2,083
Point 15	420	2,083
Point 16	454	2,097
Point 17	482	2,096
Point 18	810	2,134
Point 19	810	2,130
Point 20	810	1,998
Point 21	810	1,801
Point 22	-200	1,891
Point 23	499	1,965
Point 24	-200	1,800
Point 25	89.9947	1,921.9873
Point 26	490.0406	2,009.3202
Point 27	810.0186	2,043.084
Point 28	113	1,969.4074
Point 29	60	1,956.4878
Point 30	91	1,928
Point 31	191	1,928
Point 32	149.5	1,928
Point 33	198.129	1,930.307
Point 34	398.5487	1,997.0656
Point 35	532	2,096
Point 36	582.4244	2,110.0118
Point 37	632.8615	2,116.9809
Point 38	674.6211	2,119.9729
Point 39	749	2,125
Point 40	759	2,129
Point 41	810	2,151

Regions

	Material	Points	Area (ft ²)
Region 1	TQs (150 psf 17° A-Bed 5-17°)	18,34,26,27,19	18,289
Region 2	Tmc (150 psf 17° A-Bed 4-8°)	20,23,33,31,32,22,24,21	1.4487e+005
Region 3	Fill	29,30,32,31,33,34,18,41,40,39,38,37,36,35,17,16,15,14,13,12,11,10,9,8,7,6,28,5	40,344
Region 4	TQs (150 psf 11° A-Bed 13-17°)	26,34,33,23,20,27	22,901
Region 5	TQs (150 psf 11° A-Bed 13-17°)	4,3,2,1,22,32,30,29	12,840

Current Slip Surface

Slip Surface: 1
 F of S: 1.40
 Volume: 10,364.018 ft³
 Weight: 1,243,682.1 lbs
 Resisting Moment: 5.1344587e+008 lbs-ft
 Activating Moment: 3.674462e+008 lbs-ft
 F of S Rank (Analysis): 1 of 1 slip surfaces
 F of S Rank (Query): 1 of 1 slip surfaces
 Exit: (96.078899, 1,960.6335) ft
 Entry: (468.13688, 2,096.4951) ft
 Radius: 631.47933 ft
 Center: (76.432745, 2,591.8071) ft

Slip Slices

	X (ft)	Y (ft)	PWP (psf)	Base Normal Stress (psf)	Frictional Strength (psf)	Cohesive Strength (psf)
Slice 1	104.53945	1,961.0105	0	465.2146	302.1139	200
Slice 2	118.33333	1,961.7421	0	1,205.0082	782.54146	200
Slice 3	129	1,962.5424	0	1,739.9983	1,129.9681	200
Slice 4	139.66667	1,963.5247	0	2,245.9495	1,458.5367	200
Slice 5	150	1,964.648	0	2,414.1218	1,567.749	200
Slice 6	161.375	1,966.0999	0	2,566.9636	1,667.0056	200
Slice 7	174.125	1,967.9636	0	3,003.7843	1,950.6803	200
Slice 8	186.875	1,970.0944	0	3,402.8733	2,209.8518	200
Slice 9	199.625	1,972.495	0	3,764.7843	2,444.8795	200
Slice 10	215	1,975.7875	0	3,688.4764	2,395.3246	200
Slice 11	229.7	1,979.2382	0	3,555.0502	2,308.6766	200

Slice 12	241.1	1,982.204	0	3,761.5749	2,442.7953	200
Slice 13	252.5	1,985.3987	0	3,940.0069	2,558.6704	200
Slice 14	263.9	1,988.8258	0	4,090.5374	2,656.4261	200
Slice 15	275.3	1,992.4893	0	4,213.324	2,736.1646	200
Slice 16	286	1,996.1398	0	4,068.8967	2,642.3724	200
Slice 17	296.6	1,999.9822	0	3,855.6149	2,503.8656	200
Slice 18	307.8	2,004.2707	0	3,811.0677	2,474.9363	200
Slice 19	319	2,008.8059	0	3,741.6749	2,429.8721	200
Slice 20	330.2	2,013.5936	0	3,647.4692	2,368.6942	200
Slice 21	341.4	2,018.6401	0	3,528.4607	2,291.4092	200
Slice 22	351.5	2,023.4066	0	3,333.6839	2,164.9196	200
Slice 23	362.5	2,028.8875	0	3,156.7226	2,049.9996	200
Slice 24	375.5	2,035.6863	0	3,041.9503	1,975.4656	200
Slice 25	388.5	2,042.877	0	2,891.0912	1,877.4966	200
Slice 26	401.5	2,050.4755	0	2,703.9297	1,755.9525	200
Slice 27	414	2,058.1742	0	2,233.3438	1,450.3504	200
Slice 28	425.66667	2,065.7315	0	1,725.884	1,120.8022	200
Slice 29	437	2,073.4349	0	1,427.7424	927.18675	200
Slice 30	448.33333	2,081.5063	0	1,102.4191	715.91934	200
Slice 31	461.06844	2,091.0656	0	421.7951	273.91694	200

Section 3 SSA A for Skyline Ranch Development project.gsz

Section 3 SSA A for Skyline Ranch Development project.gsz Run By: Dr. Alexander Bykovtsev, Ph.D., P.E. 3/19/2016 4:54:49 PM

Name: TQs (150 psf 17° A-Bed 5-17°)
 Model: Anisotropic Fn.
 Unit Weight: 120 pcf
 Cohesion: 225 psf
 Phi: 40°
 Phi-Anisotropic Strength Fn.: 17 degrees A-Bed 5-17°
 C-Anisotropic Strength Fn.: 150 psf A-Bed 4-8° (Tmc)

Name: TQs (150 psf 11° A-Bed 13-17°)
 Model: Anisotropic Fn.
 Unit Weight: 120 pcf
 Cohesion: 225 psf
 Phi: 40°
 Phi-Anisotropic Strength Fn.: 11 degrees A-Bed 13-17°
 C-Anisotropic Strength Fn.: 150 psf A-Bed 13-17°

Name: Fill
 Model: Mohr-Coulomb
 Unit Weight: 120 pcf
 Cohesion: 200 psf
 Phi: 33°

Name: Tmc (150 psf 17° A-Bed 4-8°)
 Model: Anisotropic Fn.
 Unit Weight: 120 pcf
 Cohesion: 200 psf
 Phi: 40°
 Phi-Anisotropic Strength Fn.: 17 degrees A-Bed 4-8° (Tmc)
 C-Anisotropic Strength Fn.: 150 psf A-Bed 4-8° (Tmc)
 Phi-Anisotropic 17 degree

Static - Translational

Materials

- TQs (150 psf 17° A-Bed 5-17°)
- TQs (150 psf 11° A-Bed 13-17°)
- Fill
- Tmc (150 psf 17° A-Bed 4-8°)

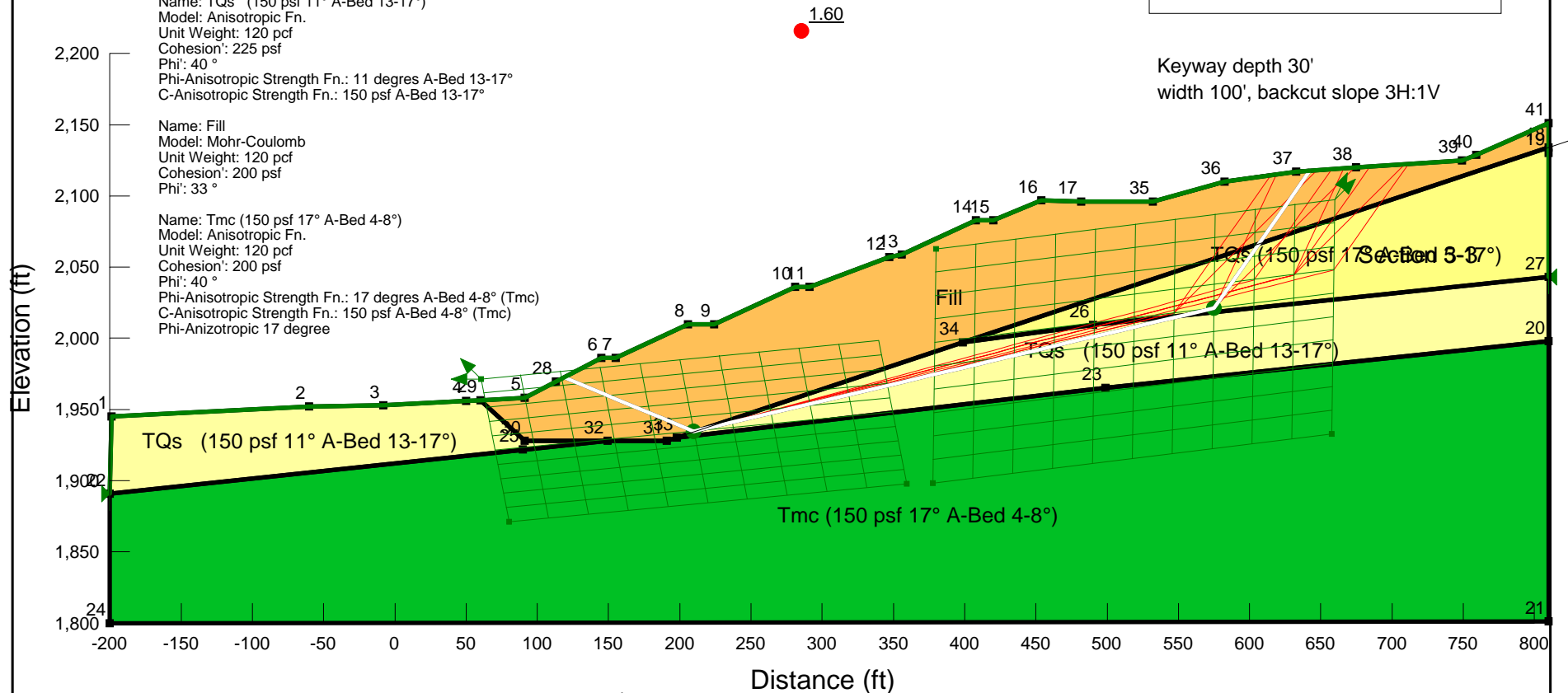

LGC Valley, Inc
 GEOTECHNICAL CONSULTING
 28532 Constellation Road, Valencia, CA 91355
 Phone 661-702-8474, Fax 661-702-8475

**Skyline Ranch
 Development project, Tract 60922
 Los Angeles CA**

Project No: **153035-01**
 Engineer: **BAS**
 Date: **March 2016**

2 - Translational

Report generated using GeoStudio 2012. Copyright © 1991-2016 GEO-SLOPE International Ltd.

File Information

File Version: 8.15
 Title: Static Slope Stability Analyses for Skyline Ranch Development project, Tract 60922, Los Angeles CA
 Comments: Run By: Dr. Alexander Bykovtsev, Ph.D., P.E.
 Last Edited By: Alexander Bykovtsev
 Revision Number: 87
 Date: 3/19/2016
 Time: 4:54:49 PM
 Tool Version: 8.15.5.11777
 File Name: Section 3 SSA A for Skyline Ranch Development project.gsz
 Directory: P:\FINAL PROJECTS\PARDEE\Skyline Ranch\SLOPE RESULTS\Section 3-3 results\Latest update 3-19-16\
 Last Solved Date: 3/19/2016
 Last Solved Time: 4:58:31 PM

Project Settings

Length(L) Units: Feet
 Time(t) Units: Seconds
 Force(F) Units: Pounds
 Pressure(p) Units: psf
 Strength Units: psf
 Unit Weight of Water: 62.4 pcf
 View: 2D
 Element Thickness: 1

Analysis Settings

2 - Translational

Kind: [SLOPE/W](#)
 Method: [Spencer](#)
 Settings
 PWP Conditions Source: [\(none\)](#)
 Slip Surface
 Direction of movement: [Right to Left](#)
 Use Passive Mode: [No](#)
 Slip Surface Option: [Block](#)
 Critical slip surfaces saved: [1](#)
 Resisting Side Maximum Convex Angle: [1 °](#)
 Driving Side Maximum Convex Angle: [5 °](#)
 Restrict Block Crossing: [No](#)
 Optimize Critical Slip Surface Location: [No](#)
 Tension Crack
 Tension Crack Option: [\(none\)](#)
 F of S Distribution
 F of S Calculation Option: [Constant](#)
 Advanced
 Number of Slices: [30](#)
 F of S Tolerance: [0.01](#)
 Minimum Slip Surface Depth: [0.1 ft](#)

file:///P:/FINAL%20PROJECTS/PARDEE/Skyline%20Ranch/SLOPE%20RESULTS/Sect... 3/19/2016

Search Method: [Root Finder](#)
 Tolerable difference between starting and converged F of S: [3](#)
 Maximum iterations to calculate converged lambda: [20](#)
 Max Absolute Lambda: [2](#)

Materials

TQs (150 psf 17° A-Bed 5-17°)

Model: [Anisotropic Fn.](#)
 Unit Weight: [120 pcf](#)
 Cohesion: [225 psf](#)
 Phi: [40 °](#)
 Phi-Anisotropic Strength Fn.: [17 degrees A-Bed 5-17°](#)
 C-Anisotropic Strength Fn.: [150 psf A-Bed 4-8° \(Tmc\)](#)
 Phi-B: [0 °](#)

TQs (150 psf 11° A-Bed 13-17°)

Model: [Anisotropic Fn.](#)
 Unit Weight: [120 pcf](#)
 Cohesion: [225 psf](#)
 Phi: [40 °](#)
 Phi-Anisotropic Strength Fn.: [11 degrees A-Bed 13-17°](#)
 C-Anisotropic Strength Fn.: [150 psf A-Bed 13-17°](#)
 Phi-B: [0 °](#)

Fill

Model: [Mohr-Coulomb](#)
 Unit Weight: [120 pcf](#)
 Cohesion: [200 psf](#)
 Phi: [33 °](#)
 Phi-B: [0 °](#)

Tmc (150 psf 17° A-Bed 4-8°)

Model: [Anisotropic Fn.](#)
 Unit Weight: [120 pcf](#)
 Cohesion: [200 psf](#)
 Phi: [40 °](#)
 Phi-Anisotropic Strength Fn.: [17 degrees A-Bed 4-8° \(Tmc\)](#)
 C-Anisotropic Strength Fn.: [150 psf A-Bed 4-8° \(Tmc\)](#)
 Phi-B: [0 °](#)

Slip Surface Limits

Left Coordinate: [\(-200, 1,891\) ft](#)
 Right Coordinate: [\(810.0186, 2,043.084\) ft](#)

Slip Surface Block

Left Grid
 Upper Left: [\(60.7191, 1,971.3745\) ft](#)
 Lower Left: [\(80.0568, 1,871.0374\) ft](#)
 Lower Right: [\(359.1763, 1,898.0372\) ft](#)
 X Increments: [10](#)
 Y Increments: [10](#)

file:///P:/FINAL%20PROJECTS/PARDEE/Skyline%20Ranch/SLOPE%20RESULTS/Sect... 3/19/2016

Starting Angle: 135 °
 Ending Angle: 180 °
 Angle Increments: 2

Right Grid

Upper Left: (379.9024, 2,062.6097) ft
 Lower Left: (377.6595, 1,898.3154) ft
 Lower Right: (657.6469, 1,932.9766) ft
 X Increments: 10
 Y Increments: 10
 Starting Angle: 45 °
 Ending Angle: 65 °
 Angle Increments: 2

Seismic Coefficients

Horz Seismic Coef.: 0
 Vert Seismic Coef.: 0

Anisotropic Strength Functions

17 degrees A-Bed 5-17°

Model: Spline Data Point Function
 Function: Modifier Factor vs. Inclination
 Curve Fit to Data: 100 %
 Segment Curvature: 0 %

Y-Intercept: 1

Data Points: Inclination (°), Modifier Factor

Data Point: (-90, 1)
 Data Point: (4.9, 1)
 Data Point: (5, 0.425)
 Data Point: (17, 0.425)
 Data Point: (17.1, 1)

150 psf A-Bed 4-8° (Tmc)

Model: Spline Data Point Function
 Function: Modifier Factor vs. Inclination
 Curve Fit to Data: 100 %
 Segment Curvature: 0 %

Y-Intercept: 1

Data Points: Inclination (°), Modifier Factor

Data Point: (-90, 1)
 Data Point: (3.9, 1)
 Data Point: (4, 0.75)
 Data Point: (8, 0.75)
 Data Point: (8.1, 1)

11 degrees A-Bed 13-17°

Model: Spline Data Point Function
 Function: Modifier Factor vs. Inclination
 Curve Fit to Data: 100 %
 Segment Curvature: 0 %

Y-Intercept: 1

Data Points: Inclination (°), Modifier Factor

Data Point: (-90, 1)
 Data Point: (12.9, 1)

Data Point: (13, 0.275)
 Data Point: (17, 0.275)
 Data Point: (17.1, 1)

150 psf A-Bed 13-17°

Model: Spline Data Point Function
 Function: Modifier Factor vs. Inclination
 Curve Fit to Data: 100 %
 Segment Curvature: 0 %

Y-Intercept: 1

Data Points: Inclination (°), Modifier Factor

Data Point: (-90, 1)
 Data Point: (12.9, 1)
 Data Point: (13, 0.667)
 Data Point: (17, 0.667)
 Data Point: (17.1, 1)

17 degrees A-Bed 4-8° (Tmc)

Model: Spline Data Point Function
 Function: Modifier Factor vs. Inclination
 Curve Fit to Data: 100 %
 Segment Curvature: 0 %

Y-Intercept: 1

Data Points: Inclination (°), Modifier Factor

Data Point: (-90, 1)
 Data Point: (3.9, 1)
 Data Point: (4, 0.425)
 Data Point: (8, 0.425)
 Data Point: (8.1, 1)

Points

	X (ft)	Y (ft)
Point 1	-199	1,945
Point 2	-60	1,952
Point 3	-8	1,953
Point 4	50	1,956
Point 5	91	1,958
Point 6	145	1,986
Point 7	155	1,986
Point 8	206	2,010
Point 9	224	2,010
Point 10	281	2,036
Point 11	291	2,036
Point 12	347	2,057
Point 13	356	2,059
Point 14	408	2,083
Point 15	420	2,083
Point 16	454	2,097
Point 17	482	2,096
Point 18	810	2,134
Point 19	810	2,130
Point 20	810	1,998

Point 21	810	1,801
Point 22	-200	1,891
Point 23	499	1,965
Point 24	-200	1,800
Point 25	89.9947	1,921.9873
Point 26	490.0406	2,009.3202
Point 27	810.0186	2,043.084
Point 28	113	1,969.4074
Point 29	60	1,956.4878
Point 30	91	1,928
Point 31	191	1,928
Point 32	149.5	1,928
Point 33	198.129	1,930.307
Point 34	398.5487	1,997.0656
Point 35	532	2,096
Point 36	582.4244	2,110.0118
Point 37	632.8615	2,116.9809
Point 38	674.6211	2,119.9729
Point 39	749	2,125
Point 40	759	2,129
Point 41	810	2,151

Regions

	Material	Points	Area (ft ²)
Region 1	TQs (150 psf 17° A-Bed 5-17°)	18,34,26,27,19	18,289
Region 2	Tmc (150 psf 17° A-Bed 4-8°)	20,23,33,31,32,22,24,21	1.4487e+005
Region 3	Fill	29,30,32,31,33,34,18,41,40,39,38,37,36,35,17,16,15,14,13,12,11,10,9,8,7,6,28,5	40,344
Region 4	TQs (150 psf 11° A-Bed 13-17°)	26,34,33,23,20,27	22,901
Region 5	TQs (150 psf 11° A-Bed 13-17°)	4,3,2,1,22,32,30,29	12,840

Current Slip Surface

Slip Surface: 65,924
 F of S: 1.60
 Volume: 39,094.946 ft³
 Weight: 4,691,393.5 lbs
 Resisting Moment: 3.4365662e+008 lbs-ft
 Activating Moment: 2.1520809e+008 lbs-ft

Resisting Force: 1,409,139.8 lbs
 Activating Force: 883,337.85 lbs
 F of S Rank (Analysis): 1 of 131,769 slip surfaces
 F of S Rank (Query): 1 of 10 slip surfaces
 Exit: (118.84895, 1,972.4402) ft
 Entry: (642.58224, 2,117.6774) ft
 Radius: 256.67241 ft
 Center: (350.50865, 2,153.9867) ft

Slip Slices

	X (ft)	Y (ft)	PWP (psf)	Base Normal Stress (psf)	Frictional Strength (psf)	Cohesive Strength (psf)
Slice 1	131.92447	1,967.0241	0	2,285.5682	1,484.2653	200
Slice 2	150	1,959.537	0	4,827.114	3,134.7645	200
Slice 3	163.5	1,953.9451	0	6,535.8231	4,244.4132	200
Slice 4	180.5	1,946.9035	0	9,215.3566	5,984.5225	200
Slice 5	197.5	1,939.8619	0	11,894.89	7,724.6319	200
Slice 6	207.97385	1,935.5234	0	13,380.304	8,689.2711	200
Slice 7	212.34756	1,935.2742	0	8,424.9486	5,471.2256	200
Slice 8	219.37371	1,936.9381	0	8,338.7373	1,620.8863	150.075
Slice 9	233.5	1,940.2834	0	8,451.5563	1,642.8161	150.075
Slice 10	252.5	1,944.7829	0	8,927.396	1,735.31	150.075
Slice 11	271.5	1,949.2824	0	9,403.2357	1,827.8039	150.075
Slice 12	286	1,952.7162	0	9,505.9493	1,847.7694	150.075
Slice 13	300.33333	1,956.1105	0	9,518.0135	1,850.1144	150.075
Slice 14	319	1,960.5311	0	9,812.5547	1,907.3674	150.075
Slice 15	337.66667	1,964.9516	0	10,107.096	1,964.6204	150.075
Slice 16	351.5	1,968.2275	0	10,246.868	1,991.7894	150.075
Slice 17	366.63718	1,971.8122	0	10,512.326	2,043.3892	150.075
Slice 18	387.91152	1,976.8503	0	11,058.238	2,149.5038	150.075
Slice 19	403.27435	1,980.4885	0	11,452.458	2,226.1323	150.075
Slice 20	414	1,983.0285	0	11,411.473	2,218.1656	150.075
Slice 21	428.5	1,986.4623	0	11,419.03	2,219.6347	150.075
Slice 22	445.5	1,990.4881	0	11,758.64	2,285.6481	150.075
Slice 23	461	1,994.1588	0	11,710.61	2,276.3119	150.075
Slice 24	475	1,997.4742	0	11,274.938	2,191.626	150.075
Slice 25	486.0203	2,000.084	0	10,948.389	2,128.1512	150.075

Slice 26	500.53045	2,003.5202	0	10,556.016	2,051.8816	150.075
Slice 27	521.51015	2,008.4885	0	9,988.6981	1,941.6062	150.075
Slice 28	542.56809	2,013.4753	0	9,754.5912	1,896.1005	150.075
Slice 29	564.0663	2,018.5664	0	9,824.1554	3,003.5457	225
Slice 30	578.71041	2,026.4589	0	5,050.9362	4,238.2387	225
Slice 31	594.52014	2,049.0376	0	3,812.5537	3,199.1124	225
Slice 32	613.17728	2,075.6827	0	2,514.9824	1,633.2487	200
Slice 33	626.30009	2,094.4241	0	1,373.0777	891.68705	200
Slice 34	637.72187	2,110.736	0	357.38028	232.08547	200

Section 3 SSA A for Skyline Ranch Development project.gsz

Section 3 SSA A for Skyline Ranch Development project.gsz Run By: Dr. Alexander Bykovtsev, Ph.D., P.E. 3/19/2016 4:54:49 PM

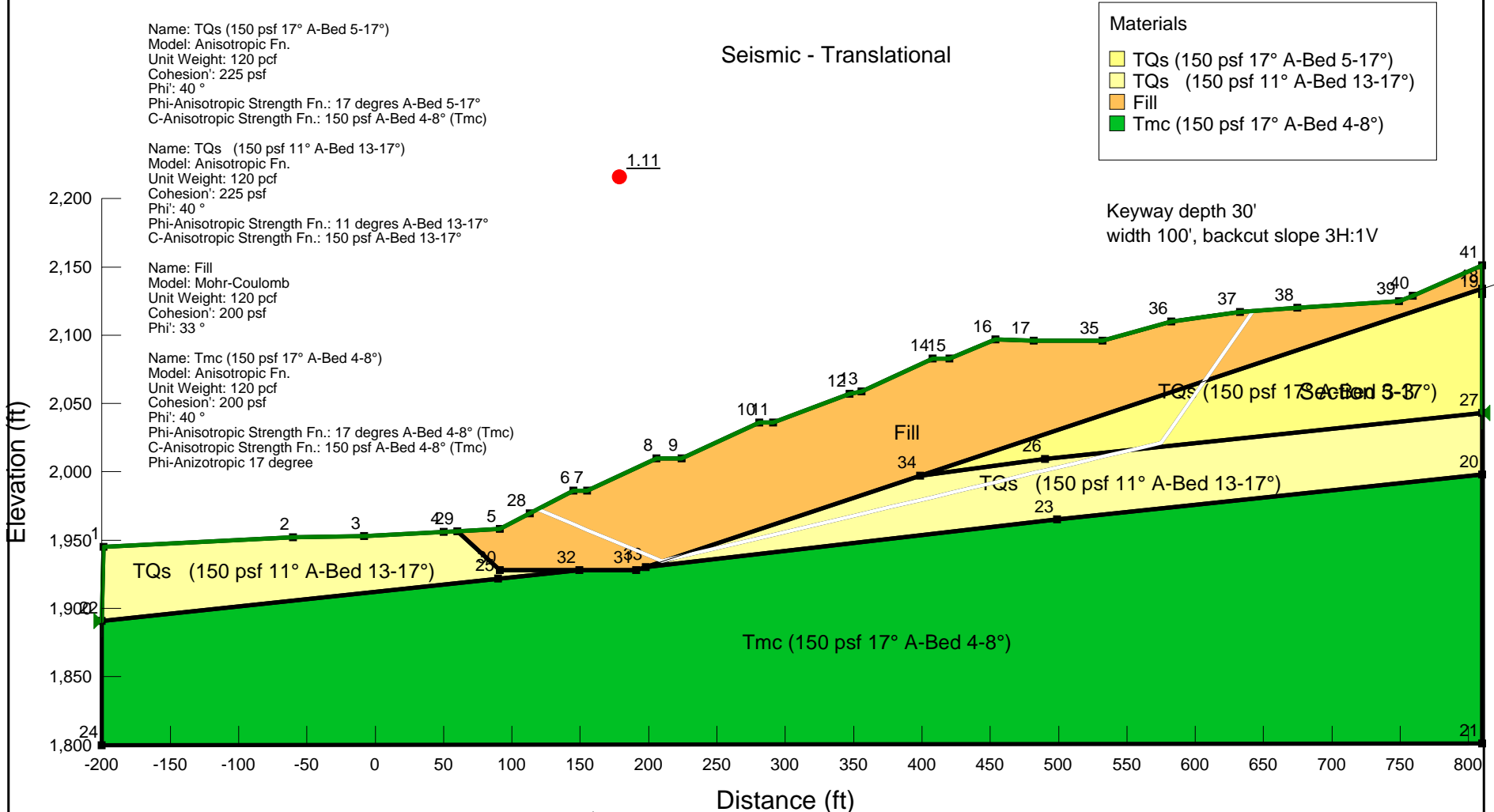

LGC Valley, Inc
 GEOTECHNICAL CONSULTING
 28532 Constellation Road, Valencia, CA 91355
 Phone 661-702-8474, Fax 661-702-8475

Skyline Ranch
 Development project, Tract 60922
 Los Angeles CA

Project No: **153035-01**
 Engineer: **BAS**
 Date: **March 2016**

2 - Translational Seismic

Report generated using GeoStudio 2012. Copyright © 1991-2016 GEO-SLOPE International Ltd.

File Information

File Version: 8.15
 Title: Static Slope Stability Analyses for Skyline Ranch Development project, Tract 60922, Los Angeles CA
 Comments: Run By: Dr. Alexander Bykovtsev, Ph.D., P.E.
 Last Edited By: Alexander Bykovtsev
 Revision Number: 87
 Date: 3/19/2016
 Time: 4:54:49 PM
 Tool Version: 8.15.5.11777
 File Name: Section 3 SSA A for Skyline Ranch Development project.gsz
 Directory: P:\FINAL PROJECTS\PARDEE\Skyline Ranch\SLOPE RESULTS\Section 3-3 results\Latest update 3-19-16\
 Last Solved Date: 3/19/2016
 Last Solved Time: 5:02:01 PM

Project Settings

Length(L) Units: Feet
 Time(t) Units: Seconds
 Force(F) Units: Pounds
 Pressure(p) Units: psf
 Strength Units: psf
 Unit Weight of Water: 62.4 pcf
 View: 2D
 Element Thickness: 1

Analysis Settings

2 - Translational Seismic

Kind: SLOPE/W
 Parent: 2 - Translational
 Method: Spencer
 Settings
 PWP Conditions Source: (none)
 Initial Slip Surface Source: Parent Analysis
 Slip Surface
 Direction of movement: Right to Left
 Use Passive Mode: No
 Slip Surface Option: Critical Slip Surfaces from Other
 Critical slip surfaces saved: 1
 Resisting Side Maximum Convex Angle: 1 °
 Driving Side Maximum Convex Angle: 5 °
 Optimize Critical Slip Surface Location: No
 Tension Crack
 Tension Crack Option: (none)
 F of S Distribution
 F of S Calculation Option: Constant
 Advanced
 Number of Slices: 30
 F of S Tolerance: 0.01

file:///P:/FINAL%20PROJECTS/PARDEE/Skyline%20Ranch/SLOPE%20RESULTS/Sect... 3/19/2016

Minimum Slip Surface Depth: 0.1 ft
 Search Method: Root Finder
 Tolerable difference between starting and converged F of S: 3
 Maximum iterations to calculate converged lambda: 20
 Max Absolute Lambda: 2

Materials

TQs (150 psf 17° A-Bed 5-17°)

Model: Anisotropic Fn.
 Unit Weight: 120 pcf
 Cohesion': 225 psf
 Phi': 40 °
 Phi-Anisotropic Strength Fn.: 17 degres A-Bed 5-17°
 C-Anisotropic Strength Fn.: 150 psf A-Bed 4-8° (Tmc)
 Phi-B: 0 °

TQs (150 psf 11° A-Bed 13-17°)

Model: Anisotropic Fn.
 Unit Weight: 120 pcf
 Cohesion': 225 psf
 Phi': 40 °
 Phi-Anisotropic Strength Fn.: 11 degres A-Bed 13-17°
 C-Anisotropic Strength Fn.: 150 psf A-Bed 13-17°
 Phi-B: 0 °

Fill

Model: Mohr-Coulomb
 Unit Weight: 120 pcf
 Cohesion': 200 psf
 Phi': 33 °
 Phi-B: 0 °

Tmc (150 psf 17° A-Bed 4-8°)

Model: Anisotropic Fn.
 Unit Weight: 120 pcf
 Cohesion': 200 psf
 Phi': 40 °
 Phi-Anisotropic Strength Fn.: 17 degres A-Bed 4-8° (Tmc)
 C-Anisotropic Strength Fn.: 150 psf A-Bed 4-8° (Tmc)
 Phi-B: 0 °

Slip Surface Limits

Left Coordinate: (-200, 1,891) ft
 Right Coordinate: (810.0186, 2,043.084) ft

Seismic Coefficients

Horz Seismic Coef.: 0.15
 Vert Seismic Coef.: 0

Anisotropic Strength Functions

file:///P:/FINAL%20PROJECTS/PARDEE/Skyline%20Ranch/SLOPE%20RESULTS/Sect... 3/19/2016

17 degrees A-Bed 5-17°

Model: Spline Data Point Function
 Function: Modifier Factor vs. Inclination
 Curve Fit to Data: 100 %
 Segment Curvature: 0 %
 Y-Intercept: 1
 Data Points: Inclination (*), Modifier Factor
 Data Point: (-90, 1)
 Data Point: (4.9, 1)
 Data Point: (5, 0.425)
 Data Point: (17, 0.425)
 Data Point: (17.1, 1)

150 psf A-Bed 4-8° (Tmc)

Model: Spline Data Point Function
 Function: Modifier Factor vs. Inclination
 Curve Fit to Data: 100 %
 Segment Curvature: 0 %
 Y-Intercept: 1
 Data Points: Inclination (*), Modifier Factor
 Data Point: (-90, 1)
 Data Point: (3.9, 1)
 Data Point: (4, 0.75)
 Data Point: (8, 0.75)
 Data Point: (8.1, 1)

11 degrees A-Bed 13-17°

Model: Spline Data Point Function
 Function: Modifier Factor vs. Inclination
 Curve Fit to Data: 100 %
 Segment Curvature: 0 %
 Y-Intercept: 1
 Data Points: Inclination (*), Modifier Factor
 Data Point: (-90, 1)
 Data Point: (12.9, 1)
 Data Point: (13, 0.275)
 Data Point: (17, 0.275)
 Data Point: (17.1, 1)

150 psf A-Bed 13-17°

Model: Spline Data Point Function
 Function: Modifier Factor vs. Inclination
 Curve Fit to Data: 100 %
 Segment Curvature: 0 %
 Y-Intercept: 1
 Data Points: Inclination (*), Modifier Factor
 Data Point: (-90, 1)
 Data Point: (12.9, 1)
 Data Point: (13, 0.667)
 Data Point: (17, 0.667)
 Data Point: (17.1, 1)

17 degrees A-Bed 4-8° (Tmc)

Model: Spline Data Point Function
 Function: Modifier Factor vs. Inclination
 Curve Fit to Data: 100 %

Segment Curvature: 0 %
 Y-Intercept: 1
 Data Points: Inclination (*), Modifier Factor
 Data Point: (-90, 1)
 Data Point: (3.9, 1)
 Data Point: (4, 0.425)
 Data Point: (8, 0.425)
 Data Point: (8.1, 1)

Points

	X (ft)	Y (ft)
Point 1	-199	1,945
Point 2	-60	1,952
Point 3	-8	1,953
Point 4	50	1,956
Point 5	91	1,958
Point 6	145	1,986
Point 7	155	1,986
Point 8	206	2,010
Point 9	224	2,010
Point 10	281	2,036
Point 11	291	2,036
Point 12	347	2,057
Point 13	356	2,059
Point 14	408	2,083
Point 15	420	2,083
Point 16	454	2,097
Point 17	482	2,096
Point 18	810	2,134
Point 19	810	2,130
Point 20	810	1,998
Point 21	810	1,801
Point 22	-200	1,891
Point 23	499	1,965
Point 24	-200	1,800
Point 25	89.9947	1,921.9873
Point 26	490.0406	2,009.3202
Point 27	810.0186	2,043.084
Point 28	113	1,969.4074
Point 29	60	1,956.4878
Point 30	91	1,928
Point 31	191	1,928
Point 32	149.5	1,928
Point 33	198.129	1,930.307
Point 34	398.5487	1,997.0656
Point 35	532	2,096
Point 36	582.4244	2,110.0118
Point 37	632.8615	2,116.9809
Point 38	674.6211	2,119.9729

Point 39	749	2,125
Point 40	759	2,129
Point 41	810	2,151

Regions

	Material	Points	Area (ft ²)
Region 1	TQs (150 psf 17° A-Bed 5-17°)	18,34,26,27,19	18,289
Region 2	Tmc (150 psf 17° A-Bed 4-8°)	20,23,33,31,32,22,24,21	1.4487e+005
Region 3	Fill	29,30,32,31,33,34,18,41,40,39,38,37,36,35,17,16,15,14,13,12,11,10,9,8,7,6,28,5	40,344
Region 4	TQs (150 psf 11° A-Bed 13-17°)	26,34,33,23,20,27	22,901
Region 5	TQs (150 psf 11° A-Bed 13-17°)	4,3,2,1,22,32,30,29	12,840

Current Slip Surface

Slip Surface: 1
 F of S: 1.11
 Volume: 39,094.946 ft³
 Weight: 4,691,393.5 lbs
 Resisting Moment: 3.7213436e+008 lbs-ft
 Activating Moment: 3.3508753e+008 lbs-ft
 Resisting Force: 1,517,288.4 lbs
 Activating Force: 1,378,623.5 lbs
 F of S Rank (Analysis): 1 of 1 slip surfaces
 F of S Rank (Query): 1 of 1 slip surfaces
 Exit: (118.84895, 1,972.4402) ft
 Entry: (642.58224, 2,117.6774) ft
 Radius: 256.67241 ft
 Center: (350.50865, 2,153.9867) ft

Slip Slices

	X (ft)	Y (ft)	PWP (psf)	Base Normal Stress (psf)	Frictional Strength (psf)	Cohesive Strength (psf)
Slice 1	131.92447	1,967.0241	0	3,345.9507	2,172.8858	200
Slice 2	150	1,959.537	0	6,925.0032	4,497.1497	200
Slice 3	163.5	1,953.9451	0	9,331.2413	6,059.779	200
Slice 4	180.5	1,946.9035	0	13,104.612	8,510.2344	200
Slice 5	197.5	1,939.8619	0	16,877.98	10,960.689	200
Slice 6	207.97385	1,935.5234	0	18,969.771	12,319.113	200
Slice 7	212.34756	1,935.2742	0	8,298.0992	5,388.8487	200

Slice 8	219.37371	1,936.9381	0	7,907.8903	1,537.1382	150.075
Slice 9	233.5	1,940.2834	0	8,014.7195	1,557.9036	150.075
Slice 10	252.5	1,944.7829	0	8,465.2959	1,645.4868	150.075
Slice 11	271.5	1,949.2824	0	8,915.8719	1,733.0699	150.075
Slice 12	286	1,952.7162	0	9,013.132	1,751.9754	150.075
Slice 13	300.33333	1,956.1105	0	9,024.556	1,754.196	150.075
Slice 14	319	1,960.5311	0	9,303.459	1,808.4092	150.075
Slice 15	337.66667	1,964.9516	0	9,582.3625	1,862.6226	150.075
Slice 16	351.5	1,968.2275	0	9,714.7138	1,888.3491	150.075
Slice 17	366.63718	1,971.8122	0	9,966.0777	1,937.2093	150.075
Slice 18	387.91152	1,976.8503	0	10,483.006	2,037.69	150.075
Slice 19	403.27435	1,980.4885	0	10,856.296	2,110.2501	150.075
Slice 20	414	1,983.0285	0	10,817.487	2,102.7064	150.075
Slice 21	428.5	1,986.4623	0	10,824.643	2,104.0974	150.075
Slice 22	445.5	1,990.4881	0	11,146.222	2,166.6061	150.075
Slice 23	461	1,994.1588	0	11,100.742	2,157.7656	150.075
Slice 24	475	1,997.4742	0	10,688.201	2,077.5758	150.075
Slice 25	486.0203	2,000.084	0	10,378.989	2,017.4711	150.075
Slice 26	500.53045	2,003.5202	0	10,007.448	1,945.2508	150.075
Slice 27	521.51015	2,008.4885	0	9,470.2506	1,840.8302	150.075
Slice 28	542.56809	2,013.4753	0	9,248.5731	1,797.7405	150.075
Slice 29	564.0663	2,018.5664	0	9,405.108	2,875.4301	225
Slice 30	578.71041	2,026.4589	0	4,061.2097	3,407.7595	225
Slice 31	594.52014	2,049.0376	0	3,059.0368	2,566.8367	225
Slice 32	613.17728	2,075.6827	0	2,032.5286	1,319.9395	200
Slice 33	626.30009	2,094.4241	0	1,098.302	713.24566	200
Slice 34	637.72187	2,110.736	0	267.32964	173.6059	200

Section 5-5 Static Final with key SSA for Skyline Ranch.gsz

Section 5-5 Static Final with key SSA for Skyline Ranch.gsz Run By: Dr. Alexander Bykovtsev, Ph.D., P.E. 3/21/2016 1:35:28 PM

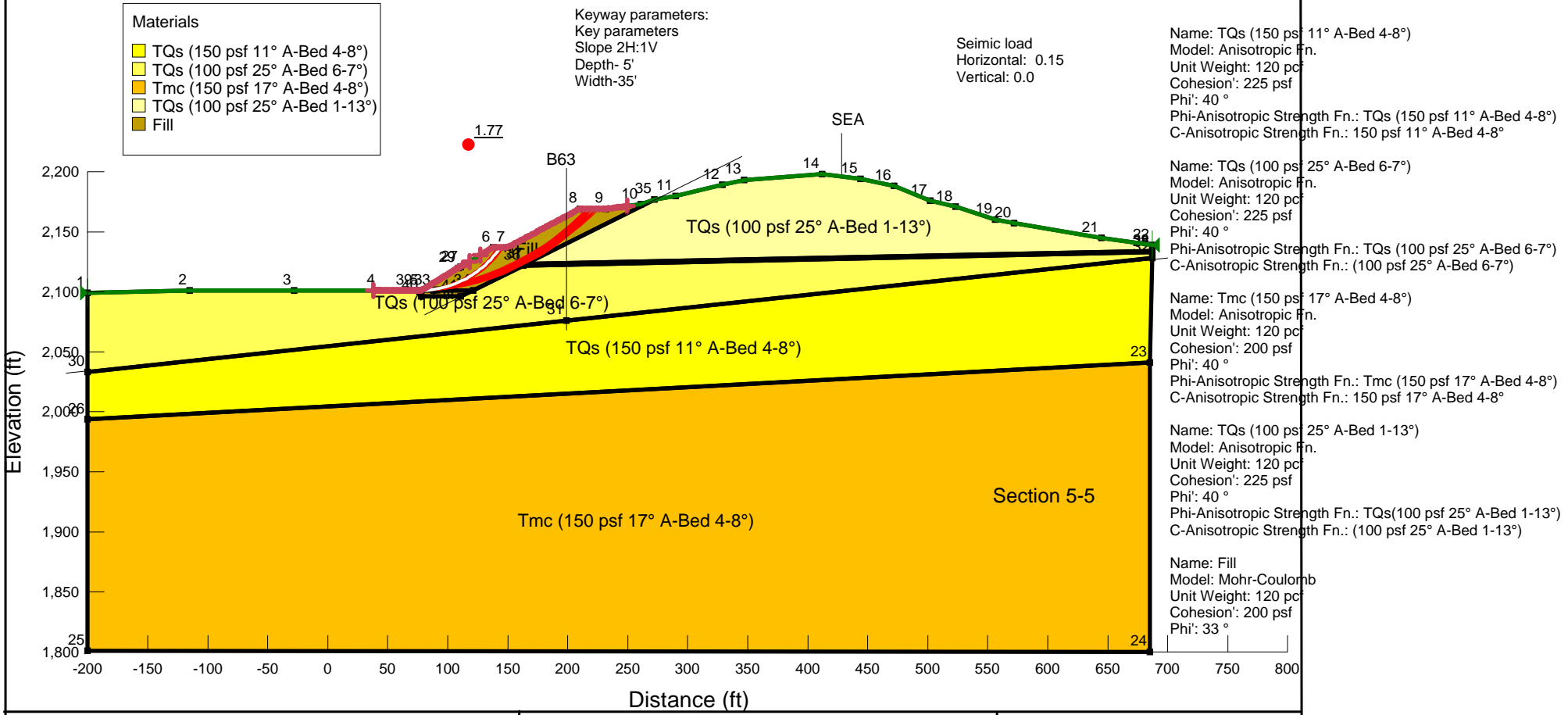

LGC **LGC Valley, Inc**
 GEOTECHNICAL CONSULTING
 28532 Constellation Road, Valencia, CA 91355
 Phone 661-702-8474, Fax 661-702-8475

Skyline Ranch
 Development project, Tract 60922
 Los Angeles CA

Project No: **153035-01**
 Engineer: **BAS**
 Date: **March 2016**

1 - Circular Mode of Failure

Report generated using GeoStudio 2012. Copyright © 1991-2016 GEO-SLOPE International Ltd.

File Information

File Version: 8.15
 Title: Static Slope Stability Analyses for Skyline Ranch Development project, Tract 60922, Los Angeles CA
 Comments: Run By: Dr. Alexander Bykovtsev, Ph.D., P.E.
 Last Edited By: Alexander Bykovtsec
 Revision Number: 82
 Date: 3/21/2016
 Time: 1:35:28 PM
 Tool Version: 8.15.5.11777
 File Name: Section 5-5 Static Final with key SSA for Skyline Ranch.gsz
 Directory: P:\FINAL PROJECTS\PARDEE\Skyline Ranch\SLOPE RESULTS\Section 5-5 results\Latest Update 3-19-16\
 Last Solved Date: 3/21/2016
 Last Solved Time: 1:37:19 PM

Project Settings

Length(L) Units: Feet
 Time(t) Units: Seconds
 Force(F) Units: Pounds
 Pressure(p) Units: psf
 Strength Units: psf
 Unit Weight of Water: 62.4 pcf
 View: 2D
 Element Thickness: 1

Analysis Settings

1 - Circular Mode of Failure

Kind: SLOPE/W
 Method: Bishop
 Settings
 PWP Conditions Source: (none)
 Slip Surface
 Direction of movement: Right to Left
 Use Passive Mode: No
 Slip Surface Option: Entry and Exit
 Critical slip surfaces saved: 10
 Resisting Side Maximum Convex Angle: 1 °
 Driving Side Maximum Convex Angle: 5 °
 Optimize Critical Slip Surface Location: No
 Tension Crack
 Tension Crack Option: (none)

file:///P:/FINAL%20PROJECTS/PARDEE/Skyline%20Ranch/SLOPE%20RESULTS/Sect... 3/21/2016

F of S Distribution
 F of S Calculation Option: Constant
 Advanced
 Number of Slices: 30
 F of S Tolerance: 0.01
 Minimum Slip Surface Depth: 0.1 ft

Materials

TQs (150 psf 11° A-Bed 4-8°)

Model: Anisotropic Fn.
 Unit Weight: 120 pcf
 Cohesion': 225 psf
 Phi': 40 °
 Phi-Anisotropic Strength Fn.: TQs (150 psf 11° A-Bed 4-8°)
 C-Anisotropic Strength Fn.: 150 psf 11° A-Bed 4-8°
 Phi-B: 0 °

TQs (100 psf 25° A-Bed 6-7°)

Model: Anisotropic Fn.
 Unit Weight: 120 pcf
 Cohesion': 225 psf
 Phi': 40 °
 Phi-Anisotropic Strength Fn.: TQs (100 psf 25° A-Bed 6-7°)
 C-Anisotropic Strength Fn.: (100 psf 25° A-Bed 6-7°)
 Phi-B: 0 °

Tmc (150 psf 17° A-Bed 4-8°)

Model: Anisotropic Fn.
 Unit Weight: 120 pcf
 Cohesion': 200 psf
 Phi': 40 °
 Phi-Anisotropic Strength Fn.: Tmc (150 psf 17° A-Bed 4-8°)
 C-Anisotropic Strength Fn.: 150 psf 17° A-Bed 4-8°
 Phi-B: 0 °

TQs (100 psf 25° A-Bed 1-13°)

Model: Anisotropic Fn.
 Unit Weight: 120 pcf
 Cohesion': 225 psf
 Phi': 40 °
 Phi-Anisotropic Strength Fn.: TQs(100 psf 25° A-Bed 1-13°)
 C-Anisotropic Strength Fn.: (100 psf 25° A-Bed 1-13°)
 Phi-B: 0 °

Fill

Model: Mohr-Coulomb
 Unit Weight: 120 pcf
 Cohesion': 200 psf

file:///P:/FINAL%20PROJECTS/PARDEE/Skyline%20Ranch/SLOPE%20RESULTS/Sect... 3/21/2016

Phi': 33 °
Phi-B: 0 °

Slip Surface Entry and Exit

Left Projection: Range
Left-Zone Left Coordinate: (38, 2,101) ft
Left-Zone Right Coordinate: (118, 2,125.1481) ft
Left-Zone Increment: 50
Right Projection: Range
Right-Zone Left Coordinate: (127, 2,130.4815) ft
Right-Zone Right Coordinate: (249.7424, 2,171.4472) ft
Right-Zone Increment: 50
Radius Increments: 50

Slip Surface Limits

Left Coordinate: (-200, 2,099) ft
Right Coordinate: (687, 2,139) ft

Seismic Coefficients

Horz Seismic Coef.: 0
Vert Seismic Coef.: 0

Anisotropic Strength Functions

Tmc (150 psf 17° A-Bed 4-8°)

Model: Spline Data Point Function
Function: Modifier Factor vs. Inclination
Curve Fit to Data: 100 %
Segment Curvature: 0 %
Y-Intercept: 1
Data Points: Inclination (°), Modifier Factor
Data Point: (-90, 1)
Data Point: (3.9, 1)
Data Point: (4, 0.425)
Data Point: (8, 0.425)
Data Point: (8.1, 1)

150 psf 17° A-Bed 4-8°

Model: Spline Data Point Function
Function: Modifier Factor vs. Inclination
Curve Fit to Data: 100 %
Segment Curvature: 0 %
Y-Intercept: 1
Data Points: Inclination (°), Modifier Factor
Data Point: (-90, 1)

Data Point: (3.9, 1)
Data Point: (4, 0.75)
Data Point: (8, 0.75)
Data Point: (8.1, 1)

TQs (150 psf 11° A-Bed 4-8°)

Model: Spline Data Point Function
Function: Modifier Factor vs. Inclination
Curve Fit to Data: 100 %
Segment Curvature: 0 %
Y-Intercept: 1
Data Points: Inclination (°), Modifier Factor
Data Point: (-90, 1)
Data Point: (3.9, 1)
Data Point: (4, 0.275)
Data Point: (8, 0.275)
Data Point: (8.1, 1)

150 psf 11° A-Bed 4-8°

Model: Spline Data Point Function
Function: Modifier Factor vs. Inclination
Curve Fit to Data: 100 %
Segment Curvature: 0 %
Y-Intercept: 1
Data Points: Inclination (°), Modifier Factor
Data Point: (-90, 1)
Data Point: (3.9, 1)
Data Point: (4, 0.667)
Data Point: (8, 0.667)
Data Point: (8.1, 1)

TQs (100 psf 25° A-Bed 6-7°)

Model: Spline Data Point Function
Function: Modifier Factor vs. Inclination
Curve Fit to Data: 100 %
Segment Curvature: 0 %
Y-Intercept: 1
Data Points: Inclination (°), Modifier Factor
Data Point: (-90, 1)
Data Point: (5.9, 1)
Data Point: (6, 0.625)
Data Point: (7, 0.625)
Data Point: (7.1, 1)

(100 psf 25° A-Bed 6-7°)

Model: Spline Data Point Function
Function: Modifier Factor vs. Inclination
Curve Fit to Data: 100 %
Segment Curvature: 0 %
Y-Intercept: 1

Data Points: Inclination (°), Modifier Factor

- Data Point: (-90, 1)
- Data Point: (5.9, 1)
- Data Point: (6, 0.444)
- Data Point: (7, 0.444)
- Data Point: (7.1, 1)

(100 psf 25° A-Bed 1-13°)

Model: Spline Data Point Function

Function: Modifier Factor vs. Inclination

- Curve Fit to Data: 100 %
- Segment Curvature: 0 %

Y-Intercept: 1

Data Points: Inclination (°), Modifier Factor

- Data Point: (-90, 1)
- Data Point: (0.9, 1)
- Data Point: (1, 0.444)
- Data Point: (13, 0.444)
- Data Point: (13.1, 1)

TQs(100 psf 25° A-Bed 1-13°)

Model: Spline Data Point Function

Function: Modifier Factor vs. Inclination

- Curve Fit to Data: 100 %
- Segment Curvature: 0 %

Y-Intercept: 1

Data Points: Inclination (°), Modifier Factor

- Data Point: (-90, 1)
- Data Point: (0.9, 1)
- Data Point: (1, 0.625)
- Data Point: (13, 0.625)
- Data Point: (13.1, 1)

Points

	X (ft)	Y (ft)
Point 1	-200	2,099
Point 2	-115	2,101
Point 3	-28	2,101
Point 4	42	2,101
Point 5	78	2,101
Point 6	138	2,137
Point 7	150	2,137
Point 8	210	2,169
Point 9	232	2,169
Point 10	261	2,173
Point 11	290	2,180
Point 12	329	2,189

Point 13	347	2,193
Point 14	412	2,198
Point 15	444	2,194
Point 16	472	2,188
Point 17	502	2,176
Point 18	523	2,171
Point 19	556	2,160
Point 20	572	2,157
Point 21	645	2,145
Point 22	687	2,139
Point 23	685	2,041
Point 24	685	1,800
Point 25	-200	1,801
Point 26	-200	1,994
Point 27	111	2,121
Point 28	687	2,133
Point 29	109	2,120
Point 30	-200	2,033
Point 31	199	2,076
Point 32	687	2,128
Point 33	88	2,101
Point 34	121	2,101
Point 35	272	2,177
Point 36	163	2,122
Point 37	165	2,123
Point 38	687	2,134
Point 39	73	2,101
Point 40	78	2,096
Point 41	111	2,096

Regions

	Material	Points	Area (ft²)
Region 1	Tmc (150 psf 17° A-Bed 4-8°)	23,24,25,26	1.9205e+005
Region 2	TQs (100 psf 25° A-Bed 6-7°)	1,30,31,32,28,36,34,41,40,39,4,3,2	32,105
Region 3	TQs (100 psf 25° A-Bed 1-13°)	22,21,20,19,18,17,16,15,14,13,12,11,35,37,38	21,235
Region 4	TQs (150 psf 11° A-Bed 4-8°)	30,26,23,32,31	55,865
Region 5	Fill	5,33,34,36,37,35,10,9,8,7,6,27,29	3,254.5
Region 6		36,28,38,37	512

Region 7	Fill	39,40,41,34,33,5	202.5
-------------	------	------------------	-------

Current Slip Surface

Slip Surface: 60,201
 F of S: 1.77
 Volume: 573.74016 ft³
 Weight: 68,848.819 lbs
 Resisting Moment: 4,609,078.4 lbs-ft
 Activating Moment: 2,604,068.2 lbs-ft
 F of S Rank (Analysis): 1 of 132,651 slip surfaces
 F of S Rank (Query): 1 of 300 slip surfaces
 Exit: (78.004122, 2,101.0025) ft
 Entry: (143.79119, 2,137) ft
 Radius: 81.751002 ft
 Center: (76.026676, 2,182.7296) ft

Slip Slices

	X (ft)	Y (ft)	PWP (psf)	Base Normal Stress (psf)	Frictional Strength (psf)	Cohesive Strength (psf)
Slice 1	79.111118	2,101.0443	0	71.160582	46.212222	200
Slice 2	81.325109	2,101.158	0	213.19928	138.45323	200
Slice 3	83.539101	2,101.3321	0	345.46092	224.34494	200
Slice 4	85.753092	2,101.5669	0	468.14495	304.01689	200
Slice 5	87.967083	2,101.863	0	581.41951	377.57824	200
Slice 6	90.181074	2,102.2211	0	685.42338	445.11915	200
Slice 7	92.395066	2,102.642	0	780.26764	506.71173	200
Slice 8	94.609057	2,103.1267	0	866.03685	562.41091	200
Slice 9	96.823048	2,103.6763	0	942.78987	612.2549	200
Slice 10	99.037039	2,104.2923	0	1,010.5604	656.26563	200
Slice 11	101.25103	2,104.9761	0	1,069.3573	694.44877	200
Slice 12	103.46502	2,105.7297	0	1,119.1642	726.79374	200
Slice 13	105.67901	2,106.5551	0	1,159.9392	753.27334	200
Slice						

14	107.893	2,107.4547	0	1,191.6141	773.84327	200
Slice 15	110	2,108.3802	0	1,201.8071	780.46265	200
Slice 16	112.125	2,109.3909	0	1,201.1479	780.03459	200
Slice 17	114.375	2,110.5423	0	1,201.3795	780.185	200
Slice 18	116.625	2,111.7837	0	1,191.7637	773.9404	200
Slice 19	118.875	2,113.12	0	1,172.0707	761.15162	200
Slice 20	121.125	2,114.5567	0	1,142.0285	741.64195	200
Slice 21	123.375	2,116.1004	0	1,101.3173	715.20382	200
Slice 22	125.625	2,117.7586	0	1,049.5638	681.59472	200
Slice 23	127.875	2,119.5405	0	986.33329	640.53233	200
Slice 24	130.125	2,121.4569	0	911.1203	591.68844	200
Slice 25	132.375	2,123.5208	0	823.33774	534.68178	200
Slice 26	134.625	2,125.7484	0	722.30347	469.06936	200
Slice 27	136.875	2,128.1598	0	607.22521	394.33666	200
Slice 28	138.9652	2,130.5791	0	440.0239	285.75486	200
Slice 29	140.89559	2,133.003	0	225.06637	146.15981	200
Slice 30	142.82599	2,135.6311	0	2.8704439	1.8640881	200

Section 5-5 Seismic Final with key SSA for Skyline Ranch.gsz

Section 5-5 Seismic Final with key SSA for Skyline Ranch.gsz Run By: Dr. Alexander Bykovtsev, Ph.D., P.E. 3/21/2016 1:24:10 PM

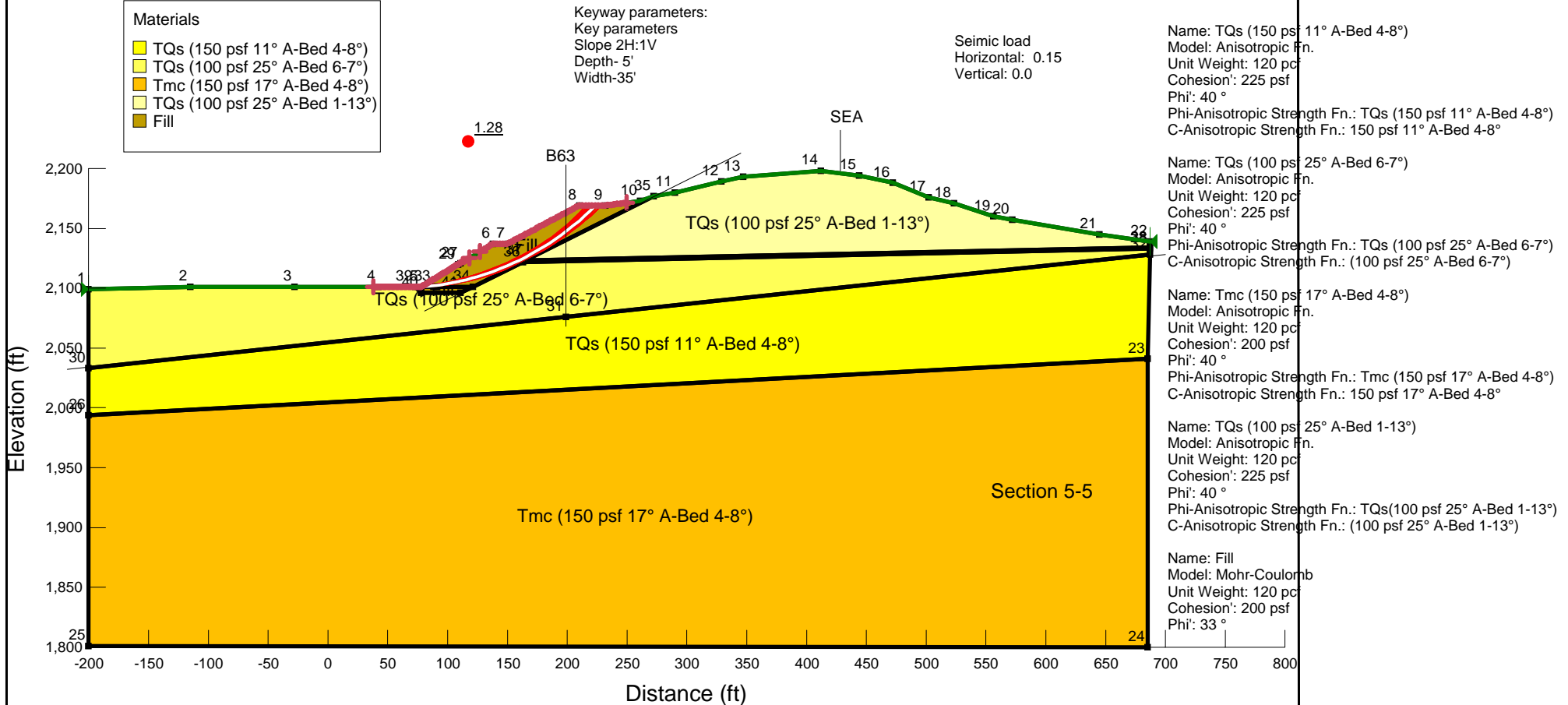

LGC **LGC Valley, Inc**
GEOTECHNICAL CONSULTING
28532 Constellation Road, Valencia, CA 91355
Phone 661-702-8474, Fax 661-702-8475

Skyline Ranch
Development project, Tract 60922
Los Angeles CA

Project No: **153035-01**
Engineer: **BAS**
Date: **March 2016**

1 - Circular Mode of Failure

Report generated using GeoStudio 2012. Copyright © 1991-2016 GEO-SLOPE International Ltd.

File Information

File Version: 8.15
 Title: *Static Slope Stability Analyses for Skyline Ranch Development project, Tract 60922, Los Angeles CA*
 Comments: Run By: Dr. Alexander Bykovtsev, Ph.D., P.E.
 Last Edited By: Alexander Bykovtsev
 Revision Number: 80
 Date: 3/21/2016
 Time: 1:24:10 PM
 Tool Version: 8.15.5.11777
 File Name: Section 5-5 Seismic Final with key SSA for Skyline Ranch.gsz
 Directory: P:\FINAL PROJECTS\PARDEE\Skyline Ranch\SLOPE RESULTS\Section 5-5 results\Latest Update 3-19-16\
 Last Solved Date: 3/21/2016
 Last Solved Time: 1:31:31 PM

Project Settings

Length(L) Units: Feet
 Time(t) Units: Seconds
 Force(F) Units: Pounds
 Pressure(p) Units: psf
 Strength Units: psf
 Unit Weight of Water: 62.4 pcf
 View: 2D
 Element Thickness: 1

Analysis Settings

1 - Circular Mode of Failure

Kind: SLOPE/W
 Method: Bishop
 Settings
 PWP Conditions Source: (none)
 Slip Surface
 Direction of movement: Right to Left
 Use Passive Mode: No
 Slip Surface Option: Entry and Exit
 Critical slip surfaces saved: 10
 Resisting Side Maximum Convex Angle: 1 °
 Driving Side Maximum Convex Angle: 5 °
 Optimize Critical Slip Surface Location: No
 Tension Crack
 Tension Crack Option: (none)

file:///P:/FINAL%20PROJECTS/PARDEE/Skyline%20Ranch/SLOPE%20RESULTS/Sect... 3/21/2016

F of S Distribution
 F of S Calculation Option: Constant
 Advanced
 Number of Slices: 30
 F of S Tolerance: 0.01
 Minimum Slip Surface Depth: 0.1 ft

Materials

TQs (150 psf 11° A-Bed 4-8°)

Model: Anisotropic Fn.
 Unit Weight: 120 pcf
 Cohesion': 225 psf
 Phi': 40 °
 Phi-Anisotropic Strength Fn.: TQs (150 psf 11° A-Bed 4-8°)
 C-Anisotropic Strength Fn.: 150 psf 11° A-Bed 4-8°
 Phi-B: 0 °

TQs (100 psf 25° A-Bed 6-7°)

Model: Anisotropic Fn.
 Unit Weight: 120 pcf
 Cohesion': 225 psf
 Phi': 40 °
 Phi-Anisotropic Strength Fn.: TQs (100 psf 25° A-Bed 6-7°)
 C-Anisotropic Strength Fn.: (100 psf 25° A-Bed 6-7°)
 Phi-B: 0 °

Tmc (150 psf 17° A-Bed 4-8°)

Model: Anisotropic Fn.
 Unit Weight: 120 pcf
 Cohesion': 200 psf
 Phi': 40 °
 Phi-Anisotropic Strength Fn.: Tmc (150 psf 17° A-Bed 4-8°)
 C-Anisotropic Strength Fn.: 150 psf 17° A-Bed 4-8°
 Phi-B: 0 °

TQs (100 psf 25° A-Bed 1-13°)

Model: Anisotropic Fn.
 Unit Weight: 120 pcf
 Cohesion': 225 psf
 Phi': 40 °
 Phi-Anisotropic Strength Fn.: TQs(100 psf 25° A-Bed 1-13°)
 C-Anisotropic Strength Fn.: (100 psf 25° A-Bed 1-13°)
 Phi-B: 0 °

Fill

Model: Mohr-Coulomb
 Unit Weight: 120 pcf
 Cohesion': 200 psf

file:///P:/FINAL%20PROJECTS/PARDEE/Skyline%20Ranch/SLOPE%20RESULTS/Sect... 3/21/2016

Phi': 33 °
Phi-B: 0 °

Slip Surface Entry and Exit

Left Projection: Range
Left-Zone Left Coordinate: (38, 2,101) ft
Left-Zone Right Coordinate: (118, 2,125.1481) ft
Left-Zone Increment: 50
Right Projection: Range
Right-Zone Left Coordinate: (127, 2,130.4815) ft
Right-Zone Right Coordinate: (249.7424, 2,171.4472) ft
Right-Zone Increment: 50
Radius Increments: 50

Slip Surface Limits

Left Coordinate: (-200, 2,099) ft
Right Coordinate: (687, 2,139) ft

Seismic Coefficients

Horz Seismic Coef.: 0.15
Vert Seismic Coef.: 0

Anisotropic Strength Functions

Tmc (150 psf 17° A-Bed 4-8°)

Model: Spline Data Point Function
Function: Modifier Factor vs. Inclination
Curve Fit to Data: 100 %
Segment Curvature: 0 %
Y-Intercept: 1
Data Points: Inclination (°), Modifier Factor
Data Point: (-90, 1)
Data Point: (3.9, 1)
Data Point: (4, 0.425)
Data Point: (8, 0.425)
Data Point: (8.1, 1)

150 psf 17° A-Bed 4-8°

Model: Spline Data Point Function
Function: Modifier Factor vs. Inclination
Curve Fit to Data: 100 %
Segment Curvature: 0 %
Y-Intercept: 1
Data Points: Inclination (°), Modifier Factor
Data Point: (-90, 1)

Data Point: (3.9, 1)
Data Point: (4, 0.75)
Data Point: (8, 0.75)
Data Point: (8.1, 1)

TQs (150 psf 11° A-Bed 4-8°)

Model: Spline Data Point Function
Function: Modifier Factor vs. Inclination
Curve Fit to Data: 100 %
Segment Curvature: 0 %
Y-Intercept: 1
Data Points: Inclination (°), Modifier Factor
Data Point: (-90, 1)
Data Point: (3.9, 1)
Data Point: (4, 0.275)
Data Point: (8, 0.275)
Data Point: (8.1, 1)

150 psf 11° A-Bed 4-8°

Model: Spline Data Point Function
Function: Modifier Factor vs. Inclination
Curve Fit to Data: 100 %
Segment Curvature: 0 %
Y-Intercept: 1
Data Points: Inclination (°), Modifier Factor
Data Point: (-90, 1)
Data Point: (3.9, 1)
Data Point: (4, 0.667)
Data Point: (8, 0.667)
Data Point: (8.1, 1)

TQs (100 psf 25° A-Bed 6-7°)

Model: Spline Data Point Function
Function: Modifier Factor vs. Inclination
Curve Fit to Data: 100 %
Segment Curvature: 0 %
Y-Intercept: 1
Data Points: Inclination (°), Modifier Factor
Data Point: (-90, 1)
Data Point: (5.9, 1)
Data Point: (6, 0.625)
Data Point: (7, 0.625)
Data Point: (7.1, 1)

(100 psf 25° A-Bed 6-7°)

Model: Spline Data Point Function
Function: Modifier Factor vs. Inclination
Curve Fit to Data: 100 %
Segment Curvature: 0 %
Y-Intercept: 1

Data Points: Inclination (°), Modifier Factor

- Data Point: (-90, 1)
- Data Point: (5.9, 1)
- Data Point: (6, 0.444)
- Data Point: (7, 0.444)
- Data Point: (7.1, 1)

(100 psf 25° A-Bed 1-13°)

Model: Spline Data Point Function

Function: Modifier Factor vs. Inclination

- Curve Fit to Data: 100 %
- Segment Curvature: 0 %

Y-Intercept: 1

Data Points: Inclination (°), Modifier Factor

- Data Point: (-90, 1)
- Data Point: (0.9, 1)
- Data Point: (1, 0.444)
- Data Point: (13, 0.444)
- Data Point: (13.1, 1)

TQs(100 psf 25° A-Bed 1-13°)

Model: Spline Data Point Function

Function: Modifier Factor vs. Inclination

- Curve Fit to Data: 100 %
- Segment Curvature: 0 %

Y-Intercept: 1

Data Points: Inclination (°), Modifier Factor

- Data Point: (-90, 1)
- Data Point: (0.9, 1)
- Data Point: (1, 0.625)
- Data Point: (13, 0.625)
- Data Point: (13.1, 1)

Points

	X (ft)	Y (ft)
Point 1	-200	2,099
Point 2	-115	2,101
Point 3	-28	2,101
Point 4	42	2,101
Point 5	78	2,101
Point 6	138	2,137
Point 7	150	2,137
Point 8	210	2,169
Point 9	232	2,169
Point 10	261	2,173
Point 11	290	2,180
Point 12	329	2,189

Point 13	347	2,193
Point 14	412	2,198
Point 15	444	2,194
Point 16	472	2,188
Point 17	502	2,176
Point 18	523	2,171
Point 19	556	2,160
Point 20	572	2,157
Point 21	645	2,145
Point 22	687	2,139
Point 23	685	2,041
Point 24	685	1,800
Point 25	-200	1,801
Point 26	-200	1,994
Point 27	111	2,121
Point 28	687	2,133
Point 29	109	2,120
Point 30	-200	2,033
Point 31	199	2,076
Point 32	687	2,128
Point 33	88	2,101
Point 34	121	2,101
Point 35	272	2,177
Point 36	163	2,122
Point 37	165	2,123
Point 38	687	2,134
Point 39	73	2,101
Point 40	78	2,096
Point 41	111	2,096

Regions

	Material	Points	Area (ft²)
Region 1	Tmc (150 psf 17° A-Bed 4-8°)	23,24,25,26	1.9205e+005
Region 2	TQs (100 psf 25° A-Bed 6-7°)	1,30,31,32,28,36,34,41,40,39,4,3,2	32,105
Region 3	TQs (100 psf 25° A-Bed 1-13°)	22,21,20,19,18,17,16,15,14,13,12,11,35,37,38	21,235
Region 4	TQs (150 psf 11° A-Bed 4-8°)	30,26,23,32,31	55,865
Region 5	Fill	5,33,34,36,37,35,10,9,8,7,6,27,29	3,254.5
Region 6		36,28,38,37	512

Region 7	Fill	39,40,41,34,33,5	202.5
-------------	------	------------------	-------

Current Slip Surface

Slip Surface: 61,877
 F of S: 1.28
 Volume: 2,166.4005 ft³
 Weight: 259,968.07 lbs
 Resisting Moment: 41,153,120 lbs-ft
 Activating Moment: 32,138,520 lbs-ft
 F of S Rank (Analysis): 1 of 132,651 slip surfaces
 F of S Rank (Query): 1 of 300 slip surfaces
 Exit: (78.015509, 2,101.0095) ft
 Entry: (223.37103, 2,169) ft
 Radius: 229.37058 ft
 Center: (59.650312, 2,329.6437) ft

Slip Slices

	X (ft)	Y (ft)	PWP (psf)	Base Normal Stress (psf)	Frictional Strength (psf)	Cohesive Strength (psf)
Slice 1	80.59755	2,101.2463	0	140.6808	91.35918	200
Slice 2	85.761632	2,101.779	0	434.36064	282.0771	200
Slice 3	90.925714	2,102.4303	0	708.29406	459.97154	200
Slice 4	96.089796	2,103.2012	0	962.91445	625.32396	200
Slice 5	101.25388	2,104.093	0	1,198.6059	778.38377	200
Slice 6	106.41796	2,105.1071	0	1,415.7065	919.37055	200
Slice 7	110	2,105.8699	0	1,544.8146	1,003.2144	200
Slice 8	113.25	2,106.6356	0	1,646.2184	1,069.0667	200
Slice 9	117.75	2,107.7656	0	1,790.2954	1,162.6314	200
Slice 10	122.25	2,108.9931	0	1,921.0518	1,247.5456	200
Slice 11	126.75	2,110.3198	0	2,038.6021	1,323.8837	200
Slice 12	131.25	2,111.7475	0	2,143.0405	1,391.7068	200
Slice 13	135.75	2,113.2782	0	2,234.4417	1,451.0634	200
Slice						

14	141	2,115.2077	0	2,144.5972	1,392.7177	200
Slice 15	147	2,117.5815	0	1,875.4445	1,217.9279	200
Slice 16	152.5	2,119.924	0	1,748.6825	1,135.6077	200
Slice 17	157.5	2,122.2102	0	1,761.2162	1,143.7472	200
Slice 18	162.5	2,124.6437	0	1,758.4998	1,141.9831	200
Slice 19	167.5	2,127.23	0	1,740.4854	1,130.2845	200
Slice 20	172.5	2,129.975	0	1,707.0996	1,108.6034	200
Slice 21	177.5	2,132.8854	0	1,658.2426	1,076.8754	200
Slice 22	182.5	2,135.9686	0	1,593.7887	1,035.0185	200
Slice 23	187.5	2,139.2329	0	1,513.5852	982.93375	200
Slice 24	192.5	2,142.688	0	1,417.453	920.50477	200
Slice 25	197.5	2,146.3446	0	1,305.1861	847.59774	200
Slice 26	202.5	2,150.2151	0	1,176.552	764.0618	200
Slice 27	207.5	2,154.3136	0	1,031.2934	669.72979	200
Slice 28	212.2285	2,158.4074	0	780.62226	506.94202	200
Slice 29	216.68551	2,162.4867	0	430.69626	279.69742	200
Slice 30	221.14252	2,166.7901	0	73.766475	47.904509	200

Section 5-5 Static Final with key SSA for Skyline Ranch.gsz

Section 5-5 Static Final with key SSA for Skyline Ranch.gsz Run By: Dr. Alexander Bykovtsev, Ph.D., P.E. 3/21/2016 1:35:28 PM

Materials

- TQs (150 psf 11° A-Bed 4-8°)
- TQs (100 psf 25° A-Bed 6-7°)
- Tmc (150 psf 17° A-Bed 4-8°)
- TQs (100 psf 25° A-Bed 1-13°)
- Fill

Keyway parameters:
Key parameters
Slope 2H:1V
Depth- 5'
Width-35'

Seismic load
Horizontal: 0.15
Vertical: 0.0

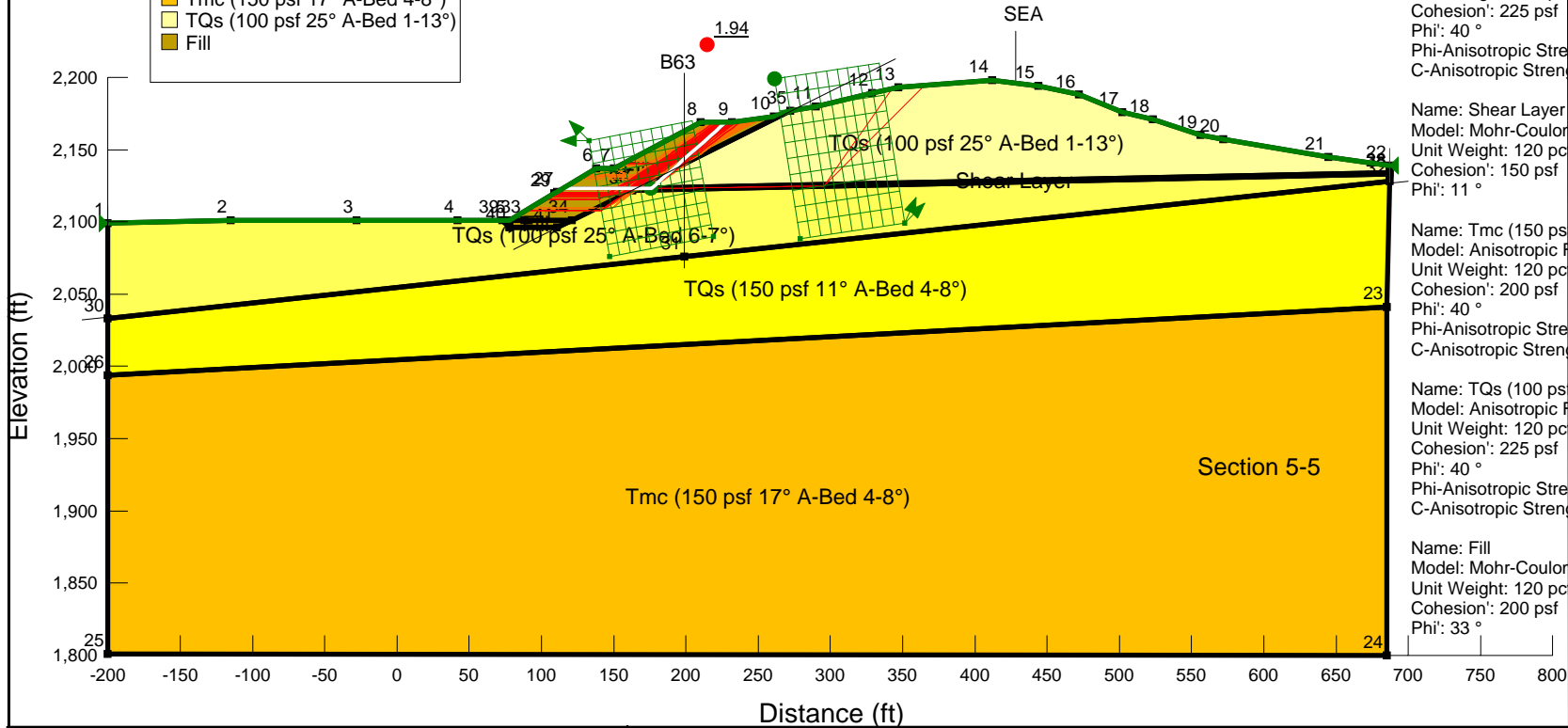

Name: TQs (150 psf 11° A-Bed 4-8°)
Model: Anisotropic Fn.
Unit Weight: 120 pcf
Cohesion: 225 psf
Phi: 40°
Phi-Anisotropic Strength Fn.: TQs (150 psf 11° A-Bed 4-8°)
C-Anisotropic Strength Fn.: 150 psf 11° A-Bed 4-8°

Name: TQs (100 psf 25° A-Bed 6-7°)
Model: Anisotropic Fn.
Unit Weight: 120 pcf
Cohesion: 225 psf
Phi: 40°
Phi-Anisotropic Strength Fn.: TQs (100 psf 25° A-Bed 6-7°)
C-Anisotropic Strength Fn.: (100 psf 25° A-Bed 6-7°)

Name: Shear Layer
Model: Mohr-Coulomb
Unit Weight: 120 pcf
Cohesion: 150 psf
Phi: 11°

Name: Tmc (150 psf 17° A-Bed 4-8°)
Model: Anisotropic Fn.
Unit Weight: 120 pcf
Cohesion: 200 psf
Phi: 40°
Phi-Anisotropic Strength Fn.: Tmc (150 psf 17° A-Bed 4-8°)
C-Anisotropic Strength Fn.: 150 psf 17° A-Bed 4-8°

Name: TQs (100 psf 25° A-Bed 1-13°)
Model: Anisotropic Fn.
Unit Weight: 120 pcf
Cohesion: 225 psf
Phi: 40°
Phi-Anisotropic Strength Fn.: TQs(100 psf 25° A-Bed 1-13°)
C-Anisotropic Strength Fn.: (100 psf 25° A-Bed 1-13°)

Name: Fill
Model: Mohr-Coulomb
Unit Weight: 120 pcf
Cohesion: 200 psf
Phi: 33°



LGC Valley, Inc
GEOTECHNICAL CONSULTING
28532 Constellation Road, Valencia, CA 91355
Phone 661-702-8474, Fax 661-702-8475

Skyline Ranch
Development project, Tract 60922
Los Angeles CA

Project No: **153035-01**
Engineer: **BAS**
Date: **March 2016**

2 - Translational

Report generated using GeoStudio 2012. Copyright © 1991-2016 GEO-SLOPE International Ltd.

File Information

File Version: 8.15
 Title: Static Slope Stability Analyses for Skyline Ranch Development project, Tract 60922, Los Angeles CA
 Comments: Run By: Dr. Alexander Bykovtsev, Ph.D., P.E.
 Last Edited By: Alexander Bykovtsev
 Revision Number: 82
 Date: 3/21/2016
 Time: 1:35:28 PM
 Tool Version: 8.15.5.11777
 File Name: Section 5-5 Static Final with key SSA for Skyline Ranch.gsz
 Directory: P:\FINAL PROJECTS\PARDEE\Skyline Ranch\SLOPE RESULTS\Section 5-5 results\Latest Update 3-19-16\
 Last Solved Date: 3/21/2016
 Last Solved Time: 1:36:03 PM

Project Settings

Length(L) Units: Feet
 Time(t) Units: Seconds
 Force(F) Units: Pounds
 Pressure(p) Units: psf
 Strength Units: psf
 Unit Weight of Water: 62.4 pcf
 View: 2D
 Element Thickness: 1

Analysis Settings

2 - Translational

Kind: SLOPE/W
 Method: Janbu
 Settings
 PWP Conditions Source: (none)
 Slip Surface
 Direction of movement: Right to Left
 Use Passive Mode: No
 Slip Surface Option: Block
 Critical slip surfaces saved: 10
 Resisting Side Maximum Convex Angle: 1 °
 Driving Side Maximum Convex Angle: 5 °
 Restrict Block Crossing: No
 Optimize Critical Slip Surface Location: No
 Tension Crack

file:///P:/FINAL%20PROJECTS/PARDEE/Skyline%20Ranch/SLOPE%20RESULTS/Sect... 3/21/2016

Tension Crack Option: (none)
 F of S Distribution
 F of S Calculation Option: Constant
 Advanced
 Number of Slices: 30
 F of S Tolerance: 0.01
 Minimum Slip Surface Depth: 0.1 ft

Materials

TQs (150 psf 11° A-Bed 4-8°)

Model: Anisotropic Fn.
 Unit Weight: 120 pcf
 Cohesion': 225 psf
 Phi': 40 °
 Phi-Anisotropic Strength Fn.: TQs (150 psf 11° A-Bed 4-8°)
 C-Anisotropic Strength Fn.: 150 psf 11° A-Bed 4-8°
 Phi-B: 0 °

TQs (100 psf 25° A-Bed 6-7°)

Model: Anisotropic Fn.
 Unit Weight: 120 pcf
 Cohesion': 225 psf
 Phi': 40 °
 Phi-Anisotropic Strength Fn.: TQs (100 psf 25° A-Bed 6-7°)
 C-Anisotropic Strength Fn.: (100 psf 25° A-Bed 6-7°)
 Phi-B: 0 °

Shear Layer

Model: Mohr-Coulomb
 Unit Weight: 120 pcf
 Cohesion': 150 psf
 Phi': 11 °
 Phi-B: 0 °

Tmc (150 psf 17° A-Bed 4-8°)

Model: Anisotropic Fn.
 Unit Weight: 120 pcf
 Cohesion': 200 psf
 Phi': 40 °
 Phi-Anisotropic Strength Fn.: Tmc (150 psf 17° A-Bed 4-8°)
 C-Anisotropic Strength Fn.: 150 psf 17° A-Bed 4-8°
 Phi-B: 0 °

TQs (100 psf 25° A-Bed 1-13°)

Model: Anisotropic Fn.
 Unit Weight: 120 pcf
 Cohesion': 225 psf
 Phi': 40 °

file:///P:/FINAL%20PROJECTS/PARDEE/Skyline%20Ranch/SLOPE%20RESULTS/Sect... 3/21/2016

Phi-Anisotropic Strength Fn.: TQs(100 psf 25° A-Bed 1-13°)
C-Anisotropic Strength Fn.: (100 psf 25° A-Bed 1-13°)
Phi-B: 0°

Fill

Model: Mohr-Coulomb
Unit Weight: 120 pcf
Cohesion: 200 psf
Phi: 33°
Phi-B: 0°

Slip Surface Limits

Left Coordinate: (-200, 2,099) ft
Right Coordinate: (687, 2,139) ft

Slip Surface Block

Left Grid

Upper Left: (132.724, 2,155.9869) ft
Lower Left: (147.2387, 2,075.9597) ft
Lower Right: (218.8751, 2,089.9995) ft
X Increments: 10
Y Increments: 10
Starting Angle: 135°
Ending Angle: 180°
Angle Increments: 2

Right Grid

Upper Left: (261.4184, 2,199.03) ft
Lower Left: (279.2153, 2,088.405) ft
Lower Right: (351.5514, 2,099.3522) ft
X Increments: 10
Y Increments: 10
Starting Angle: 45°
Ending Angle: 65°
Angle Increments: 2

Seismic Coefficients

Horz Seismic Coef.: 0
Vert Seismic Coef.: 0

Anisotropic Strength Functions

Tmc (150 psf 17° A-Bed 4-8°)

Model: Spline Data Point Function
Function: Modifier Factor vs. Inclination
Curve Fit to Data: 100 %

Segment Curvature: 0 %
Y-Intercept: 1
Data Points: Inclination (°), Modifier Factor
Data Point: (-90, 1)
Data Point: (3.9, 1)
Data Point: (4, 0.425)
Data Point: (8, 0.425)
Data Point: (8.1, 1)

150 psf 17° A-Bed 4-8°

Model: Spline Data Point Function
Function: Modifier Factor vs. Inclination
Curve Fit to Data: 100 %
Segment Curvature: 0 %
Y-Intercept: 1
Data Points: Inclination (°), Modifier Factor
Data Point: (-90, 1)
Data Point: (3.9, 1)
Data Point: (4, 0.75)
Data Point: (8, 0.75)
Data Point: (8.1, 1)

TQs (150 psf 11° A-Bed 4-8°)

Model: Spline Data Point Function
Function: Modifier Factor vs. Inclination
Curve Fit to Data: 100 %
Segment Curvature: 0 %
Y-Intercept: 1
Data Points: Inclination (°), Modifier Factor
Data Point: (-90, 1)
Data Point: (3.9, 1)
Data Point: (4, 0.275)
Data Point: (8, 0.275)
Data Point: (8.1, 1)

150 psf 11° A-Bed 4-8°

Model: Spline Data Point Function
Function: Modifier Factor vs. Inclination
Curve Fit to Data: 100 %
Segment Curvature: 0 %
Y-Intercept: 1
Data Points: Inclination (°), Modifier Factor
Data Point: (-90, 1)
Data Point: (3.9, 1)
Data Point: (4, 0.667)
Data Point: (8, 0.667)
Data Point: (8.1, 1)

TQs (100 psf 25° A-Bed 6-7°)

Model: Spline Data Point Function

Function: **Modifier Factor vs. Inclination**

Curve Fit to Data: 100 %

Segment Curvature: 0 %

Y-Intercept: 1

Data Points: **Inclination (°), Modifier Factor**

Data Point: (-90, 1)

Data Point: (5.9, 1)

Data Point: (6, 0.625)

Data Point: (7, 0.625)

Data Point: (7.1, 1)

(100 psf 25° A-Bed 6-7°)

Model: **Spline Data Point Function**

Function: **Modifier Factor vs. Inclination**

Curve Fit to Data: 100 %

Segment Curvature: 0 %

Y-Intercept: 1

Data Points: **Inclination (°), Modifier Factor**

Data Point: (-90, 1)

Data Point: (5.9, 1)

Data Point: (6, 0.444)

Data Point: (7, 0.444)

Data Point: (7.1, 1)

(100 psf 25° A-Bed 1-13°)

Model: **Spline Data Point Function**

Function: **Modifier Factor vs. Inclination**

Curve Fit to Data: 100 %

Segment Curvature: 0 %

Y-Intercept: 1

Data Points: **Inclination (°), Modifier Factor**

Data Point: (-90, 1)

Data Point: (0.9, 1)

Data Point: (1, 0.444)

Data Point: (13, 0.444)

Data Point: (13.1, 1)

TQs(100 psf 25° A-Bed 1-13°)

Model: **Spline Data Point Function**

Function: **Modifier Factor vs. Inclination**

Curve Fit to Data: 100 %

Segment Curvature: 0 %

Y-Intercept: 1

Data Points: **Inclination (°), Modifier Factor**

Data Point: (-90, 1)

Data Point: (0.9, 1)

Data Point: (1, 0.625)

Data Point: (13, 0.625)

Data Point: (13.1, 1)

Points

	X (ft)	Y (ft)
Point 1	-200	2,099
Point 2	-115	2,101
Point 3	-28	2,101
Point 4	42	2,101
Point 5	78	2,101
Point 6	138	2,137
Point 7	150	2,137
Point 8	210	2,169
Point 9	232	2,169
Point 10	261	2,173
Point 11	290	2,180
Point 12	329	2,189
Point 13	347	2,193
Point 14	412	2,198
Point 15	444	2,194
Point 16	472	2,188
Point 17	502	2,176
Point 18	523	2,171
Point 19	556	2,160
Point 20	572	2,157
Point 21	645	2,145
Point 22	687	2,139
Point 23	685	2,041
Point 24	685	1,800
Point 25	-200	1,801
Point 26	-200	1,994
Point 27	111	2,121
Point 28	687	2,133
Point 29	109	2,120
Point 30	-200	2,033
Point 31	199	2,076
Point 32	687	2,128
Point 33	88	2,101
Point 34	121	2,101
Point 35	272	2,177
Point 36	163	2,122
Point 37	165	2,123
Point 38	687	2,134
Point 39	73	2,101
Point 40	78	2,096

Point 41 | 111 | 2,096

Regions

	Material	Points	Area (ft²)
Region 1	Tmc (150 psf 17° A-Bed 4-8°)	23,24,25,26	1.9205e+005
Region 2	TQs (100 psf 25° A-Bed 6-7°)	1,30,31,32,28,36,34,41,40,39,4,3,2	32,105
Region 3	TQs (100 psf 25° A-Bed 1-13°)	22,21,20,19,18,17,16,15,14,13,12,11,35,37,38	21,235
Region 4	TQs (150 psf 11° A-Bed 4-8°)	30,26,23,32,31	55,865
Region 5	Fill	5,33,34,36,37,35,10,9,8,7,6,27,29	3,254.5
Region 6	Shear Layer	36,28,38,37	512
Region 7	Fill	39,40,41,34,33,5	202.5

Current Slip Surface

Slip Surface: 66,399
 F of S: 1.94
 Volume: 1,752.2519 ft³
 Weight: 210,270.23 lbs
 Resisting Force: 130,112.76 lbs
 Activating Force: 67,221.054 lbs
 F of S Rank (Analysis): 1 of 131,769 slip surfaces
 F of S Rank (Query): 1 of 300 slip surfaces
 Exit: (114.36353, 2,122.9932) ft
 Entry: (227.60406, 2,169) ft
 Radius: 67.44354 ft
 Center: (156.96523, 2,180.5017) ft

Slip Slices

	X (ft)	Y (ft)	PWP (psf)	Base Normal Stress (psf)	Frictional Strength (psf)	Cohesive Strength (psf)
Slice 1	116.33323	2,122.9932	0	140.068	90.961223	200
Slice 2	120.27264	2,122.9932	0	420.204	272.88367	200
Slice 3	124.21206	2,122.9932	0	700.34	454.80611	200
Slice 4	128.15147	2,122.9932	0	980.476	636.72856	200
Slice 5	132.09088	2,122.9932	0	1,260.612	818.651	200

Slice 6	136.03029	2,122.9932	0	1,540.748	1,000.5735	200
Slice 7	140	2,122.9932	0	1,680.816	1,091.5347	200
Slice 8	144	2,122.9932	0	1,680.816	1,091.5347	200
Slice 9	148	2,122.9932	0	1,680.816	1,091.5347	200
Slice 10	151.8733	2,122.9932	0	1,800.7072	1,169.3929	200
Slice 11	155.6199	2,122.9932	0	2,040.4896	1,325.1094	200
Slice 12	159.3665	2,122.9932	0	2,280.272	1,480.826	200
Slice 13	163.1131	2,122.9932	0	2,520.0544	1,636.5425	200
Slice 14	166.79313	2,122.9932	0	2,755.576	535.62971	150
Slice 15	170.39978	2,122.9932	0	2,986.4016	580.49767	150
Slice 16	173.99963	2,122.9932	0	3,216.792	625.28102	150
Slice 17	175.93471	2,123.1132	0	2,990.4133	581.27746	150
Slice 18	177.81519	2,124.7833	0	2,268.662	1,903.6334	225
Slice 19	181.30582	2,127.8832	0	2,161.3979	1,813.6282	225
Slice 20	184.79645	2,130.9832	0	2,054.1338	1,723.6229	225
Slice 21	188.28708	2,134.0832	0	1,946.8697	1,633.6176	225
Slice 22	192.02915	2,137.4065	0	1,963.6416	1,275.2038	200
Slice 23	196.02267	2,140.953	0	1,832.6896	1,190.1626	200
Slice 24	200.01619	2,144.4996	0	1,701.7376	1,105.1213	200
Slice 25	204.00972	2,148.0462	0	1,570.7856	1,020.0801	200
Slice 26	208.00324	2,151.5928	0	1,439.8337	935.03891	200
Slice 27	211.76041	2,154.9295	0	1,229.8472	798.67214	200
Slice 28	215.28122	2,158.0563	0	940.82641	610.97982	200
Slice 29	218.80203	2,161.1831	0	651.80558	423.28749	200

Slice 30	222.32284	2,164.3098	0	362.78475	235.59517	200
Slice 31	225.84366	2,167.4366	0	73.763924	47.902853	200

Section 5-5 Seismic Final with key SSA for Skyline Ranch.gsz

Section 5-5 Seismic Final with key SSA for Skyline Ranch.gsz Run By: Dr. Alexander Bykovtsev, Ph.D., P.E. 3/21/2016 1:24:10 PM

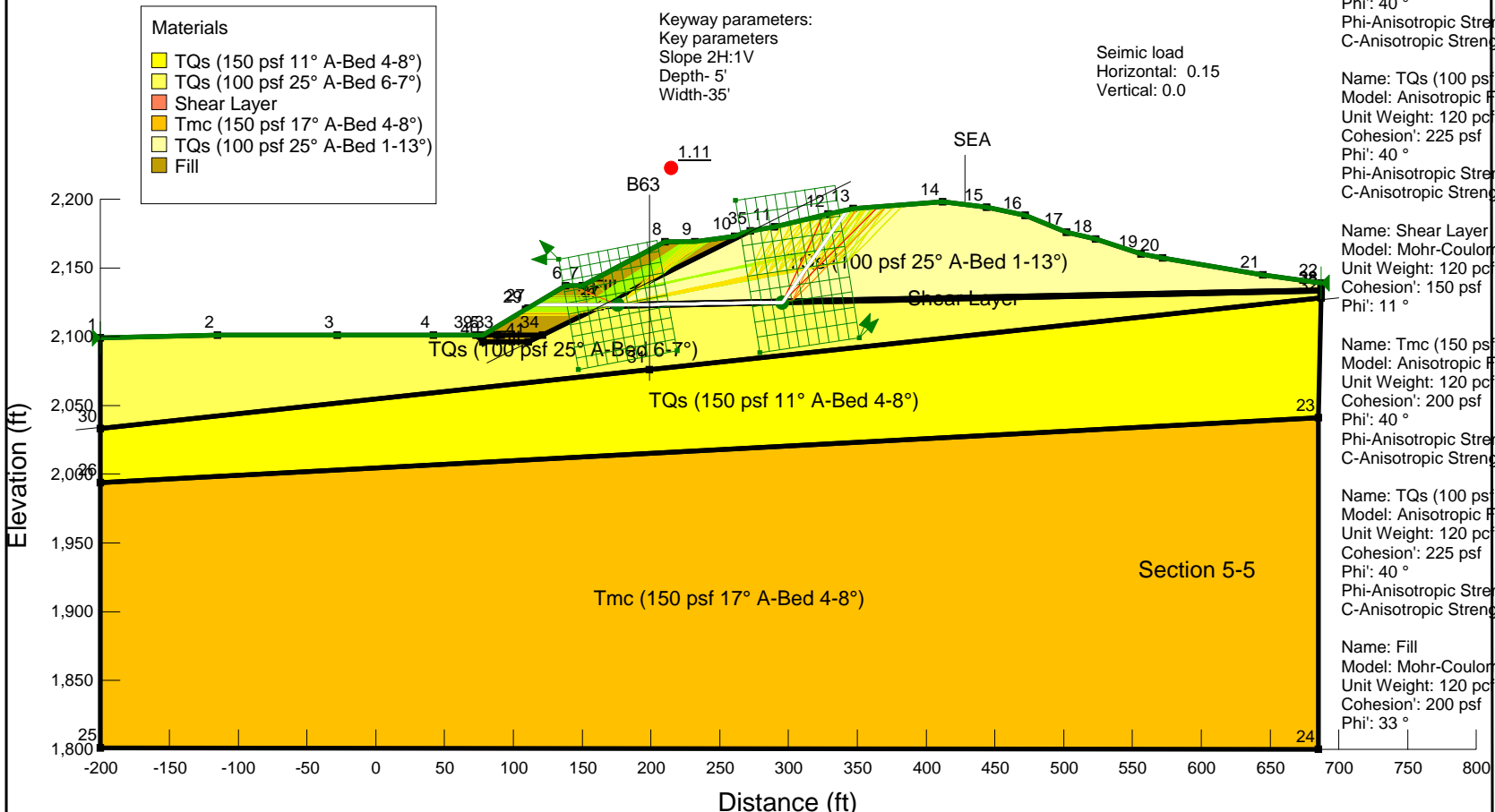

- Materials**
- TQs (150 psf 11° A-Bed 4-8°)
 - TQs (100 psf 25° A-Bed 6-7°)
 - Shear Layer
 - Tmc (150 psf 17° A-Bed 4-8°)
 - TQs (100 psf 25° A-Bed 1-13°)
 - Fill

Keyway parameters:
 Key parameters
 Slope 2H:1V
 Depth- 5'
 Width-35'

Seismic load
 Horizontal: 0.15
 Vertical: 0.0

Name: TQs (150 psf 11° A-Bed 4-8°)
 Model: Anisotropic Frn.
 Unit Weight: 120 pcf
 Cohesion: 225 psf
 Phi: 40°
 Phi-Anisotropic Strength Fn.: TQs (150 psf 11° A-Bed 4-8°)
 C-Anisotropic Strength Fn.: 150 psf 11° A-Bed 4-8°

Name: TQs (100 psf 25° A-Bed 6-7°)
 Model: Anisotropic Frn.
 Unit Weight: 120 pcf
 Cohesion: 225 psf
 Phi: 40°
 Phi-Anisotropic Strength Fn.: TQs (100 psf 25° A-Bed 6-7°)
 C-Anisotropic Strength Fn.: (100 psf 25° A-Bed 6-7°)

Name: Shear Layer
 Model: Mohr-Coulomb
 Unit Weight: 120 pcf
 Cohesion: 150 psf
 Phi: 11°

Name: Tmc (150 psf 17° A-Bed 4-8°)
 Model: Anisotropic Frn.
 Unit Weight: 120 pcf
 Cohesion: 200 psf
 Phi: 40°
 Phi-Anisotropic Strength Fn.: Tmc (150 psf 17° A-Bed 4-8°)
 C-Anisotropic Strength Fn.: 150 psf 17° A-Bed 4-8°

Name: TQs (100 psf 25° A-Bed 1-13°)
 Model: Anisotropic Frn.
 Unit Weight: 120 pcf
 Cohesion: 225 psf
 Phi: 40°
 Phi-Anisotropic Strength Fn.: TQs(100 psf 25° A-Bed 1-13°)
 C-Anisotropic Strength Fn.: (100 psf 25° A-Bed 1-13°)

Name: Fill
 Model: Mohr-Coulomb
 Unit Weight: 120 pcf
 Cohesion: 200 psf
 Phi: 33°

LGC **LGC Valley, Inc**
 GEOTECHNICAL CONSULTING
 28532 Constellation Road, Valencia, CA 91355
 Phone 661-702-8474, Fax 661-702-8475

Skyline Ranch
 Development project, Tract 60922
 Los Angeles CA

Project No: **153035-01**
 Engineer: **BAS**
 Date: **March 2016**

2 - Translational

Report generated using GeoStudio 2012. Copyright © 1991-2016 GEO-SLOPE International Ltd.

File Information

File Version: 8.15
 Title: Static Slope Stability Analyses for Skyline Ranch Development project, Tract 60922, Los Angeles CA
 Comments: Run By: Dr. Alexander Bykovtsev, Ph.D., P.E.
 Last Edited By: Alexander Bykovtsev
 Revision Number: 80
 Date: 3/21/2016
 Time: 1:24:10 PM
 Tool Version: 8.15.5.11777
 File Name: Section 5-5 Seismic Final with key SSA for Skyline Ranch.gsz
 Directory: P:\FINAL PROJECTS\PARDEE\Skyline Ranch\SLOPE RESULTS\Section 5-5 results\Latest Update 3-19-16\
 Last Solved Date: 3/21/2016
 Last Solved Time: 1:26:45 PM

Project Settings

Length(L) Units: Feet
 Time(t) Units: Seconds
 Force(F) Units: Pounds
 Pressure(p) Units: psf
 Strength Units: psf
 Unit Weight of Water: 62.4 pcf
 View: 2D
 Element Thickness: 1

Analysis Settings

2 - Translational

Kind: SLOPE/W
 Method: Janbu
 Settings
 PWP Conditions Source: (none)
 Slip Surface
 Direction of movement: Right to Left
 Use Passive Mode: No
 Slip Surface Option: Block
 Critical slip surfaces saved: 10
 Resisting Side Maximum Convex Angle: 1 °
 Driving Side Maximum Convex Angle: 5 °
 Restrict Block Crossing: No
 Optimize Critical Slip Surface Location: No
 Tension Crack

file:///P:/FINAL%20PROJECTS/PARDEE/Skyline%20Ranch/SLOPE%20RESULTS/Sect... 3/21/2016

Tension Crack Option: (none)
 F of S Distribution
 F of S Calculation Option: Constant
 Advanced
 Number of Slices: 30
 F of S Tolerance: 0.01
 Minimum Slip Surface Depth: 0.1 ft

Materials

TQs (150 psf 11° A-Bed 4-8°)

Model: Anisotropic Fn.
 Unit Weight: 120 pcf
 Cohesion': 225 psf
 Phi': 40 °
 Phi-Anisotropic Strength Fn.: TQs (150 psf 11° A-Bed 4-8°)
 C-Anisotropic Strength Fn.: 150 psf 11° A-Bed 4-8°
 Phi-B: 0 °

TQs (100 psf 25° A-Bed 6-7°)

Model: Anisotropic Fn.
 Unit Weight: 120 pcf
 Cohesion': 225 psf
 Phi': 40 °
 Phi-Anisotropic Strength Fn.: TQs (100 psf 25° A-Bed 6-7°)
 C-Anisotropic Strength Fn.: (100 psf 25° A-Bed 6-7°)
 Phi-B: 0 °

Shear Layer

Model: Mohr-Coulomb
 Unit Weight: 120 pcf
 Cohesion': 150 psf
 Phi': 11 °
 Phi-B: 0 °

Tmc (150 psf 17° A-Bed 4-8°)

Model: Anisotropic Fn.
 Unit Weight: 120 pcf
 Cohesion': 200 psf
 Phi': 40 °
 Phi-Anisotropic Strength Fn.: Tmc (150 psf 17° A-Bed 4-8°)
 C-Anisotropic Strength Fn.: 150 psf 17° A-Bed 4-8°
 Phi-B: 0 °

TQs (100 psf 25° A-Bed 1-13°)

Model: Anisotropic Fn.
 Unit Weight: 120 pcf
 Cohesion': 225 psf
 Phi': 40 °

file:///P:/FINAL%20PROJECTS/PARDEE/Skyline%20Ranch/SLOPE%20RESULTS/Sect... 3/21/2016

Phi-Anisotropic Strength Fn.: TQs(100 psf 25° A-Bed 1-13°)
C-Anisotropic Strength Fn.: (100 psf 25° A-Bed 1-13°)
Phi-B: 0°

Fill

Model: Mohr-Coulomb
Unit Weight: 120 pcf
Cohesion: 200 psf
Phi: 33°
Phi-B: 0°

Slip Surface Limits

Left Coordinate: (-200, 2,099) ft
Right Coordinate: (687, 2,139) ft

Slip Surface Block

Left Grid

Upper Left: (132.724, 2,155.9869) ft
Lower Left: (147.2387, 2,075.9597) ft
Lower Right: (218.8751, 2,089.9995) ft
X Increments: 10
Y Increments: 10
Starting Angle: 135°
Ending Angle: 180°
Angle Increments: 2

Right Grid

Upper Left: (261.4184, 2,199.03) ft
Lower Left: (279.2153, 2,088.405) ft
Lower Right: (351.5514, 2,099.3522) ft
X Increments: 10
Y Increments: 10
Starting Angle: 45°
Ending Angle: 65°
Angle Increments: 2

Seismic Coefficients

Horz Seismic Coef.: 0.15
Vert Seismic Coef.: 0

Anisotropic Strength Functions

Tmc (150 psf 17° A-Bed 4-8°)

Model: Spline Data Point Function
Function: Modifier Factor vs. Inclination
Curve Fit to Data: 100 %

Segment Curvature: 0 %
Y-Intercept: 1
Data Points: Inclination (°), Modifier Factor
Data Point: (-90, 1)
Data Point: (3.9, 1)
Data Point: (4, 0.425)
Data Point: (8, 0.425)
Data Point: (8.1, 1)

150 psf 17° A-Bed 4-8°

Model: Spline Data Point Function
Function: Modifier Factor vs. Inclination
Curve Fit to Data: 100 %
Segment Curvature: 0 %
Y-Intercept: 1
Data Points: Inclination (°), Modifier Factor
Data Point: (-90, 1)
Data Point: (3.9, 1)
Data Point: (4, 0.75)
Data Point: (8, 0.75)
Data Point: (8.1, 1)

TQs (150 psf 11° A-Bed 4-8°)

Model: Spline Data Point Function
Function: Modifier Factor vs. Inclination
Curve Fit to Data: 100 %
Segment Curvature: 0 %
Y-Intercept: 1
Data Points: Inclination (°), Modifier Factor
Data Point: (-90, 1)
Data Point: (3.9, 1)
Data Point: (4, 0.275)
Data Point: (8, 0.275)
Data Point: (8.1, 1)

150 psf 11° A-Bed 4-8°

Model: Spline Data Point Function
Function: Modifier Factor vs. Inclination
Curve Fit to Data: 100 %
Segment Curvature: 0 %
Y-Intercept: 1
Data Points: Inclination (°), Modifier Factor
Data Point: (-90, 1)
Data Point: (3.9, 1)
Data Point: (4, 0.667)
Data Point: (8, 0.667)
Data Point: (8.1, 1)

TQs (100 psf 25° A-Bed 6-7°)

Model: Spline Data Point Function

Function: **Modifier Factor vs. Inclination**

Curve Fit to Data: 100 %

Segment Curvature: 0 %

Y-Intercept: 1

Data Points: **Inclination (°), Modifier Factor**

Data Point: (-90, 1)

Data Point: (5.9, 1)

Data Point: (6, 0.625)

Data Point: (7, 0.625)

Data Point: (7.1, 1)

(100 psf 25° A-Bed 6-7°)

Model: **Spline Data Point Function**

Function: **Modifier Factor vs. Inclination**

Curve Fit to Data: 100 %

Segment Curvature: 0 %

Y-Intercept: 1

Data Points: **Inclination (°), Modifier Factor**

Data Point: (-90, 1)

Data Point: (5.9, 1)

Data Point: (6, 0.444)

Data Point: (7, 0.444)

Data Point: (7.1, 1)

(100 psf 25° A-Bed 1-13°)

Model: **Spline Data Point Function**

Function: **Modifier Factor vs. Inclination**

Curve Fit to Data: 100 %

Segment Curvature: 0 %

Y-Intercept: 1

Data Points: **Inclination (°), Modifier Factor**

Data Point: (-90, 1)

Data Point: (0.9, 1)

Data Point: (1, 0.444)

Data Point: (13, 0.444)

Data Point: (13.1, 1)

TQs(100 psf 25° A-Bed 1-13°)

Model: **Spline Data Point Function**

Function: **Modifier Factor vs. Inclination**

Curve Fit to Data: 100 %

Segment Curvature: 0 %

Y-Intercept: 1

Data Points: **Inclination (°), Modifier Factor**

Data Point: (-90, 1)

Data Point: (0.9, 1)

Data Point: (1, 0.625)

Data Point: (13, 0.625)

Data Point: (13.1, 1)

Points

	X (ft)	Y (ft)
Point 1	-200	2,099
Point 2	-115	2,101
Point 3	-28	2,101
Point 4	42	2,101
Point 5	78	2,101
Point 6	138	2,137
Point 7	150	2,137
Point 8	210	2,169
Point 9	232	2,169
Point 10	261	2,173
Point 11	290	2,180
Point 12	329	2,189
Point 13	347	2,193
Point 14	412	2,198
Point 15	444	2,194
Point 16	472	2,188
Point 17	502	2,176
Point 18	523	2,171
Point 19	556	2,160
Point 20	572	2,157
Point 21	645	2,145
Point 22	687	2,139
Point 23	685	2,041
Point 24	685	1,800
Point 25	-200	1,801
Point 26	-200	1,994
Point 27	111	2,121
Point 28	687	2,133
Point 29	109	2,120
Point 30	-200	2,033
Point 31	199	2,076
Point 32	687	2,128
Point 33	88	2,101
Point 34	121	2,101
Point 35	272	2,177
Point 36	163	2,122
Point 37	165	2,123
Point 38	687	2,134
Point 39	73	2,101
Point 40	78	2,096

Point 41 | 111 | 2,096

Regions

	Material	Points	Area (ft²)
Region 1	Tmc (150 psf 17° A-Bed 4-8°)	23,24,25,26	1.9205e+005
Region 2	TQs (100 psf 25° A-Bed 6-7°)	1,30,31,32,28,36,34,41,40,39,4,3,2	32,105
Region 3	TQs (100 psf 25° A-Bed 1-13°)	22,21,20,19,18,17,16,15,14,13,12,11,35,37,38	21,235
Region 4	TQs (150 psf 11° A-Bed 4-8°)	30,26,23,32,31	55,865
Region 5	Fill	5,33,34,36,37,35,10,9,8,7,6,27,29	3,254.5
Region 6	Shear Layer	36,28,38,37	512
Region 7	Fill	39,40,41,34,33,5	202.5

Current Slip Surface

Slip Surface: 66,176
 F of S: 1.11
 Volume: 7,646.2846 ft³
 Weight: 917,554.15 lbs
 Resisting Force: 278,153.03 lbs
 Activating Force: 250,094.99 lbs
 F of S Rank (Analysis): 1 of 131,769 slip surfaces
 F of S Rank (Query): 1 of 300 slip surfaces
 Exit: (114.36353, 2,122.9932) ft
 Entry: (342.59158, 2,192.0204) ft
 Radius: 116.23557 ft
 Center: (212.8197, 2,209.2771) ft

Slip Slices

	X (ft)	Y (ft)	PWP (psf)	Base Normal Stress (psf)	Frictional Strength (psf)	Cohesive Strength (psf)
Slice 1	118.30294	2,122.9932	0	280.136	181.92245	200
Slice 2	126.18176	2,122.9932	0	840.408	545.76734	200
Slice 3	134.06059	2,122.9932	0	1,400.68	909.61223	200
Slice 4	141	2,122.9932	0	1,680.816	1,091.5347	200
Slice 5	147	2,122.9932	0	1,680.816	1,091.5347	200

Slice 6	153.7466	2,122.9932	0	1,920.5984	1,247.2512	200
Slice 7	161.2466	2,122.9932	0	2,400.5984	1,558.9668	200
Slice 8	170.39978	2,122.9932	0	2,986.4016	580.49767	150
Slice 9	180.07461	2,123.0604	0	3,585.5716	696.96452	150
Slice 10	188.62472	2,123.1949	0	4,115.1923	799.91236	150
Slice 11	197.17483	2,123.3293	0	4,644.813	902.86019	150
Slice 12	205.72494	2,123.4638	0	5,174.4337	1,005.808	150
Slice 13	213.66667	2,123.5886	0	5,432.3441	1,055.9407	150
Slice 14	221	2,123.704	0	5,418.5443	1,053.2583	150
Slice 15	228.33333	2,123.8193	0	5,404.7445	1,050.5759	150
Slice 16	235.625	2,123.9339	0	5,450.8589	1,059.5396	150
Slice 17	242.875	2,124.0479	0	5,556.8876	1,080.1495	150
Slice 18	250.125	2,124.1619	0	5,662.9163	1,100.7594	150
Slice 19	257.375	2,124.2759	0	5,768.945	1,121.3693	150
Slice 20	266.5	2,124.4194	0	6,050.9529	1,176.1861	150
Slice 21	276.5	2,124.5767	0	6,361.2322	1,236.4983	150
Slice 22	285.5	2,124.7182	0	6,523.8037	1,268.099	150
Slice 23	292.78853	2,124.8328	0	6,676.8515	1,297.8485	150
Slice 24	295.88798	2,125.3207	0	5,229.4801	1,016.508	150
Slice 25	300.29903	2,131.6203	0	2,795.7163	2,345.8846	225
Slice 26	308.49931	2,143.3315	0	2,228.0047	1,869.5179	225
Slice 27	316.69958	2,155.0428	0	1,660.2931	1,393.1513	225
Slice 28	324.89986	2,166.754	0	1,092.5815	916.78469	225
Slice 29	332.39789	2,177.4623	0	571.80756	479.80351	225

Slice 30	339.19368	2,187.1677	0	97.971414	82.207778	225
-------------	-----------	------------	---	-----------	-----------	-----

Section 5-5 Static Temporary Final without key SSA for Skyline Ranch.gsz

Section 5-5 Static Temporary Final without key SSA for Skyline Ranch.gsz Run By: Dr. Alexander Bykovtsev, Ph.D., P.E. 3/21/2016 1:43:45 PM

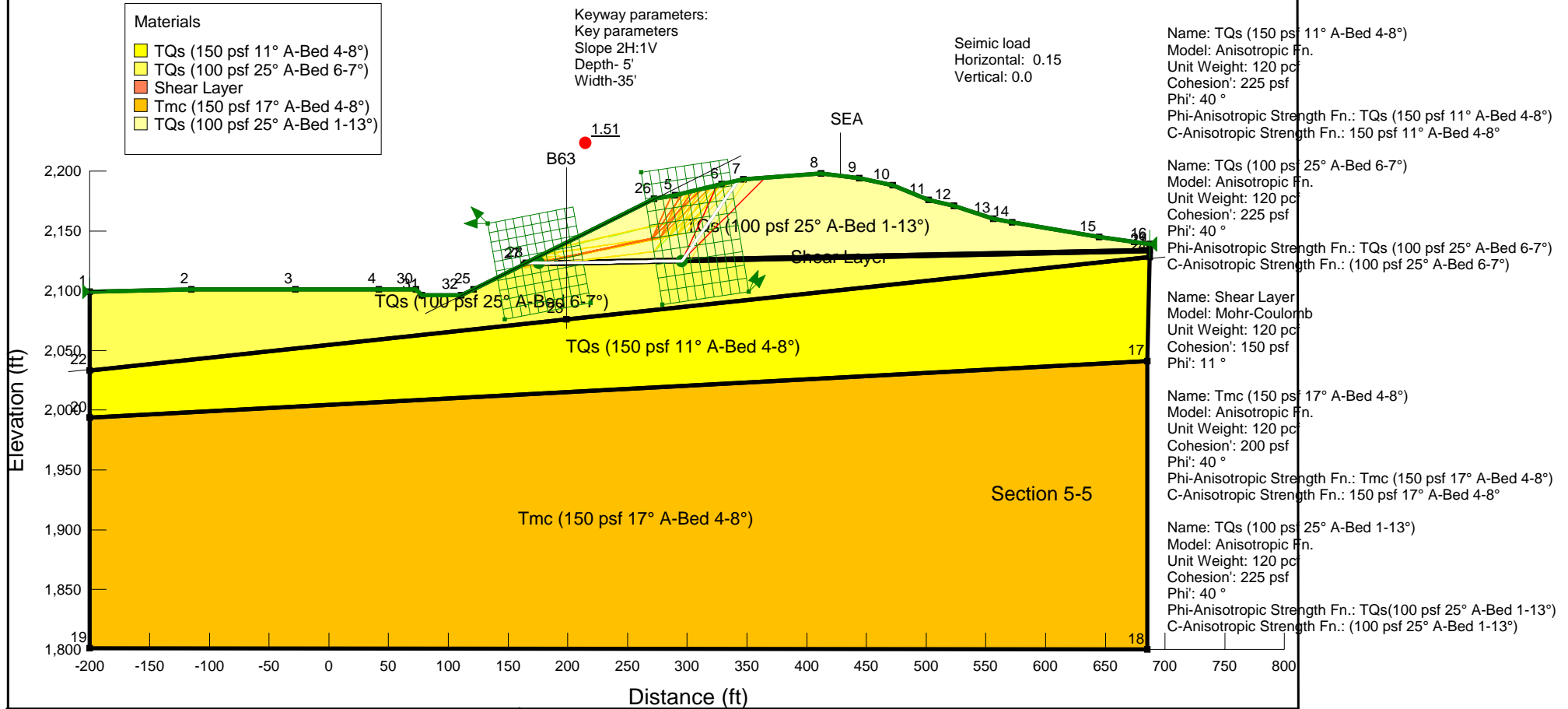

LGC Valley, Inc
GEOTECHNICAL CONSULTING
28532 Constellation Road, Valencia, CA 91355
Phone 661-702-8474, Fax 661-702-8475

Skyline Ranch
Development project, Tract 60922
Los Angeles CA

Project No: **153035-01**
Engineer: **BAS**
Date: **March 2016**

2 - Translational

Report generated using GeoStudio 2012. Copyright © 1991-2016 GEO-SLOPE International Ltd.

File Information

File Version: 8.15
 Title: Static Slope Stability Analyses for Skyline Ranch Development project, Tract 60922, Los Angeles CA
 Comments: Run By: Dr. Alexander Bykovtsev, Ph.D., P.E.
 Last Edited By: Alexander Bykovtsec
 Revision Number: 84
 Date: 3/21/2016
 Time: 1:43:45 PM
 Tool Version: 8.15.5.11777
 File Name: Section 5-5 Static Temporary Final without key SSA for Skyline Ranch.gsz
 Directory: P:\FINAL PROJECTS\PARDEE\Skyline Ranch\SLOPE RESULTS\Section 5-5 results\Latest Update 3-19-16\
 Last Solved Date: 3/21/2016
 Last Solved Time: 1:44:16 PM

Project Settings

Length(L) Units: Feet
 Time(t) Units: Seconds
 Force(F) Units: Pounds
 Pressure(p) Units: psf
 Strength Units: psf
 Unit Weight of Water: 62.4 pcf
 View: 2D
 Element Thickness: 1

Analysis Settings

2 - Translational

Kind: SLOPE/W
 Method: Janbu
 Settings
 PWP Conditions Source: (none)
 Slip Surface
 Direction of movement: Right to Left
 Use Passive Mode: No
 Slip Surface Option: Block
 Critical slip surfaces saved: 10
 Resisting Side Maximum Convex Angle: 1 °
 Driving Side Maximum Convex Angle: 5 °
 Restrict Block Crossing: No
 Optimize Critical Slip Surface Location: No
 Tension Crack

file:///P:/FINAL%20PROJECTS/PARDEE/Skyline%20Ranch/SLOPE%20RESULTS/Sect... 3/21/2016

Tension Crack Option: (none)
 F of S Distribution
 F of S Calculation Option: Constant
 Advanced
 Number of Slices: 30
 F of S Tolerance: 0.01
 Minimum Slip Surface Depth: 0.1 ft

Materials

TQs (150 psf 11° A-Bed 4-8°)

Model: Anisotropic Fn.
 Unit Weight: 120 pcf
 Cohesion': 225 psf
 Phi': 40 °
 Phi-Anisotropic Strength Fn.: TQs (150 psf 11° A-Bed 4-8°)
 C-Anisotropic Strength Fn.: 150 psf 11° A-Bed 4-8°
 Phi-B: 0 °

TQs (100 psf 25° A-Bed 6-7°)

Model: Anisotropic Fn.
 Unit Weight: 120 pcf
 Cohesion': 225 psf
 Phi': 40 °
 Phi-Anisotropic Strength Fn.: TQs (100 psf 25° A-Bed 6-7°)
 C-Anisotropic Strength Fn.: (100 psf 25° A-Bed 6-7°)
 Phi-B: 0 °

Shear Layer

Model: Mohr-Coulomb
 Unit Weight: 120 pcf
 Cohesion': 150 psf
 Phi': 11 °
 Phi-B: 0 °

Tmc (150 psf 17° A-Bed 4-8°)

Model: Anisotropic Fn.
 Unit Weight: 120 pcf
 Cohesion': 200 psf
 Phi': 40 °
 Phi-Anisotropic Strength Fn.: Tmc (150 psf 17° A-Bed 4-8°)
 C-Anisotropic Strength Fn.: 150 psf 17° A-Bed 4-8°
 Phi-B: 0 °

TQs (100 psf 25° A-Bed 1-13°)

Model: Anisotropic Fn.
 Unit Weight: 120 pcf
 Cohesion': 225 psf
 Phi': 40 °

file:///P:/FINAL%20PROJECTS/PARDEE/Skyline%20Ranch/SLOPE%20RESULTS/Sect... 3/21/2016

Phi-Anisotropic Strength Fn.: TQs(100 psf 25° A-Bed 1-13°)
 C-Anisotropic Strength Fn.: (100 psf 25° A-Bed 1-13°)
 Phi-B: 0°

Slip Surface Limits

Left Coordinate: (-200, 2,099) ft
 Right Coordinate: (687, 2,139) ft

Slip Surface Block

Left Grid

Upper Left: (132.724, 2,155.9869) ft
 Lower Left: (147.2387, 2,075.9597) ft
 Lower Right: (218.8751, 2,089.9995) ft
 X Increments: 10
 Y Increments: 10
 Starting Angle: 135°
 Ending Angle: 180°
 Angle Increments: 2

Right Grid

Upper Left: (261.4184, 2,199.03) ft
 Lower Left: (279.2153, 2,088.405) ft
 Lower Right: (351.5514, 2,099.3522) ft
 X Increments: 10
 Y Increments: 10
 Starting Angle: 45°
 Ending Angle: 65°
 Angle Increments: 2

Seismic Coefficients

Horz Seismic Coef.: 0
 Vert Seismic Coef.: 0

Anisotropic Strength Functions

Tmc (150 psf 17° A-Bed 4-8°)

Model: Spline Data Point Function
 Function: Modifier Factor vs. Inclination
 Curve Fit to Data: 100 %
 Segment Curvature: 0 %
 Y-Intercept: 1
 Data Points: Inclination (°), Modifier Factor
 Data Point: (-90, 1)
 Data Point: (3.9, 1)
 Data Point: (4, 0.425)
 Data Point: (8, 0.425)

Data Point: (8.1, 1)

150 psf 17° A-Bed 4-8°

Model: Spline Data Point Function
 Function: Modifier Factor vs. Inclination
 Curve Fit to Data: 100 %
 Segment Curvature: 0 %
 Y-Intercept: 1
 Data Points: Inclination (°), Modifier Factor
 Data Point: (-90, 1)
 Data Point: (3.9, 1)
 Data Point: (4, 0.75)
 Data Point: (8, 0.75)
 Data Point: (8.1, 1)

TQs (150 psf 11° A-Bed 4-8°)

Model: Spline Data Point Function
 Function: Modifier Factor vs. Inclination
 Curve Fit to Data: 100 %
 Segment Curvature: 0 %
 Y-Intercept: 1
 Data Points: Inclination (°), Modifier Factor
 Data Point: (-90, 1)
 Data Point: (3.9, 1)
 Data Point: (4, 0.275)
 Data Point: (8, 0.275)
 Data Point: (8.1, 1)

150 psf 11° A-Bed 4-8°

Model: Spline Data Point Function
 Function: Modifier Factor vs. Inclination
 Curve Fit to Data: 100 %
 Segment Curvature: 0 %
 Y-Intercept: 1
 Data Points: Inclination (°), Modifier Factor
 Data Point: (-90, 1)
 Data Point: (3.9, 1)
 Data Point: (4, 0.667)
 Data Point: (8, 0.667)
 Data Point: (8.1, 1)

TQs (100 psf 25° A-Bed 6-7°)

Model: Spline Data Point Function
 Function: Modifier Factor vs. Inclination
 Curve Fit to Data: 100 %
 Segment Curvature: 0 %
 Y-Intercept: 1
 Data Points: Inclination (°), Modifier Factor
 Data Point: (-90, 1)
 Data Point: (5.9, 1)

Data Point: (6, 0.625)
 Data Point: (7, 0.625)
 Data Point: (7.1, 1)

(100 psf 25° A-Bed 6-7°)

Model: Spline Data Point Function
 Function: Modifier Factor vs. Inclination
 Curve Fit to Data: 100 %
 Segment Curvature: 0 %
 Y-Intercept: 1
 Data Points: Inclination (°), Modifier Factor
 Data Point: (-90, 1)
 Data Point: (5.9, 1)
 Data Point: (6, 0.444)
 Data Point: (7, 0.444)
 Data Point: (7.1, 1)

(100 psf 25° A-Bed 1-13°)

Model: Spline Data Point Function
 Function: Modifier Factor vs. Inclination
 Curve Fit to Data: 100 %
 Segment Curvature: 0 %
 Y-Intercept: 1
 Data Points: Inclination (°), Modifier Factor
 Data Point: (-90, 1)
 Data Point: (0.9, 1)
 Data Point: (1, 0.444)
 Data Point: (13, 0.444)
 Data Point: (13.1, 1)

TQs(100 psf 25° A-Bed 1-13°)

Model: Spline Data Point Function
 Function: Modifier Factor vs. Inclination
 Curve Fit to Data: 100 %
 Segment Curvature: 0 %
 Y-Intercept: 1
 Data Points: Inclination (°), Modifier Factor
 Data Point: (-90, 1)
 Data Point: (0.9, 1)
 Data Point: (1, 0.625)
 Data Point: (13, 0.625)
 Data Point: (13.1, 1)

Points

	X (ft)	Y (ft)
Point 1	-200	2,099
Point 2	-115	2,101
Point 3	-28	2,101

Point 4	42	2,101
Point 5	290	2,180
Point 6	329	2,189
Point 7	347	2,193
Point 8	412	2,198
Point 9	444	2,194
Point 10	472	2,188
Point 11	502	2,176
Point 12	523	2,171
Point 13	556	2,160
Point 14	572	2,157
Point 15	645	2,145
Point 16	687	2,139
Point 17	685	2,041
Point 18	685	1,800
Point 19	-200	1,801
Point 20	-200	1,994
Point 21	687	2,133
Point 22	-200	2,033
Point 23	199	2,076
Point 24	687	2,128
Point 25	121	2,101
Point 26	272	2,177
Point 27	163	2,122
Point 28	165	2,123
Point 29	687	2,134
Point 30	73	2,101
Point 31	78	2,096
Point 32	111	2,096

Regions

	Material	Points	Area (ft²)
Region 1	Tmc (150 psf 17° A-Bed 4-8°)	17,18,19,20	1.9205e+005
Region 2	TQs (100 psf 25° A-Bed 6-7°)	1,22,23,24,21,27,25,32,31,30,4,3,2	32,105
Region 3	TQs (100 psf 25° A-Bed 1-13°)	16,15,14,13,12,11,10,9,8,7,6,5,26,28,29	21,235
Region 4	TQs (150 psf 11° A-Bed 4-8°)	22,20,17,24,23	55,865
Region 5	Shear Layer	27,21,29,28	512

Current Slip Surface

Slip Surface: 66,176
 F of S: 1.51
 Volume: 5,425.5653 ft³

Weight: 651,067.84 lbs
 Resisting Force: 194,122.75 lbs
 Activating Force: 128,297.82 lbs
 F of S Rank (Analysis): 1 of 131,769 slip surfaces
 F of S Rank (Query): 1 of 300 slip surfaces
 Exit: (164.9864, 2,122.9932) ft
 Entry: (342.59158, 2,192.0204) ft
 Radius: 102.6563 ft
 Center: (233.66818, 2,209.2771) ft

Slip Slices

	X (ft)	Y (ft)	PWP (psf)	Base Normal Stress (psf)	Frictional Strength (psf)	Cohesive Strength (psf)
Slice 1	164.9932	2,122.9932	0	0.408	0.079307166	150
Slice 2	167.69989	2,122.9932	0	164.32321	31.941196	150
Slice 3	173.09966	2,122.9932	0	491.33762	95.506358	150
Slice 4	178.80581	2,123.0405	0	827.99585	160.94609	150
Slice 5	184.81834	2,123.135	0	1,180.0611	229.38063	150
Slice 6	190.83087	2,123.2296	0	1,532.1263	297.81518	150
Slice 7	196.8434	2,123.3241	0	1,884.1915	366.24972	150
Slice 8	202.85593	2,123.4187	0	2,236.2567	434.68426	150
Slice 9	208.86845	2,123.5132	0	2,588.3219	503.1188	150
Slice 10	214.88098	2,123.6077	0	2,940.3871	571.55335	150
Slice 11	220.89351	2,123.7023	0	3,292.4523	639.98789	150
Slice 12	226.90604	2,123.7968	0	3,644.5175	708.42243	150
Slice 13	232.91857	2,123.8914	0	3,996.5827	776.85697	150
Slice 14	238.9311	2,123.9859	0	4,348.6479	845.29152	150
Slice 15	244.94362	2,124.0805	0	4,700.7131	913.72606	150
Slice 16	250.95615	2,124.175	0	5,052.7783	982.1606	150
Slice 17	256.96868	2,124.2696	0	5,404.8435	1,050.5951	150
Slice	262.98121	2,124.3641	0	5,756.9087	1,119.0297	150

18						
Slice 19	268.99374	2,124.4586	0	6,108.9739	1,187.4642	150
Slice 20	275	2,124.5531	0	6,339.2358	1,232.2226	150
Slice 21	281	2,124.6474	0	6,447.6945	1,253.3049	150
Slice 22	287	2,124.7418	0	6,556.1533	1,274.3871	150
Slice 23	292.78853	2,124.8328	0	6,682.1963	1,298.8874	150
Slice 24	295.88798	2,125.3207	0	5,560.5139	1,080.8544	150
Slice 25	298.93232	2,129.6685	0	3,386.7557	2,841.8255	225
Slice 26	304.39917	2,137.4759	0	2,948.7961	2,474.3338	225
Slice 27	309.86602	2,145.2834	0	2,510.8366	2,106.8421	225
Slice 28	315.33287	2,153.0909	0	2,072.877	1,739.3504	225
Slice 29	320.79972	2,160.8984	0	1,634.9175	1,371.8587	225
Slice 30	326.26657	2,168.7058	0	1,196.958	1,004.367	225
Slice 31	332.39789	2,177.4623	0	703.82351	590.57804	225
Slice 32	339.19368	2,187.1677	0	155.51415	130.49187	225

Section 7-7 Static Final with keyway SSA for Skyline Ranch.gsz

Section 7-7 Static Final with keyway SSA for Skyline Ranch.gsz Run By: Dr. Alexander Bykovtsev, Ph.D., P.E. 3/21/2016 3:13:19 PM

Name: TQs150psf-17° bedding 4-8°
 Model: Anisotropic Fn.
 Unit Weight: 120 pcf
 Cohesion: 225 psf
 Phi: 40°
 Phi-Anisotropic Strength Fn.: TQs150psf-17° bedding 4-8°
 C-Anisotropic Strength Fn.: 150psf-17° bedding 4-8°

Materials

- TQs150psf-17° bedding 4-8°
- Fill
- TQs150psf-11° bedding 4-8°

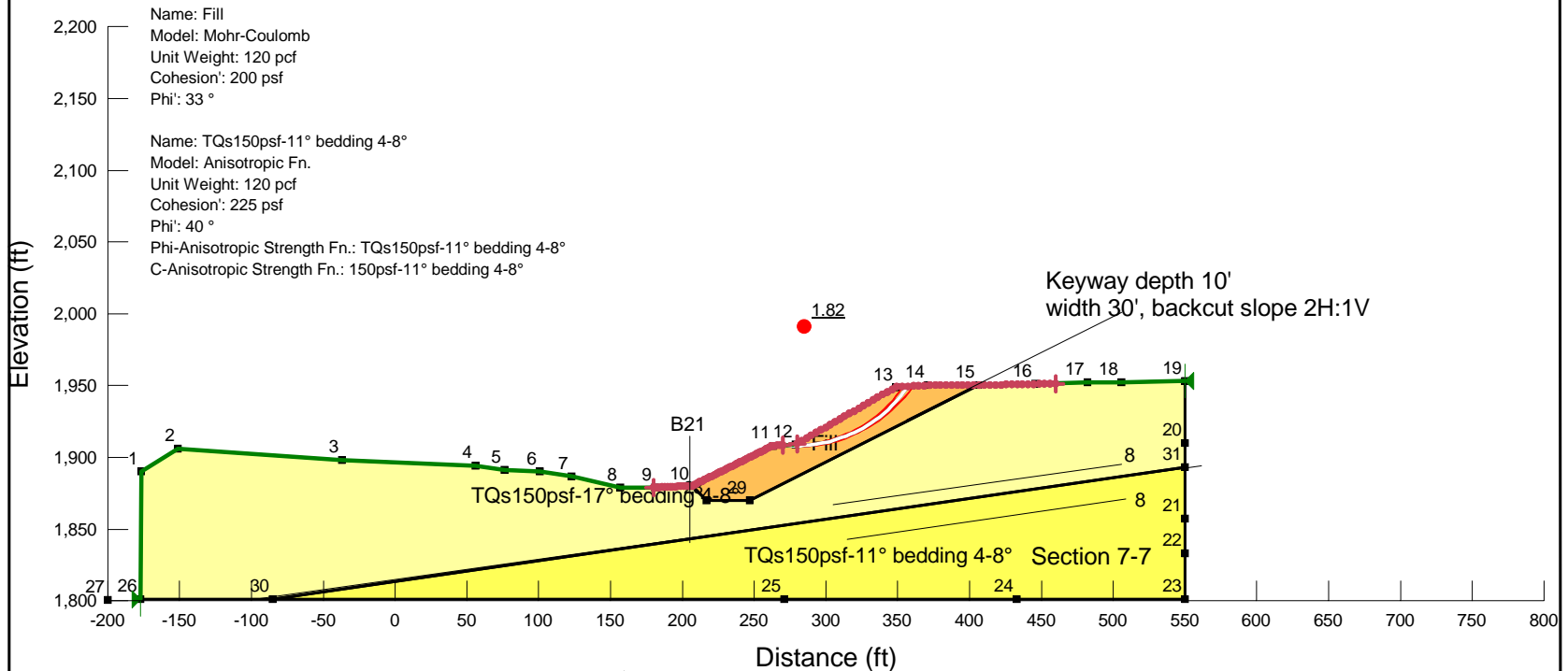

LGC Valley, Inc
 GEOTECHNICAL CONSULTING
 28532 Constellation Road, Valencia, CA 91355
 Phone 661-702-8474, Fax 661-702-8475

Skyline Ranch
 Development project, Tract 60922
 Los Angeles CA

Project No: **153035-01**
 Engineer: **BAS**
 Date: **March 2016**

1 - Circular Mode of Failure

Report generated using GeoStudio 2012. Copyright © 1991-2015 GEO-SLOPE International Ltd.

File Information

File Version: 8.15
 Title: Static Slope Stability Analyses for Skyline Ranch Development project, Tract 60922, Los Angeles CA
 Comments: Run By: Dr. Alexander Bykovtsev, Ph.D., P.E.
 Last Edited By: Alexander Bykovtsev
 Revision Number: 102
 Date: 3/21/2016
 Time: 3:13:19 PM
 Tool Version: 8.15.1.11236
 File Name: Section 7-7 Static Final with keyway SSA for Skyline Ranch.gsd
 Directory: G:\SLOPE RESULTS\Section 7-7 results\updated 3-21-2016\
 Last Solved Date: 3/21/2016
 Last Solved Time: 3:13:34 PM

Project Settings

Length(L) Units: Feet
 Time(t) Units: Seconds
 Force(F) Units: Pounds
 Pressure(p) Units: psf
 Strength Units: psf
 Unit Weight of Water: 62.4 pcf
 View: 2D
 Element Thickness: 1

Analysis Settings

1 - Circular Mode of Failure

Kind: [SLOPE/W](#)
 Method: [Bishop](#)
 Settings
 PWP Conditions Source: [\(none\)](#)
 Slip Surface
 Direction of movement: [Right to Left](#)
 Use Passive Mode: [No](#)
 Slip Surface Option: [Entry and Exit](#)
 Critical slip surfaces saved: 1
 Resisting Side Maximum Convex Angle: 1 °
 Driving Side Maximum Convex Angle: 5 °
 Optimize Critical Slip Surface Location: [No](#)
 Tension Crack
 Tension Crack Option: [\(none\)](#)

file:///G:/SLOPE%20RESULTS/Section%207-7%20results/updated%203-21-2016/section... 3/21/2016

F of S Distribution
 F of S Calculation Option: [Constant](#)
 Advanced
 Number of Slices: 30
 F of S Tolerance: 0.01
 Minimum Slip Surface Depth: 0.1 ft

Materials

TQs150psf-17° bedding 4-8°

Model: [Anisotropic Fn.](#)
 Unit Weight: 120 pcf
 Cohesion': 225 psf
 Phi': 40 °
 Phi-Anisotropic Strength Fn.: TQs150psf-17° bedding 4-8°
 C-Anisotropic Strength Fn.: 150psf-17° bedding 4-8°
 Phi-B: 0 °

Fill

Model: [Mohr-Coulomb](#)
 Unit Weight: 120 pcf
 Cohesion': 200 psf
 Phi': 33 °
 Phi-B: 0 °

TQs150psf-11° bedding 4-8°

Model: [Anisotropic Fn.](#)
 Unit Weight: 120 pcf
 Cohesion': 225 psf
 Phi': 40 °
 Phi-Anisotropic Strength Fn.: TQs150psf-11° bedding 4-8°
 C-Anisotropic Strength Fn.: 150psf-11° bedding 4-8°
 Phi-B: 0 °

Slip Surface Entry and Exit

Left Projection: [Range](#)
 Left-Zone Left Coordinate: (180, 1,879) ft
 Left-Zone Right Coordinate: (270, 1,908.4375) ft
 Left-Zone Increment: 50
 Right Projection: [Range](#)
 Right-Zone Left Coordinate: (280, 1,909.5714) ft
 Right-Zone Right Coordinate: (460, 1,951.3889) ft
 Right-Zone Increment: 50
 Radius Increments: 50

Slip Surface Limits

file:///G:/SLOPE%20RESULTS/Section%207-7%20results/updated%203-21-2016/section... 3/21/2016

Left Coordinate: (-177.5082, 1,801) ft
 Right Coordinate: (550, 1,953) ft

Seismic Coefficients

Horz Seismic Coef.: 0
 Vert Seismic Coef.: 0

Anisotropic Strength Functions

TQs150psf-17° bedding 4-8°

Model: Spline Data Point Function
 Function: Modifier Factor vs. Inclination
 Curve Fit to Data: 100 %
 Segment Curvature: 0 %

Y-Intercept: 1

Data Points: Inclination (°), Modifier Factor

- Data Point: (-90, 1)
- Data Point: (3.9, 1)
- Data Point: (4, 0.425)
- Data Point: (8, 0.425)
- Data Point: (8.1, 1)

150psf-17° bedding 4-8°

Model: Spline Data Point Function
 Function: Modifier Factor vs. Inclination
 Curve Fit to Data: 100 %
 Segment Curvature: 0 %

Y-Intercept: 1

Data Points: Inclination (°), Modifier Factor

- Data Point: (-90, 1)
- Data Point: (3.9, 1)
- Data Point: (4, 0.667)
- Data Point: (8, 0.667)
- Data Point: (8.1, 1)

TQs150psf-11° bedding 4-8°

Model: Spline Data Point Function
 Function: Modifier Factor vs. Inclination
 Curve Fit to Data: 100 %
 Segment Curvature: 0 %

Y-Intercept: 1

Data Points: Inclination (°), Modifier Factor

- Data Point: (-90, 1)
- Data Point: (3.9, 1)
- Data Point: (4, 0.275)
- Data Point: (8, 0.275)
- Data Point: (8.1, 1)

150psf-11° bedding 4-8°

Model: Spline Data Point Function
 Function: Modifier Factor vs. Inclination
 Curve Fit to Data: 100 %
 Segment Curvature: 0 %

Y-Intercept: 1

Data Points: Inclination (°), Modifier Factor

- Data Point: (-90, 1)
- Data Point: (3.9, 1)
- Data Point: (4, 0.667)
- Data Point: (8, 0.667)
- Data Point: (8.1, 1)

Points

	X (ft)	Y (ft)
Point 1	-177	1,890
Point 2	-151	1,906
Point 3	-37	1,898
Point 4	56	1,894
Point 5	76	1,891
Point 6	101	1,890
Point 7	123	1,887
Point 8	157	1,879
Point 9	181	1,879
Point 10	207	1,880
Point 11	263	1,908
Point 12	279	1,909
Point 13	349	1,949
Point 14	371	1,950
Point 15	406	1,950
Point 16	446	1,951
Point 17	482	1,952
Point 18	506	1,952
Point 19	550	1,953
Point 20	550	1,910
Point 21	550	1,857
Point 22	550	1,833
Point 23	550	1,801
Point 24	433	1,801
Point 25	271	1,801
Point 26	-177.5082	1,801
Point 27	-200	1,800.4977
Point 28	217	1,870
Point 29	247	1,870

Point 30	-85	1,801
Point 31	550	1,893

Regions

	Material	Points	Area (ft ²)
Region 1	TQs150psf-17° bedding 4-8°	1,26,30,31,20,19,18,17,16,15,29,28,10,9,8,7,6,5,4,3,2	48,206
Region 2	Fill	10,28,29,15,14,13,12,11	4,229
Region 3	TQs150psf-11° bedding 4-8°	30,25,24,23,22,21,31	29,210

Current Slip Surface

Slip Surface: 131,245
 F of S: 1.82
 Volume: 841.81909 ft³
 Weight: 101,018.29 lbs
 Resisting Moment: 7,722,657.4 lbs-ft
 Activating Moment: 4,236,948.8 lbs-ft
 F of S Rank (Analysis): 1 of 132,651 slip surfaces
 F of S Rank (Query): 1 of 20 slip surfaces
 Exit: (270, 1,908.4375) ft
 Entry: (357.15601, 1,949.3707) ft
 Radius: 95.097239 ft
 Center: (278.71534, 2,003.1345) ft

Slip Slices

	X (ft)	Y (ft)	PWP (psf)	Base Normal Stress (psf)	Frictional Strength (psf)	Cohesive Strength (psf)
Slice 1	271.5	1,908.3233	0	34.210662	22.216663	200
Slice 2	274.5	1,908.1426	0	75.182007	48.823766	200
Slice 3	277.5	1,908.0569	0	103.79506	67.405298	200
Slice 4	280.45833	1,908.0645	0	208.89492	135.65794	200
Slice 5	283.375	1,908.1627	0	388.31985	252.17786	200
Slice 6	286.29167	1,908.3509	0	553.40693	359.38666	200
Slice 7	289.20833	1,908.6294	0	704.4939	457.50369	200

Slice 8	292.125	1,908.999	0	841.86	546.71028	200
Slice 9	295.04167	1,909.4609	0	965.7303	627.15259	200
Slice 10	297.95833	1,910.0165	0	1,076.279	698.94376	200
Slice 11	300.875	1,910.6673	0	1,173.6319	762.16549	200
Slice 12	303.79167	1,911.4155	0	1,257.8681	816.86907	200
Slice 13	306.70833	1,912.2635	0	1,329.0204	863.07595	200
Slice 14	309.625	1,913.214	0	1,387.0762	900.77782	200
Slice 15	312.54167	1,914.2704	0	1,431.976	929.9361	200
Slice 16	315.45833	1,915.4365	0	1,463.6126	950.48111	200
Slice 17	318.375	1,916.7168	0	1,481.8282	962.31047	200
Slice 18	321.29167	1,918.1164	0	1,486.4117	965.28702	200
Slice 19	324.20833	1,919.6413	0	1,477.0939	959.23597	200
Slice 20	327.125	1,921.2986	0	1,453.542	943.9412	200
Slice 21	330.04167	1,923.0965	0	1,415.3524	919.14058	200
Slice 22	332.95833	1,925.0446	0	1,362.0415	884.52007	200
Slice 23	335.875	1,927.1547	0	1,293.0342	839.70626	200
Slice 24	338.79167	1,929.4407	0	1,207.6502	784.25719	200
Slice 25	341.70833	1,931.9195	0	1,105.0854	717.65082	200
Slice 26	344.625	1,934.6122	0	984.3908	639.27086	200
Slice 27	347.54167	1,937.5453	0	844.44603	548.38966	200
Slice 28	350.45833	1,940.6338	0	629.24686	408.63769	200
Slice 29	353.375	1,943.8984	0	343.5332	223.09307	200
Slice 30	355.29167	1,947.4878	0	44.75417	29.063698	200

Section 7-7 Seismic Final with keyway SSA for Skyline Ranch.gsz

Section 7-7 Seismic Final with keyway SSA for Skyline Ranch.gsz Run By: Dr. Alexander Bykovtsev, Ph.D., P.E. 3/21/2016 3:03:48 PM

Name: TQs150psf-17° bedding 4-8°
 Model: Anisotropic Fn.
 Unit Weight: 120 pcf
 Cohesion: 225 psf
 Phi: 40 °
 Phi-Anisotropic Strength Fn.: TQs150psf-17° bedding 4-8°
 C-Anisotropic Strength Fn.: 150psf-17° bedding 4-8°

Materials

- TQs150psf-17° bedding 4-8°
- Fill
- TQs150psf-11° bedding 4-8°

Seismic load
 Horizontal: 0.15
 Vertical: 0.0

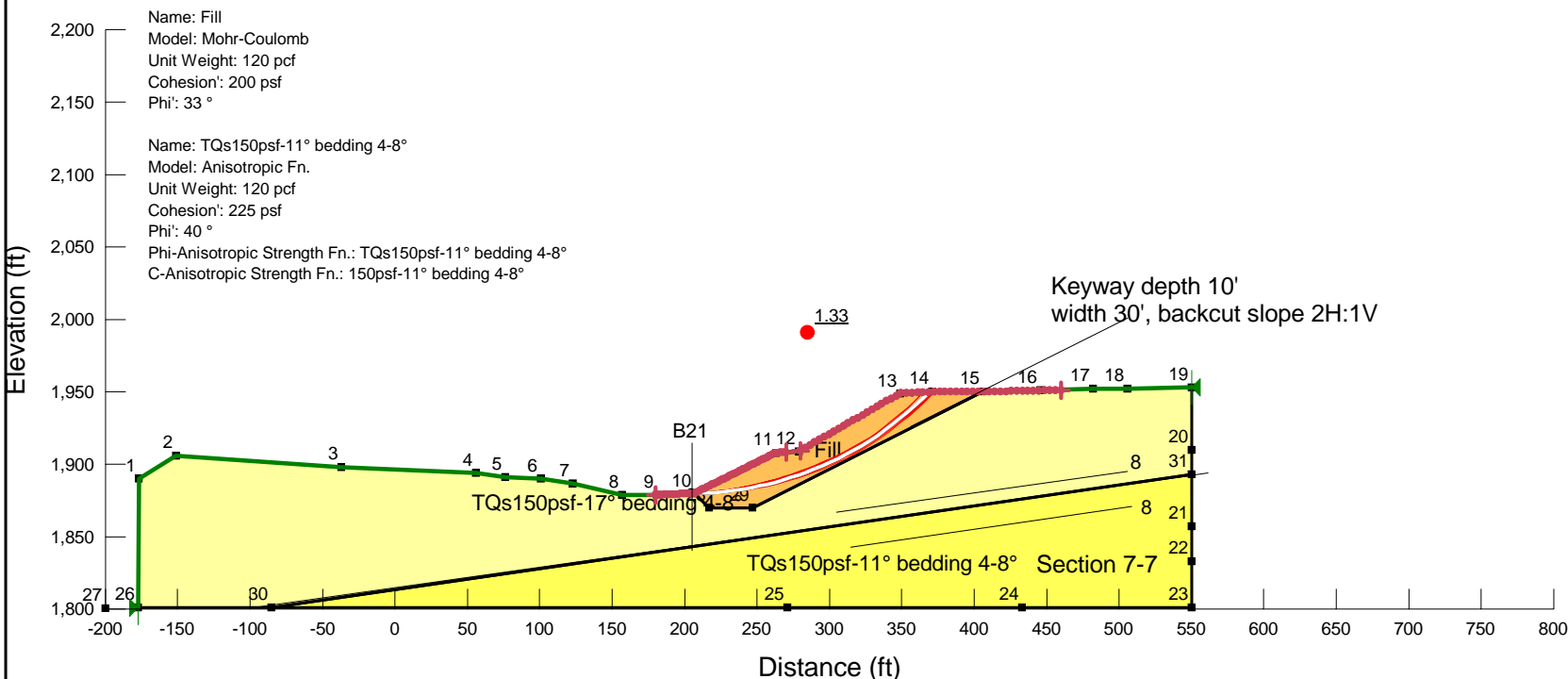

LGC **LGC Valley, Inc**
 GEOTECHNICAL CONSULTING
 28532 Constellation Road, Valencia, CA 91355
 Phone 661-702-8474, Fax 661-702-8475

Skyline Ranch
 Development project, Tract 60922
 Los Angeles CA

Project No: **153035-01**
 Engineer: **BAS**
 Date: **March 2016**

1 - Circular Mode of Failure

Report generated using GeoStudio 2012. Copyright © 1991-2015 GEO-SLOPE International Ltd.

File Information

File Version: 8.15
 Title: Static Slope Stability Analyses for Skyline Ranch Development project, Tract 60922, Los Angeles CA
 Comments: Run By: Dr. Alexander Bykovtsev, Ph.D., P.E.
 Last Edited By: Alexander Bykovtsev
 Revision Number: 99
 Date: 3/21/2016
 Time: 3:03:48 PM
 Tool Version: 8.15.1.11236
 File Name: Section 7-7 Seismic Final with keyway SSA for Skyline Ranch.gsz
 Directory: G:\SLOPE RESULTS\Section 7-7 results\updated 3-21-2016\
 Last Solved Date: 3/21/2016
 Last Solved Time: 3:08:03 PM

Project Settings

Length(L) Units: Feet
 Time(t) Units: Seconds
 Force(F) Units: Pounds
 Pressure(p) Units: psf
 Strength Units: psf
 Unit Weight of Water: 62.4 pcf
 View: 2D
 Element Thickness: 1

Analysis Settings

1 - Circular Mode of Failure

Kind: [SLOPE/W](#)
 Method: [Bishop](#)
 Settings
 PWP Conditions Source: [\(none\)](#)
 Slip Surface
 Direction of movement: [Right to Left](#)
 Use Passive Mode: [No](#)
 Slip Surface Option: [Entry and Exit](#)
 Critical slip surfaces saved: [1](#)
 Resisting Side Maximum Convex Angle: [1 °](#)
 Driving Side Maximum Convex Angle: [5 °](#)
 Optimize Critical Slip Surface Location: [No](#)
 Tension Crack
 Tension Crack Option: [\(none\)](#)

file:///G:/SLOPE%20RESULTS/Section%207-7%20results/updated%203-21-2016/section... 3/21/2016

F of S Distribution
 F of S Calculation Option: [Constant](#)
 Advanced
 Number of Slices: [30](#)
 F of S Tolerance: [0.01](#)
 Minimum Slip Surface Depth: [0.1 ft](#)

Materials

TQs150psf-17° bedding 4-8°

Model: [Anisotropic Fn.](#)
 Unit Weight: [120 pcf](#)
 Cohesion': [225 psf](#)
 Phi': [40 °](#)
 Phi-Anisotropic Strength Fn.: [TQs150psf-17° bedding 4-8°](#)
 C-Anisotropic Strength Fn.: [150psf-17° bedding 4-8°](#)
 Phi-B: [0 °](#)

Fill

Model: [Mohr-Coulomb](#)
 Unit Weight: [120 pcf](#)
 Cohesion': [200 psf](#)
 Phi': [33 °](#)
 Phi-B: [0 °](#)

TQs150psf-11° bedding 4-8°

Model: [Anisotropic Fn.](#)
 Unit Weight: [120 pcf](#)
 Cohesion': [225 psf](#)
 Phi': [40 °](#)
 Phi-Anisotropic Strength Fn.: [TQs150psf-11° bedding 4-8°](#)
 C-Anisotropic Strength Fn.: [150psf-11° bedding 4-8°](#)
 Phi-B: [0 °](#)

Slip Surface Entry and Exit

Left Projection: [Range](#)
 Left-Zone Left Coordinate: [\(180, 1,879\) ft](#)
 Left-Zone Right Coordinate: [\(270, 1,908.4375\) ft](#)
 Left-Zone Increment: [50](#)
 Right Projection: [Range](#)
 Right-Zone Left Coordinate: [\(280, 1,909.5714\) ft](#)
 Right-Zone Right Coordinate: [\(460, 1,951.3889\) ft](#)
 Right-Zone Increment: [50](#)
 Radius Increments: [50](#)

Slip Surface Limits

file:///G:/SLOPE%20RESULTS/Section%207-7%20results/updated%203-21-2016/section... 3/21/2016

Left Coordinate: (-177.5082, 1,801) ft
 Right Coordinate: (550, 1,953) ft

Seismic Coefficients

Horz Seismic Coef.: 0.15
 Vert Seismic Coef.: 0

Anisotropic Strength Functions

TQs150psf-17° bedding 4-8°

Model: Spline Data Point Function
 Function: Modifier Factor vs. Inclination
 Curve Fit to Data: 100 %
 Segment Curvature: 0 %
 Y-Intercept: 1
 Data Points: Inclination (°), Modifier Factor
 Data Point: (-90, 1)
 Data Point: (3.9, 1)
 Data Point: (4, 0.425)
 Data Point: (8, 0.425)
 Data Point: (8.1, 1)

150psf-17° bedding 4-8°

Model: Spline Data Point Function
 Function: Modifier Factor vs. Inclination
 Curve Fit to Data: 100 %
 Segment Curvature: 0 %
 Y-Intercept: 1
 Data Points: Inclination (°), Modifier Factor
 Data Point: (-90, 1)
 Data Point: (3.9, 1)
 Data Point: (4, 0.667)
 Data Point: (8, 0.667)
 Data Point: (8.1, 1)

TQs150psf-11° bedding 4-8°

Model: Spline Data Point Function
 Function: Modifier Factor vs. Inclination
 Curve Fit to Data: 100 %
 Segment Curvature: 0 %
 Y-Intercept: 1
 Data Points: Inclination (°), Modifier Factor
 Data Point: (-90, 1)
 Data Point: (3.9, 1)
 Data Point: (4, 0.275)
 Data Point: (8, 0.275)
 Data Point: (8.1, 1)

150psf-11° bedding 4-8°

Model: Spline Data Point Function
 Function: Modifier Factor vs. Inclination
 Curve Fit to Data: 100 %
 Segment Curvature: 0 %
 Y-Intercept: 1
 Data Points: Inclination (°), Modifier Factor
 Data Point: (-90, 1)
 Data Point: (3.9, 1)
 Data Point: (4, 0.667)
 Data Point: (8, 0.667)
 Data Point: (8.1, 1)

Points

	X (ft)	Y (ft)
Point 1	-177	1,890
Point 2	-151	1,906
Point 3	-37	1,898
Point 4	56	1,894
Point 5	76	1,891
Point 6	101	1,890
Point 7	123	1,887
Point 8	157	1,879
Point 9	181	1,879
Point 10	207	1,880
Point 11	263	1,908
Point 12	279	1,909
Point 13	349	1,949
Point 14	371	1,950
Point 15	406	1,950
Point 16	446	1,951
Point 17	482	1,952
Point 18	506	1,952
Point 19	550	1,953
Point 20	550	1,910
Point 21	550	1,857
Point 22	550	1,833
Point 23	550	1,801
Point 24	433	1,801
Point 25	271	1,801
Point 26	-177.5082	1,801
Point 27	-200	1,800.4977
Point 28	217	1,870
Point 29	247	1,870

Point 30	-85	1,801
Point 31	550	1,893

Regions

	Material	Points	Area (ft ²)
Region 1	TQs150psf-17° bedding 4-8°	1,26,30,31,20,19,18,17,16,15,29,28,10,9,8,7,6,5,4,3,2	48,206
Region 2	Fill	10,28,29,15,14,13,12,11	4,229
Region 3	TQs150psf-11° bedding 4-8°	30,25,24,23,22,21,31	29,210

Current Slip Surface

Slip Surface: 37,755
 F of S: 1.33
 Volume: 2,445.3315 ft³
 Weight: 293,439.78 lbs
 Resisting Moment: 47,114,303 lbs-ft
 Activating Moment: 35,344,421 lbs-ft
 F of S Rank (Analysis): 1 of 132,651 slip surfaces
 F of S Rank (Query): 1 of 20 slip surfaces
 Exit: (207.03645, 1,880.0182) ft
 Entry: (368.5749, 1,949.8898) ft
 Radius: 230.49199 ft
 Center: (203.23372, 2,110.4788) ft

Slip Slices

	X (ft)	Y (ft)	PWP (psf)	Base Normal Stress (psf)	Frictional Strength (psf)	Cohesive Strength (psf)
Slice 1	209.83463	1,880.0984	0	151.8663	98.623131	200
Slice 2	215.43099	1,880.3269	0	447.1842	290.40481	200
Slice 3	221.02734	1,880.6918	0	719.93456	467.53097	200
Slice 4	226.62369	1,881.194	0	970.74694	630.41043	200
Slice 5	232.22005	1,881.8342	0	1,200.1804	779.40625	200
Slice 6	237.8164	1,882.6136	0	1,408.7294	914.83954	200
Slice 7	243.41276	1,883.5336	0	1,596.829	1,036.9929	200

Slice 8	249.00911	1,884.5961	0	1,764.8594	1,146.1131	200
Slice 9	254.60547	1,885.8029	0	1,913.1492	1,242.4136	200
Slice 10	260.20182	1,887.1565	0	2,041.9789	1,326.0766	200
Slice 11	265.66667	1,888.6208	0	2,026.2575	1,315.867	200
Slice 12	271	1,890.1915	0	1,871.2051	1,215.1748	200
Slice 13	276.33333	1,891.9037	0	1,704.4537	1,106.8852	200
Slice 14	281.69231	1,893.7703	0	1,665.0158	1,081.2739	200
Slice 15	287.07692	1,895.7965	0	1,748.0189	1,135.1767	200
Slice 16	292.46154	1,897.9784	0	1,812.8562	1,177.2826	200
Slice 17	297.84615	1,900.321	0	1,859.5331	1,207.5949	200
Slice 18	303.23077	1,902.8296	0	1,888.0188	1,226.0937	200
Slice 19	308.61538	1,905.5103	0	1,898.2453	1,232.7349	200
Slice 20	314	1,908.3701	0	1,890.1074	1,227.4501	200
Slice 21	319.38462	1,911.4165	0	1,863.4615	1,210.146	200
Slice 22	324.76923	1,914.6584	0	1,818.1243	1,180.7038	200
Slice 23	330.15385	1,918.1057	0	1,753.8722	1,138.978	200
Slice 24	335.53846	1,921.7695	0	1,670.4392	1,084.7959	200
Slice 25	340.92308	1,925.6629	0	1,567.5158	1,017.9567	200
Slice 26	346.30769	1,929.8007	0	1,444.7477	938.23016	200
Slice 27	351.44686	1,933.9874	0	1,199.5612	779.00412	200
Slice 28	356.34059	1,938.217	0	838.67409	544.64132	200
Slice 29	361.23432	1,942.696	0	468.0426	303.95042	200
Slice 30	366.12804	1,947.445	0	87.825777	57.034726	200

Section 7-7 Static Final with keyway SSA for Skyline Ranch.gsz

Section 7-7 Static Final with keyway SSA for Skyline Ranch.gsz Run By: Dr. Alexander Bykovtsev, Ph.D., P.E. 3/21/2016 3:10:42 PM

Name: TQs150psf-17° bedding 4-8°
 Model: Anisotropic Fn.
 Unit Weight: 120 pcf
 Cohesion: 225 psf
 Phi: 40 °
 Phi-Anisotropic Strength Fn.: TQs150psf-17° bedding 4-8°
 C-Anisotropic Strength Fn.: 150psf-17° bedding 4-8°

Materials

- TQs150psf-17° bedding 4-8°
- Fill
- TQs150psf-11° bedding 4-8°

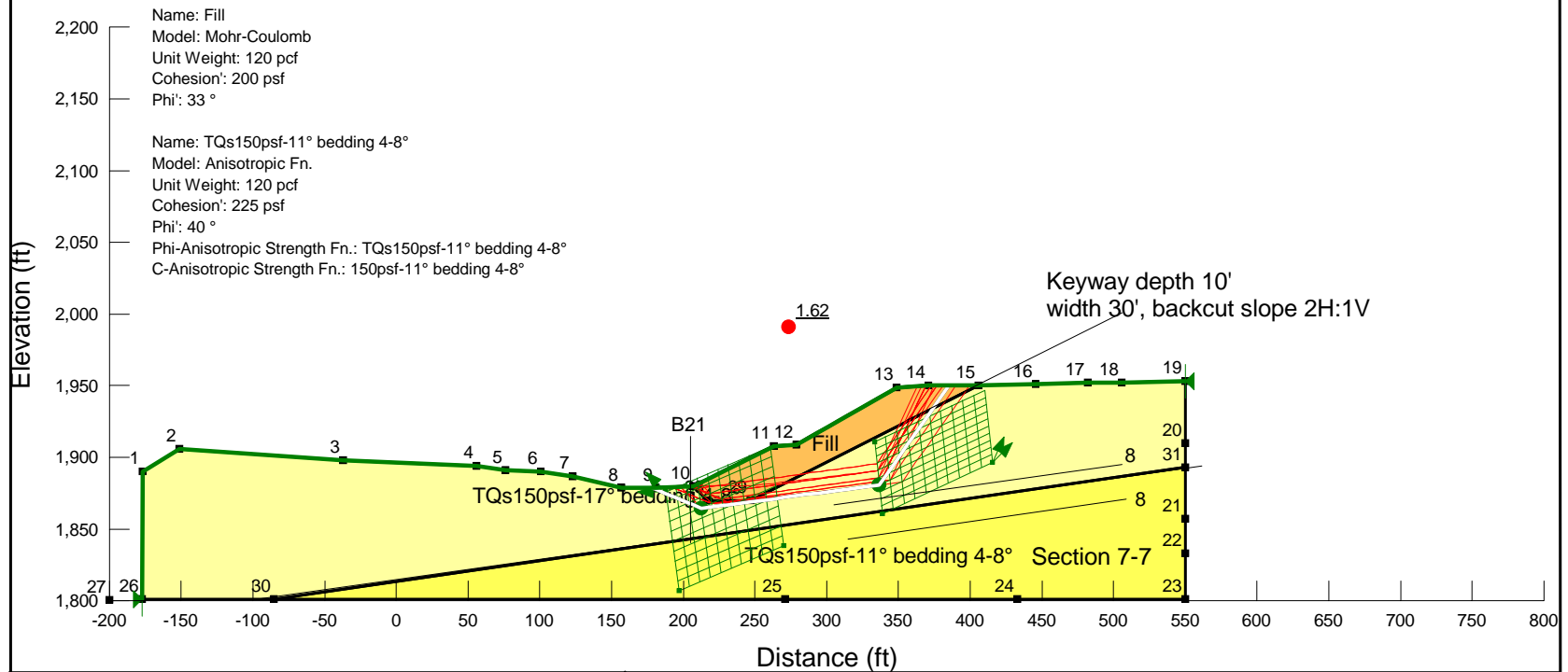

LGC **LGC Valley, Inc**
 GEOTECHNICAL CONSULTING
 28532 Constellation Road, Valencia, CA 91355
 Phone 661-702-8474, Fax 661-702-8475

Skyline Ranch
 Development project, Tract 60922
 Los Angeles CA

Project No: **153035-01**
 Engineer: **BAS**
 Date: **March 2016**

2 - Translational

Report generated using GeoStudio 2012. Copyright © 1991-2015 GEO-SLOPE International Ltd.

File Information

File Version: 8.15
 Title: Static Slope Stability Analyses for Skyline Ranch Development project, Tract 60922, Los Angeles CA
 Comments: Run By: Dr. Alexander Bykovtsev, Ph.D., P.E.
 Last Edited By: Alexander Bykovtsev
 Revision Number: 101
 Date: 3/21/2016
 Time: 3:10:42 PM
 Tool Version: 8.15.1.11236
 File Name: Section 7-7 Static Final with keyway SSA for Skyline Ranch.s3z
 Directory: G:\SLOPE RESULTS\Section 7-7 results\updated 3-21-2016\
 Last Solved Date: 3/21/2016
 Last Solved Time: 3:11:08 PM

Project Settings

Length(L) Units: Feet
 Time(t) Units: Seconds
 Force(F) Units: Pounds
 Pressure(p) Units: psf
 Strength Units: psf
 Unit Weight of Water: 62.4 pcf
 View: 2D
 Element Thickness: 1

Analysis Settings

2 - Translational

Kind: SLOPE/W
 Method: Janbu
 Settings
 PWP Conditions Source: (none)
 Slip Surface
 Direction of movement: Right to Left
 Use Passive Mode: No
 Slip Surface Option: Block
 Critical slip surfaces saved: 10
 Resisting Side Maximum Convex Angle: 1 °
 Driving Side Maximum Convex Angle: 5 °
 Restrict Block Crossing: No
 Optimize Critical Slip Surface Location: No
 Tension Crack

file:///G:/SLOPE%20RESULTS/Section%207-7%20results/updated%203-21-2016/section... 3/21/2016

Tension Crack Option: (none)
 F of S Distribution
 F of S Calculation Option: Constant
 Advanced
 Number of Slices: 30
 F of S Tolerance: 0.01
 Minimum Slip Surface Depth: 0.1 ft

Materials

TQs150psf-17° bedding 4-8°

Model: Anisotropic Fn.
 Unit Weight: 120 pcf
 Cohesion': 225 psf
 Phi': 40 °
 Phi-Anisotropic Strength Fn.: TQs150psf-17° bedding 4-8°
 C-Anisotropic Strength Fn.: 150psf-17° bedding 4-8°
 Phi-B: 0 °

Fill

Model: Mohr-Coulomb
 Unit Weight: 120 pcf
 Cohesion': 200 psf
 Phi': 33 °
 Phi-B: 0 °

TQs150psf-11° bedding 4-8°

Model: Anisotropic Fn.
 Unit Weight: 120 pcf
 Cohesion': 225 psf
 Phi': 40 °
 Phi-Anisotropic Strength Fn.: TQs150psf-11° bedding 4-8°
 C-Anisotropic Strength Fn.: 150psf-11° bedding 4-8°
 Phi-B: 0 °

Slip Surface Limits

Left Coordinate: (-177.5082, 1,801) ft
 Right Coordinate: (550, 1,953) ft

Slip Surface Block

Left Grid
 Upper Left: (187.968, 1,876.0315) ft
 Lower Left: (197.2912, 1,806.9576) ft
 Lower Right: (269.9924, 1,838.286) ft
 X Increments: 10
 Y Increments: 10

file:///G:/SLOPE%20RESULTS/Section%207-7%20results/updated%203-21-2016/section... 3/21/2016

Starting Angle: 135 °
 Ending Angle: 180 °
 Angle Increments: 2
 Right Grid
 Upper Left: (333.3485, 1,910.6689) ft
 Lower Left: (339.0092, 1,860.8593) ft
 Lower Right: (415.9794, 1,896.8331) ft
 X Increments: 10
 Y Increments: 10
 Starting Angle: 45 °
 Ending Angle: 65 °
 Angle Increments: 2

Seismic Coefficients

Horz Seismic Coef.: 0
 Vert Seismic Coef.: 0

Anisotropic Strength Functions

TQs150psf-17° bedding 4-8°

Model: Spline Data Point Function
 Function: Modifier Factor vs. Inclination
 Curve Fit to Data: 100 %
 Segment Curvature: 0 %
 Y-Intercept: 1
 Data Points: Inclination (°), Modifier Factor
 Data Point: (-90, 1)
 Data Point: (3.9, 1)
 Data Point: (4, 0.425)
 Data Point: (8, 0.425)
 Data Point: (8.1, 1)

150psf-17° bedding 4-8°

Model: Spline Data Point Function
 Function: Modifier Factor vs. Inclination
 Curve Fit to Data: 100 %
 Segment Curvature: 0 %
 Y-Intercept: 1
 Data Points: Inclination (°), Modifier Factor
 Data Point: (-90, 1)
 Data Point: (3.9, 1)
 Data Point: (4, 0.667)
 Data Point: (8, 0.667)
 Data Point: (8.1, 1)

TQs150psf-11° bedding 4-8°

Model: Spline Data Point Function
 Function: Modifier Factor vs. Inclination

Curve Fit to Data: 100 %
 Segment Curvature: 0 %
 Y-Intercept: 1
 Data Points: Inclination (°), Modifier Factor
 Data Point: (-90, 1)
 Data Point: (3.9, 1)
 Data Point: (4, 0.275)
 Data Point: (8, 0.275)
 Data Point: (8.1, 1)

150psf-11° bedding 4-8°

Model: Spline Data Point Function
 Function: Modifier Factor vs. Inclination
 Curve Fit to Data: 100 %
 Segment Curvature: 0 %
 Y-Intercept: 1
 Data Points: Inclination (°), Modifier Factor
 Data Point: (-90, 1)
 Data Point: (3.9, 1)
 Data Point: (4, 0.667)
 Data Point: (8, 0.667)
 Data Point: (8.1, 1)

Points

	X (ft)	Y (ft)
Point 1	-177	1,890
Point 2	-151	1,906
Point 3	-37	1,898
Point 4	56	1,894
Point 5	76	1,891
Point 6	101	1,890
Point 7	123	1,887
Point 8	157	1,879
Point 9	181	1,879
Point 10	207	1,880
Point 11	263	1,908
Point 12	279	1,909
Point 13	349	1,949
Point 14	371	1,950
Point 15	406	1,950
Point 16	446	1,951
Point 17	482	1,952
Point 18	506	1,952
Point 19	550	1,953
Point 20	550	1,910
Point 21	550	1,857

Point 22	550	1,833
Point 23	550	1,801
Point 24	433	1,801
Point 25	271	1,801
Point 26	-177.5082	1,801
Point 27	-200	1,800.4977
Point 28	217	1,870
Point 29	247	1,870
Point 30	-85	1,801
Point 31	550	1,893

Regions

	Material	Points	Area (ft ²)
Region 1	TQs150psf-17° bedding 4-8°	1,26,30,31,20,19,18,17,16,15,29,28,10,9,8,7,6,5,4,3,2	48,206
Region 2	Fill	10,28,29,15,14,13,12,11	4,229
Region 3	TQs150psf-11° bedding 4-8°	30,25,24,23,22,21,31	29,210

Current Slip Surface

Slip Surface: 87,617
 F of S: 1.62
 Volume: 6,644.417 ft³
 Weight: 797,330.04 lbs
 Resisting Force: 332,180.03 lbs
 Activating Force: 205,264.76 lbs
 F of S Rank (Analysis): 1 of 131,769 slip surfaces
 F of S Rank (Query): 1 of 20 slip surfaces
 Exit: (178.07102, 1,879) ft
 Entry: (385.21109, 1,950) ft
 Radius: 114.02385 ft
 Center: (263.38891, 1,967.75) ft

Slip Slices

--	--	--	--	--	--	--

	X (ft)	Y (ft)	PWP (psf)	Base Normal Stress (psf)	Frictional Strength (psf)	Cohesive Strength (psf)
Slice 1	179.53551	1,878.3934	0	166.26136	139.50985	225
Slice 2	184.25	1,876.4406	0	483.9536	406.08528	225
Slice 3	190.75	1,873.7482	0	933.83861	783.58363	225
Slice 4	197.25	1,871.0558	0	1,383.7236	1,161.082	225
Slice 5	203.75	1,868.3634	0	1,833.6086	1,538.5803	225
Slice 6	209.78766	1,865.8625	0	2,448.214	2,054.2955	225
Slice 7	214.78766	1,864.9943	0	2,201.9664	673.20867	150.075
Slice 8	220.75	1,865.7662	0	2,460.7383	752.32321	150.075
Slice 9	228.25	1,866.7371	0	2,786.2464	851.84102	150.075
Slice 10	235.75	1,867.7081	0	3,111.7545	951.35883	150.075
Slice 11	243.25	1,868.6791	0	3,437.2626	1,050.8766	150.075
Slice 12	251	1,869.6824	0	3,773.621	1,153.7117	150.075
Slice 13	259	1,870.7181	0	4,120.8296	1,259.864	150.075
Slice 14	267	1,871.7538	0	4,263.0607	1,303.3485	150.075
Slice 15	275	1,872.7895	0	4,200.3143	1,284.1649	150.075
Slice 16	282.60906	1,873.7746	0	4,355.773	1,331.6934	150.075
Slice 17	289.82717	1,874.7091	0	4,729.4368	1,445.9339	150.075
Slice 18	297.04529	1,875.6435	0	5,103.1006	1,560.1744	150.075
Slice 19	304.2634	1,876.578	0	5,476.7645	1,674.4149	150.075
Slice 20	311.48152	1,877.5125	0	5,850.4283	1,788.6554	150.075
Slice 21	318.69963	1,878.447	0	6,224.0921	1,902.8959	150.075
Slice 22	325.91775	1,879.3814	0	6,597.756	2,017.1364	150.075
Slice 23	333.13586	1,880.3159	0	6,971.4198	2,131.3769	150.075

Slice 24	339.80869	1,885.1587	0	3,922.1401	3,291.0663	225
Slice 25	345.93623	1,893.9097	0	3,560.4843	2,987.601	225
Slice 26	352.66667	1,903.5218	0	3,030.381	2,542.7916	225
Slice 27	360	1,913.9948	0	2,331.8302	1,956.6378	225
Slice 28	367.33333	1,924.4679	0	1,633.2794	1,370.4841	225
Slice 29	372.4516	1,931.7776	0	1,141.1832	957.5664	225
Slice 30	376.73017	1,937.888	0	810.99373	526.66549	200
Slice 31	382.38412	1,945.9627	0	195.44588	126.92404	200

Section 7-7 Seismic Final with keyway SSA for Skyline Ranch.gsz

Section 7-7 Seismic Final with keyway SSA for Skyline Ranch.gsz Run By: Dr. Alexander Bykovtsev, Ph.D., P.E. 3/21/2016 3:03:48 PM

Name: TQs150psf-17° bedding 4-8°
 Model: Anisotropic Fn.
 Unit Weight: 120 pcf
 Cohesion: 225 psf
 Phi: 40 °
 Phi-Anisotropic Strength Fn.: TQs150psf-17° bedding 4-8°
 C-Anisotropic Strength Fn.: 150psf-17° bedding 4-8°

Materials

- TQs150psf-17° bedding 4-8°
- Fill
- TQs150psf-11° bedding 4-8°

Seismic load
 Horizontal: 0.15
 Vertical: 0.0

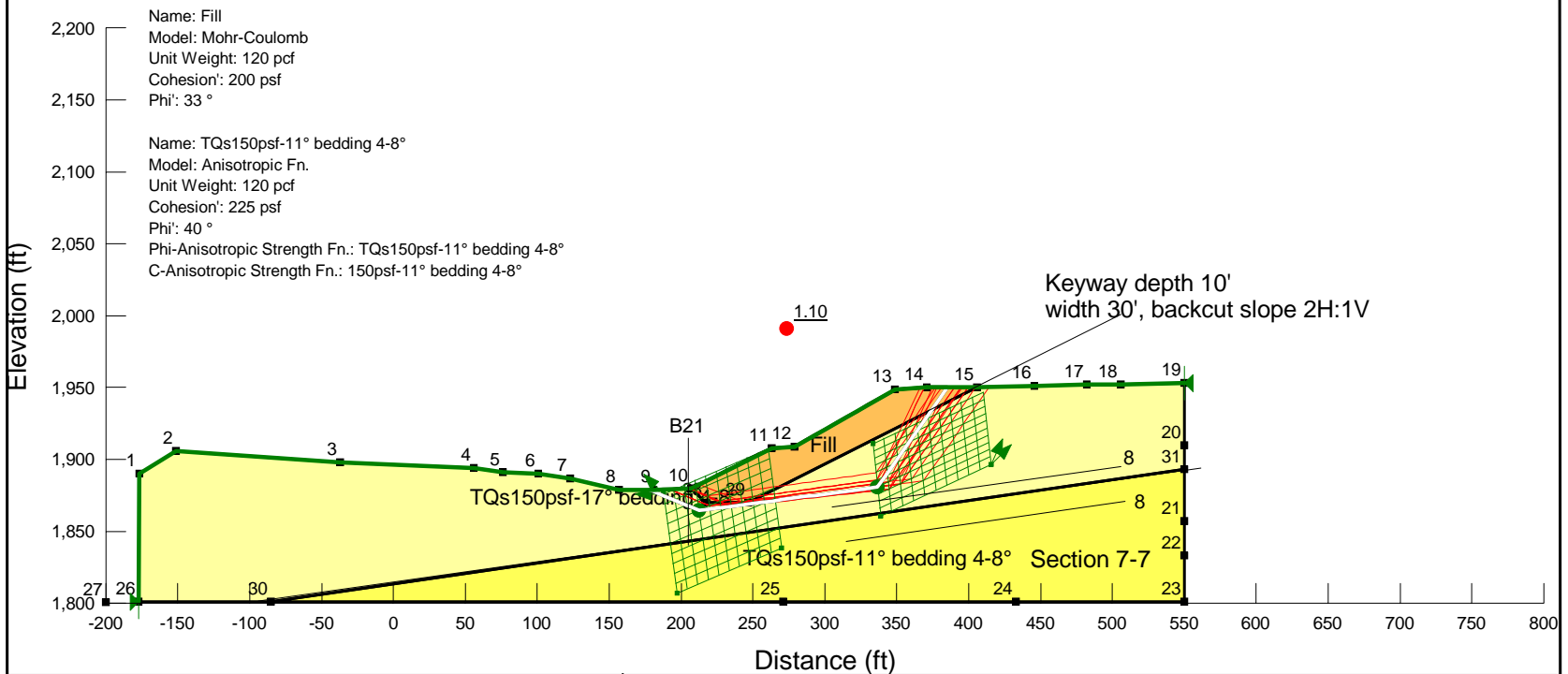

LGC **LGC Valley, Inc**
 GEOTECHNICAL CONSULTING
 28532 Constellation Road, Valencia, CA 91355
 Phone 661-702-8474, Fax 661-702-8475

Skyline Ranch
 Development project, Tract 60922
 Los Angeles CA

Project No: **153035-01**
 Engineer: **BAS**
 Date: **March 2016**

2 - Translational

Report generated using GeoStudio 2012. Copyright © 1991-2015 GEO-SLOPE International Ltd.

File Information

File Version: 8.15
 Title: Static Slope Stability Analyses for Skyline Ranch Development project, Tract 60922, Los Angeles CA
 Comments: Run By: Dr. Alexander Bykovtsev, Ph.D., P.E.
 Last Edited By: Alexander Bykovtsev
 Revision Number: 99
 Date: 3/21/2016
 Time: 3:03:48 PM
 Tool Version: 8.15.1.11236
 File Name: Section 7-7 Seismic Final with keyway SSA for Skyline Ranch.gsz
 Directory: G:\SLOPE RESULTS\Section 7-7 results\updated 3-21-2016\
 Last Solved Date: 3/21/2016
 Last Solved Time: 3:04:43 PM

Project Settings

Length(L) Units: Feet
 Time(t) Units: Seconds
 Force(F) Units: Pounds
 Pressure(p) Units: psf
 Strength Units: psf
 Unit Weight of Water: 62.4 pcf
 View: 2D
 Element Thickness: 1

Analysis Settings

2 - Translational

Kind: [SLOPE/W](#)
 Method: [Janbu](#)
 Settings
 PWP Conditions Source: [\(none\)](#)
 Slip Surface
 Direction of movement: [Right to Left](#)
 Use Passive Mode: [No](#)
 Slip Surface Option: [Block](#)
 Critical slip surfaces saved: [10](#)
 Resisting Side Maximum Convex Angle: [1 °](#)
 Driving Side Maximum Convex Angle: [5 °](#)
 Restrict Block Crossing: [No](#)
 Optimize Critical Slip Surface Location: [No](#)
 Tension Crack

file:///G:/SLOPE%20RESULTS/Section%207-7%20results/updated%203-21-2016/section... 3/21/2016

Tension Crack Option: [\(none\)](#)
 F of S Distribution
 F of S Calculation Option: [Constant](#)
 Advanced
 Number of Slices: [30](#)
 F of S Tolerance: [0.01](#)
 Minimum Slip Surface Depth: [0.1 ft](#)

Materials

TQs150psf-17° bedding 4-8°

Model: [Anisotropic Fn.](#)
 Unit Weight: [120 pcf](#)
 Cohesion': [225 psf](#)
 Phi': [40 °](#)
 Phi-Anisotropic Strength Fn.: [TQs150psf-17° bedding 4-8°](#)
 C-Anisotropic Strength Fn.: [150psf-17° bedding 4-8°](#)
 Phi-B: [0 °](#)

Fill

Model: [Mohr-Coulomb](#)
 Unit Weight: [120 pcf](#)
 Cohesion': [200 psf](#)
 Phi': [33 °](#)
 Phi-B: [0 °](#)

TQs150psf-11° bedding 4-8°

Model: [Anisotropic Fn.](#)
 Unit Weight: [120 pcf](#)
 Cohesion': [225 psf](#)
 Phi': [40 °](#)
 Phi-Anisotropic Strength Fn.: [TQs150psf-11° bedding 4-8°](#)
 C-Anisotropic Strength Fn.: [150psf-11° bedding 4-8°](#)
 Phi-B: [0 °](#)

Slip Surface Limits

Left Coordinate: [\(-177.5082, 1,801\) ft](#)
 Right Coordinate: [\(550, 1,953\) ft](#)

Slip Surface Block

Left Grid
 Upper Left: [\(187.968, 1,876.0315\) ft](#)
 Lower Left: [\(197.2912, 1,806.9576\) ft](#)
 Lower Right: [\(269.9924, 1,838.286\) ft](#)
 X Increments: [10](#)
 Y Increments: [10](#)

file:///G:/SLOPE%20RESULTS/Section%207-7%20results/updated%203-21-2016/section... 3/21/2016

Starting Angle: 135 °
 Ending Angle: 180 °
 Angle Increments: 2
 Right Grid
 Upper Left: (333.3485, 1,910.6689) ft
 Lower Left: (339.0092, 1,860.8593) ft
 Lower Right: (415.9794, 1,896.8331) ft
 X Increments: 10
 Y Increments: 10
 Starting Angle: 45 °
 Ending Angle: 65 °
 Angle Increments: 2

Seismic Coefficients

Horz Seismic Coef.: 0.15
 Vert Seismic Coef.: 0

Anisotropic Strength Functions

TQs150psf-17° bedding 4-8°

Model: Spline Data Point Function
 Function: Modifier Factor vs. Inclination
 Curve Fit to Data: 100 %
 Segment Curvature: 0 %
 Y-Intercept: 1
 Data Points: Inclination (°), Modifier Factor
 Data Point: (-90, 1)
 Data Point: (3.9, 1)
 Data Point: (4, 0.425)
 Data Point: (8, 0.425)
 Data Point: (8.1, 1)

150psf-17° bedding 4-8°

Model: Spline Data Point Function
 Function: Modifier Factor vs. Inclination
 Curve Fit to Data: 100 %
 Segment Curvature: 0 %
 Y-Intercept: 1
 Data Points: Inclination (°), Modifier Factor
 Data Point: (-90, 1)
 Data Point: (3.9, 1)
 Data Point: (4, 0.667)
 Data Point: (8, 0.667)
 Data Point: (8.1, 1)

TQs150psf-11° bedding 4-8°

Model: Spline Data Point Function
 Function: Modifier Factor vs. Inclination

Curve Fit to Data: 100 %
 Segment Curvature: 0 %
 Y-Intercept: 1
 Data Points: Inclination (°), Modifier Factor
 Data Point: (-90, 1)
 Data Point: (3.9, 1)
 Data Point: (4, 0.275)
 Data Point: (8, 0.275)
 Data Point: (8.1, 1)

150psf-11° bedding 4-8°

Model: Spline Data Point Function
 Function: Modifier Factor vs. Inclination
 Curve Fit to Data: 100 %
 Segment Curvature: 0 %
 Y-Intercept: 1
 Data Points: Inclination (°), Modifier Factor
 Data Point: (-90, 1)
 Data Point: (3.9, 1)
 Data Point: (4, 0.667)
 Data Point: (8, 0.667)
 Data Point: (8.1, 1)

Points

	X (ft)	Y (ft)
Point 1	-177	1,890
Point 2	-151	1,906
Point 3	-37	1,898
Point 4	56	1,894
Point 5	76	1,891
Point 6	101	1,890
Point 7	123	1,887
Point 8	157	1,879
Point 9	181	1,879
Point 10	207	1,880
Point 11	263	1,908
Point 12	279	1,909
Point 13	349	1,949
Point 14	371	1,950
Point 15	406	1,950
Point 16	446	1,951
Point 17	482	1,952
Point 18	506	1,952
Point 19	550	1,953
Point 20	550	1,910
Point 21	550	1,857

Point 22	550	1,833
Point 23	550	1,801
Point 24	433	1,801
Point 25	271	1,801
Point 26	-177.5082	1,801
Point 27	-200	1,800.4977
Point 28	217	1,870
Point 29	247	1,870
Point 30	-85	1,801
Point 31	550	1,893

Regions

	Material	Points	Area (ft ²)
Region 1	TQs150psf-17° bedding 4-8°	1,26,30,31,20,19,18,17,16,15,29,28,10,9,8,7,6,5,4,3,2	48,206
Region 2	Fill	10,28,29,15,14,13,12,11	4,229
Region 3	TQs150psf-11° bedding 4-8°	30,25,24,23,22,21,31	29,210

Current Slip Surface

Slip Surface: 87,617
 F of S: 1.10
 Volume: 6,644.417 ft³
 Weight: 797,330.04 lbs
 Resisting Force: 320,432.74 lbs
 Activating Force: 292,595.3 lbs
 F of S Rank (Analysis): 1 of 131,769 slip surfaces
 F of S Rank (Query): 1 of 20 slip surfaces
 Exit: (178.07102, 1,879) ft
 Entry: (385.21109, 1,950) ft
 Radius: 114.02385 ft
 Center: (263.38891, 1,967.75) ft

Slip Slices

--	--	--	--	--	--	--

	X (ft)	Y (ft)	PWP (psf)	Base Normal Stress (psf)	Frictional Strength (psf)	Cohesive Strength (psf)
Slice 1	179.53551	1,878.3934	0	230.20495	193.16489	225
Slice 2	184.25	1,876.4406	0	594.66078	498.97964	225
Slice 3	190.75	1,873.7482	0	1,110.7679	932.04491	225
Slice 4	197.25	1,871.0558	0	1,626.875	1,365.1102	225
Slice 5	203.75	1,868.3634	0	2,142.982	1,798.1754	225
Slice 6	209.78766	1,865.8625	0	2,848.056	2,389.8027	225
Slice 7	214.78766	1,864.9943	0	2,172.1571	664.09509	150.075
Slice 8	220.75	1,865.7662	0	2,428.0646	742.33384	150.075
Slice 9	228.25	1,866.7371	0	2,749.9694	840.75001	150.075
Slice 10	235.75	1,867.7081	0	3,071.8741	939.16617	150.075
Slice 11	243.25	1,868.6791	0	3,393.7789	1,037.5823	150.075
Slice 12	251	1,869.6824	0	3,726.4139	1,139.279	150.075
Slice 13	259	1,870.7181	0	4,069.779	1,244.2563	150.075
Slice 14	267	1,871.7538	0	4,210.4356	1,287.2593	150.075
Slice 15	275	1,872.7895	0	4,148.3838	1,268.2882	150.075
Slice 16	282.60906	1,873.7746	0	4,302.1216	1,315.2906	150.075
Slice 17	289.82717	1,874.7091	0	4,671.649	1,428.2664	150.075
Slice 18	297.04529	1,875.6435	0	5,041.1764	1,541.2423	150.075
Slice 19	304.2634	1,876.578	0	5,410.7039	1,654.2182	150.075
Slice 20	311.48152	1,877.5125	0	5,780.2313	1,767.1941	150.075
Slice 21	318.69963	1,878.447	0	6,149.7588	1,880.1699	150.075
Slice 22	325.91775	1,879.3814	0	6,519.2862	1,993.1458	150.075
Slice 23	333.13586	1,880.3159	0	6,888.8137	2,106.1217	150.075

Slice 24	339.80869	1,885.1587	0	3,225.6989	2,706.6828	225
Slice 25	345.93623	1,893.9097	0	2,924.1517	2,453.6546	225
Slice 26	352.66667	1,903.5218	0	2,482.1536	2,082.7741	225
Slice 27	360	1,913.9948	0	1,899.7045	1,594.0414	225
Slice 28	367.33333	1,924.4679	0	1,317.2555	1,105.3086	225
Slice 29	372.4516	1,931.7776	0	906.9476	761.0194	225
Slice 30	376.73017	1,937.888	0	647.83123	420.70652	200
Slice 31	382.38412	1,945.9627	0	122.03969	79.253504	200

Section 7-7 Static Temporary Final without keyway SSA for Skyline Ranch.gsz

Section 7-7 Static Temporary Final without keyway SSA for Skyline Ranch.gsz Run By: Dr. Alexander Bykovtsev, Ph.D., P.E. 3/21/2016 3:16:19 PM

Materials

- TQs150psf-17° bedding 4-8°
- TQs150psf-11° bedding 4-8°

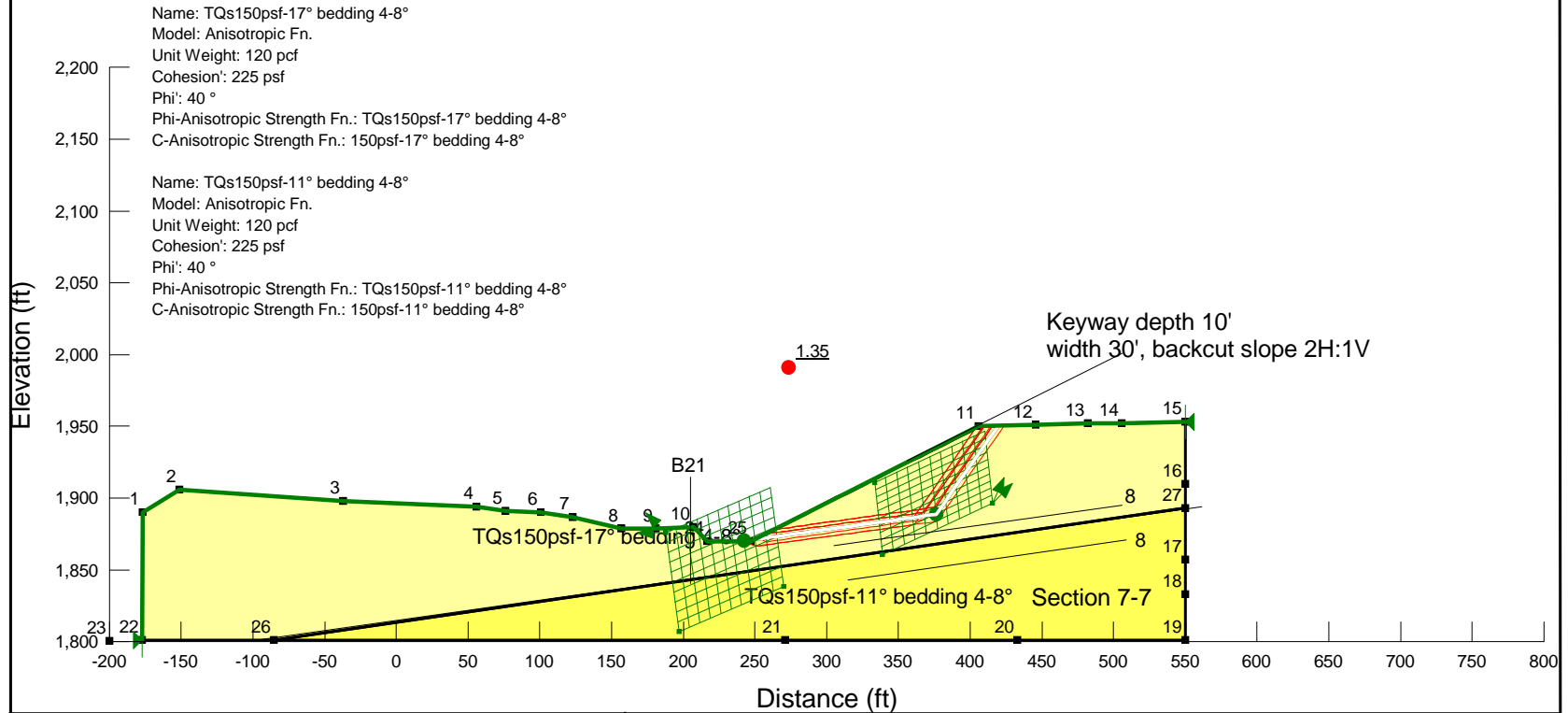

LGC **LGC Valley, Inc**
 GEOTECHNICAL CONSULTING
 28532 Constellation Road, Valencia, CA 91355
 Phone 661-702-8474, Fax 661-702-8475

Skyline Ranch
 Development project, Tract 60922
 Los Angeles CA

Project No: **153035-01**
 Engineer: **BAS**
 Date: **March 2016**

2 - Translational

Report generated using GeoStudio 2012. Copyright © 1991-2015 GEO-SLOPE International Ltd.

File Information

File Version: 8.15
 Title: Static Slope Stability Analyses for Skyline Ranch Development project, Tract 60922, Los Angeles CA
 Comments: Run By: Dr. Alexander Bykovtsev, Ph.D., P.E.
 Last Edited By: Alexander Bykovtsev
 Revision Number: 104
 Date: 3/21/2016
 Time: 3:16:19 PM
 Tool Version: 8.15.1.11236
 File Name: Section 7-7 Static Temporary Final without keyway SSA for Skyline Ranch.gsz
 Directory: G:\SLOPE RESULTS\Section 7-7 results\updated 3-21-2016\
 Last Solved Date: 3/21/2016
 Last Solved Time: 3:17:08 PM

Project Settings

Length(L) Units: Feet
 Time(t) Units: Seconds
 Force(F) Units: Pounds
 Pressure(p) Units: psf
 Strength Units: psf
 Unit Weight of Water: 62.4 pcf
 View: 2D
 Element Thickness: 1

Analysis Settings

2 - Translational

Kind: SLOPE/W
 Method: Janbu
 Settings
 PWP Conditions Source: (none)
 Slip Surface
 Direction of movement: Right to Left
 Use Passive Mode: No
 Slip Surface Option: Block
 Critical slip surfaces saved: 10
 Resisting Side Maximum Convex Angle: 1 °
 Driving Side Maximum Convex Angle: 5 °
 Restrict Block Crossing: No
 Optimize Critical Slip Surface Location: No
 Tension Crack

file:///G:/SLOPE%20RESULTS/Section%207-7%20results/updated%203-21-2016/section... 3/21/2016

Tension Crack Option: (none)
 F of S Distribution
 F of S Calculation Option: Constant
 Advanced
 Number of Slices: 30
 F of S Tolerance: 0.01
 Minimum Slip Surface Depth: 0.1 ft

Materials

TQs150psf-17° bedding 4-8°

Model: Anisotropic Fn.
 Unit Weight: 120 pcf
 Cohesion': 225 psf
 Phi': 40 °
 Phi-Anisotropic Strength Fn.: TQs150psf-17° bedding 4-8°
 C-Anisotropic Strength Fn.: 150psf-17° bedding 4-8°
 Phi-B: 0 °

TQs150psf-11° bedding 4-8°

Model: Anisotropic Fn.
 Unit Weight: 120 pcf
 Cohesion': 225 psf
 Phi': 40 °
 Phi-Anisotropic Strength Fn.: TQs150psf-11° bedding 4-8°
 C-Anisotropic Strength Fn.: 150psf-11° bedding 4-8°
 Phi-B: 0 °

Slip Surface Limits

Left Coordinate: (-177.5082, 1,801) ft
 Right Coordinate: (550, 1,953) ft

Slip Surface Block

Left Grid
 Upper Left: (187.968, 1,876.0315) ft
 Lower Left: (197.2912, 1,806.9576) ft
 Lower Right: (269.9924, 1,838.286) ft
 X Increments: 10
 Y Increments: 10
 Starting Angle: 135 °
 Ending Angle: 180 °
 Angle Increments: 2
 Right Grid
 Upper Left: (333.3485, 1,910.6689) ft
 Lower Left: (339.0092, 1,860.8593) ft
 Lower Right: (415.9794, 1,896.8331) ft

file:///G:/SLOPE%20RESULTS/Section%207-7%20results/updated%203-21-2016/section... 3/21/2016

X Increments: 10
 Y Increments: 10
 Starting Angle: 45 °
 Ending Angle: 65 °
 Angle Increments: 2

Seismic Coefficients

Horz Seismic Coef.: 0
 Vert Seismic Coef.: 0

Anisotropic Strength Functions

TQs150psf-17° bedding 4-8°

Model: Spline Data Point Function
 Function: Modifier Factor vs. Inclination
 Curve Fit to Data: 100 %
 Segment Curvature: 0 %

Y-Intercept: 1
 Data Points: Inclination (°), Modifier Factor
 Data Point: (-90, 1)
 Data Point: (3.9, 1)
 Data Point: (4, 0.425)
 Data Point: (8, 0.425)
 Data Point: (8.1, 1)

150psf-17° bedding 4-8°

Model: Spline Data Point Function
 Function: Modifier Factor vs. Inclination
 Curve Fit to Data: 100 %
 Segment Curvature: 0 %

Y-Intercept: 1
 Data Points: Inclination (°), Modifier Factor
 Data Point: (-90, 1)
 Data Point: (3.9, 1)
 Data Point: (4, 0.667)
 Data Point: (8, 0.667)
 Data Point: (8.1, 1)

TQs150psf-11° bedding 4-8°

Model: Spline Data Point Function
 Function: Modifier Factor vs. Inclination
 Curve Fit to Data: 100 %
 Segment Curvature: 0 %

Y-Intercept: 1
 Data Points: Inclination (°), Modifier Factor
 Data Point: (-90, 1)
 Data Point: (3.9, 1)
 Data Point: (4, 0.275)

Data Point: (8, 0.275)
 Data Point: (8.1, 1)

150psf-11° bedding 4-8°

Model: Spline Data Point Function
 Function: Modifier Factor vs. Inclination
 Curve Fit to Data: 100 %
 Segment Curvature: 0 %

Y-Intercept: 1
 Data Points: Inclination (°), Modifier Factor
 Data Point: (-90, 1)
 Data Point: (3.9, 1)
 Data Point: (4, 0.667)
 Data Point: (8, 0.667)
 Data Point: (8.1, 1)

Points

	X (ft)	Y (ft)
Point 1	-177	1,890
Point 2	-151	1,906
Point 3	-37	1,898
Point 4	56	1,894
Point 5	76	1,891
Point 6	101	1,890
Point 7	123	1,887
Point 8	157	1,879
Point 9	181	1,879
Point 10	207	1,880
Point 11	406	1,950
Point 12	446	1,951
Point 13	482	1,952
Point 14	506	1,952
Point 15	550	1,953
Point 16	550	1,910
Point 17	550	1,857
Point 18	550	1,833
Point 19	550	1,801
Point 20	433	1,801
Point 21	271	1,801
Point 22	-177.5082	1,801
Point 23	-200	1,800.4977
Point 24	217	1,870
Point 25	247	1,870
Point 26	-85	1,801
Point 27	550	1,893

Regions

	Material	Points	Area (ft ²)
Region 1	TQs150psf-17° bedding 4-8°	1,22,26,27,16,15,14,13,12,11,25,24,10,9,8,7,6,5,4,3,2	48,206
Region 2	TQs150psf-11° bedding 4-8°	26,21,20,19,18,17,27	29,210

Current Slip Surface

Slip Surface: 80,306
 F of S: 1.35
 Volume: 4,025.9453 ft³
 Weight: 483,113.44 lbs
 Resisting Force: 186,246.05 lbs
 Activating Force: 138,339.21 lbs
 F of S Rank (Analysis): 1 of 131,769 slip surfaces
 F of S Rank (Query): 1 of 20 slip surfaces
 Exit: (249.57834, 1,871.2973) ft
 Entry: (419.44452, 1,950.3361) ft
 Radius: 106.60257 ft
 Center: (306.92882, 1,970.0958) ft

Slip Slices

	X (ft)	Y (ft)	PWP (psf)	Base Normal Stress (psf)	Frictional Strength (psf)	Cohesive Strength (psf)
Slice 1	252.45979	1,871.6953	0	107.51923	32.871927	150.075
Slice 2	258.22269	1,872.4912	0	352.30531	107.71054	150.075
Slice 3	263.9856	1,873.2871	0	597.0914	182.54916	150.075
Slice 4	269.7485	1,874.0831	0	841.87749	257.38778	150.075
Slice 5	275.5114	1,874.879	0	1,086.6636	332.22639	150.075
Slice 6	281.2743	1,875.675	0	1,331.4497	407.06501	150.075
Slice 7	287.0372	1,876.4709	0	1,576.2357	481.90363	150.075
Slice 8	292.8001	1,877.2669	0	1,821.0218	556.74224	150.075
Slice 9	298.563	1,878.0628	0	2,065.8079	631.58086	150.075
Slice 10	304.3259	1,878.8588	0	2,310.594	706.41948	150.075
Slice 11	310.0888	1,879.6547	0	2,555.3801	781.2581	150.075

Slice 12	315.8517	1,880.4507	0	2,800.1662	856.09671	150.075
Slice 13	321.6146	1,881.2466	0	3,044.9523	930.93533	150.075
Slice 14	327.3775	1,882.0426	0	3,289.7383	1,005.7739	150.075
Slice 15	333.1404	1,882.8385	0	3,534.5244	1,080.6126	150.075
Slice 16	338.90331	1,883.6345	0	3,779.3105	1,155.4512	150.075
Slice 17	344.66621	1,884.4304	0	4,024.0966	1,230.2898	150.075
Slice 18	350.42911	1,885.2264	0	4,268.8827	1,305.1284	150.075
Slice 19	356.19201	1,886.0223	0	4,513.6688	1,379.967	150.075
Slice 20	361.95491	1,886.8183	0	4,758.4549	1,454.8056	150.075
Slice 21	367.71781	1,887.6142	0	5,003.2409	1,529.6443	150.075
Slice 22	373.48071	1,888.4101	0	5,248.027	1,604.4829	150.075
Slice 23	379.32594	1,893.0408	0	2,643.0094	2,217.7482	225
Slice 24	385.25351	1,901.5063	0	2,294.2888	1,925.1368	225
Slice 25	391.18108	1,909.9717	0	1,945.5681	1,632.5255	225
Slice 26	397.10865	1,918.4372	0	1,596.8474	1,339.9141	225
Slice 27	403.03622	1,926.9026	0	1,248.1268	1,047.3027	225
Slice 28	409.36113	1,935.9355	0	773.81792	649.31033	225
Slice 29	416.08339	1,945.5359	0	173.92083	145.93691	225

Section 8-8 Static Final with keyway SSA for Skyline Ranch.gsz

Section 8-8 Static Final with keyway SSA for Skyline Ranch.gsz Run By: Dr. Alexander Bykovtsev, Ph.D., P.E. 3/22/2016 9:37:29 AM

Name: TQs100-25° bedding 3-14°
 Model: Anisotropic Fn.
 Unit Weight: 120 pcf
 Cohesion: 225 psf
 Phi: 40 °
 Phi-Anisotropic Strength Fn.: TQs100-25° bedding 3-14°
 C-Anisotropic Strength Fn.: 100pcf-25° bedding 3-14°

- Materials**
- TQs100-25° bedding 3-14°
 - Tmc150-17° bedding 13-17°
 - Fill
 - Tmc100psf-25° bedding 0-15°

Name: Tmc150-17° bedding 13-17°
 Model: Anisotropic Fn.
 Unit Weight: 120 pcf
 Cohesion: 200 psf
 Phi: 40 °
 Phi-Anisotropic Strength Fn.: Tmc150-17° bedding 13-17°
 C-Anisotropic Strength Fn.: 150psf-17° bedding 13-17°

Name: Fill
 Model: Mohr-Coulomb
 Unit Weight: 120 pcf
 Cohesion: 200 psf
 Phi: 33 °

Name: Tmc100psf-25° bedding 0-15°
 Model: Anisotropic Fn.
 Unit Weight: 120 pcf
 Cohesion: 200 psf
 Phi: 40 °
 Phi-Anisotropic Strength Fn.: Tmc100-25° bedding 0-15°
 C-Anisotropic Strength Fn.: 100pcf-25° bedding 0-15°

Keyway depth 5'
 width 45', backcut slope 2H:1V

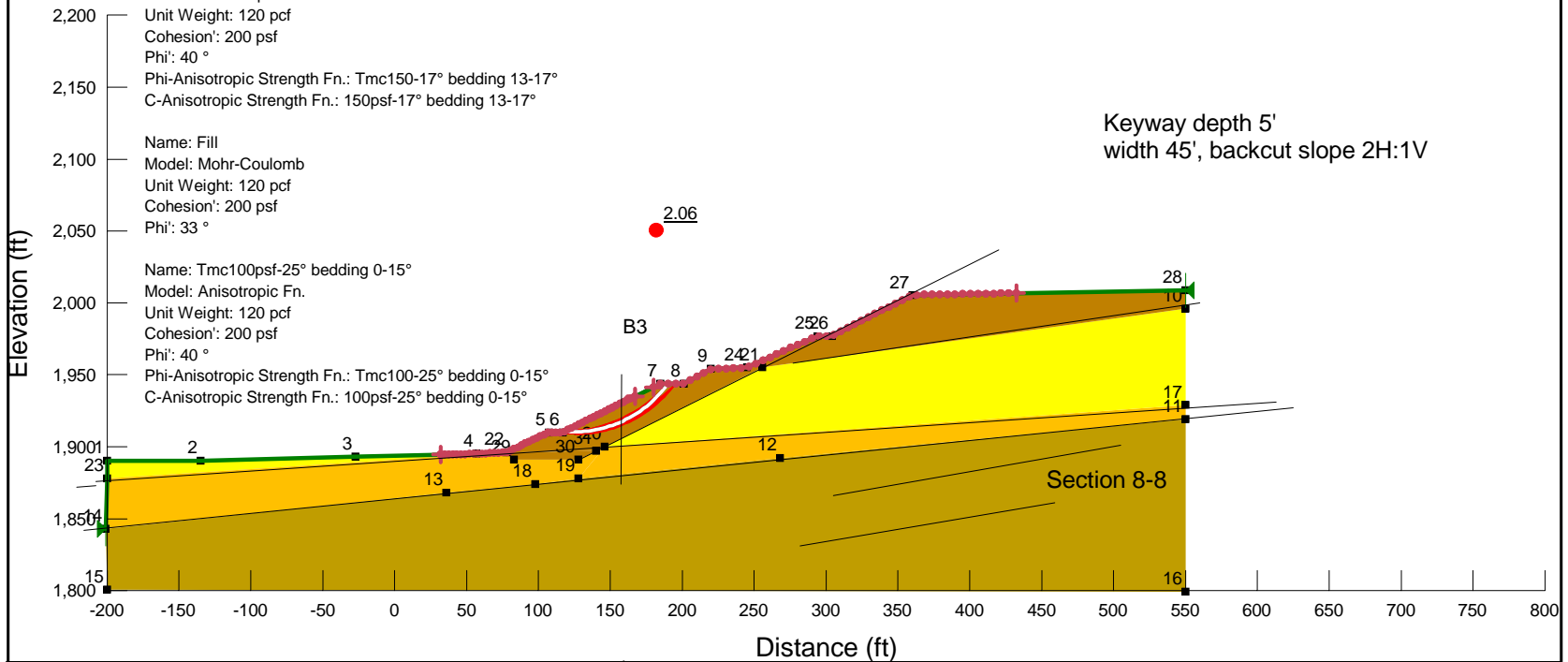

LGC **LGC Valley, Inc**
 GEOTECHNICAL CONSULTING
 28532 Constellation Road, Valencia, CA 91355
 Phone 661-702-8474, Fax 661-702-8475

Skyline Ranch
 Development project, Tract 60922
 Los Angeles CA

Project No: **153035-01**
 Engineer: **BAS**
 Date: **March 2016**

1 - Circular Mode of Failure

Report generated using GeoStudio 2012. Copyright © 1991-2015 GEO-SLOPE International Ltd.

File Information

File Version: 8.15
 Title: Static Slope Stability Analyses for Skyline Ranch Development project, Tract 60922, Los Angeles CA
 Comments: Run By: Dr. Alexander Bykovtsev, Ph.D., P.E.
 Last Edited By: Alexander Bykovtsev
 Revision Number: 158
 Date: 3/22/2016
 Time: 9:37:29 AM
 Tool Version: 8.15.1.11236
 File Name: Section 8-8 Static Final with keyway SSA for Skyline Ranch.gsz
 Directory: G:\SLOPE RESULTS\Section 8-8 results\Latest updated 3-21-2016\
 Last Solved Date: 3/22/2016
 Last Solved Time: 9:37:45 AM

Project Settings

Length(L) Units: Feet
 Time(t) Units: Seconds
 Force(F) Units: Pounds
 Pressure(p) Units: psf
 Strength Units: psf
 Unit Weight of Water: 62.4 pcf
 View: 2D
 Element Thickness: 1

Analysis Settings

1 - Circular Mode of Failure

Kind: [SLOPE/W](#)
 Method: [Bishop](#)
 Settings
 PWP Conditions Source: [\(none\)](#)
 Slip Surface
 Direction of movement: [Right to Left](#)
 Use Passive Mode: [No](#)
 Slip Surface Option: [Entry and Exit](#)
 Critical slip surfaces saved: 1
 Resisting Side Maximum Convex Angle: 1 °
 Driving Side Maximum Convex Angle: 5 °
 Optimize Critical Slip Surface Location: [No](#)
 Tension Crack
 Tension Crack Option: [\(none\)](#)

file:///G:/SLOPE%20RESULTS/Section%208-8%20results/Latest%20updated%203-21-20... 3/22/2016

F of S Distribution
 F of S Calculation Option: [Constant](#)
 Advanced
 Number of Slices: 30
 F of S Tolerance: 0.01
 Minimum Slip Surface Depth: 0.1 ft

Materials

TQs100-25° bedding 3-14°

Model: [Anisotropic Fn.](#)
 Unit Weight: 120 pcf
 Cohesion': 225 psf
 Phi': 40 °
 Phi-Anisotropic Strength Fn.: TQs100-25° bedding 3-14°
 C-Anisotropic Strength Fn.: 100pcf-25° bedding 3-14°
 Phi-B: 0 °

Tmc150-17° bedding 13-17°

Model: [Anisotropic Fn.](#)
 Unit Weight: 120 pcf
 Cohesion': 200 psf
 Phi': 40 °
 Phi-Anisotropic Strength Fn.: Tmc150-17° bedding 13-17°
 C-Anisotropic Strength Fn.: 150pcf-17° bedding 13-17°
 Phi-B: 0 °

Fill

Model: [Mohr-Coulomb](#)
 Unit Weight: 120 pcf
 Cohesion': 200 psf
 Phi': 33 °
 Phi-B: 0 °

Tmc100psf-25° bedding 0-15°

Model: [Anisotropic Fn.](#)
 Unit Weight: 120 pcf
 Cohesion': 200 psf
 Phi': 40 °
 Phi-Anisotropic Strength Fn.: Tmc100-25° bedding 0-15°
 C-Anisotropic Strength Fn.: 100psf-25° bedding 0-15°
 Phi-B: 0 °

Slip Surface Entry and Exit

Left Projection: [Range](#)
 Left-Zone Left Coordinate: (31.8663, 1,894.4016) ft
 Left-Zone Right Coordinate: (167, 1,935) ft
 Left-Zone Increment: 50

file:///G:/SLOPE%20RESULTS/Section%208-8%20results/Latest%20updated%203-21-20... 3/22/2016

Right Projection: Range
 Right-Zone Left Coordinate: (180.1299, 1,941.5649) ft
 Right-Zone Right Coordinate: (432.5595, 2,006.8366) ft
 Right-Zone Increment: 50
 Radius Increments: 50

Slip Surface Limits

Left Coordinate: (-201, 1,843) ft
 Right Coordinate: (550, 2,009) ft

Seismic Coefficients

Horz Seismic Coef.: 0
 Vert Seismic Coef.: 0

Anisotropic Strength Functions

Tmc100-25° bedding 0-15°

Model: Spline Data Point Function
 Function: Modifier Factor vs. Inclination
 Curve Fit to Data: 100 %
 Segment Curvature: 0 %
 Y-Intercept: 0.625
 Data Points: Inclination (°), Modifier Factor
 Data Point: (-90, 1)
 Data Point: (-0.9, 1)
 Data Point: (0, 0.625)
 Data Point: (15, 0.625)
 Data Point: (15.1, 1)

100pcf-25° bedding 3-14°

Model: Spline Data Point Function
 Function: Modifier Factor vs. Inclination
 Curve Fit to Data: 100 %
 Segment Curvature: 0 %
 Y-Intercept: 1
 Data Points: Inclination (°), Modifier Factor
 Data Point: (-90, 1)
 Data Point: (2.9, 1)
 Data Point: (3, 0.444)
 Data Point: (14, 0.444)
 Data Point: (14.1, 1)

100psf-25° bedding 0-15°

Model: Spline Data Point Function
 Function: Modifier Factor vs. Inclination
 Curve Fit to Data: 100 %

Segment Curvature: 0 %
 Y-Intercept: 0.5
 Data Points: Inclination (°), Modifier Factor
 Data Point: (-90, 1)
 Data Point: (-0.9, 1)
 Data Point: (0, 0.5)
 Data Point: (15, 0.5)
 Data Point: (15.1, 1)

TQs100-25° bedding 3-14°

Model: Spline Data Point Function
 Function: Modifier Factor vs. Inclination
 Curve Fit to Data: 100 %
 Segment Curvature: 0 %
 Y-Intercept: 1
 Data Points: Inclination (°), Modifier Factor
 Data Point: (-90, 1)
 Data Point: (2.9, 1)
 Data Point: (3, 0.625)
 Data Point: (14, 0.625)
 Data Point: (14.1, 1)

Tmc150-17° bedding 13-17°

Model: Spline Data Point Function
 Function: Modifier Factor vs. Inclination
 Curve Fit to Data: 100 %
 Segment Curvature: 0 %
 Y-Intercept: 1
 Data Points: Inclination (°), Modifier Factor
 Data Point: (-90, 1)
 Data Point: (12.9, 1)
 Data Point: (13, 0.425)
 Data Point: (17, 0.425)
 Data Point: (17.1, 1)

150psf-17° bedding 13-17°

Model: Spline Data Point Function
 Function: Modifier Factor vs. Inclination
 Curve Fit to Data: 100 %
 Segment Curvature: 0 %
 Y-Intercept: 1
 Data Points: Inclination (°), Modifier Factor
 Data Point: (-90, 1)
 Data Point: (12.9, 1)
 Data Point: (13, 0.75)
 Data Point: (17, 0.75)
 Data Point: (17.1, 1)

Points



	X (ft)	Y (ft)
Point 1	-200	1,890
Point 2	-135	1,890
Point 3	-27	1,893
Point 4	57	1,895
Point 5	107	1,910
Point 6	117	1,910
Point 7	185	1,944
Point 8	201	1,944
Point 9	220	1,954
Point 10	550	1,996
Point 11	550	1,919
Point 12	268	1,892
Point 13	36	1,868
Point 14	-201	1,843
Point 15	-200	1,800.4977
Point 16	550	1,799
Point 17	550	1,929
Point 18	98	1,874
Point 19	128	1,878
Point 20	146	1,900
Point 21	256	1,955
Point 22	78	1,896
Point 23	-200	1,878

Point 24	245	1,955
Point 25	294	1,977
Point 26	304	1,977
Point 27	360	2,005.5
Point 28	550	2,009
Point 29	83	1,891
Point 30	128	1,891
Point 31	140	1,897

Regions

	Material	Points	Area (ft²)
Region 1	Tmc150-17° bedding 13-17°	11,12,19,18,13,14,15,16	61,653
Region 2	Tmc100psf-25° bedding 0-15°	12,11,17,20,19	6,209
Region 3	TQs100-25° bedding 3-14°	1,23,22,4,3,2	1,447.5
Region 4	Tmc100psf-25° bedding 0-15°	23,14,13,18,29,22	8,396
Region 5	TQs100-25° bedding 3-14°	20,21,10,17	19,364
Region 6	Tmc100psf-25° bedding 0-15°	18,19,20,31,30,29	694.5
Region 7	Fill	22,5,6,7,8,9,24,25,26,27,28,10,21,20,31	9,516
Region 8	Fill	22,29,30,31	292.5

Current Slip Surface

Slip Surface: 80,754
 F of S: 2.06
 Volume: 648.41255 ft³
 Weight: 77,809.507 lbs
 Resisting Moment: 5,233,028.6 lbs-ft
 Activating Moment: 2,546,265.3 lbs-ft
 F of S Rank (Analysis): 1 of 132,651 slip surfaces
 F of S Rank (Query): 1 of 50 slip surfaces
 Exit: (117.96558, 1,910.4828) ft
 Entry: (190.23724, 1,944) ft
 Radius: 81.288567 ft
 Center: (124.28877, 1,991.5251) ft

Slip Slices

	X (ft)	Y (ft)	PWP (psf)	Base Normal Stress (psf)	Frictional Strength (psf)	Cohesive Strength (psf)

Slice 1	119.16263	1,910.4071	0	88.81307	57.675882	200
Slice 2	121.55671	1,910.2912	0	244.3156	158.6604	200
Slice 3	123.9508	1,910.246	0	388.44124	252.25669	200
Slice 4	126.34489	1,910.2713	0	521.51091	338.67315	200
Slice 5	128.73897	1,910.3672	0	643.79862	418.08771	200
Slice 6	131.13306	1,910.534	0	755.53575	490.65065	200
Slice 7	133.52714	1,910.7721	0	856.91453	556.4868	200
Slice 8	135.92123	1,911.0822	0	948.0908	615.69736	200
Slice 9	138.31532	1,911.465	0	1,029.1861	668.36129	200
Slice 10	140.7094	1,911.9217	0	1,100.2894	714.53632	200
Slice 11	143.10349	1,912.4534	0	1,161.4581	754.2597	200
Slice 12	145.49758	1,913.0618	0	1,212.7185	787.5486	200
Slice 13	147.89166	1,913.7486	0	1,254.0663	814.40021	200
Slice 14	150.28575	1,914.516	0	1,285.4663	834.79156	200
Slice 15	152.67983	1,915.3664	0	1,306.8511	848.67906	200
Slice 16	155.07392	1,916.3025	0	1,318.1208	855.99768	200
Slice 17	157.46801	1,917.3277	0	1,319.1404	856.65979	200
Slice 18	159.86209	1,918.4457	0	1,309.7378	850.55364	200
Slice 19	162.25618	1,919.6608	0	1,289.7005	837.54133	200
Slice 20	164.65027	1,920.9781	0	1,258.7722	817.45625	200
Slice 21	167.04435	1,922.4033	0	1,216.6473	790.09998	200
Slice 22	169.43844	1,923.9435	0	1,162.965	755.23831	200
Slice 23	171.83253	1,925.6066	0	1,097.3023	712.59642	200
Slice 24	174.22661	1,927.4022	0	1,019.1641	661.85291	200

Slice 25	176.6207	1,929.3418	0	927.97273	602.63254	200
Slice 26	179.01478	1,931.4395	0	823.05365	534.49729	200
Slice 27	181.40887	1,933.7125	0	703.61935	456.93575	200
Slice 28	183.80296	1,936.1825	0	568.75018	369.35069	200
Slice 29	186.30931	1,939.0162	0	352.03744	228.61578	200
Slice 30	188.92793	1,942.2814	0	55.621416	36.12097	200

Section 8-8 Seismic Final with keyway SSA for Skyline Ranch.gsz

Section 8-8 Seismic Final with keyway SSA for Skyline Ranch.gsz Run By: Dr. Alexander Bykovtsev, Ph.D., P.E. 3/22/2016 9:28:29 AM

Name: TQs100-25° bedding 3-14°
 Model: Anisotropic Fn.
 Unit Weight: 120 pcf
 Cohesion: 225 psf
 Phi: 40°
 Phi-Anisotropic Strength Fn.: TQs100-25° bedding 3-14°
 C-Anisotropic Strength Fn.: 100pcf-25° bedding 3-14°

Materials

- TQs100-25° bedding 3-14°
- Tmc150-17° bedding 13-17°
- Fill
- Tmc100pcf-25° bedding 0-15°

Seismic load
 Horizontal: 0.15
 Vertical: 0.0

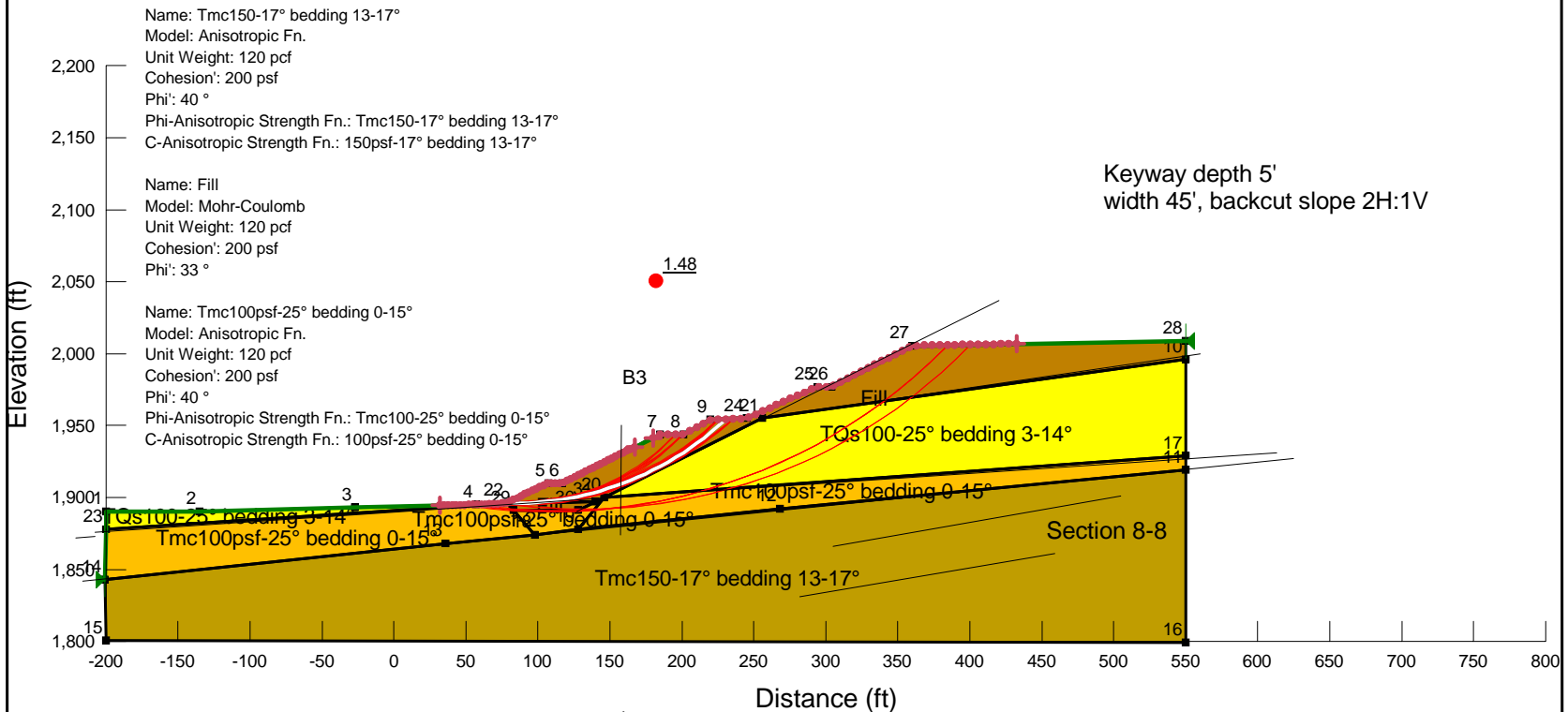

	<p>LGC Valley, Inc GEOTECHNICAL CONSULTING 28532 Constellation Road, Valencia, CA 91355 Phone 661-702-8474, Fax 661-702-8475</p>	<p>Skyline Ranch Development project, Tract 60922 Los Angeles CA</p>	<p>Project No: 153035-01 Engineer: BAS Date: March 2016</p>
--	--	---	--

1 - Circular Mode of Failure

Report generated using GeoStudio 2012. Copyright © 1991-2015 GEO-SLOPE International Ltd.

File Information

File Version: 8.15
 Title: Static Slope Stability Analyses for Skyline Ranch Development project, Tract 60922, Los Angeles CA
 Comments: Run By: Dr. Alexander Bykovtsev, Ph.D., P.E.
 Last Edited By: Alexander Bykovtsev
 Revision Number: 155
 Date: 3/22/2016
 Time: 9:28:29 AM
 Tool Version: 8.15.1.11236
 File Name: Section 8-8 Seismic Final with keyway SSA for Skyline Ranch.gsz
 Directory: G:\SLOPE RESULTS\Section 8-8 results\Latest updated 3-21-2016\
 Last Solved Date: 3/22/2016
 Last Solved Time: 9:28:45 AM

Project Settings

Length(L) Units: Feet
 Time(t) Units: Seconds
 Force(F) Units: Pounds
 Pressure(p) Units: psf
 Strength Units: psf
 Unit Weight of Water: 62.4 pcf
 View: 2D
 Element Thickness: 1

Analysis Settings

1 - Circular Mode of Failure

Kind: SLOPE/W
 Method: Bishop
 Settings
 PWP Conditions Source: (none)
 Slip Surface
 Direction of movement: Right to Left
 Use Passive Mode: No
 Slip Surface Option: Entry and Exit
 Critical slip surfaces saved: 1
 Resisting Side Maximum Convex Angle: 1 °
 Driving Side Maximum Convex Angle: 5 °
 Optimize Critical Slip Surface Location: No
 Tension Crack
 Tension Crack Option: (none)

file:///G:/SLOPE%20RESULTS/Section%208-8%20results/Latest%20updated%203-21-20... 3/22/2016

F of S Distribution
 F of S Calculation Option: Constant
 Advanced
 Number of Slices: 30
 F of S Tolerance: 0.01
 Minimum Slip Surface Depth: 0.1 ft

Materials

TQs100-25° bedding 3-14°

Model: Anisotropic Fn.
 Unit Weight: 120 pcf
 Cohesion': 225 psf
 Phi': 40 °
 Phi-Anisotropic Strength Fn.: TQs100-25° bedding 3-14°
 C-Anisotropic Strength Fn.: 100pcf-25° bedding 3-14°
 Phi-B: 0 °

Tmc150-17° bedding 13-17°

Model: Anisotropic Fn.
 Unit Weight: 120 pcf
 Cohesion': 200 psf
 Phi': 40 °
 Phi-Anisotropic Strength Fn.: Tmc150-17° bedding 13-17°
 C-Anisotropic Strength Fn.: 150pcf-17° bedding 13-17°
 Phi-B: 0 °

Fill

Model: Mohr-Coulomb
 Unit Weight: 120 pcf
 Cohesion': 200 psf
 Phi': 33 °
 Phi-B: 0 °

Tmc100psf-25° bedding 0-15°

Model: Anisotropic Fn.
 Unit Weight: 120 pcf
 Cohesion': 200 psf
 Phi': 40 °
 Phi-Anisotropic Strength Fn.: Tmc100-25° bedding 0-15°
 C-Anisotropic Strength Fn.: 100psf-25° bedding 0-15°
 Phi-B: 0 °

Slip Surface Entry and Exit

Left Projection: Range
 Left-Zone Left Coordinate: (31.8663, 1,894.4016) ft
 Left-Zone Right Coordinate: (167, 1,935) ft
 Left-Zone Increment: 50

file:///G:/SLOPE%20RESULTS/Section%208-8%20results/Latest%20updated%203-21-20... 3/22/2016

Right Projection: Range
Right-Zone Left Coordinate: (180.1299, 1,941.5649) ft
Right-Zone Right Coordinate: (432.5595, 2,006.8366) ft
Right-Zone Increment: 50
Radius Increments: 50

Slip Surface Limits

Left Coordinate: (-201, 1,843) ft
Right Coordinate: (550, 2,009) ft

Seismic Coefficients

Horz Seismic Coef.: 0.15
Vert Seismic Coef.: 0

Anisotropic Strength Functions

Tmc100-25° bedding 0-15°

Model: Spline Data Point Function
Function: Modifier Factor vs. Inclination
Curve Fit to Data: 100 %
Segment Curvature: 0 %
Y-Intercept: 0.625
Data Points: Inclination (°), Modifier Factor
Data Point: (-90, 1)
Data Point: (-0.9, 1)
Data Point: (0, 0.625)
Data Point: (15, 0.625)
Data Point: (15.1, 1)

100pcf-25° bedding 3-14°

Model: Spline Data Point Function
Function: Modifier Factor vs. Inclination
Curve Fit to Data: 100 %
Segment Curvature: 0 %
Y-Intercept: 1
Data Points: Inclination (°), Modifier Factor
Data Point: (-90, 1)
Data Point: (2.9, 1)
Data Point: (3, 0.444)
Data Point: (14, 0.444)
Data Point: (14.1, 1)

100psf-25° bedding 0-15°

Model: Spline Data Point Function
Function: Modifier Factor vs. Inclination
Curve Fit to Data: 100 %

Segment Curvature: 0 %
Y-Intercept: 0.5
Data Points: Inclination (°), Modifier Factor
Data Point: (-90, 1)
Data Point: (-0.9, 1)
Data Point: (0, 0.5)
Data Point: (15, 0.5)
Data Point: (15.1, 1)

TQs100-25° bedding 3-14°

Model: Spline Data Point Function
Function: Modifier Factor vs. Inclination
Curve Fit to Data: 100 %
Segment Curvature: 0 %
Y-Intercept: 1
Data Points: Inclination (°), Modifier Factor
Data Point: (-90, 1)
Data Point: (2.9, 1)
Data Point: (3, 0.625)
Data Point: (14, 0.625)
Data Point: (14.1, 1)

Tmc150-17° bedding 13-17°

Model: Spline Data Point Function
Function: Modifier Factor vs. Inclination
Curve Fit to Data: 100 %
Segment Curvature: 0 %
Y-Intercept: 1
Data Points: Inclination (°), Modifier Factor
Data Point: (-90, 1)
Data Point: (12.9, 1)
Data Point: (13, 0.425)
Data Point: (17, 0.425)
Data Point: (17.1, 1)

150psf-17° bedding 13-17°

Model: Spline Data Point Function
Function: Modifier Factor vs. Inclination
Curve Fit to Data: 100 %
Segment Curvature: 0 %
Y-Intercept: 1
Data Points: Inclination (°), Modifier Factor
Data Point: (-90, 1)
Data Point: (12.9, 1)
Data Point: (13, 0.75)
Data Point: (17, 0.75)
Data Point: (17.1, 1)

Points



	X (ft)	Y (ft)
Point 1	-200	1,890
Point 2	-135	1,890
Point 3	-27	1,893
Point 4	57	1,895
Point 5	107	1,910
Point 6	117	1,910
Point 7	185	1,944
Point 8	201	1,944
Point 9	220	1,954
Point 10	550	1,996
Point 11	550	1,919
Point 12	268	1,892
Point 13	36	1,868
Point 14	-201	1,843
Point 15	-200	1,800.4977
Point 16	550	1,799
Point 17	550	1,929
Point 18	98	1,874
Point 19	128	1,878
Point 20	146	1,900
Point 21	256	1,955
Point 22	78	1,896
Point 23	-200	1,878

Point 24	245	1,955
Point 25	294	1,977
Point 26	304	1,977
Point 27	360	2,005.5
Point 28	550	2,009
Point 29	83	1,891
Point 30	128	1,891
Point 31	140	1,897

Regions

	Material	Points	Area (ft²)
Region 1	Tmc150-17° bedding 13-17°	11,12,19,18,13,14,15,16	61,653
Region 2	Tmc100psf-25° bedding 0-15°	12,11,17,20,19	6,209
Region 3	TQs100-25° bedding 3-14°	1,23,22,4,3,2	1,447.5
Region 4	Tmc100psf-25° bedding 0-15°	23,14,13,18,29,22	8,396
Region 5	TQs100-25° bedding 3-14°	20,21,10,17	19,364
Region 6	Tmc100psf-25° bedding 0-15°	18,19,20,31,30,29	694.5
Region 7	Fill	22,5,6,7,8,9,24,25,26,27,28,10,21,20,31	9,516
Region 8	Fill	22,29,30,31	292.5

Current Slip Surface

Slip Surface: 42,140
 F of S: 1.48
 Volume: 2,129.5156 ft³
 Weight: 255,541.87 lbs
 Resisting Moment: 39,750,707 lbs-ft
 Activating Moment: 26,865,927 lbs-ft
 F of S Rank (Analysis): 1 of 132,651 slip surfaces
 F of S Rank (Query): 1 of 50 slip surfaces
 Exit: (78.001259, 1,896.0006) ft
 Entry: (230.48674, 1,954.4195) ft
 Radius: 216.9753 ft
 Center: (82.325339, 2,112.9328) ft

Slip Slices

	X (ft)	Y (ft)	PWP (psf)	Base Normal Stress (psf)	Frictional Strength (psf)	Cohesive Strength (psf)

Slice 1	78.009414	1,896.0004	0	3.2043685	2.0809412	200
Slice 2	80.61912	1,895.9798	0	155.74732	101.14349	200
Slice 3	85.822221	1,896.0013	0	447.65659	290.71159	200
Slice 4	91.025322	1,896.1476	0	718.79949	466.79385	200
Slice 5	95.855727	1,896.3913	0	952.92412	618.83616	200
Slice 6	100.31344	1,896.716	0	1,153.4495	749.05883	200
Slice 7	104.77115	1,897.1333	0	1,339.7967	870.07412	200
Slice 8	109.5	1,897.6807	0	1,384.6889	899.2275	200
Slice 9	114.5	1,898.3712	0	1,290.4376	838.01995	200
Slice 10	119.61538	1,899.2024	0	1,327.6056	862.15715	200
Slice 11	124.84615	1,900.1814	0	1,491.429	968.54535	200
Slice 12	130.07692	1,901.2943	0	1,637.0297	1,063.0995	200
Slice 13	135.30769	1,902.543	0	1,764.6215	1,145.9586	200
Slice 14	140.53846	1,903.9301	0	1,874.3786	1,217.2357	200
Slice 15	145.76923	1,905.4583	0	1,966.4365	1,277.0188	200
Slice 16	151	1,907.1308	0	2,040.8934	1,325.3716	200
Slice 17	156.23077	1,908.9511	0	2,097.8105	1,362.3341	200
Slice 18	161.46154	1,910.9233	0	2,137.2134	1,387.9226	200
Slice 19	166.69231	1,913.0518	0	2,159.091	1,402.1301	200
Slice 20	171.92308	1,915.3416	0	2,163.3964	1,404.9261	200
Slice 21	177.15385	1,917.7986	0	2,150.0457	1,396.256	200
Slice 22	182.38462	1,920.429	0	2,118.9177	1,376.0413	200
Slice 23	187.66667	1,923.2695	0	1,940.5046	1,260.1784	200
Slice 24	193	1,926.3322	0	1,619.3073	1,051.5905	200

Slice 25	198.33333	1,929.6012	0	1,285.9492	835.10516	200
Slice 26	203.375	1,932.8854	0	1,076.0599	698.80148	200
Slice 27	208.125	1,936.1724	0	985.8633	640.22711	200
Slice 28	212.875	1,939.652	0	879.71045	571.29065	200
Slice 29	217.625	1,943.3361	0	757.31664	491.80718	200
Slice 30	222.62168	1,947.4535	0	498.56692	323.77315	200
Slice 31	227.86505	1,952.0478	0	107.38548	69.736949	200

Section 8-8 Static Final with keyway SSA for Skyline Ranch.gsz

Section 8-8 Static Final with keyway SSA for Skyline Ranch.gsz Run By: Dr. Alexander Bykovtsev, Ph.D., P.E. 3/22/2016 9:34:48 AM

Name: TQs100-25° bedding 3-14°
 Model: Anisotropic Fn.
 Unit Weight: 120 pcf
 Cohesion: 225 psf
 Phi: 40 °
 Phi-Anisotropic Strength Fn.: TQs100-25° bedding 3-14°
 C-Anisotropic Strength Fn.: 100pcf-25° bedding 3-14°

- Materials**
- TQs100-25° bedding 3-14°
 - Tmc150-17° bedding 13-17°
 - Fill
 - Tmc100psf-25° bedding 0-15°

Name: Tmc150-17° bedding 13-17°
 Model: Anisotropic Fn.
 Unit Weight: 120 pcf
 Cohesion: 200 psf
 Phi: 40 °
 Phi-Anisotropic Strength Fn.: Tmc150-17° bedding 13-17°
 C-Anisotropic Strength Fn.: 150psf-17° bedding 13-17°

Name: Fill
 Model: Mohr-Coulomb
 Unit Weight: 120 pcf
 Cohesion: 200 psf
 Phi: 33 °

Name: Tmc100psf-25° bedding 0-15°
 Model: Anisotropic Fn.
 Unit Weight: 120 pcf
 Cohesion: 200 psf
 Phi: 40 °
 Phi-Anisotropic Strength Fn.: Tmc100-25° bedding 0-15°
 C-Anisotropic Strength Fn.: 100psf-25° bedding 0-15°

Keyway depth 5'
 width 45', backcut slope 2H:1V

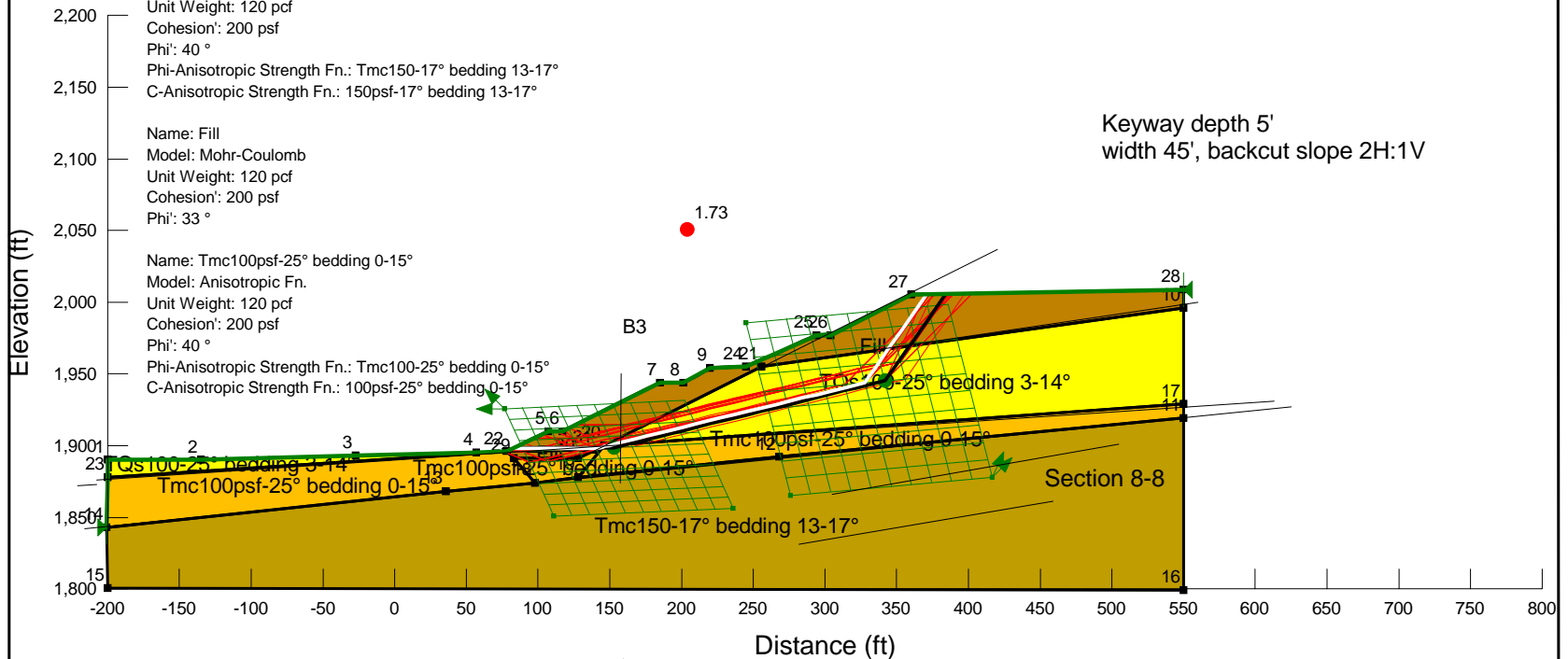

LGC Valley, Inc
 GEOTECHNICAL CONSULTING
 28532 Constellation Road, Valencia, CA 91355
 Phone 661-702-8474, Fax 661-702-8475

Skyline Ranch
 Development project, Tract 60922
 Los Angeles CA

Project No: **153035-01**
 Engineer: **BAS**
 Date: **March 2016**

2 - Translational

Report generated using GeoStudio 2012. Copyright © 1991-2015 GEO-SLOPE International Ltd.

File Information

File Version: 8.15
 Title: Static Slope Stability Analyses for Skyline Ranch Development project, Tract 60922, Los Angeles CA
 Comments: Run By: Dr. Alexander Bykovtsev, Ph.D., P.E.
 Last Edited By: Alexander Bykovtsev
 Revision Number: 157
 Date: 3/22/2016
 Time: 9:34:48 AM
 Tool Version: 8.15.1.11236
 File Name: Section 8-8 Static Final with keyway SSA for Skyline Ranch.gsz
 Directory: G:\SLOPE RESULTS\Section 8-8 results\Latest updated 3-21-2016\
 Last Solved Date: 3/22/2016
 Last Solved Time: 9:35:28 AM

Project Settings

Length(L) Units: Feet
 Time(t) Units: Seconds
 Force(F) Units: Pounds
 Pressure(p) Units: psf
 Strength Units: psf
 Unit Weight of Water: 62.4 pcf
 View: 2D
 Element Thickness: 1

Analysis Settings

2 - Translational

Kind: SLOPE/W
 Method: Janbu
 Settings
 PWP Conditions Source: (none)
 Slip Surface
 Direction of movement: Right to Left
 Use Passive Mode: No
 Slip Surface Option: Block
 Critical slip surfaces saved: 10
 Resisting Side Maximum Convex Angle: 1 °
 Driving Side Maximum Convex Angle: 5 °
 Restrict Block Crossing: No
 Optimize Critical Slip Surface Location: No
 Tension Crack

file:///G:/SLOPE%20RESULTS/Section%208-8%20results/Latest%20updated%203-21-20... 3/22/2016

Tension Crack Option: (none)
 F of S Distribution
 F of S Calculation Option: Constant
 Advanced
 Number of Slices: 30
 F of S Tolerance: 0.01
 Minimum Slip Surface Depth: 0.1 ft

Materials

TQs100-25° bedding 3-14°

Model: Anisotropic Fn.
 Unit Weight: 120 pcf
 Cohesion': 225 psf
 Phi': 40 °
 Phi-Anisotropic Strength Fn.: TQs100-25° bedding 3-14°
 C-Anisotropic Strength Fn.: 100pcf-25° bedding 3-14°
 Phi-B: 0 °

Tmc150-17° bedding 13-17°

Model: Anisotropic Fn.
 Unit Weight: 120 pcf
 Cohesion': 200 psf
 Phi': 40 °
 Phi-Anisotropic Strength Fn.: Tmc150-17° bedding 13-17°
 C-Anisotropic Strength Fn.: 150psf-17° bedding 13-17°
 Phi-B: 0 °

Fill

Model: Mohr-Coulomb
 Unit Weight: 120 pcf
 Cohesion': 200 psf
 Phi': 33 °
 Phi-B: 0 °

Tmc100psf-25° bedding 0-15°

Model: Anisotropic Fn.
 Unit Weight: 120 pcf
 Cohesion': 200 psf
 Phi': 40 °
 Phi-Anisotropic Strength Fn.: Tmc100-25° bedding 0-15°
 C-Anisotropic Strength Fn.: 100psf-25° bedding 0-15°
 Phi-B: 0 °

Slip Surface Limits

Left Coordinate: (-201, 1,843) ft
 Right Coordinate: (550, 2,009) ft

file:///G:/SLOPE%20RESULTS/Section%208-8%20results/Latest%20updated%203-21-20... 3/22/2016

Slip Surface Block

Left Grid

Upper Left: (76.8746, 1,925.8506) ft
 Lower Left: (110.8805, 1,850.7649) ft
 Lower Right: (236.0227, 1,856.3268) ft
 X Increments: 10
 Y Increments: 10
 Starting Angle: 135 °
 Ending Angle: 180 °
 Angle Increments: 2

Right Grid

Upper Left: (244.9639, 1,985.7845) ft
 Lower Left: (275.7545, 1,865.054) ft
 Lower Right: (416.7433, 1,877.9566) ft
 X Increments: 10
 Y Increments: 10
 Starting Angle: 45 °
 Ending Angle: 65 °
 Angle Increments: 2

Seismic Coefficients

Horz Seismic Coef.: 0
 Vert Seismic Coef.: 0

Anisotropic Strength Functions

Tmc100-25° bedding 0-15°

Model: Spline Data Point Function
 Function: Modifier Factor vs. Inclination
 Curve Fit to Data: 100 %
 Segment Curvature: 0 %
 Y-Intercept: 0.625
 Data Points: Inclination (°), Modifier Factor
 Data Point: (-90, 1)
 Data Point: (-0.9, 1)
 Data Point: (0, 0.625)
 Data Point: (15, 0.625)
 Data Point: (15.1, 1)

100pcf-25° bedding 3-14°

Model: Spline Data Point Function
 Function: Modifier Factor vs. Inclination
 Curve Fit to Data: 100 %
 Segment Curvature: 0 %
 Y-Intercept: 1
 Data Points: Inclination (°), Modifier Factor
 Data Point: (-90, 1)

Data Point: (2.9, 1)
 Data Point: (3, 0.444)
 Data Point: (14, 0.444)
 Data Point: (14.1, 1)

100psf-25° bedding 0-15°

Model: Spline Data Point Function
 Function: Modifier Factor vs. Inclination
 Curve Fit to Data: 100 %
 Segment Curvature: 0 %
 Y-Intercept: 0.5
 Data Points: Inclination (°), Modifier Factor
 Data Point: (-90, 1)
 Data Point: (-0.9, 1)
 Data Point: (0, 0.5)
 Data Point: (15, 0.5)
 Data Point: (15.1, 1)

TQs100-25° bedding 3-14°

Model: Spline Data Point Function
 Function: Modifier Factor vs. Inclination
 Curve Fit to Data: 100 %
 Segment Curvature: 0 %
 Y-Intercept: 1
 Data Points: Inclination (°), Modifier Factor
 Data Point: (-90, 1)
 Data Point: (2.9, 1)
 Data Point: (3, 0.625)
 Data Point: (14, 0.625)
 Data Point: (14.1, 1)

Tmc150-17° bedding 13-17°

Model: Spline Data Point Function
 Function: Modifier Factor vs. Inclination
 Curve Fit to Data: 100 %
 Segment Curvature: 0 %
 Y-Intercept: 1
 Data Points: Inclination (°), Modifier Factor
 Data Point: (-90, 1)
 Data Point: (12.9, 1)
 Data Point: (13, 0.425)
 Data Point: (17, 0.425)
 Data Point: (17.1, 1)

150psf-17° bedding 13-17°

Model: Spline Data Point Function
 Function: Modifier Factor vs. Inclination
 Curve Fit to Data: 100 %
 Segment Curvature: 0 %
 Y-Intercept: 1

Data Points: Inclination (°), Modifier Factor

- Data Point: (-90, 1)
- Data Point: (12.9, 1)
- Data Point: (13, 0.75)
- Data Point: (17, 0.75)
- Data Point: (17.1, 1)

Points

	X (ft)	Y (ft)
Point 1	-200	1,890
Point 2	-135	1,890
Point 3	-27	1,893
Point 4	57	1,895
Point 5	107	1,910
Point 6	117	1,910
Point 7	185	1,944
Point 8	201	1,944
Point 9	220	1,954
Point 10	550	1,996
Point 11	550	1,919
Point 12	268	1,892
Point 13	36	1,868
Point 14	-201	1,843
Point 15	-200	1,800.4977
Point 16	550	1,799
Point 17	550	1,929
Point 18	98	1,874
Point 19	128	1,878
Point 20	146	1,900
Point 21	256	1,955
Point 22	78	1,896
Point 23	-200	1,878
Point 24	245	1,955
Point 25	294	1,977
Point 26	304	1,977
Point 27	360	2,005.5
Point 28	550	2,009
Point 29	83	1,891
Point 30	128	1,891
Point 31	140	1,897

Regions

	Material	Points	Area (ft²)
--	----------	--------	------------

Region 1	Tmc150-17° bedding 13-17°	11,12,19,18,13,14,15,16	61,653
Region 2	Tmc100psf-25° bedding 0-15°	12,11,17,20,19	6,209
Region 3	TQs100-25° bedding 3-14°	1,23,22,4,3,2	1,447.5
Region 4	Tmc100psf-25° bedding 0-15°	23,14,13,18,29,22	8,396
Region 5	TQs100-25° bedding 3-14°	20,21,10,17	19,364
Region 6	Tmc100psf-25° bedding 0-15°	18,19,20,31,30,29	694.5
Region 7	Fill	22,5,6,7,8,9,24,25,26,27,28,10,21,20,31	9,516
Region 8	Fill	22,29,30,31	292.5

Current Slip Surface

Slip Surface: 78,263
 F of S: 1.73
 Volume: 9,473.1768 ft³
 Weight: 1,136,781.2 lbs
 Resisting Force: 556,949.79 lbs
 Activating Force: 321,328.2 lbs
 F of S Rank (Analysis): 2 of 131,769 slip surfaces
 F of S Rank (Query): 2 of 50 slip surfaces
 Exit: (83.380059, 1,898.5973) ft
 Entry: (384.38678, 2,005.9492) ft
 Radius: 160.07064 ft
 Center: (205.16867, 2,032.7872) ft

Slip Slices

	X (ft)	Y (ft)	PWP (psf)	Base Normal Stress (psf)	Frictional Strength (psf)	Cohesive Strength (psf)
Slice 1	89.285044	1,898.5973	0	342.0819	222.15058	200
Slice 2	101.09501	1,898.5973	0	1,026.2457	666.45175	200
Slice 3	112	1,898.5973	0	1,368.3276	888.60233	200
Slice 4	121.36576	1,898.5973	0	1,630.273	1,058.7117	200
Slice 5	130.09727	1,898.5973	0	2,154.1638	1,398.9303	200
Slice 6	138.82878	1,898.5973	0	2,678.0546	1,739.149	200
	144.02343	1,898.5973	0	2,989.7332	1,394.1355	100

Slice 7						
Slice 8	145.42616	1,898.5973	0	3,073.897	1,433.3817	100
Slice 9	149.52403	1,898.5973	0	3,319.7694	1,548.0339	100
Slice 10	158.49512	1,899.9426	0	3,453.2084	1,610.2575	100
Slice 11	169.20664	1,902.5882	0	3,758.2068	1,752.4806	99.9
Slice 12	179.73555	1,905.1886	0	4,057.9925	1,892.273	99.9
Slice 13	189	1,907.4768	0	4,096.7113	1,910.3278	99.9
Slice 14	197	1,909.4526	0	3,874.363	1,806.6451	99.9
Slice 15	205.75	1,911.6137	0	3,912.5004	1,824.4289	99.9
Slice 16	215.25	1,913.9601	0	4,211.1235	1,963.6791	99.9
Slice 17	226.25	1,916.6769	0	4,214.8585	1,965.4208	99.9
Slice 18	238.75	1,919.7642	0	3,923.7055	1,829.6539	99.9
Slice 19	250.5	1,922.6662	0	3,903.1505	1,820.069	99.9
Slice 20	260.75	1,925.1978	0	4,136.1451	1,928.7161	99.9
Slice 21	270.25	1,927.5441	0	4,352.0914	2,029.4135	99.9
Slice 22	279.75	1,929.8905	0	4,568.0376	2,130.1109	99.9
Slice 23	289.25	1,932.2368	0	4,783.9839	2,230.8083	99.9
Slice 24	299	1,934.6449	0	4,752.9893	2,216.3553	99.9
Slice 25	308.73418	1,937.049	0	4,753.5728	2,216.6274	99.9
Slice 26	318.20253	1,939.3876	0	5,032.6751	2,346.775	99.9
Slice 27	327.67089	1,941.7261	0	5,311.7775	2,476.9225	99.9
Slice 28	337.13924	1,944.0646	0	5,590.8798	2,607.0701	99.9
Slice 29	346.0912	1,951.2575	0	3,238.4279	2,717.3637	225
Slice 30	354.52676	1,963.3047	0	2,687.9975	2,255.4977	225

Slice 31	359.37227	1,970.2248	0	2,626.5186	1,705.6811	200
Slice 32	366.0967	1,979.8283	0	1,909.2288	1,239.8677	200
Slice 33	378.29008	1,997.2422	0	564.90322	366.85244	200

Section 8-8 Seismic Final with keyway SSA for Skyline Ranch.gsz

Section 8-8 Seismic Final with keyway SSA for Skyline Ranch.gsz Run By: Dr. Alexander Bykovtsev, Ph.D., P.E. 3/22/2016 9:20:06 AM

Name: TQs100-25° bedding 3-14°
 Model: Anisotropic Fn.
 Unit Weight: 120 pcf
 Cohesion: 225 psf
 Phi: 40°
 Phi-Anisotropic Strength Fn.: TQs100-25° bedding 3-14°
 C-Anisotropic Strength Fn.: 100pcf-25° bedding 3-14°

Materials

- TQs100-25° bedding 3-14°
- Tmc150-17° bedding 13-17°
- Fill
- Tmc100psf-25° bedding 0-15°

Seismic load
 Horizontal: 0.15
 Vertical: 0.0

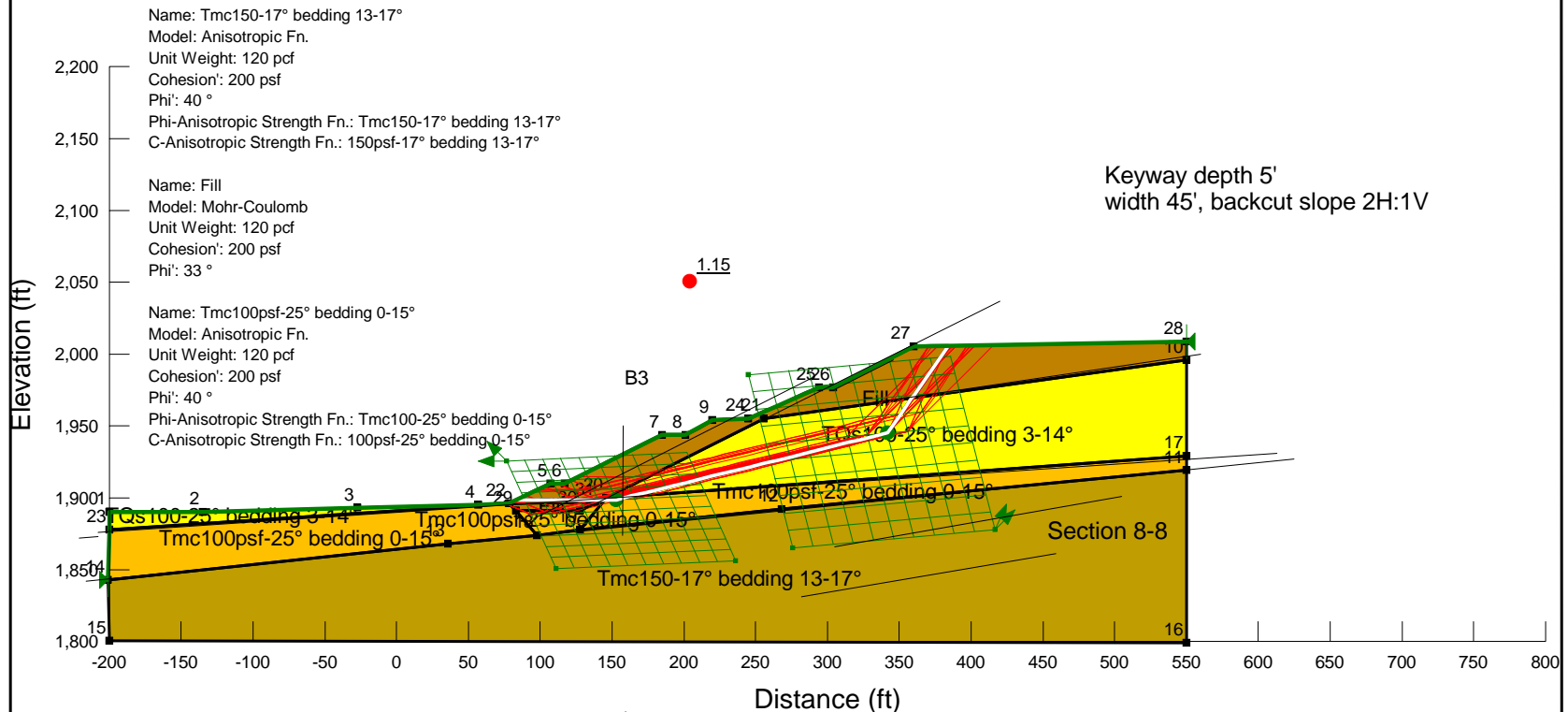

LGC **LGC Valley, Inc**
 GEOTECHNICAL CONSULTING
 28532 Constellation Road, Valencia, CA 91355
 Phone 661-702-8474, Fax 661-702-8475

Skyline Ranch
 Development project, Tract 60922
 Los Angeles CA

Project No: **153035-01**
 Engineer: **BAS**
 Date: **March 2016**

2 - Translational

Report generated using GeoStudio 2012. Copyright © 1991-2015 GEO-SLOPE International Ltd.

File Information

File Version: 8.15
 Title: Static Slope Stability Analyses for Skyline Ranch Development project, Tract 60922, Los Angeles CA
 Comments: Run By: Dr. Alexander Bykovtsev, Ph.D., P.E.
 Last Edited By: Alexander Bykovtsev
 Revision Number: 154
 Date: 3/22/2016
 Time: 9:20:06 AM
 Tool Version: 8.15.1.11236
 File Name: Section 8-8 Seismic Final with keyway SSA for Skyline Ranch.gsz
 Directory: G:\SLOPE RESULTS\Section 8-8 results\Latest updated 3-21-2016\
 Last Solved Date: 3/22/2016
 Last Solved Time: 9:20:24 AM

Project Settings

Length(L) Units: Feet
 Time(t) Units: Seconds
 Force(F) Units: Pounds
 Pressure(p) Units: psf
 Strength Units: psf
 Unit Weight of Water: 62.4 pcf
 View: 2D
 Element Thickness: 1

Analysis Settings

2 - Translational

Kind: SLOPE/W
 Method: Janbu
 Settings
 PWP Conditions Source: (none)
 Slip Surface
 Direction of movement: Right to Left
 Use Passive Mode: No
 Slip Surface Option: Block
 Critical slip surfaces saved: 10
 Resisting Side Maximum Convex Angle: 1 °
 Driving Side Maximum Convex Angle: 5 °
 Restrict Block Crossing: No
 Optimize Critical Slip Surface Location: No
 Tension Crack

file:///G:/SLOPE%20RESULTS/Section%208-8%20results/Latest%20updated%203-21-20... 3/22/2016

Tension Crack Option: (none)
 F of S Distribution
 F of S Calculation Option: Constant
 Advanced
 Number of Slices: 30
 F of S Tolerance: 0.01
 Minimum Slip Surface Depth: 0.1 ft

Materials

TQs100-25° bedding 3-14°

Model: Anisotropic Fn.
 Unit Weight: 120 pcf
 Cohesion': 225 psf
 Phi': 40 °
 Phi-Anisotropic Strength Fn.: TQs100-25° bedding 3-14°
 C-Anisotropic Strength Fn.: 100pcf-25° bedding 3-14°
 Phi-B: 0 °

Tmc150-17° bedding 13-17°

Model: Anisotropic Fn.
 Unit Weight: 120 pcf
 Cohesion': 200 psf
 Phi': 40 °
 Phi-Anisotropic Strength Fn.: Tmc150-17° bedding 13-17°
 C-Anisotropic Strength Fn.: 150psf-17° bedding 13-17°
 Phi-B: 0 °

Fill

Model: Mohr-Coulomb
 Unit Weight: 120 pcf
 Cohesion': 200 psf
 Phi': 33 °
 Phi-B: 0 °

Tmc100psf-25° bedding 0-15°

Model: Anisotropic Fn.
 Unit Weight: 120 pcf
 Cohesion': 200 psf
 Phi': 40 °
 Phi-Anisotropic Strength Fn.: Tmc100-25° bedding 0-15°
 C-Anisotropic Strength Fn.: 100psf-25° bedding 0-15°
 Phi-B: 0 °

Slip Surface Limits

Left Coordinate: (-201, 1,843) ft
 Right Coordinate: (550, 2,009) ft

file:///G:/SLOPE%20RESULTS/Section%208-8%20results/Latest%20updated%203-21-20... 3/22/2016

Slip Surface Block

Left Grid

Upper Left: (76.8746, 1,925.8506) ft
 Lower Left: (110.8805, 1,850.7649) ft
 Lower Right: (236.0227, 1,856.3268) ft
 X Increments: 10
 Y Increments: 10
 Starting Angle: 135 °
 Ending Angle: 180 °
 Angle Increments: 2

Right Grid

Upper Left: (244.9639, 1,985.7845) ft
 Lower Left: (275.7545, 1,865.054) ft
 Lower Right: (416.7433, 1,877.9566) ft
 X Increments: 10
 Y Increments: 10
 Starting Angle: 45 °
 Ending Angle: 65 °
 Angle Increments: 2

Seismic Coefficients

Horz Seismic Coef.: 0.15
 Vert Seismic Coef.: 0

Anisotropic Strength Functions

Tmc100-25° bedding 0-15°

Model: Spline Data Point Function
 Function: Modifier Factor vs. Inclination
 Curve Fit to Data: 100 %
 Segment Curvature: 0 %
 Y-Intercept: 0.625
 Data Points: Inclination (°), Modifier Factor
 Data Point: (-90, 1)
 Data Point: (-0.9, 1)
 Data Point: (0, 0.625)
 Data Point: (15, 0.625)
 Data Point: (15.1, 1)

100pcf-25° bedding 3-14°

Model: Spline Data Point Function
 Function: Modifier Factor vs. Inclination
 Curve Fit to Data: 100 %
 Segment Curvature: 0 %
 Y-Intercept: 1
 Data Points: Inclination (°), Modifier Factor
 Data Point: (-90, 1)

Data Point: (2.9, 1)
 Data Point: (3, 0.444)
 Data Point: (14, 0.444)
 Data Point: (14.1, 1)

100psf-25° bedding 0-15°

Model: Spline Data Point Function
 Function: Modifier Factor vs. Inclination
 Curve Fit to Data: 100 %
 Segment Curvature: 0 %
 Y-Intercept: 0.5
 Data Points: Inclination (°), Modifier Factor
 Data Point: (-90, 1)
 Data Point: (-0.9, 1)
 Data Point: (0, 0.5)
 Data Point: (15, 0.5)
 Data Point: (15.1, 1)

TQs100-25° bedding 3-14°

Model: Spline Data Point Function
 Function: Modifier Factor vs. Inclination
 Curve Fit to Data: 100 %
 Segment Curvature: 0 %
 Y-Intercept: 1
 Data Points: Inclination (°), Modifier Factor
 Data Point: (-90, 1)
 Data Point: (2.9, 1)
 Data Point: (3, 0.625)
 Data Point: (14, 0.625)
 Data Point: (14.1, 1)

Tmc150-17° bedding 13-17°

Model: Spline Data Point Function
 Function: Modifier Factor vs. Inclination
 Curve Fit to Data: 100 %
 Segment Curvature: 0 %
 Y-Intercept: 1
 Data Points: Inclination (°), Modifier Factor
 Data Point: (-90, 1)
 Data Point: (12.9, 1)
 Data Point: (13, 0.425)
 Data Point: (17, 0.425)
 Data Point: (17.1, 1)

150psf-17° bedding 13-17°

Model: Spline Data Point Function
 Function: Modifier Factor vs. Inclination
 Curve Fit to Data: 100 %
 Segment Curvature: 0 %
 Y-Intercept: 1

Data Points: Inclination (°), Modifier Factor

- Data Point: (-90, 1)
- Data Point: (12.9, 1)
- Data Point: (13, 0.75)
- Data Point: (17, 0.75)
- Data Point: (17.1, 1)

Points

	X (ft)	Y (ft)
Point 1	-200	1,890
Point 2	-135	1,890
Point 3	-27	1,893
Point 4	57	1,895
Point 5	107	1,910
Point 6	117	1,910
Point 7	185	1,944
Point 8	201	1,944
Point 9	220	1,954
Point 10	550	1,996
Point 11	550	1,919
Point 12	268	1,892
Point 13	36	1,868
Point 14	-201	1,843
Point 15	-200	1,800.4977
Point 16	550	1,799
Point 17	550	1,929
Point 18	98	1,874
Point 19	128	1,878
Point 20	146	1,900
Point 21	256	1,955
Point 22	78	1,896
Point 23	-200	1,878
Point 24	245	1,955
Point 25	294	1,977
Point 26	304	1,977
Point 27	360	2,005.5
Point 28	550	2,009
Point 29	83	1,891
Point 30	128	1,891
Point 31	140	1,897

Regions

	Material	Points	Area (ft²)
--	----------	--------	------------

Region 1	Tmc150-17° bedding 13-17°	11,12,19,18,13,14,15,16	61,653
Region 2	Tmc100psf-25° bedding 0-15°	12,11,17,20,19	6,209
Region 3	TQs100-25° bedding 3-14°	1,23,22,4,3,2	1,447.5
Region 4	Tmc100psf-25° bedding 0-15°	23,14,13,18,29,22	8,396
Region 5	TQs100-25° bedding 3-14°	20,21,10,17	19,364
Region 6	Tmc100psf-25° bedding 0-15°	18,19,20,31,30,29	694.5
Region 7	Fill	22,5,6,7,8,9,24,25,26,27,28,10,21,20,31	9,516
Region 8	Fill	22,29,30,31	292.5

Current Slip Surface

Slip Surface: 78,263
 F of S: 1.15
 Volume: 9,473.1768 ft³
 Weight: 1,136,781.2 lbs
 Resisting Force: 532,408.49 lbs
 Activating Force: 462,664.31 lbs
 F of S Rank (Analysis): 1 of 131,769 slip surfaces
 F of S Rank (Query): 1 of 50 slip surfaces
 Exit: (83.380059, 1,898.5973) ft
 Entry: (384.38678, 2,005.9492) ft
 Radius: 160.07064 ft
 Center: (205.16867, 2,032.7872) ft

Slip Slices

	X (ft)	Y (ft)	PWP (psf)	Base Normal Stress (psf)	Frictional Strength (psf)	Cohesive Strength (psf)
Slice 1	89.285044	1,898.5973	0	342.0819	222.15058	200
Slice 2	101.09501	1,898.5973	0	1,026.2457	666.45175	200
Slice 3	112	1,898.5973	0	1,368.3276	888.60233	200
Slice 4	121.36576	1,898.5973	0	1,630.273	1,058.7117	200
Slice 5	130.09727	1,898.5973	0	2,154.1638	1,398.9303	200
Slice 6	138.82878	1,898.5973	0	2,678.0546	1,739.149	200
	144.02343	1,898.5973	0	2,989.7332	1,394.1355	100

Slice 7						
Slice 8	145.42616	1,898.5973	0	3,073.897	1,433.3817	100
Slice 9	149.52403	1,898.5973	0	3,319.7694	1,548.0339	100
Slice 10	158.49512	1,899.9426	0	3,338.9706	1,556.9876	100
Slice 11	169.20664	1,902.5882	0	3,634.4758	1,694.7839	99.9
Slice 12	179.73555	1,905.1886	0	3,924.924	1,830.2221	99.9
Slice 13	189	1,907.4768	0	3,962.4367	1,847.7146	99.9
Slice 14	197	1,909.4526	0	3,747.014	1,747.2613	99.9
Slice 15	205.75	1,911.6137	0	3,783.9635	1,764.4912	99.9
Slice 16	215.25	1,913.9601	0	4,073.2853	1,899.4041	99.9
Slice 17	226.25	1,916.6769	0	4,076.904	1,901.0915	99.9
Slice 18	238.75	1,919.7642	0	3,794.8196	1,769.5534	99.9
Slice 19	250.5	1,922.6662	0	3,774.9049	1,760.267	99.9
Slice 20	260.75	1,925.1978	0	4,000.6423	1,865.5302	99.9
Slice 21	270.25	1,927.5441	0	4,209.8624	1,963.0911	99.9
Slice 22	279.75	1,929.8905	0	4,419.0825	2,060.652	99.9
Slice 23	289.25	1,932.2368	0	4,628.3026	2,158.213	99.9
Slice 24	299	1,934.6449	0	4,598.2735	2,144.2101	99.9
Slice 25	308.73418	1,937.049	0	4,598.8388	2,144.4738	99.9
Slice 26	318.20253	1,939.3876	0	4,869.2478	2,270.5676	99.9
Slice 27	327.67089	1,941.7261	0	5,139.6569	2,396.6614	99.9
Slice 28	337.13924	1,944.0646	0	5,410.0659	2,522.7552	99.9
Slice 29	346.0912	1,951.2575	0	2,627.4325	2,204.6776	225
Slice 30	354.52676	1,963.3047	0	2,172.9106	1,823.2885	225

Slice 31	359.37227	1,970.2248	0	2,179.0503	1,415.0918	200
Slice 32	366.0967	1,979.8283	0	1,571.137	1,020.3083	200
Slice 33	378.29008	1,997.2422	0	431.80198	280.41549	200

Section 8-8 Static Temporary Final without keyway SSA for Skyline Ranch.gsz

Section 8-8 Static Temporary Final without keyway SSA for Skyline Ranch.gsz Run By: Dr. Alexander Bykovtsev, Ph.D., P.E. 3/22/2016 9:06:34 AM

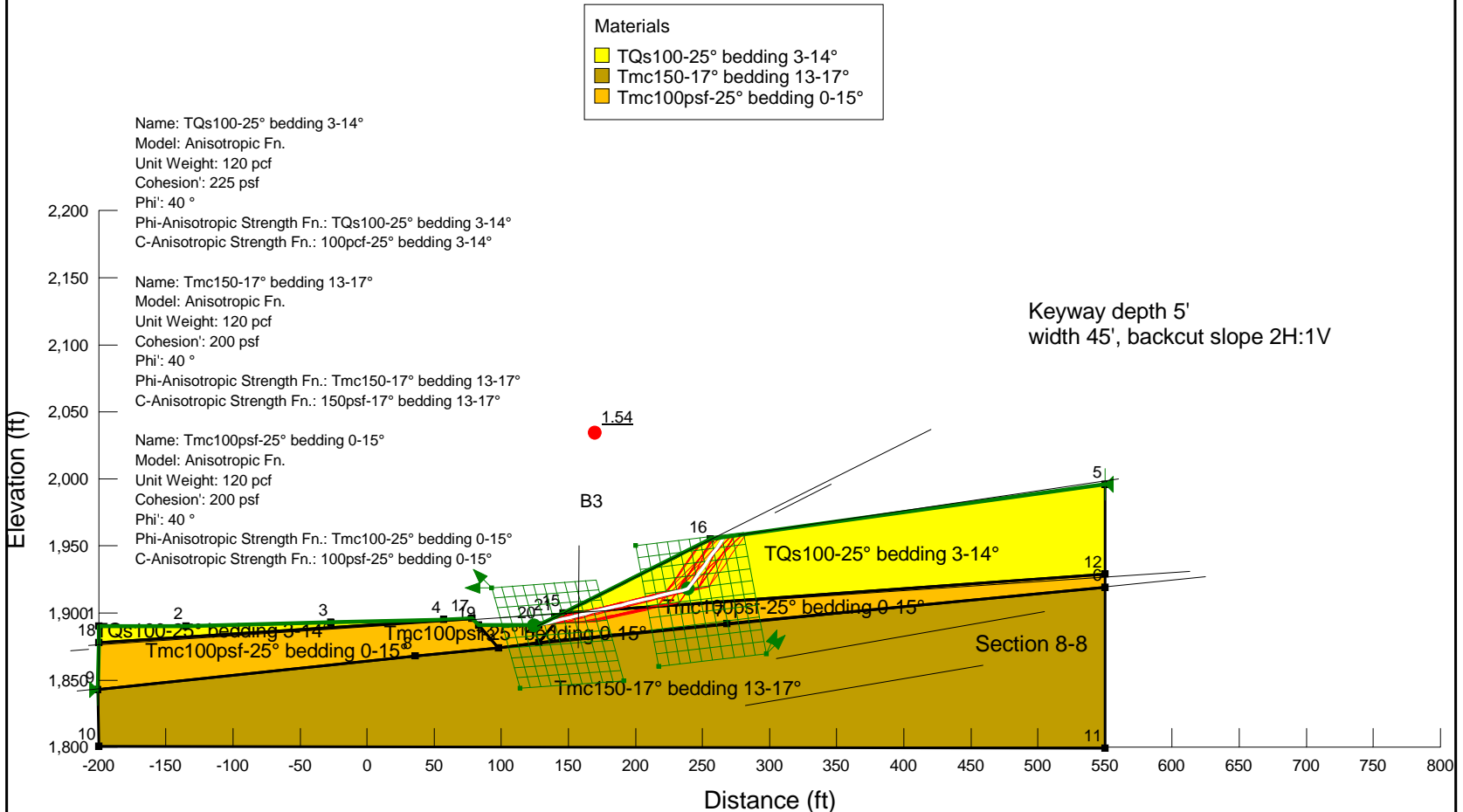

LGC **LGC Valley, Inc**
 GEOTECHNICAL CONSULTING
 28532 Constellation Road, Valencia, CA 91355
 Phone 661-702-8474, Fax 661-702-8475

Skyline Ranch
 Development project, Tract 60922
 Los Angeles CA

Project No: **153035-01**
 Engineer: **BAS**
 Date: **March 2016**

2 - Translational

Report generated using GeoStudio 2012. Copyright © 1991-2015 GEO-SLOPE International Ltd.

File Information

File Version: 8.15
 Title: Static Slope Stability Analyses for Skyline Ranch Development project, Tract 60922, Los Angeles CA
 Comments: Run By: Dr. Alexander Bykovtsev, Ph.D., P.E.
 Last Edited By: Alexander Bykovtsev
 Revision Number: 157
 Date: 3/22/2016
 Time: 9:06:34 AM
 Tool Version: 8.15.1.11236
 File Name: Section 8-8 Static Temporary Final without keyway SSA for Skyline Ranch.gsz
 Directory: G:\SLOPE RESULTS\Section 8-8 results\Latest updated 3-21-2016\
 Last Solved Date: 3/22/2016
 Last Solved Time: 9:06:55 AM

Project Settings

Length(L) Units: Feet
 Time(t) Units: Seconds
 Force(F) Units: Pounds
 Pressure(p) Units: psf
 Strength Units: psf
 Unit Weight of Water: 62.4 pcf
 View: 2D
 Element Thickness: 1

Analysis Settings

2 - Translational

Kind: SLOPE/W
 Method: Janbu
 Settings
 PWP Conditions Source: (none)
 Slip Surface
 Direction of movement: Right to Left
 Use Passive Mode: No
 Slip Surface Option: Block
 Critical slip surfaces saved: 10
 Resisting Side Maximum Convex Angle: 1 °
 Driving Side Maximum Convex Angle: 5 °
 Restrict Block Crossing: No
 Optimize Critical Slip Surface Location: No
 Tension Crack

file:///G:/SLOPE%20RESULTS/Section%208-8%20results/Latest%20updated%203-21-20... 3/22/2016

Tension Crack Option: (none)
 F of S Distribution
 F of S Calculation Option: Constant
 Advanced
 Number of Slices: 30
 F of S Tolerance: 0.01
 Minimum Slip Surface Depth: 0.1 ft

Materials

TQs100-25° bedding 3-14°

Model: Anisotropic Fn.
 Unit Weight: 120 pcf
 Cohesion': 225 psf
 Phi': 40 °
 Phi-Anisotropic Strength Fn.: TQs100-25° bedding 3-14°
 C-Anisotropic Strength Fn.: 100pcf-25° bedding 3-14°
 Phi-B: 0 °

Tmc150-17° bedding 13-17°

Model: Anisotropic Fn.
 Unit Weight: 120 pcf
 Cohesion': 200 psf
 Phi': 40 °
 Phi-Anisotropic Strength Fn.: Tmc150-17° bedding 13-17°
 C-Anisotropic Strength Fn.: 150psf-17° bedding 13-17°
 Phi-B: 0 °

Tmc100psf-25° bedding 0-15°

Model: Anisotropic Fn.
 Unit Weight: 120 pcf
 Cohesion': 200 psf
 Phi': 40 °
 Phi-Anisotropic Strength Fn.: Tmc100-25° bedding 0-15°
 C-Anisotropic Strength Fn.: 100psf-25° bedding 0-15°
 Phi-B: 0 °

Slip Surface Limits

Left Coordinate: (-201, 1,843) ft
 Right Coordinate: (550, 1,996) ft

Slip Surface Block

Left Grid
 Upper Left: (92.8893, 1,918.8506) ft
 Lower Left: (113.9754, 1,843.7649) ft
 Lower Right: (191.5725, 1,849.3268) ft

file:///G:/SLOPE%20RESULTS/Section%208-8%20results/Latest%20updated%203-21-20... 3/22/2016

X Increments: 10
 Y Increments: 10
 Starting Angle: 135 °
 Ending Angle: 180 °
 Angle Increments: 2

Right Grid

Upper Left: (199.961, 1,950.2414) ft
 Lower Left: (217.5045, 1,860.0503) ft
 Lower Right: (297.8353, 1,869.6891) ft
 X Increments: 10
 Y Increments: 10
 Starting Angle: 45 °
 Ending Angle: 65 °
 Angle Increments: 2

Seismic Coefficients

Horz Seismic Coef.: 0
 Vert Seismic Coef.: 0

Anisotropic Strength Functions

Tmc100-25° bedding 0-15°

Model: Spline Data Point Function
 Function: Modifier Factor vs. Inclination
 Curve Fit to Data: 100 %
 Segment Curvature: 0 %
 Y-Intercept: 0.625
 Data Points: Inclination (°), Modifier Factor
 Data Point: (-90, 1)
 Data Point: (-0.9, 1)
 Data Point: (0, 0.625)
 Data Point: (15, 0.625)
 Data Point: (15.1, 1)

100pcf-25° bedding 3-14°

Model: Spline Data Point Function
 Function: Modifier Factor vs. Inclination
 Curve Fit to Data: 100 %
 Segment Curvature: 0 %
 Y-Intercept: 1
 Data Points: Inclination (°), Modifier Factor
 Data Point: (-90, 1)
 Data Point: (2.9, 1)
 Data Point: (3, 0.444)
 Data Point: (14, 0.444)
 Data Point: (14.1, 1)

100psf-25° bedding 0-15°

Model: Spline Data Point Function
 Function: Modifier Factor vs. Inclination
 Curve Fit to Data: 100 %
 Segment Curvature: 0 %
 Y-Intercept: 0.5
 Data Points: Inclination (°), Modifier Factor
 Data Point: (-90, 1)
 Data Point: (-0.9, 1)
 Data Point: (0, 0.5)
 Data Point: (15, 0.5)
 Data Point: (15.1, 1)

TQs100-25° bedding 3-14°

Model: Spline Data Point Function
 Function: Modifier Factor vs. Inclination
 Curve Fit to Data: 100 %
 Segment Curvature: 0 %
 Y-Intercept: 1
 Data Points: Inclination (°), Modifier Factor
 Data Point: (-90, 1)
 Data Point: (2.9, 1)
 Data Point: (3, 0.625)
 Data Point: (14, 0.625)
 Data Point: (14.1, 1)

Tmc150-17° bedding 13-17°

Model: Spline Data Point Function
 Function: Modifier Factor vs. Inclination
 Curve Fit to Data: 100 %
 Segment Curvature: 0 %
 Y-Intercept: 1
 Data Points: Inclination (°), Modifier Factor
 Data Point: (-90, 1)
 Data Point: (12.9, 1)
 Data Point: (13, 0.425)
 Data Point: (17, 0.425)
 Data Point: (17.1, 1)

150psf-17° bedding 13-17°

Model: Spline Data Point Function
 Function: Modifier Factor vs. Inclination
 Curve Fit to Data: 100 %
 Segment Curvature: 0 %
 Y-Intercept: 1
 Data Points: Inclination (°), Modifier Factor
 Data Point: (-90, 1)
 Data Point: (12.9, 1)
 Data Point: (13, 0.75)
 Data Point: (17, 0.75)
 Data Point: (17.1, 1)

Points

	X (ft)	Y (ft)
Point 1	-200	1,890
Point 2	-135	1,890
Point 3	-27	1,893
Point 4	57	1,895
Point 5	550	1,996
Point 6	550	1,919
Point 7	268	1,892
Point 8	36	1,868
Point 9	-201	1,843
Point 10	-200	1,800.4977
Point 11	550	1,799
Point 12	550	1,929
Point 13	98	1,874
Point 14	128	1,878
Point 15	146	1,900
Point 16	256	1,955
Point 17	78	1,896
Point 18	-200	1,878
Point 19	83	1,891
Point 20	128	1,891
Point 21	140	1,897

Regions

	Material	Points	Area (ft²)
Region 1	Tmc150-17° bedding 13-17°	6,7,14,13,8,9,10,11	61,653
Region 2	Tmc100psf-25° bedding 0-15°	7,6,12,15,14	6,209
Region 3	TQs100-25° bedding 3-14°	1,18,17,4,3,2	1,447.5
Region 4	Tmc100psf-25° bedding 0-15°	18,9,8,13,19,17	8,396
Region 5	TQs100-25° bedding 3-14°	15,16,5,12	19,364
Region 6	Tmc100psf-25° bedding 0-15°	13,14,15,21,20,19	694.5

Current Slip Surface

Slip Surface: 76,079
 F of S: 1.54
 Volume: 1,982.3892 ft³
 Weight: 237,886.7 lbs
 Resisting Force: 118,932.65 lbs
 Activating Force: 77,235.118 lbs
 F of S Rank (Analysis): 1 of 131,769 slip surfaces
 F of S Rank (Query): 1 of 50 slip surfaces

Exit: (129.16285, 1,891.5814) ft
 Entry: (265.97843, 1,956.3916) ft
 Radius: 84.753865 ft
 Center: (174.54501, 1,972.5941) ft

Slip Slices

	X (ft)	Y (ft)	PWP (psf)	Base Normal Stress (psf)	Frictional Strength (psf)	Cohesive Strength (psf)
Slice 1	131.87213	1,892.2329	0	64.140147	29.909042	100
Slice 2	137.29071	1,893.5359	0	221.46642	103.27149	100
Slice 3	140.77451	1,894.3737	0	322.61716	150.43885	100
Slice 4	143.77451	1,895.0951	0	409.72099	191.05603	100
Slice 5	148.15872	1,896.1493	0	537.01468	250.41406	100
Slice 6	152.47615	1,897.1876	0	662.36961	308.86802	100
Slice 7	156.79358	1,898.2258	0	787.72455	367.32199	100
Slice 8	161.11101	1,899.264	0	913.07949	425.77596	100
Slice 9	165.42844	1,900.3022	0	1,038.4344	484.22993	100
Slice 10	169.74587	1,901.3404	0	1,163.7894	542.68389	100
Slice 11	174.14479	1,902.3982	0	1,291.5248	602.24791	99.9
Slice 12	178.6252	1,903.4756	0	1,421.6117	662.90844	99.9
Slice 13	183.10561	1,904.553	0	1,551.6986	723.56896	99.9
Slice 14	187.58602	1,905.6304	0	1,681.7856	784.22949	99.9
Slice 15	192.06643	1,906.7078	0	1,811.8725	844.89001	99.9
Slice 16	196.54684	1,907.7852	0	1,941.9594	905.55054	99.9
Slice 17	201.02725	1,908.8626	0	2,072.0463	966.21107	99.9
Slice 18	205.50765	1,909.94	0	2,202.1332	1,026.8716	99.9
Slice 19	209.98806	1,911.0174	0	2,332.2202	1,087.5321	99.9
Slice 20	214.46847	1,912.0948	0	2,462.3071	1,148.1926	99.9

Slice 21	218.94888	1,913.1722	0	2,592.394	1,208.8532	99.9
Slice 22	223.42929	1,914.2496	0	2,722.4809	1,269.5137	99.9
Slice 23	227.9097	1,915.327	0	2,852.5678	1,330.1742	99.9
Slice 24	232.39011	1,916.4044	0	2,982.6547	1,390.8347	99.9
Slice 25	236.87052	1,917.4818	0	3,112.7417	1,451.4953	99.9
Slice 26	241.22188	1,921.0355	0	1,678.1283	1,408.1168	225
Slice 27	245.4442	1,927.0656	0	1,413.3821	1,185.9684	225
Slice 28	249.66652	1,933.0957	0	1,148.636	963.82006	225
Slice 29	253.88884	1,939.1258	0	883.88989	741.67168	225
Slice 30	258.49461	1,945.7035	0	534.34036	448.3648	225
Slice 31	263.48382	1,952.8289	0	99.987422	83.899409	225

Section 10-10 Static Final with keyway SSA for Skyline Ranch.gsz

Section 10-10 Static Final with keyway SSA for Skyline Ranch.gsz Run By: Dr. Alexander Bykovtsev, Ph.D., P.E. 3/19/2016 7:19:51 PM

Name: Fill
 Model: Mohr-Coulomb
 Unit Weight: 120 pcf
 Cohesion: 200 psf
 Phi: 33 °

Materials

- Fill
- TQs 150-11° bedding 0-6°
- TQs 150-17° bedding 0-6°

Name: TQs 150-11° bedding 0-6°
 Model: Anisotropic Fn.
 Unit Weight: 120 pcf
 Cohesion: 225 psf
 Phi: 40 °
 Phi-Anisotropic Strength Fn.: TQs 150-17° bedding 0-6°
 C-Anisotropic Strength Fn.: 150pcf-11° bedding 0-6°

Name: TQs 150-17° bedding 0-6°
 Model: Anisotropic Fn.
 Unit Weight: 120 pcf
 Cohesion: 225 psf
 Phi: 40 °
 Phi-Anisotropic Strength Fn.: TQs 150-17° bedding 0-6°
 C-Anisotropic Strength Fn.: 150pcf-17° bedding 0-6°

Key parameters
 Slope 2H:1V
 Depth- 15'
 Width-60'

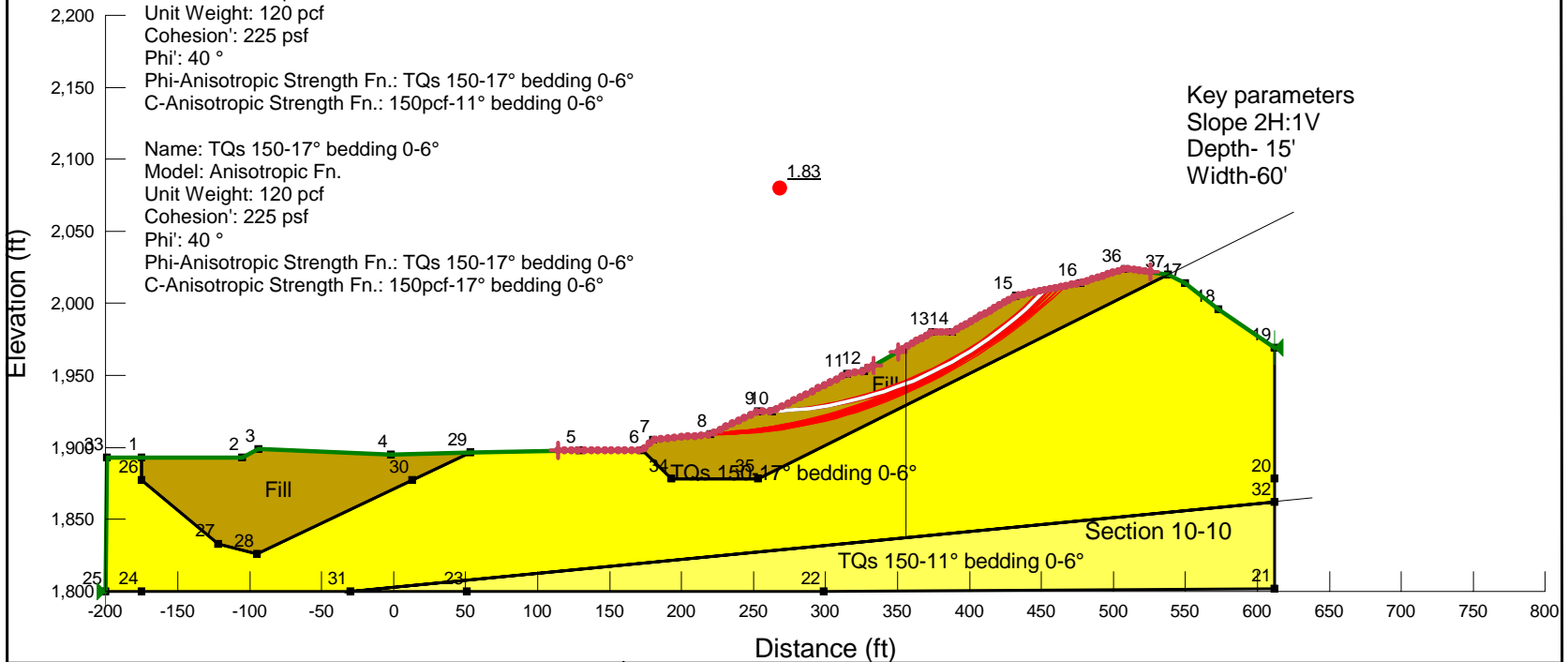

	<p>LGC Valley, Inc GEOTECHNICAL CONSULTING 28532 Constellation Road, Valencia, CA 91355 Phone 661-702-8474, Fax 661-702-8475</p>	<p>Skyline Ranch Development project, Tract 60922 Los Angeles CA</p>	<p>Project No: 153035-01 Engineer: BAS Date: March 2016</p>
---	--	---	--

1 - Circular Mode of Failure

Report generated using GeoStudio 2012. Copyright © 1991-2015 GEO-SLOPE International Ltd.

File Information

File Version: 8.15
 Title: Static Slope Stability Analyses for Skyline Ranch Development project, Tract 60922, Los Angeles CA
 Comments: Run By: Dr. Alexander Bykovtsev, Ph.D., P.E.
 Last Edited By: Alexander Bykovtsev
 Revision Number: 97
 Date: 3/19/2016
 Time: 7:19:51 PM
 Tool Version: 8.15.1.11236
 File Name: Section 10-10 Static Final with keyway SSA for Skyline Ranch.gsz
 Directory: C:\Users\Alexander\Desktop\LGC valley\original sections\
 Last Solved Date: 3/19/2016
 Last Solved Time: 7:20:14 PM

Project Settings

Length(L) Units: Feet
 Time(t) Units: Seconds
 Force(F) Units: Pounds
 Pressure(p) Units: psf
 Strength Units: psf
 Unit Weight of Water: 62.4 pcf
 View: 2D
 Element Thickness: 1

Analysis Settings

1 - Circular Mode of Failure

Kind: [SLOPE/W](#)
 Method: [Bishop](#)
 Settings
 PWP Conditions Source: [\(none\)](#)
 Slip Surface
 Direction of movement: [Right to Left](#)
 Use Passive Mode: [No](#)
 Slip Surface Option: [Entry and Exit](#)
 Critical slip surfaces saved: [10](#)
 Resisting Side Maximum Convex Angle: [1 °](#)
 Driving Side Maximum Convex Angle: [5 °](#)
 Optimize Critical Slip Surface Location: [No](#)
 Tension Crack
 Tension Crack Option: [\(none\)](#)

file:///C:/Users/Alexander/Desktop/LGC%20valley/original%20sections/section%2010-10... 3/19/2016

F of S Distribution
 F of S Calculation Option: [Constant](#)
 Advanced
 Number of Slices: [30](#)
 F of S Tolerance: [0.01](#)
 Minimum Slip Surface Depth: [0.1 ft](#)

Materials

Fill

Model: [Mohr-Coulomb](#)
 Unit Weight: [120 pcf](#)
 Cohesion': [200 psf](#)
 Phi': [33 °](#)
 Phi-B: [0 °](#)

TQs 150-11° bedding 0-6°

Model: [Anisotropic Fn.](#)
 Unit Weight: [120 pcf](#)
 Cohesion': [225 psf](#)
 Phi': [40 °](#)
 Phi-Anisotropic Strength Fn.: [TQs 150-17° bedding 0-6°](#)
 C-Anisotropic Strength Fn.: [150pcf-11° bedding 0-6°](#)
 Phi-B: [0 °](#)

TQs 150-17° bedding 0-6°

Model: [Anisotropic Fn.](#)
 Unit Weight: [120 pcf](#)
 Cohesion': [225 psf](#)
 Phi': [40 °](#)
 Phi-Anisotropic Strength Fn.: [TQs 150-17° bedding 0-6°](#)
 C-Anisotropic Strength Fn.: [150pcf-17° bedding 0-6°](#)
 Phi-B: [0 °](#)

Slip Surface Entry and Exit

Left Projection: [Range](#)
 Left-Zone Left Coordinate: [\(114.0248, 1,897.657\) ft](#)
 Left-Zone Right Coordinate: [\(333.4764, 1,956.7205\) ft](#)
 Left-Zone Increment: [50](#)
 Right Projection: [Range](#)
 Right-Zone Left Coordinate: [\(350.425, 1,966.4569\) ft](#)
 Right-Zone Right Coordinate: [\(525.4812, 2,021.6692\) ft](#)
 Right-Zone Increment: [50](#)
 Radius Increments: [50](#)

Slip Surface Limits

file:///C:/Users/Alexander/Desktop/LGC%20valley/original%20sections/section%2010-10... 3/19/2016

Left Coordinate: (-200, 1,800) ft
 Right Coordinate: (612, 1,969) ft

Seismic Coefficients

Horz Seismic Coef.: 0
 Vert Seismic Coef.: 0

Anisotropic Strength Functions

150pcf-11° bedding 0-6°

Model: Spline Data Point Function
 Function: Modifier Factor vs. Inclination
 Curve Fit to Data: 100 %
 Segment Curvature: 0 %
 Y-Intercept: 0.667
 Data Points: Inclination (°), Modifier Factor
 Data Point: (-90, 1)
 Data Point: (-0.9, 1)
 Data Point: (0, 0.667)
 Data Point: (6, 0.667)
 Data Point: (6.1, 1)

TQs 150-17° bedding 0-6°

Model: Spline Data Point Function
 Function: Modifier Factor vs. Inclination
 Curve Fit to Data: 100 %
 Segment Curvature: 0 %
 Y-Intercept: 0.425
 Data Points: Inclination (°), Modifier Factor
 Data Point: (-90, 1)
 Data Point: (-0.9, 1)
 Data Point: (0, 0.425)
 Data Point: (6, 0.425)
 Data Point: (6.1, 1)

150pcf-17° bedding 0-6°

Model: Spline Data Point Function
 Function: Modifier Factor vs. Inclination
 Curve Fit to Data: 100 %
 Segment Curvature: 0 %
 Y-Intercept: 0.667
 Data Points: Inclination (°), Modifier Factor
 Data Point: (-90, 1)
 Data Point: (-0.9, 1)
 Data Point: (0, 0.667)
 Data Point: (6, 0.667)
 Data Point: (6.1, 1)

Points

	X (ft)	Y (ft)
Point 1	-175	1,893
Point 2	-105	1,893
Point 3	-94	1,899
Point 4	-2	1,895
Point 5	129	1,898
Point 6	173	1,898
Point 7	180	1,905
Point 8	220	1,909
Point 9	253	1,925
Point 10	263	1,925
Point 11	315	1,951
Point 12	327	1,953
Point 13	374	1,980
Point 14	388	1,980
Point 15	432	2,005
Point 16	477	2,014
Point 17	550	2,014
Point 18	573	1,996
Point 19	612	1,969
Point 20	612	1,878
Point 21	612	1,802
Point 22	299	1,800
Point 23	51	1,800
Point 24	-175	1,800
Point 25	-200	1,800
Point 26	-175.1684	1,877
Point 27	-122	1,833
Point 28	-95	1,826
Point 29	53	1,896.2595
Point 30	13	1,877.2704
Point 31	-30	1,800
Point 32	612	1,862
Point 33	-199	1,893
Point 34	193	1,878
Point 35	253	1,878
Point 36	508	2,024
Point 37	538	2,020

Regions

	Material	Points	

			Area (ft ²)
Region 1	Fill	26,27,28,30,29,4,3,2,1	8,996
Region 2	TQs 150-11° bedding 0-6°	31,23,22,21,32	19,589
Region 3	TQs 150-17° bedding 0-6°	31,32,20,19,18,17,37,35,34,6,5,29,30,28,27,26,1,33,25,24	70,166
Region 4	Fill	6,34,35,37,36,16,15,14,13,12,11,10,9,8,7	11,889

Current Slip Surface

Slip Surface: 87,378
 F of S: 1.83
 Volume: 3,220.1592 ft³
 Weight: 386,419.11 lbs
 Resisting Moment: 76,374,330 lbs-ft
 Activating Moment: 41,799,057 lbs-ft
 F of S Rank (Analysis): 1 of 132,651 slip surfaces
 F of S Rank (Query): 1 of 50 slip surfaces
 Exit: (263.09824, 1,925.0491) ft
 Entry: (452.53556, 2,009.1071) ft
 Radius: 275.23527 ft
 Center: (254.39858, 2,200.1469) ft

Slip Slices

	X (ft)	Y (ft)	PWP (psf)	Base Normal Stress (psf)	Frictional Strength (psf)	Cohesive Strength (psf)
Slice 1	266.3421	1,925.19	0	170.35033	110.6268	200
Slice 2	272.82982	1,925.5487	0	504.59684	327.68902	200
Slice 3	279.31754	1,926.0613	0	815.45248	529.56103	200
Slice 4	285.80526	1,926.7289	0	1,103.3308	716.51143	200
Slice 5	292.29298	1,927.5524	0	1,368.5909	888.7733	200
Slice 6	298.7807	1,928.5334	0	1,611.54	1,046.5463	200
Slice 7	305.26842	1,929.6735	0	1,832.437	1,189.9985	200
Slice 8	311.75614	1,930.9749	0	2,031.4938	1,319.2675	200
Slice 9	318	1,932.3787	0	2,092.263	1,358.7315	200
	324	1,933.8754	0	2,019.1095	1,311.225	200

Slice						
Slice 10						
Slice 11	330.35714	1,935.6236	0	2,073.9016	1,346.8074	200
Slice 12	337.07143	1,937.6449	0	2,250.9306	1,461.7715	200
Slice 13	343.78571	1,939.8551	0	2,404.0566	1,561.2126	200
Slice 14	350.5	1,942.259	0	2,533.2287	1,645.0979	200
Slice 15	357.21429	1,944.8622	0	2,638.3431	1,713.36	200
Slice 16	363.92857	1,947.6706	0	2,719.2418	1,765.8962	200
Slice 17	370.64286	1,950.6915	0	2,775.71	1,802.5672	200
Slice 18	377.5	1,954.0063	0	2,602.7087	1,690.2188	200
Slice 19	384.5	1,957.6344	0	2,205.4244	1,432.2193	200
Slice 20	391.14286	1,961.3115	0	1,990.0447	1,292.3501	200
Slice 21	397.42857	1,965.0228	0	1,952.2516	1,267.807	200
Slice 22	403.71429	1,968.9645	0	1,891.59	1,228.4129	200
Slice 23	410	1,973.1488	0	1,807.5807	1,173.8566	200
Slice 24	416.28571	1,977.5892	0	1,699.6805	1,103.7854	200
Slice 25	422.57143	1,982.3016	0	1,567.277	1,017.8016	200
Slice 26	428.85714	1,987.3039	0	1,409.6837	915.45932	200
Slice 27	435.42259	1,992.869	0	1,101.178	715.11335	200
Slice 28	442.26778	1,999.0557	0	644.12484	418.29956	200
Slice 29	449.11297	2,005.6802	0	162.08651	105.26021	200

Section 10-10 Seismic Final with keyway SSA for Skyline Ranch.gsz

Section 10-10 Seismic Final with keyway SSA for Skyline Ranch.gsz Run By: Dr. Alexander Bykovtsev, Ph.D., P.E. 3/19/2016 7:00:06 PM

Name: Fill
 Model: Mohr-Coulomb
 Unit Weight: 120 pcf
 Cohesion: 200 psf
 Phi: 33 °

Materials

- Fill
- TQs 150-11° bedding 0-6°
- TQs 150-17° bedding 0-6°

Seismic load
 Horizontal: 0.15
 Vertical: 0.0

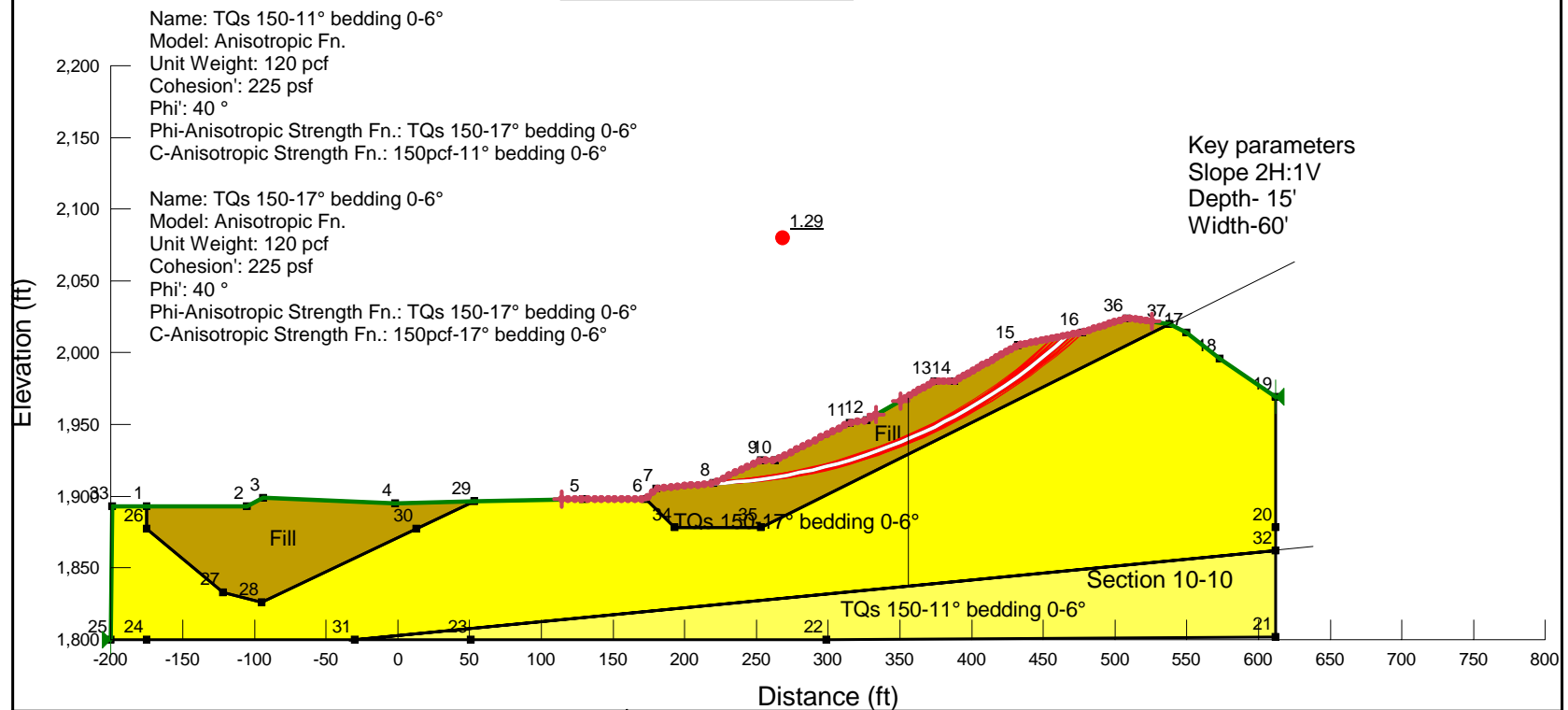

LGC Valley, Inc
 GEOTECHNICAL CONSULTING
 28532 Constellation Road, Valencia, CA 91355
 Phone 661-702-8474, Fax 661-702-8475

Skyline Ranch
 Development project, Tract 60922
 Los Angeles CA

Project No: **153035-01**
 Engineer: **BAS**
 Date: **March 2016**

1 - Circular Mode of Failure

Report generated using GeoStudio 2012. Copyright © 1991-2015 GEO-SLOPE International Ltd.

File Information

File Version: 8.15
Title: Static Slope Stability Analyses for Skyline Ranch Development project, Tract 60922, Los Angeles CA
Comments: Run By: Dr. Alexander Bykovtsev, Ph.D., P.E.
Last Edited By: Alexander Bykovtsev
Revision Number: 92
Date: 3/19/2016
Time: 7:00:06 PM
Tool Version: 8.15.1.11236
File Name: Section 10-10 Seismic Final with keyway SSA for Skyline Ranch.gsz
Directory: C:\Users\Alexander\Desktop\LGC valley\original sections\
Last Solved Date: 3/19/2016
Last Solved Time: 7:07:10 PM

Project Settings

Length(L) Units: Feet
Time(t) Units: Seconds
Force(F) Units: Pounds
Pressure(p) Units: psf
Strength Units: psf
Unit Weight of Water: 62.4 pcf
View: 2D
Element Thickness: 1

Analysis Settings

1 - Circular Mode of Failure

Kind: SLOPE/W
Method: Bishop
Settings
PWP Conditions Source: (none)
Slip Surface
Direction of movement: Right to Left
Use Passive Mode: No
Slip Surface Option: Entry and Exit
Critical slip surfaces saved: 10
Resisting Side Maximum Convex Angle: 1 °
Driving Side Maximum Convex Angle: 5 °
Optimize Critical Slip Surface Location: No
Tension Crack
Tension Crack Option: (none)

F of S Distribution

F of S Calculation Option: [Constant](#)

Advanced

Number of Slices: [30](#)

F of S Tolerance: [0.01](#)

Minimum Slip Surface Depth: [0.1 ft](#)

Materials

Fill

Model: [Mohr-Coulomb](#)

Unit Weight: [120 pcf](#)

Cohesion': [200 psf](#)

Phi': [33 °](#)

Phi-B: [0 °](#)

TQs 150-11° bedding 0-6°

Model: [Anisotropic Fn.](#)

Unit Weight: [120 pcf](#)

Cohesion': [225 psf](#)

Phi': [40 °](#)

Phi-Anisotropic Strength Fn.: [TQs 150-17° bedding 0-6°](#)

C-Anisotropic Strength Fn.: [150pcf-11° bedding 0-6°](#)

Phi-B: [0 °](#)

TQs 150-17° bedding 0-6°

Model: [Anisotropic Fn.](#)

Unit Weight: [120 pcf](#)

Cohesion': [225 psf](#)

Phi': [40 °](#)

Phi-Anisotropic Strength Fn.: [TQs 150-17° bedding 0-6°](#)

C-Anisotropic Strength Fn.: [150pcf-17° bedding 0-6°](#)

Phi-B: [0 °](#)

Slip Surface Entry and Exit

Left Projection: [Range](#)

Left-Zone Left Coordinate: [\(114.0248, 1,897.657\) ft](#)

Left-Zone Right Coordinate: [\(333.4764, 1,956.7205\) ft](#)

Left-Zone Increment: [50](#)

Right Projection: [Range](#)

Right-Zone Left Coordinate: [\(350.425, 1,966.4569\) ft](#)

Right-Zone Right Coordinate: [\(525.4812, 2,021.6692\) ft](#)

Right-Zone Increment: [50](#)

Radius Increments: [50](#)

Slip Surface Limits

Left Coordinate: (-200, 1,800) ft
Right Coordinate: (612, 1,969) ft

Seismic Coefficients

Horz Seismic Coef.: 0.15
Vert Seismic Coef.: 0

Anisotropic Strength Functions

150pcf-11° bedding 0-6°

Model: [Spline Data Point Function](#)
Function: [Modifier Factor vs. Inclination](#)
Curve Fit to Data: 100 %
Segment Curvature: 0 %
Y-Intercept: 0.667
Data Points: [Inclination \(°\), Modifier Factor](#)
Data Point: (-90, 1)
Data Point: (-0.9, 1)
Data Point: (0, 0.667)
Data Point: (6, 0.667)
Data Point: (6.1, 1)

TQs 150-17° bedding 0-6°

Model: [Spline Data Point Function](#)
Function: [Modifier Factor vs. Inclination](#)
Curve Fit to Data: 100 %
Segment Curvature: 0 %
Y-Intercept: 0.425
Data Points: [Inclination \(°\), Modifier Factor](#)
Data Point: (-90, 1)
Data Point: (-0.9, 1)
Data Point: (0, 0.425)
Data Point: (6, 0.425)
Data Point: (6.1, 1)

150pcf-17° bedding 0-6°

Model: [Spline Data Point Function](#)
Function: [Modifier Factor vs. Inclination](#)
Curve Fit to Data: 100 %
Segment Curvature: 0 %
Y-Intercept: 0.667
Data Points: [Inclination \(°\), Modifier Factor](#)
Data Point: (-90, 1)
Data Point: (-0.9, 1)
Data Point: (0, 0.667)
Data Point: (6, 0.667)
Data Point: (6.1, 1)

Points

	X (ft)	Y (ft)
Point 1	-175	1,893
Point 2	-105	1,893
Point 3	-94	1,899
Point 4	-2	1,895
Point 5	129	1,898
Point 6	173	1,898
Point 7	180	1,905
Point 8	220	1,909
Point 9	253	1,925
Point 10	263	1,925
Point 11	315	1,951
Point 12	327	1,953
Point 13	374	1,980
Point 14	388	1,980
Point 15	432	2,005
Point 16	477	2,014
Point 17	550	2,014
Point 18	573	1,996
Point 19	612	1,969
Point 20	612	1,878
Point 21	612	1,802
Point 22	299	1,800
Point 23	51	1,800
Point 24	-175	1,800
Point 25	-200	1,800
Point 26	-175.1684	1,877
Point 27	-122	1,833
Point 28	-95	1,826
Point 29	53	1,896.2595
Point 30	13	1,877.2704
Point 31	-30	1,800
Point 32	612	1,862
Point 33	-199	1,893
Point 34	193	1,878
Point 35	253	1,878
Point 36	508	2,024
Point 37	538	2,020

Regions

	Material	Points	

			Area (ft ²)
Region 1	Fill	26,27,28,30,29,4,3,2,1	8,996
Region 2	TQs 150-11° bedding 0-6°	31,23,22,21,32	19,589
Region 3	TQs 150-17° bedding 0-6°	31,32,20,19,18,17,37,35,34,6,5,29,30,28,27,26,1,33,25,24	70,166
Region 4	Fill	6,34,35,37,36,16,15,14,13,12,11,10,9,8,7	11,889

Current Slip Surface

Slip Surface: 61,570
 F of S: 1.29
 Volume: 4,845.2894 ft³
 Weight: 581,434.73 lbs
 Resisting Moment: 1.5192364e+008 lbs-ft
 Activating Moment: 1.1738992e+008 lbs-ft
 F of S Rank (Analysis): 1 of 132,651 slip surfaces
 F of S Rank (Query): 1 of 50 slip surfaces
 Exit: (218.35144, 1,908.8351) ft
 Entry: (467.27523, 2,012.055) ft
 Radius: 391.16783 ft
 Center: (202.14986, 2,299.6673) ft

Slip Slices

	X (ft)	Y (ft)	PWP (psf)	Base Normal Stress (psf)	Frictional Strength (psf)	Cohesive Strength (psf)
Slice 1	219.17572	1,908.8711	0	-1.1093562	-0.72042433	200
Slice 2	224.125	1,909.1391	0	208.75719	135.5685	200
Slice 3	232.375	1,909.6909	0	601.79972	390.81331	200
Slice 4	240.625	1,910.4183	0	966.73558	627.80542	200
Slice 5	248.875	1,911.3224	0	1,304.2256	846.974	200
Slice 6	258	1,912.5401	0	1,373.7608	892.1307	200
Slice 7	267.33333	1,913.9938	0	1,433.4381	930.88557	200
Slice 8	276	1,915.5593	0	1,717.9318	1,115.638	200
Slice 9	284.66667	1,917.3277	0	1,974.1637	1,282.0369	200
	293.33333	1,919.3017	0	2,202.5694	1,430.3653	200

Slice 10						
Slice 11	302	1,921.4846	0	2,403.5279	1,560.8693	200
Slice 12	310.66667	1,923.8801	0	2,577.3648	1,673.7603	200
Slice 13	321	1,927.0452	0	2,539.9395	1,649.456	200
Slice 14	330.91667	1,930.3244	0	2,500.9306	1,624.1233	200
Slice 15	338.75	1,933.1496	0	2,641.8007	1,715.6054	200
Slice 16	346.58333	1,936.1656	0	2,759.997	1,792.363	200
Slice 17	354.41667	1,939.3771	0	2,855.5741	1,854.4315	200
Slice 18	362.25	1,942.7895	0	2,928.5539	1,901.8252	200
Slice 19	370.08333	1,946.4085	0	2,978.9251	1,934.5366	200
Slice 20	377.5	1,950.0257	0	2,813.4162	1,827.0539	200
Slice 21	384.5	1,953.6253	0	2,440.1515	1,584.6529	200
Slice 22	392.4	1,957.9192	0	2,239.8111	1,454.5503	200
Slice 23	401.2	1,962.9698	0	2,201.1826	1,429.4647	200
Slice 24	410	1,968.3312	0	2,133.6531	1,385.6105	200
Slice 25	418.8	1,974.0186	0	2,036.95	1,322.8108	200
Slice 26	427.6	1,980.0495	0	1,910.748	1,240.8543	200
Slice 27	436.4094	1,986.4511	0	1,612.7149	1,047.3093	200
Slice 28	445.22821	1,993.2468	0	1,149.2693	746.3442	200
Slice 29	454.04702	2,000.4569	0	664.5264	431.54849	200
Slice 30	462.86582	2,008.112	0	158.5394	102.95669	200

Section 10-10 Static Final with keyway SSA for Skyline Ranch.gsz

Section 10-10 Static Final with keyway SSA for Skyline Ranch.gsz Run By: Dr. Alexander Bykovtsev, Ph.D., P.E. 3/19/2016 7:14:14 PM

Name: Fill
 Model: Mohr-Coulomb
 Unit Weight: 120 pcf
 Cohesion: 200 psf
 Phi: 33 °

Materials

- Fill
- TQs 150-11° bedding 0-6°
- TQs 150-17° bedding 0-6°

Name: TQs 150-11° bedding 0-6°
 Model: Anisotropic Fn.
 Unit Weight: 120 pcf
 Cohesion: 225 psf
 Phi: 40 °
 Phi-Anisotropic Strength Fn.: TQs 150-17° bedding 0-6°
 C-Anisotropic Strength Fn.: 150pcf-11° bedding 0-6°

Name: TQs 150-17° bedding 0-6°
 Model: Anisotropic Fn.
 Unit Weight: 120 pcf
 Cohesion: 225 psf
 Phi: 40 °
 Phi-Anisotropic Strength Fn.: TQs 150-17° bedding 0-6°
 C-Anisotropic Strength Fn.: 150pcf-17° bedding 0-6°

Key parameters
 Slope 2H:1V
 Depth- 15'
 Width-60'

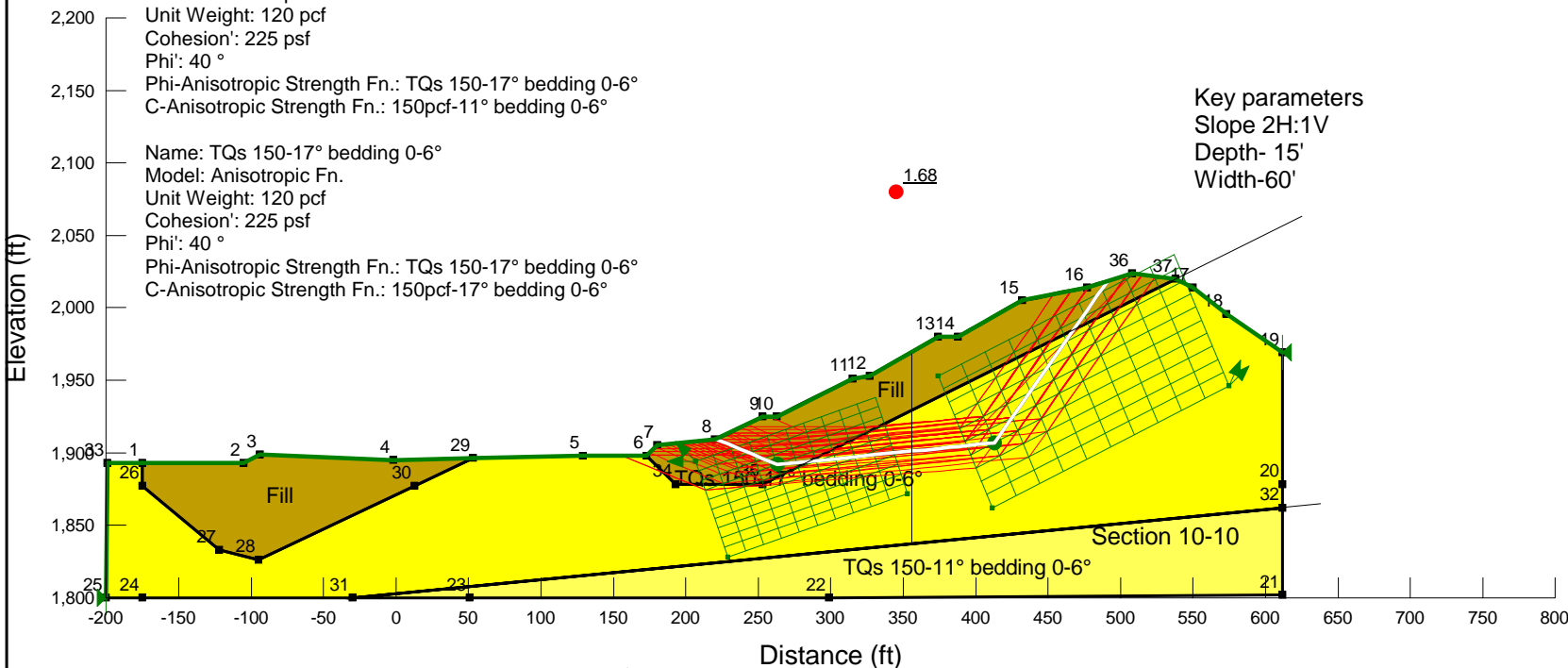

LGC Valley, Inc
 GEOTECHNICAL CONSULTING
 28532 Constellation Road, Valencia, CA 91355
 Phone 661-702-8474, Fax 661-702-8475

Skyline Ranch
 Development project, Tract 60922
 Los Angeles CA

Project No: **153035-01**
 Engineer: **BAS**
 Date: **March 2016**

2 - Translational

Report generated using GeoStudio 2012. Copyright © 1991-2015 GEO-SLOPE International Ltd.

File Information

File Version: 8.15
 Title: Static Slope Stability Analyses for Skyline Ranch Development project, Tract 60922, Los Angeles CA
 Comments: Run By: Dr. Alexander Bykovtsev, Ph.D., P.E.
 Last Edited By: Alexander Bykovtsev
 Revision Number: 95
 Date: 3/19/2016
 Time: 7:14:14 PM
 Tool Version: 8.15.1.11236
 File Name: Section 10-10 Static Final with keyway SSA for Skyline Ranch.gsz
 Directory: C:\Users\Alexander\Desktop\LGC valley\original sections\
 Last Solved Date: 3/19/2016
 Last Solved Time: 7:14:29 PM

Project Settings

Length(L) Units: Feet
 Time(t) Units: Seconds
 Force(F) Units: Pounds
 Pressure(p) Units: psf
 Strength Units: psf
 Unit Weight of Water: 62.4 pcf
 View: 2D
 Element Thickness: 1

Analysis Settings

2 - Translational

Kind: SLOPE/W
 Method: Janbu
 Settings
 PWP Conditions Source: (none)
 Slip Surface
 Direction of movement: Right to Left
 Use Passive Mode: No
 Slip Surface Option: Block
 Critical slip surfaces saved: 10
 Resisting Side Maximum Convex Angle: 1 °
 Driving Side Maximum Convex Angle: 5 °
 Restrict Block Crossing: No
 Optimize Critical Slip Surface Location: No
 Tension Crack

file:///C:/Users/Alexander/Desktop/LGC%20valley/original%20sections/section%2010-10... 3/19/2016

Tension Crack Option: (none)
 F of S Distribution
 F of S Calculation Option: Constant
 Advanced
 Number of Slices: 30
 F of S Tolerance: 0.01
 Minimum Slip Surface Depth: 0.1 ft

Materials

Fill

Model: Mohr-Coulomb
 Unit Weight: 120 pcf
 Cohesion': 200 psf
 Phi': 33 °
 Phi-B: 0 °

TQs 150-11° bedding 0-6°

Model: Anisotropic Fn.
 Unit Weight: 120 pcf
 Cohesion': 225 psf
 Phi': 40 °
 Phi-Anisotropic Strength Fn.: TQs 150-17° bedding 0-6°
 C-Anisotropic Strength Fn.: 150pcf-11° bedding 0-6°
 Phi-B: 0 °

TQs 150-17° bedding 0-6°

Model: Anisotropic Fn.
 Unit Weight: 120 pcf
 Cohesion': 225 psf
 Phi': 40 °
 Phi-Anisotropic Strength Fn.: TQs 150-17° bedding 0-6°
 C-Anisotropic Strength Fn.: 150pcf-17° bedding 0-6°
 Phi-B: 0 °

Slip Surface Limits

Left Coordinate: (-200, 1,800) ft
 Right Coordinate: (612, 1,969) ft

Slip Surface Block

Left Grid
 Upper Left: (207, 1,894) ft
 Lower Left: (229, 1,828) ft
 Lower Right: (353, 1,872) ft
 X Increments: 10
 Y Increments: 10

file:///C:/Users/Alexander/Desktop/LGC%20valley/original%20sections/section%2010-10... 3/19/2016

Starting Angle: 135 °
 Ending Angle: 180 °
 Angle Increments: 2
 Right Grid
 Upper Left: (373.9817, 1,953.006) ft
 Lower Left: (411.6124, 1,862.1107) ft
 Lower Right: (574.679, 1,945.8768) ft
 X Increments: 10
 Y Increments: 10
 Starting Angle: 45 °
 Ending Angle: 65 °
 Angle Increments: 2

Seismic Coefficients

Horz Seismic Coef.: 0
 Vert Seismic Coef.: 0

Anisotropic Strength Functions

150pcf-11° bedding 0-6°

Model: Spline Data Point Function
 Function: Modifier Factor vs. Inclination
 Curve Fit to Data: 100 %
 Segment Curvature: 0 %
 Y-Intercept: 0.667
 Data Points: Inclination (°), Modifier Factor
 Data Point: (-90, 1)
 Data Point: (-0.9, 1)
 Data Point: (0, 0.667)
 Data Point: (6, 0.667)
 Data Point: (6.1, 1)

TQs 150-17° bedding 0-6°

Model: Spline Data Point Function
 Function: Modifier Factor vs. Inclination
 Curve Fit to Data: 100 %
 Segment Curvature: 0 %
 Y-Intercept: 0.425
 Data Points: Inclination (°), Modifier Factor
 Data Point: (-90, 1)
 Data Point: (-0.9, 1)
 Data Point: (0, 0.425)
 Data Point: (6, 0.425)
 Data Point: (6.1, 1)

150pcf-17° bedding 0-6°

Model: Spline Data Point Function
 Function: Modifier Factor vs. Inclination

Curve Fit to Data: 100 %
 Segment Curvature: 0 %
 Y-Intercept: 0.667
 Data Points: Inclination (°), Modifier Factor
 Data Point: (-90, 1)
 Data Point: (-0.9, 1)
 Data Point: (0, 0.667)
 Data Point: (6, 0.667)
 Data Point: (6.1, 1)

Points

	X (ft)	Y (ft)
Point 1	-175	1,893
Point 2	-105	1,893
Point 3	-94	1,899
Point 4	-2	1,895
Point 5	129	1,898
Point 6	173	1,898
Point 7	180	1,905
Point 8	220	1,909
Point 9	253	1,925
Point 10	263	1,925
Point 11	315	1,951
Point 12	327	1,953
Point 13	374	1,980
Point 14	388	1,980
Point 15	432	2,005
Point 16	477	2,014
Point 17	550	2,014
Point 18	573	1,996
Point 19	612	1,969
Point 20	612	1,878
Point 21	612	1,802
Point 22	299	1,800
Point 23	51	1,800
Point 24	-175	1,800
Point 25	-200	1,800
Point 26	-175.1684	1,877
Point 27	-122	1,833
Point 28	-95	1,826
Point 29	53	1,896.2595
Point 30	13	1,877.2704
Point 31	-30	1,800
Point 32	612	1,862

Point 33	-199	1,893
Point 34	193	1,878
Point 35	253	1,878
Point 36	508	2,024
Point 37	538	2,020

Regions

	Material	Points	Area (ft ²)
Region 1	Fill	26,27,28,30,29,4,3,2,1	8,996
Region 2	TQs 150-11° bedding 0-6°	31,23,22,21,32	19,589
Region 3	TQs 150-17° bedding 0-6°	31,32,20,19,18,17,37,35,34,6,5,29,30,28,27,26,1,33,25,24	70,166
Region 4	Fill	6,34,35,37,36,16,15,14,13,12,11,10,9,8,7	11,889

Current Slip Surface

Slip Surface: 88,709
 F of S: 1.68
 Volume: 13,456.281 ft³
 Weight: 1,614,753.8 lbs
 Resisting Force: 682,879.44 lbs
 Activating Force: 406,970.26 lbs
 F of S Rank (Analysis): 1 of 131,769 slip surfaces
 F of S Rank (Query): 1 of 50 slip surfaces
 Exit: (220.77194, 1,909.3743) ft
 Entry: (491.07679, 2,018.5409) ft
 Radius: 163.0926 ft
 Center: (322.85795, 2,045.8326) ft

Slip Slices

	X (ft)	Y (ft)	PWP (psf)	Base Normal Stress (psf)	Frictional Strength (psf)	Cohesive Strength (psf)
Slice 1	224.80045	1,907.7056	0	576.96079	374.68272	200
Slice 2	232.85747	1,904.3683	0	1,612.8226	1,047.3793	200
Slice 3	240.91448	1,901.031	0	2,648.6845	1,720.0758	200

Slice 4	248.97149	1,897.6936	0	3,684.5464	2,392.7724	200
Slice 5	258	1,893.9539	0	4,498.6414	2,921.4519	200
Slice 6	268.57993	1,892.3923	0	4,091.7363	2,657.2046	200
Slice 7	279.63978	1,893.4526	0	4,592.7697	2,982.5795	200
Slice 8	290.09976	1,894.5041	0	5,181.2522	1,584.0678	150.075
Slice 9	300.05986	1,895.5054	0	5,650.092	1,727.4065	150.075
Slice 10	310.01995	1,896.5066	0	6,118.9318	1,870.7452	150.075
Slice 11	321	1,897.6104	0	6,400.1135	1,956.7111	150.075
Slice 12	331.7	1,898.686	0	6,709.3549	2,051.2556	150.075
Slice 13	341.1	1,899.631	0	7,234.3141	2,211.7518	150.075
Slice 14	350.5	1,900.5759	0	7,759.2733	2,372.2479	150.075
Slice 15	359.9	1,901.5209	0	8,284.2325	2,532.744	150.075
Slice 16	369.3	1,902.4658	0	8,809.1917	2,693.2402	150.075
Slice 17	377.5	1,903.2901	0	9,030.2122	2,760.8129	150.075
Slice 18	384.5	1,903.9938	0	8,947.294	2,735.4623	150.075
Slice 19	392.14446	1,904.7623	0	9,134.2196	2,792.6112	150.075
Slice 20	400.43339	1,905.5955	0	9,590.9891	2,932.2596	150.075
Slice 21	408.72232	1,906.4288	0	10,047.759	3,071.9081	150.075
Slice 22	417.65008	1,913.6767	0	5,702.2777	4,784.7791	225
Slice 23	427.2167	1,927.3392	0	5,127.1506	4,302.1902	225
Slice 24	436.43803	1,940.5087	0	4,458.5518	3,741.1692	225
Slice 25	445.31408	1,953.185	0	3,696.4813	3,101.7161	225
Slice 26	454.19014	1,965.8613	0	2,934.4107	2,462.263	225
Slice 27	463.0662	1,978.5376	0	2,172.3402	1,822.8099	225

Slice 28	472.25211	1,991.6565	0	1,541.5795	1,001.1134	200
Slice 29	480.5192	2,003.4631	0	791.13205	513.76716	200
Slice 30	487.55759	2,013.515	0	190.46801	123.69137	200

Section 10-10 Seismic Final with keyway SSA for Skyline Ranch.gsz

Section 10-10 Seismic Final with keyway SSA for Skyline Ranch.gsz Run By: Dr. Alexander Bykovtsev, Ph.D., P.E. 3/19/2016 7:00:06 PM

Name: Fill
 Model: Mohr-Coulomb
 Unit Weight: 120 pcf
 Cohesion: 200 psf
 Phi: 33 °

Materials

- Fill
- TQs 150-11° bedding 0-6°
- TQs 150-17° bedding 0-6°

Seismic load
 Horizontal: 0.15
 Vertical: 0.0

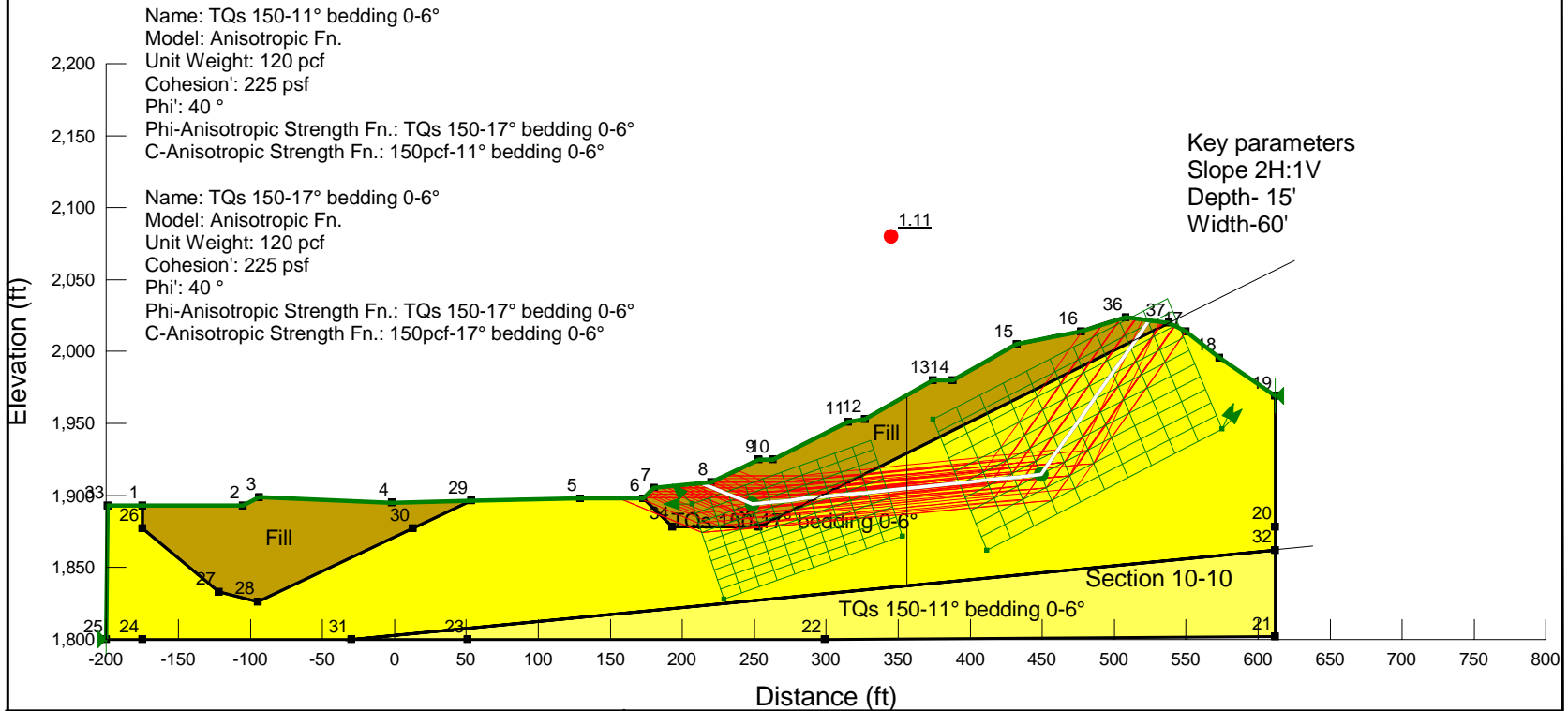

LGC Valley, Inc
 GEOTECHNICAL CONSULTING
 28532 Constellation Road, Valencia, CA 91355
 Phone 661-702-8474, Fax 661-702-8475

Skyline Ranch
 Development project, Tract 60922
 Los Angeles CA

Project No: **153035-01**
 Engineer: **BAS**
 Date: **March 2016**

2 - Translational

Report generated using GeoStudio 2012. Copyright © 1991-2015 GEO-SLOPE International Ltd.

File Information

File Version: 8.15
 Title: Static Slope Stability Analyses for Skyline Ranch Development project, Tract 60922, Los Angeles CA
 Comments: Run By: Dr. Alexander Bykovtsev, Ph.D., P.E.
 Last Edited By: Alexander Bykovtsev
 Revision Number: 92
 Date: 3/19/2016
 Time: 7:00:06 PM
 Tool Version: 8.15.1.11236
 File Name: Section 10-10 Seismic Final with keyway SSA for Skyline Ranch.gsz
 Directory: C:\Users\Alexander\Desktop\LGC valley\original sections\
 Last Solved Date: 3/19/2016
 Last Solved Time: 7:02:03 PM

Project Settings

Length(L) Units: Feet
 Time(t) Units: Seconds
 Force(F) Units: Pounds
 Pressure(p) Units: psf
 Strength Units: psf
 Unit Weight of Water: 62.4 pcf
 View: 2D
 Element Thickness: 1

Analysis Settings

2 - Translational

Kind: SLOPE/W
 Method: Janbu
 Settings
 PWP Conditions Source: (none)
 Slip Surface
 Direction of movement: Right to Left
 Use Passive Mode: No
 Slip Surface Option: Block
 Critical slip surfaces saved: 10
 Resisting Side Maximum Convex Angle: 1 °
 Driving Side Maximum Convex Angle: 5 °
 Restrict Block Crossing: No
 Optimize Critical Slip Surface Location: No
 Tension Crack

file:///C:/Users/Alexander/Desktop/LGC%20valley/original%20sections/section%2010-10... 3/19/2016

Tension Crack Option: (none)
 F of S Distribution
 F of S Calculation Option: Constant
 Advanced
 Number of Slices: 30
 F of S Tolerance: 0.01
 Minimum Slip Surface Depth: 0.1 ft

Materials

Fill

Model: Mohr-Coulomb
 Unit Weight: 120 pcf
 Cohesion': 200 psf
 Phi': 33 °
 Phi-B: 0 °

TQs 150-11° bedding 0-6°

Model: Anisotropic Fn.
 Unit Weight: 120 pcf
 Cohesion': 225 psf
 Phi': 40 °
 Phi-Anisotropic Strength Fn.: TQs 150-17° bedding 0-6°
 C-Anisotropic Strength Fn.: 150pcf-11° bedding 0-6°
 Phi-B: 0 °

TQs 150-17° bedding 0-6°

Model: Anisotropic Fn.
 Unit Weight: 120 pcf
 Cohesion': 225 psf
 Phi': 40 °
 Phi-Anisotropic Strength Fn.: TQs 150-17° bedding 0-6°
 C-Anisotropic Strength Fn.: 150pcf-17° bedding 0-6°
 Phi-B: 0 °

Slip Surface Limits

Left Coordinate: (-200, 1,800) ft
 Right Coordinate: (612, 1,969) ft

Slip Surface Block

Left Grid
 Upper Left: (207, 1,894) ft
 Lower Left: (229, 1,828) ft
 Lower Right: (353, 1,872) ft
 X Increments: 10
 Y Increments: 10

file:///C:/Users/Alexander/Desktop/LGC%20valley/original%20sections/section%2010-10... 3/19/2016

Starting Angle: 135 °
 Ending Angle: 180 °
 Angle Increments: 2
 Right Grid
 Upper Left: (373.9817, 1,953.006) ft
 Lower Left: (411.6124, 1,862.1107) ft
 Lower Right: (574.679, 1,945.8768) ft
 X Increments: 10
 Y Increments: 10
 Starting Angle: 45 °
 Ending Angle: 65 °
 Angle Increments: 2

Seismic Coefficients

Horz Seismic Coef.: 0.15
 Vert Seismic Coef.: 0

Anisotropic Strength Functions

150pcf-11° bedding 0-6°

Model: Spline Data Point Function
 Function: Modifier Factor vs. Inclination
 Curve Fit to Data: 100 %
 Segment Curvature: 0 %
 Y-Intercept: 0.667
 Data Points: Inclination (°), Modifier Factor
 Data Point: (-90, 1)
 Data Point: (-0.9, 1)
 Data Point: (0, 0.667)
 Data Point: (6, 0.667)
 Data Point: (6.1, 1)

TQs 150-17° bedding 0-6°

Model: Spline Data Point Function
 Function: Modifier Factor vs. Inclination
 Curve Fit to Data: 100 %
 Segment Curvature: 0 %
 Y-Intercept: 0.425
 Data Points: Inclination (°), Modifier Factor
 Data Point: (-90, 1)
 Data Point: (-0.9, 1)
 Data Point: (0, 0.425)
 Data Point: (6, 0.425)
 Data Point: (6.1, 1)

150pcf-17° bedding 0-6°

Model: Spline Data Point Function
 Function: Modifier Factor vs. Inclination

Curve Fit to Data: 100 %
 Segment Curvature: 0 %
 Y-Intercept: 0.667
 Data Points: Inclination (°), Modifier Factor
 Data Point: (-90, 1)
 Data Point: (-0.9, 1)
 Data Point: (0, 0.667)
 Data Point: (6, 0.667)
 Data Point: (6.1, 1)

Points

	X (ft)	Y (ft)
Point 1	-175	1,893
Point 2	-105	1,893
Point 3	-94	1,899
Point 4	-2	1,895
Point 5	129	1,898
Point 6	173	1,898
Point 7	180	1,905
Point 8	220	1,909
Point 9	253	1,925
Point 10	263	1,925
Point 11	315	1,951
Point 12	327	1,953
Point 13	374	1,980
Point 14	388	1,980
Point 15	432	2,005
Point 16	477	2,014
Point 17	550	2,014
Point 18	573	1,996
Point 19	612	1,969
Point 20	612	1,878
Point 21	612	1,802
Point 22	299	1,800
Point 23	51	1,800
Point 24	-175	1,800
Point 25	-200	1,800
Point 26	-175.1684	1,877
Point 27	-122	1,833
Point 28	-95	1,826
Point 29	53	1,896.2595
Point 30	13	1,877.2704
Point 31	-30	1,800
Point 32	612	1,862

Point 33	-199	1,893
Point 34	193	1,878
Point 35	253	1,878
Point 36	508	2,024
Point 37	538	2,020

Regions

	Material	Points	Area (ft ²)
Region 1	Fill	26,27,28,30,29,4,3,2,1	8,996
Region 2	TQs 150-11° bedding 0-6°	31,23,22,21,32	19,589
Region 3	TQs 150-17° bedding 0-6°	31,32,20,19,18,17,37,35,34,6,5,29,30,28,27,26,1,33,25,24	70,166
Region 4	Fill	6,34,35,37,36,16,15,14,13,12,11,10,9,8,7	11,889

Current Slip Surface

Slip Surface: 99,572
 F of S: 1.11
 Volume: 16,392.944 ft³
 Weight: 1,967,153.3 lbs
 Resisting Force: 770,188.39 lbs
 Activating Force: 696,251.3 lbs
 F of S Rank (Analysis): 1 of 131,769 slip surfaces
 F of S Rank (Query): 1 of 50 slip surfaces
 Exit: (213.86735, 1,908.3867) ft
 Entry: (524.38023, 2,021.816) ft
 Radius: 174.70961 ft
 Center: (338.04733, 2,050.1733) ft

Slip Slices

	X (ft)	Y (ft)	PWP (psf)	Base Normal Stress (psf)	Frictional Strength (psf)	Cohesive Strength (psf)
Slice 1	216.93367	1,907.1166	0	348.42727	226.27131	200
Slice 2	224.76667	1,903.8721	0	1,277.1805	829.41072	200
Slice 3	234.3	1,899.9233	0	2,635.083	1,711.2429	200

Slice 4	243.83333	1,895.9744	0	3,992.9855	2,593.0751	200
Slice 5	250.8	1,894.2249	0	3,346.2791	2,173.0991	200
Slice 6	258	1,894.9608	0	3,383.7224	2,197.415	200
Slice 7	268.25613	1,896.0092	0	3,562.582	2,313.5678	200
Slice 8	278.76839	1,897.0837	0	4,036.034	2,621.0311	200
Slice 9	289.28064	1,898.1582	0	4,509.486	2,928.4944	200
Slice 10	299.65258	1,899.2184	0	5,134.421	1,569.75	150.075
Slice 11	309.88419	1,900.2643	0	5,609.4308	1,714.9751	150.075
Slice 12	321	1,901.4005	0	5,892.0677	1,801.3859	150.075
Slice 13	331.7	1,902.4942	0	6,196.2494	1,894.3835	150.075
Slice 14	341.1	1,903.4551	0	6,714.3486	2,052.7824	150.075
Slice 15	350.5	1,904.4159	0	7,232.4479	2,211.1812	150.075
Slice 16	359.9	1,905.3767	0	7,750.5471	2,369.5801	150.075
Slice 17	369.3	1,906.3376	0	8,268.6464	2,527.9789	150.075
Slice 18	381	1,907.5335	0	8,444.1871	2,581.6471	150.075
Slice 19	393.5	1,908.8112	0	8,659.7862	2,647.5623	150.075
Slice 20	404.5	1,909.9356	0	9,258.0021	2,830.4553	150.075
Slice 21	415.5	1,911.06	0	9,856.218	3,013.3483	150.075
Slice 22	426.5	1,912.1844	0	10,454.434	3,196.2412	150.075
Slice 23	436.31079	1,913.1872	0	10,802.738	3,302.7285	150.075
Slice 24	444.93238	1,914.0685	0	10,901.131	3,332.8102	150.075
Slice 25	453.86931	1,921.1159	0	4,951.0517	4,154.4256	225
Slice 26	463.12158	1,934.3296	0	4,295.6757	3,604.4999	225
Slice 27	472.37386	1,947.5432	0	3,640.2998	3,054.5742	225

Slice 28	482.16667	1,961.5287	0	2,983.1638	2,503.1717	225
Slice 29	492.5	1,976.2863	0	2,324.2679	1,950.2923	225
Slice 30	502.83333	1,991.0438	0	1,665.3719	1,397.413	225
Slice 31	511.56492	2,003.5138	0	1,014.8699	851.57692	225
Slice 32	519.75504	2,015.2105	0	331.69356	215.40432	200

Section 10-10 Static Final Temporary without keyway SSA for Skyline Ranch.gsz

Section 10-10 Static Final Temporary without keyway SSA for Skyline Ranch.gsz Run By: Dr. Alexander Bykovtsev, Ph.D., P.E. 3/19/2016 7:32:52 PM

Name: Fill
 Model: Mohr-Coulomb
 Unit Weight: 120 pcf
 Cohesion: 200 psf
 Phi: 33 °

Materials

- Fill
- TQs 150-11° bedding 0-6°
- TQs 150-17° bedding 0-6°

Name: TQs 150-11° bedding 0-6°
 Model: Anisotropic Fn.
 Unit Weight: 120 pcf
 Cohesion: 225 psf
 Phi: 40 °
 Phi-Anisotropic Strength Fn.: TQs 150-17° bedding 0-6°
 C-Anisotropic Strength Fn.: 150pcf-11° bedding 0-6°

Name: TQs 150-17° bedding 0-6°
 Model: Anisotropic Fn.
 Unit Weight: 120 pcf
 Cohesion: 225 psf
 Phi: 40 °
 Phi-Anisotropic Strength Fn.: TQs 150-17° bedding 0-6°
 C-Anisotropic Strength Fn.: 150pcf-17° bedding 0-6°

Key parameters
 Slope 2H:1V
 Depth- 15'
 Width-60'

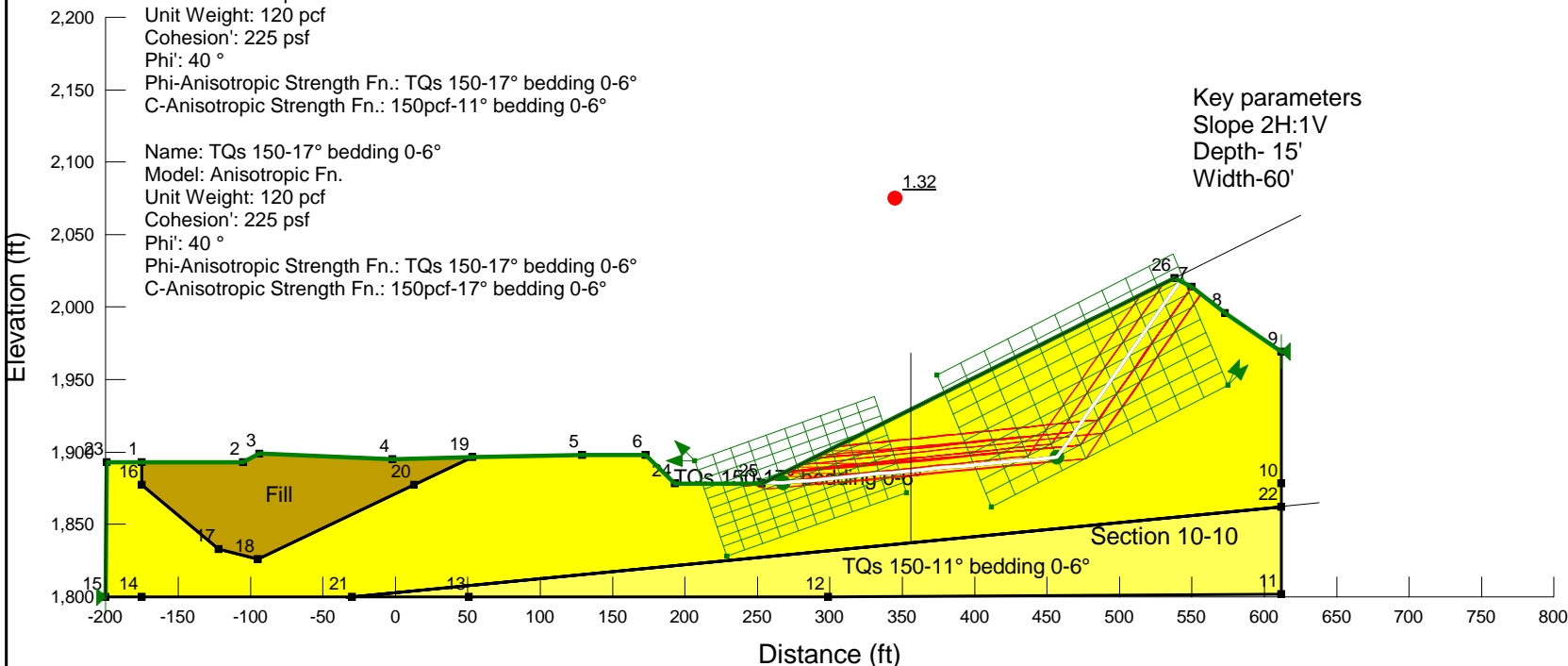

LGC **LGC Valley, Inc**
 GEOTECHNICAL CONSULTING
 28532 Constellation Road, Valencia, CA 91355
 Phone 661-702-8474, Fax 661-702-8475

Skyline Ranch
 Development project, Tract 60922
 Los Angeles CA

Project No: **153035-01**
 Engineer: **BAS**
 Date: **March 2016**

2 - Translational

Report generated using GeoStudio 2012. Copyright © 1991-2015 GEO-SLOPE International Ltd.

File Information

File Version: 8.15
 Title: Static Slope Stability Analyses for Skyline Ranch Development project, Tract 60922, Los Angeles CA
 Comments: Run By: Dr. Alexander Bykovtsev, Ph.D., P.E.
 Last Edited By: Alexander Bykovtsev
 Revision Number: 100
 Date: 3/19/2016
 Time: 7:32:52 PM
 Tool Version: 8.15.1.11236
 File Name: Section 10-10 Static Final Temporary without keyway SSA for Skyline Ranch.gsz
 Directory: C:\Users\Alexander\Desktop\LGC valley\original sections\
 Last Solved Date: 3/19/2016
 Last Solved Time: 7:33:40 PM

Project Settings

Length(L) Units: Feet
 Time(t) Units: Seconds
 Force(F) Units: Pounds
 Pressure(p) Units: psf
 Strength Units: psf
 Unit Weight of Water: 62.4 pcf
 View: 2D
 Element Thickness: 1

Analysis Settings

2 - Translational

Kind: SLOPE/W
 Method: Janbu
 Settings
 PWP Conditions Source: (none)
 Slip Surface
 Direction of movement: Right to Left
 Use Passive Mode: No
 Slip Surface Option: Block
 Critical slip surfaces saved: 10
 Resisting Side Maximum Convex Angle: 1 °
 Driving Side Maximum Convex Angle: 5 °
 Restrict Block Crossing: No
 Optimize Critical Slip Surface Location: No
 Tension Crack

file:///C:/Users/Alexander/Desktop/LGC%20valley/original%20sections/section%2010-10... 3/19/2016

Tension Crack Option: (none)
 F of S Distribution
 F of S Calculation Option: Constant
 Advanced
 Number of Slices: 30
 F of S Tolerance: 0.01
 Minimum Slip Surface Depth: 0.1 ft

Materials

Fill

Model: Mohr-Coulomb
 Unit Weight: 120 pcf
 Cohesion': 200 psf
 Phi': 33 °
 Phi-B: 0 °

TQs 150-11° bedding 0-6°

Model: Anisotropic Fn.
 Unit Weight: 120 pcf
 Cohesion': 225 psf
 Phi': 40 °
 Phi-Anisotropic Strength Fn.: TQs 150-17° bedding 0-6°
 C-Anisotropic Strength Fn.: 150pcf-11° bedding 0-6°
 Phi-B: 0 °

TQs 150-17° bedding 0-6°

Model: Anisotropic Fn.
 Unit Weight: 120 pcf
 Cohesion': 225 psf
 Phi': 40 °
 Phi-Anisotropic Strength Fn.: TQs 150-17° bedding 0-6°
 C-Anisotropic Strength Fn.: 150pcf-17° bedding 0-6°
 Phi-B: 0 °

Slip Surface Limits

Left Coordinate: (-200, 1,800) ft
 Right Coordinate: (612, 1,969) ft

Slip Surface Block

Left Grid
 Upper Left: (207, 1,894) ft
 Lower Left: (229, 1,828) ft
 Lower Right: (353, 1,872) ft
 X Increments: 10
 Y Increments: 10

file:///C:/Users/Alexander/Desktop/LGC%20valley/original%20sections/section%2010-10... 3/19/2016

Starting Angle: 135 °
 Ending Angle: 180 °
 Angle Increments: 2
 Right Grid
 Upper Left: (373.9817, 1,953.006) ft
 Lower Left: (411.6124, 1,862.1107) ft
 Lower Right: (574.679, 1,945.8768) ft
 X Increments: 10
 Y Increments: 10
 Starting Angle: 45 °
 Ending Angle: 65 °
 Angle Increments: 2

Seismic Coefficients

Horz Seismic Coef.: 0
 Vert Seismic Coef.: 0

Anisotropic Strength Functions

150pcf-11° bedding 0-6°

Model: Spline Data Point Function
 Function: Modifier Factor vs. Inclination
 Curve Fit to Data: 100 %
 Segment Curvature: 0 %
 Y-Intercept: 0.667
 Data Points: Inclination (°), Modifier Factor
 Data Point: (-90, 1)
 Data Point: (-0.9, 1)
 Data Point: (0, 0.667)
 Data Point: (6, 0.667)
 Data Point: (6.1, 1)

TQs 150-17° bedding 0-6°

Model: Spline Data Point Function
 Function: Modifier Factor vs. Inclination
 Curve Fit to Data: 100 %
 Segment Curvature: 0 %
 Y-Intercept: 0.425
 Data Points: Inclination (°), Modifier Factor
 Data Point: (-90, 1)
 Data Point: (-0.9, 1)
 Data Point: (0, 0.425)
 Data Point: (6, 0.425)
 Data Point: (6.1, 1)

150pcf-17° bedding 0-6°

Model: Spline Data Point Function
 Function: Modifier Factor vs. Inclination

Curve Fit to Data: 100 %
 Segment Curvature: 0 %
 Y-Intercept: 0.667
 Data Points: Inclination (°), Modifier Factor
 Data Point: (-90, 1)
 Data Point: (-0.9, 1)
 Data Point: (0, 0.667)
 Data Point: (6, 0.667)
 Data Point: (6.1, 1)

Points

	X (ft)	Y (ft)
Point 1	-175	1,893
Point 2	-105	1,893
Point 3	-94	1,899
Point 4	-2	1,895
Point 5	129	1,898
Point 6	173	1,898
Point 7	550	2,014
Point 8	573	1,996
Point 9	612	1,969
Point 10	612	1,878
Point 11	612	1,802
Point 12	299	1,800
Point 13	51	1,800
Point 14	-175	1,800
Point 15	-200	1,800
Point 16	-175.1684	1,877
Point 17	-122	1,833
Point 18	-95	1,826
Point 19	53	1,896.2595
Point 20	13	1,877.2704
Point 21	-30	1,800
Point 22	612	1,862
Point 23	-199	1,893
Point 24	193	1,878
Point 25	253	1,878
Point 26	538	2,020

Regions

	Material	Points	Area (ft²)
	Fill	16,17,18,20,19,4,3,2,1	8,996

Region 1			
Region 2	TQs 150-11° bedding 0-6°	21,13,12,11,22	19,589
Region 3	TQs 150-17° bedding 0-6°	21,22,10,9,8,7,26,25,24,6,5,19,20,18,17,16,1,23,15,14	70,166

Current Slip Surface

Slip Surface: 65,021
 F of S: 1.32
 Volume: 12,250.598 ft³
 Weight: 1,470,071.8 lbs
 Resisting Force: 542,715.93 lbs
 Activating Force: 411,405.32 lbs
 F of S Rank (Analysis): 1 of 131,769 slip surfaces
 F of S Rank (Query): 1 of 50 slip surfaces
 Exit: (254.20423, 1,878.6) ft
 Entry: (541.97298, 2,018.0135) ft
 Radius: 188.34833 ft
 Center: (347.43302, 2,052.8669) ft

Slip Slices

	X (ft)	Y (ft)	PWP (psf)	Base Normal Stress (psf)	Frictional Strength (psf)	Cohesive Strength (psf)
Slice 1	260.90211	1,878.6	0	400.46316	122.43387	150.075
Slice 2	272.32923	1,879.0433	0	998.29944	305.21077	150.075
Slice 3	281.7877	1,879.9298	0	1,447.7196	442.61228	150.075
Slice 4	291.24616	1,880.8163	0	1,897.1397	580.0138	150.075
Slice 5	300.70463	1,881.7028	0	2,346.5598	717.41532	150.075
Slice 6	310.16309	1,882.5893	0	2,795.9799	854.81684	150.075
Slice 7	319.62156	1,883.4758	0	3,245.4	992.21836	150.075
Slice 8	329.08003	1,884.3623	0	3,694.8201	1,129.6199	150.075
Slice 9	338.53849	1,885.2488	0	4,144.2402	1,267.0214	150.075
Slice 10	347.99696	1,886.1353	0	4,593.6604	1,404.4229	150.075
Slice 11	357.45542	1,887.0218	0	5,043.0805	1,541.8244	150.075
	366.91389	1,887.9083	0	5,492.5006	1,679.2259	150.075

Slice 12						
Slice 13	376.37235	1,888.7948	0	5,941.9207	1,816.6275	150.075
Slice 14	385.83082	1,889.6813	0	6,391.3408	1,954.029	150.075
Slice 15	395.28928	1,890.5678	0	6,840.7609	2,091.4305	150.075
Slice 16	404.74775	1,891.4543	0	7,290.1811	2,228.832	150.075
Slice 17	414.20622	1,892.3408	0	7,739.6012	2,366.2335	150.075
Slice 18	423.66468	1,893.2273	0	8,189.0213	2,503.6351	150.075
Slice 19	433.12315	1,894.1138	0	8,638.4414	2,641.0366	150.075
Slice 20	442.58161	1,895.0003	0	9,087.8615	2,778.4381	150.075
Slice 21	452.04008	1,895.8868	0	9,537.2816	2,915.8396	150.075
Slice 22	461.84623	1,903.5807	0	4,818.3043	4,043.0374	225
Slice 23	472.00006	1,918.0818	0	4,223.2569	3,543.7333	225
Slice 24	482.1539	1,932.583	0	3,628.2094	3,044.4292	225
Slice 25	492.30774	1,947.0842	0	3,033.1619	2,545.1251	225
Slice 26	502.46157	1,961.5854	0	2,438.1145	2,045.821	225
Slice 27	512.61541	1,976.0866	0	1,843.067	1,546.5169	225
Slice 28	522.76925	1,990.5877	0	1,248.0196	1,047.2128	225
Slice 29	532.92308	2,005.0889	0	652.97212	547.90866	225
Slice 30	539.98649	2,015.1765	0	114.06313	95.71033	225

Section 11-11 Static Final with 250' keyway SSA for Skyline Ranch.gsz

Section 11-11 Static Final with 250' keyway SSA for Skyline Ranch.gsz Run By: Dr. Alexander Bykovtsev, Ph.D., P.E. 3/20/2016 5:11:13 PM

- Materials**
- QIs
 - TQs 150-17° bedding 17-23°
 - Fill
 - TQs 150-11° bedding 11-15°
 - TQs 150-17° bedding 5-15°

Key parameters
 Slope 2H:1V
 Depth- 25'
 Width-260'

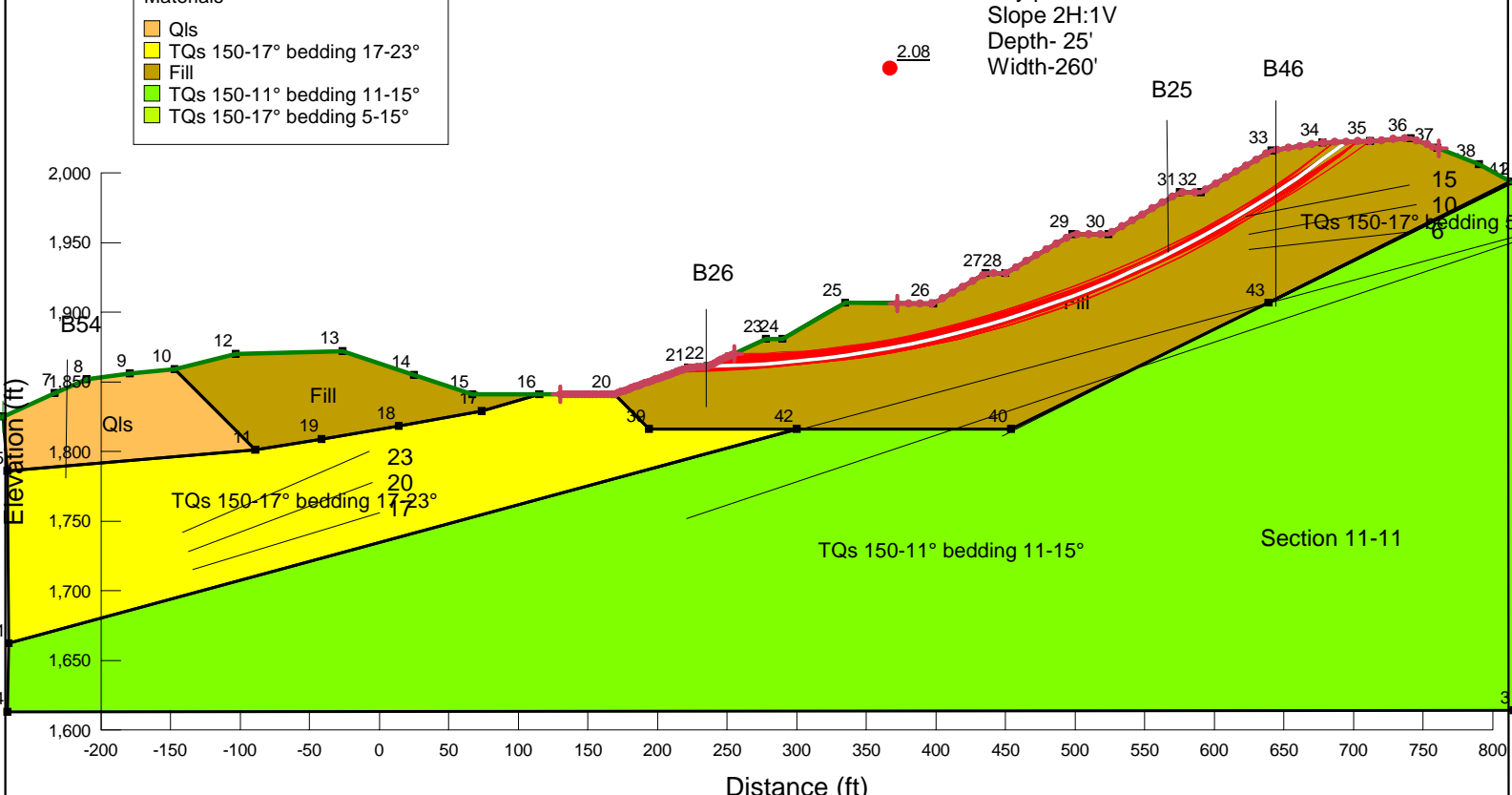

- Name: QIs
- Model: Mohr-Coulomb
- Unit Weight: 100 pcf
- Cohesion: 0 psf
- Phi: 20 °
- Name: TQs 150-17° bedding 17-23°
- Model: Anisotropic Fn.
- Unit Weight: 120 pcf
- Cohesion: 225 psf
- Phi: 40 °
- Phi-Anisotropic Strength Fn.: TQs 150-17° bedding 17-23°
- C-Anisotropic Strength Fn.: 150pcf-17° bedding 17-23°
- Name: Fill
- Model: Mohr-Coulomb
- Unit Weight: 120 pcf
- Cohesion: 200 psf
- Phi: 33 °
- Name: TQs 150-11° bedding 11-15°
- Model: Anisotropic Fn.
- Unit Weight: 120 pcf
- Cohesion: 225 psf
- Phi: 40 °
- Phi-Anisotropic Strength Fn.: TQs 150-11° bedding 11-15°
- C-Anisotropic Strength Fn.: 150pcf-11° bedding 11-15°
- Name: TQs 150-17° bedding 5-15°
- Model: Anisotropic Fn.
- Unit Weight: 120 pcf
- Cohesion: 225 psf
- Phi: 40 °
- Phi-Anisotropic Strength Fn.: TQs 150-17° bedding 5-15°
- C-Anisotropic Strength Fn.: 150pcf-17° bedding 11-15°

LGC LGC Valley, Inc
 GEOTECHNICAL CONSULTING
 28532 Constellation Road, Valencia, CA 91355
 Phone 661-702-8474, Fax 661-702-8475

Skyline Ranch
 Development project, Tract 60922
 Los Angeles CA

Project No: **153035-01**
 Engineer: **BAS**
 Date: **March 2016**

1 - Circular Mode of Failure

Report generated using GeoStudio 2012. Copyright © 1991-2015 GEO-SLOPE International Ltd.

File Information

File Version: 8.15
 Title: Static Slope Stability Analyses for Skyline Ranch Development project, Tract 60922, Los Angeles CA
 Comments: Run By: Dr. Alexander Bykovtsev, Ph.D., P.E.
 Last Edited By: Alexander Bykovtsev
 Revision Number: 134
 Date: 3/20/2016
 Time: 5:11:13 PM
 Tool Version: 8.15.1.11236
 File Name: Section 11-11 Static Final with 250' keyway SSA for Skyline Ranch.gsz
 Directory: C:\Users\Alexander\Desktop\LGC valley\original sections\
 Last Solved Date: 3/20/2016
 Last Solved Time: 5:13:41 PM

Project Settings

Length(L) Units: Feet
 Time(t) Units: Seconds
 Force(F) Units: Pounds
 Pressure(p) Units: psf
 Strength Units: psf
 Unit Weight of Water: 62.4 pcf
 View: 2D
 Element Thickness: 1

Analysis Settings

1 - Circular Mode of Failure

Kind: SLOPE/W
 Method: Bishop
 Settings
 PWP Conditions Source: (none)
 Slip Surface
 Direction of movement: Right to Left
 Use Passive Mode: No
 Slip Surface Option: Entry and Exit
 Critical slip surfaces saved: 10
 Resisting Side Maximum Convex Angle: 1 °
 Driving Side Maximum Convex Angle: 5 °
 Optimize Critical Slip Surface Location: No
 Tension Crack
 Tension Crack Option: (none)
 F of S Distribution
 F of S Calculation Option: Constant
 Advanced
 Number of Slices: 30

F of S Tolerance: 0.01
 Minimum Slip Surface Depth: 0.1 ft

Materials

Q1s

Model: Mohr-Coulomb
 Unit Weight: 100 pcf
 Cohesion: 0 psf
 Phi: 20 °
 Phi-B: 0 °

TQs 150-17° bedding 17-23°

Model: Anisotropic Fn.
 Unit Weight: 120 pcf
 Cohesion: 225 psf
 Phi: 40 °
 Phi-Anisotropic Strength Fn.: TQs 150-17° bedding 17-23°
 C-Anisotropic Strength Fn.: 150pcf-17° bedding 17-23°
 Phi-B: 0 °

Fill

Model: Mohr-Coulomb
 Unit Weight: 120 pcf
 Cohesion: 200 psf
 Phi: 33 °
 Phi-B: 0 °

TQs 150-11° bedding 11-15°

Model: Anisotropic Fn.
 Unit Weight: 120 pcf
 Cohesion: 225 psf
 Phi: 40 °
 Phi-Anisotropic Strength Fn.: TQs 150-11° bedding 11-15°
 C-Anisotropic Strength Fn.: 150pcf-11° bedding 11-15°
 Phi-B: 0 °

TQs 150-17° bedding 5-15°

Model: Anisotropic Fn.
 Unit Weight: 120 pcf
 Cohesion: 225 psf
 Phi: 40 °
 Phi-Anisotropic Strength Fn.: TQs 150-17° bedding 5-15°
 C-Anisotropic Strength Fn.: 150pcf-17° bedding 11-15°
 Phi-B: 0 °

Slip Surface Entry and Exit

Left Projection: Range
 Left-Zone Left Coordinate: (130.2939, 1,841) ft
 Left-Zone Right Coordinate: (255.214, 1,870.1495) ft
 Left-Zone Increment: 50

Right Projection: [Range](#)
 Right-Zone Left Coordinate: (371.9441, 1,906.4136) ft
 Right-Zone Right Coordinate: (760.9121, 2,017.6352) ft
 Right-Zone Increment: 50
 Radius Increments: 50

Slip Surface Limits

Left Coordinate: (-270, 1,825) ft
 Right Coordinate: (815, 1,994) ft

Seismic Coefficients

Horz Seismic Coef.: 0
 Vert Seismic Coef.: 0

Anisotropic Strength Functions

TQs 150-17° bedding 17-23°

Model: [Spline Data Point Function](#)
 Function: [Modifier Factor vs. Inclination](#)
 Curve Fit to Data: 100 %
 Segment Curvature: 0 %
 Y-Intercept: 1
 Data Points: [Inclination \(°\), Modifier Factor](#)
 Data Point: (-90, 1)
 Data Point: (16.9, 1)
 Data Point: (17, 0.425)
 Data Point: (23, 0.425)
 Data Point: (23.1, 1)

150pcf-17° bedding 17-23°

Model: [Spline Data Point Function](#)
 Function: [Modifier Factor vs. Inclination](#)
 Curve Fit to Data: 100 %
 Segment Curvature: 0 %
 Y-Intercept: 1
 Data Points: [Inclination \(°\), Modifier Factor](#)
 Data Point: (-90, 1)
 Data Point: (16.9, 1)
 Data Point: (17, 0.667)
 Data Point: (23, 0.667)
 Data Point: (23.1, 1)

TQs 150-17° bedding 5-15°

Model: [Spline Data Point Function](#)
 Function: [Modifier Factor vs. Inclination](#)
 Curve Fit to Data: 100 %
 Segment Curvature: 0 %
 Y-Intercept: 1
 Data Points: [Inclination \(°\), Modifier Factor](#)
 Data Point: (-90, 1)

Data Point: (4.9, 1)
 Data Point: (5, 0.425)
 Data Point: (15, 0.425)
 Data Point: (15.1, 1)

150pcf-17° bedding 11-15°

Model: [Spline Data Point Function](#)
 Function: [Modifier Factor vs. Inclination](#)
 Curve Fit to Data: 100 %
 Segment Curvature: 0 %
 Y-Intercept: 1
 Data Points: [Inclination \(°\), Modifier Factor](#)
 Data Point: (-90, 1)
 Data Point: (4.9, 1)
 Data Point: (5, 0.667)
 Data Point: (15, 0.667)
 Data Point: (15.1, 1)

TQs 150-11° bedding 11-15°

Model: [Spline Data Point Function](#)
 Function: [Modifier Factor vs. Inclination](#)
 Curve Fit to Data: 100 %
 Segment Curvature: 0 %
 Y-Intercept: 1
 Data Points: [Inclination \(°\), Modifier Factor](#)
 Data Point: (-90, 1)
 Data Point: (10.9, 1)
 Data Point: (11, 0.275)
 Data Point: (17, 0.275)
 Data Point: (17.1, 1)

150pcf-11° bedding 11-15°

Model: [Spline Data Point Function](#)
 Function: [Modifier Factor vs. Inclination](#)
 Curve Fit to Data: 100 %
 Segment Curvature: 0 %
 Y-Intercept: 1
 Data Points: [Inclination \(°\), Modifier Factor](#)
 Data Point: (-90, 1)
 Data Point: (10.9, 1)
 Data Point: (11, 0.667)
 Data Point: (15, 0.667)
 Data Point: (15.1, 1)

Points

	X (ft)	Y (ft)
Point 1	-266	1,662
Point 2	815	1,994
Point 3	815	1,614
Point 4	-267	1,613
Point 5	-267	1,786
Point 6	-270	1,825

Point 7	-233	1,842
Point 8	-210	1,852
Point 9	-179	1,856
Point 10	-147	1,859
Point 11	-89	1,801
Point 12	-103	1,870
Point 13	-26	1,872
Point 14	25	1,855
Point 15	67	1,841
Point 16	115	1,841
Point 17	74	1,829
Point 18	14	1,818
Point 19	-41	1,809
Point 20	169	1,841
Point 21	222	1,860
Point 22	236	1,861
Point 23	278	1,881
Point 24	290	1,881
Point 25	335	1,907
Point 26	398	1,906
Point 27	436	1,928
Point 28	450	1,928
Point 29	498	1,956
Point 30	524	1,956
Point 31	575	1,986
	590	1,986

Point 32		
Point 33	641	2,016
Point 34	678	2,022
Point 35	712	2,023
Point 36	741	2,025
Point 37	760	2,018
Point 38	790	2,006
Point 39	194	1,816
Point 40	454	1,816
Point 41	813	1,994
Point 42	300	1,816
Point 43	639	1,907

Regions

	Material	Points	Area (ft ²)
Region 1	TQs 150-11° bedding 11-15°	1,4,3,2,43,40,42	2.0743e+005
Region 2	Qls	5,6,7,8,9,10,11	8,715
Region 3	Fill	10,12,13,14,15,16,17,18,19,11	9,960
Region 4	TQs 150-17° bedding 17-23°	16,17,18,19,11,5,1,42,39,20	41,895
Region 5	TQs 150-17° bedding 5-15°	2,41,43	87
Region 6	Fill	20,39,42,40,43,41,38,37,36,35,34,33,32,31,30,29,28,27,26,25,24,23,22,21	52,185

Current Slip Surface

Slip Surface: 111,395
F of S: 2.08

Volume: 13,457.952 ft³
 Weight: 1,614,954.2 lbs
 Resisting Moment: 8.4519605e+008 lbs-ft
 Activating Moment: 4.0620067e+008 lbs-ft
 F of S Rank (Analysis): 1 of 132,651 slip surfaces
 F of S Rank (Query): 1 of 100 slip surfaces
 Exit: (236.38743, 1,861.1845) ft
 Entry: (694.99917, 2,022.5) ft
 Radius: 765.84149 ft
 Center: (224.71301, 2,626.937) ft

Slip Slices

	X (ft)	Y (ft)	PWP (psf)	Base Normal Stress (psf)	Frictional Strength (psf)	Cohesive Strength (psf)
Slice 1	243.32286	1,861.3531	0	370.93407	240.8874	200
Slice 2	257.19372	1,861.8161	0	1,094.5741	710.82476	200
Slice 3	271.06457	1,862.5311	0	1,780.4771	1,156.2554	200
Slice 4	284	1,863.4175	0	2,052.7439	1,333.0675	200
Slice 5	297.5	1,864.5995	0	2,407.2284	1,563.2724	200
Slice 6	312.5	1,866.181	0	3,211.6387	2,085.6626	200
Slice 7	327.5	1,868.0623	0	3,971.7733	2,579.2997	200
Slice 8	342.875	1,870.308	0	4,169.9869	2,708.0212	200
Slice 9	358.625	1,872.9365	0	3,814.3422	2,477.0628	200
Slice 10	374.375	1,875.9044	0	3,424.5553	2,223.9322	200
Slice 11	390.125	1,879.2158	0	3,000.8693	1,948.7873	200
Slice 12	407.5	1,883.293	0	3,121.9662	2,027.4285	200
Slice 13	426.5	1,888.2231	0	3,766.2189	2,445.8111	200
Slice 14	443	1,892.8998	0	3,828.4792	2,486.2435	200
Slice 15	458	1,897.5401	0	3,805.0151	2,471.0057	200
Slice 16	474	1,902.853	0	4,212.387	2,735.5561	200
Slice 17	490	1,908.5616	0	4,570.8406	2,968.3386	200
Slice 18	504.5	1,914.067	0	4,449.7307	2,889.6889	200
Slice 19	517.5	1,919.3075	0	3,864.7675	2,509.8094	200
Slice 20	532.5	1,925.7279	0	3,686.0226	2,393.7311	200
Slice 21	549.5	1,933.4397	0	3,893.678	2,528.584	200
Slice 22	566.5	1,941.66	0	4,044.0082	2,626.2096	200
Slice 23	582.5	1,949.8626	0	3,679.4836	2,389.4846	200

Slice 24	598.5	1,958.5796	0	3,267.038	2,121.6393	200
Slice 25	615.5	1,968.3772	0	3,255.4255	2,114.098	200
Slice 26	632.5	1,978.7687	0	3,182.9473	2,067.0302	200
Slice 27	650.25	1,990.2992	0	2,648.0235	1,719.6465	200
Slice 28	668.75	2,003.0657	0	1,656.2169	1,075.5598	200
Slice 29	686.49959	2,016.0746	0	540.94276	351.29234	200

Section 11-11 Seismic Final with 250' keyway SSA for Skyline Ranch.gsz

Section 11-11 Seismic Final with 250' keyway SSA for Skyline Ranch.gsz Run By: Dr. Alexander Bykovtsev, Ph.D., P.E. 3/20/2016 5:04:15 PM

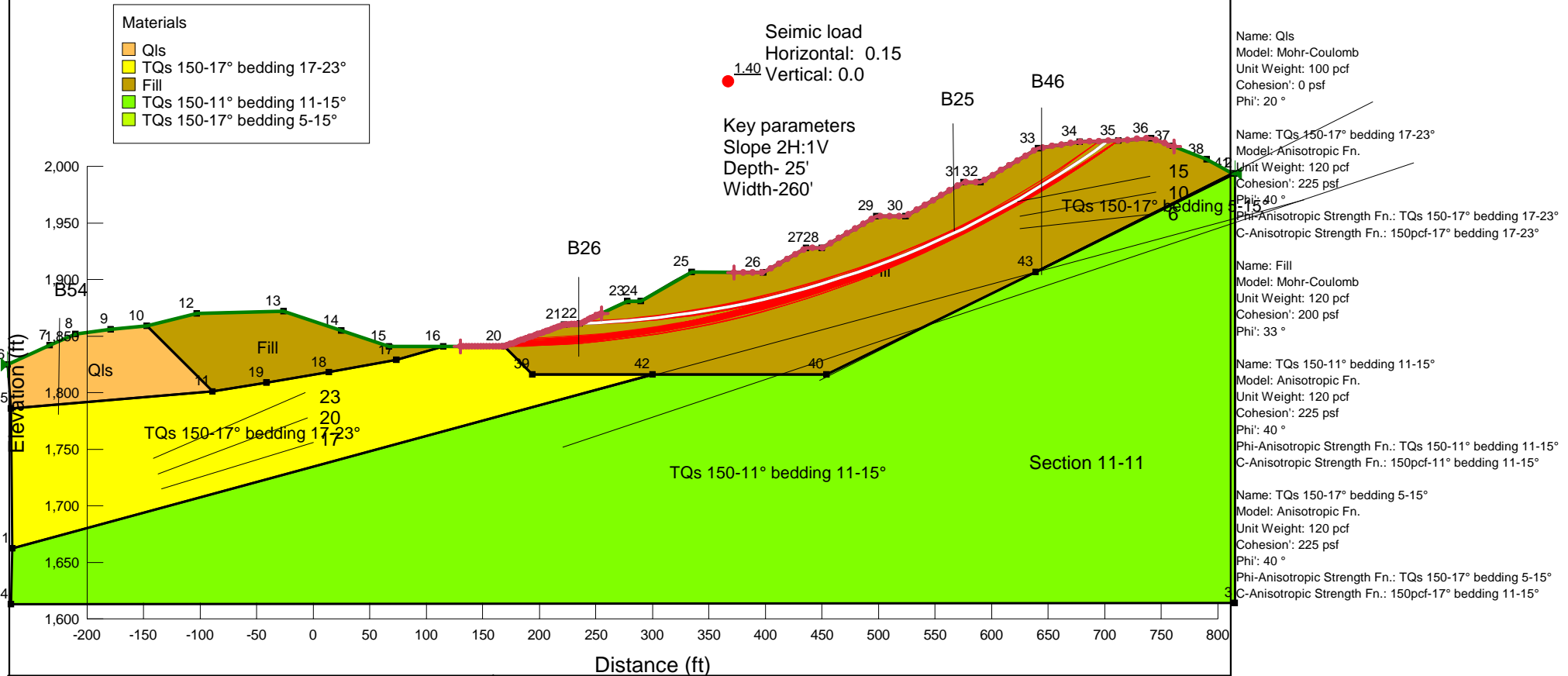

LGC **LGC Valley, Inc**
 GEOTECHNICAL CONSULTING
 28532 Constellation Road, Valencia, CA 91355
 Phone 661-702-8474, Fax 661-702-8475

Skyline Ranch
 Development project, Tract 60922
 Los Angeles CA

Project No: **153035-01**
 Engineer: **BAS**
 Date: **March 2016**

1 - Circular Mode of Failure

Report generated using GeoStudio 2012. Copyright © 1991-2015 GEO-SLOPE International Ltd.

File Information

File Version: 8.15
 Title: Static Slope Stability Analyses for Skyline Ranch Development project, Tract 60922, Los Angeles CA
 Comments: Run By: Dr. Alexander Bykovtsev, Ph.D., P.E.
 Last Edited By: Alexander Bykovtsev
 Revision Number: 132
 Date: 3/20/2016
 Time: 5:04:15 PM
 Tool Version: 8.15.1.11236
 File Name: Section 11-11 Seismic Final with 250' keyway SSA for Skyline Ranch.gsz
 Directory: C:\Users\Alexander\Desktop\LGC valley\original sections\
 Last Solved Date: 3/20/2016
 Last Solved Time: 5:07:26 PM

Project Settings

Length(L) Units: Feet
 Time(t) Units: Seconds
 Force(F) Units: Pounds
 Pressure(p) Units: psf
 Strength Units: psf
 Unit Weight of Water: 62.4 pcf
 View: 2D
 Element Thickness: 1

Analysis Settings

1 - Circular Mode of Failure

Kind: SLOPE/W
 Method: Bishop
 Settings
 PWP Conditions Source: (none)
 Slip Surface
 Direction of movement: Right to Left
 Use Passive Mode: No
 Slip Surface Option: Entry and Exit
 Critical slip surfaces saved: 10
 Resisting Side Maximum Convex Angle: 1 °
 Driving Side Maximum Convex Angle: 5 °
 Optimize Critical Slip Surface Location: No
 Tension Crack
 Tension Crack Option: (none)
 F of S Distribution
 F of S Calculation Option: Constant
 Advanced
 Number of Slices: 30

file:///C:/Users/Alexander/Desktop/LGC%20valley/original%20sections/Final%20Results... 3/20/2016

F of S Tolerance: 0.01
 Minimum Slip Surface Depth: 0.1 ft

Materials

Q1s

Model: Mohr-Coulomb
 Unit Weight: 100 pcf
 Cohesion: 0 psf
 Phi: 20 °
 Phi-B: 0 °

TQs 150-17° bedding 17-23°

Model: Anisotropic Fn.
 Unit Weight: 120 pcf
 Cohesion: 225 psf
 Phi: 40 °
 Phi-Anisotropic Strength Fn.: TQs 150-17° bedding 17-23°
 C-Anisotropic Strength Fn.: 150pcf-17° bedding 17-23°
 Phi-B: 0 °

Fill

Model: Mohr-Coulomb
 Unit Weight: 120 pcf
 Cohesion: 200 psf
 Phi: 33 °
 Phi-B: 0 °

TQs 150-11° bedding 11-15°

Model: Anisotropic Fn.
 Unit Weight: 120 pcf
 Cohesion: 225 psf
 Phi: 40 °
 Phi-Anisotropic Strength Fn.: TQs 150-11° bedding 11-15°
 C-Anisotropic Strength Fn.: 150pcf-11° bedding 11-15°
 Phi-B: 0 °

TQs 150-17° bedding 5-15°

Model: Anisotropic Fn.
 Unit Weight: 120 pcf
 Cohesion: 225 psf
 Phi: 40 °
 Phi-Anisotropic Strength Fn.: TQs 150-17° bedding 5-15°
 C-Anisotropic Strength Fn.: 150pcf-17° bedding 11-15°
 Phi-B: 0 °

Slip Surface Entry and Exit

Left Projection: Range
 Left-Zone Left Coordinate: (130.2939, 1,841) ft
 Left-Zone Right Coordinate: (255.214, 1,870.1495) ft
 Left-Zone Increment: 50

file:///C:/Users/Alexander/Desktop/LGC%20valley/original%20sections/Final%20Results... 3/20/2016

Right Projection: [Range](#)
 Right-Zone Left Coordinate: (371.9441, 1,906.4136) ft
 Right-Zone Right Coordinate: (760.9121, 2,017.6352) ft
 Right-Zone Increment: 50
 Radius Increments: 50

Slip Surface Limits

Left Coordinate: (-270, 1,825) ft
 Right Coordinate: (815, 1,994) ft

Seismic Coefficients

Horz Seismic Coef.: 0.15
 Vert Seismic Coef.: 0

Anisotropic Strength Functions

TQs 150-17° bedding 17-23°

Model: [Spline Data Point Function](#)
 Function: [Modifier Factor vs. Inclination](#)
 Curve Fit to Data: 100 %
 Segment Curvature: 0 %
 Y-Intercept: 1
 Data Points: [Inclination \(°\), Modifier Factor](#)
 Data Point: (-90, 1)
 Data Point: (16.9, 1)
 Data Point: (17, 0.425)
 Data Point: (23, 0.425)
 Data Point: (23.1, 1)

150pcf-17° bedding 17-23°

Model: [Spline Data Point Function](#)
 Function: [Modifier Factor vs. Inclination](#)
 Curve Fit to Data: 100 %
 Segment Curvature: 0 %
 Y-Intercept: 1
 Data Points: [Inclination \(°\), Modifier Factor](#)
 Data Point: (-90, 1)
 Data Point: (16.9, 1)
 Data Point: (17, 0.667)
 Data Point: (23, 0.667)
 Data Point: (23.1, 1)

TQs 150-17° bedding 5-15°

Model: [Spline Data Point Function](#)
 Function: [Modifier Factor vs. Inclination](#)
 Curve Fit to Data: 100 %
 Segment Curvature: 0 %
 Y-Intercept: 1
 Data Points: [Inclination \(°\), Modifier Factor](#)
 Data Point: (-90, 1)

Data Point: (4.9, 1)
 Data Point: (5, 0.425)
 Data Point: (15, 0.425)
 Data Point: (15.1, 1)

150pcf-17° bedding 11-15°

Model: [Spline Data Point Function](#)
 Function: [Modifier Factor vs. Inclination](#)
 Curve Fit to Data: 100 %
 Segment Curvature: 0 %
 Y-Intercept: 1
 Data Points: [Inclination \(°\), Modifier Factor](#)
 Data Point: (-90, 1)
 Data Point: (4.9, 1)
 Data Point: (5, 0.667)
 Data Point: (15, 0.667)
 Data Point: (15.1, 1)

TQs 150-11° bedding 11-15°

Model: [Spline Data Point Function](#)
 Function: [Modifier Factor vs. Inclination](#)
 Curve Fit to Data: 100 %
 Segment Curvature: 0 %
 Y-Intercept: 1
 Data Points: [Inclination \(°\), Modifier Factor](#)
 Data Point: (-90, 1)
 Data Point: (10.9, 1)
 Data Point: (11, 0.275)
 Data Point: (17, 0.275)
 Data Point: (17.1, 1)

150pcf-11° bedding 11-15°

Model: [Spline Data Point Function](#)
 Function: [Modifier Factor vs. Inclination](#)
 Curve Fit to Data: 100 %
 Segment Curvature: 0 %
 Y-Intercept: 1
 Data Points: [Inclination \(°\), Modifier Factor](#)
 Data Point: (-90, 1)
 Data Point: (10.9, 1)
 Data Point: (11, 0.667)
 Data Point: (15, 0.667)
 Data Point: (15.1, 1)

Points

	X (ft)	Y (ft)
Point 1	-266	1,662
Point 2	815	1,994
Point 3	815	1,614
Point 4	-267	1,613
Point 5	-267	1,786
Point 6	-270	1,825

Point 7	-233	1,842
Point 8	-210	1,852
Point 9	-179	1,856
Point 10	-147	1,859
Point 11	-89	1,801
Point 12	-103	1,870
Point 13	-26	1,872
Point 14	25	1,855
Point 15	67	1,841
Point 16	115	1,841
Point 17	74	1,829
Point 18	14	1,818
Point 19	-41	1,809
Point 20	169	1,841
Point 21	222	1,860
Point 22	236	1,861
Point 23	278	1,881
Point 24	290	1,881
Point 25	335	1,907
Point 26	398	1,906
Point 27	436	1,928
Point 28	450	1,928
Point 29	498	1,956
Point 30	524	1,956
Point 31	575	1,986
	590	1,986

Point 32		
Point 33	641	2,016
Point 34	678	2,022
Point 35	712	2,023
Point 36	741	2,025
Point 37	760	2,018
Point 38	790	2,006
Point 39	194	1,816
Point 40	454	1,816
Point 41	813	1,994
Point 42	300	1,816
Point 43	639	1,907

Regions

	Material	Points	Area (ft ²)
Region 1	TQs 150-11° bedding 11-15°	1,4,3,2,43,40,42	2.0743e+005
Region 2	Qls	5,6,7,8,9,10,11	8,715
Region 3	Fill	10,12,13,14,15,16,17,18,19,11	9,960
Region 4	TQs 150-17° bedding 17-23°	16,17,18,19,11,5,1,42,39,20	41,895
Region 5	TQs 150-17° bedding 5-15°	2,41,43	87
Region 6	Fill	20,39,42,40,43,41,38,37,36,35,34,33,32,31,30,29,28,27,26,25,24,23,22,21	52,185

Current Slip Surface

Slip Surface: 111,445
F of S: 1.40

Volume: 13,525.903 ft³
 Weight: 1,623,108.4 lbs
 Resisting Moment: 8.8568221e+008 lbs-ft
 Activating Moment: 6.319232e+008 lbs-ft
 F of S Rank (Analysis): 1 of 132,651 slip surfaces
 F of S Rank (Query): 1 of 100 slip surfaces
 Exit: (236.38743, 1,861.1845) ft
 Entry: (703.40902, 2,022.7473) ft
 Radius: 836.89711 ft
 Center: (208.48626, 2,697.6164) ft

Slip Slices

	X (ft)	Y (ft)	PWP (psf)	Base Normal Stress (psf)	Frictional Strength (psf)	Cohesive Strength (psf)
Slice 1	243.32286	1,861.4734	0	348.97626	226.62783	200
Slice 2	257.19372	1,862.1667	0	1,034.8511	672.04019	200
Slice 3	271.06457	1,863.0911	0	1,683.6765	1,093.3923	200
Slice 4	284	1,864.1548	0	1,927.733	1,251.8844	200
Slice 5	297.5	1,865.5007	0	2,253.1932	1,463.2408	200
Slice 6	312.5	1,867.2425	0	3,018.1974	1,960.0403	200
Slice 7	327.5	1,869.2595	0	3,739.8716	2,428.701	200
Slice 8	342.875	1,871.6183	0	3,913.1576	2,541.2343	200
Slice 9	358.625	1,874.3357	0	3,549.3584	2,304.9803	200
Slice 10	374.375	1,877.3645	0	3,157.1346	2,050.2672	200
Slice 11	390.125	1,880.7081	0	2,736.8888	1,777.3564	200
Slice 12	407.5	1,884.7851	0	2,848.3543	1,849.7429	200
Slice 13	426.5	1,889.6746	0	3,467.8152	2,252.0255	200
Slice 14	443	1,894.2815	0	3,528.2505	2,291.2727	200
Slice 15	458	1,898.8239	0	3,509.5952	2,279.1578	200
Slice 16	474	1,903.9993	0	3,907.743	2,537.718	200
Slice 17	490	1,909.5335	0	4,261.0923	2,767.1857	200
Slice 18	504.5	1,914.8493	0	4,157.114	2,699.6614	200
Slice 19	517.5	1,919.89	0	3,612.6961	2,346.1123	200
Slice 20	532.5	1,926.0421	0	3,462.5969	2,248.6367	200
Slice 21	549.5	1,933.4045	0	3,686.9516	2,394.3344	200
Slice 22	566.5	1,941.2206	0	3,860.8905	2,507.2916	200
Slice 23	582.5	1,948.9908	0	3,549.6951	2,305.199	200

Slice 24	598.5	1,957.2153	0	3,199.5967	2,077.8424	200
Slice 25	615.5	1,966.4242	0	3,236.5338	2,101.8296	200
Slice 26	632.5	1,976.1513	0	3,222.2426	2,092.5488	200
Slice 27	650.25	1,986.8964	0	2,783.6383	1,807.7159	200
Slice 28	668.75	1,998.7377	0	1,929.8348	1,253.2494	200
Slice 29	684.35225	2,009.2206	0	1,104.3814	717.19365	200
Slice 30	697.05676	2,018.1795	0	317.64309	206.27984	200

Section 11-11 Static Final with 250' keyway SSA for Skyline Ranch.gsz

Section 11-11 Static Final with 250' keyway SSA for Skyline Ranch.gsz Run By: Dr. Alexander Bykovtsev, Ph.D., P.E. 3/20/2016 5:11:13 PM

- Materials**
- Qls
 - TQs 150-17° bedding 17-23°
 - Fill
 - TQs 150-11° bedding 11-15°
 - TQs 150-17° bedding 5-15°

Key parameters
 Slope 2H:1V
 Depth- 25'
 Width-260'

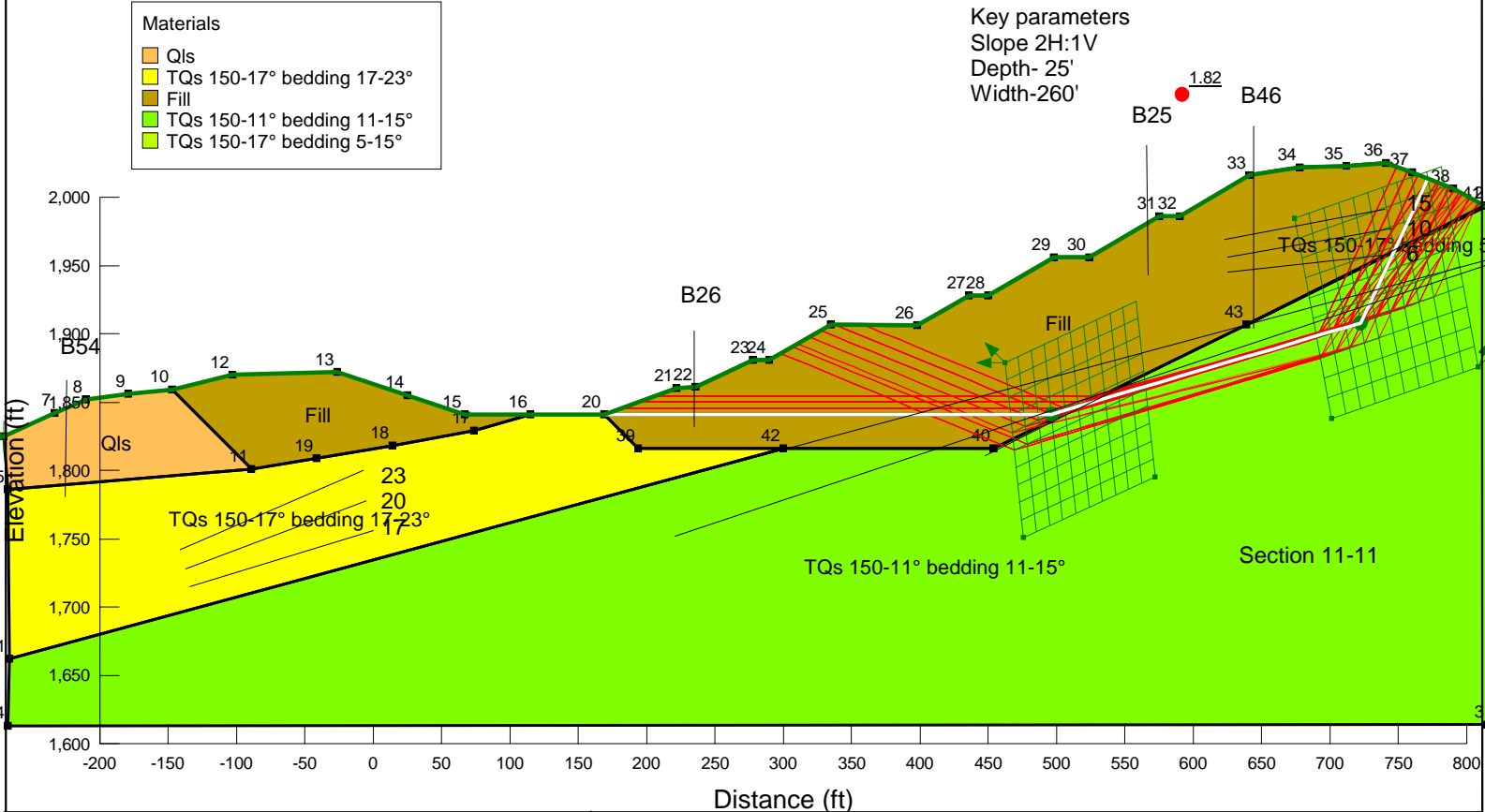

- Name: Qls
 Model: Mohr-Coulomb
 Unit Weight: 100 pcf
 Cohesion: 0 psf
 Phi: 20 °
- Name: TQs 150-17° bedding 17-23°
 Model: Anisotropic Fn.
 Unit Weight: 120 pcf
 Cohesion: 225 psf
 Phi: 40 °
 Phi-Anisotropic Strength Fn.: TQs 150-17° bedding 17-23°
 C-Anisotropic Strength Fn.: 150pcf-17° bedding 17-23°
- Name: Fill
 Model: Mohr-Coulomb
 Unit Weight: 120 pcf
 Cohesion: 200 psf
 Phi: 33 °
- Name: TQs 150-11° bedding 11-15°
 Model: Anisotropic Fn.
 Unit Weight: 120 pcf
 Cohesion: 225 psf
 Phi: 40 °
 Phi-Anisotropic Strength Fn.: TQs 150-11° bedding 11-15°
 C-Anisotropic Strength Fn.: 150pcf-11° bedding 11-15°
- Name: TQs 150-17° bedding 5-15°
 Model: Anisotropic Fn.
 Unit Weight: 120 pcf
 Cohesion: 225 psf
 Phi: 40 °
 Phi-Anisotropic Strength Fn.: TQs 150-17° bedding 5-15°
 C-Anisotropic Strength Fn.: 150pcf-17° bedding 11-15°

LGC **LGC Valley, Inc**
 GEOTECHNICAL CONSULTING
 28532 Constellation Road, Valencia, CA 91355
 Phone 661-702-8474, Fax 661-702-8475

Skyline Ranch
 Development project, Tract 60922
 Los Angeles CA

Project No: **153035-01**
 Engineer: **BAS**
 Date: **March 2016**

2 - Translational

Report generated using GeoStudio 2012. Copyright © 1991-2015 GEO-SLOPE International Ltd.

File Information

File Version: 8.15
 Title: Static Slope Stability Analyses for Skyline Ranch Development project, Tract 60922, Los Angeles CA
 Comments: Run By: Dr. Alexander Bykovtsev, Ph.D., P.E.
 Last Edited By: Alexander Bykovtsev
 Revision Number: 134
 Date: 3/20/2016
 Time: 5:11:13 PM
 Tool Version: 8.15.1.11236
 File Name: Section 11-11 Static Final with 250' keyway SSA for Skyline Ranch.gsz
 Directory: C:\Users\Alexander\Desktop\LGC valley\original sections\
 Last Solved Date: 3/20/2016
 Last Solved Time: 5:11:28 PM

Project Settings

Length(L) Units: Feet
 Time(t) Units: Seconds
 Force(F) Units: Pounds
 Pressure(p) Units: psf
 Strength Units: psf
 Unit Weight of Water: 62.4 pcf
 View: 2D
 Element Thickness: 1

Analysis Settings

2 - Translational

Kind: SLOPE/W
 Method: Janbu
 Settings
 PWP Conditions Source: (none)
 Slip Surface
 Direction of movement: Right to Left
 Use Passive Mode: No
 Slip Surface Option: Block
 Critical slip surfaces saved: 10
 Resisting Side Maximum Convex Angle: 1 °
 Driving Side Maximum Convex Angle: 5 °
 Restrict Block Crossing: No
 Optimize Critical Slip Surface Location: No
 Tension Crack
 Tension Crack Option: (none)
 F of S Distribution
 F of S Calculation Option: Constant
 Advanced

Number of Slices: 30
 F of S Tolerance: 0.01
 Minimum Slip Surface Depth: 0.1 ft

Materials

Q1s

Model: Mohr-Coulomb
 Unit Weight: 100 pcf
 Cohesion': 0 psf
 Phi': 20 °
 Phi-B: 0 °

TQs 150-17° bedding 17-23°

Model: Anisotropic Fn.
 Unit Weight: 120 pcf
 Cohesion': 225 psf
 Phi': 40 °
 Phi-Anisotropic Strength Fn.: TQs 150-17° bedding 17-23°
 C-Anisotropic Strength Fn.: 150pcf-17° bedding 17-23°
 Phi-B: 0 °

Fill

Model: Mohr-Coulomb
 Unit Weight: 120 pcf
 Cohesion': 200 psf
 Phi': 33 °
 Phi-B: 0 °

TQs 150-11° bedding 11-15°

Model: Anisotropic Fn.
 Unit Weight: 120 pcf
 Cohesion': 225 psf
 Phi': 40 °
 Phi-Anisotropic Strength Fn.: TQs 150-11° bedding 11-15°
 C-Anisotropic Strength Fn.: 150pcf-11° bedding 11-15°
 Phi-B: 0 °

TQs 150-17° bedding 5-15°

Model: Anisotropic Fn.
 Unit Weight: 120 pcf
 Cohesion': 225 psf
 Phi': 40 °
 Phi-Anisotropic Strength Fn.: TQs 150-17° bedding 5-15°
 C-Anisotropic Strength Fn.: 150pcf-17° bedding 11-15°
 Phi-B: 0 °

Slip Surface Limits

Left Coordinate: (-270, 1,825) ft
 Right Coordinate: (815, 1,994) ft

Slip Surface Block

Left Grid

Upper Left: (462.0176, 1,878.9172) ft
 Lower Left: (475.6569, 1,750.9259) ft
 Lower Right: (571.9684, 1,795.6298) ft
 X Increments: 10
 Y Increments: 10
 Starting Angle: 135 °
 Ending Angle: 180 °
 Angle Increments: 2

Right Grid

Upper Left: (674.1719, 1,984.603) ft
 Lower Left: (701.0288, 1,838.0786) ft
 Lower Right: (808.478, 1,875.8575) ft
 X Increments: 10
 Y Increments: 10
 Starting Angle: 45 °
 Ending Angle: 65 °
 Angle Increments: 2

Seismic Coefficients

Horz Seismic Coef.: 0
 Vert Seismic Coef.: 0

Anisotropic Strength Functions

TQs 150-17° bedding 17-23°

Model: Spline Data Point Function
 Function: Modifier Factor vs. Inclination
 Curve Fit to Data: 100 %
 Segment Curvature: 0 %
 Y-Intercept: 1
 Data Points: Inclination (°), Modifier Factor
 Data Point: (-90, 1)
 Data Point: (16.9, 1)
 Data Point: (17, 0.425)
 Data Point: (23, 0.425)
 Data Point: (23.1, 1)

150pcf-17° bedding 17-23°

Model: Spline Data Point Function
 Function: Modifier Factor vs. Inclination
 Curve Fit to Data: 100 %
 Segment Curvature: 0 %
 Y-Intercept: 1
 Data Points: Inclination (°), Modifier Factor
 Data Point: (-90, 1)
 Data Point: (16.9, 1)
 Data Point: (17, 0.667)
 Data Point: (23, 0.667)
 Data Point: (23.1, 1)

TQs 150-17° bedding 5-15°

Model: Spline Data Point Function
 Function: Modifier Factor vs. Inclination
 Curve Fit to Data: 100 %
 Segment Curvature: 0 %
 Y-Intercept: 1
 Data Points: Inclination (°), Modifier Factor
 Data Point: (-90, 1)
 Data Point: (4.9, 1)
 Data Point: (5, 0.425)
 Data Point: (15, 0.425)
 Data Point: (15.1, 1)

150pcf-17° bedding 11-15°

Model: Spline Data Point Function
 Function: Modifier Factor vs. Inclination
 Curve Fit to Data: 100 %
 Segment Curvature: 0 %
 Y-Intercept: 1
 Data Points: Inclination (°), Modifier Factor
 Data Point: (-90, 1)
 Data Point: (4.9, 1)
 Data Point: (5, 0.667)
 Data Point: (15, 0.667)
 Data Point: (15.1, 1)

TQs 150-11° bedding 11-15°

Model: Spline Data Point Function
 Function: Modifier Factor vs. Inclination
 Curve Fit to Data: 100 %
 Segment Curvature: 0 %
 Y-Intercept: 1
 Data Points: Inclination (°), Modifier Factor
 Data Point: (-90, 1)
 Data Point: (10.9, 1)
 Data Point: (11, 0.275)
 Data Point: (17, 0.275)
 Data Point: (17.1, 1)

150pcf-11° bedding 11-15°

Model: Spline Data Point Function
 Function: Modifier Factor vs. Inclination
 Curve Fit to Data: 100 %
 Segment Curvature: 0 %
 Y-Intercept: 1
 Data Points: Inclination (°), Modifier Factor
 Data Point: (-90, 1)
 Data Point: (10.9, 1)
 Data Point: (11, 0.667)
 Data Point: (15, 0.667)
 Data Point: (15.1, 1)

Points

	X (ft)	Y (ft)
Point 1	-266	1,662
Point 2	815	1,994
Point 3	815	1,614
Point 4	-267	1,613
Point 5	-267	1,786
Point 6	-270	1,825
Point 7	-233	1,842
Point 8	-210	1,852
Point 9	-179	1,856
Point 10	-147	1,859
Point 11	-89	1,801
Point 12	-103	1,870
Point 13	-26	1,872
Point 14	25	1,855
Point 15	67	1,841
Point 16	115	1,841
Point 17	74	1,829
Point 18	14	1,818
Point 19	-41	1,809
Point 20	169	1,841
Point 21	222	1,860
Point 22	236	1,861
Point 23	278	1,881
Point 24	290	1,881
	335	1,907

Point 25		
Point 26	398	1,906
Point 27	436	1,928
Point 28	450	1,928
Point 29	498	1,956
Point 30	524	1,956
Point 31	575	1,986
Point 32	590	1,986
Point 33	641	2,016
Point 34	678	2,022
Point 35	712	2,023
Point 36	741	2,025
Point 37	760	2,018
Point 38	790	2,006
Point 39	194	1,816
Point 40	454	1,816
Point 41	813	1,994
Point 42	300	1,816
Point 43	639	1,907

Regions

	Material	Points	Area (ft²)
Region 1	TQs 150-11° bedding 11-15°	1,4,3,2,43,40,42	2.0743e+005
Region 2	Qls	5,6,7,8,9,10,11	8,715
Region 3	Fill	10,12,13,14,15,16,17,18,19,11	9,960
		16,17,18,19,11,5,1,42,39,20	41,895

Region 4	TQs 150-17° bedding 17-23°		
Region 5	TQs 150-17° bedding 5-15°	2,41,43	87
Region 6	Fill	20,39,42,40,43,41,38,37,36,35,34,33,32,31,30,29,28,27,26,25,24,23,22,21	52,185

Current Slip Surface

Slip Surface: 76,011
 F of S: 1.82
 Volume: 47,947.893 ft³
 Weight: 5,753,747.1 lbs
 Resisting Force: 2,380,689.2 lbs
 Activating Force: 1,311,665.4 lbs
 F of S Rank (Analysis): 1 of 131,769 slip surfaces
 F of S Rank (Query): 1 of 100 slip surfaces
 Exit: (169.36779, 1,841.1319) ft
 Entry: (771.6343, 2,013.3463) ft
 Radius: 300.00207 ft
 Center: (433.5683, 2,056.3999) ft

Slip Slices

	X (ft)	Y (ft)	PWP (psf)	Base Normal Stress (psf)	Frictional Strength (psf)	Cohesive Strength (psf)
Slice 1	178.13983	1,841.1319	0	377.363	245.0624	200
Slice 2	195.6839	1,841.1319	0	1,132.089	735.18719	200
Slice 3	213.22797	1,841.1319	0	1,886.815	1,225.312	200
Slice 4	229	1,841.1319	0	2,324.178	1,509.3388	200
Slice 5	246.5	1,841.1319	0	2,984.178	1,937.9479	200
Slice 6	267.5	1,841.1319	0	4,184.178	2,717.237	200
Slice 7	284	1,841.1319	0	4,784.178	3,106.8815	200
Slice 8	301.25	1,841.1319	0	5,564.178	3,613.4194	200
Slice 9	323.75	1,841.1319	0	7,124.178	4,626.4953	200
Slice 10	345.5	1,841.1319	0	7,884.178	5,120.0451	200
Slice 11	366.5	1,841.1319	0	7,844.178	5,094.0688	200
Slice 12	387.5	1,841.1319	0	7,804.178	5,068.0925	200
Slice 13	407.5	1,841.1319	0	8,444.178	5,483.7133	200
Slice 14	426.5	1,841.1319	0	9,764.178	6,340.9313	200
Slice 15	443	1,841.1319	0	10,424.178	6,769.5403	200
	461.59169	1,841.1319	0	11,235.596	7,296.4817	200

Slice 16						
Slice 17	484.77508	1,841.1319	0	12,858.433	8,350.3643	200
Slice 18	497.18338	1,841.3734	0	12,359.615	8,026.4281	200
Slice 19	508.12566	1,844.6098	0	12,060.058	7,831.8931	200
Slice 20	521.12566	1,848.4549	0	12,474.31	2,424.7602	225
Slice 21	532.5	1,851.8191	0	12,664.586	2,461.7461	225
Slice 22	549.5	1,856.8472	0	13,242.92	2,574.1628	225
Slice 23	566.5	1,861.8753	0	13,821.254	2,686.5795	225
Slice 24	582.5	1,866.6077	0	13,852.385	2,692.631	225
Slice 25	602.25	1,872.4492	0	14,011.091	2,723.4802	225
Slice 26	626.75	1,879.6956	0	14,844.572	2,885.4925	225
Slice 27	640	1,883.6146	0	15,295.332	2,973.1115	225
Slice 28	650.25	1,886.6463	0	15,185.591	2,951.7799	225
Slice 29	668.75	1,892.1181	0	14,898.069	2,895.8912	225
Slice 30	686.5	1,897.3681	0	14,490.948	2,816.755	225
Slice 31	703.5	1,902.3962	0	13,964.229	2,714.3712	225
Slice 32	717.2604	1,906.4661	0	13,562.087	2,636.2027	225
Slice 33	731.7604	1,927.8364	0	5,687.7821	4,772.6159	225
Slice 34	743.96016	1,953.9989	0	4,082.6731	3,425.7695	225
Slice 35	753.46016	1,974.3717	0	2,994.5629	1,944.6919	200
Slice 36	765.81715	2,000.8714	0	872.1564	566.38499	200

Section 11-11 Seismic Final with 250' keyway SSA for Skyline Ranch.gsz

Section 11-11 Seismic Final with 250' keyway SSA for Skyline Ranch.gsz Run By: Dr. Alexander Bykovtsev, Ph.D., P.E. 3/20/2016 5:04:15 PM

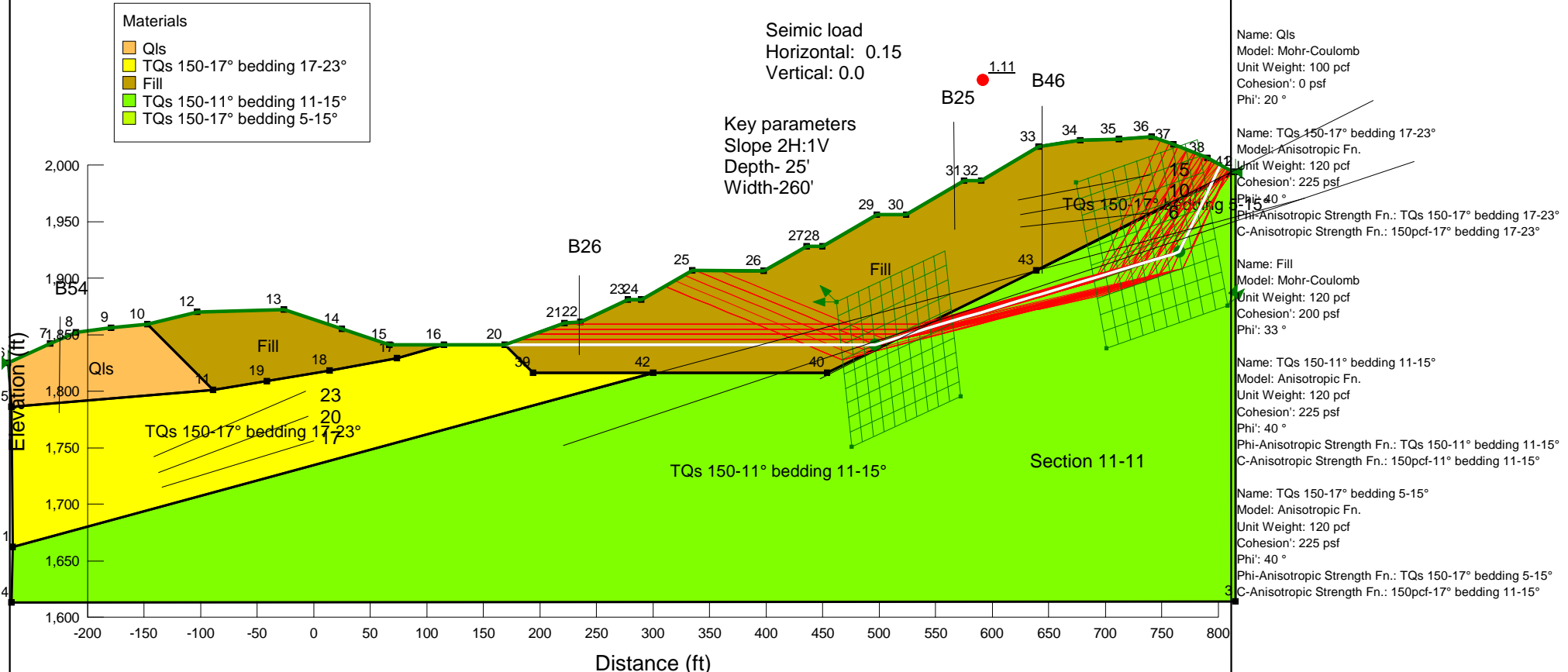

LGC **LGC Valley, Inc**
 GEOTECHNICAL CONSULTING
 28532 Constellation Road, Valencia, CA 91355
 Phone 661-702-8474, Fax 661-702-8475

Skyline Ranch
 Development project, Tract 60922
 Los Angeles CA

Project No: **153035-01**
 Engineer: **BAS**
 Date: **March 2016**

2 - Translational

Report generated using GeoStudio 2012. Copyright © 1991-2015 GEO-SLOPE International Ltd.

File Information

File Version: 8.15
 Title: Static Slope Stability Analyses for Skyline Ranch Development project, Tract 60922, Los Angeles CA
 Comments: Run By: Dr. Alexander Bykovtsev, Ph.D., P.E.
 Last Edited By: Alexander Bykovtsev
 Revision Number: 132
 Date: 3/20/2016
 Time: 5:04:15 PM
 Tool Version: 8.15.1.11236
 File Name: Section 11-11 Seismic Final with 250' keyway SSA for Skyline Ranch.gsz
 Directory: C:\Users\Alexander\Desktop\LGC valley\original sections\
 Last Solved Date: 3/20/2016
 Last Solved Time: 5:04:30 PM

Project Settings

Length(L) Units: Feet
 Time(t) Units: Seconds
 Force(F) Units: Pounds
 Pressure(p) Units: psf
 Strength Units: psf
 Unit Weight of Water: 62.4 pcf
 View: 2D
 Element Thickness: 1

Analysis Settings

2 - Translational

Kind: SLOPE/W
 Method: Janbu
 Settings
 PWP Conditions Source: (none)
 Slip Surface
 Direction of movement: Right to Left
 Use Passive Mode: No
 Slip Surface Option: Block
 Critical slip surfaces saved: 10
 Resisting Side Maximum Convex Angle: 1 °
 Driving Side Maximum Convex Angle: 5 °
 Restrict Block Crossing: No
 Optimize Critical Slip Surface Location: No
 Tension Crack
 Tension Crack Option: (none)
 F of S Distribution
 F of S Calculation Option: Constant
 Advanced

Number of Slices: 30
 F of S Tolerance: 0.01
 Minimum Slip Surface Depth: 0.1 ft

Materials

QIs

Model: Mohr-Coulomb
 Unit Weight: 100 pcf
 Cohesion': 0 psf
 Phi': 20 °
 Phi-B: 0 °

TQs 150-17° bedding 17-23°

Model: Anisotropic Fn.
 Unit Weight: 120 pcf
 Cohesion': 225 psf
 Phi': 40 °
 Phi-Anisotropic Strength Fn.: TQs 150-17° bedding 17-23°
 C-Anisotropic Strength Fn.: 150pcf-17° bedding 17-23°
 Phi-B: 0 °

Fill

Model: Mohr-Coulomb
 Unit Weight: 120 pcf
 Cohesion': 200 psf
 Phi': 33 °
 Phi-B: 0 °

TQs 150-11° bedding 11-15°

Model: Anisotropic Fn.
 Unit Weight: 120 pcf
 Cohesion': 225 psf
 Phi': 40 °
 Phi-Anisotropic Strength Fn.: TQs 150-11° bedding 11-15°
 C-Anisotropic Strength Fn.: 150pcf-11° bedding 11-15°
 Phi-B: 0 °

TQs 150-17° bedding 5-15°

Model: Anisotropic Fn.
 Unit Weight: 120 pcf
 Cohesion': 225 psf
 Phi': 40 °
 Phi-Anisotropic Strength Fn.: TQs 150-17° bedding 5-15°
 C-Anisotropic Strength Fn.: 150pcf-17° bedding 11-15°
 Phi-B: 0 °

Slip Surface Limits

Left Coordinate: (-270, 1,825) ft
 Right Coordinate: (815, 1,994) ft

Slip Surface Block

Left Grid

Upper Left: (462.0176, 1,878.9172) ft
 Lower Left: (475.6569, 1,750.9259) ft
 Lower Right: (571.9684, 1,795.6298) ft
 X Increments: 10
 Y Increments: 10
 Starting Angle: 135 °
 Ending Angle: 180 °
 Angle Increments: 2

Right Grid

Upper Left: (674.1719, 1,984.603) ft
 Lower Left: (701.0288, 1,838.0786) ft
 Lower Right: (808.478, 1,875.8575) ft
 X Increments: 10
 Y Increments: 10
 Starting Angle: 45 °
 Ending Angle: 65 °
 Angle Increments: 2

Seismic Coefficients

Horz Seismic Coef.: 0.15
 Vert Seismic Coef.: 0

Anisotropic Strength Functions**TQs 150-17° bedding 17-23°**

Model: Spline Data Point Function
 Function: Modifier Factor vs. Inclination
 Curve Fit to Data: 100 %
 Segment Curvature: 0 %
 Y-Intercept: 1
 Data Points: Inclination (°), Modifier Factor
 Data Point: (-90, 1)
 Data Point: (16.9, 1)
 Data Point: (17, 0.425)
 Data Point: (23, 0.425)
 Data Point: (23.1, 1)

150pcf-17° bedding 17-23°

Model: Spline Data Point Function
 Function: Modifier Factor vs. Inclination
 Curve Fit to Data: 100 %
 Segment Curvature: 0 %
 Y-Intercept: 1
 Data Points: Inclination (°), Modifier Factor
 Data Point: (-90, 1)
 Data Point: (16.9, 1)
 Data Point: (17, 0.667)
 Data Point: (23, 0.667)
 Data Point: (23.1, 1)

TQs 150-17° bedding 5-15°

Model: Spline Data Point Function
 Function: Modifier Factor vs. Inclination
 Curve Fit to Data: 100 %
 Segment Curvature: 0 %
 Y-Intercept: 1
 Data Points: Inclination (°), Modifier Factor
 Data Point: (-90, 1)
 Data Point: (4.9, 1)
 Data Point: (5, 0.425)
 Data Point: (15, 0.425)
 Data Point: (15.1, 1)

150pcf-17° bedding 11-15°

Model: Spline Data Point Function
 Function: Modifier Factor vs. Inclination
 Curve Fit to Data: 100 %
 Segment Curvature: 0 %
 Y-Intercept: 1
 Data Points: Inclination (°), Modifier Factor
 Data Point: (-90, 1)
 Data Point: (4.9, 1)
 Data Point: (5, 0.667)
 Data Point: (15, 0.667)
 Data Point: (15.1, 1)

TQs 150-11° bedding 11-15°

Model: Spline Data Point Function
 Function: Modifier Factor vs. Inclination
 Curve Fit to Data: 100 %
 Segment Curvature: 0 %
 Y-Intercept: 1
 Data Points: Inclination (°), Modifier Factor
 Data Point: (-90, 1)
 Data Point: (10.9, 1)
 Data Point: (11, 0.275)
 Data Point: (17, 0.275)
 Data Point: (17.1, 1)

150pcf-11° bedding 11-15°

Model: Spline Data Point Function
 Function: Modifier Factor vs. Inclination
 Curve Fit to Data: 100 %
 Segment Curvature: 0 %
 Y-Intercept: 1
 Data Points: Inclination (°), Modifier Factor
 Data Point: (-90, 1)
 Data Point: (10.9, 1)
 Data Point: (11, 0.667)
 Data Point: (15, 0.667)
 Data Point: (15.1, 1)

Points

	X (ft)	Y (ft)
Point 1	-266	1,662
Point 2	815	1,994
Point 3	815	1,614
Point 4	-267	1,613
Point 5	-267	1,786
Point 6	-270	1,825
Point 7	-233	1,842
Point 8	-210	1,852
Point 9	-179	1,856
Point 10	-147	1,859
Point 11	-89	1,801
Point 12	-103	1,870
Point 13	-26	1,872
Point 14	25	1,855
Point 15	67	1,841
Point 16	115	1,841
Point 17	74	1,829
Point 18	14	1,818
Point 19	-41	1,809
Point 20	169	1,841
Point 21	222	1,860
Point 22	236	1,861
Point 23	278	1,881
Point 24	290	1,881
	335	1,907

Point 25		
Point 26	398	1,906
Point 27	436	1,928
Point 28	450	1,928
Point 29	498	1,956
Point 30	524	1,956
Point 31	575	1,986
Point 32	590	1,986
Point 33	641	2,016
Point 34	678	2,022
Point 35	712	2,023
Point 36	741	2,025
Point 37	760	2,018
Point 38	790	2,006
Point 39	194	1,816
Point 40	454	1,816
Point 41	813	1,994
Point 42	300	1,816
Point 43	639	1,907

Regions

	Material	Points	Area (ft²)
Region 1	TQs 150-11° bedding 11-15°	1,4,3,2,43,40,42	2.0743e+005
Region 2	Qls	5,6,7,8,9,10,11	8,715
Region 3	Fill	10,12,13,14,15,16,17,18,19,11	9,960
		16,17,18,19,11,5,1,42,39,20	41,895

Region 4	TQs 150-17° bedding 17-23°		
Region 5	TQs 150-17° bedding 5-15°	2,41,43	87
Region 6	Fill	20,39,42,40,43,41,38,37,36,35,34,33,32,31,30,29,28,27,26,25,24,23,22,21	52,185

Current Slip Surface

Slip Surface: 76,023
 F of S: 1.11
 Volume: 50,963.807 ft³
 Weight: 6,115,656.9 lbs
 Resisting Force: 2,382,251.1 lbs
 Activating Force: 2,149,311.8 lbs
 F of S Rank (Analysis): 1 of 131,769 slip surfaces
 F of S Rank (Query): 1 of 100 slip surfaces
 Exit: (169.36779, 1,841.1319) ft
 Entry: (801.37443, 2,000.0655) ft
 Radius: 299.14077 ft
 Center: (455.39526, 2,039.7989) ft

Slip Slices

	X (ft)	Y (ft)	PWP (psf)	Base Normal Stress (psf)	Frictional Strength (psf)	Cohesive Strength (psf)
Slice 1	182.52584	1,841.1319	0	566.0445	367.5936	200
Slice 2	208.84195	1,841.1319	0	1,698.1335	1,102.7808	200
Slice 3	229	1,841.1319	0	2,324.178	1,509.3388	200
Slice 4	246.5	1,841.1319	0	2,984.178	1,937.9479	200
Slice 5	267.5	1,841.1319	0	4,184.178	2,717.237	200
Slice 6	284	1,841.1319	0	4,784.178	3,106.8815	200
Slice 7	301.25	1,841.1319	0	5,564.178	3,613.4194	200
Slice 8	323.75	1,841.1319	0	7,124.178	4,626.4953	200
Slice 9	345.5	1,841.1319	0	7,884.178	5,120.0451	200
Slice 10	366.5	1,841.1319	0	7,844.178	5,094.0688	200
Slice 11	387.5	1,841.1319	0	7,804.178	5,068.0925	200
Slice 12	407.5	1,841.1319	0	8,444.178	5,483.7133	200
Slice 13	426.5	1,841.1319	0	9,764.178	6,340.9313	200
Slice 14	443	1,841.1319	0	10,424.178	6,769.5403	200
Slice 15	461.59169	1,841.1319	0	11,235.596	7,296.4817	200
	484.77508	1,841.1319	0	12,858.433	8,350.3643	200

Slice 16						
Slice 17	497.18338	1,841.3807	0	11,562.202	7,508.5817	200
Slice 18	508.64675	1,844.8734	0	11,255.414	7,309.3512	200
Slice 19	521.64675	1,848.8344	0	12,143.798	2,360.5152	225
Slice 20	536.75	1,853.4361	0	12,473.818	2,424.6647	225
Slice 21	562.25	1,861.2057	0	13,297.15	2,584.7041	225
Slice 22	582.5	1,867.3756	0	13,448.605	2,614.144	225
Slice 23	602.25	1,873.3932	0	13,583.916	2,640.4459	225
Slice 24	626.75	1,880.858	0	14,374.96	2,794.2092	225
Slice 25	640	1,884.8951	0	14,802.77	2,877.3669	225
Slice 26	650.25	1,888.0182	0	14,684.936	2,854.4623	225
Slice 27	668.75	1,893.6549	0	14,384.692	2,796.101	225
Slice 28	686.5	1,899.0631	0	13,968.133	2,715.13	225
Slice 29	703.5	1,904.2428	0	13,435.258	2,611.5495	225
Slice 30	726.5	1,911.2506	0	12,779.616	2,484.1057	225
Slice 31	750.5	1,918.5631	0	11,662.268	2,266.9153	225
Slice 32	762.75024	1,922.2956	0	10,713.437	2,082.4813	225
Slice 33	777.75024	1,949.4033	0	2,633.4659	2,209.7403	225
Slice 34	791.8086	1,979.5515	0	994.79949	834.73589	225
Slice 35	793.88431	1,984.0029	0	742.82708	623.30593	225
Slice 36	797.76292	1,992.3206	0	337.8916	219.42937	200

Section 12-12 Static Final with keyway SSA for Skyline Ranch.gsz

Section 12-12 Static Final with keyway SSA for Skyline Ranch.gsz Run By: Dr. Alexander Bykovtsev, Ph.D., P.E. 3/20/2016 1:48:15 PM

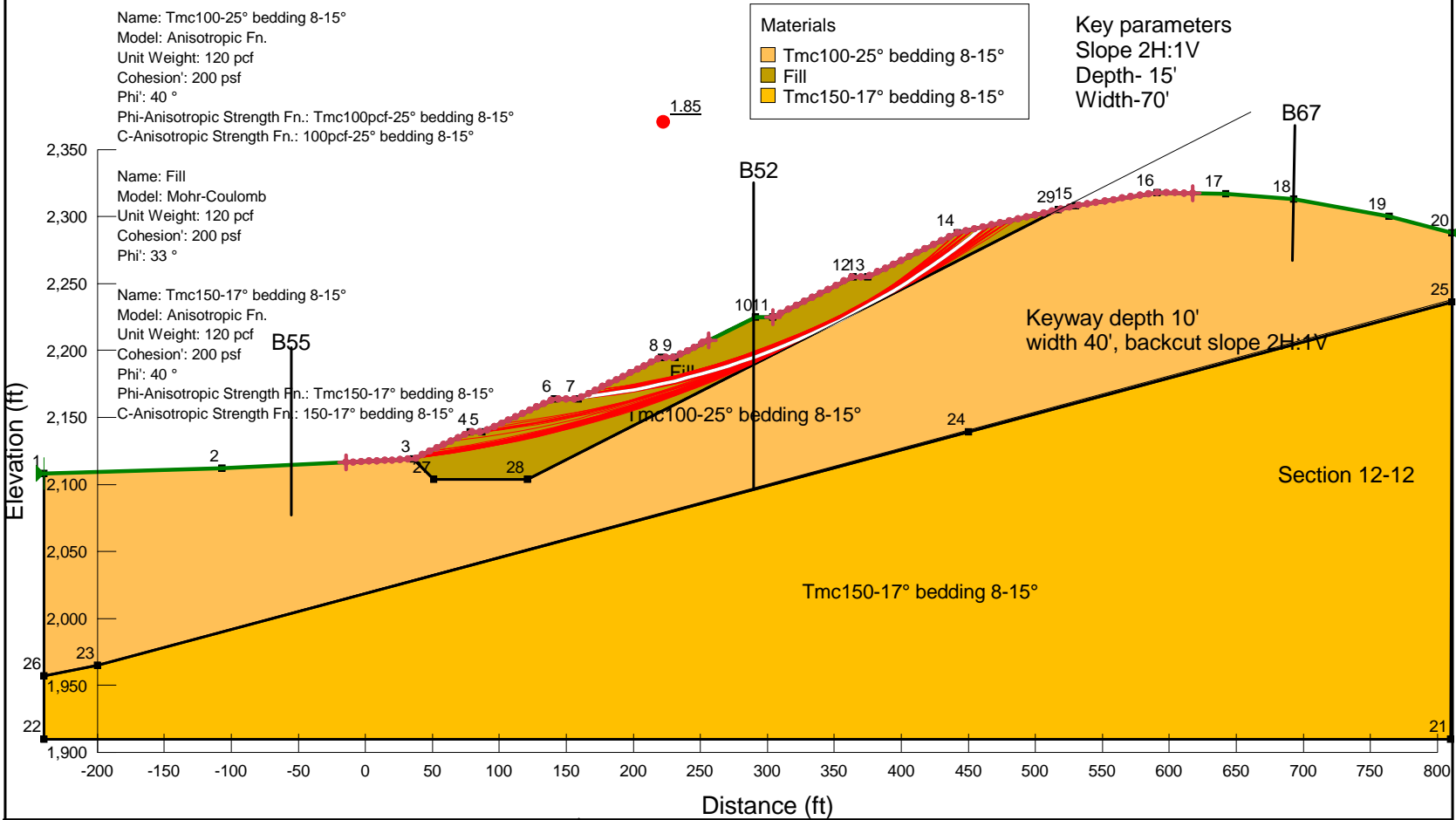

	<p>LGC Valley, Inc GEOTECHNICAL CONSULTING 28532 Constellation Road, Valencia, CA 91355 Phone 661-702-8474, Fax 661-702-8475</p>	<p>Skyline Ranch Development project, Tract 60922 Los Angeles CA</p>	<p>Project No: 153035-01 Engineer: BAS Date: March 2016</p>
---	---	---	---

1 - Circular Mode of Failure

Report generated using GeoStudio 2012. Copyright © 1991-2015 GEO-SLOPE International Ltd.

File Information

File Version: 8.15
 Title: Static Slope Stability Analyses for Skyline Ranch Development project, Tract 60922, Los Angeles CA
 Comments: Run By: Dr. Alexander Bykovtsev, Ph.D., P.E.
 Last Edited By: Alexander Bykovtsev
 Revision Number: 118
 Date: 3/20/2016
 Time: 1:48:15 PM
 Tool Version: 8.15.1.11236
 File Name: Section 12-12 Static Final with keyway SSA for Skyline Ranch.gsz
 Directory: C:\Users\Alexander\Desktop\LGC valley\original sections\Final Results for Section 12\
 Last Solved Date: 3/20/2016
 Last Solved Time: 1:50:30 PM

Project Settings

Length(L) Units: Feet
 Time(t) Units: Seconds
 Force(F) Units: Pounds
 Pressure(p) Units: psf
 Strength Units: psf
 Unit Weight of Water: 62.4 pcf
 View: 2D
 Element Thickness: 1

Analysis Settings

1 - Circular Mode of Failure

Kind: [SLOPE/W](#)
 Method: [Bishop](#)
 Settings
 PWP Conditions Source: [\(none\)](#)
 Slip Surface
 Direction of movement: [Right to Left](#)
 Use Passive Mode: [No](#)
 Slip Surface Option: [Entry and Exit](#)
 Critical slip surfaces saved: [10](#)
 Resisting Side Maximum Convex Angle: [1 °](#)
 Driving Side Maximum Convex Angle: [5 °](#)
 Optimize Critical Slip Surface Location: [No](#)
 Tension Crack
 Tension Crack Option: [\(none\)](#)

F of S Distribution
 F of S Calculation Option: [Constant](#)
 Advanced
 Number of Slices: [30](#)
 F of S Tolerance: [0.01](#)
 Minimum Slip Surface Depth: [0.1 ft](#)

Materials

Tmc100-25° bedding 8-15°

Model: [Anisotropic Fn.](#)
 Unit Weight: [120 pcf](#)
 Cohesion': [200 psf](#)
 Phi': [40 °](#)
 Phi-Anisotropic Strength Fn.: [Tmc100pcf-25° bedding 8-15°](#)
 C-Anisotropic Strength Fn.: [100pcf-25° bedding 8-15°](#)
 Phi-B: [0 °](#)

Fill

Model: [Mohr-Coulomb](#)
 Unit Weight: [120 pcf](#)
 Cohesion': [200 psf](#)
 Phi': [33 °](#)
 Phi-B: [0 °](#)

Tmc150-17° bedding 8-15°

Model: [Anisotropic Fn.](#)
 Unit Weight: [120 pcf](#)
 Cohesion': [200 psf](#)
 Phi': [40 °](#)
 Phi-Anisotropic Strength Fn.: [Tmc150-17° bedding 8-15°](#)
 C-Anisotropic Strength Fn.: [150-17° bedding 8-15°](#)
 Phi-B: [0 °](#)

Slip Surface Entry and Exit

Left Projection: [Range](#)
 Left-Zone Left Coordinate: [\(-14.6024, 2,116.523\) ft](#)
 Left-Zone Right Coordinate: [\(256.0584, 2,207.5292\) ft](#)
 Left-Zone Increment: [50](#)
 Right Projection: [Range](#)
 Right-Zone Left Coordinate: [\(304, 2,225\) ft](#)
 Right-Zone Right Coordinate: [\(617.5728, 2,317.479\) ft](#)
 Right-Zone Increment: [50](#)
 Radius Increments: [50](#)

Slip Surface Limits

Left Coordinate: (-240, 2,108) ft
 Right Coordinate: (811, 2,288) ft

Seismic Coefficients

Horz Seismic Coef.: 0
 Vert Seismic Coef.: 0

Anisotropic Strength Functions

150-17° bedding 8-15°

Model: Spline Data Point Function
 Function: Modifier Factor vs. Inclination
 Curve Fit to Data: 100 %
 Segment Curvature: 0 %
 Y-Intercept: 1
 Data Points: Inclination (°), Modifier Factor
 Data Point: (-90, 1)
 Data Point: (7.9, 1)
 Data Point: (8, 0.75)
 Data Point: (15, 0.75)
 Data Point: (15.1, 1)

100pcf-25° bedding 8-15°

Model: Spline Data Point Function
 Function: Modifier Factor vs. Inclination
 Curve Fit to Data: 100 %
 Segment Curvature: 0 %
 Y-Intercept: 1
 Data Points: Inclination (°), Modifier Factor
 Data Point: (-90, 1)
 Data Point: (7.9, 1)
 Data Point: (8, 0.5)
 Data Point: (15, 0.5)
 Data Point: (15.1, 1)

Tmc150-17° bedding 8-15°

Model: Spline Data Point Function
 Function: Modifier Factor vs. Inclination
 Curve Fit to Data: 100 %
 Segment Curvature: 0 %
 Y-Intercept: 1
 Data Points: Inclination (°), Modifier Factor
 Data Point: (-90, 1)
 Data Point: (7.9, 1)
 Data Point: (8, 0.425)
 Data Point: (15, 0.425)
 Data Point: (15.1, 1)

Tmc100pcf-25° bedding 8-15°

Model: Spline Data Point Function
 Function: Modifier Factor vs. Inclination
 Curve Fit to Data: 100 %
 Segment Curvature: 0 %
 Y-Intercept: 1
 Data Points: Inclination (°), Modifier Factor
 Data Point: (-90, 1)
 Data Point: (7.9, 1)
 Data Point: (8, 0.625)
 Data Point: (15, 0.625)
 Data Point: (15.1, 1)

Points

	X (ft)	Y (ft)
Point 1	-240	2,108
Point 2	-107	2,112
Point 3	36	2,119
Point 4	78	2,139
Point 5	87	2,139
Point 6	141	2,164
Point 7	159	2,164
Point 8	221	2,195
Point 9	231	2,195
Point 10	291	2,225
Point 11	304	2,225
Point 12	364	2,255
Point 13	375	2,255
Point 14	442	2,288
Point 15	530	2,308
Point 16	591	2,318
Point 17	642	2,317
Point 18	693	2,313
Point 19	764	2,300
Point 20	811	2,288
Point 21	810	1,910
Point 22	-240	1,910
Point 23	-200	1,965
Point 24	450	2,139
Point 25	810.8624	2,236
Point 26	-240	1,957
Point 27	51	2,104
Point 28	121	2,104
Point 29	517	2,305

Regions

	Material	Points	Area (ft ²)
Region 1	Tmc100-25° bedding 8-15°	1,26,23,24,25,20,19,18,17,16,15,29,28,27,3,2	1.1206e+005
Region 2	Tmc150-17° bedding 8-15°	23,26,22,21,25,24	1.9434e+005
Region 3	Fill	3,27,28,29,14,13,12,11,10,9,8,7,6,5,4	14,105

Current Slip Surface

Slip Surface: 74,165
 F of S: 1.85
 Volume: 5,764.7121 ft³
 Weight: 691,765.45 lbs
 Resisting Moment: 2.7811601e+008 lbs-ft
 Activating Moment: 1.5014612e+008 lbs-ft
 F of S Rank (Analysis): 1 of 132,651 slip surfaces
 F of S Rank (Query): 1 of 100 slip surfaces
 Exit: (160.87368, 2,164.9368) ft
 Entry: (461.07827, 2,292.3244) ft
 Radius: 572.22348 ft
 Center: (96.719459, 2,733.5527) ft

Slip Slices

	X (ft)	Y (ft)	PWP (psf)	Base Normal Stress (psf)	Frictional Strength (psf)	Cohesive Strength (psf)
Slice 1	165.8842	2,165.547	0	205.53098	133.47338	200
Slice 2	175.90526	2,166.8572	0	625.78062	406.38669	200
Slice 3	185.92631	2,168.3482	0	1,020.4134	662.66418	200
Slice 4	195.94737	2,170.0212	0	1,389.6628	902.45758	200
Slice 5	205.96842	2,171.8781	0	1,733.7329	1,125.8993	200
Slice 6	215.98947	2,173.9205	0	2,052.799	1,333.1032	200
Slice 7	226	2,176.148	0	2,069.249	1,343.786	200
Slice 8	236	2,178.5625	0	2,064.1304	1,340.4619	200
Slice 9	246	2,181.1685	0	2,311.9497	1,501.3977	200
Slice 10	256	2,183.9689	0	2,535.3026	1,646.4447	200

Slice 11	266	2,186.9665	0	2,734.233	1,775.6317	200
Slice 12	276	2,190.1647	0	2,908.7593	1,888.9704	200
Slice 13	286	2,193.567	0	3,058.8739	1,986.4559	200
Slice 14	297.5	2,197.7554	0	2,854.5432	1,853.762	200
Slice 15	309	2,202.1887	0	2,626.9576	1,705.9662	200
Slice 16	319	2,206.2941	0	2,700.7433	1,753.8832	200
Slice 17	329	2,210.6229	0	2,749.8355	1,785.7641	200
Slice 18	339	2,215.1808	0	2,774.0927	1,801.5169	200
Slice 19	349	2,219.9738	0	2,773.3453	1,801.0315	200
Slice 20	359	2,225.0087	0	2,747.3953	1,784.1794	200
Slice 21	369.5	2,230.5702	0	2,414.7349	1,568.1472	200
Slice 22	379.78571	2,236.2772	0	2,058.1562	1,336.5823	200
Slice 23	389.35714	2,241.8496	0	1,955.1699	1,269.7022	200
Slice 24	398.92857	2,247.6745	0	1,828.2705	1,187.2927	200
Slice 25	408.5	2,253.761	0	1,677.157	1,089.1585	200
Slice 26	418.07143	2,260.1193	0	1,501.5003	975.08571	200
Slice 27	427.64286	2,266.7604	0	1,300.9421	844.84165	200
Slice 28	437.21429	2,273.6967	0	1,075.094	698.17421	200
Slice 29	446.76957	2,280.9289	0	704.25619	457.34932	200
Slice 30	456.30871	2,288.471	0	191.44756	124.3275	200

Section 12-12 Seismic Final with keyway SSA for Skyline Ranch.gsz

Section 12-12 Seismic Final with keyway SSA for Skyline Ranch.gsz Run By: Dr. Alexander Bykovtsev, Ph.D., P.E. 3/20/2016 1:35:46 PM

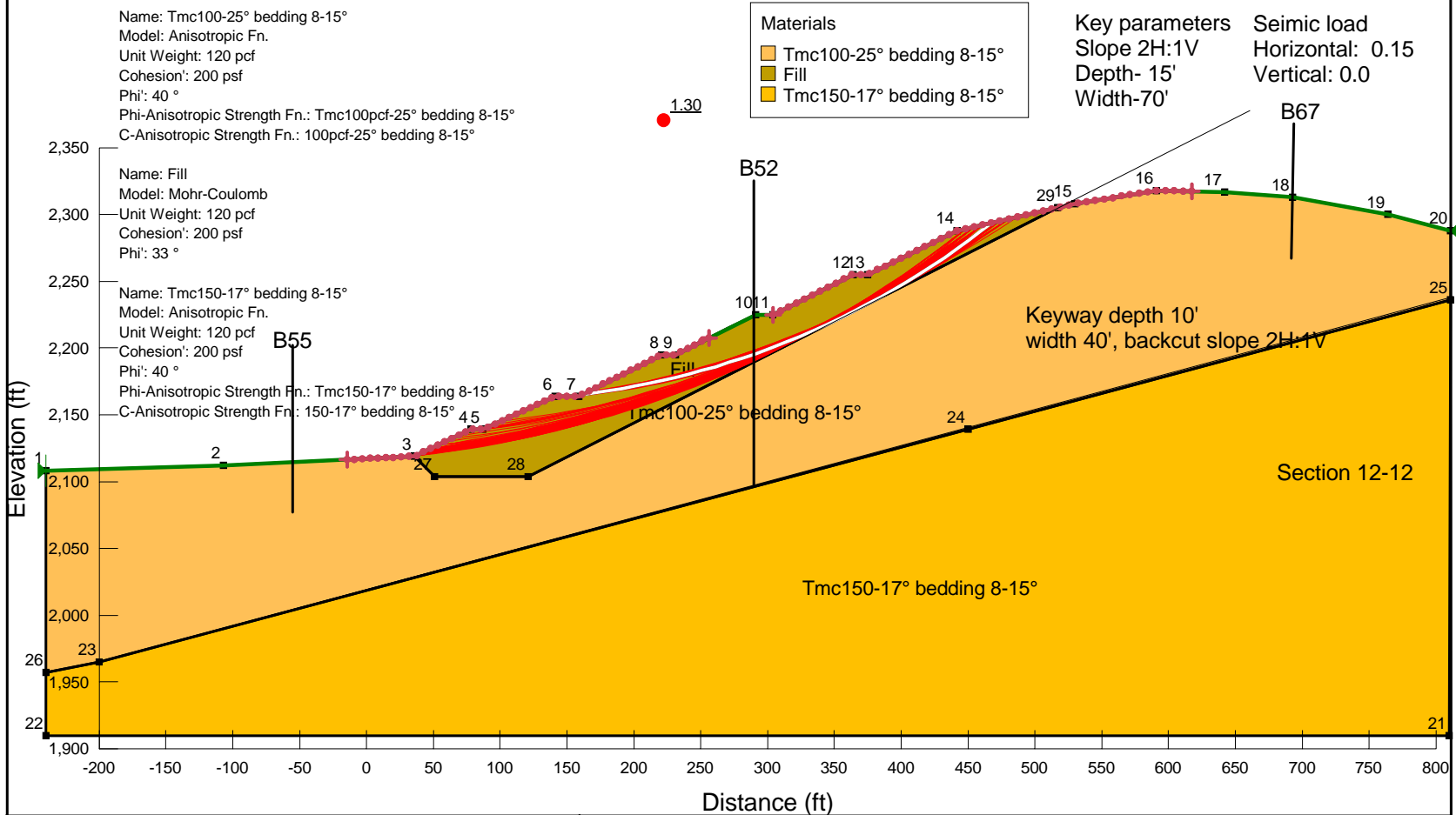

	<p>LGC Valley, Inc GEOTECHNICAL CONSULTING 28532 Constellation Road, Valencia, CA 91355 Phone 661-702-8474, Fax 661-702-8475</p>	<p>Skyline Ranch Development project, Tract 60922 Los Angeles CA</p>	<p>Project No: 153035-01 Engineer: BAS Date: March 2016</p>
---	---	---	--

1 - Circular Mode of Failure

Report generated using GeoStudio 2012. Copyright © 1991-2015 GEO-SLOPE International Ltd.

File Information

File Version: 8.15
 Title: Static Slope Stability Analyses for Skyline Ranch Development project, Tract 60922, Los Angeles CA
 Comments: Run By: Dr. Alexander Bykovtsev, Ph.D., P.E.
 Last Edited By: Alexander Bykovtsev
 Revision Number: 115
 Date: 3/20/2016
 Time: 1:35:46 PM
 Tool Version: 8.15.1.11236
 File Name: Section 12-12 Seismic Final with keyway SSA for Skyline Ranch.sgs
 Directory: C:\Users\Alexander\Desktop\LGC valley\original sections\
 Last Solved Date: 3/20/2016
 Last Solved Time: 1:36:02 PM

Project Settings

Length(L) Units: Feet
 Time(t) Units: Seconds
 Force(F) Units: Pounds
 Pressure(p) Units: psf
 Strength Units: psf
 Unit Weight of Water: 62.4 pcf
 View: 2D
 Element Thickness: 1

Analysis Settings

1 - Circular Mode of Failure

Kind: [SLOPE/W](#)
 Method: [Bishop](#)
 Settings
 PWP Conditions Source: [\(none\)](#)
 Slip Surface
 Direction of movement: [Right to Left](#)
 Use Passive Mode: [No](#)
 Slip Surface Option: [Entry and Exit](#)
 Critical slip surfaces saved: [10](#)
 Resisting Side Maximum Convex Angle: [1 °](#)
 Driving Side Maximum Convex Angle: [5 °](#)
 Optimize Critical Slip Surface Location: [No](#)
 Tension Crack
 Tension Crack Option: [\(none\)](#)

F of S Distribution
 F of S Calculation Option: [Constant](#)
 Advanced
 Number of Slices: [30](#)
 F of S Tolerance: [0.01](#)
 Minimum Slip Surface Depth: [0.1 ft](#)

Materials

Tmc100-25° bedding 8-15°

Model: [Anisotropic Fn.](#)
 Unit Weight: [120 pcf](#)
 Cohesion': [200 psf](#)
 Phi': [40 °](#)
 Phi-Anisotropic Strength Fn.: [Tmc100pcf-25° bedding 8-15°](#)
 C-Anisotropic Strength Fn.: [100pcf-25° bedding 8-15°](#)
 Phi-B: [0 °](#)

Fill

Model: [Mohr-Coulomb](#)
 Unit Weight: [120 pcf](#)
 Cohesion': [200 psf](#)
 Phi': [33 °](#)
 Phi-B: [0 °](#)

Tmc150-17° bedding 8-15°

Model: [Anisotropic Fn.](#)
 Unit Weight: [120 pcf](#)
 Cohesion': [200 psf](#)
 Phi': [40 °](#)
 Phi-Anisotropic Strength Fn.: [Tmc150-17° bedding 8-15°](#)
 C-Anisotropic Strength Fn.: [150-17° bedding 8-15°](#)
 Phi-B: [0 °](#)

Slip Surface Entry and Exit

Left Projection: [Range](#)
 Left-Zone Left Coordinate: [\(-14.6024, 2,116.523\) ft](#)
 Left-Zone Right Coordinate: [\(256.0584, 2,207.5292\) ft](#)
 Left-Zone Increment: [50](#)
 Right Projection: [Range](#)
 Right-Zone Left Coordinate: [\(304, 2,225\) ft](#)
 Right-Zone Right Coordinate: [\(617.5728, 2,317.479\) ft](#)
 Right-Zone Increment: [50](#)
 Radius Increments: [50](#)

Slip Surface Limits

Left Coordinate: (-240, 2,108) ft
 Right Coordinate: (811, 2,288) ft

Seismic Coefficients

Horz Seismic Coef.: 0.15
 Vert Seismic Coef.: 0

Anisotropic Strength Functions

150-17° bedding 8-15°

Model: Spline Data Point Function
 Function: Modifier Factor vs. Inclination
 Curve Fit to Data: 100 %
 Segment Curvature: 0 %
 Y-Intercept: 1
 Data Points: Inclination (°), Modifier Factor
 Data Point: (-90, 1)
 Data Point: (7.9, 1)
 Data Point: (8, 0.75)
 Data Point: (15, 0.75)
 Data Point: (15.1, 1)

100pcf-25° bedding 8-15°

Model: Spline Data Point Function
 Function: Modifier Factor vs. Inclination
 Curve Fit to Data: 100 %
 Segment Curvature: 0 %
 Y-Intercept: 1
 Data Points: Inclination (°), Modifier Factor
 Data Point: (-90, 1)
 Data Point: (7.9, 1)
 Data Point: (8, 0.5)
 Data Point: (15, 0.5)
 Data Point: (15.1, 1)

Tmc150-17° bedding 8-15°

Model: Spline Data Point Function
 Function: Modifier Factor vs. Inclination
 Curve Fit to Data: 100 %
 Segment Curvature: 0 %
 Y-Intercept: 1
 Data Points: Inclination (°), Modifier Factor
 Data Point: (-90, 1)
 Data Point: (7.9, 1)
 Data Point: (8, 0.425)
 Data Point: (15, 0.425)
 Data Point: (15.1, 1)

Tmc100pcf-25° bedding 8-15°

Model: Spline Data Point Function
 Function: Modifier Factor vs. Inclination
 Curve Fit to Data: 100 %
 Segment Curvature: 0 %
 Y-Intercept: 1
 Data Points: Inclination (°), Modifier Factor
 Data Point: (-90, 1)
 Data Point: (7.9, 1)
 Data Point: (8, 0.625)
 Data Point: (15, 0.625)
 Data Point: (15.1, 1)

Points

	X (ft)	Y (ft)
Point 1	-240	2,108
Point 2	-107	2,112
Point 3	36	2,119
Point 4	78	2,139
Point 5	87	2,139
Point 6	141	2,164
Point 7	159	2,164
Point 8	221	2,195
Point 9	231	2,195
Point 10	291	2,225
Point 11	304	2,225
Point 12	364	2,255
Point 13	375	2,255
Point 14	442	2,288
Point 15	530	2,308
Point 16	591	2,318
Point 17	642	2,317
Point 18	693	2,313
Point 19	764	2,300
Point 20	811	2,288
Point 21	810	1,910
Point 22	-240	1,910
Point 23	-200	1,965
Point 24	450	2,139
Point 25	810.8624	2,236
Point 26	-240	1,957
Point 27	51	2,104
Point 28	121	2,104
Point 29	517	2,305

Regions

	Material	Points	Area (ft ²)
Region 1	Tmc100-25° bedding 8-15°	1,26,23,24,25,20,19,18,17,16,15,29,28,27,3,2	1.1206e+005
Region 2	Tmc150-17° bedding 8-15°	23,26,22,21,25,24	1.9434e+005
Region 3	Fill	3,27,28,29,14,13,12,11,10,9,8,7,6,5,4	14,105

Current Slip Surface

Slip Surface: 79,417
 F of S: 1.30
 Volume: 5,827.6236 ft³
 Weight: 699,314.83 lbs
 Resisting Moment: 2.8656071e+008 lbs-ft
 Activating Moment: 2.2089541e+008 lbs-ft
 F of S Rank (Analysis): 1 of 132,651 slip surfaces
 F of S Rank (Query): 1 of 100 slip surfaces
 Exit: (161.71733, 2,165.3587) ft
 Entry: (467.54239, 2,293.7896) ft
 Radius: 614.64467 ft
 Center: (85.471326, 2,775.2559) ft

Slip Slices

	X (ft)	Y (ft)	PWP (psf)	Base Normal Stress (psf)	Frictional Strength (psf)	Cohesive Strength (psf)
Slice 1	166.65755	2,166.017	0	184.64344	119.90885	200
Slice 2	176.538	2,167.4155	0	576.28907	374.2465	200
Slice 3	186.41844	2,168.9782	0	943.68835	612.83838	200
Slice 4	196.29889	2,170.7064	0	1,287.1841	835.90712	200
Slice 5	206.17933	2,172.6015	0	1,607.091	1,043.6571	200
Slice 6	216.05978	2,174.6652	0	1,903.6972	1,236.2754	200
Slice 7	226	2,176.9137	0	1,910.2766	1,240.5481	200
Slice 8	236	2,179.351	0	1,899.5067	1,233.5541	200
Slice 9	246	2,181.9669	0	2,134.1089	1,385.9065	200
Slice 10	256	2,184.7638	0	2,345.7677	1,523.3593	200

Slice 11	266	2,187.7441	0	2,534.662	1,646.0288	200
Slice 12	276	2,190.9107	0	2,700.9487	1,754.0166	200
Slice 13	286	2,194.2668	0	2,844.763	1,847.4107	200
Slice 14	297.5	2,198.3816	0	2,651.2432	1,721.7375	200
Slice 15	309	2,202.7227	0	2,438.0634	1,583.2969	200
Slice 16	319	2,206.7287	0	2,513.917	1,632.5568	200
Slice 17	329	2,210.9402	0	2,567.6705	1,667.4647	200
Slice 18	339	2,215.362	0	2,599.3578	1,688.0427	200
Slice 19	349	2,219.9991	0	2,608.9941	1,694.3006	200
Slice 20	359	2,224.857	0	2,596.5757	1,686.2359	200
Slice 21	369.5	2,230.2079	0	2,297.3103	1,491.8907	200
Slice 22	379.78571	2,235.6844	0	1,978.2067	1,284.6624	200
Slice 23	389.35714	2,241.017	0	1,899.6515	1,233.6481	200
Slice 24	398.92857	2,246.5767	0	1,800.8901	1,169.5117	200
Slice 25	408.5	2,252.3707	0	1,681.8489	1,092.2054	200
Slice 26	418.07143	2,258.4069	0	1,542.441	1,001.6729	200
Slice 27	427.64286	2,264.6939	0	1,382.5664	897.84912	200
Slice 28	437.21429	2,271.2411	0	1,202.113	780.66129	200
Slice 29	446.25706	2,277.6676	0	913.53729	593.25806	200
Slice 30	454.77119	2,283.9542	0	521.58308	338.72001	200
Slice 31	463.28532	2,290.4719	0	116.99713	75.978824	200

Section 12-12 Static Final with keyway SSA for Skyline Ranch.gsz

Section 12-12 Static Final with keyway SSA for Skyline Ranch.gsz Run By: Dr. Alexander Bykovtsev, Ph.D., P.E. 3/20/2016 1:48:15 PM

Name: Tmc100-25° bedding 8-15°
 Model: Anisotropic Fn.
 Unit Weight: 120 pcf
 Cohesion: 200 psf
 Phi: 40°
 Phi-Anisotropic Strength Fn.: Tmc100pcf-25° bedding 8-15°
 C-Anisotropic Strength Fn.: 100pcf-25° bedding 8-15°

Materials

- Tmc100-25° bedding 8-15°
- Fill
- Tmc150-17° bedding 8-15°

Key parameters

Slope 2H:1V
 Depth- 15'
 Width-70'

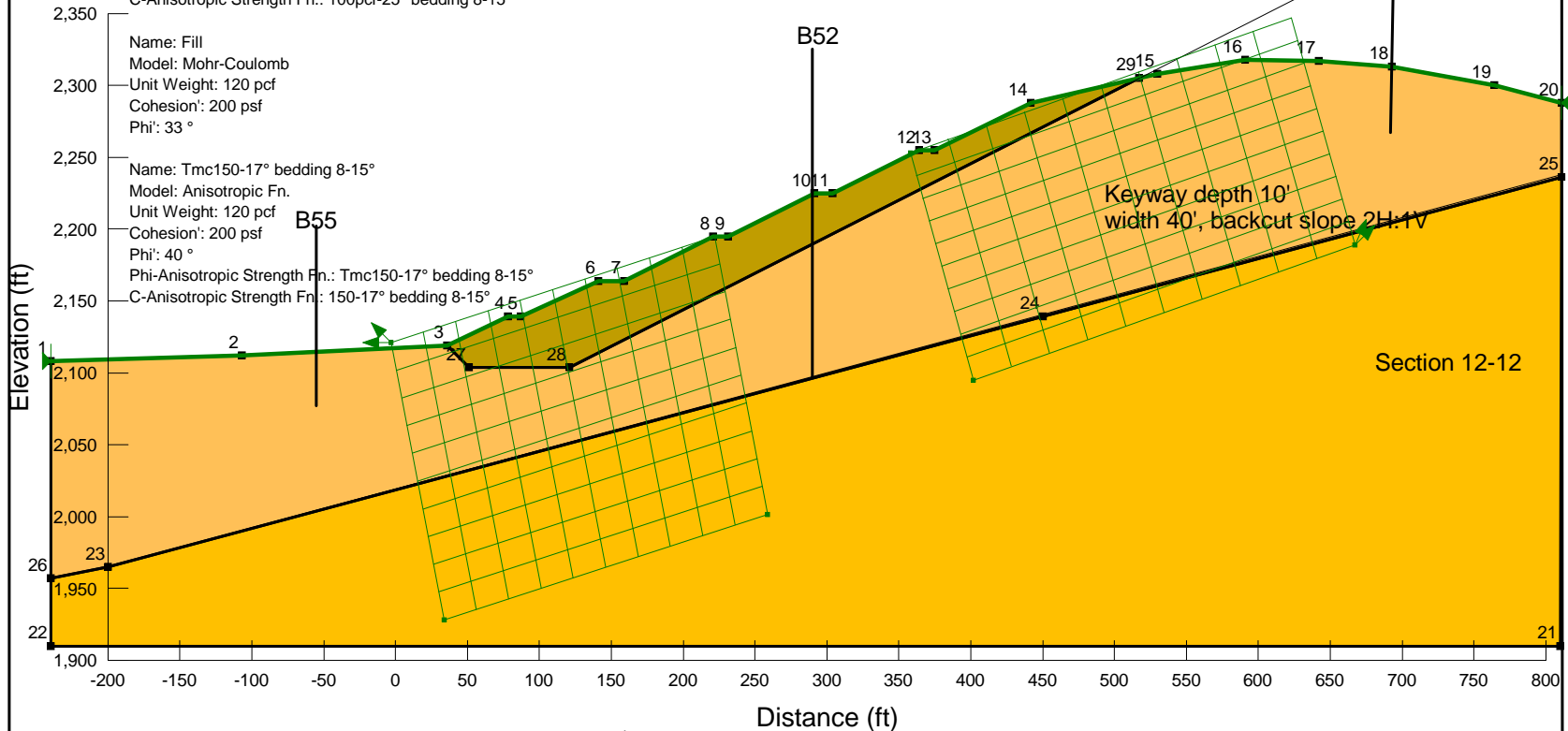

LGC **LGC Valley, Inc**
 GEOTECHNICAL CONSULTING
 28532 Constellation Road, Valencia, CA 91355
 Phone 661-702-8474, Fax 661-702-8475

Skyline Ranch
 Development project, Tract 60922
 Los Angeles CA

Project No: **153035-01**
 Engineer: **BAS**
 Date: **March 2016**

2 - Translational

Report generated using GeoStudio 2012. Copyright © 1991-2015 GEO-SLOPE International Ltd.

File Information

File Version: 8.15
 Title: Static Slope Stability Analyses for Skyline Ranch Development project, Tract 60922, Los Angeles CA
 Comments: Run By: Dr. Alexander Bykovtsev, Ph.D., P.E.
 Last Edited By: Alexander Bykovtsev
 Revision Number: 118
 Date: 3/20/2016
 Time: 1:48:15 PM
 Tool Version: 8.15.1.11236
 File Name: Section 12-12 Static Final with keyway SSA for Skyline Ranch.gsz
 Directory: C:\Users\Alexander\Desktop\LGC valley\original sections\Final Results for Section 12\

Project Settings

Length(L) Units: Feet
 Time(t) Units: Seconds
 Force(F) Units: Pounds
 Pressure(p) Units: psf
 Strength Units: psf
 Unit Weight of Water: 62.4 pcf
 View: 2D
 Element Thickness: 1

Analysis Settings

2 - Translational

Kind: SLOPE/W
 Method: Janbu
 Settings
 PWP Conditions Source: (none)
 Slip Surface
 Direction of movement: Right to Left
 Use Passive Mode: No
 Slip Surface Option: Block
 Critical slip surfaces saved: 10
 Resisting Side Maximum Convex Angle: 1 °
 Driving Side Maximum Convex Angle: 5 °
 Restrict Block Crossing: No
 Optimize Critical Slip Surface Location: No
 Tension Crack
 Tension Crack Option: (none)
 F of S Distribution

F of S Calculation Option: Constant
 Advanced
 Number of Slices: 30
 F of S Tolerance: 0.01
 Minimum Slip Surface Depth: 0.1 ft

Materials

Tmc100-25° bedding 8-15°

Model: Anisotropic Fn.
 Unit Weight: 120 pcf
 Cohesion': 200 psf
 Phi': 40 °
 Phi-Anisotropic Strength Fn.: Tmc100pcf-25° bedding 8-15°
 C-Anisotropic Strength Fn.: 100pcf-25° bedding 8-15°
 Phi-B: 0 °

Fill

Model: Mohr-Coulomb
 Unit Weight: 120 pcf
 Cohesion': 200 psf
 Phi': 33 °
 Phi-B: 0 °

Tmc150-17° bedding 8-15°

Model: Anisotropic Fn.
 Unit Weight: 120 pcf
 Cohesion': 200 psf
 Phi': 40 °
 Phi-Anisotropic Strength Fn.: Tmc150-17° bedding 8-15°
 C-Anisotropic Strength Fn.: 150-17° bedding 8-15°
 Phi-B: 0 °

Slip Surface Limits

Left Coordinate: (-240, 2,108) ft
 Right Coordinate: (811, 2,288) ft

Slip Surface Block

Left Grid
 Upper Left: (-3, 2,120.9992) ft
 Lower Left: (34, 1,927.9128) ft
 Lower Right: (259, 2,001.527) ft
 X Increments: 10
 Y Increments: 10
 Starting Angle: 135 °
 Ending Angle: 180 °

Angle Increments: 2
 Right Grid
 Upper Left: (358, 2,253) ft
 Lower Left: (402, 2,095) ft
 Lower Right: (667, 2,189) ft
 X Increments: 10
 Y Increments: 10
 Starting Angle: 45 °
 Ending Angle: 65 °
 Angle Increments: 2

Seismic Coefficients

Horz Seismic Coef.: 0
 Vert Seismic Coef.: 0

Anisotropic Strength Functions

150-17° bedding 8-15°

Model: Spline Data Point Function
 Function: Modifier Factor vs. Inclination
 Curve Fit to Data: 100 %
 Segment Curvature: 0 %
 Y-Intercept: 1
 Data Points: Inclination (°), Modifier Factor
 Data Point: (-90, 1)
 Data Point: (7.9, 1)
 Data Point: (8, 0.75)
 Data Point: (15, 0.75)
 Data Point: (15.1, 1)

100pcf-25° bedding 8-15°

Model: Spline Data Point Function
 Function: Modifier Factor vs. Inclination
 Curve Fit to Data: 100 %
 Segment Curvature: 0 %
 Y-Intercept: 1
 Data Points: Inclination (°), Modifier Factor
 Data Point: (-90, 1)
 Data Point: (7.9, 1)
 Data Point: (8, 0.5)
 Data Point: (15, 0.5)
 Data Point: (15.1, 1)

Tmc150-17° bedding 8-15°

Model: Spline Data Point Function
 Function: Modifier Factor vs. Inclination
 Curve Fit to Data: 100 %
 Segment Curvature: 0 %

Y-Intercept: 1
 Data Points: Inclination (°), Modifier Factor
 Data Point: (-90, 1)
 Data Point: (7.9, 1)
 Data Point: (8, 0.425)
 Data Point: (15, 0.425)
 Data Point: (15.1, 1)

Tmc100pcf-25° bedding 8-15°

Model: Spline Data Point Function
 Function: Modifier Factor vs. Inclination
 Curve Fit to Data: 100 %
 Segment Curvature: 0 %
 Y-Intercept: 1
 Data Points: Inclination (°), Modifier Factor
 Data Point: (-90, 1)
 Data Point: (7.9, 1)
 Data Point: (8, 0.625)
 Data Point: (15, 0.625)
 Data Point: (15.1, 1)

Points

	X (ft)	Y (ft)
Point 1	-240	2,108
Point 2	-107	2,112
Point 3	36	2,119
Point 4	78	2,139
Point 5	87	2,139
Point 6	141	2,164
Point 7	159	2,164
Point 8	221	2,195
Point 9	231	2,195
Point 10	291	2,225
Point 11	304	2,225
Point 12	364	2,255
Point 13	375	2,255
Point 14	442	2,288
Point 15	530	2,308
Point 16	591	2,318
Point 17	642	2,317
Point 18	693	2,313
Point 19	764	2,300
Point 20	811	2,288
Point 21	810	1,910
Point 22	-240	1,910

Point 23	-200	1,965
Point 24	450	2,139
Point 25	810.8624	2,236
Point 26	-240	1,957
Point 27	51	2,104
Point 28	121	2,104
Point 29	517	2,305

Regions

	Material	Points	Area (ft ²)
Region 1	Tmc100-25° bedding 8-15°	1,26,23,24,25,20,19,18,17,16,15,29,28,27,3,2	1.1206e+005
Region 2	Tmc150-17° bedding 8-15°	23,26,22,21,25,24	1.9434e+005
Region 3	Fill	3,27,28,29,14,13,12,11,10,9,8,7,6,5,4	14,105

Section 12-12 Seismic Final with keyway SSA for Skyline Ranch.gsz

Section 12-12 Seismic Final with keyway SSA for Skyline Ranch.gsz Run By: Dr. Alexander Bykovtsev, Ph.D., P.E. 3/20/2016 1:28:21 PM

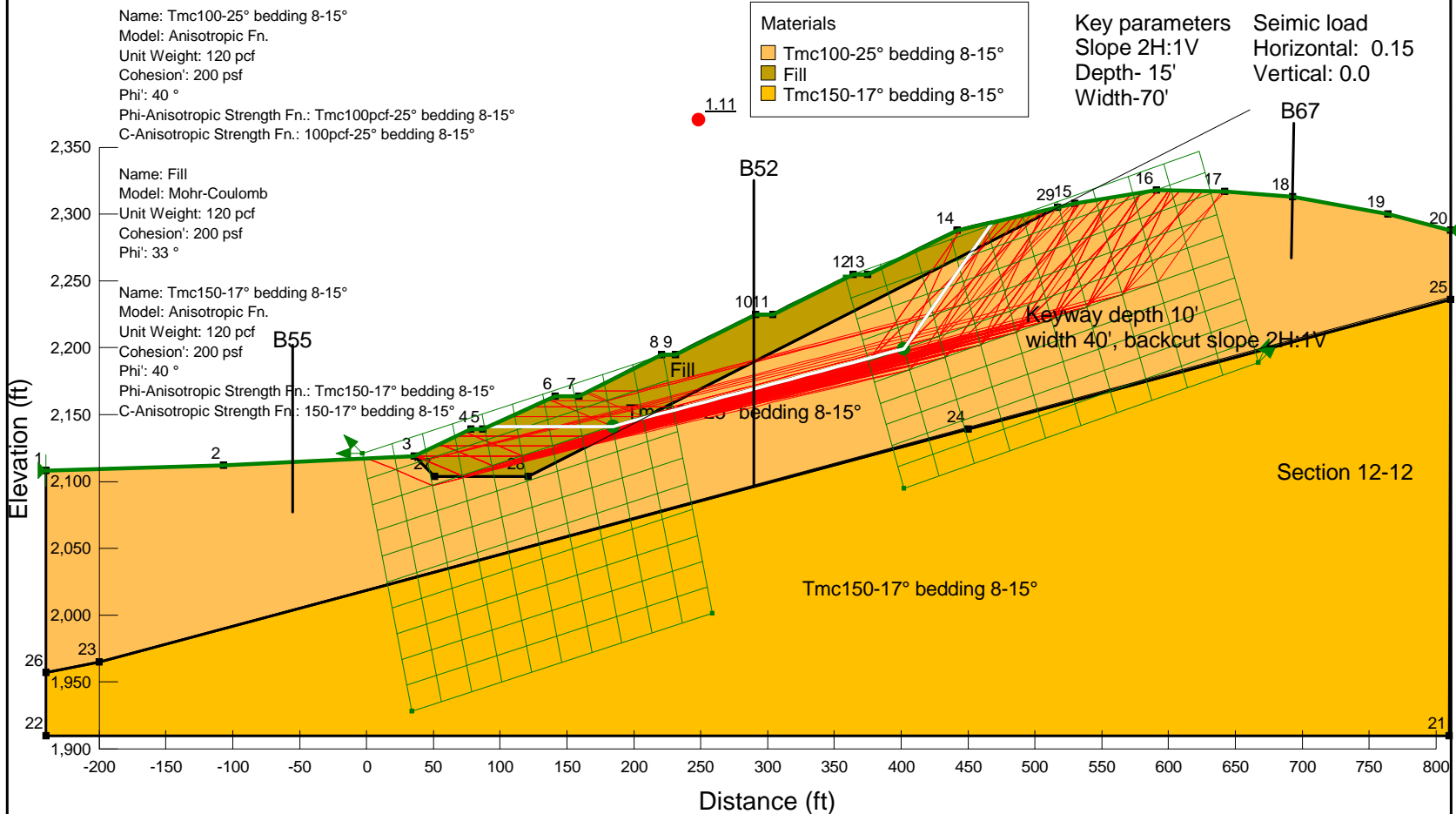

	LGC Valley, Inc GEOTECHNICAL CONSULTING 28532 Constellation Road, Valencia, CA 91355 Phone 661-702-8474, Fax 661-702-8475	Skyline Ranch Development project, Tract 60922 Los Angeles CA	Project No: 153035-01 Engineer: BAS Date: March 2016
---	---	--	---

2 - Translational

Report generated using GeoStudio 2012. Copyright © 1991-2015 GEO-SLOPE International Ltd.

File Information

File Version: 8.15
 Title: Static Slope Stability Analyses for Skyline Ranch Development project, Tract 60922, Los Angeles CA
 Comments: Run By: Dr. Alexander Bykovtsev, Ph.D., P.E.
 Last Edited By: Alexander Bykovtsev
 Revision Number: 113
 Date: 3/20/2016
 Time: 1:28:21 PM
 Tool Version: 8.15.1.11236
 File Name: Section 12-12 Seismic Final with keyway SSA for Skyline Ranch.gsz
 Directory: C:\Users\Alexander\Desktop\LGC valley\original sections\
 Last Solved Date: 3/20/2016
 Last Solved Time: 1:28:37 PM

Project Settings

Length(L) Units: Feet
 Time(t) Units: Seconds
 Force(F) Units: Pounds
 Pressure(p) Units: psf
 Strength Units: psf
 Unit Weight of Water: 62.4 pcf
 View: 2D
 Element Thickness: 1

Analysis Settings

2 - Translational

Kind: SLOPE/W
 Method: Janbu
 Settings
 PWP Conditions Source: (none)
 Slip Surface
 Direction of movement: Right to Left
 Use Passive Mode: No
 Slip Surface Option: Block
 Critical slip surfaces saved: 10
 Resisting Side Maximum Convex Angle: 1 °
 Driving Side Maximum Convex Angle: 5 °
 Restrict Block Crossing: No
 Optimize Critical Slip Surface Location: No
 Tension Crack

file:///C:/Users/Alexander/Desktop/LGC%20valley/original%20sections/section%2012-12... 3/20/2016

Tension Crack Option: (none)
 F of S Distribution
 F of S Calculation Option: Constant
 Advanced
 Number of Slices: 30
 F of S Tolerance: 0.01
 Minimum Slip Surface Depth: 0.1 ft

Materials

Tmc100-25° bedding 8-15°

Model: Anisotropic Fn.
 Unit Weight: 120 pcf
 Cohesion': 200 psf
 Phi': 40 °
 Phi-Anisotropic Strength Fn.: Tmc100pcf-25° bedding 8-15°
 C-Anisotropic Strength Fn.: 100pcf-25° bedding 8-15°
 Phi-B: 0 °

Fill

Model: Mohr-Coulomb
 Unit Weight: 120 pcf
 Cohesion': 200 psf
 Phi': 33 °
 Phi-B: 0 °

Tmc150-17° bedding 8-15°

Model: Anisotropic Fn.
 Unit Weight: 120 pcf
 Cohesion': 200 psf
 Phi': 40 °
 Phi-Anisotropic Strength Fn.: Tmc150-17° bedding 8-15°
 C-Anisotropic Strength Fn.: 150-17° bedding 8-15°
 Phi-B: 0 °

Slip Surface Limits

Left Coordinate: (-240, 2,108) ft
 Right Coordinate: (811, 2,288) ft

Slip Surface Block

Left Grid
 Upper Left: (-3, 2,120.9992) ft
 Lower Left: (34, 1,927.9128) ft
 Lower Right: (259, 2,001.527) ft
 X Increments: 10
 Y Increments: 10

file:///C:/Users/Alexander/Desktop/LGC%20valley/original%20sections/section%2012-12... 3/20/2016

Starting Angle: 135 °
 Ending Angle: 180 °
 Angle Increments: 2
 Right Grid
 Upper Left: (358, 2,253) ft
 Lower Left: (402, 2,095) ft
 Lower Right: (667, 2,189) ft
 X Increments: 10
 Y Increments: 10
 Starting Angle: 45 °
 Ending Angle: 65 °
 Angle Increments: 2

Seismic Coefficients

Horz Seismic Coef.: 0.15
 Vert Seismic Coef.: 0

Anisotropic Strength Functions

150-17° bedding 8-15°

Model: Spline Data Point Function
 Function: Modifier Factor vs. Inclination
 Curve Fit to Data: 100 %
 Segment Curvature: 0 %
 Y-Intercept: 1
 Data Points: Inclination (°), Modifier Factor
 Data Point: (-90, 1)
 Data Point: (7.9, 1)
 Data Point: (8, 0.75)
 Data Point: (15, 0.75)
 Data Point: (15.1, 1)

100pcf-25° bedding 8-15°

Model: Spline Data Point Function
 Function: Modifier Factor vs. Inclination
 Curve Fit to Data: 100 %
 Segment Curvature: 0 %
 Y-Intercept: 1
 Data Points: Inclination (°), Modifier Factor
 Data Point: (-90, 1)
 Data Point: (7.9, 1)
 Data Point: (8, 0.5)
 Data Point: (15, 0.5)
 Data Point: (15.1, 1)

Tmc150-17° bedding 8-15°

Model: Spline Data Point Function
 Function: Modifier Factor vs. Inclination

Curve Fit to Data: 100 %
 Segment Curvature: 0 %
 Y-Intercept: 1
 Data Points: Inclination (°), Modifier Factor
 Data Point: (-90, 1)
 Data Point: (7.9, 1)
 Data Point: (8, 0.425)
 Data Point: (15, 0.425)
 Data Point: (15.1, 1)

Tmc100pcf-25° bedding 8-15°

Model: Spline Data Point Function
 Function: Modifier Factor vs. Inclination
 Curve Fit to Data: 100 %
 Segment Curvature: 0 %
 Y-Intercept: 1
 Data Points: Inclination (°), Modifier Factor
 Data Point: (-90, 1)
 Data Point: (7.9, 1)
 Data Point: (8, 0.625)
 Data Point: (15, 0.625)
 Data Point: (15.1, 1)

Points

	X (ft)	Y (ft)
Point 1	-240	2,108
Point 2	-107	2,112
Point 3	36	2,119
Point 4	78	2,139
Point 5	87	2,139
Point 6	141	2,164
Point 7	159	2,164
Point 8	221	2,195
Point 9	231	2,195
Point 10	291	2,225
Point 11	304	2,225
Point 12	364	2,255
Point 13	375	2,255
Point 14	442	2,288
Point 15	530	2,308
Point 16	591	2,318
Point 17	642	2,317
Point 18	693	2,313
Point 19	764	2,300
Point 20	811	2,288
Point 21	810	1,910

Point 22	-240	1,910
Point 23	-200	1,965
Point 24	450	2,139
Point 25	810.8624	2,236
Point 26	-240	1,957
Point 27	51	2,104
Point 28	121	2,104
Point 29	517	2,305

Regions

Region	Material	Points	Area (ft ²)
Region 1	Tmc100-25° bedding 8-15°	1,26,23,24,25,20,19,18,17,16,15,29,28,27,3,2	1.1206e+005
Region 2	Tmc150-17° bedding 8-15°	23,26,22,21,25,24	1.9434e+005
Region 3	Fill	3,27,28,29,14,13,12,11,10,9,8,7,6,5,4	14,105

Current Slip Surface

Slip Surface: 105,473
 F of S: 1.11
 Volume: 15,653.932 ft³
 Weight: 1,878,471.8 lbs
 Resisting Force: 889,080.31 lbs
 Activating Force: 799,701.22 lbs
 F of S Rank (Analysis): 1 of 131,769 slip surfaces
 F of S Rank (Query): 1 of 100 slip surfaces
 Exit: (91.910285, 2,141.2733) ft
 Entry: (468.48139, 2,294.0024) ft
 Radius: 215.82605 ft
 Center: (233.73808, 2,332.1847) ft

Slip Slices

	X (ft)	Y (ft)	PWP (psf)	Base Normal Stress (psf)	Frictional Strength (psf)	Cohesive Strength (psf)
Slice 1	98.046499	2,141.2733	0	340.9008	221.38357	200
	110.31893	2,141.2733	0	1,022.7024	664.1507	200

Slice						
Slice 2						
Slice 3	122.59136	2,141.2733	0	1,704.504	1,106.9178	200
Slice 4	134.86379	2,141.2733	0	2,386.3056	1,549.685	200
Slice 5	150	2,141.2733	0	2,727.2064	1,771.0685	200
Slice 6	165.35	2,141.2733	0	3,108.2064	2,018.4928	200
Slice 7	178.05	2,141.2733	0	3,870.2064	2,513.3414	200
Slice 8	189.67244	2,142.6762	0	3,763.0085	2,443.7263	200
Slice 9	200.21731	2,145.482	0	4,018.9963	2,609.9667	200
Slice 10	213.24487	2,148.9485	0	4,528.6368	2,111.738	100
Slice 11	226	2,152.3424	0	4,580.8154	2,136.0693	100
Slice 12	237	2,155.2694	0	4,588.6985	2,139.7453	100
Slice 13	249	2,158.4624	0	4,891.5517	2,280.968	100
Slice 14	261	2,161.6554	0	5,194.405	2,422.1908	100
Slice 15	273	2,164.8484	0	5,497.2582	2,563.4136	100
Slice 16	285	2,168.0414	0	5,800.1114	2,704.6364	100
Slice 17	297.5	2,171.3675	0	5,764.9315	2,688.2317	100
Slice 18	310	2,174.6936	0	5,729.7516	2,671.827	100
Slice 19	322	2,177.8866	0	6,032.6048	2,813.0498	100
Slice 20	334	2,181.0796	0	6,335.458	2,954.2726	100
Slice 21	346	2,184.2726	0	6,638.3113	3,095.4954	100
Slice 22	358	2,187.4656	0	6,941.1645	3,236.7182	100
Slice 23	369.5	2,190.5256	0	6,934.6933	3,233.7006	100
Slice 24	381.775	2,193.7918	0	6,942.3262	3,237.2599	100
Slice 25	395.325	2,197.3973	0	7,273.388	3,391.6365	100

Slice 26	408.75	2,208.6972	0	3,499.7987	2,936.6798	200
Slice 27	422.05	2,227.6916	0	2,783.1982	2,335.3806	200
Slice 28	435.35	2,246.6859	0	2,066.5977	1,734.0814	200
Slice 29	447.83806	2,264.5207	0	1,304.3584	1,094.4866	200
Slice 30	461.07875	2,283.4304	0	439.95509	285.71017	200

Section 12-12 Static Temporary Final without keyway SSA for Skyline Ranch.gsz

Section 12-12 Static Temporary Final without keyway SSA for Skyline Ranch.gsz Run By: Dr. Alexander Bykovtsev, Ph.D., P.E. 3/20/2016 1:53:40 PM

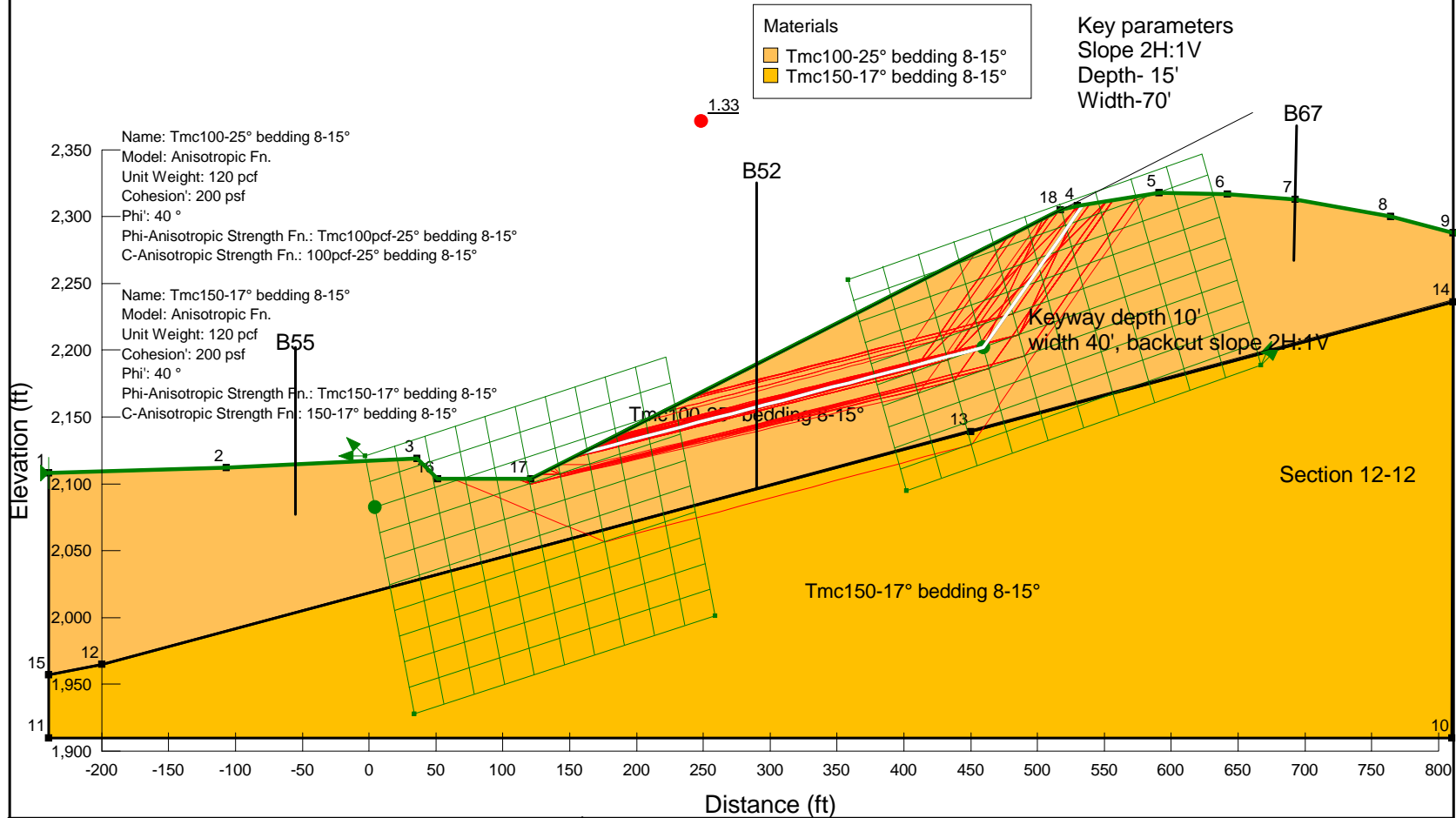

LGC Valley, Inc
 GEOTECHNICAL CONSULTING
 28532 Constellation Road, Valencia, CA 91355
 Phone 661-702-8474, Fax 661-702-8475

Skyline Ranch
 Development project, Tract 60922
 Los Angeles CA

Project No: **153035-01**
 Engineer: **BAS**
 Date: **March 2016**

2 - Translational

Report generated using GeoStudio 2012. Copyright © 1991-2015 GEO-SLOPE International Ltd.

File Information

File Version: 8.15
 Title: Static Slope Stability Analyses for Skyline Ranch Development project, Tract 60922, Los Angeles CA
 Comments: Run By: Dr. Alexander Bykovtsev, Ph.D., P.E.
 Last Edited By: Alexander Bykovtsev
 Revision Number: 120
 Date: 3/20/2016
 Time: 1:53:40 PM
 Tool Version: 8.15.1.11236
 File Name: Section 12-12 Static Temporary Final without keyway SSA for Skyline Ranch.gsz
 Directory: C:\Users\Alexander\Desktop\LGC valley\original sections\Final Results for Section 12\
 Last Solved Date: 3/20/2016
 Last Solved Time: 1:54:59 PM

Project Settings

Length(L) Units: Feet
 Time(t) Units: Seconds
 Force(F) Units: Pounds
 Pressure(p) Units: psf
 Strength Units: psf
 Unit Weight of Water: 62.4 pcf
 View: 2D
 Element Thickness: 1

Analysis Settings

2 - Translational

Kind: SLOPE/W
 Method: Janbu
 Settings
 PWP Conditions Source: (none)
 Slip Surface
 Direction of movement: Right to Left
 Use Passive Mode: No
 Slip Surface Option: Block
 Critical slip surfaces saved: 10
 Resisting Side Maximum Convex Angle: 1 °
 Driving Side Maximum Convex Angle: 5 °
 Restrict Block Crossing: No
 Optimize Critical Slip Surface Location: No
 Tension Crack

file:///C:/Users/Alexander/Desktop/LGC%20valley/original%20sections/Final%20Results... 3/20/2016

Tension Crack Option: (none)
 F of S Distribution
 F of S Calculation Option: Constant
 Advanced
 Number of Slices: 30
 F of S Tolerance: 0.01
 Minimum Slip Surface Depth: 0.1 ft

Materials

Tmc100-25° bedding 8-15°

Model: Anisotropic Fn.
 Unit Weight: 120 pcf
 Cohesion': 200 psf
 Phi': 40 °
 Phi-Anisotropic Strength Fn.: Tmc100pcf-25° bedding 8-15°
 C-Anisotropic Strength Fn.: 100pcf-25° bedding 8-15°
 Phi-B: 0 °

Tmc150-17° bedding 8-15°

Model: Anisotropic Fn.
 Unit Weight: 120 pcf
 Cohesion': 200 psf
 Phi': 40 °
 Phi-Anisotropic Strength Fn.: Tmc150-17° bedding 8-15°
 C-Anisotropic Strength Fn.: 150-17° bedding 8-15°
 Phi-B: 0 °

Slip Surface Limits

Left Coordinate: (-240, 2,108) ft
 Right Coordinate: (811, 2,288) ft

Slip Surface Block

Left Grid
 Upper Left: (-3, 2,120.9992) ft
 Lower Left: (34, 1,927.9128) ft
 Lower Right: (259, 2,001.527) ft
 X Increments: 10
 Y Increments: 10
 Starting Angle: 135 °
 Ending Angle: 180 °
 Angle Increments: 2
 Right Grid
 Upper Left: (358, 2,253) ft
 Lower Left: (402, 2,095) ft
 Lower Right: (667, 2,189) ft

file:///C:/Users/Alexander/Desktop/LGC%20valley/original%20sections/Final%20Results... 3/20/2016

X Increments: 10
 Y Increments: 10
 Starting Angle: 45 °
 Ending Angle: 65 °
 Angle Increments: 2

Seismic Coefficients

Horz Seismic Coef.: 0
 Vert Seismic Coef.: 0

Anisotropic Strength Functions

150-17° bedding 8-15°

Model: Spline Data Point Function
 Function: Modifier Factor vs. Inclination
 Curve Fit to Data: 100 %
 Segment Curvature: 0 %

Y-Intercept: 1
 Data Points: Inclination (°), Modifier Factor
 Data Point: (-90, 1)
 Data Point: (7.9, 1)
 Data Point: (8, 0.75)
 Data Point: (15, 0.75)
 Data Point: (15.1, 1)

100pcf-25° bedding 8-15°

Model: Spline Data Point Function
 Function: Modifier Factor vs. Inclination
 Curve Fit to Data: 100 %
 Segment Curvature: 0 %

Y-Intercept: 1
 Data Points: Inclination (°), Modifier Factor
 Data Point: (-90, 1)
 Data Point: (7.9, 1)
 Data Point: (8, 0.5)
 Data Point: (15, 0.5)
 Data Point: (15.1, 1)

Tmc150-17° bedding 8-15°

Model: Spline Data Point Function
 Function: Modifier Factor vs. Inclination
 Curve Fit to Data: 100 %
 Segment Curvature: 0 %

Y-Intercept: 1
 Data Points: Inclination (°), Modifier Factor
 Data Point: (-90, 1)
 Data Point: (7.9, 1)
 Data Point: (8, 0.425)

Data Point: (15, 0.425)
 Data Point: (15.1, 1)

Tmc100pcf-25° bedding 8-15°

Model: Spline Data Point Function
 Function: Modifier Factor vs. Inclination
 Curve Fit to Data: 100 %
 Segment Curvature: 0 %

Y-Intercept: 1
 Data Points: Inclination (°), Modifier Factor
 Data Point: (-90, 1)
 Data Point: (7.9, 1)
 Data Point: (8, 0.625)
 Data Point: (15, 0.625)
 Data Point: (15.1, 1)

Points

	X (ft)	Y (ft)
Point 1	-240	2,108
Point 2	-107	2,112
Point 3	36	2,119
Point 4	530	2,308
Point 5	591	2,318
Point 6	642	2,317
Point 7	693	2,313
Point 8	764	2,300
Point 9	811	2,288
Point 10	810	1,910
Point 11	-240	1,910
Point 12	-200	1,965
Point 13	450	2,139
Point 14	810.8624	2,236
Point 15	-240	1,957
Point 16	51	2,104
Point 17	121	2,104
Point 18	517	2,305

Regions

	Material	Points	Area (ft²)
Region 1	Tmc100-25° bedding 8-15°	1,15,12,13,14,9,8,7,6,5,4,18,17,16,3,2	1.1206e+005
Region 2	Tmc150-17° bedding 8-15°	12,15,11,10,14,13	1.9434e+005

Current Slip Surface

Slip Surface: 96,734
 F of S: 1.33
 Volume: 13,980.199 ft³
 Weight: 1,677,623.9 lbs
 Resisting Force: 756,993.04 lbs
 Activating Force: 568,227.64 lbs
 F of S Rank (Analysis): 1 of 131,769 slip surfaces
 F of S Rank (Query): 1 of 100 slip surfaces
 Exit: (158.16867, 2,122.8659) ft
 Entry: (534.04644, 2,308.6634) ft
 Radius: 239.0956 ft
 Center: (277.22741, 2,355.1127) ft

Slip Slices

	X (ft)	Y (ft)	PWP (psf)	Base Normal Stress (psf)	Frictional Strength (psf)	Cohesive Strength (psf)
Slice 1	164.44641	2,124.5187	0	150.44855	70.15531	100
Slice 2	177.00188	2,127.8243	0	487.49666	227.32343	100
Slice 3	189.55735	2,131.1299	0	824.54477	384.49154	100
Slice 4	202.11282	2,134.4355	0	1,161.5929	541.65966	100
Slice 5	214.6683	2,137.7411	0	1,498.641	698.82777	100
Slice 6	227.22377	2,141.0466	0	1,835.6891	855.99589	100
Slice 7	239.77924	2,144.3522	0	2,172.7372	1,013.164	100
Slice 8	252.33471	2,147.6578	0	2,509.7853	1,170.3321	100
Slice 9	264.89018	2,150.9634	0	2,846.8334	1,327.5002	100
Slice 10	277.44566	2,154.269	0	3,183.8816	1,484.6683	100
Slice 11	290.00113	2,157.5746	0	3,520.9297	1,641.8365	100
Slice 12	302.5566	2,160.8802	0	3,857.9778	1,799.0046	100
Slice 13	315.11207	2,164.1858	0	4,195.0259	1,956.1727	100
Slice 14	327.66754	2,167.4913	0	4,532.074	2,113.3408	100
Slice 15	340.22302	2,170.7969	0	4,869.1221	2,270.5089	100
Slice 16	352.77849	2,174.1025	0	5,206.1702	2,427.677	100

Slice 17	365.33396	2,177.4081	0	5,543.2183	2,584.8452	100
Slice 18	377.88943	2,180.7137	0	5,880.2664	2,742.0133	100
Slice 19	390.4449	2,184.0193	0	6,217.3146	2,899.1814	100
Slice 20	403.00038	2,187.3249	0	6,554.3627	3,056.3495	100
Slice 21	415.55585	2,190.6304	0	6,891.4108	3,213.5176	100
Slice 22	428.11132	2,193.936	0	7,228.4589	3,370.6857	100
Slice 23	440.66679	2,197.2416	0	7,565.507	3,527.8539	100
Slice 24	453.22226	2,200.5472	0	7,902.5551	3,685.022	100
Slice 25	465.25	2,210.4119	0	4,205.6975	3,528.9992	200
Slice 26	476.75	2,226.8356	0	3,536.5318	2,967.5025	200
Slice 27	488.25	2,243.2593	0	2,867.366	2,406.0058	200
Slice 28	499.75	2,259.683	0	2,198.2003	1,844.5091	200
Slice 29	511.25	2,276.1067	0	1,529.0346	1,283.0123	200
Slice 30	523.5	2,293.6015	0	702.49952	589.46709	200
Slice 31	532.02322	2,305.7739	0	48.872803	41.009151	200

Section 13-13 Static Final SSA with key for Skyline Ranch.gsz

Section 13-13 Static Final SSA with key for Skyline Ranch.gsz Run By: Dr. Alexander Bykovtsev, Ph.D., P.E. 3/22/2016 12:10:09 PM

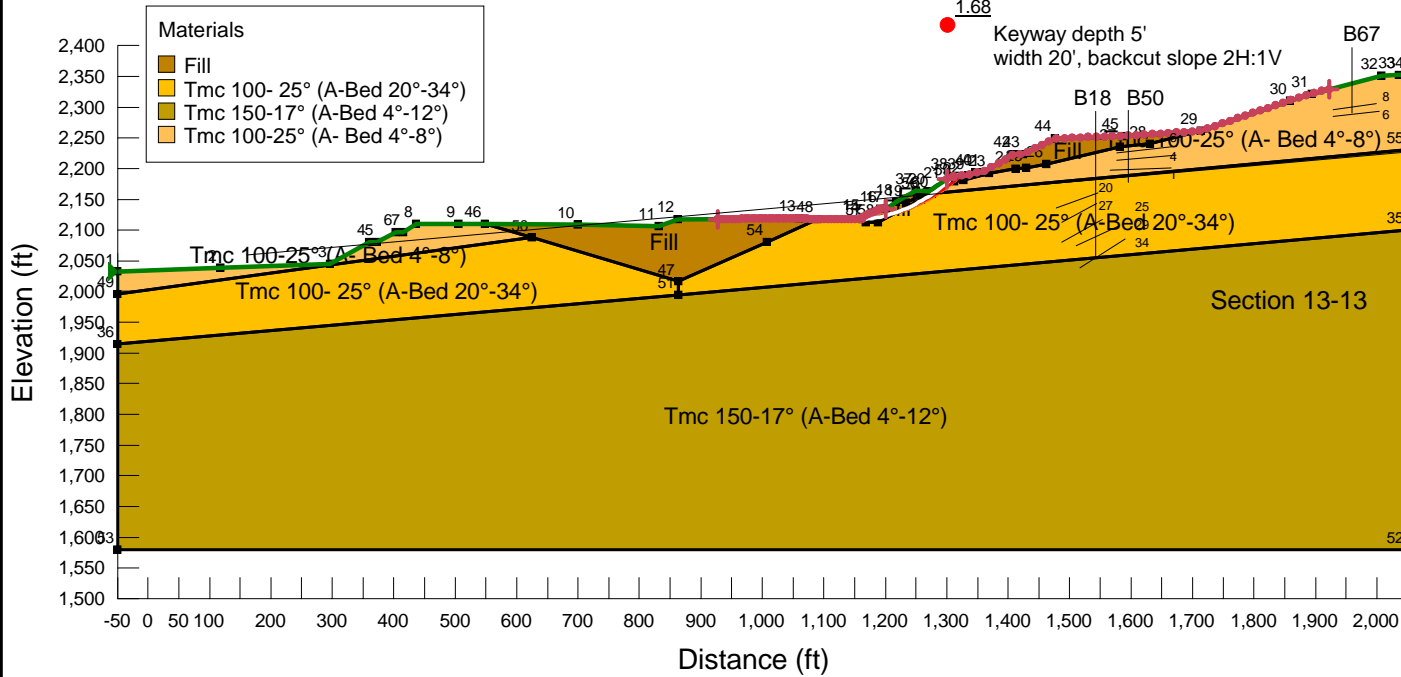

LGC **LGC Valley, Inc**
 GEOTECHNICAL CONSULTING
 28532 Constellation Road, Valencia, CA 91355
 Phone 661-702-8474, Fax 661-702-8475

Skyline Ranch
 Development project, Tract 60922
 Los Angeles CA

Project No: **153035-01**
 Engineer: **BAS**
 Date: **March 2016**

1 - Circular Mode of Failure

Report generated using GeoStudio 2012. Copyright © 1991-2015 GEO-SLOPE International Ltd.

File Information

File Version: 8.15
 Title: Static Slope Stability Analyses for Skyline Ranch Development project, Tract 60922, Los Angeles CA
 Comments: Run By: Dr. Alexander Bykovtsev, Ph.D., P.E.
 Last Edited By: Alexander Bykovtsev
 Revision Number: 137
 Date: 3/22/2016
 Time: 12:10:09 PM
 Tool Version: 8.15.1.11236
 File Name: Section 13-13 Static Final SSA with key for Skyline Ranch.gsz
 Directory: G:\SLOPE RESULTS\Section 13-13 results\
 Last Solved Date: 3/22/2016
 Last Solved Time: 12:13:40 PM

Project Settings

Length(L) Units: Feet
 Time(t) Units: Seconds
 Force(F) Units: Pounds
 Pressure(p) Units: psf
 Strength Units: psf
 Unit Weight of Water: 62.4 pcf
 View: 2D
 Element Thickness: 1

Analysis Settings

1 - Circular Mode of Failure

Kind: SLOPE/W
 Method: Bishop
 Settings
 PWP Conditions Source: (none)
 Slip Surface
 Direction of movement: Right to Left
 Use Passive Mode: No
 Slip Surface Option: Entry and Exit
 Critical slip surfaces saved: 1
 Resisting Side Maximum Convex Angle: 1 °
 Driving Side Maximum Convex Angle: 5 °
 Optimize Critical Slip Surface Location: No
 Tension Crack
 Tension Crack Option: (none)

F of S Distribution
 F of S Calculation Option: Constant
 Advanced
 Number of Slices: 30
 F of S Tolerance: 0.01
 Minimum Slip Surface Depth: 0.1 ft

Materials

Fill

Model: Mohr-Coulomb
 Unit Weight: 120 pcf
 Cohesion': 200 psf
 Phi': 33 °
 Phi-B: 0 °

Tmc 100- 25° (A-Bed 20°-34°)

Model: Anisotropic Fn.
 Unit Weight: 120 pcf
 Cohesion': 200 psf
 Phi': 40 °
 Phi-Anisotropic Strength Fn.: Tmc 100- 25° (A-Bed 20°-34°)
 C-Anisotropic Strength Fn.: 100- 25° (A-Bed 20°-34°)
 Phi-B: 0 °

Tmc 150-17° (A-Bed 4°-12°)

Model: Anisotropic Fn.
 Unit Weight: 120 pcf
 Cohesion': 200 psf
 Phi': 40 °
 Phi-Anisotropic Strength Fn.: Tmc 150-17° (A-Bed 4°-12°)
 C-Anisotropic Strength Fn.: 150-17° (A-Bed 4°-12°)
 Phi-B: 0 °

Tmc 100-25° (A- Bed 4°-8°)

Model: Anisotropic Fn.
 Unit Weight: 120 pcf
 Cohesion': 200 psf
 Phi': 40 °
 Phi-Anisotropic Strength Fn.: Tmc 100-25° (A- Bed 4°-8°)
 C-Anisotropic Strength Fn.: 100 (A- Bed4°-8°)
 Phi-B: 0 °

Slip Surface Entry and Exit

Left Projection: Range
 Left-Zone Left Coordinate: (927.8352, 2,117.665) ft
 Left-Zone Right Coordinate: (1,200, 2,135) ft
 Left-Zone Increment: 50

Right Projection: Range
Right-Zone Left Coordinate: (1,300, 2,182.5946) ft
Right-Zone Right Coordinate: (1,923.1499, 2,329.2888) ft
Right-Zone Increment: 50
Radius Increments: 50

Slip Surface Limits

Left Coordinate: (-50, 2,033) ft
Right Coordinate: (2,050, 2,352) ft

Seismic Coefficients

Horz Seismic Coef.: 0
Vert Seismic Coef.: 0

Anisotropic Strength Functions

Tmc 100-25° (A- Bed 4°-8°)

Model: Spline Data Point Function
Function: Modifier Factor vs. Inclination
Curve Fit to Data: 100 %
Segment Curvature: 0 %
Y-Intercept: 1
Data Points: Inclination (°), Modifier Factor
Data Point: (-90, 1)
Data Point: (3.9, 1)
Data Point: (4, 0.625)
Data Point: (8, 0.625)
Data Point: (8.1, 1)

Tmc 100- 25° (A-Bed 20°-34°)

Model: Spline Data Point Function
Function: Modifier Factor vs. Inclination
Curve Fit to Data: 100 %
Segment Curvature: 0 %
Y-Intercept: 1
Data Points: Inclination (°), Modifier Factor
Data Point: (-90, 1)
Data Point: (19.9, 1)
Data Point: (20, 0.625)
Data Point: (34, 0.625)
Data Point: (34.1, 1)

100- 25° (A-Bed 20°-34°)

Model: Spline Data Point Function
Function: Modifier Factor vs. Inclination
Curve Fit to Data: 100 %

Segment Curvature: 0 %
Y-Intercept: 1
Data Points: Inclination (°), Modifier Factor
Data Point: (-90, 1)
Data Point: (19.9, 1)
Data Point: (20, 0.5)
Data Point: (34, 0.5)
Data Point: (34.1, 1)

Tmc 150-17° (A-Bed 4°-12°)

Model: Spline Data Point Function
Function: Modifier Factor vs. Inclination
Curve Fit to Data: 100 %
Segment Curvature: 0 %
Y-Intercept: 1
Data Points: Inclination (°), Modifier Factor
Data Point: (-90, 1)
Data Point: (3.9, 1)
Data Point: (4, 0.425)
Data Point: (12, 0.425)
Data Point: (12.1, 1)

100 (A- Bed4°-8°)

Model: Spline Data Point Function
Function: Modifier Factor vs. Inclination
Curve Fit to Data: 100 %
Segment Curvature: 0 %
Y-Intercept: 1
Data Points: Inclination (°), Modifier Factor
Data Point: (-90, 1)
Data Point: (3.9, 1)
Data Point: (4, 0.5)
Data Point: (8, 0.5)
Data Point: (8.1, 1)

150-17° (A-Bed 4°-12°)

Model: Spline Data Point Function
Function: Modifier Factor vs. Inclination
Curve Fit to Data: 100 %
Segment Curvature: 0 %
Y-Intercept: 1
Data Points: Inclination (°), Modifier Factor
Data Point: (-90, 1)
Data Point: (3.9, 1)
Data Point: (4, 0.75)
Data Point: (12, 0.75)
Data Point: (12.1, 1)

Points



	X (ft)	Y (ft)
Point 1	-50	2,033
Point 2	118	2,039
Point 3	296	2,045
Point 4	360	2,081
Point 5	373	2,081
Point 6	403	2,097
Point 7	416	2,097
Point 8	437	2,110
Point 9	505	2,110
Point 10	700	2,109
Point 11	831	2,106
Point 12	862	2,117
Point 13	1,060	2,119
Point 14	1,163	2,117
Point 15	1,163	2,121
Point 16	1,192	2,135
Point 17	1,202	2,135
Point 18	1,218	2,146
Point 19	1,234	2,145
Point 20	1,271	2,163
Point 21	1,295	2,174
Point 22	1,327	2,182
Point 23	1,369	2,192
	1,412	2,200

Point 24		
Point 25	1,429	2,201
Point 26	1,462	2,207
Point 27	1,582	2,236
Point 28	1,631	2,240
Point 29	1,713	2,261
Point 30	1,859	2,311
Point 31	1,895	2,322
Point 32	2,007	2,351
Point 33	2,036	2,353
Point 34	2,050	2,352
Point 35	2,050	2,100
Point 36	-50	1,914.8161
Point 37	1,250	2,164
Point 38	1,308	2,188
Point 39	1,335	2,189
Point 40	1,347	2,194
Point 41	1,359	2,194
Point 42	1,410	2,223
Point 43	1,425	2,223
Point 44	1,476	2,249
Point 45	1,586	2,253
Point 46	549	2,109.7744
Point 47	863	2,017

Point 48	1,089	2,117
Point 49	-50	1,996
Point 50	625	2,087.3194
Point 51	863	1,994
Point 52	2,049	1,580
Point 53	-50	1,580
Point 54	1,007.64	2,081
Point 55	2,050	2,230
Point 56	1,260	2,157.3607
Point 57	1,168	2,112
Point 58	1,188	2,112
Point 59	1,313	2,178.5
Point 60	1,276.0361	2,158.8352

Regions

	Material	Points	Area (ft²)
Region 1	Fill	46,50,47,54,48,13,12,11,10	25,797
Region 2	Tmc 100-25° (A- Bed 4°-8°)	49,50,46,9,8,7,6,5,4,3,2,1	16,398
Region 3	Tmc 100- 25° (A-Bed 20° -34°)	47,50,49,36,51	82,160
Region 4	Tmc 150-17° (A-Bed 4° -12°)	36,51,35,52,53	8.959e+005
Region 5	Tmc 100- 25° (A-Bed 20° -34°)	51,35,55,60,58,57,14,48,54,47	1.3322e+005
Region 6	Tmc 100-25° (A- Bed 4°-8°)	55,34,33,32,31,30,29,28,27,26,25,24,23,22,59,60	49,472
Region 7	Fill	18,19,56,20,37	372.83

Region 8	Fill	22,23,24,25,26,27,28,29,45,44,43,42,41,40,39,38,20,21,59	7,527
Region 9	Fill	14,57,58,60,59,21,20,56,19,18,17,16,15	1,578.4

Current Slip Surface

Slip Surface: 109,307
 F of S: 1.68
 Volume: 1,809.91 ft³
 Weight: 217,189.2 lbs
 Resisting Moment: 33,555,141 lbs-ft
 Activating Moment: 20,003,789 lbs-ft
 F of S Rank (Analysis): 1 of 132,651 slip surfaces
 F of S Rank (Query): 1 of 100 slip surfaces
 Exit: (1,163, 2,117.0471) ft
 Entry: (1,311.3619, 2,188.1245) ft
 Radius: 237.73425 ft
 Center: (1,140.81, 2,353.7435) ft

Slip Slices

	X (ft)	Y (ft)	PWP (psf)	Base Normal Stress (psf)	Frictional Strength (psf)	Cohesive Strength (psf)
Slice 1	1,165.4167	2,117.2986	0	549.66949	356.95954	200
Slice 2	1,170.25	2,117.8517	0	746.90945	485.04867	200
Slice 3	1,175.0833	2,118.5054	0	929.65523	603.72517	200
Slice 4	1,179.9167	2,119.2606	0	1,098.0953	713.11143	200
Slice 5	1,184.75	2,120.1181	0	1,252.3944	813.3144	200
Slice 6	1,189.5833	2,121.0793	0	1,392.6943	904.42625	200
Slice 7	1,194.5	2,122.1655	0	1,388.1535	901.47742	200
Slice 8	1,199.5	2,123.382	0	1,241.5709	806.28554	200
Slice 9	1,204.6667	2,124.7626	0	1,277.5841	829.67281	200
Slice 10	1,210	2,126.3176	0	1,490.4238	967.89252	200
Slice 11	1,215.3333	2,128.0092	0	1,684.637	1,094.016	200
Slice 12	1,220.6494	2,129.8343	0	1,824.7915	1,185.0334	200
	1,225.9742	2,131.8056	0	2,005.1994	935.03984	100

Slice 13						
Slice 14	1,231.3247	2,133.9338	0	2,084.6151	972.07198	100
Slice 15	1,236.6667	2,136.2105	0	2,146.0572	1,000.7229	100
Slice 16	1,242	2,138.6401	0	2,189.3557	1,020.9133	100
Slice 17	1,247.3333	2,141.2312	0	2,214.3685	1,032.577	100
Slice 18	1,252.5	2,143.8985	0	2,061.6702	961.37258	100
Slice 19	1,257.5	2,146.6377	0	1,735.673	809.35762	100
Slice 20	1,262.75	2,149.6897	0	1,379.9504	643.48142	100
Slice 21	1,268.25	2,153.0796	0	993.29364	463.18043	100
Slice 22	1,273.518	2,156.5204	0	793.48877	370.00989	100
Slice 23	1,276.5501	2,158.5722	0	666.91206	559.60566	200
Slice 24	1,278.3402	2,159.8348	0	657.61914	551.80798	200
Slice 25	1,282.1802	2,162.6365	0	670.39184	435.35755	200
Slice 26	1,287.3081	2,166.5396	0	617.5782	401.05997	200
Slice 27	1,292.436	2,170.6696	0	544.73919	353.75777	200
Slice 28	1,295.9866	2,173.6432	0	484.76012	314.8069	200
Slice 29	1,299.7299	2,176.9716	0	405.09049	263.06884	200
Slice 30	1,305.2433	2,182.0906	0	271.17684	176.1043	200
Slice 31	1,309.6809	2,186.428	0	54.655435	35.493655	200

Section 13-13 Seismic Final SSA with key for Skyline Ranch.gsz

Section 13-13 Seismic Final SSA with key for Skyline Ranch.gsz Run By: Dr. Alexander Bykovtsev, Ph.D., P.E. 3/22/2016 12:06:01 PM

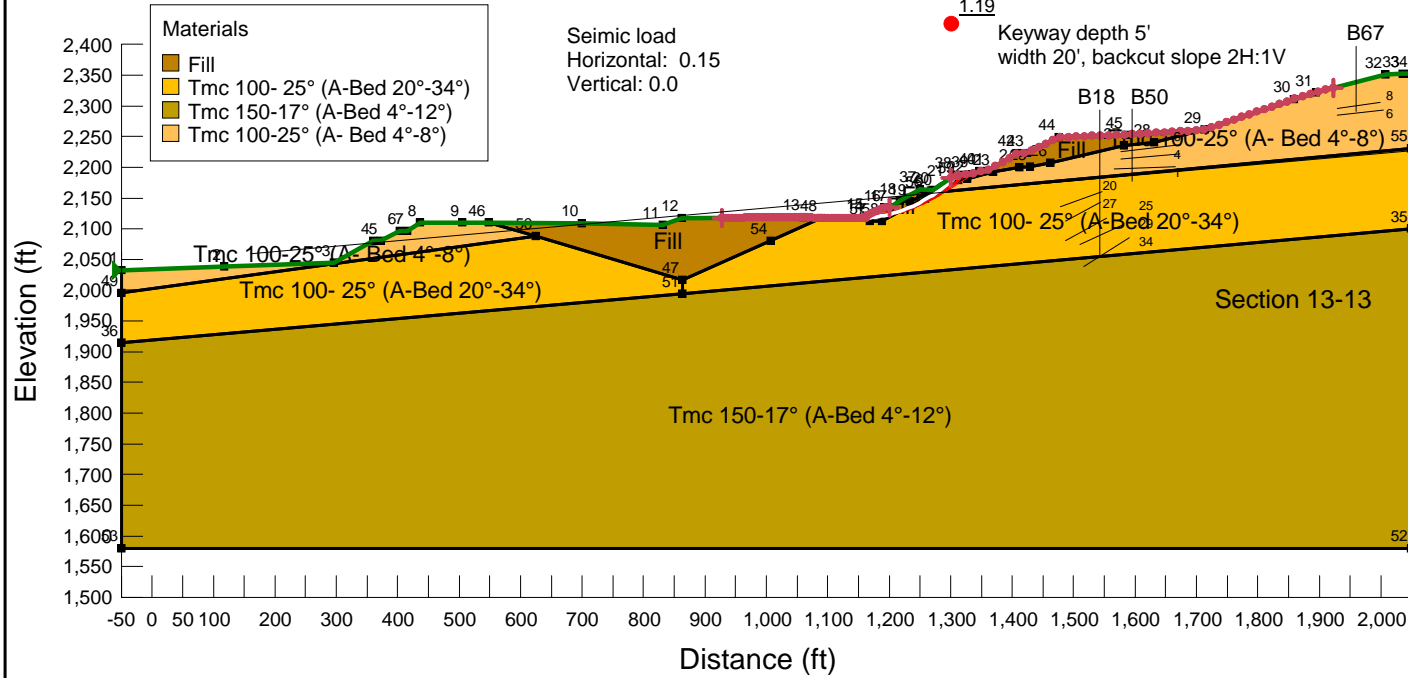

Name: Fill
Model: Mohr-Coulomb
Unit Weight: 120 pcf
Cohesion': 200 psf
Phi': 33 °

Name: Tmc 100- 25° (A-Bed 20°-34°)
Model: Anisotropic Fn.
Unit Weight: 120 pcf
Cohesion': 200 psf
Phi': 40 °
Phi-Anisotropic Strength Fn.: Tmc 100- 25° (A-Bed 20°-34°)
C-Anisotropic Strength Fn.: 100- 25° (A-Bed 20°-34°)

Name: Tmc 150-17° (A-Bed 4°-12°)
Model: Anisotropic Fn.
Unit Weight: 120 pcf
Cohesion': 200 psf
Phi': 40 °
Phi-Anisotropic Strength Fn.: Tmc 150-17° (A-Bed 4°-12°)
C-Anisotropic Strength Fn.: 150-17° (A-Bed 4°-12°)

Name: Tmc 100-25° (A- Bed 4°-8°)
Model: Anisotropic Fn.
Unit Weight: 120 pcf
Cohesion': 200 psf
Phi': 40 °
Phi-Anisotropic Strength Fn.: Tmc 100-25° (A- Bed 4°-8°)
C-Anisotropic Strength Fn.: 100 (A- Bed4°-8°)



LGC Valley, Inc
GEOTECHNICAL CONSULTING
28532 Constellation Road, Valencia, CA 91355
Phone 661-702-8474, Fax 661-702-8475

Skyline Ranch
Development project, Tract 60922
Los Angeles CA

Project No: **153035-01**
Engineer: **BAS**
Date: **March 2016**

1 - Circular Mode of Failure

Report generated using GeoStudio 2012. Copyright © 1991-2015 GEO-SLOPE International Ltd.

File Information

File Version: 8.15
 Title: Static Slope Stability Analyses for Skyline Ranch Development project, Tract 60922, Los Angeles CA
 Comments: Run By: Dr. Alexander Bykovtsev, Ph.D., P.E.
 Last Edited By: Alexander Bykovtsev
 Revision Number: 135
 Date: 3/22/2016
 Time: 12:06:01 PM
 Tool Version: 8.15.1.11236
 File Name: Section 13-13 Seismic Final SSA with key for Skyline Ranch.gsz
 Directory: G:\SLOPE RESULTS\Section 13-13 results\
 Last Solved Date: 3/22/2016
 Last Solved Time: 12:06:33 PM

Project Settings

Length(L) Units: Feet
 Time(t) Units: Seconds
 Force(F) Units: Pounds
 Pressure(p) Units: psf
 Strength Units: psf
 Unit Weight of Water: 62.4 pcf
 View: 2D
 Element Thickness: 1

Analysis Settings

1 - Circular Mode of Failure

Kind: SLOPE/W
 Method: Bishop
 Settings
 PWP Conditions Source: (none)
 Slip Surface
 Direction of movement: Right to Left
 Use Passive Mode: No
 Slip Surface Option: Entry and Exit
 Critical slip surfaces saved: 1
 Resisting Side Maximum Convex Angle: 1 °
 Driving Side Maximum Convex Angle: 5 °
 Optimize Critical Slip Surface Location: No
 Tension Crack
 Tension Crack Option: (none)

F of S Distribution
 F of S Calculation Option: Constant
 Advanced
 Number of Slices: 30
 F of S Tolerance: 0.01
 Minimum Slip Surface Depth: 0.1 ft

Materials

Fill

Model: Mohr-Coulomb
 Unit Weight: 120 pcf
 Cohesion': 200 psf
 Phi': 33 °
 Phi-B: 0 °

Tmc 100- 25° (A-Bed 20°-34°)

Model: Anisotropic Fn.
 Unit Weight: 120 pcf
 Cohesion': 200 psf
 Phi': 40 °
 Phi-Anisotropic Strength Fn.: Tmc 100- 25° (A-Bed 20°-34°)
 C-Anisotropic Strength Fn.: 100- 25° (A-Bed 20°-34°)
 Phi-B: 0 °

Tmc 150-17° (A-Bed 4°-12°)

Model: Anisotropic Fn.
 Unit Weight: 120 pcf
 Cohesion': 200 psf
 Phi': 40 °
 Phi-Anisotropic Strength Fn.: Tmc 150-17° (A-Bed 4°-12°)
 C-Anisotropic Strength Fn.: 150-17° (A-Bed 4°-12°)
 Phi-B: 0 °

Tmc 100-25° (A- Bed 4°-8°)

Model: Anisotropic Fn.
 Unit Weight: 120 pcf
 Cohesion': 200 psf
 Phi': 40 °
 Phi-Anisotropic Strength Fn.: Tmc 100-25° (A- Bed 4°-8°)
 C-Anisotropic Strength Fn.: 100 (A- Bed4°-8°)
 Phi-B: 0 °

Slip Surface Entry and Exit

Left Projection: Range
 Left-Zone Left Coordinate: (927.8352, 2,117.665) ft
 Left-Zone Right Coordinate: (1,200, 2,135) ft
 Left-Zone Increment: 50

Right Projection: Range
Right-Zone Left Coordinate: (1,300, 2,182.5946) ft
Right-Zone Right Coordinate: (1,923.1499, 2,329.2888) ft
Right-Zone Increment: 50
Radius Increments: 50

Slip Surface Limits

Left Coordinate: (-50, 2,033) ft
Right Coordinate: (2,050, 2,352) ft

Seismic Coefficients

Horz Seismic Coef.: 0.15
Vert Seismic Coef.: 0

Anisotropic Strength Functions

Tmc 100-25° (A- Bed 4°-8°)

Model: Spline Data Point Function
Function: Modifier Factor vs. Inclination
Curve Fit to Data: 100 %
Segment Curvature: 0 %
Y-Intercept: 1
Data Points: Inclination (°), Modifier Factor
Data Point: (-90, 1)
Data Point: (3.9, 1)
Data Point: (4, 0.625)
Data Point: (8, 0.625)
Data Point: (8.1, 1)

Tmc 100- 25° (A-Bed 20°-34°)

Model: Spline Data Point Function
Function: Modifier Factor vs. Inclination
Curve Fit to Data: 100 %
Segment Curvature: 0 %
Y-Intercept: 1
Data Points: Inclination (°), Modifier Factor
Data Point: (-90, 1)
Data Point: (19.9, 1)
Data Point: (20, 0.625)
Data Point: (34, 0.625)
Data Point: (34.1, 1)

100- 25° (A-Bed 20°-34°)

Model: Spline Data Point Function
Function: Modifier Factor vs. Inclination
Curve Fit to Data: 100 %

Segment Curvature: 0 %
Y-Intercept: 1
Data Points: Inclination (°), Modifier Factor
Data Point: (-90, 1)
Data Point: (19.9, 1)
Data Point: (20, 0.5)
Data Point: (34, 0.5)
Data Point: (34.1, 1)

Tmc 150-17° (A-Bed 4°-12°)

Model: Spline Data Point Function
Function: Modifier Factor vs. Inclination
Curve Fit to Data: 100 %
Segment Curvature: 0 %
Y-Intercept: 1
Data Points: Inclination (°), Modifier Factor
Data Point: (-90, 1)
Data Point: (3.9, 1)
Data Point: (4, 0.425)
Data Point: (12, 0.425)
Data Point: (12.1, 1)

100 (A- Bed4°-8°)

Model: Spline Data Point Function
Function: Modifier Factor vs. Inclination
Curve Fit to Data: 100 %
Segment Curvature: 0 %
Y-Intercept: 1
Data Points: Inclination (°), Modifier Factor
Data Point: (-90, 1)
Data Point: (3.9, 1)
Data Point: (4, 0.5)
Data Point: (8, 0.5)
Data Point: (8.1, 1)

150-17° (A-Bed 4°-12°)

Model: Spline Data Point Function
Function: Modifier Factor vs. Inclination
Curve Fit to Data: 100 %
Segment Curvature: 0 %
Y-Intercept: 1
Data Points: Inclination (°), Modifier Factor
Data Point: (-90, 1)
Data Point: (3.9, 1)
Data Point: (4, 0.75)
Data Point: (12, 0.75)
Data Point: (12.1, 1)

Points



	X (ft)	Y (ft)
Point 1	-50	2,033
Point 2	118	2,039
Point 3	296	2,045
Point 4	360	2,081
Point 5	373	2,081
Point 6	403	2,097
Point 7	416	2,097
Point 8	437	2,110
Point 9	505	2,110
Point 10	700	2,109
Point 11	831	2,106
Point 12	862	2,117
Point 13	1,060	2,119
Point 14	1,163	2,117
Point 15	1,163	2,121
Point 16	1,192	2,135
Point 17	1,202	2,135
Point 18	1,218	2,146
Point 19	1,234	2,145
Point 20	1,271	2,163
Point 21	1,295	2,174
Point 22	1,327	2,182
Point 23	1,369	2,192
	1,412	2,200

Point 24		
Point 25	1,429	2,201
Point 26	1,462	2,207
Point 27	1,582	2,236
Point 28	1,631	2,240
Point 29	1,713	2,261
Point 30	1,859	2,311
Point 31	1,895	2,322
Point 32	2,007	2,351
Point 33	2,036	2,353
Point 34	2,050	2,352
Point 35	2,050	2,100
Point 36	-50	1,914.8161
Point 37	1,250	2,164
Point 38	1,308	2,188
Point 39	1,335	2,189
Point 40	1,347	2,194
Point 41	1,359	2,194
Point 42	1,410	2,223
Point 43	1,425	2,223
Point 44	1,476	2,249
Point 45	1,586	2,253
Point 46	549	2,109.7744
Point 47	863	2,017

Point 48	1,089	2,117
Point 49	-50	1,996
Point 50	625	2,087.3194
Point 51	863	1,994
Point 52	2,049	1,580
Point 53	-50	1,580
Point 54	1,007.64	2,081
Point 55	2,050	2,230
Point 56	1,260	2,157.3607
Point 57	1,168	2,112
Point 58	1,188	2,112
Point 59	1,313	2,178.5
Point 60	1,276.0361	2,158.8352

Regions

	Material	Points	Area (ft²)
Region 1	Fill	46,50,47,54,48,13,12,11,10	25,797
Region 2	Tmc 100-25° (A- Bed 4°-8°)	49,50,46,9,8,7,6,5,4,3,2,1	16,398
Region 3	Tmc 100- 25° (A-Bed 20° -34°)	47,50,49,36,51	82,160
Region 4	Tmc 150-17° (A-Bed 4° -12°)	36,51,35,52,53	8.959e+005
Region 5	Tmc 100- 25° (A-Bed 20° -34°)	51,35,55,60,58,57,14,48,54,47	1.3322e+005
Region 6	Tmc 100-25° (A- Bed 4°-8°)	55,34,33,32,31,30,29,28,27,26,25,24,23,22,59,60	49,472
Region 7	Fill	18,19,56,20,37	372.83

Region 8	Fill	22,23,24,25,26,27,28,29,45,44,43,42,41,40,39,38,20,21,59	7,527
Region 9	Fill	14,57,58,60,59,21,20,56,19,18,17,16,15	1,578.4

Current Slip Surface

Slip Surface: 109,307
 F of S: 1.19
 Volume: 1,809.91 ft³
 Weight: 217,189.2 lbs
 Resisting Moment: 31,921,881 lbs-ft
 Activating Moment: 26,799,449 lbs-ft
 F of S Rank (Analysis): 1 of 132,651 slip surfaces
 F of S Rank (Query): 1 of 100 slip surfaces
 Exit: (1,163, 2,117.0471) ft
 Entry: (1,311.3619, 2,188.1245) ft
 Radius: 237.73425 ft
 Center: (1,140.81, 2,353.7435) ft

Slip Slices

	X (ft)	Y (ft)	PWP (psf)	Base Normal Stress (psf)	Frictional Strength (psf)	Cohesive Strength (psf)
Slice 1	1,165.4167	2,117.2986	0	536.3873	348.33399	200
Slice 2	1,170.25	2,117.8517	0	727.5247	472.46006	200
Slice 3	1,175.0833	2,118.5054	0	903.38437	586.66467	200
Slice 4	1,179.9167	2,119.2606	0	1,064.2894	691.15761	200
Slice 5	1,184.75	2,120.1181	0	1,210.5317	786.1285	200
Slice 6	1,189.5833	2,121.0793	0	1,342.3745	871.74817	200
Slice 7	1,194.5	2,122.1655	0	1,333.2452	865.81958	200
Slice 8	1,199.5	2,123.382	0	1,187.0504	770.87955	200
Slice 9	1,204.6667	2,124.7626	0	1,217.2142	790.46816	200
Slice 10	1,210	2,126.3176	0	1,416.6076	919.95575	200
Slice 11	1,215.3333	2,128.0092	0	1,596.9446	1,037.0679	200
Slice 12	1,220.6494	2,129.8343	0	1,724.6363	1,119.9919	200
	1,225.9742	2,131.8056	0	1,921.5658	896.04083	100

Slice 13						
Slice 14	1,231.3247	2,133.9338	0	1,992.5326	929.13323	100
Slice 15	1,236.6667	2,136.2105	0	2,045.8591	953.99979	100
Slice 16	1,242	2,138.6401	0	2,081.4956	970.61735	100
Slice 17	1,247.3333	2,141.2312	0	2,099.4124	978.97206	100
Slice 18	1,252.5	2,143.8985	0	1,948.4264	908.56613	100
Slice 19	1,257.5	2,146.6377	0	1,633.9893	761.94173	100
Slice 20	1,262.75	2,149.6897	0	1,292.7285	602.80921	100
Slice 21	1,268.25	2,153.0796	0	923.90126	430.82223	100
Slice 22	1,273.518	2,156.5204	0	732.84731	341.73231	100
Slice 23	1,276.5501	2,158.5722	0	580.98647	487.50553	200
Slice 24	1,278.3402	2,159.8348	0	571.45265	479.50571	200
Slice 25	1,282.1802	2,162.6365	0	589.23793	382.65558	200
Slice 26	1,287.3081	2,166.5396	0	537.68794	349.17863	200
Slice 27	1,292.436	2,170.6696	0	468.17483	304.03629	200
Slice 28	1,295.9866	2,173.6432	0	411.62717	267.31381	200
Slice 29	1,299.7299	2,176.9716	0	337.38954	219.10333	200
Slice 30	1,305.2433	2,182.0906	0	213.82023	138.85648	200
Slice 31	1,309.6809	2,186.428	0	17.499119	11.36406	200

Section 13-13 Static Final SSA with key for Skyline Ranch.gsz

Section 13-13 Static Final SSA with key for Skyline Ranch.gsz Run By: Dr. Alexander Bykovtsev, Ph.D., P.E. 3/22/2016 12:10:09 PM

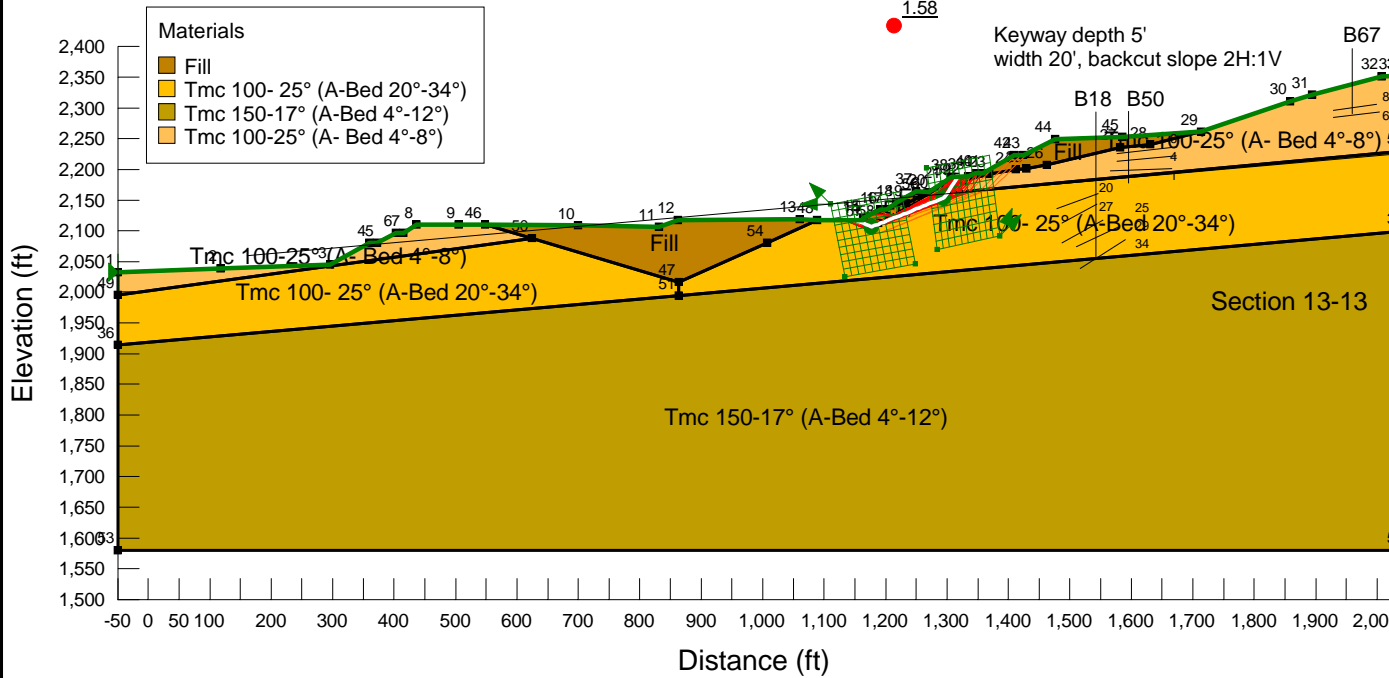

- Name: Fill
Model: Mohr-Coulomb
Unit Weight: 120 pcf
Cohesion: 200 psf
Phi: 33 °
- Name: Tmc 100- 25° (A-Bed 20°-34°)
Model: Anisotropic Fn.
Unit Weight: 120 pcf
Cohesion: 200 psf
Phi: 40 °
Phi-Anisotropic Strength Fn.: Tmc 100- 25° (A-Bed 20°-34°)
C-Anisotropic Strength Fn.: 100- 25° (A-Bed 20°-34°)
- Name: Tmc 150-17° (A-Bed 4°-12°)
Model: Anisotropic Fn.
Unit Weight: 120 pcf
Cohesion: 200 psf
Phi: 40 °
Phi-Anisotropic Strength Fn.: Tmc 150-17° (A-Bed 4°-12°)
C-Anisotropic Strength Fn.: 150-17° (A-Bed 4°-12°)
- Name: Tmc 100-25° (A- Bed 4°-8°)
Model: Anisotropic Fn.
Unit Weight: 120 pcf
Cohesion: 200 psf
Phi: 40 °
Phi-Anisotropic Strength Fn.: Tmc 100-25° (A- Bed 4°-8°)
C-Anisotropic Strength Fn.: 100 (A- Bed4°-8°)

LGC **LGC Valley, Inc**
 GEOTECHNICAL CONSULTING
 28532 Constellation Road, Valencia, CA 91355
 Phone 661-702-8474, Fax 661-702-8475

Skyline Ranch
 Development project, Tract 60922
 Los Angeles CA

Project No: **153035-01**
 Engineer: **BAS**
 Date: **March 2016**

2 - Translational

Report generated using GeoStudio 2012. Copyright © 1991-2015 GEO-SLOPE International Ltd.

File Information

File Version: 8.15
 Title: Static Slope Stability Analyses for Skyline Ranch Development project, Tract 60922, Los Angeles CA
 Comments: Run By: Dr. Alexander Bykovtsev, Ph.D., P.E.
 Last Edited By: Alexander Bykovtsev
 Revision Number: 137
 Date: 3/22/2016
 Time: 12:10:09 PM
 Tool Version: 8.15.1.11236
 File Name: Section 13-13 Static Final SSA with key for Skyline Ranch.gsz
 Directory: G:\SLOPE RESULTS\Section 13-13 results\
 Last Solved Date: 3/22/2016
 Last Solved Time: 12:10:33 PM

Project Settings

Length(L) Units: Feet
 Time(t) Units: Seconds
 Force(F) Units: Pounds
 Pressure(p) Units: psf
 Strength Units: psf
 Unit Weight of Water: 62.4 pcf
 View: 2D
 Element Thickness: 1

Analysis Settings

2 - Translational

Kind: SLOPE/W
 Method: Janbu
 Settings
 PWP Conditions Source: (none)
 Slip Surface
 Direction of movement: Right to Left
 Use Passive Mode: No
 Slip Surface Option: Block
 Critical slip surfaces saved: 10
 Resisting Side Maximum Convex Angle: 1 °
 Driving Side Maximum Convex Angle: 5 °
 Restrict Block Crossing: No
 Optimize Critical Slip Surface Location: No
 Tension Crack

Tension Crack Option: (none)
 F of S Distribution
 F of S Calculation Option: Constant
 Advanced
 Number of Slices: 30
 F of S Tolerance: 0.01
 Minimum Slip Surface Depth: 0.1 ft

Materials

Fill

Model: Mohr-Coulomb
 Unit Weight: 120 pcf
 Cohesion': 200 psf
 Phi': 33 °
 Phi-B: 0 °

Tmc 100- 25° (A-Bed 20°-34°)

Model: Anisotropic Fn.
 Unit Weight: 120 pcf
 Cohesion': 200 psf
 Phi': 40 °
 Phi-Anisotropic Strength Fn.: Tmc 100- 25° (A-Bed 20°-34°)
 C-Anisotropic Strength Fn.: 100- 25° (A-Bed 20°-34°)
 Phi-B: 0 °

Tmc 150-17° (A-Bed 4°-12°)

Model: Anisotropic Fn.
 Unit Weight: 120 pcf
 Cohesion': 200 psf
 Phi': 40 °
 Phi-Anisotropic Strength Fn.: Tmc 150-17° (A-Bed 4°-12°)
 C-Anisotropic Strength Fn.: 150-17° (A-Bed 4°-12°)
 Phi-B: 0 °

Tmc 100-25° (A- Bed 4°-8°)

Model: Anisotropic Fn.
 Unit Weight: 120 pcf
 Cohesion': 200 psf
 Phi': 40 °
 Phi-Anisotropic Strength Fn.: Tmc 100-25° (A- Bed 4°-8°)
 C-Anisotropic Strength Fn.: 100 (A- Bed4°-8°)
 Phi-B: 0 °

Slip Surface Limits

Left Coordinate: (-50, 2,033) ft
 Right Coordinate: (2,050, 2,352) ft

Slip Surface Block

Left Grid

Upper Left: (1,111, 2,143) ft
 Lower Left: (1,134, 2,025) ft
 Lower Right: (1,248, 2,046) ft
 X Increments: 10
 Y Increments: 10
 Starting Angle: 135 °
 Ending Angle: 180 °
 Angle Increments: 2

Right Grid

Upper Left: (1,266.6877, 2,201.9943) ft
 Lower Left: (1,284.7124, 2,069.4062) ft
 Lower Right: (1,386.5849, 2,091.0405) ft
 X Increments: 10
 Y Increments: 10
 Starting Angle: 45 °
 Ending Angle: 65 °
 Angle Increments: 2

Seismic Coefficients

Horz Seismic Coef.: 0
 Vert Seismic Coef.: 0

Anisotropic Strength Functions

Tmc 100-25° (A- Bed 4°-8°)

Model: Spline Data Point Function
 Function: Modifier Factor vs. Inclination
 Curve Fit to Data: 100 %
 Segment Curvature: 0 %

Y-Intercept: 1

Data Points: Inclination (°), Modifier Factor
 Data Point: (-90, 1)
 Data Point: (3.9, 1)
 Data Point: (4, 0.625)
 Data Point: (8, 0.625)
 Data Point: (8.1, 1)

Tmc 100- 25° (A-Bed 20°-34°)

Model: Spline Data Point Function
 Function: Modifier Factor vs. Inclination
 Curve Fit to Data: 100 %
 Segment Curvature: 0 %

Y-Intercept: 1

Data Points: Inclination (°), Modifier Factor
 Data Point: (-90, 1)

Data Point: (19.9, 1)
 Data Point: (20, 0.625)
 Data Point: (34, 0.625)
 Data Point: (34.1, 1)

100- 25° (A-Bed 20°-34°)

Model: Spline Data Point Function
 Function: Modifier Factor vs. Inclination
 Curve Fit to Data: 100 %
 Segment Curvature: 0 %

Y-Intercept: 1

Data Points: Inclination (°), Modifier Factor
 Data Point: (-90, 1)
 Data Point: (19.9, 1)
 Data Point: (20, 0.5)
 Data Point: (34, 0.5)
 Data Point: (34.1, 1)

Tmc 150-17° (A-Bed 4°-12°)

Model: Spline Data Point Function
 Function: Modifier Factor vs. Inclination
 Curve Fit to Data: 100 %
 Segment Curvature: 0 %

Y-Intercept: 1

Data Points: Inclination (°), Modifier Factor
 Data Point: (-90, 1)
 Data Point: (3.9, 1)
 Data Point: (4, 0.425)
 Data Point: (12, 0.425)
 Data Point: (12.1, 1)

100 (A- Bed4°-8°)

Model: Spline Data Point Function
 Function: Modifier Factor vs. Inclination
 Curve Fit to Data: 100 %
 Segment Curvature: 0 %

Y-Intercept: 1

Data Points: Inclination (°), Modifier Factor
 Data Point: (-90, 1)
 Data Point: (3.9, 1)
 Data Point: (4, 0.5)
 Data Point: (8, 0.5)
 Data Point: (8.1, 1)

150-17° (A-Bed 4°-12°)

Model: Spline Data Point Function
 Function: Modifier Factor vs. Inclination
 Curve Fit to Data: 100 %
 Segment Curvature: 0 %

Y-Intercept: 1

Data Points: Inclination (°), Modifier Factor

Data Point: (-90, 1)

Data Point: (3.9, 1)

Data Point: (4, 0.75)

Data Point: (12, 0.75)

Data Point: (12.1, 1)

Points

	X (ft)	Y (ft)
Point 1	-50	2,033
Point 2	118	2,039
Point 3	296	2,045
Point 4	360	2,081
Point 5	373	2,081
Point 6	403	2,097
Point 7	416	2,097
Point 8	437	2,110
Point 9	505	2,110
Point 10	700	2,109
Point 11	831	2,106
Point 12	862	2,117
Point 13	1,060	2,119
Point 14	1,163	2,117
Point 15	1,163	2,121
Point 16	1,192	2,135
Point 17	1,202	2,135
Point 18	1,218	2,146
Point 19	1,234	2,145
Point 20	1,271	2,163
Point 21	1,295	2,174
Point 22	1,327	2,182
Point 23	1,369	2,192
Point 24	1,412	2,200
Point 25	1,429	2,201
Point 26	1,462	2,207
Point 27	1,582	2,236
Point 28	1,631	2,240
Point 29	1,713	2,261
Point 30	1,859	2,311
Point 31	1,895	2,322
Point 32	2,007	2,351
Point 33	2,036	2,353
Point 34	2,050	2,352
Point 35	2,050	2,100

Point 36	-50	1,914.8161
Point 37	1,250	2,164
Point 38	1,308	2,188
Point 39	1,335	2,189
Point 40	1,347	2,194
Point 41	1,359	2,194
Point 42	1,410	2,223
Point 43	1,425	2,223
Point 44	1,476	2,249
Point 45	1,586	2,253
Point 46	549	2,109.7744
Point 47	863	2,017
Point 48	1,089	2,117
Point 49	-50	1,996
Point 50	625	2,087.3194
Point 51	863	1,994
Point 52	2,049	1,580
Point 53	-50	1,580
Point 54	1,007.64	2,081
Point 55	2,050	2,230
Point 56	1,260	2,157.3607
Point 57	1,168	2,112
Point 58	1,188	2,112
Point 59	1,313	2,178.5

Point 60	1,276.0361	2,158.8352
----------	------------	------------

Regions

Region	Material	Points	Area (ft²)
Region 1	Fill	46,50,47,54,48,13,12,11,10	25,797
Region 2	Tmc 100-25° (A-Bed 4°-8°)	49,50,46,9,8,7,6,5,4,3,2,1	16,398
Region 3	Tmc 100- 25° (A-Bed 20° -34°)	47,50,49,36,51	82,160
Region 4	Tmc 150-17° (A-Bed 4° -12°)	36,51,35,52,53	8.959e+005
Region 5	Tmc 100- 25° (A-Bed 20° -34°)	51,35,55,60,58,57,14,48,54,47	1.3322e+005
Region 6	Tmc 100-25° (A- Bed 4°-8°)	55,34,33,32,31,30,29,28,27,26,25,24,23,22,59,60	49,472
Region 7	Fill	18,19,56,20,37	372.83
Region 8	Fill	22,23,24,25,26,27,28,29,45,44,43,42,41,40,39,38,20,21,59	7,527
Region 9	Fill	14,57,58,60,59,21,20,56,19,18,17,16,15	1,578.4

Current Slip Surface

Slip Surface: 77,888
 F of S: 1.58
 Volume: 3,321.8473 ft³
 Weight: 398,621.67 lbs
 Resisting Force: 207,769.45 lbs
 Activating Force: 131,647.76 lbs
 F of S Rank (Analysis): 1 of 131,769 slip surfaces
 F of S Rank (Query): 1 of 100 slip surfaces
 Exit: (1,151.3679, 2,117) ft
 Entry: (1,318.8608, 2,188.4023) ft
 Radius: 98.718185 ft
 Center: (1,212.2853, 2,206.2528) ft

Slip Slices

	X (ft)	Y (ft)	PWP (psf)	Base Normal Stress (psf)	Frictional Strength (psf)	Cohesive Strength (psf)
Slice 1	1,154.2759	2,115.7955	0	252.06089	211.5042	200

Slice 2	1,160.092	2,113.3864	0	622.32647	522.19392	200
Slice 3	1,165.5	2,111.1463	0	1,766.8934	1,482.5996	200
Slice 4	1,170.3	2,109.1581	0	2,428.6247	2,037.8581	200
Slice 5	1,174.9	2,107.2527	0	3,062.7838	2,569.9808	200
Slice 6	1,179.9	2,107.3836	0	2,314.4647	1,079.2526	100
Slice 7	1,185.3	2,109.5509	0	2,361.6524	1,101.2566	100
Slice 8	1,190	2,111.4372	0	2,402.7231	1,120.4082	100
Slice 9	1,194.5	2,113.2432	0	2,312.5102	1,078.3412	100
Slice 10	1,199.5	2,115.2499	0	2,097.1304	977.90795	100
Slice 11	1,204.6667	2,117.3235	0	2,071.3426	965.88294	100
Slice 12	1,210	2,119.464	0	2,235.147	1,042.2662	100
Slice 13	1,215.3333	2,121.6045	0	2,398.9514	1,118.6494	100
Slice 14	1,220.6667	2,123.745	0	2,526.9791	1,178.3497	100
Slice 15	1,226	2,125.8855	0	2,619.2302	1,221.3671	100
Slice 16	1,231.3333	2,128.026	0	2,711.4814	1,264.3845	100
Slice 17	1,236.6667	2,130.1665	0	2,803.7325	1,307.4019	100
Slice 18	1,242	2,132.3069	0	2,895.9836	1,350.4193	100
Slice 19	1,247.3333	2,134.4474	0	2,988.2348	1,393.4367	100
Slice 20	1,252.5	2,136.521	0	2,913.8931	1,358.7706	100
Slice 21	1,257.5	2,138.5277	0	2,672.9585	1,246.421	100
Slice 22	1,262.75	2,140.6348	0	2,419.9773	1,128.4539	100
Slice 23	1,268.25	2,142.8422	0	2,154.9493	1,004.8694	100
Slice 24	1,273.518	2,144.9565	0	2,096.5773	977.65006	100
Slice 25	1,279.0754	2,147.1869	0	2,260.21	1,053.9532	100

Slice 26	1,285.1541	2,149.6265	0	2,439.1914	1,137.4136	100
Slice 27	1,291.2327	2,152.0661	0	2,618.1728	1,220.874	100
Slice 28	1,294.636	2,153.8057	0	1,617.1724	1,356.9688	200
Slice 29	1,297.34	2,157.6674	0	1,478.1217	1,240.2913	200
Slice 30	1,303.84	2,166.9503	0	1,143.8597	959.81228	200
Slice 31	1,309.6451	2,175.2409	0	773.52797	649.06703	200
Slice 32	1,311.4949	2,177.8827	0	662.10652	429.977	200
Slice 33	1,315.2802	2,183.2886	0	263.44322	171.08203	200

Section 13-13 Seismic Final SSA with key for Skyline Ranch.gsz

Section 13-13 Seismic Final SSA with key for Skyline Ranch.gsz Run By: Dr. Alexander Bykovtsev, Ph.D., P.E. 3/22/2016 11:59:24 AM

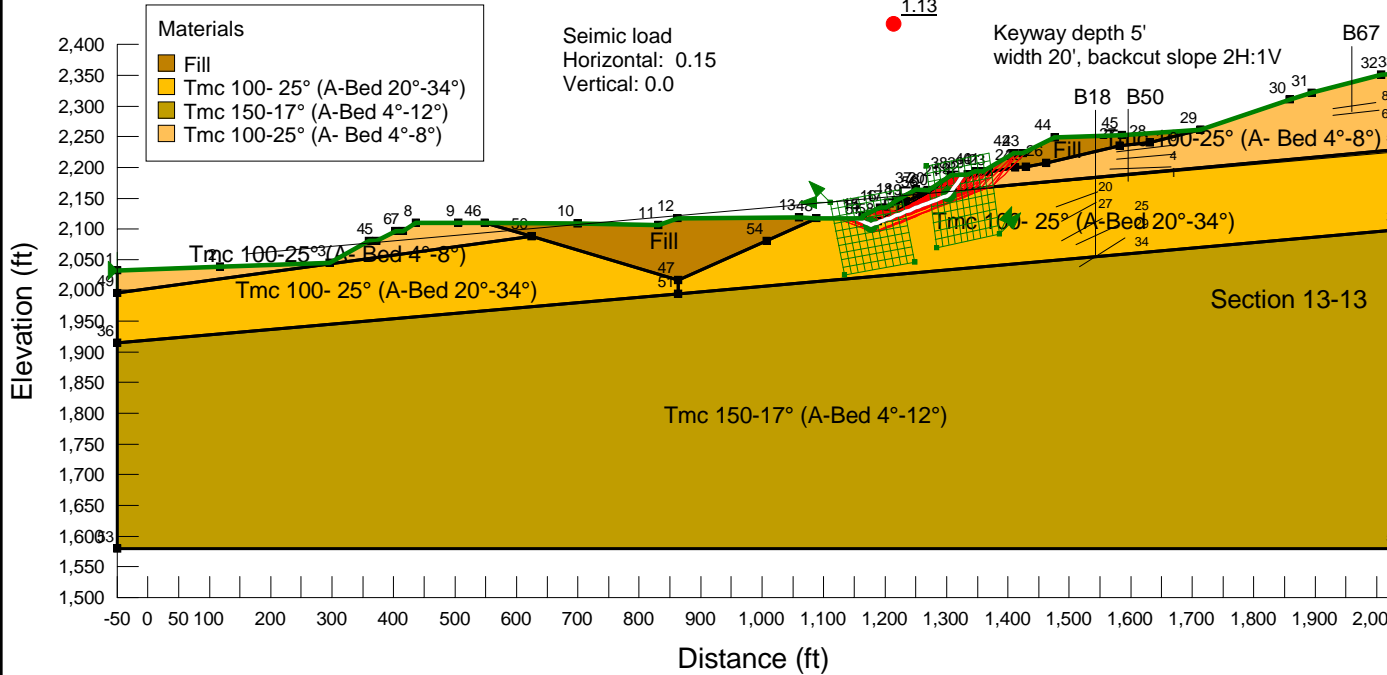

Name: Fill
Model: Mohr-Coulomb
Unit Weight: 120 pcf
Cohesion: 200 psf
Phi: 33 °

Name: Tmc 100- 25° (A-Bed 20°-34°)
Model: Anisotropic Fn.
Unit Weight: 120 pcf
Cohesion: 200 psf
Phi: 40 °
Phi-Anisotropic Strength Fn.: Tmc 100- 25° (A-Bed 20°-34°)
C-Anisotropic Strength Fn.: 100- 25° (A-Bed 20°-34°)

Name: Tmc 150-17° (A-Bed 4°-12°)
Model: Anisotropic Fn.
Unit Weight: 120 pcf
Cohesion: 200 psf
Phi: 40 °
Phi-Anisotropic Strength Fn.: Tmc 150-17° (A-Bed 4°-12°)
C-Anisotropic Strength Fn.: 150-17° (A-Bed 4°-12°)

Name: Tmc 100-25° (A- Bed 4°-8°)
Model: Anisotropic Fn.
Unit Weight: 120 pcf
Cohesion: 200 psf
Phi: 40 °
Phi-Anisotropic Strength Fn.: Tmc 100-25° (A- Bed 4°-8°)
C-Anisotropic Strength Fn.: 100 (A- Bed 4°-8°)



LGC Valley, Inc

GEOTECHNICAL CONSULTING

28532 Constellation Road, Valencia, CA 91355
Phone 661-702-8474, Fax 661-702-8475

Skyline Ranch
Development project, Tract 60922
Los Angeles CA

Project No: 153035-01
Engineer: BAS
Date: March 2016

2 - Translational

Report generated using GeoStudio 2012. Copyright © 1991-2015 GEO-SLOPE International Ltd.

File Information

File Version: 8.15
 Title: Static Slope Stability Analyses for Skyline Ranch Development project, Tract 60922, Los Angeles CA
 Comments: Run By: Dr. Alexander Bykovtsev, Ph.D., P.E.
 Last Edited By: Alexander Bykovtsev
 Revision Number: 133
 Date: 3/22/2016
 Time: 11:59:24 AM
 Tool Version: 8.15.1.11236
 File Name: Section 13-13 Seismic Final SSA with key for Skyline Ranch.gsz
 Directory: G:\SLOPE RESULTS\Section 13-13 results\
 Last Solved Date: 3/22/2016
 Last Solved Time: 12:00:10 PM

Project Settings

Length(L) Units: Feet
 Time(t) Units: Seconds
 Force(F) Units: Pounds
 Pressure(p) Units: psf
 Strength Units: psf
 Unit Weight of Water: 62.4 pcf
 View: 2D
 Element Thickness: 1

Analysis Settings

2 - Translational

Kind: SLOPE/W
 Method: Janbu
 Settings
 PWP Conditions Source: (none)
 Slip Surface
 Direction of movement: Right to Left
 Use Passive Mode: No
 Slip Surface Option: Block
 Critical slip surfaces saved: 10
 Resisting Side Maximum Convex Angle: 1 °
 Driving Side Maximum Convex Angle: 5 °
 Restrict Block Crossing: No
 Optimize Critical Slip Surface Location: No
 Tension Crack

file:///G:/SLOPE%20RESULTS/Section%2013-13%20results/Latest%20updated%203-22-... 3/22/2016

Tension Crack Option: (none)
 F of S Distribution
 F of S Calculation Option: Constant
 Advanced
 Number of Slices: 30
 F of S Tolerance: 0.01
 Minimum Slip Surface Depth: 0.1 ft

Materials

Fill

Model: Mohr-Coulomb
 Unit Weight: 120 pcf
 Cohesion': 200 psf
 Phi': 33 °
 Phi-B: 0 °

Tmc 100- 25° (A-Bed 20°-34°)

Model: Anisotropic Fn.
 Unit Weight: 120 pcf
 Cohesion': 200 psf
 Phi': 40 °
 Phi-Anisotropic Strength Fn.: Tmc 100- 25° (A-Bed 20°-34°)
 C-Anisotropic Strength Fn.: 100- 25° (A-Bed 20°-34°)
 Phi-B: 0 °

Tmc 150-17° (A-Bed 4°-12°)

Model: Anisotropic Fn.
 Unit Weight: 120 pcf
 Cohesion': 200 psf
 Phi': 40 °
 Phi-Anisotropic Strength Fn.: Tmc 150-17° (A-Bed 4°-12°)
 C-Anisotropic Strength Fn.: 150-17° (A-Bed 4°-12°)
 Phi-B: 0 °

Tmc 100-25° (A- Bed 4°-8°)

Model: Anisotropic Fn.
 Unit Weight: 120 pcf
 Cohesion': 200 psf
 Phi': 40 °
 Phi-Anisotropic Strength Fn.: Tmc 100-25° (A- Bed 4°-8°)
 C-Anisotropic Strength Fn.: 100 (A- Bed4°-8°)
 Phi-B: 0 °

Slip Surface Limits

Left Coordinate: (-50, 2,033) ft
 Right Coordinate: (2,050, 2,352) ft

file:///G:/SLOPE%20RESULTS/Section%2013-13%20results/Latest%20updated%203-22-... 3/22/2016

Slip Surface Block

Left Grid

Upper Left: (1,111, 2,143) ft
 Lower Left: (1,134, 2,025) ft
 Lower Right: (1,248, 2,046) ft
 X Increments: 10
 Y Increments: 10
 Starting Angle: 135 °
 Ending Angle: 180 °
 Angle Increments: 2

Right Grid

Upper Left: (1,266.6877, 2,201.9943) ft
 Lower Left: (1,284.7124, 2,069.4062) ft
 Lower Right: (1,386.5849, 2,091.0405) ft
 X Increments: 10
 Y Increments: 10
 Starting Angle: 45 °
 Ending Angle: 65 °
 Angle Increments: 2

Seismic Coefficients

Horz Seismic Coef.: 0.15
 Vert Seismic Coef.: 0

Anisotropic Strength Functions

Tmc 100-25° (A- Bed 4°-8°)

Model: Spline Data Point Function
 Function: Modifier Factor vs. Inclination
 Curve Fit to Data: 100 %
 Segment Curvature: 0 %

Y-Intercept: 1

Data Points: Inclination (°), Modifier Factor
 Data Point: (-90, 1)
 Data Point: (3.9, 1)
 Data Point: (4, 0.625)
 Data Point: (8, 0.625)
 Data Point: (8.1, 1)

Tmc 100- 25° (A-Bed 20°-34°)

Model: Spline Data Point Function
 Function: Modifier Factor vs. Inclination
 Curve Fit to Data: 100 %
 Segment Curvature: 0 %

Y-Intercept: 1

Data Points: Inclination (°), Modifier Factor
 Data Point: (-90, 1)

Data Point: (19.9, 1)
 Data Point: (20, 0.625)
 Data Point: (34, 0.625)
 Data Point: (34.1, 1)

100- 25° (A-Bed 20°-34°)

Model: Spline Data Point Function
 Function: Modifier Factor vs. Inclination
 Curve Fit to Data: 100 %
 Segment Curvature: 0 %

Y-Intercept: 1

Data Points: Inclination (°), Modifier Factor
 Data Point: (-90, 1)
 Data Point: (19.9, 1)
 Data Point: (20, 0.5)
 Data Point: (34, 0.5)
 Data Point: (34.1, 1)

Tmc 150-17° (A-Bed 4°-12°)

Model: Spline Data Point Function
 Function: Modifier Factor vs. Inclination
 Curve Fit to Data: 100 %
 Segment Curvature: 0 %

Y-Intercept: 1

Data Points: Inclination (°), Modifier Factor
 Data Point: (-90, 1)
 Data Point: (3.9, 1)
 Data Point: (4, 0.425)
 Data Point: (12, 0.425)
 Data Point: (12.1, 1)

100 (A- Bed4°-8°)

Model: Spline Data Point Function
 Function: Modifier Factor vs. Inclination
 Curve Fit to Data: 100 %
 Segment Curvature: 0 %

Y-Intercept: 1

Data Points: Inclination (°), Modifier Factor
 Data Point: (-90, 1)
 Data Point: (3.9, 1)
 Data Point: (4, 0.5)
 Data Point: (8, 0.5)
 Data Point: (8.1, 1)

150-17° (A-Bed 4°-12°)

Model: Spline Data Point Function
 Function: Modifier Factor vs. Inclination
 Curve Fit to Data: 100 %
 Segment Curvature: 0 %

Y-Intercept: 1

Data Points: Inclination (°), Modifier Factor

- Data Point: (-90, 1)
- Data Point: (3.9, 1)
- Data Point: (4, 0.75)
- Data Point: (12, 0.75)
- Data Point: (12.1, 1)

Points

	X (ft)	Y (ft)
Point 1	-50	2,033
Point 2	118	2,039
Point 3	296	2,045
Point 4	360	2,081
Point 5	373	2,081
Point 6	403	2,097
Point 7	416	2,097
Point 8	437	2,110
Point 9	505	2,110
Point 10	700	2,109
Point 11	831	2,106
Point 12	862	2,117
Point 13	1,060	2,119
Point 14	1,163	2,117
Point 15	1,163	2,121
Point 16	1,192	2,135
Point 17	1,202	2,135
Point 18	1,218	2,146
Point 19	1,234	2,145
Point 20	1,271	2,163
Point 21	1,295	2,174
Point 22	1,327	2,182
Point 23	1,369	2,192
Point 24	1,412	2,200
Point 25	1,429	2,201
Point 26	1,462	2,207
Point 27	1,582	2,236
Point 28	1,631	2,240
Point 29	1,713	2,261
Point 30	1,859	2,311
Point 31	1,895	2,322
Point 32	2,007	2,351
Point 33	2,036	2,353
Point 34	2,050	2,352
Point 35	2,050	2,100

Point 36	-50	1,914.8161
Point 37	1,250	2,164
Point 38	1,308	2,188
Point 39	1,335	2,189
Point 40	1,347	2,194
Point 41	1,359	2,194
Point 42	1,410	2,223
Point 43	1,425	2,223
Point 44	1,476	2,249
Point 45	1,586	2,253
Point 46	549	2,109.7744
Point 47	863	2,017
Point 48	1,089	2,117
Point 49	-50	1,996
Point 50	625	2,087.3194
Point 51	863	1,994
Point 52	2,049	1,580
Point 53	-50	1,580
Point 54	1,007.64	2,081
Point 55	2,050	2,230
Point 56	1,260	2,157.3607
Point 57	1,168	2,112
Point 58	1,188	2,112
Point 59	1,313	2,178.5

Point 60	1,276.0361	2,158.8352
----------	------------	------------

Regions

	Material	Points	Area (ft²)
Region 1	Fill	46,50,47,54,48,13,12,11,10	25,797
Region 2	Tmc 100-25° (A-Bed 4°-8°)	49,50,46,9,8,7,6,5,4,3,2,1	16,398
Region 3	Tmc 100- 25° (A-Bed 20° -34°)	47,50,49,36,51	82,160
Region 4	Tmc 150-17° (A-Bed 4° -12°)	36,51,35,52,53	8.959e+005
Region 5	Tmc 100- 25° (A-Bed 20° -34°)	51,35,55,60,58,57,14,48,54,47	1.3322e+005
Region 6	Tmc 100-25° (A- Bed 4°-8°)	55,34,33,32,31,30,29,28,27,26,25,24,23,22,59,60	49,472
Region 7	Fill	18,19,56,20,37	372.83
Region 8	Fill	22,23,24,25,26,27,28,29,45,44,43,42,41,40,39,38,20,21,59	7,527
Region 9	Fill	14,57,58,60,59,21,20,56,19,18,17,16,15	1,578.4

Current Slip Surface

Slip Surface: 77,891
 F of S: 1.13
 Volume: 3,731.129 ft³
 Weight: 447,735.48 lbs
 Resisting Force: 224,668.02 lbs
 Activating Force: 198,819.85 lbs
 F of S Rank (Analysis): 1 of 131,769 slip surfaces
 F of S Rank (Query): 1 of 100 slip surfaces
 Exit: (1,151.3679, 2,117) ft
 Entry: (1,327.7641, 2,188.732) ft
 Radius: 100.80246 ft
 Center: (1,217.6885, 2,206.665) ft

Slip Slices

	X (ft)	Y (ft)	PWP (psf)	Base Normal Stress (psf)	Frictional Strength (psf)	Cohesive Strength (psf)
Slice 1	1,154.2759	2,115.7955	0	313.80973	263.31763	200

Slice 2	1,160.092	2,113.3864	0	730.69628	613.12698	200
Slice 3	1,165.5	2,111.1463	0	2,019.3782	1,694.4595	200
Slice 4	1,170.3	2,109.1581	0	2,764.4296	2,319.6318	200
Slice 5	1,174.9	2,107.2527	0	3,478.4371	2,918.7553	200
Slice 6	1,179.9	2,107.3428	0	2,229.6729	1,039.7135	100
Slice 7	1,185.3	2,109.4283	0	2,283.6585	1,064.8875	100
Slice 8	1,190	2,111.2435	0	2,330.6461	1,086.7981	100
Slice 9	1,194.5	2,112.9815	0	2,250.658	1,049.499	100
Slice 10	1,199.5	2,114.9126	0	2,050.6923	956.25353	100
Slice 11	1,204.6667	2,116.908	0	2,033.9059	948.42592	100
Slice 12	1,210	2,118.9678	0	2,200.2988	1,026.0162	100
Slice 13	1,215.3333	2,121.0276	0	2,366.6917	1,103.6065	100
Slice 14	1,220.6667	2,123.0874	0	2,498.5673	1,165.1011	100
Slice 15	1,226	2,125.1472	0	2,595.9257	1,210.5	100
Slice 16	1,231.3333	2,127.2071	0	2,693.2841	1,255.899	100
Slice 17	1,236.6667	2,129.2669	0	2,790.6425	1,301.298	100
Slice 18	1,242	2,131.3267	0	2,888.001	1,346.697	100
Slice 19	1,247.3333	2,133.3865	0	2,985.3594	1,392.0959	100
Slice 20	1,252.5	2,135.3819	0	2,921.7282	1,362.4242	100
Slice 21	1,257.5	2,137.313	0	2,697.1074	1,257.6818	100
Slice 22	1,262.75	2,139.3406	0	2,461.2555	1,147.7023	100
Slice 23	1,268.25	2,141.4648	0	2,214.1727	1,032.4857	100
Slice 24	1,273.518	2,143.4994	0	2,166.1078	1,010.0727	100
Slice 25	1,279.1968	2,145.6926	0	2,336.3225	1,089.4451	100

Slice 26	1,285.518	2,148.134	0	2,525.7987	1,177.7993	100
Slice 27	1,291.8394	2,150.5753	0	2,715.2748	1,266.1534	100
Slice 28	1,297.3648	2,152.7094	0	2,880.8969	1,343.3843	100
Slice 29	1,302.0945	2,154.536	0	3,022.665	1,409.4918	100
Slice 30	1,306.2297	2,157.9776	0	1,559.2192	1,308.3402	200
Slice 31	1,308.4746	2,161.1837	0	1,442.9885	1,210.8111	200
Slice 32	1,310.9746	2,164.7541	0	1,240.098	1,040.5658	200
Slice 33	1,315.303	2,170.9358	0	888.81685	745.80589	200
Slice 34	1,319.9091	2,177.514	0	515.00429	432.13991	200
Slice 35	1,324.9881	2,184.7675	0	116.32431	75.541893	200

Section 13-13 Static Temporary Final SSA without key for Skyline Ranch.gsz

Section 13-13 Static Temporary Final SSA without key for Skyline Ranch.gsz Run By: Dr. Alexander Bykovtsev, Ph.D., P.E. 3/22/2016 12:20:39 PM

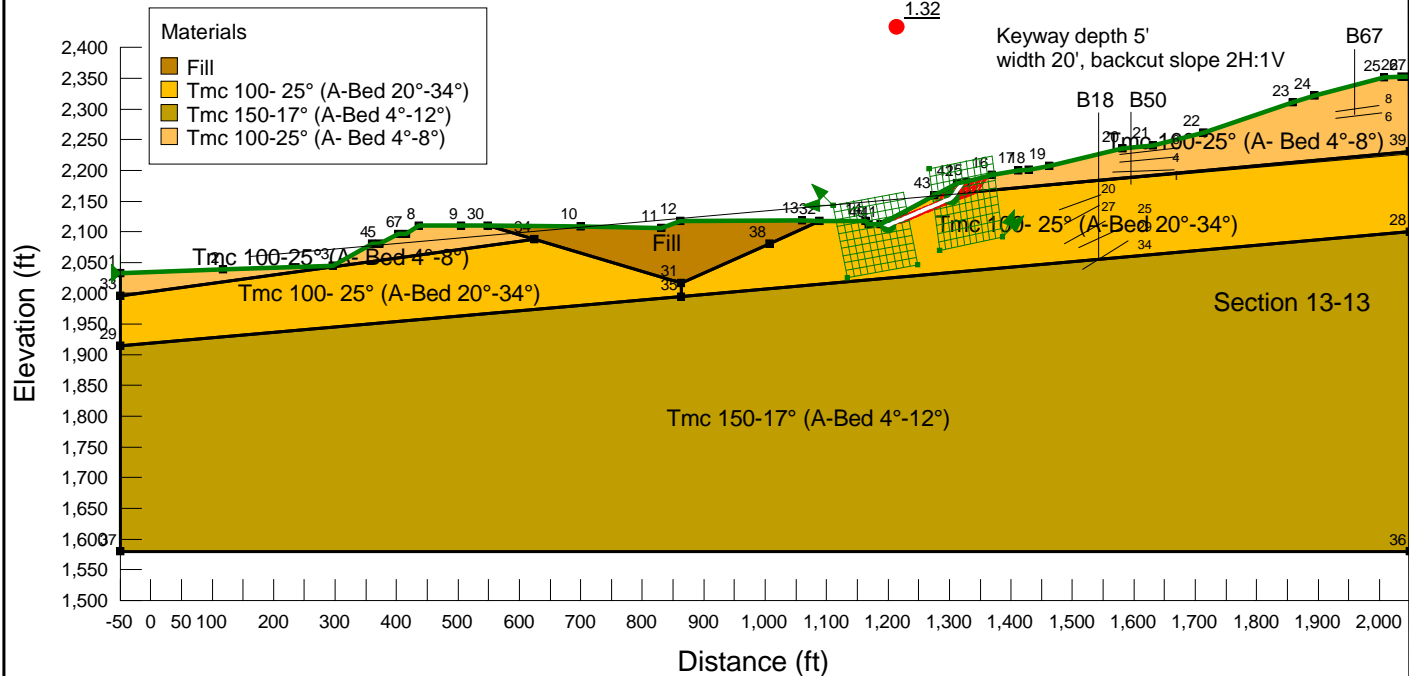

Name: Fill
 Model: Mohr-Coulomb
 Unit Weight: 120 pcf
 Cohesion: 200 psf
 Phi: 33 °

Name: Tmc 100- 25° (A-Bed 20°-34°)
 Model: Anisotropic Fn.
 Unit Weight: 120 pcf
 Cohesion: 200 psf
 Phi: 40 °
 Phi-Anisotropic Strength Fn.: Tmc 100- 25° (A-Bed 20°-34°)
 C-Anisotropic Strength Fn.: 100- 25° (A-Bed 20°-34°)

Name: Tmc 150-17° (A-Bed 4°-12°)
 Model: Anisotropic Fn.
 Unit Weight: 120 pcf
 Cohesion: 200 psf
 Phi: 40 °
 Phi-Anisotropic Strength Fn.: Tmc 150-17° (A-Bed 4°-12°)
 C-Anisotropic Strength Fn.: 150-17° (A-Bed 4°-12°)

Name: Tmc 100-25° (A- Bed 4°-8°)
 Model: Anisotropic Fn.
 Unit Weight: 120 pcf
 Cohesion: 200 psf
 Phi: 40 °
 Phi-Anisotropic Strength Fn.: Tmc 100-25° (A- Bed 4°-8°)
 C-Anisotropic Strength Fn.: 100 (A- Bed 4°-8°)

LGC Valley, Inc
 GEOTECHNICAL CONSULTING
 28532 Constellation Road, Valencia, CA 91355
 Phone 661-702-8474, Fax 661-702-8475

Skyline Ranch
 Development project, Tract 60922
 Los Angeles CA

Project No: 153035-01
 Engineer: BAS
 Date: March 2016

2 - Translational

Report generated using GeoStudio 2012. Copyright © 1991-2015 GEO-SLOPE International Ltd.

File Information

File Version: 8.15
 Title: Static Slope Stability Analyses for Skyline Ranch Development project, Tract 60922, Los Angeles CA
 Comments: Run By: Dr. Alexander Bykovtsev, Ph.D., P.E.
 Last Edited By: Alexander Bykovtsev
 Revision Number: 139
 Date: 3/22/2016
 Time: 12:20:39 PM
 Tool Version: 8.15.1.11236
 File Name: Section 13-13 Static Temporary Final SSA without key for Skyline Ranch.gsz
 Directory: G:\SLOPE RESULTS\Section 13-13 results\
 Last Solved Date: 3/22/2016
 Last Solved Time: 12:25:22 PM

Project Settings

Length(L) Units: Feet
 Time(t) Units: Seconds
 Force(F) Units: Pounds
 Pressure(p) Units: psf
 Strength Units: psf
 Unit Weight of Water: 62.4 pcf
 View: 2D
 Element Thickness: 1

Analysis Settings

2 - Translational

Kind: [SLOPE/W](#)
 Method: [Janbu](#)
 Settings
 PWP Conditions Source: [\(none\)](#)
 Slip Surface
 Direction of movement: [Right to Left](#)
 Use Passive Mode: [No](#)
 Slip Surface Option: [Block](#)
 Critical slip surfaces saved: [10](#)
 Resisting Side Maximum Convex Angle: [1 °](#)
 Driving Side Maximum Convex Angle: [5 °](#)
 Restrict Block Crossing: [No](#)
 Optimize Critical Slip Surface Location: [No](#)
 Tension Crack

Tension Crack Option: [\(none\)](#)
 F of S Distribution
 F of S Calculation Option: [Constant](#)
 Advanced
 Number of Slices: [30](#)
 F of S Tolerance: [0.01](#)
 Minimum Slip Surface Depth: [0.1 ft](#)

Materials

Fill

Model: [Mohr-Coulomb](#)
 Unit Weight: [120 pcf](#)
 Cohesion': [200 psf](#)
 Phi': [33 °](#)
 Phi-B: [0 °](#)

Tmc 100- 25° (A-Bed 20°-34°)

Model: [Anisotropic Fn.](#)
 Unit Weight: [120 pcf](#)
 Cohesion': [200 psf](#)
 Phi': [40 °](#)
 Phi-Anisotropic Strength Fn.: [Tmc 100- 25° \(A-Bed 20°-34°\)](#)
 C-Anisotropic Strength Fn.: [100- 25° \(A-Bed 20°-34°\)](#)
 Phi-B: [0 °](#)

Tmc 150-17° (A-Bed 4°-12°)

Model: [Anisotropic Fn.](#)
 Unit Weight: [120 pcf](#)
 Cohesion': [200 psf](#)
 Phi': [40 °](#)
 Phi-Anisotropic Strength Fn.: [Tmc 150-17° \(A-Bed 4°-12°\)](#)
 C-Anisotropic Strength Fn.: [150-17° \(A-Bed 4°-12°\)](#)
 Phi-B: [0 °](#)

Tmc 100-25° (A- Bed 4°-8°)

Model: [Anisotropic Fn.](#)
 Unit Weight: [120 pcf](#)
 Cohesion': [200 psf](#)
 Phi': [40 °](#)
 Phi-Anisotropic Strength Fn.: [Tmc 100-25° \(A- Bed 4°-8°\)](#)
 C-Anisotropic Strength Fn.: [100 \(A- Bed4°-8°\)](#)
 Phi-B: [0 °](#)

Slip Surface Limits

Left Coordinate: [\(-50, 2,033\) ft](#)
 Right Coordinate: [\(2,050, 2,352\) ft](#)

Slip Surface Block

Left Grid

Upper Left: (1,111, 2,143) ft
 Lower Left: (1,134, 2,025) ft
 Lower Right: (1,248, 2,046) ft
 X Increments: 10
 Y Increments: 10
 Starting Angle: 135 °
 Ending Angle: 180 °
 Angle Increments: 2

Right Grid

Upper Left: (1,266.6877, 2,201.9943) ft
 Lower Left: (1,284.7124, 2,069.4062) ft
 Lower Right: (1,386.5849, 2,091.0405) ft
 X Increments: 10
 Y Increments: 10
 Starting Angle: 45 °
 Ending Angle: 65 °
 Angle Increments: 2

Seismic Coefficients

Horz Seismic Coef.: 0
 Vert Seismic Coef.: 0

Anisotropic Strength Functions

Tmc 100-25° (A- Bed 4°-8°)

Model: Spline Data Point Function
 Function: Modifier Factor vs. Inclination
 Curve Fit to Data: 100 %
 Segment Curvature: 0 %

Y-Intercept: 1

Data Points: Inclination (°), Modifier Factor
 Data Point: (-90, 1)
 Data Point: (3.9, 1)
 Data Point: (4, 0.625)
 Data Point: (8, 0.625)
 Data Point: (8.1, 1)

Tmc 100- 25° (A-Bed 20°-34°)

Model: Spline Data Point Function
 Function: Modifier Factor vs. Inclination
 Curve Fit to Data: 100 %
 Segment Curvature: 0 %

Y-Intercept: 1

Data Points: Inclination (°), Modifier Factor
 Data Point: (-90, 1)

Data Point: (19.9, 1)
 Data Point: (20, 0.625)
 Data Point: (34, 0.625)
 Data Point: (34.1, 1)

100- 25° (A-Bed 20°-34°)

Model: Spline Data Point Function
 Function: Modifier Factor vs. Inclination
 Curve Fit to Data: 100 %
 Segment Curvature: 0 %

Y-Intercept: 1

Data Points: Inclination (°), Modifier Factor
 Data Point: (-90, 1)
 Data Point: (19.9, 1)
 Data Point: (20, 0.5)
 Data Point: (34, 0.5)
 Data Point: (34.1, 1)

Tmc 150-17° (A-Bed 4°-12°)

Model: Spline Data Point Function
 Function: Modifier Factor vs. Inclination
 Curve Fit to Data: 100 %
 Segment Curvature: 0 %

Y-Intercept: 1

Data Points: Inclination (°), Modifier Factor
 Data Point: (-90, 1)
 Data Point: (3.9, 1)
 Data Point: (4, 0.425)
 Data Point: (12, 0.425)
 Data Point: (12.1, 1)

100 (A- Bed4°-8°)

Model: Spline Data Point Function
 Function: Modifier Factor vs. Inclination
 Curve Fit to Data: 100 %
 Segment Curvature: 0 %

Y-Intercept: 1

Data Points: Inclination (°), Modifier Factor
 Data Point: (-90, 1)
 Data Point: (3.9, 1)
 Data Point: (4, 0.5)
 Data Point: (8, 0.5)
 Data Point: (8.1, 1)

150-17° (A-Bed 4°-12°)

Model: Spline Data Point Function
 Function: Modifier Factor vs. Inclination
 Curve Fit to Data: 100 %
 Segment Curvature: 0 %

Y-Intercept: 1

Data Points: Inclination (°), Modifier Factor

Data Point: (-90, 1)

Data Point: (3.9, 1)

Data Point: (4, 0.75)

Data Point: (12, 0.75)

Data Point: (12.1, 1)

Points

	X (ft)	Y (ft)
Point 1	-50	2,033
Point 2	118	2,039
Point 3	296	2,045
Point 4	360	2,081
Point 5	373	2,081
Point 6	403	2,097
Point 7	416	2,097
Point 8	437	2,110
Point 9	505	2,110
Point 10	700	2,109
Point 11	831	2,106
Point 12	862	2,117
Point 13	1,060	2,119
Point 14	1,163	2,117
Point 15	1,327	2,182
Point 16	1,369	2,192
Point 17	1,412	2,200
Point 18	1,429	2,201
Point 19	1,462	2,207
Point 20	1,582	2,236
Point 21	1,631	2,240
Point 22	1,713	2,261
Point 23	1,859	2,311
Point 24	1,895	2,322
Point 25	2,007	2,351
Point 26	2,036	2,353
Point 27	2,050	2,352
Point 28	2,050	2,100
Point 29	-50	1,914.8161
Point 30	549	2,109.7744
Point 31	863	2,017
Point 32	1,089	2,117
Point 33	-50	1,996
Point 34	625	2,087.3194
Point 35	863	1,994

Point 36	2,049	1,580
Point 37	-50	1,580
Point 38	1,007.64	2,081
Point 39	2,050	2,230
Point 40	1,168	2,112
Point 41	1,188	2,112
Point 42	1,313	2,178.5
Point 43	1,276.0361	2,158.8352

Regions

	Material	Points	Area (ft ²)
Region 1	Fill	30,34,31,38,32,13,12,11,10	25,797
Region 2	Tmc 100-25° (A- Bed 4°-8°)	33,34,30,9,8,7,6,5,4,3,2,1	16,398
Region 3	Tmc 100- 25° (A-Bed 20°-34°)	31,34,33,29,35	82,160
Region 4	Tmc 150-17° (A-Bed 4° -12°)	29,35,28,36,37	8.959e+005
Region 5	Tmc 100- 25° (A-Bed 20°-34°)	35,28,39,43,41,40,14,32,38,31	1.3322e+005
Region 6	Tmc 100-25° (A- Bed 4°-8°)	39,27,26,25,24,23,22,21,20,19,18,17,16,15,42,43	49,472

Current Slip Surface

Slip Surface: 80,069

F of S: 1.32

Volume: 1,586.6086 ft³

Weight: 190,393.03 lbs

Resisting Force: 93,953.979 lbs

Activating Force: 70,977.484 lbs

F of S Rank (Analysis): 1 of 131,769 slip surfaces

F of S Rank (Query): 1 of 100 slip surfaces

Exit: (1,191.6678, 2,113.9513) ft

Entry: (1,322.2122, 2,180.803) ft

Radius: 84.174713 ft

Center: (1,231.2639, 2,197.516) ft

Slip Slices

	X (ft)	Y (ft)	PWP (psf)	Base Normal Stress (psf)	Frictional Strength (psf)	Cohesive Strength (psf)
Slice 1	1,193.7509	2,113.0885	0	405.08643	339.90787	200
Slice 2	1,197.917	2,111.3628	0	1,046.043	877.73427	200
Slice 3	1,202.2364	2,111.4623	0	817.32242	381.1237	100
Slice 4	1,206.7091	2,113.3869	0	864.7341	403.23213	100
Slice 5	1,211.1818	2,115.3116	0	912.14578	425.34056	100
Slice 6	1,215.6545	2,117.2362	0	959.55745	447.44899	100
Slice 7	1,220.1272	2,119.1608	0	1,006.9691	469.55742	100
Slice 8	1,224.5999	2,121.0855	0	1,054.3808	491.66585	100
Slice 9	1,229.0726	2,123.0101	0	1,101.7925	513.77427	100
Slice 10	1,233.5453	2,124.9347	0	1,149.2042	535.8827	100
Slice 11	1,238.018	2,126.8593	0	1,196.6158	557.99113	100
Slice 12	1,242.4908	2,128.784	0	1,244.0275	580.09956	100
Slice 13	1,246.9635	2,130.7086	0	1,291.4392	602.20799	100
Slice 14	1,251.4362	2,132.6332	0	1,338.8509	624.31642	100
Slice 15	1,255.9089	2,134.5579	0	1,386.2626	646.42484	100
Slice 16	1,260.3816	2,136.4825	0	1,433.6742	668.53327	100
Slice 17	1,264.8543	2,138.4071	0	1,481.0859	690.6417	100
Slice 18	1,269.327	2,140.3318	0	1,528.4976	712.75013	100
Slice 19	1,273.7997	2,142.2564	0	1,575.9093	734.85856	100
Slice 20	1,278.0663	2,144.0923	0	1,621.136	755.94814	100
Slice 21	1,282.1268	2,145.8396	0	1,664.1778	776.01887	100
Slice 22	1,286.1873	2,147.5868	0	1,707.2197	796.0896	100

Slice 23	1,290.2477	2,149.334	0	1,750.2615	816.16033	100
Slice 24	1,294.3082	2,151.0813	0	1,793.3033	836.23106	100
Slice 25	1,298.3686	2,152.8285	0	1,836.3451	856.3018	100
Slice 26	1,302.4291	2,154.5757	0	1,879.3869	876.37253	100
Slice 27	1,306.7043	2,158.6554	0	926.90038	777.76176	200
Slice 28	1,310.9746	2,164.7541	0	685.61877	575.30246	200
Slice 29	1,315.303	2,170.9358	0	400.1049	335.72787	200
Slice 30	1,319.9091	2,177.514	0	57.956299	48.631109	200

Section 14-14 Static Final SSA with key for Skyline Ranch.gsz

Section 14-14 Static Final SSA with key for Skyline Ranch.gsz Run By: Dr. Alexander Bykovtsev, Ph.D., P.E. 3/22/2016 3:36:29 PM

Name: Fill
 Model: Mohr-Coulomb
 Unit Weight: 120 pcf
 Cohesion: 200 psf
 Phi: 33 °

Name: Tmc 100-25° (A-Bed 12°-20°)
 Model: Anisotropic Fn.
 Unit Weight: 120 pcf
 Cohesion: 200 psf
 Phi: 40 °

Phi-Anisotropic Strength Fn.: Tmc 100-25° (A-Bed 12°-20°)
 C-Anisotropic Strength Fn.: 100 psf (A-Bed 12°-20°)

Name: Tmc 150-17° (A-Bed 12°-20°)
 Model: Anisotropic Fn.
 Unit Weight: 120 pcf
 Cohesion: 200 psf
 Phi: 40 °

Phi-Anisotropic Strength Fn.: Tmc 150-17° (A-Bed 12°-20°)
 C-Anisotropic Strength Fn.: 150 psf (A-Bed 12°-20°)

Materials	
	Fill
	Tmc 100-25° (A-Bed 12°-20°)
	Tmc 150-17° (A-Bed 12°-20°)

Keyway depth 25'
 width 50', backcut slope 3H:1V

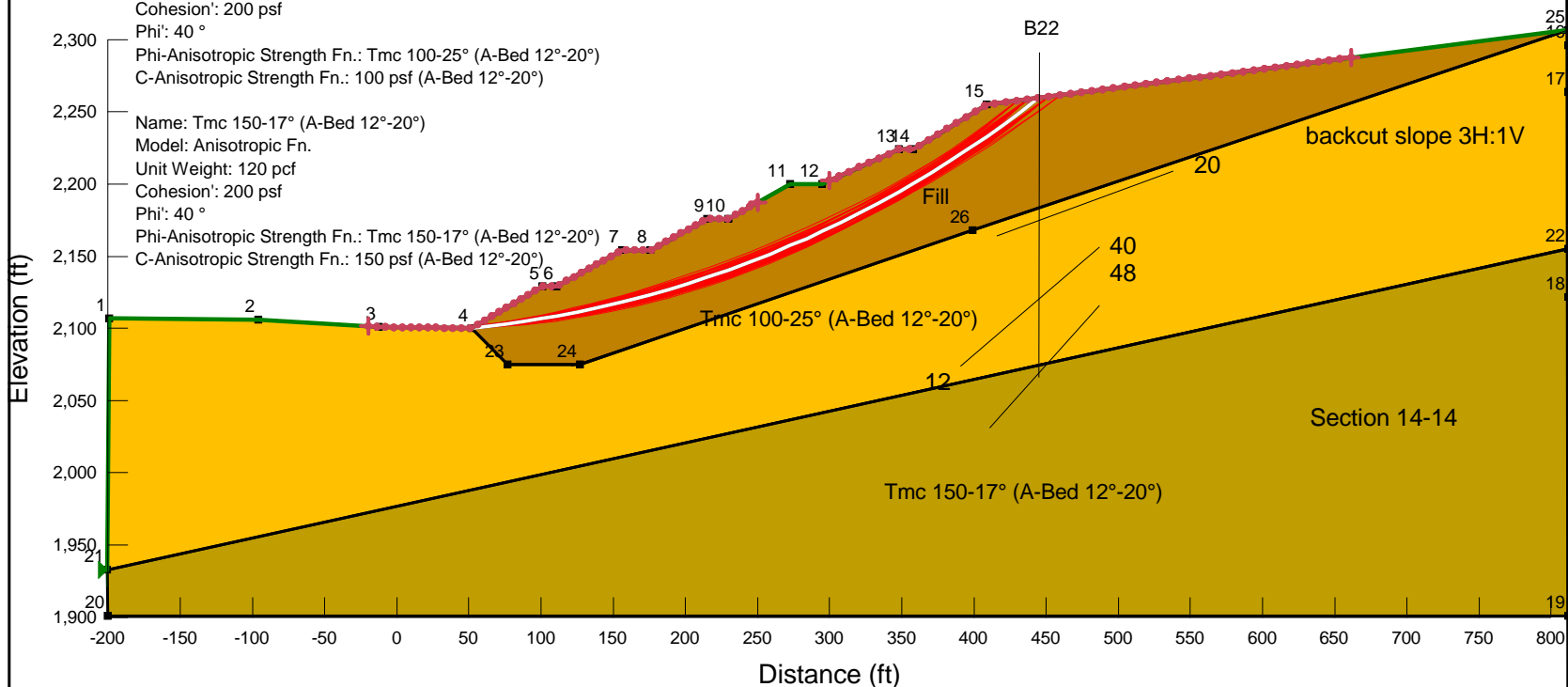

LGC	LGC Valley, Inc
	GEOTECHNICAL CONSULTING
	28532 Constellation Road, Valencia, CA 91355
	Phone 661-702-8474, Fax 661-702-8475

Skyline Ranch
 Development project, Tract 60922
 Los Angeles CA

Project No: **153035-01**
 Engineer: **BAS**
 Date: **March 2016**

1 - Circular Mode of Failure

Report generated using GeoStudio 2012. Copyright © 1991-2015 GEO-SLOPE International Ltd.

File Information

File Version: 8.15

Title: Static Slope Stability Analyses for Skyline Ranch Development project, Tract 60922, Los Angeles CA

Comments: Run By: Dr. Alexander Bykovtsev, Ph.D., P.E.

Last Edited By: Alexander Bykovtsev

Revision Number: 119

Date: 3/22/2016

Time: 3:36:29 PM

Tool Version: 8.15.1.11236

File Name: Section 14-14 Static Final SSA with key for Skyline Ranch.gsz

Directory: G:\SLOPE RESULTS\Section 14-14 results\

Last Solved Date: 3/22/2016

Last Solved Time: 3:36:45 PM

Project Settings

Length(L) Units: Feet

Time(t) Units: Seconds

Force(F) Units: Pounds

Pressure(p) Units: psf

Strength Units: psf

Unit Weight of Water: 62.4 pcf

View: 2D

Element Thickness: 1

Analysis Settings

1 - Circular Mode of Failure

Kind: SLOPE/W

Method: [Bishop](#)

Settings

PWP Conditions Source: [\(none\)](#)

Slip Surface

Direction of movement: [Right to Left](#)

Use Passive Mode: [No](#)

Slip Surface Option: [Entry and Exit](#)

Critical slip surfaces saved: [10](#)

Resisting Side Maximum Convex Angle: [1 °](#)

Driving Side Maximum Convex Angle: [5 °](#)

Optimize Critical Slip Surface Location: [No](#)

Tension Crack

Tension Crack Option: [\(none\)](#)

F of S Distribution

F of S Calculation Option: [Constant](#)

Advanced

Number of Slices: [30](#)

F of S Tolerance: [0.01](#)

Minimum Slip Surface Depth: [0.1 ft](#)

Materials

Fill

Model: [Mohr-Coulomb](#)

Unit Weight: [120 pcf](#)

Cohesion': [200 psf](#)

Phi': [33 °](#)

Phi-B: [0 °](#)

Tmc 100-25° (A-Bed 12°-20°)

Model: [Anisotropic Fn.](#)

Unit Weight: [120 pcf](#)

Cohesion': [200 psf](#)

Phi': [40 °](#)

Phi-Anisotropic Strength Fn.: [Tmc 100-25° \(A-Bed 12°-20°\)](#)

C-Anisotropic Strength Fn.: [100 psf \(A-Bed 12°-20°\)](#)

Phi-B: 0°

Tmc 150-17° (A-Bed 12°-20°)

Model: Anisotropic Fn.

Unit Weight: 120 pcf

Cohesion': 200 psf

Phi': 40°

Phi-Anisotropic Strength Fn.: Tmc 150-17° (A-Bed 12°-20°)

C-Anisotropic Strength Fn.: 150 psf (A-Bed 12°-20°)

Phi-B: 0°

Slip Surface Entry and Exit

Left Projection: Range

Left-Zone Left Coordinate: (-19.3634, 2,101.4383) ft

Left-Zone Right Coordinate: (250, 2,187.1628) ft

Left-Zone Increment: 50

Right Projection: Range

Right-Zone Left Coordinate: (300, 2,202.2642) ft

Right-Zone Right Coordinate: (661.3692, 2,287.5638) ft

Right-Zone Increment: 50

Radius Increments: 50

Slip Surface Limits

Left Coordinate: (-200.4103, 1,933) ft

Right Coordinate: (812, 2,307) ft

Seismic Coefficients

Horz Seismic Coef.: 0

Vert Seismic Coef.: 0

Anisotropic Strength Functions

Tmc 150-17° (A-Bed 12°-20°)

Model: [Spline Data Point Function](#)

Function: [Modifier Factor vs. Inclination](#)

Curve Fit to Data: 100 %

Segment Curvature: 0 %

Y-Intercept: 1

Data Points: [Inclination \(°\), Modifier Factor](#)

Data Point: (-90, 1)

Data Point: (17.9, 1)

Data Point: (18, 0.425)

Data Point: (22, 0.425)

Data Point: (22.1, 1)

150 psf (A-Bed 12°-20°)

Model: [Spline Data Point Function](#)

Function: [Modifier Factor vs. Inclination](#)

Curve Fit to Data: 100 %

Segment Curvature: 0 %

Y-Intercept: 1

Data Points: [Inclination \(°\), Modifier Factor](#)

Data Point: (-90, 1)

Data Point: (11.9, 1)

Data Point: (12, 0.667)

Data Point: (20, 0.667)

Data Point: (20.1, 1)

100 psf (A-Bed 12°-20°)

Model: [Spline Data Point Function](#)

Function: [Modifier Factor vs. Inclination](#)

Curve Fit to Data: 100 %

Segment Curvature: 0 %

Y-Intercept: 1

Data Points: [Inclination \(°\), Modifier Factor](#)

Data Point: (-90, 1)

Data Point: (11.9, 1)

Data Point: (12, 0.5)

Data Point: (20, 0.5)

Data Point: (20.1, 1)

Tmc 100-25° (A-Bed 12°-20°)

Model: [Spline Data Point Function](#)

Function: [Modifier Factor vs. Inclination](#)

Curve Fit to Data: 100 %

Segment Curvature: 0 %

Y-Intercept: 1

Data Points: [Inclination \(°\)](#), [Modifier Factor](#)

Data Point: (-90, 1)

Data Point: (11.9, 1)

Data Point: (12, 0.625)

Data Point: (20, 0.625)

Data Point: (20.1, 1)

Points

	X (ft)	Y (ft)
Point 1	-199	2,107
Point 2	-96	2,106
Point 3	-12	2,101
Point 4	52	2,100
Point 5	101	2,129
Point 6	111	2,129
Point 7	156	2,154
Point 8	176	2,154
Point 9	215	2,176
Point 10	230	2,176
Point 11	273	2,200
Point 12	295	2,200
Point 13	348	2,224
Point 14	358	2,224
Point 15	409	2,255
Point 16	812	2,296

Point 17	812	2,264
Point 18	812	2,122
Point 19	812	1,901
Point 20	-200	1,901
Point 21	-200.4103	1,933
Point 22	812	2,155
Point 23	77	2,075
Point 24	127	2,075
Point 25	812	2,307
Point 26	399	2,168

Regions

	Material	Points	Area (ft²)
Region 1	Tmc 150-17° (A-Bed 12°-20°)	21,20,19,18,22	1.4477e+005
Region 2	Tmc 100-25° (A-Bed 12°-20°)	1,21,22,17,16,25,26,24,23,4,3,2	1.1865e+005
Region 3	Fill	4,23,24,26,25,15,14,13,12,11,10,9,8,7,6,5	39,768

Current Slip Surface

Slip Surface: 32,293
 F of S: 1.87
 Volume: 10,691.937 ft³
 Weight: 1,283,032.5 lbs

Resisting Moment: 6.6036603e+008 lbs-ft
 Activating Moment: 3.5256276e+008 lbs-ft
 F of S Rank (Analysis): 1 of 132,651 slip surfaces
 F of S Rank (Query): 1 of 50 slip surfaces
 Exit: (52.287117, 2,100.1699) ft
 Entry: (444.60145, 2,259.5937) ft
 Radius: 758.84435 ft
 Center: (-25.892211, 2,854.9764) ft

Slip Slices

	X (ft)	Y (ft)	PWP (psf)	Base Normal Stress (psf)	Frictional Strength (psf)	Cohesive Strength (psf)
Slice 1	58.376228	2,100.8503	0	326.26504	211.87899	200
Slice 2	70.554448	2,102.311	0	983.14483	638.46172	200
Slice 3	82.732669	2,103.972	0	1,609.9659	1,045.5241	200
Slice 4	94.91089	2,105.8346	0	2,206.9897	1,433.2359	200
Slice 5	106	2,107.699	0	2,391.1884	1,552.8559	200
Slice 6	118.5	2,110.0352	0	2,581.8512	1,676.6738	200
Slice 7	133.5	2,113.1003	0	3,150.6971	2,046.0866	200
Slice 8	148.5	2,116.4828	0	3,676.3283	2,387.4355	200
Slice 9	161	2,119.5245	0	3,777.6225	2,453.2168	200
Slice 10	171	2,122.1384	0	3,471.8107	2,254.6202	200
Slice 11	182.5	2,125.3383	0	3,502.6191	2,274.6275	200
Slice 12	195.5	2,129.1774	0	3,858.6928	2,505.8644	200
Slice 13	208.5	2,133.2712	0	4,182.5488	2,716.179	200
Slice 14	222.5	2,137.9805	0	4,040.7658	2,624.104	200
Slice 15	237.16667	2,143.2275	0	3,877.1846	2,517.8731	200
Slice 16	251.5	2,148.691	0	4,115.6046	2,672.7049	200
Slice 17	265.83333	2,154.4903	0	4,314.667	2,801.9775	200
Slice 18	278.5	2,159.8835	0	4,139.6801	2,688.3397	200
Slice 19	289.5	2,164.8054	0	3,604.3878	2,340.7168	200
Slice 20	301.625	2,170.4887	0	3,303.1551	2,145.094	200
Slice 21	314.875	2,176.9885	0	3,226.3732	2,095.2312	200
Slice 22	328.125	2,183.8128	0	3,117.0171	2,024.2146	200

Slice 23	341.375	2,190.9717	0	2,974.789	1,931.8506	200
Slice 24	353	2,197.5175	0	2,598.0916	1,687.2204	200
Slice 25	364.375	2,204.2222	0	2,297.4012	1,491.9498	200
Slice 26	377.125	2,212.0415	0	2,270.4658	1,474.4577	200
Slice 27	389.875	2,220.2132	0	2,208.7276	1,434.3645	200
Slice 28	402.625	2,228.7511	0	2,111.6537	1,371.3239	200
Slice 29	414.93358	2,237.3484	0	1,711.1396	1,111.227	200
Slice 30	426.80073	2,245.9943	0	1,015.6686	659.58289	200
Slice 31	438.66788	2,254.9994	0	297.21704	193.015	200

Section 14-14 Seismic Final SSA with key for Skyline Ranch.gsz

Section 14-14 Seismic Final SSA with key for Skyline Ranch.gsz Run By: Dr. Alexander Bykovtsev, Ph.D., P.E. 3/22/2016 3:22:20 PM

Name: Fill
 Model: Mohr-Coulomb
 Unit Weight: 120 pcf
 Cohesion: 200 psf
 Phi: 33 °

Materials

- Fill
- Tmc 100-25° (A-Bed 12°-20°)
- Tmc 150-17° (A-Bed 12°-20°)

Seismic load
 Horizontal: 0.15
 Vertical: 0.0

Name: Tmc 100-25° (A-Bed 12°-20°)
 Model: Anisotropic Fn.
 Unit Weight: 120 pcf
 Cohesion: 200 psf
 Phi: 40 °
 Phi-Anisotropic Strength Fn.: Tmc 100-25° (A-Bed 12°-20°)
 C-Anisotropic Strength Fn.: 100 psf (A-Bed 12°-20°)

Keyway depth 25'
 width 50', backcut slope 3H:1V

Name: Tmc 150-17° (A-Bed 12°-20°)
 Model: Anisotropic Fn.
 Unit Weight: 120 pcf
 Cohesion: 200 psf
 Phi: 40 °
 Phi-Anisotropic Strength Fn.: Tmc 150-17° (A-Bed 12°-20°)
 C-Anisotropic Strength Fn.: 150 psf (A-Bed 12°-20°)

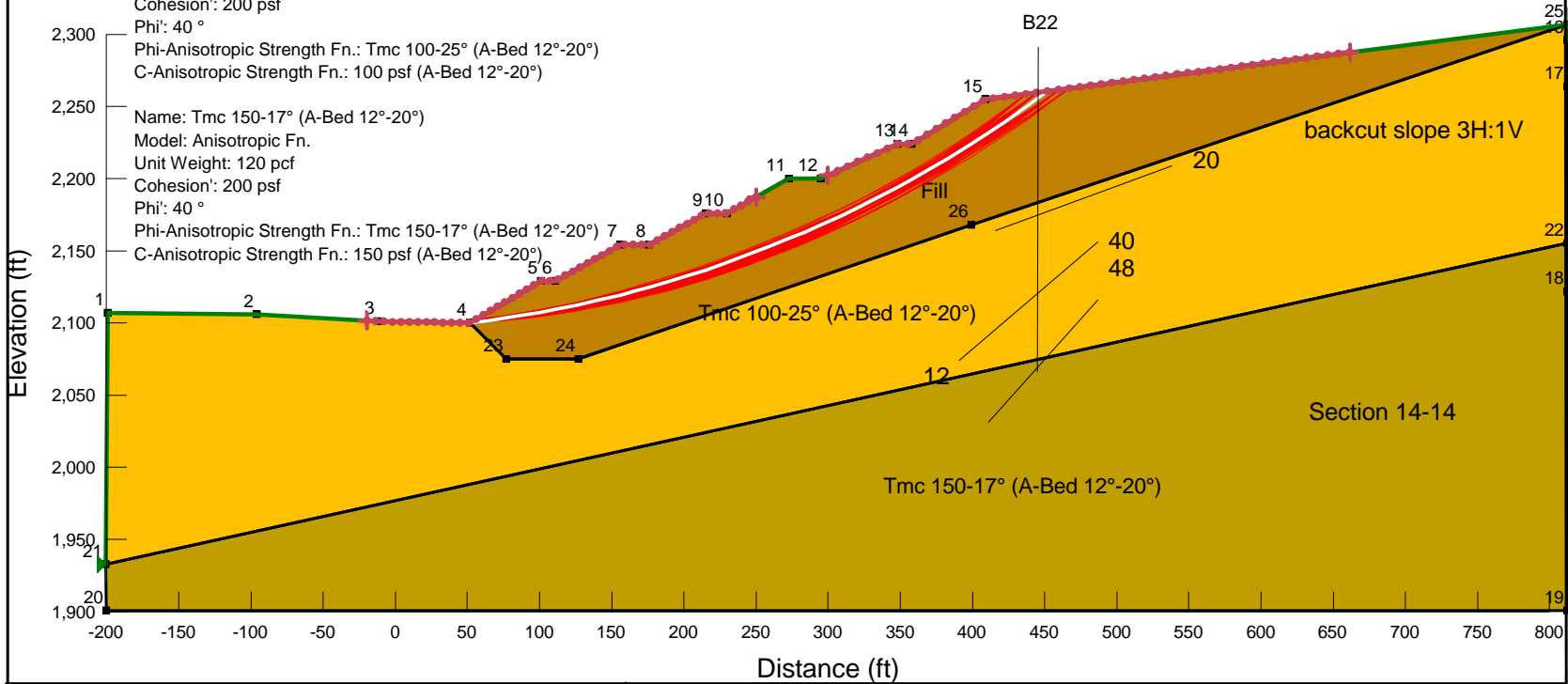

	<p>LGC Valley, Inc GEOTECHNICAL CONSULTING 28532 Constellation Road, Valencia, CA 91355 Phone 661-702-8474, Fax 661-702-8475</p>	<p>Skyline Ranch Development project, Tract 60922 Los Angeles CA</p>	<p>Project No: 153035-01 Engineer: BAS Date: March 2016</p>
---	--	---	--

1 - Circular Mode of Failure

Report generated using GeoStudio 2012. Copyright © 1991-2015 GEO-SLOPE International Ltd.

File Information

File Version: 8.15
 Title: Static Slope Stability Analyses for Skyline Ranch Development project, Tract 60922, Los Angeles CA
 Comments: Run By: Dr. Alexander Bykovtsev, Ph.D., P.E.
 Last Edited By: Alexander Bykovtsev
 Revision Number: 115
 Date: 3/22/2016
 Time: 3:22:20 PM
 Tool Version: 8.15.1.11236
 File Name: Section 14-14 Seismic Final SSA with key for Skyline Ranch.gsz
 Directory: G:\SLOPE RESULTS\Section 14-14 results\
 Last Solved Date: 3/22/2016
 Last Solved Time: 3:26:24 PM

Project Settings

Length(L) Units: Feet
 Time(t) Units: Seconds
 Force(F) Units: Pounds
 Pressure(p) Units: psf
 Strength Units: psf
 Unit Weight of Water: 62.4 pcf
 View: 2D
 Element Thickness: 1

Analysis Settings

1 - Circular Mode of Failure

Kind: [SLOPE/W](#)
 Method: [Bishop](#)
 Settings
 PWP Conditions Source: [\(none\)](#)
 Slip Surface
 Direction of movement: [Right to Left](#)
 Use Passive Mode: [No](#)
 Slip Surface Option: [Entry and Exit](#)
 Critical slip surfaces saved: [10](#)
 Resisting Side Maximum Convex Angle: [1 °](#)
 Driving Side Maximum Convex Angle: [5 °](#)
 Optimize Critical Slip Surface Location: [No](#)
 Tension Crack
 Tension Crack Option: [\(none\)](#)

file:///G:/SLOPE%20RESULTS/Section%2014-14%20results/section%2014-14%20seismi... 3/22/2016

F of S Distribution
 F of S Calculation Option: [Constant](#)
 Advanced
 Number of Slices: [30](#)
 F of S Tolerance: [0.01](#)
 Minimum Slip Surface Depth: [0.1 ft](#)

Materials

Fill

Model: [Mohr-Coulomb](#)
 Unit Weight: [120 pcf](#)
 Cohesion': [200 psf](#)
 Phi': [33 °](#)
 Phi-B: [0 °](#)

Tmc 100-25° (A-Bed 12°-20°)

Model: [Anisotropic Fn.](#)
 Unit Weight: [120 pcf](#)
 Cohesion': [200 psf](#)
 Phi': [40 °](#)
 Phi-Anisotropic Strength Fn.: [Tmc 100-25° \(A-Bed 12°-20°\)](#)
 C-Anisotropic Strength Fn.: [100 psf \(A-Bed 12°-20°\)](#)
 Phi-B: [0 °](#)

Tmc 150-17° (A-Bed 12°-20°)

Model: [Anisotropic Fn.](#)
 Unit Weight: [120 pcf](#)
 Cohesion': [200 psf](#)
 Phi': [40 °](#)
 Phi-Anisotropic Strength Fn.: [Tmc 150-17° \(A-Bed 12°-20°\)](#)
 C-Anisotropic Strength Fn.: [150 psf \(A-Bed 12°-20°\)](#)
 Phi-B: [0 °](#)

Slip Surface Entry and Exit

Left Projection: [Range](#)
 Left-Zone Left Coordinate: [\(-19.3634, 2,101.4383\) ft](#)
 Left-Zone Right Coordinate: [\(250, 2,187.1628\) ft](#)
 Left-Zone Increment: [50](#)
 Right Projection: [Range](#)
 Right-Zone Left Coordinate: [\(300, 2,202.2642\) ft](#)
 Right-Zone Right Coordinate: [\(661.3692, 2,287.5638\) ft](#)
 Right-Zone Increment: [50](#)
 Radius Increments: [50](#)

Slip Surface Limits

file:///G:/SLOPE%20RESULTS/Section%2014-14%20results/section%2014-14%20seismi... 3/22/2016

Left Coordinate: (-200.4103, 1,933) ft
 Right Coordinate: (812, 2,307) ft

Seismic Coefficients

Horz Seismic Coef.: 0.15
 Vert Seismic Coef.: 0

Anisotropic Strength Functions

Tmc 150-17° (A-Bed 12°-20°)

Model: Spline Data Point Function
 Function: Modifier Factor vs. Inclination
 Curve Fit to Data: 100 %
 Segment Curvature: 0 %

Y-Intercept: 1

Data Points: Inclination (°), Modifier Factor

- Data Point: (-90, 1)
- Data Point: (17.9, 1)
- Data Point: (18, 0.425)
- Data Point: (22, 0.425)
- Data Point: (22.1, 1)

150 psf (A-Bed 12°-20°)

Model: Spline Data Point Function
 Function: Modifier Factor vs. Inclination
 Curve Fit to Data: 100 %
 Segment Curvature: 0 %

Y-Intercept: 1

Data Points: Inclination (°), Modifier Factor

- Data Point: (-90, 1)
- Data Point: (11.9, 1)
- Data Point: (12, 0.667)
- Data Point: (20, 0.667)
- Data Point: (20.1, 1)

100 psf (A-Bed 12°-20°)

Model: Spline Data Point Function
 Function: Modifier Factor vs. Inclination
 Curve Fit to Data: 100 %
 Segment Curvature: 0 %

Y-Intercept: 1

Data Points: Inclination (°), Modifier Factor

- Data Point: (-90, 1)
- Data Point: (11.9, 1)
- Data Point: (12, 0.5)
- Data Point: (20, 0.5)
- Data Point: (20.1, 1)

Tmc 100-25° (A-Bed 12°-20°)

Model: Spline Data Point Function
 Function: Modifier Factor vs. Inclination
 Curve Fit to Data: 100 %
 Segment Curvature: 0 %

Y-Intercept: 1

Data Points: Inclination (°), Modifier Factor

- Data Point: (-90, 1)
- Data Point: (11.9, 1)
- Data Point: (12, 0.625)
- Data Point: (20, 0.625)
- Data Point: (20.1, 1)

Points

	X (ft)	Y (ft)
Point 1	-199	2,107
Point 2	-96	2,106
Point 3	-12	2,101
Point 4	52	2,100
Point 5	101	2,129
Point 6	111	2,129
Point 7	156	2,154
Point 8	176	2,154
Point 9	215	2,176
Point 10	230	2,176
Point 11	273	2,200
Point 12	295	2,200
Point 13	348	2,224
Point 14	358	2,224
Point 15	409	2,255
Point 16	812	2,296
Point 17	812	2,264
Point 18	812	2,122
Point 19	812	1,901
Point 20	-200	1,901
Point 21	-200.4103	1,933
Point 22	812	2,155
Point 23	77	2,075
Point 24	127	2,075
Point 25	812	2,307
Point 26	399	2,168

Regions

	Material	Points	Area (ft²)
Region 1	Tmc 150-17° (A-Bed 12°-20°)	21,20,19,18,22	1.4477e+005
Region 2	Tmc 100-25° (A-Bed 12°-20°)	1,21,22,17,16,25,26,24,23,4,3,2	1.1865e+005
Region 3	Fill	4,23,24,26,25,15,14,13,12,11,10,9,8,7,6,5	39,768

Current Slip Surface

Slip Surface: 32,343
 F of S: 1.29
 Volume: 10,673.463 ft³
 Weight: 1,280,815.6 lbs
 Resisting Moment: 6.9068626e+008 lbs-ft
 Activating Moment: 5.3349881e+008 lbs-ft
 F of S Rank (Analysis): 1 of 132,651 slip surfaces
 F of S Rank (Query): 1 of 50 slip surfaces
 Exit: (52.344529, 2,100.2039) ft
 Entry: (452.0762, 2,260.5582) ft
 Radius: 836.87766 ft
 Center: (-48.878949, 2,930.9373) ft

Slip Slices

	X (ft)	Y (ft)	PWP (psf)	Base Normal Stress (psf)	Frictional Strength (psf)	Cohesive Strength (psf)
Slice 1	58.426462	2,100.9902	0	298.35774	193.75579	200
Slice 2	70.59033	2,102.6538	0	913.672	593.34553	200
Slice 3	82.754198	2,104.4998	0	1,500.1129	974.18469	200
Slice 4	94.918066	2,106.5293	0	2,058.0556	1,336.517	200
Slice 5	106	2,108.5318	0	2,218.1618	1,440.4911	200
Slice 6	118.5	2,111.0045	0	2,384.4715	1,548.4939	200
Slice 7	133.5	2,114.2103	0	2,914.7123	1,892.8363	200
Slice 8	148.5	2,117.7054	0	3,404.5314	2,210.9286	200
Slice 9	161	2,120.8211	0	3,489.2712	2,265.9592	200
Slice 10	171	2,123.478	0	3,186.5388	2,069.3625	200
Slice 11	182.5	2,126.7096	0	3,208.6478	2,083.7202	200

Slice 12	195.5	2,130.5643	0	3,543.8568	2,301.4075	200
Slice 13	208.5	2,134.6499	0	3,849.6503	2,499.9921	200
Slice 14	222.5	2,139.322	0	3,711.8753	2,410.52	200
Slice 15	237.16667	2,144.4998	0	3,556.7246	2,309.764	200
Slice 16	251.5	2,149.8626	0	3,788.3182	2,460.1626	200
Slice 17	265.83333	2,155.5274	0	3,984.9675	2,587.8681	200
Slice 18	278.5	2,160.774	0	3,827.5805	2,485.6599	200
Slice 19	289.5	2,165.5435	0	3,330.0726	2,162.5744	200
Slice 20	301.625	2,171.0308	0	3,059.2436	1,986.696	200
Slice 21	314.875	2,177.2841	0	3,005.705	1,951.9277	200
Slice 22	328.125	2,183.8248	0	2,924.8351	1,899.4101	200
Slice 23	341.375	2,190.6604	0	2,816.6197	1,829.1342	200
Slice 24	353	2,196.8903	0	2,487.4426	1,615.3641	200
Slice 25	364.375	2,203.2481	0	2,233.1968	1,450.2549	200
Slice 26	377.125	2,210.6388	0	2,243.3842	1,456.8707	200
Slice 27	389.875	2,218.3343	0	2,224.6931	1,444.7326	200
Slice 28	402.625	2,226.3445	0	2,176.9669	1,413.7388	200
Slice 29	416.17937	2,235.2288	0	1,784.0371	1,158.5673	200
Slice 30	430.5381	2,245.0461	0	1,052.2684	683.3511	200
Slice 31	444.89684	2,255.3112	0	297.19019	192.99757	200

Section 14-14 Static Final SSA with key for Skyline Ranch.gsz

Section 14-14 Static Final SSA with key for Skyline Ranch.gsz Run By: Dr. Alexander Bykovtsev, Ph.D., P.E. 3/22/2016 3:30:27 PM

Name: Fill
 Model: Mohr-Coulomb
 Unit Weight: 120 pcf
 Cohesion: 200 psf
 Phi: 33 °

Name: Tmc 100-25° (A-Bed 12°-20°)
 Model: Anisotropic Fn.
 Unit Weight: 120 pcf
 Cohesion: 200 psf
 Phi: 40 °
 Phi-Anisotropic Strength Fn.: Tmc 100-25° (A-Bed 12°-20°)
 C-Anisotropic Strength Fn.: 100 psf (A-Bed 12°-20°)

Name: Tmc 150-17° (A-Bed 12°-20°)
 Model: Anisotropic Fn.
 Unit Weight: 120 pcf
 Cohesion: 200 psf
 Phi: 40 °
 Phi-Anisotropic Strength Fn.: Tmc 150-17° (A-Bed 12°-20°)
 C-Anisotropic Strength Fn.: 150 psf (A-Bed 12°-20°)

- Materials
- Fill
 - Tmc 100-25° (A-Bed 12°-20°)
 - Tmc 150-17° (A-Bed 12°-20°)

Keyway depth 25'
 width 50', backcut slope 3H:1V

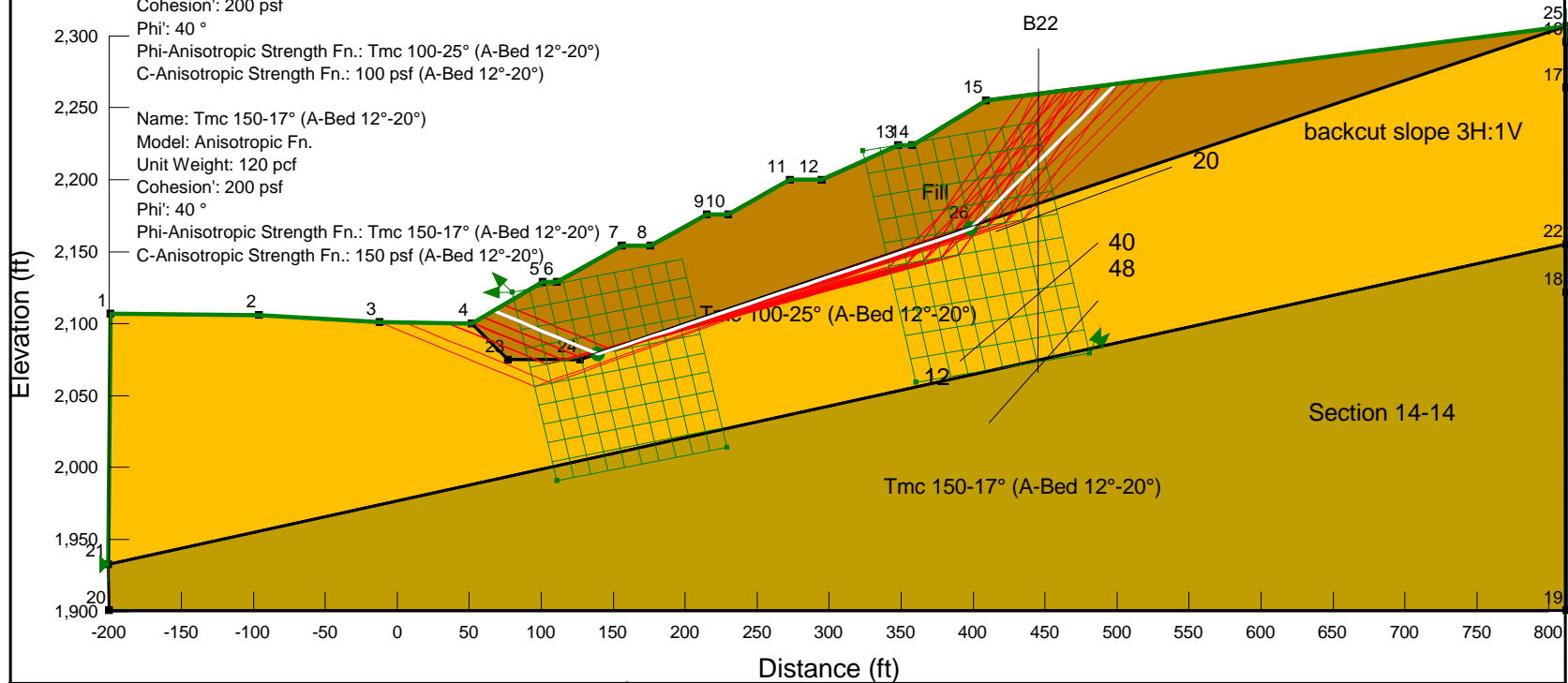

LGC **LGC Valley, Inc**
 GEOTECHNICAL CONSULTING
 28532 Constellation Road, Valencia, CA 91355
 Phone 661-702-8474, Fax 661-702-8475

Skyline Ranch
 Development project, Tract 60922
 Los Angeles CA

Project No: **153035-01**
 Engineer: **BAS**
 Date: **March 2016**

2 - Translational

Report generated using GeoStudio 2012. Copyright © 1991-2015 GEO-SLOPE International Ltd.

File Information

File Version: 8.15
 Title: Static Slope Stability Analyses for Skyline Ranch Development project, Tract 60922, Los Angeles CA
 Comments: Run By: Dr. Alexander Bykovtsev, Ph.D., P.E.
 Last Edited By: Alexander Bykovtsev
 Revision Number: 117
 Date: 3/22/2016
 Time: 3:30:27 PM
 Tool Version: 8.15.1.11236
 File Name: Section 14-14 Static Final SSA with key for Skyline Ranch.gsz
 Directory: G:\SLOPE RESULTS\Section 14-14 results\
 Last Solved Date: 3/22/2016
 Last Solved Time: 3:30:58 PM

Project Settings

Length(L) Units: Feet
 Time(t) Units: Seconds
 Force(F) Units: Pounds
 Pressure(p) Units: psf
 Strength Units: psf
 Unit Weight of Water: 62.4 pcf
 View: 2D
 Element Thickness: 1

Analysis Settings

2 - Translational

Kind: SLOPE/W
 Method: Janbu
 Settings
 PWP Conditions Source: (none)
 Slip Surface
 Direction of movement: Right to Left
 Use Passive Mode: No
 Slip Surface Option: Block
 Critical slip surfaces saved: 10
 Resisting Side Maximum Convex Angle: 1 °
 Driving Side Maximum Convex Angle: 5 °
 Restrict Block Crossing: No
 Optimize Critical Slip Surface Location: No
 Tension Crack

file:///G:/SLOPE%20RESULTS/Section%2014-14%20results/section%2014-14%20static... 3/22/2016

Tension Crack Option: (none)
 F of S Distribution
 F of S Calculation Option: Constant
 Advanced
 Number of Slices: 30
 F of S Tolerance: 0.01
 Minimum Slip Surface Depth: 0.1 ft

Materials

Fill

Model: Mohr-Coulomb
 Unit Weight: 120 pcf
 Cohesion': 200 psf
 Phi': 33 °
 Phi-B: 0 °

Tmc 100-25° (A-Bed 12°-20°)

Model: Anisotropic Fn.
 Unit Weight: 120 pcf
 Cohesion': 200 psf
 Phi': 40 °
 Phi-Anisotropic Strength Fn.: Tmc 100-25° (A-Bed 12°-20°)
 C-Anisotropic Strength Fn.: 100 psf (A-Bed 12°-20°)
 Phi-B: 0 °

Tmc 150-17° (A-Bed 12°-20°)

Model: Anisotropic Fn.
 Unit Weight: 120 pcf
 Cohesion': 200 psf
 Phi': 40 °
 Phi-Anisotropic Strength Fn.: Tmc 150-17° (A-Bed 12°-20°)
 C-Anisotropic Strength Fn.: 150 psf (A-Bed 12°-20°)
 Phi-B: 0 °

Slip Surface Limits

Left Coordinate: (-200.4103, 1,933) ft
 Right Coordinate: (812, 2,307) ft

Slip Surface Block

Left Grid
 Upper Left: (80, 2,122) ft
 Lower Left: (111, 1,991) ft
 Lower Right: (229, 2,014) ft
 X Increments: 10
 Y Increments: 10

file:///G:/SLOPE%20RESULTS/Section%2014-14%20results/section%2014-14%20static... 3/22/2016

Starting Angle: 135 °
 Ending Angle: 180 °
 Angle Increments: 2
 Right Grid
 Upper Left: (323.3505, 2,220.2241) ft
 Lower Left: (360.3413, 2,059.0196) ft
 Lower Right: (481.0019, 2,079.2802) ft
 X Increments: 10
 Y Increments: 10
 Starting Angle: 45 °
 Ending Angle: 65 °
 Angle Increments: 2

Seismic Coefficients

Horz Seismic Coef.: 0
 Vert Seismic Coef.: 0

Anisotropic Strength Functions

Tmc 150-17° (A-Bed 12°-20°)

Model: Spline Data Point Function
 Function: Modifier Factor vs. Inclination
 Curve Fit to Data: 100 %
 Segment Curvature: 0 %
 Y-Intercept: 1
 Data Points: Inclination (°), Modifier Factor
 Data Point: (-90, 1)
 Data Point: (17.9, 1)
 Data Point: (18, 0.425)
 Data Point: (22, 0.425)
 Data Point: (22.1, 1)

150 psf (A-Bed 12°-20°)

Model: Spline Data Point Function
 Function: Modifier Factor vs. Inclination
 Curve Fit to Data: 100 %
 Segment Curvature: 0 %
 Y-Intercept: 1
 Data Points: Inclination (°), Modifier Factor
 Data Point: (-90, 1)
 Data Point: (11.9, 1)
 Data Point: (12, 0.667)
 Data Point: (20, 0.667)
 Data Point: (20.1, 1)

100 psf (A-Bed 12°-20°)

Model: Spline Data Point Function
 Function: Modifier Factor vs. Inclination

Curve Fit to Data: 100 %
 Segment Curvature: 0 %
 Y-Intercept: 1
 Data Points: Inclination (°), Modifier Factor
 Data Point: (-90, 1)
 Data Point: (11.9, 1)
 Data Point: (12, 0.5)
 Data Point: (20, 0.5)
 Data Point: (20.1, 1)

Tmc 100-25° (A-Bed 12°-20°)

Model: Spline Data Point Function
 Function: Modifier Factor vs. Inclination
 Curve Fit to Data: 100 %
 Segment Curvature: 0 %
 Y-Intercept: 1
 Data Points: Inclination (°), Modifier Factor
 Data Point: (-90, 1)
 Data Point: (11.9, 1)
 Data Point: (12, 0.625)
 Data Point: (20, 0.625)
 Data Point: (20.1, 1)

Points

	X (ft)	Y (ft)
Point 1	-199	2,107
Point 2	-96	2,106
Point 3	-12	2,101
Point 4	52	2,100
Point 5	101	2,129
Point 6	111	2,129
Point 7	156	2,154
Point 8	176	2,154
Point 9	215	2,176
Point 10	230	2,176
Point 11	273	2,200
Point 12	295	2,200
Point 13	348	2,224
Point 14	358	2,224
Point 15	409	2,255
Point 16	812	2,296
Point 17	812	2,264
Point 18	812	2,122
Point 19	812	1,901
Point 20	-200	1,901
Point 21	-200.4103	1,933

Point 22	812	2,155
Point 23	77	2,075
Point 24	127	2,075
Point 25	812	2,307
Point 26	399	2,168

Regions

	Material	Points	Area (ft ²)
Region 1	Tmc 150-17° (A-Bed 12°-20°)	21,20,19,18,22	1.4477e+005
Region 2	Tmc 100-25° (A-Bed 12°-20°)	1,21,22,17,16,25,26,24,23,4,3,2	1.1865e+005
Region 3	Fill	4,23,24,26,25,15,14,13,12,11,10,9,8,7,6,5	39,768

Current Slip Surface

Slip Surface: 76,807
 F of S: 1.64
 Volume: 25,292.21 ft³
 Weight: 3,035,065.2 lbs
 Resisting Force: 1,472,366 lbs
 Activating Force: 900,131.81 lbs
 F of S Rank (Analysis): 1 of 131,769 slip surfaces
 F of S Rank (Query): 1 of 50 slip surfaces
 Exit: (66.994388, 2,108.8742) ft
 Entry: (499.24963, 2,266.6451) ft
 Radius: 236.24981 ft
 Center: (239.93286, 2,306.0878) ft

Slip Slices

	X (ft)	Y (ft)	PWP (psf)	Base Normal Stress (psf)	Frictional Strength (psf)	Cohesive Strength (psf)
Slice 1	75.495791	2,105.3528	0	1,288.0005	836.43731	200
Slice 2	92.498597	2,098.31	0	3,743.2141	2,430.8717	200
Slice 3	106	2,092.7176	0	5,268.0856	3,421.1348	200
Slice 4	117.98201	2,087.7545	0	6,537.1969	4,245.3053	200
Slice 5	132.28201	2,081.8312	0	8,527.6566	5,537.9249	200
Slice 6	147.8	2,081.558	0	7,416.861	3,458.5391	100

Slice 7	166	2,087.6796	0	7,245.3415	3,378.5582	100
Slice 8	182.5	2,093.2293	0	7,039.0904	3,282.3818	100
Slice 9	195.5	2,097.6018	0	7,363.3879	3,433.6042	100
Slice 10	208.5	2,101.9743	0	7,687.6854	3,584.8266	100
Slice 11	222.5	2,106.6832	0	7,573.5342	3,531.597	100
Slice 12	237.16667	2,111.6163	0	7,471.3329	3,483.9397	100
Slice 13	251.5	2,116.4373	0	7,819.5301	3,646.3068	100
Slice 14	265.83333	2,121.2582	0	8,167.7274	3,808.6738	100
Slice 15	278.5	2,125.5186	0	8,139.2061	3,795.3741	100
Slice 16	289.5	2,129.2184	0	7,733.9662	3,606.4077	100
Slice 17	301.625	2,133.2967	0	7,615.8702	3,551.3386	100
Slice 18	314.875	2,137.7533	0	7,784.9182	3,630.167	100
Slice 19	328.125	2,142.2099	0	7,953.9662	3,708.9953	100
Slice 20	341.375	2,146.6665	0	8,123.0141	3,787.8237	100
Slice 21	353	2,150.5765	0	8,023.3382	3,741.344	100
Slice 22	364.74619	2,154.5273	0	8,039.7486	3,748.9963	100
Slice 23	378.23856	2,159.0654	0	8,440.9692	3,936.0886	100
Slice 24	391.99237	2,163.865	0	8,773.2329	4,091.0257	100
Slice 25	400.20925	2,167.6047	0	6,433.873	5,398.6605	200
Slice 26	405.20925	2,172.6047	0	6,798.2248	4,414.8188	200
Slice 27	416.5208	2,183.9163	0	6,107.2759	3,966.1113	200
Slice 28	431.56241	2,198.9579	0	4,980.9835	3,234.6885	200
Slice 29	446.60401	2,213.9995	0	3,854.6912	2,503.2657	200
Slice 30	461.64562	2,229.0411	0	2,728.3989	1,771.8429	200

Slice 31	476.68723	2,244.0827	0	1,602.1065	1,040.4201	200
Slice 32	491.72883	2,259.1243	0	475.81419	308.99735	200

Section 14-14 Seismic Final SSA with key for Skyline Ranch.gsz

Section 14-14 Seismic Final SSA with key for Skyline Ranch.gsz Run By: Dr. Alexander Bykovtsev, Ph.D., P.E. 3/22/2016 3:22:20 PM

Name: Fill
 Model: Mohr-Coulomb
 Unit Weight: 120 pcf
 Cohesion: 200 psf
 Phi: 33 °

Name: Tmc 100-25° (A-Bed 12°-20°)
 Model: Anisotropic Fn.
 Unit Weight: 120 pcf
 Cohesion: 200 psf
 Phi: 40 °
 Phi-Anisotropic Strength Fn.: Tmc 100-25° (A-Bed 12°-20°)
 C-Anisotropic Strength Fn.: 100 psf (A-Bed 12°-20°)

Name: Tmc 150-17° (A-Bed 12°-20°)
 Model: Anisotropic Fn.
 Unit Weight: 120 pcf
 Cohesion: 200 psf
 Phi: 40 °
 Phi-Anisotropic Strength Fn.: Tmc 150-17° (A-Bed 12°-20°)
 C-Anisotropic Strength Fn.: 150 psf (A-Bed 12°-20°)

Materials

- Fill
- Tmc 100-25° (A-Bed 12°-20°)
- Tmc 150-17° (A-Bed 12°-20°)

Seismic load
 Horizontal: 0.15
 Vertical: 0.0

Keyway depth 25'
 width 50', backcut slope 3H:1V

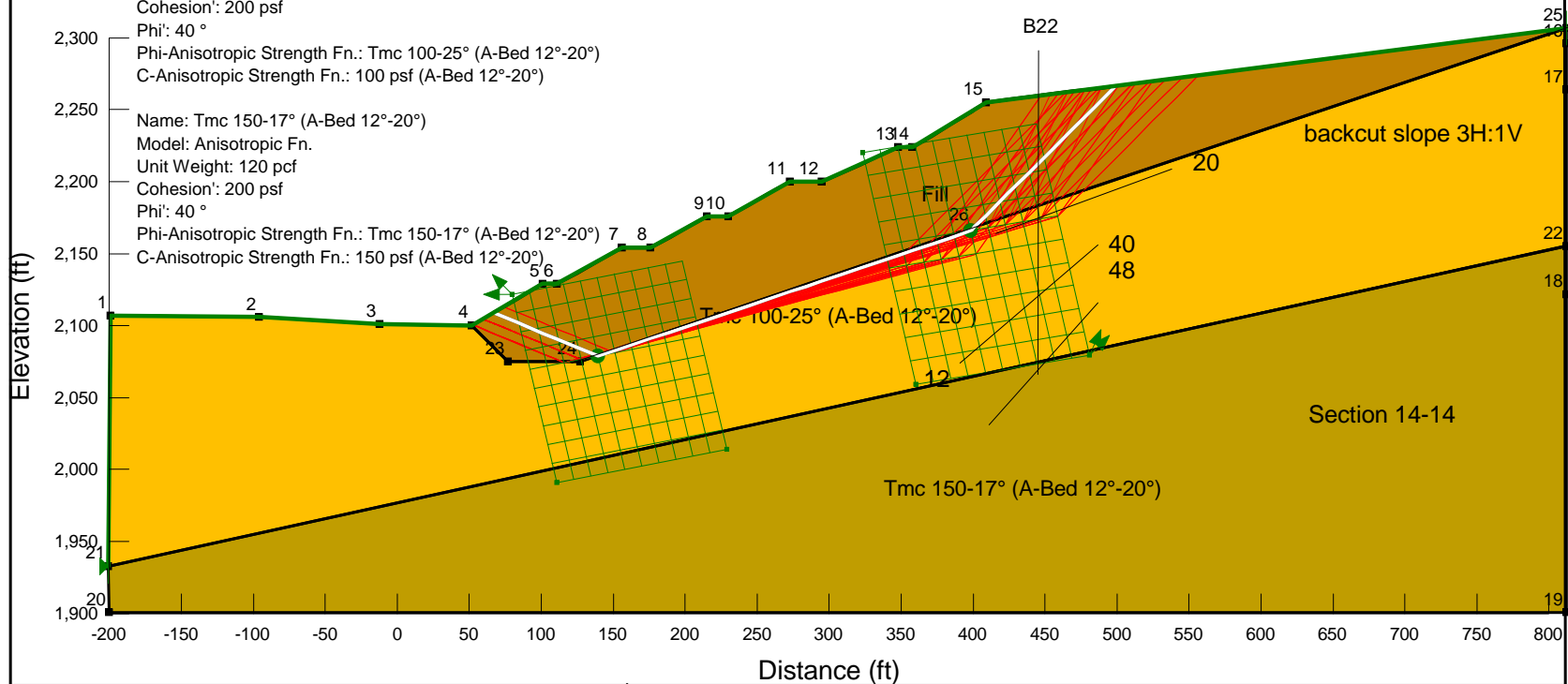

LGC Valley, Inc
 GEOTECHNICAL CONSULTING
 28532 Constellation Road, Valencia, CA 91355
 Phone 661-702-8474, Fax 661-702-8475

Skyline Ranch
 Development project, Tract 60922
 Los Angeles CA

Project No: **153035-01**
 Engineer: **BAS**
 Date: **March 2016**

2 - Translational

Report generated using GeoStudio 2012. Copyright © 1991-2015 GEO-SLOPE International Ltd.

File Information

File Version: 8.15
 Title: Static Slope Stability Analyses for Skyline Ranch Development project, Tract 60922, Los Angeles CA
 Comments: Run By: Dr. Alexander Bykovtsev, Ph.D., P.E.
 Last Edited By: Alexander Bykovtsev
 Revision Number: 115
 Date: 3/22/2016
 Time: 3:22:20 PM
 Tool Version: 8.15.1.11236
 File Name: Section 14-14 Seismic Final SSA with key for Skyline Ranch.gsz
 Directory: G:\SLOPE RESULTS\Section 14-14 results\
 Last Solved Date: 3/22/2016
 Last Solved Time: 3:22:37 PM

Project Settings

Length(L) Units: Feet
 Time(t) Units: Seconds
 Force(F) Units: Pounds
 Pressure(p) Units: psf
 Strength Units: psf
 Unit Weight of Water: 62.4 pcf
 View: 2D
 Element Thickness: 1

Analysis Settings

2 - Translational

Kind: SLOPE/W
 Method: Janbu
 Settings
 PWP Conditions Source: (none)
 Slip Surface
 Direction of movement: Right to Left
 Use Passive Mode: No
 Slip Surface Option: Block
 Critical slip surfaces saved: 10
 Resisting Side Maximum Convex Angle: 1 °
 Driving Side Maximum Convex Angle: 5 °
 Restrict Block Crossing: No
 Optimize Critical Slip Surface Location: No
 Tension Crack

file:///G:/SLOPE%20RESULTS/Section%2014-14%20results/section%2014-14%20seismi... 3/22/2016

Tension Crack Option: (none)
 F of S Distribution
 F of S Calculation Option: Constant
 Advanced
 Number of Slices: 30
 F of S Tolerance: 0.01
 Minimum Slip Surface Depth: 0.1 ft

Materials

Fill

Model: Mohr-Coulomb
 Unit Weight: 120 pcf
 Cohesion': 200 psf
 Phi': 33 °
 Phi-B: 0 °

Tmc 100-25° (A-Bed 12°-20°)

Model: Anisotropic Fn.
 Unit Weight: 120 pcf
 Cohesion': 200 psf
 Phi': 40 °
 Phi-Anisotropic Strength Fn.: Tmc 100-25° (A-Bed 12°-20°)
 C-Anisotropic Strength Fn.: 100 psf (A-Bed 12°-20°)
 Phi-B: 0 °

Tmc 150-17° (A-Bed 12°-20°)

Model: Anisotropic Fn.
 Unit Weight: 120 pcf
 Cohesion': 200 psf
 Phi': 40 °
 Phi-Anisotropic Strength Fn.: Tmc 150-17° (A-Bed 12°-20°)
 C-Anisotropic Strength Fn.: 150 psf (A-Bed 12°-20°)
 Phi-B: 0 °

Slip Surface Limits

Left Coordinate: (-200.4103, 1,933) ft
 Right Coordinate: (812, 2,307) ft

Slip Surface Block

Left Grid
 Upper Left: (80, 2,122) ft
 Lower Left: (111, 1,991) ft
 Lower Right: (229, 2,014) ft
 X Increments: 10
 Y Increments: 10

file:///G:/SLOPE%20RESULTS/Section%2014-14%20results/section%2014-14%20seismi... 3/22/2016

Starting Angle: 135 °
 Ending Angle: 180 °
 Angle Increments: 2
 Right Grid
 Upper Left: (323.3505, 2,220.2241) ft
 Lower Left: (360.3413, 2,059.0196) ft
 Lower Right: (481.0019, 2,079.2802) ft
 X Increments: 10
 Y Increments: 10
 Starting Angle: 45 °
 Ending Angle: 65 °
 Angle Increments: 2

Seismic Coefficients

Horz Seismic Coef.: 0.15
 Vert Seismic Coef.: 0

Anisotropic Strength Functions

Tmc 150-17° (A-Bed 12°-20°)

Model: Spline Data Point Function
 Function: Modifier Factor vs. Inclination
 Curve Fit to Data: 100 %
 Segment Curvature: 0 %
 Y-Intercept: 1
 Data Points: Inclination (°), Modifier Factor
 Data Point: (-90, 1)
 Data Point: (17.9, 1)
 Data Point: (18, 0.425)
 Data Point: (22, 0.425)
 Data Point: (22.1, 1)

150 psf (A-Bed 12°-20°)

Model: Spline Data Point Function
 Function: Modifier Factor vs. Inclination
 Curve Fit to Data: 100 %
 Segment Curvature: 0 %
 Y-Intercept: 1
 Data Points: Inclination (°), Modifier Factor
 Data Point: (-90, 1)
 Data Point: (11.9, 1)
 Data Point: (12, 0.667)
 Data Point: (20, 0.667)
 Data Point: (20.1, 1)

100 psf (A-Bed 12°-20°)

Model: Spline Data Point Function
 Function: Modifier Factor vs. Inclination

Curve Fit to Data: 100 %
 Segment Curvature: 0 %
 Y-Intercept: 1
 Data Points: Inclination (°), Modifier Factor
 Data Point: (-90, 1)
 Data Point: (11.9, 1)
 Data Point: (12, 0.5)
 Data Point: (20, 0.5)
 Data Point: (20.1, 1)

Tmc 100-25° (A-Bed 12°-20°)

Model: Spline Data Point Function
 Function: Modifier Factor vs. Inclination
 Curve Fit to Data: 100 %
 Segment Curvature: 0 %
 Y-Intercept: 1
 Data Points: Inclination (°), Modifier Factor
 Data Point: (-90, 1)
 Data Point: (11.9, 1)
 Data Point: (12, 0.625)
 Data Point: (20, 0.625)
 Data Point: (20.1, 1)

Points

	X (ft)	Y (ft)
Point 1	-199	2,107
Point 2	-96	2,106
Point 3	-12	2,101
Point 4	52	2,100
Point 5	101	2,129
Point 6	111	2,129
Point 7	156	2,154
Point 8	176	2,154
Point 9	215	2,176
Point 10	230	2,176
Point 11	273	2,200
Point 12	295	2,200
Point 13	348	2,224
Point 14	358	2,224
Point 15	409	2,255
Point 16	812	2,296
Point 17	812	2,264
Point 18	812	2,122
Point 19	812	1,901
Point 20	-200	1,901
Point 21	-200.4103	1,933

Point 22	812	2,155
Point 23	77	2,075
Point 24	127	2,075
Point 25	812	2,307
Point 26	399	2,168

Regions

	Material	Points	Area (ft ²)
Region 1	Tmc 150-17° (A-Bed 12°-20°)	21,20,19,18,22	1.4477e+005
Region 2	Tmc 100-25° (A-Bed 12°-20°)	1,21,22,17,16,25,26,24,23,4,3,2	1.1865e+005
Region 3	Fill	4,23,24,26,25,15,14,13,12,11,10,9,8,7,6,5	39,768

Current Slip Surface

Slip Surface: 76,807
 F of S: 1.13
 Volume: 25,292.21 ft³
 Weight: 3,035,065.2 lbs
 Resisting Force: 1,429,519.8 lbs
 Activating Force: 1,268,278.3 lbs
 F of S Rank (Analysis): 1 of 131,769 slip surfaces
 F of S Rank (Query): 1 of 50 slip surfaces
 Exit: (66.994388, 2,108.8742) ft
 Entry: (499.24963, 2,266.6451) ft
 Radius: 236.24981 ft
 Center: (239.93286, 2,306.0878) ft

Slip Slices

	X (ft)	Y (ft)	PWP (psf)	Base Normal Stress (psf)	Frictional Strength (psf)	Cohesive Strength (psf)
Slice 1	75.495791	2,105.3528	0	1,443.3086	937.2956	200
Slice 2	92.498597	2,098.31	0	4,137.4452	2,686.8883	200
Slice 3	106	2,092.7176	0	5,810.7057	3,773.5164	200
Slice 4	117.98201	2,087.7545	0	7,203.3174	4,677.889	200
Slice 5	132.28201	2,081.8312	0	9,387.4735	6,096.2966	200
Slice 6	147.8	2,081.558	0	7,127.1722	3,323.455	100

Slice 7	166	2,087.6796	0	6,962.1637	3,246.5103	100
Slice 8	182.5	2,093.2293	0	6,763.742	3,153.9847	100
Slice 9	195.5	2,097.6018	0	7,075.729	3,299.4666	100
Slice 10	208.5	2,101.9743	0	7,387.7159	3,444.9485	100
Slice 11	222.5	2,106.6832	0	7,277.898	3,393.7396	100
Slice 12	237.16667	2,111.6163	0	7,179.5763	3,347.8914	100
Slice 13	251.5	2,116.4373	0	7,514.5558	3,504.0949	100
Slice 14	265.83333	2,121.2582	0	7,849.5353	3,660.2984	100
Slice 15	278.5	2,125.5186	0	7,822.0967	3,647.5036	100
Slice 16	289.5	2,129.2184	0	7,432.2399	3,465.7104	100
Slice 17	301.625	2,133.2967	0	7,318.627	3,412.7318	100
Slice 18	314.875	2,137.7533	0	7,481.2578	3,488.5678	100
Slice 19	328.125	2,142.2099	0	7,643.8886	3,564.4038	100
Slice 20	341.375	2,146.6665	0	7,806.5194	3,640.2398	100
Slice 21	353	2,150.5765	0	7,710.6272	3,595.5245	100
Slice 22	364.74619	2,154.5273	0	7,726.4146	3,602.8863	100
Slice 23	378.23856	2,159.0654	0	8,112.4048	3,782.8765	100
Slice 24	391.99237	2,163.865	0	8,410.1981	3,921.7398	100
Slice 25	400.20925	2,167.6047	0	5,548.3739	4,655.6385	200
Slice 26	405.20925	2,172.6047	0	5,990.5138	3,890.2852	200
Slice 27	416.5208	2,183.9163	0	5,378.1001	3,492.5791	200
Slice 28	431.56241	2,198.9579	0	4,379.8255	2,844.2919	200
Slice 29	446.60401	2,213.9995	0	3,381.5508	2,196.0047	200
Slice 30	461.64562	2,229.0411	0	2,383.2761	1,547.7176	200

Slice 31	476.68723	2,244.0827	0	1,385.0014	899.43041	200
Slice 32	491.72883	2,259.1243	0	386.72667	251.14324	200

Section 14-14 Static Temporary Final SSA without key for Skyline Ranch.gsz

Section 14-14 Static Temporary Final SSA without key for Skyline Ranch.gsz Run By: Dr. Alexander Bykovtsev, Ph.D., P.E. 3/22/2016 3:43:42 PM

Name: Tmc 100-25° (A-Bed 12°-20°)
 Model: Anisotropic Fn.
 Unit Weight: 120 pcf
 Cohesion: 200 psf
 Phi: 40°
 Phi-Anisotropic Strength Fn.: Tmc 100-25° (A-Bed 12°-20°)
 C-Anisotropic Strength Fn.: 100 psf (A-Bed 12°-20°)

Materials
 Tmc 100-25° (A-Bed 12°-20°)
 Tmc 150-17° (A-Bed 12°-20°)

Keyway depth 25'
 width 50', backcut slope 3H:1V

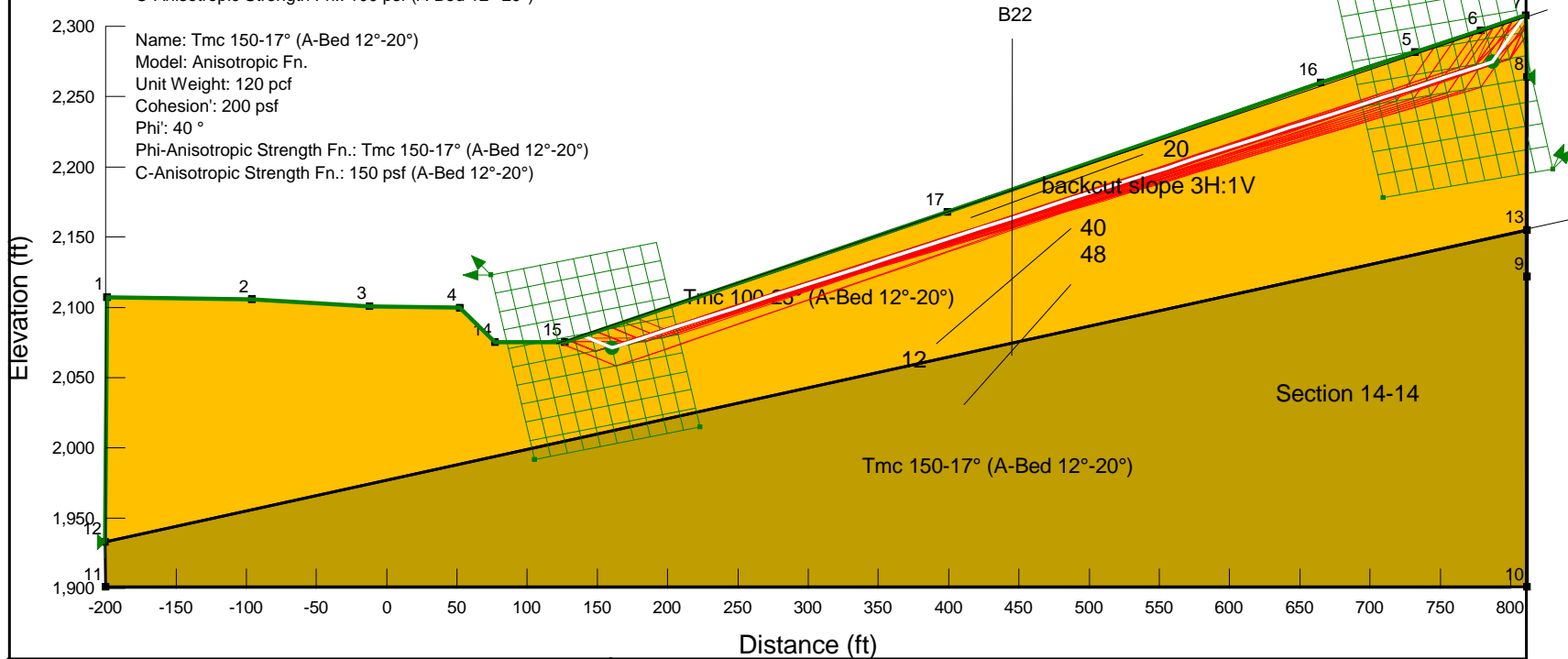

LGC Valley, Inc
 GEOTECHNICAL CONSULTING
 28532 Constellation Road, Valencia, CA 91355
 Phone 661-702-8474, Fax 661-702-8475

Skyline Ranch
 Development project, Tract 60922
 Los Angeles CA

Project No: **153035-01**
 Engineer: **BAS**
 Date: **March 2016**

2 - Translational

Report generated using GeoStudio 2012. Copyright © 1991-2015 GEO-SLOPE International Ltd.

File Information

File Version: 8.15
 Title: Static Slope Stability Analyses for Skyline Ranch Development project, Tract 60922, Los Angeles CA
 Comments: Run By: Dr. Alexander Bykovtsev, Ph.D., P.E.
 Last Edited By: Alexander Bykovtsev
 Revision Number: 129
 Date: 3/22/2016
 Time: 3:43:42 PM
 Tool Version: 8.15.1.11236
 File Name: Section 14-14 Static Temporary Final SSA without key for Skyline Ranch.gsz
 Directory: G:\SLOPE RESULTS\Section 14-14 results\
 Last Solved Date: 3/22/2016
 Last Solved Time: 3:43:58 PM

Project Settings

Length(L) Units: Feet
 Time(t) Units: Seconds
 Force(F) Units: Pounds
 Pressure(p) Units: psf
 Strength Units: psf
 Unit Weight of Water: 62.4 pcf
 View: 2D
 Element Thickness: 1

Analysis Settings

2 - Translational

Kind: [SLOPE/W](#)
 Method: [Janbu](#)
 Settings
 PWP Conditions Source: [\(none\)](#)
 Slip Surface
 Direction of movement: [Right to Left](#)
 Use Passive Mode: [No](#)
 Slip Surface Option: [Block](#)
 Critical slip surfaces saved: [10](#)
 Resisting Side Maximum Convex Angle: [1 °](#)
 Driving Side Maximum Convex Angle: [5 °](#)
 Restrict Block Crossing: [No](#)
 Optimize Critical Slip Surface Location: [No](#)
 Tension Crack

Tension Crack Option: [\(none\)](#)
 F of S Distribution
 F of S Calculation Option: [Constant](#)
 Advanced
 Number of Slices: [30](#)
 F of S Tolerance: [0.01](#)
 Minimum Slip Surface Depth: [0.1 ft](#)

Materials

Tmc 100-25° (A-Bed 12°-20°)

Model: [Anisotropic Fn.](#)
 Unit Weight: [120 pcf](#)
 Cohesion': [200 psf](#)
 Phi': [40 °](#)
 Phi-Anisotropic Strength Fn.: [Tmc 100-25° \(A-Bed 12°-20°\)](#)
 C-Anisotropic Strength Fn.: [100 psf \(A-Bed 12°-20°\)](#)
 Phi-B: [0 °](#)

Tmc 150-17° (A-Bed 12°-20°)

Model: [Anisotropic Fn.](#)
 Unit Weight: [120 pcf](#)
 Cohesion': [200 psf](#)
 Phi': [40 °](#)
 Phi-Anisotropic Strength Fn.: [Tmc 150-17° \(A-Bed 12°-20°\)](#)
 C-Anisotropic Strength Fn.: [150 psf \(A-Bed 12°-20°\)](#)
 Phi-B: [0 °](#)

Slip Surface Limits

Left Coordinate: [\(-200.4103, 1,933\) ft](#)
 Right Coordinate: [\(812, 2,264\) ft](#)

Slip Surface Block

Left Grid
 Upper Left: [\(74, 2,123\) ft](#)
 Lower Left: [\(105, 1,992\) ft](#)
 Lower Right: [\(223, 2,015\) ft](#)
 X Increments: [10](#)
 Y Increments: [10](#)
 Starting Angle: [135 °](#)
 Ending Angle: [180 °](#)
 Angle Increments: [2](#)
 Right Grid
 Upper Left: [\(672.3505, 2,339.2241\) ft](#)
 Lower Left: [\(709.3413, 2,178.0196\) ft](#)
 Lower Right: [\(830.0019, 2,198.2802\) ft](#)

X Increments: 10
 Y Increments: 10
 Starting Angle: 45 °
 Ending Angle: 65 °
 Angle Increments: 2

Seismic Coefficients

Horz Seismic Coef.: 0
 Vert Seismic Coef.: 0

Anisotropic Strength Functions

Tmc 150-17° (A-Bed 12°-20°)

Model: Spline Data Point Function
 Function: Modifier Factor vs. Inclination
 Curve Fit to Data: 100 %
 Segment Curvature: 0 %

Y-Intercept: 1
 Data Points: Inclination (°), Modifier Factor
 Data Point: (-90, 1)
 Data Point: (17.9, 1)
 Data Point: (18, 0.425)
 Data Point: (22, 0.425)
 Data Point: (22.1, 1)

150 psf (A-Bed 12°-20°)

Model: Spline Data Point Function
 Function: Modifier Factor vs. Inclination
 Curve Fit to Data: 100 %
 Segment Curvature: 0 %

Y-Intercept: 1
 Data Points: Inclination (°), Modifier Factor
 Data Point: (-90, 1)
 Data Point: (11.9, 1)
 Data Point: (12, 0.667)
 Data Point: (20, 0.667)
 Data Point: (20.1, 1)

100 psf (A-Bed 12°-20°)

Model: Spline Data Point Function
 Function: Modifier Factor vs. Inclination
 Curve Fit to Data: 100 %
 Segment Curvature: 0 %

Y-Intercept: 1
 Data Points: Inclination (°), Modifier Factor
 Data Point: (-90, 1)
 Data Point: (11.9, 1)
 Data Point: (12, 0.5)

Data Point: (20, 0.5)
 Data Point: (20.1, 1)

Tmc 100-25° (A-Bed 12°-20°)

Model: Spline Data Point Function
 Function: Modifier Factor vs. Inclination
 Curve Fit to Data: 100 %
 Segment Curvature: 0 %

Y-Intercept: 1
 Data Points: Inclination (°), Modifier Factor
 Data Point: (-90, 1)
 Data Point: (11.9, 1)
 Data Point: (12, 0.625)
 Data Point: (20, 0.625)
 Data Point: (20.1, 1)

Points

	X (ft)	Y (ft)
Point 1	-199	2,107
Point 2	-96	2,106
Point 3	-12	2,101
Point 4	52	2,100
Point 5	732	2,282
Point 6	779	2,297
Point 7	811	2,308
Point 8	812	2,264
Point 9	812	2,122
Point 10	812	1,901
Point 11	-200	1,901
Point 12	-200.4103	1,933
Point 13	812	2,155
Point 14	77	2,075
Point 15	127	2,075
Point 16	665	2,260
Point 17	399	2,168

Regions

	Material	Points	Area (ft²)
Region 1	Tmc 150-17° (A-Bed 12°-20°)	12,11,10,9,13	1.4477e+005
Region 2	Tmc 100-25° (A-Bed 12°-20°)	1,12,13,8,7,6,5,16,17,15,14,4,3,2	1.1922e+005

Current Slip Surface

Slip Surface: 66,983

F of S: 1.62
 Volume: 13,462.726 ft³
 Weight: 1,615,527.1 lbs
 Resisting Force: 767,036.08 lbs
 Activating Force: 474,731.75 lbs
 F of S Rank (Analysis): 1 of 131,769 slip surfaces
 F of S Rank (Query): 1 of 50 slip surfaces
 Exit: (140.34873, 2,079.5641) ft
 Entry: (810.47325, 2,307.8189) ft
 Radius: 331.6586 ft
 Center: (417.10062, 2,364.8826) ft

Slip Slices

	X (ft)	Y (ft)	PWP (psf)	Base Normal Stress (psf)	Frictional Strength (psf)	Cohesive Strength (psf)
Slice 1	150.32436	2,075.432	0	1,220.9089	1,024.4642	200
Slice 2	171.15	2,074.8216	0	1,656.5548	772.46419	100
Slice 3	192.85	2,081.8648	0	1,697.821	791.70693	100
Slice 4	214.55	2,088.908	0	1,739.0872	810.94967	100
Slice 5	236.25	2,095.9512	0	1,780.3534	830.19241	100
Slice 6	257.95	2,102.9944	0	1,821.6196	849.43515	100
Slice 7	279.65	2,110.0376	0	1,862.8857	868.67789	100
Slice 8	301.35	2,117.0808	0	1,904.1519	887.92063	100
Slice 9	323.05	2,124.124	0	1,945.4181	907.16337	100
Slice 10	344.75	2,131.1672	0	1,986.6843	926.40611	100
Slice 11	366.45	2,138.2104	0	2,027.9505	945.64885	100
Slice 12	388.15	2,145.2536	0	2,069.2167	964.89159	100
Slice 13	410.08333	2,152.3725	0	2,115.7312	986.58168	100
Slice 14	432.25	2,159.5672	0	2,167.4941	1,010.7191	100
Slice 15	454.41667	2,166.7618	0	2,219.257	1,034.8565	100
Slice 16	476.58333	2,173.9565	0	2,271.0199	1,058.994	100
	498.75	2,181.1511	0	2,322.7827	1,083.1314	100

Slice 17						
Slice 18	520.91667	2,188.3458	0	2,374.5456	1,107.2688	100
Slice 19	543.08333	2,195.5405	0	2,426.3085	1,131.4062	100
Slice 20	565.25	2,202.7351	0	2,478.0714	1,155.5437	100
Slice 21	587.41667	2,209.9298	0	2,529.8343	1,179.6811	100
Slice 22	609.58333	2,217.1245	0	2,581.5971	1,203.8185	100
Slice 23	631.75	2,224.3191	0	2,633.36	1,227.9559	100
Slice 24	653.91667	2,231.5138	0	2,685.1229	1,252.0934	100
Slice 25	676.16667	2,238.7355	0	2,715.6418	1,266.3246	100
Slice 26	698.5	2,245.9843	0	2,724.9168	1,270.6496	100
Slice 27	720.83333	2,253.233	0	2,734.1919	1,274.9746	100
Slice 28	743.75	2,260.6711	0	2,731.8423	1,273.879	100
Slice 29	767.25	2,268.2985	0	2,717.868	1,267.3627	100
Slice 30	783.18719	2,273.4713	0	2,719.6877	1,268.2112	100
Slice 31	798.92381	2,291.3246	0	758.88378	636.7791	200

Section 15-15 Static Final with key SSA for Skyline Ranch.gsz

Section 15-15 Static Final with key SSA for Skyline Ranch.gsz Run By: Dr. Alexander Bykovtsev, Ph.D., P.E. 3/23/2016 9:49:45 AM

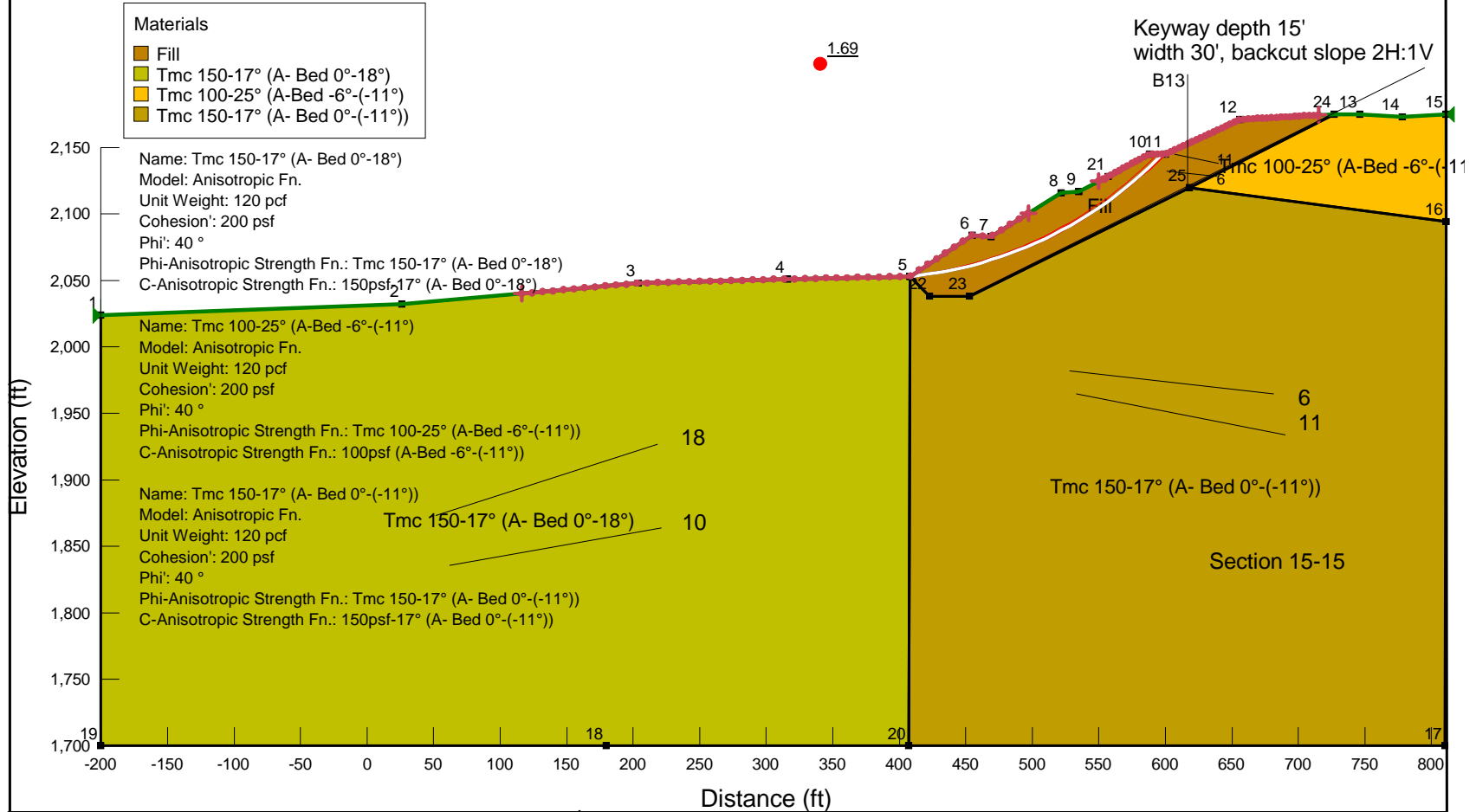

LGC Valley, Inc
 GEOTECHNICAL CONSULTING
 28532 Constellation Road, Valencia, CA 91355
 Phone 661-702-8474, Fax 661-702-8475

Skyline Ranch
 Development project, Tract 60922
 Los Angeles CA

Project No: **153035-01**
 Engineer: **BAS**
 Date: **March 2016**

1 - Circular Mode of Failure

Report generated using GeoStudio 2012. Copyright © 1991-2015 GEO-SLOPE International Ltd.

File Information

File Version: 8.15
 Title: Static Slope Stability Analyses for Skyline Ranch Development project, Tract 60922, Los Angeles CA
 Comments: Run By: Dr. Alexander Bykovtsev, Ph.D., P.E.
 Last Edited By: Alexander Bykovtsev
 Revision Number: 122
 Date: 3/23/2016
 Time: 9:49:45 AM
 Tool Version: 8.15.1.11236
 File Name: Section 15-15 Static Final with key SSA for Skyline Ranch.gsz
 Directory: G:\SLOPE RESULTS\Section 15-15 results\
 Last Solved Date: 3/24/2016
 Last Solved Time: 3:10:59 PM

Project Settings

Length(L) Units: Feet
 Time(t) Units: Seconds
 Force(F) Units: Pounds
 Pressure(p) Units: psf
 Strength Units: psf
 Unit Weight of Water: 62.4 pcf
 View: 2D
 Element Thickness: 1

Analysis Settings

1 - Circular Mode of Failure

Kind: SLOPE/W
 Method: Bishop
 Settings
 PWP Conditions Source: (none)
 Slip Surface
 Direction of movement: Right to Left
 Use Passive Mode: No
 Slip Surface Option: Entry and Exit
 Critical slip surfaces saved: 10
 Resisting Side Maximum Convex Angle: 1 °
 Driving Side Maximum Convex Angle: 5 °
 Optimize Critical Slip Surface Location: No
 Tension Crack
 Tension Crack Option: (none)

F of S Distribution
 F of S Calculation Option: Constant
 Advanced
 Number of Slices: 30
 F of S Tolerance: 0.01
 Minimum Slip Surface Depth: 0.1 ft

Materials

Fill

Model: Mohr-Coulomb
 Unit Weight: 120 pcf
 Cohesion': 200 psf
 Phi': 33 °
 Phi-B: 0 °

Tmc 150-17° (A- Bed 0°-18°)

Model: Anisotropic Fn.
 Unit Weight: 120 pcf
 Cohesion': 200 psf
 Phi': 40 °
 Phi-Anisotropic Strength Fn.: Tmc 150-17° (A- Bed 0°-18°)
 C-Anisotropic Strength Fn.: 150psf-17° (A- Bed 0°-18°)
 Phi-B: 0 °

Tmc 100-25° (A-Bed -6°-(-11°))

Model: Anisotropic Fn.
 Unit Weight: 120 pcf
 Cohesion': 200 psf
 Phi': 40 °
 Phi-Anisotropic Strength Fn.: Tmc 100-25° (A-Bed -6°-(-11°))
 C-Anisotropic Strength Fn.: 100psf (A-Bed -6°-(-11°))
 Phi-B: 0 °

Tmc 150-17° (A- Bed 0°-(-11°))

Model: Anisotropic Fn.
 Unit Weight: 120 pcf
 Cohesion': 200 psf
 Phi': 40 °
 Phi-Anisotropic Strength Fn.: Tmc 150-17° (A- Bed 0°-(-11°))
 C-Anisotropic Strength Fn.: 150psf-17° (A- Bed 0°-(-11°))
 Phi-B: 0 °

Slip Surface Entry and Exit

Left Projection: Range
 Left-Zone Left Coordinate: (116.082, 2,040.0973) ft
 Left-Zone Right Coordinate: (497.0595, 2,100.471) ft
 Left-Zone Increment: 50

Right Projection: Range
Right-Zone Left Coordinate: (549.9577, 2,124.4788) ft
Right-Zone Right Coordinate: (715.1464, 2,174.3322) ft
Right-Zone Increment: 50
Radius Increments: 50

Slip Surface Limits

Left Coordinate: (-200, 2,024) ft
Right Coordinate: (811, 2,175) ft

Seismic Coefficients

Horz Seismic Coef.: 0
Vert Seismic Coef.: 0

Anisotropic Strength Functions

Tmc 150-17° (A- Bed 0°-(-11°))

Model: Spline Data Point Function
Function: Modifier Factor vs. Inclination
Curve Fit to Data: 100 %
Segment Curvature: 0 %
Y-Intercept: 0.425
Data Points: Inclination (°), Modifier Factor
Data Point: (-90, 1)
Data Point: (-11.1, 1)
Data Point: (-11, 0.425)
Data Point: (0, 0.425)
Data Point: (0.9, 1)

150psf-17° (A- Bed 0°-18°)

Model: Spline Data Point Function
Function: Modifier Factor vs. Inclination
Curve Fit to Data: 100 %
Segment Curvature: 0 %
Y-Intercept: 0.75
Data Points: Inclination (°), Modifier Factor
Data Point: (-90, 1)
Data Point: (-0.9, 1)
Data Point: (0, 0.75)
Data Point: (18, 0.75)
Data Point: (18.1, 1)

Tmc 100-25° (A-Bed -6°-(-11°))

Model: Spline Data Point Function
Function: Modifier Factor vs. Inclination
Curve Fit to Data: 100 %

Segment Curvature: 0 %
Y-Intercept: 1
Data Points: Inclination (°), Modifier Factor
Data Point: (-90, 1)
Data Point: (-11.1, 1)
Data Point: (-11, 0.625)
Data Point: (-6, 0.625)
Data Point: (-5.9, 1)

100psf (A-Bed -6°-(-11°))

Model: Spline Data Point Function
Function: Modifier Factor vs. Inclination
Curve Fit to Data: 100 %
Segment Curvature: 0 %
Y-Intercept: 1
Data Points: Inclination (°), Modifier Factor
Data Point: (-90, 1)
Data Point: (-11.1, 1)
Data Point: (-11, 0.5)
Data Point: (-6, 0.5)
Data Point: (-5.9, 1)

150psf-17° (A- Bed 0°-(-11°))

Model: Spline Data Point Function
Function: Modifier Factor vs. Inclination
Curve Fit to Data: 100 %
Segment Curvature: 0 %
Y-Intercept: 0.75
Data Points: Inclination (°), Modifier Factor
Data Point: (-90, 1)
Data Point: (-11.1, 1)
Data Point: (-11, 0.75)
Data Point: (0, 0.75)
Data Point: (0.9, 1)

Tmc 150-17° (A- Bed 0°-18°)

Model: Spline Data Point Function
Function: Modifier Factor vs. Inclination
Curve Fit to Data: 100 %
Segment Curvature: 0 %
Y-Intercept: 0.425
Data Points: Inclination (°), Modifier Factor
Data Point: (-90, 1)
Data Point: (-0.9, 1)
Data Point: (0, 0.425)
Data Point: (18, 0.425)
Data Point: (18.1, 1)

Points



	X (ft)	Y (ft)
Point 1	-200	2,024
Point 2	26	2,032
Point 3	204	2,048
Point 4	316	2,051
Point 5	408	2,053
Point 6	455	2,084
Point 7	469	2,083
Point 8	522	2,116
Point 9	535	2,117
Point 10	588	2,145
Point 11	600	2,145
Point 12	656	2,171
Point 13	746	2,175
Point 14	778	2,173
Point 15	811	2,175
Point 16	811	2,094
Point 17	810	1,700
Point 18	180	1,700
Point 19	-200	1,700
Point 20	407	1,700
Point 21	557	2,128
Point 22	423	2,038
Point 23	453	2,038

Point 24	727	2,175
Point 25	618	2,120

Regions

	Material	Points	Area (ft²)
Region 1	Tmc 150-17° (A- Bed 0°-(-11°))	17,16,25,23,22,5,20	1.5639e+005
Region 2	Tmc 150-17° (A- Bed 0°-18°)	1,19,18,20,5,4,3,2	2.06e+005
Region 3	Tmc 100-25° (A-Bed -6°-(-11°)	16,15,14,13,24,25	10,062
Region 4	Fill	5,22,23,25,24,12,11,10,21,9,8,7,6	10,039

Current Slip Surface

Slip Surface: 81,412
 F of S: 1.69
 Volume: 3,373.1411 ft³
 Weight: 404,776.94 lbs
 Resisting Moment: 87,226,090 lbs-ft
 Activating Moment: 51,612,584 lbs-ft
 F of S Rank (Analysis): 1 of 132,651 slip surfaces
 F of S Rank (Query): 1 of 10 slip surfaces
 Exit: (408.04237, 2,053.0279) ft
 Entry: (597.63425, 2,145) ft
 Radius: 305.36559 ft
 Center: (377.74289, 2,356.8866) ft

Slip Slices

	X (ft)	Y (ft)	PWP (psf)	Base Normal Stress (psf)	Frictional Strength (psf)	Cohesive Strength (psf)
Slice 1	411.39648	2,053.3999	0	199.2744	129.41031	200
Slice 2	418.10472	2,054.2191	0	606.71458	394.00506	200
Slice 3	424.81295	2,055.1897	0	990.29782	643.10692	200
Slice 4	431.52118	2,056.3131	0	1,350.3367	876.91891	200
Slice 5	438.22942	2,057.5911	0	1,687.0963	1,095.6132	200
Slice 6	444.93765	2,059.0256	0	2,000.7961	1,299.3322	200
Slice 7	451.64588	2,060.6189	0	2,291.6113	1,488.1898	200
Slice 8	458.5	2,062.4154	0	2,287.2438	1,485.3535	200

Slice 9	465.5	2,064.4255	0	1,994.072	1,294.9655	200
Slice 10	472.3125	2,066.5547	0	1,940.1482	1,259.9469	200
Slice 11	478.9375	2,068.7973	0	2,119.8342	1,376.6364	200
Slice 12	485.5625	2,071.211	0	2,277.95	1,479.3181	200
Slice 13	492.1875	2,073.8004	0	2,414.4406	1,567.9561	200
Slice 14	498.8125	2,076.5702	0	2,529.2118	1,642.4893	200
Slice 15	505.4375	2,079.526	0	2,622.1292	1,702.8306	200
Slice 16	512.0625	2,082.6736	0	2,693.0174	1,748.8659	200
Slice 17	518.6875	2,086.0198	0	2,741.6573	1,780.4531	200
Slice 18	525.25	2,089.5366	0	2,592.079	1,683.3158	200
Slice 19	531.75	2,093.2281	0	2,249.7615	1,461.0122	200
Slice 20	538.66667	2,097.4004	0	2,018.6813	1,310.9469	200
Slice 21	546	2,102.0957	0	1,891.561	1,228.394	200
Slice 22	553.33333	2,107.0946	0	1,737.3579	1,128.2534	200
Slice 23	560.1	2,111.9803	0	1,585.7026	1,029.7673	200
Slice 24	566.3	2,116.7224	0	1,439.3008	934.69284	200
Slice 25	572.5	2,121.7237	0	1,271.5684	825.76619	200
Slice 26	578.7	2,127.0009	0	1,081.9922	702.65394	200
Slice 27	584.9	2,132.5737	0	870.01372	564.99351	200
Slice 28	590.40856	2,137.7743	0	548.38207	356.12348	200
Slice 29	595.22569	2,142.556	0	124.86914	81.090969	200

Section 15-15 Seismic Final with key SSA for Skyline Ranch.gsz

Section 15-15 Seismic Final with key SSA for Skyline Ranch.gsz Run By: Dr. Alexander Bykovtsev, Ph.D., P.E. 3/24/2016 2:50:53 PM

Seismic load
Horizontal: 0.15
Vertical: 0.0

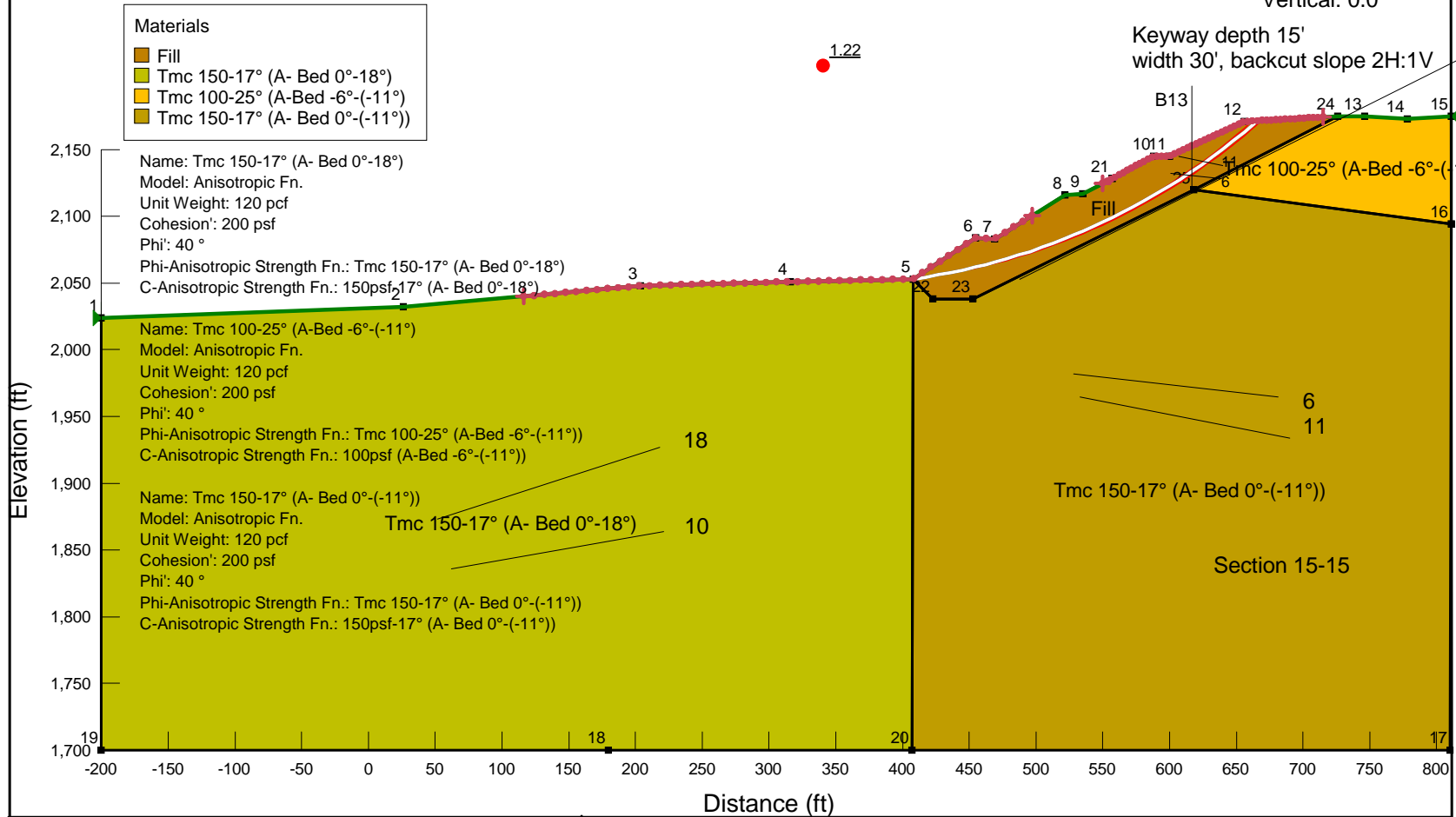

LGC Valley, Inc
GEOTECHNICAL CONSULTING
28532 Constellation Road, Valencia, CA 91355
Phone 661-702-8474, Fax 661-702-8475

Skyline Ranch
Development project, Tract 60922
Los Angeles CA

Project No: 153035-01
Engineer: BAS
Date: March 2016

1 - Circular Mode of Failure

Report generated using GeoStudio 2012. Copyright © 1991-2015 GEO-SLOPE International Ltd.

File Information

File Version: 8.15
 Title: Static Slope Stability Analyses for Skyline Ranch Development project, Tract 60922, Los Angeles CA
 Comments: Run By: Dr. Alexander Bykovtsev, Ph.D., P.E.
 Last Edited By: Alexander Bykovtsev
 Revision Number: 123
 Date: 3/24/2016
 Time: 2:50:53 PM
 Tool Version: 8.15.1.11236
 File Name: Section 15-15 Seismic Final with key SSA for Skyline Ranch.gsz
 Directory: G:\SLOPE RESULTS\Section 15-15 results\
 Last Solved Date: 3/24/2016
 Last Solved Time: 2:51:08 PM

Project Settings

Length(L) Units: Feet
 Time(t) Units: Seconds
 Force(F) Units: Pounds
 Pressure(p) Units: psf
 Strength Units: psf
 Unit Weight of Water: 62.4 pcf
 View: 2D
 Element Thickness: 1

Analysis Settings

1 - Circular Mode of Failure

Kind: SLOPE/W
 Method: Bishop
 Settings
 PWP Conditions Source: (none)
 Slip Surface
 Direction of movement: Right to Left
 Use Passive Mode: No
 Slip Surface Option: Entry and Exit
 Critical slip surfaces saved: 10
 Resisting Side Maximum Convex Angle: 1 °
 Driving Side Maximum Convex Angle: 5 °
 Optimize Critical Slip Surface Location: No
 Tension Crack
 Tension Crack Option: (none)

file:///G:/SLOPE%20RESULTS/Section%2015-15%20results/section%2015-15%20seismi... 3/24/2016

F of S Distribution
 F of S Calculation Option: Constant
 Advanced
 Number of Slices: 30
 F of S Tolerance: 0.01
 Minimum Slip Surface Depth: 0.1 ft

Materials

Fill

Model: Mohr-Coulomb
 Unit Weight: 120 pcf
 Cohesion': 200 psf
 Phi': 33 °
 Phi-B: 0 °

Tmc 150-17° (A- Bed 0°-18°)

Model: Anisotropic Fn.
 Unit Weight: 120 pcf
 Cohesion': 200 psf
 Phi': 40 °
 Phi-Anisotropic Strength Fn.: Tmc 150-17° (A- Bed 0°-18°)
 C-Anisotropic Strength Fn.: 150psf-17° (A- Bed 0°-18°)
 Phi-B: 0 °

Tmc 100-25° (A-Bed -6°-(-11°))

Model: Anisotropic Fn.
 Unit Weight: 120 pcf
 Cohesion': 200 psf
 Phi': 40 °
 Phi-Anisotropic Strength Fn.: Tmc 100-25° (A-Bed -6°-(-11°))
 C-Anisotropic Strength Fn.: 100psf (A-Bed -6°-(-11°))
 Phi-B: 0 °

Tmc 150-17° (A- Bed 0°-(-11°))

Model: Anisotropic Fn.
 Unit Weight: 120 pcf
 Cohesion': 200 psf
 Phi': 40 °
 Phi-Anisotropic Strength Fn.: Tmc 150-17° (A- Bed 0°-(-11°))
 C-Anisotropic Strength Fn.: 150psf-17° (A- Bed 0°-(-11°))
 Phi-B: 0 °

Slip Surface Entry and Exit

Left Projection: Range
 Left-Zone Left Coordinate: (116.082, 2,040.0973) ft
 Left-Zone Right Coordinate: (497.0595, 2,100.471) ft
 Left-Zone Increment: 50

file:///G:/SLOPE%20RESULTS/Section%2015-15%20results/section%2015-15%20seismi... 3/24/2016

Right Projection: Range
Right-Zone Left Coordinate: (549.9577, 2,124.4788) ft
Right-Zone Right Coordinate: (714.9781, 2,174.3702) ft
Right-Zone Increment: 50
Radius Increments: 50

Slip Surface Limits

Left Coordinate: (-200, 2,024) ft
Right Coordinate: (811, 2,175) ft

Seismic Coefficients

Horz Seismic Coef.: 0.15
Vert Seismic Coef.: 0

Anisotropic Strength Functions

Tmc 150-17° (A- Bed 0°-(-11°))

Model: Spline Data Point Function
Function: Modifier Factor vs. Inclination
Curve Fit to Data: 100 %
Segment Curvature: 0 %
Y-Intercept: 0.425
Data Points: Inclination (°), Modifier Factor
Data Point: (-90, 1)
Data Point: (-11.1, 1)
Data Point: (-11, 0.425)
Data Point: (0, 0.425)
Data Point: (0.9, 1)

150psf-17° (A- Bed 0°-18°)

Model: Spline Data Point Function
Function: Modifier Factor vs. Inclination
Curve Fit to Data: 100 %
Segment Curvature: 0 %
Y-Intercept: 0.75
Data Points: Inclination (°), Modifier Factor
Data Point: (-90, 1)
Data Point: (-0.9, 1)
Data Point: (0, 0.75)
Data Point: (18, 0.75)
Data Point: (18.1, 1)

Tmc 100-25° (A-Bed -6°-(-11°))

Model: Spline Data Point Function
Function: Modifier Factor vs. Inclination
Curve Fit to Data: 100 %

Segment Curvature: 0 %
Y-Intercept: 1
Data Points: Inclination (°), Modifier Factor
Data Point: (-90, 1)
Data Point: (-11.1, 1)
Data Point: (-11, 0.625)
Data Point: (-6, 0.625)
Data Point: (-5.9, 1)

100psf (A-Bed -6°-(-11°))

Model: Spline Data Point Function
Function: Modifier Factor vs. Inclination
Curve Fit to Data: 100 %
Segment Curvature: 0 %
Y-Intercept: 1
Data Points: Inclination (°), Modifier Factor
Data Point: (-90, 1)
Data Point: (-11.1, 1)
Data Point: (-11, 0.5)
Data Point: (-6, 0.5)
Data Point: (-5.9, 1)

150psf-17° (A- Bed 0°-(-11°))

Model: Spline Data Point Function
Function: Modifier Factor vs. Inclination
Curve Fit to Data: 100 %
Segment Curvature: 0 %
Y-Intercept: 0.75
Data Points: Inclination (°), Modifier Factor
Data Point: (-90, 1)
Data Point: (-11.1, 1)
Data Point: (-11, 0.75)
Data Point: (0, 0.75)
Data Point: (0.9, 1)

Tmc 150-17° (A- Bed 0°-18°)

Model: Spline Data Point Function
Function: Modifier Factor vs. Inclination
Curve Fit to Data: 100 %
Segment Curvature: 0 %
Y-Intercept: 0.425
Data Points: Inclination (°), Modifier Factor
Data Point: (-90, 1)
Data Point: (-0.9, 1)
Data Point: (0, 0.425)
Data Point: (18, 0.425)
Data Point: (18.1, 1)

Points



	X (ft)	Y (ft)
Point 1	-200	2,024
Point 2	26	2,032
Point 3	204	2,048
Point 4	316	2,051
Point 5	408	2,053
Point 6	455	2,084
Point 7	469	2,083
Point 8	522	2,116
Point 9	535	2,117
Point 10	588	2,145
Point 11	600	2,145
Point 12	656	2,171
Point 13	746	2,175
Point 14	778	2,173
Point 15	811	2,175
Point 16	811	2,094
Point 17	810	1,700
Point 18	180	1,700
Point 19	-200	1,700
Point 20	407	1,700
Point 21	557	2,128
Point 22	423	2,038
Point 23	453	2,038

Point 24	726	2,175
Point 25	618	2,120

Regions

	Material	Points	Area (ft²)
Region 1	Tmc 150-17° (A- Bed 0°-(-11°))	17,16,25,23,22,5,20	1.5639e+005
Region 2	Tmc 150-17° (A- Bed 0°-18°)	1,19,18,20,5,4,3,2	2.06e+005
Region 3	Tmc 100-25° (A-Bed -6°-(-11°)	16,15,14,13,24,25	10,089
Region 4	Fill	5,22,23,25,24,12,11,10,21,9,8,7,6	10,014

Current Slip Surface

Slip Surface: 59,072
 F of S: 1.22
 Volume: 5,332.3803 ft³
 Weight: 639,885.63 lbs
 Resisting Moment: 2.0775189e+008 lbs-ft
 Activating Moment: 1.7087178e+008 lbs-ft
 F of S Rank (Analysis): 1 of 132,651 slip surfaces
 F of S Rank (Query): 1 of 10 slip surfaces
 Exit: (408.0629, 2,053.0415) ft
 Entry: (665.76589, 2,171.5581) ft
 Radius: 497.95078 ft
 Center: (337.47416, 2,545.9636) ft

Slip Slices

	X (ft)	Y (ft)	PWP (psf)	Base Normal Stress (psf)	Frictional Strength (psf)	Cohesive Strength (psf)
Slice 1	412.75661	2,053.7594	0	240.6821	156.30078	200
Slice 2	422.14403	2,055.2872	0	748.01618	485.76739	200
Slice 3	431.53145	2,057	0	1,225.4595	795.82272	200
Slice 4	440.91887	2,058.8998	0	1,673.4931	1,086.7791	200
Slice 5	450.30629	2,060.9887	0	2,092.548	1,358.9166	200
Slice 6	458.5	2,062.9577	0	2,165.1899	1,406.0908	200
Slice 7	465.5	2,064.7659	0	1,904.7084	1,236.9321	200
Slice 8	473.41667	2,066.9505	0	1,919.4316	1,246.4934	200

Slice 9	482.25	2,069.5461	0	2,198.9284	1,428.0008	200
Slice 10	491.08333	2,072.3207	0	2,454.5819	1,594.0241	200
Slice 11	499.91667	2,075.2773	0	2,686.5675	1,744.6774	200
Slice 12	508.75	2,078.4195	0	2,895.0316	1,880.0555	200
Slice 13	517.58333	2,081.7511	0	3,080.0916	2,000.2349	200
Slice 14	525.25	2,084.788	0	3,048.0219	1,979.4086	200
Slice 15	531.75	2,087.4885	0	2,808.4051	1,823.7996	200
Slice 16	538.66667	2,090.4853	0	2,695.5171	1,750.4893	200
Slice 17	546	2,093.7959	0	2,704.8535	1,756.5524	200
Slice 18	553.33333	2,097.2507	0	2,699.6877	1,753.1977	200
Slice 19	560.875	2,100.96	0	2,696.7984	1,751.3213	200
Slice 20	568.625	2,104.9362	0	2,694.8414	1,750.0505	200
Slice 21	576.375	2,109.0862	0	2,676.0126	1,737.8229	200
Slice 22	584.125	2,113.4148	0	2,640.273	1,714.6133	200
Slice 23	594	2,119.2313	0	2,267.9321	1,472.8123	200
Slice 24	604	2,125.3729	0	1,850.1048	1,201.4721	200
Slice 25	612	2,130.5511	0	1,697.0741	1,102.0928	200
Slice 26	620	2,135.9508	0	1,527.0723	991.69232	200
Slice 27	628	2,141.5808	0	1,340.0231	870.22115	200
Slice 28	636	2,147.451	0	1,135.843	737.62508	200
Slice 29	644	2,153.5721	0	914.44314	593.84632	200
Slice 30	652	2,159.956	0	675.73114	438.82493	200
Slice 31	660.88295	2,167.3867	0	224.79826	145.9857	200

Section 15-15 Static Final with key SSA for Skyline Ranch.gsz

Section 15-15 Static Final with key SSA for Skyline Ranch.gsz Run By: Dr. Alexander Bykovtsev, Ph.D., P.E. 3/23/2016 9:49:45 AM

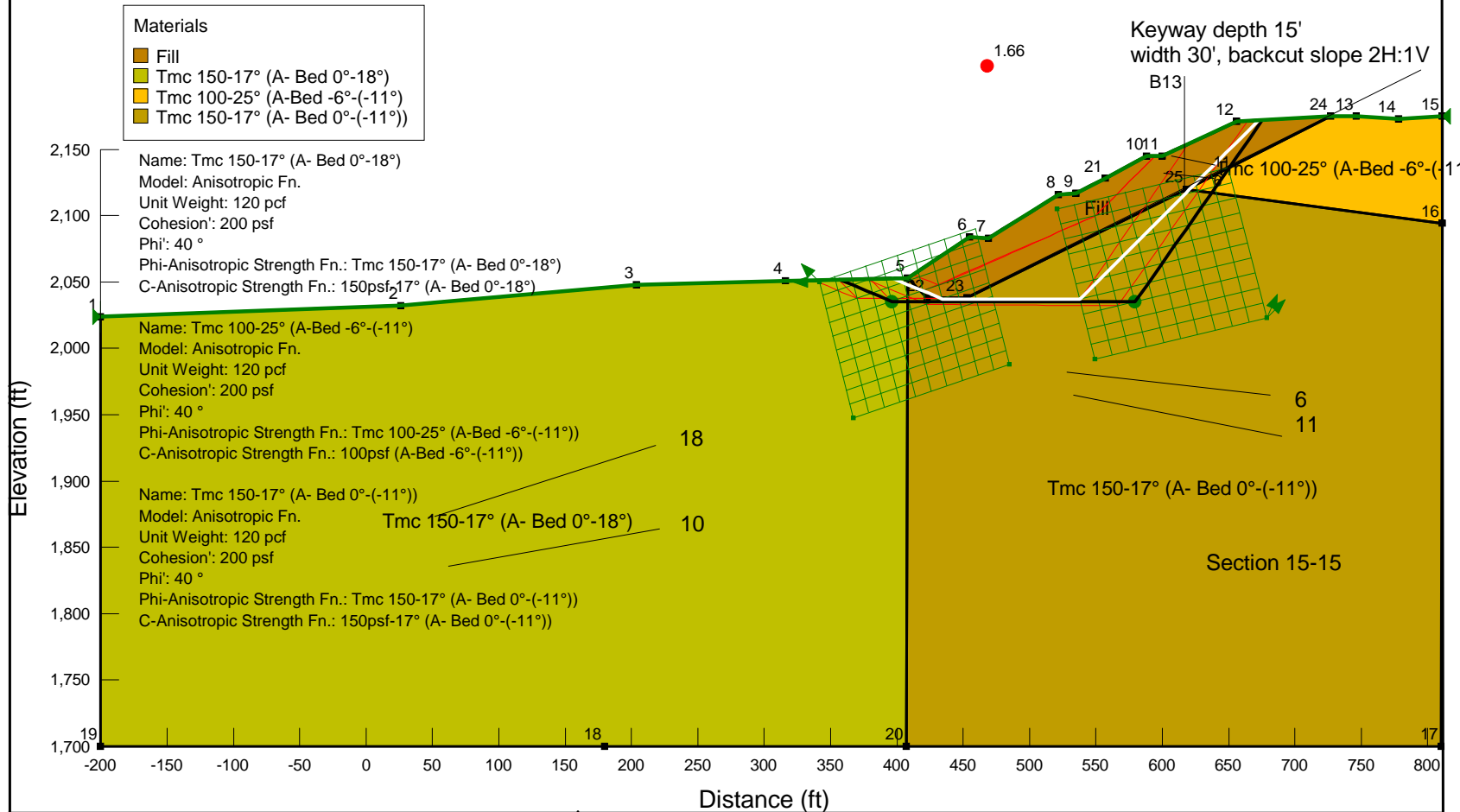

LGC **LGC Valley, Inc**
 GEOTECHNICAL CONSULTING
 28532 Constellation Road, Valencia, CA 91355
 Phone 661-702-8474, Fax 661-702-8475

Skyline Ranch
 Development project, Tract 60922
 Los Angeles CA

Project No: **153035-01**
 Engineer: **BAS**
 Date: **March 2016**

2 - Translational

Report generated using GeoStudio 2012. Copyright © 1991-2015 GEO-SLOPE International Ltd.

File Information

File Version: 8.15
 Title: Static Slope Stability Analyses for Skyline Ranch Development project, Tract 60922, Los Angeles CA
 Comments: Run By: Dr. Alexander Bykovtsev, Ph.D., P.E.
 Last Edited By: Alexander Bykovtsev
 Revision Number: 122
 Date: 3/23/2016
 Time: 9:49:45 AM
 Tool Version: 8.15.1.11236
 File Name: Section 15-15 Static Final with key SSA for Skyline Ranch.gsz
 Directory: G:\SLOPE RESULTS\Section 15-15 results\
 Last Solved Date: 3/24/2016
 Last Solved Time: 2:56:43 PM

Project Settings

Length(L) Units: Feet
 Time(t) Units: Seconds
 Force(F) Units: Pounds
 Pressure(p) Units: psf
 Strength Units: psf
 Unit Weight of Water: 62.4 pcf
 View: 2D
 Element Thickness: 1

Analysis Settings

2 - Translational

Kind: [SLOPE/W](#)
 Method: [Janbu](#)
 Settings
 PWP Conditions Source: [\(none\)](#)
 Slip Surface
 Direction of movement: [Right to Left](#)
 Use Passive Mode: [No](#)
 Slip Surface Option: [Block](#)
 Critical slip surfaces saved: [10](#)
 Resisting Side Maximum Convex Angle: [1 °](#)
 Driving Side Maximum Convex Angle: [5 °](#)
 Restrict Block Crossing: [No](#)
 Optimize Critical Slip Surface Location: [No](#)
 Tension Crack

Tension Crack Option: [\(none\)](#)
 F of S Distribution
 F of S Calculation Option: [Constant](#)
 Advanced
 Number of Slices: [30](#)
 F of S Tolerance: [0.01](#)
 Minimum Slip Surface Depth: [0.1 ft](#)

Materials

Fill

Model: [Mohr-Coulomb](#)
 Unit Weight: [120 pcf](#)
 Cohesion': [200 psf](#)
 Phi': [33 °](#)
 Phi-B: [0 °](#)

Tmc 150-17° (A- Bed 0°-18°)

Model: [Anisotropic Fn.](#)
 Unit Weight: [120 pcf](#)
 Cohesion': [200 psf](#)
 Phi': [40 °](#)
 Phi-Anisotropic Strength Fn.: [Tmc 150-17° \(A- Bed 0°-18°\)](#)
 C-Anisotropic Strength Fn.: [150psf-17° \(A- Bed 0°-18°\)](#)
 Phi-B: [0 °](#)

Tmc 100-25° (A-Bed -6°-(-11°))

Model: [Anisotropic Fn.](#)
 Unit Weight: [120 pcf](#)
 Cohesion': [200 psf](#)
 Phi': [40 °](#)
 Phi-Anisotropic Strength Fn.: [Tmc 100-25° \(A-Bed -6°-\(-11°\)\)](#)
 C-Anisotropic Strength Fn.: [100psf \(A-Bed -6°-\(-11°\)\)](#)
 Phi-B: [0 °](#)

Tmc 150-17° (A- Bed 0°-(-11°))

Model: [Anisotropic Fn.](#)
 Unit Weight: [120 pcf](#)
 Cohesion': [200 psf](#)
 Phi': [40 °](#)
 Phi-Anisotropic Strength Fn.: [Tmc 150-17° \(A- Bed 0°-\(-11°\)\)](#)
 C-Anisotropic Strength Fn.: [150psf-17° \(A- Bed 0°-\(-11°\)\)](#)
 Phi-B: [0 °](#)

Slip Surface Limits

Left Coordinate: [\(-200, 2,024\) ft](#)
 Right Coordinate: [\(811, 2,175\) ft](#)

Slip Surface Block

Left Grid

Upper Left: (341.5832, 2,050.0454) ft
 Lower Left: (367.0512, 1,947.4848) ft
 Lower Right: (484.9793, 1,987.7541) ft
 X Increments: 10
 Y Increments: 10
 Starting Angle: 135 °
 Ending Angle: 180 °
 Angle Increments: 2

Right Grid

Upper Left: (520.6643, 2,104.9641) ft
 Lower Left: (549.385, 1,991.8817) ft
 Lower Right: (678.6285, 2,022.7223) ft
 X Increments: 10
 Y Increments: 10
 Starting Angle: 45 °
 Ending Angle: 65 °
 Angle Increments: 2

Seismic Coefficients

Horz Seismic Coef.: 0
 Vert Seismic Coef.: 0

Anisotropic Strength Functions

Tmc 150-17° (A- Bed 0°-(-11°))

Model: Spline Data Point Function
 Function: Modifier Factor vs. Inclination
 Curve Fit to Data: 100 %
 Segment Curvature: 0 %

Y-Intercept: 0.425

Data Points: Inclination (°), Modifier Factor
 Data Point: (-90, 1)
 Data Point: (-11.1, 1)
 Data Point: (-11, 0.425)
 Data Point: (0, 0.425)
 Data Point: (0.9, 1)

150psf-17° (A- Bed 0°-18°)

Model: Spline Data Point Function
 Function: Modifier Factor vs. Inclination
 Curve Fit to Data: 100 %
 Segment Curvature: 0 %

Y-Intercept: 0.75

Data Points: Inclination (°), Modifier Factor
 Data Point: (-90, 1)

Data Point: (-0.9, 1)
 Data Point: (0, 0.75)
 Data Point: (18, 0.75)
 Data Point: (18.1, 1)

Tmc 100-25° (A-Bed -6°-(-11°))

Model: Spline Data Point Function
 Function: Modifier Factor vs. Inclination
 Curve Fit to Data: 100 %
 Segment Curvature: 0 %

Y-Intercept: 1

Data Points: Inclination (°), Modifier Factor
 Data Point: (-90, 1)
 Data Point: (-11.1, 1)
 Data Point: (-11, 0.625)
 Data Point: (-6, 0.625)
 Data Point: (-5.9, 1)

100psf (A-Bed -6°-(-11°))

Model: Spline Data Point Function
 Function: Modifier Factor vs. Inclination
 Curve Fit to Data: 100 %
 Segment Curvature: 0 %

Y-Intercept: 1

Data Points: Inclination (°), Modifier Factor
 Data Point: (-90, 1)
 Data Point: (-11.1, 1)
 Data Point: (-11, 0.5)
 Data Point: (-6, 0.5)
 Data Point: (-5.9, 1)

150psf-17° (A- Bed 0°-(-11°))

Model: Spline Data Point Function
 Function: Modifier Factor vs. Inclination
 Curve Fit to Data: 100 %
 Segment Curvature: 0 %

Y-Intercept: 0.75

Data Points: Inclination (°), Modifier Factor
 Data Point: (-90, 1)
 Data Point: (-11.1, 1)
 Data Point: (-11, 0.75)
 Data Point: (0, 0.75)
 Data Point: (0.9, 1)

Tmc 150-17° (A- Bed 0°-18°)

Model: Spline Data Point Function
 Function: Modifier Factor vs. Inclination
 Curve Fit to Data: 100 %
 Segment Curvature: 0 %

Y-Intercept: 0.425

Data Points: Inclination (°), Modifier Factor

- Data Point: (-90, 1)
- Data Point: (-0.9, 1)
- Data Point: (0, 0.425)
- Data Point: (18, 0.425)
- Data Point: (18.1, 1)

Points

	X (ft)	Y (ft)
Point 1	-200	2,024
Point 2	26	2,032
Point 3	204	2,048
Point 4	316	2,051
Point 5	408	2,053
Point 6	455	2,084
Point 7	469	2,083
Point 8	522	2,116
Point 9	535	2,117
Point 10	588	2,145
Point 11	600	2,145
Point 12	656	2,171
Point 13	746	2,175
Point 14	778	2,173
Point 15	811	2,175
Point 16	811	2,094
Point 17	810	1,700
Point 18	180	1,700
Point 19	-200	1,700
Point 20	407	1,700
Point 21	557	2,128
Point 22	423	2,038
Point 23	453	2,038
Point 24	727	2,175
Point 25	618	2,120

Regions

	Material	Points	Area (ft²)
Region 1	Tmc 150-17° (A- Bed 0°-(-11°))	17,16,25,23,22,5,20	1.5639e+005
Region 2	Tmc 150-17° (A- Bed 0°-18°)	1,19,18,20,5,4,3,2	2.06e+005
Region 3	Tmc 100-25° (A-Bed -6°-(-11°)	16,15,14,13,24,25	10,062
Region 4	Fill	5,22,23,25,24,12,11,10,21,9,8,7,6	10,039

Current Slip Surface

Slip Surface: 88,682
 F of S: 1.66
 Volume: 16,605.485 ft³
 Weight: 1,992,658.2 lbs
 Resisting Force: 800,243.14 lbs
 Activating Force: 481,801.42 lbs
 F of S Rank (Analysis): 4 of 131,769 slip surfaces
 F of S Rank (Query): 4 of 10 slip surfaces
 Exit: (356.56764, 2,051.8819) ft
 Entry: (675.4982, 2,172.0985) ft
 Radius: 187.31574 ft
 Center: (482.0474, 2,202.1526) ft

Slip Slices

	X (ft)	Y (ft)	PWP (psf)	Base Normal Stress (psf)	Frictional Strength (psf)	Cohesive Strength (psf)
Slice 1	361.54604	2,049.8198	0	393.26169	329.98574	200
Slice 2	371.50284	2,045.6955	0	1,052.8474	883.44389	200
Slice 3	381.45964	2,041.5713	0	1,712.4332	1,436.902	200
Slice 4	391.41644	2,037.4471	0	2,372.0189	1,990.3602	200
Slice 5	402.19742	2,035.3746	0	2,100.8855	748.46451	155.67179
Slice 6	415.5	2,035.3509	0	2,712.5651	829.31437	150
Slice 7	428	2,035.3286	0	3,704.9266	1,132.7097	150
Slice 8	438	2,035.3108	0	4,498.8159	1,375.426	150
Slice 9	448	2,035.293	0	5,292.7051	1,618.1423	150
Slice 10	454	2,035.2823	0	5,769.0387	1,763.7721	150
Slice 11	462	2,035.268	0	5,789.9051	1,770.1516	150
Slice 12	474.3	2,035.2461	0	6,128.6467	1,873.7153	150
Slice 13	484.9	2,035.2272	0	6,923.1751	2,116.627	150
Slice 14	495.5	2,035.2084	0	7,717.7035	2,359.5387	150
Slice 15	506.1	2,035.1895	0	8,512.2319	2,602.4504	150
	516.7	2,035.1706	0	9,306.7603	2,845.3622	150

Slice 16						
Slice 17	528.5	2,035.1495	0	9,765.4345	2,985.593	150
Slice 18	540.5	2,035.1282	0	10,158.13	3,105.652	150
Slice 19	551.5	2,035.1086	0	10,820.7	3,308.2201	150
Slice 20	562.63546	2,035.0887	0	11,524.163	3,523.2901	150
Slice 21	573.90638	2,035.0686	0	12,268.517	3,750.8621	150
Slice 22	583.77092	2,041.0984	0	6,966.2633	5,845.3889	200
Slice 23	594	2,055.707	0	6,111.3636	5,128.043	200
Slice 24	604.5	2,070.7025	0	5,213.5571	4,374.6939	200
Slice 25	613.5	2,083.5559	0	4,610.1095	3,868.3412	200
Slice 26	622.80168	2,096.84	0	3,986.4346	3,345.0158	200
Slice 27	632.40503	2,110.5551	0	3,342.5322	2,804.7175	200
Slice 28	643.85429	2,126.9063	0	2,574.8625	2,160.5662	200
Slice 29	653.25094	2,140.3261	0	2,149.0112	1,395.5842	200
Slice 30	660.87455	2,151.2137	0	1,431.3264	929.51426	200
Slice 31	670.62365	2,165.1369	0	403.31036	261.91281	200

Section 15-15 Seismic Final with key SSA for Skyline Ranch.gsz

Section 15-15 Seismic Final with key SSA for Skyline Ranch.gsz Run By: Dr. Alexander Bykovtsev, Ph.D., P.E. 3/23/2016 10:01:34 AM

Seismic load
Horizontal: 0.15
Vertical: 0.0

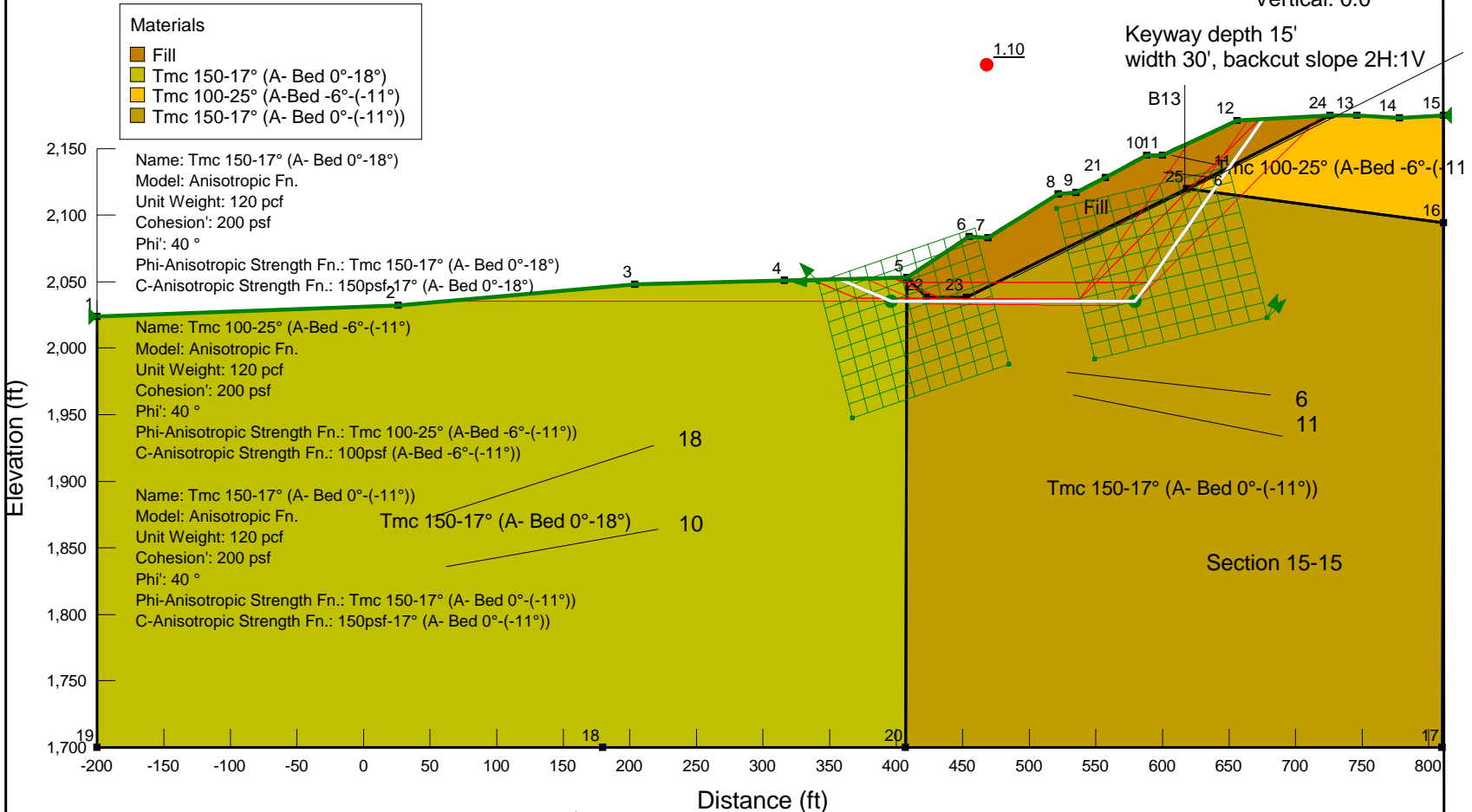

LGC **LGC Valley, Inc**
 GEOTECHNICAL CONSULTING
 28532 Constellation Road, Valencia, CA 91355
 Phone 661-702-8474, Fax 661-702-8475

Skyline Ranch
 Development project, Tract 60922
 Los Angeles CA

Project No: **153035-01**
 Engineer: **BAS**
 Date: **March 2016**

2 - Translational

Report generated using GeoStudio 2012. Copyright © 1991-2015 GEO-SLOPE International Ltd.

File Information

File Version: 8.15
 Title: Static Slope Stability Analyses for Skyline Ranch Development project, Tract 60922, Los Angeles CA
 Comments: Run By: Dr. Alexander Bykovtsev, Ph.D., P.E.
 Last Edited By: Alexander Bykovtsev
 Revision Number: 122
 Date: 3/23/2016
 Time: 10:01:34 AM
 Tool Version: 8.15.1.11236
 File Name: Section 15-15 Seismic Final with key SSA for Skyline Ranch.gsz
 Directory: G:\SLOPE RESULTS\Section 15-15 results\
 Last Solved Date: 3/24/2016
 Last Solved Time: 2:45:37 PM

Project Settings

Length(L) Units: Feet
 Time(t) Units: Seconds
 Force(F) Units: Pounds
 Pressure(p) Units: psf
 Strength Units: psf
 Unit Weight of Water: 62.4 pcf
 View: 2D
 Element Thickness: 1

Analysis Settings

2 - Translational

Kind: SLOPE/W
 Method: Janbu
 Settings
 PWP Conditions Source: (none)
 Slip Surface
 Direction of movement: Right to Left
 Use Passive Mode: No
 Slip Surface Option: Block
 Critical slip surfaces saved: 10
 Resisting Side Maximum Convex Angle: 1 °
 Driving Side Maximum Convex Angle: 5 °
 Restrict Block Crossing: No
 Optimize Critical Slip Surface Location: No
 Tension Crack

file:///G:/SLOPE%20RESULTS/Section%2015-15%20results/section%2015-15%20seismi... 3/24/2016

Tension Crack Option: (none)
 F of S Distribution
 F of S Calculation Option: Constant
 Advanced
 Number of Slices: 30
 F of S Tolerance: 0.01
 Minimum Slip Surface Depth: 0.1 ft

Materials

Fill

Model: Mohr-Coulomb
 Unit Weight: 120 pcf
 Cohesion': 200 psf
 Phi': 33 °
 Phi-B: 0 °

Tmc 150-17° (A- Bed 0°-18°)

Model: Anisotropic Fn.
 Unit Weight: 120 pcf
 Cohesion': 200 psf
 Phi': 40 °
 Phi-Anisotropic Strength Fn.: Tmc 150-17° (A- Bed 0°-18°)
 C-Anisotropic Strength Fn.: 150psf-17° (A- Bed 0°-18°)
 Phi-B: 0 °

Tmc 100-25° (A-Bed -6°-(-11°))

Model: Anisotropic Fn.
 Unit Weight: 120 pcf
 Cohesion': 200 psf
 Phi': 40 °
 Phi-Anisotropic Strength Fn.: Tmc 100-25° (A-Bed -6°-(-11°))
 C-Anisotropic Strength Fn.: 100psf (A-Bed -6°-(-11°))
 Phi-B: 0 °

Tmc 150-17° (A- Bed 0°-(-11°))

Model: Anisotropic Fn.
 Unit Weight: 120 pcf
 Cohesion': 200 psf
 Phi': 40 °
 Phi-Anisotropic Strength Fn.: Tmc 150-17° (A- Bed 0°-(-11°))
 C-Anisotropic Strength Fn.: 150psf-17° (A- Bed 0°-(-11°))
 Phi-B: 0 °

Slip Surface Limits

Left Coordinate: (-200, 2,024) ft
 Right Coordinate: (811, 2,175) ft

file:///G:/SLOPE%20RESULTS/Section%2015-15%20results/section%2015-15%20seismi... 3/24/2016

Slip Surface Block

Left Grid

Upper Left: (341.5832, 2,050.0454) ft
 Lower Left: (367.0512, 1,947.4848) ft
 Lower Right: (484.9793, 1,987.7541) ft
 X Increments: 10
 Y Increments: 10
 Starting Angle: 135 °
 Ending Angle: 180 °
 Angle Increments: 2

Right Grid

Upper Left: (520.6643, 2,104.9641) ft
 Lower Left: (549.385, 1,991.8817) ft
 Lower Right: (678.6285, 2,022.7223) ft
 X Increments: 10
 Y Increments: 10
 Starting Angle: 45 °
 Ending Angle: 65 °
 Angle Increments: 2

Seismic Coefficients

Horz Seismic Coef.: 0.15
 Vert Seismic Coef.: 0

Anisotropic Strength Functions

Tmc 150-17° (A- Bed 0°-(-11°))

Model: Spline Data Point Function
 Function: Modifier Factor vs. Inclination
 Curve Fit to Data: 100 %
 Segment Curvature: 0 %

Y-Intercept: 0.425

Data Points: Inclination (°), Modifier Factor
 Data Point: (-90, 1)
 Data Point: (-11.1, 1)
 Data Point: (-11, 0.425)
 Data Point: (0, 0.425)
 Data Point: (0.9, 1)

150psf-17° (A- Bed 0°-18°)

Model: Spline Data Point Function
 Function: Modifier Factor vs. Inclination
 Curve Fit to Data: 100 %
 Segment Curvature: 0 %

Y-Intercept: 0.75

Data Points: Inclination (°), Modifier Factor
 Data Point: (-90, 1)

Data Point: (-0.9, 1)
 Data Point: (0, 0.75)
 Data Point: (18, 0.75)
 Data Point: (18.1, 1)

Tmc 100-25° (A-Bed -6°-(-11°))

Model: Spline Data Point Function
 Function: Modifier Factor vs. Inclination
 Curve Fit to Data: 100 %
 Segment Curvature: 0 %

Y-Intercept: 1

Data Points: Inclination (°), Modifier Factor
 Data Point: (-90, 1)
 Data Point: (-11.1, 1)
 Data Point: (-11, 0.625)
 Data Point: (-6, 0.625)
 Data Point: (-5.9, 1)

100psf (A-Bed -6°-(-11°))

Model: Spline Data Point Function
 Function: Modifier Factor vs. Inclination
 Curve Fit to Data: 100 %
 Segment Curvature: 0 %

Y-Intercept: 1

Data Points: Inclination (°), Modifier Factor
 Data Point: (-90, 1)
 Data Point: (-11.1, 1)
 Data Point: (-11, 0.5)
 Data Point: (-6, 0.5)
 Data Point: (-5.9, 1)

150psf-17° (A- Bed 0°-(-11°))

Model: Spline Data Point Function
 Function: Modifier Factor vs. Inclination
 Curve Fit to Data: 100 %
 Segment Curvature: 0 %

Y-Intercept: 0.75

Data Points: Inclination (°), Modifier Factor
 Data Point: (-90, 1)
 Data Point: (-11.1, 1)
 Data Point: (-11, 0.75)
 Data Point: (0, 0.75)
 Data Point: (0.9, 1)

Tmc 150-17° (A- Bed 0°-18°)

Model: Spline Data Point Function
 Function: Modifier Factor vs. Inclination
 Curve Fit to Data: 100 %
 Segment Curvature: 0 %

Y-Intercept: 0.425

Data Points: Inclination (°), Modifier Factor

- Data Point: (-90, 1)
- Data Point: (-0.9, 1)
- Data Point: (0, 0.425)
- Data Point: (18, 0.425)
- Data Point: (18.1, 1)

Points

	X (ft)	Y (ft)
Point 1	-200	2,024
Point 2	26	2,032
Point 3	204	2,048
Point 4	316	2,051
Point 5	408	2,053
Point 6	455	2,084
Point 7	469	2,083
Point 8	522	2,116
Point 9	535	2,117
Point 10	588	2,145
Point 11	600	2,145
Point 12	656	2,171
Point 13	746	2,175
Point 14	778	2,173
Point 15	811	2,175
Point 16	811	2,094
Point 17	810	1,700
Point 18	180	1,700
Point 19	-200	1,700
Point 20	407	1,700
Point 21	557	2,128
Point 22	423	2,038
Point 23	453	2,038
Point 24	726	2,175
Point 25	618	2,120

Regions

	Material	Points	Area (ft²)
Region 1	Tmc 150-17° (A- Bed 0°-(-11°))	17,16,25,23,22,5,20	1.5639e+005
Region 2	Tmc 150-17° (A- Bed 0°-18°)	1,19,18,20,5,4,3,2	2.06e+005
Region 3	Tmc 100-25° (A-Bed -6°-(-11°)	16,15,14,13,24,25	10,089
Region 4	Fill	5,22,23,25,24,12,11,10,21,9,8,7,6	10,014

Current Slip Surface

Slip Surface: 88,682
 F of S: 1.10
 Volume: 16,605.638 ft³
 Weight: 1,992,676.6 lbs
 Resisting Force: 755,815.65 lbs
 Activating Force: 685,211.77 lbs
 F of S Rank (Analysis): 1 of 131,769 slip surfaces
 F of S Rank (Query): 1 of 10 slip surfaces
 Exit: (356.56764, 2,051.8819) ft
 Entry: (675.50965, 2,172.1148) ft
 Radius: 187.33243 ft
 Center: (482.0451, 2,202.1731) ft

Slip Slices

	X (ft)	Y (ft)	PWP (psf)	Base Normal Stress (psf)	Frictional Strength (psf)	Cohesive Strength (psf)
Slice 1	361.54604	2,049.8198	0	488.0084	409.48767	200
Slice 2	371.50284	2,045.6955	0	1,246.5371	1,045.9688	200
Slice 3	381.45964	2,041.5713	0	2,005.0657	1,682.4499	200
Slice 4	391.41644	2,037.4471	0	2,763.5944	2,318.931	200
Slice 5	402.19742	2,035.3746	0	2,101.3632	748.63471	155.67179
Slice 6	415.5	2,035.3509	0	2,713.0825	829.47257	150
Slice 7	428	2,035.3286	0	3,705.6044	1,132.9169	150
Slice 8	438	2,035.3108	0	4,499.6219	1,375.6725	150
Slice 9	448	2,035.293	0	5,293.6393	1,618.428	150
Slice 10	454	2,035.2823	0	5,770.0498	1,764.0813	150
Slice 11	462	2,035.268	0	5,790.9196	1,770.4618	150
Slice 12	474.3	2,035.2461	0	6,129.716	1,874.0422	150
Slice 13	484.9	2,035.2272	0	6,924.3727	2,116.9932	150
Slice 14	495.5	2,035.2084	0	7,719.0294	2,359.9441	150
Slice 15	506.1	2,035.1895	0	8,513.6861	2,602.8951	150
	516.7	2,035.1706	0	9,308.3429	2,845.846	150

Slice 16						
Slice 17	528.5	2,035.1495	0	9,767.0912	2,986.0995	150
Slice 18	540.5	2,035.1282	0	10,159.85	3,106.1779	150
Slice 19	551.5	2,035.1086	0	10,822.527	3,308.7787	150
Slice 20	562.63546	2,035.0887	0	11,526.104	3,523.8835	150
Slice 21	573.90638	2,035.0686	0	12,270.578	3,751.4923	150
Slice 22	583.77092	2,041.0984	0	5,736.178	4,813.2248	200
Slice 23	594	2,055.707	0	5,027.2403	4,218.3555	200
Slice 24	604.5	2,070.7025	0	4,282.7215	3,593.63	200
Slice 25	613.5	2,083.5559	0	3,782.304	3,173.7299	200
Slice 26	622.80168	2,096.84	0	3,265.1126	2,739.7548	200
Slice 27	632.40503	2,110.5551	0	2,731.1474	2,291.7048	200
Slice 28	643.93692	2,127.0243	0	2,089.9521	1,753.6781	200
Slice 29	653.33356	2,140.4441	0	1,775.9628	1,153.3238	200
Slice 30	660.87741	2,151.2178	0	1,170.9304	760.41106	200
Slice 31	670.63224	2,165.1492	0	296.82185	192.75836	200

Section 15-15 Static Temporary Final without key SSA for Skyline Ranch.gsz

Section 15-15 Static Temporary Final without key SSA for Skyline Ranch.gsz Run By: Dr. Alexander Bykovtsev, Ph.D., P.E. 3/23/2016 9:56:37 AM

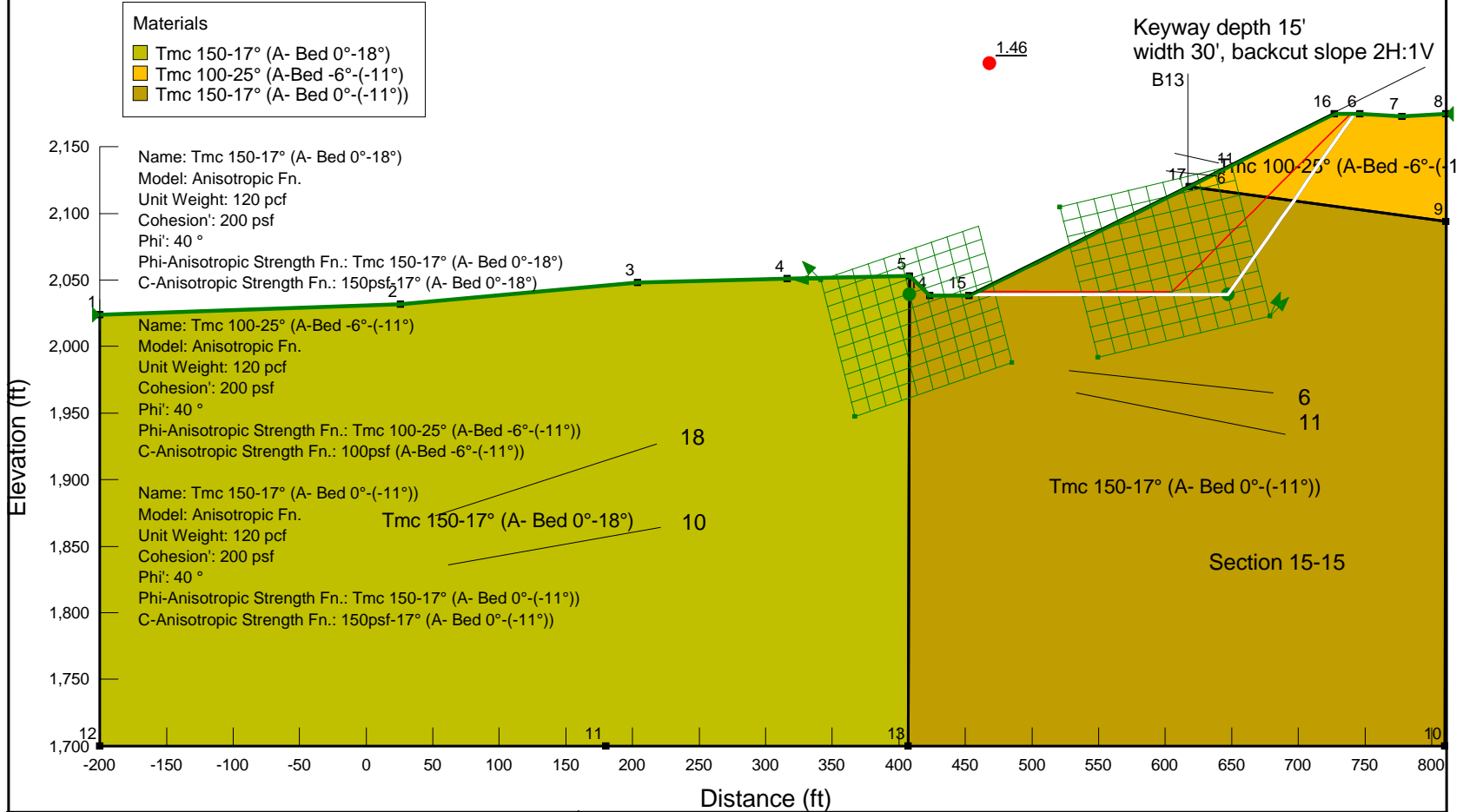

LGC Valley, Inc
 GEOTECHNICAL CONSULTING
 28532 Constellation Road, Valencia, CA 91355
 Phone 661-702-8474, Fax 661-702-8475

Skyline Ranch
 Development project, Tract 60922
 Los Angeles CA

Project No: **153035-01**
 Engineer: **BAS**
 Date: **March 2016**

2 - Translational

Report generated using GeoStudio 2012. Copyright © 1991-2015 GEO-SLOPE International Ltd.

File Information

File Version: 8.15
 Title: Static Slope Stability Analyses for Skyline Ranch Development project, Tract 60922, Los Angeles CA
 Comments: Run By: Dr. Alexander Bykovtsev, Ph.D., P.E.
 Last Edited By: Alexander Bykovtsev
 Revision Number: 125
 Date: 3/23/2016
 Time: 9:56:37 AM
 Tool Version: 8.15.1.11236
 File Name: Section 15-15 Static Temporary Final without key SSA for Skyline Ranch.gsz
 Directory: G:\SLOPE RESULTS\Section 15-15 results\
 Last Solved Date: 3/24/2016
 Last Solved Time: 3:14:46 PM

Project Settings

Length(L) Units: Feet
 Time(t) Units: Seconds
 Force(F) Units: Pounds
 Pressure(p) Units: psf
 Strength Units: psf
 Unit Weight of Water: 62.4 pcf
 View: 2D
 Element Thickness: 1

Analysis Settings

2 - Translational

Kind: SLOPE/W
 Method: Janbu
 Settings
 PWP Conditions Source: (none)
 Slip Surface
 Direction of movement: Right to Left
 Use Passive Mode: No
 Slip Surface Option: Block
 Critical slip surfaces saved: 10
 Resisting Side Maximum Convex Angle: 1 °
 Driving Side Maximum Convex Angle: 5 °
 Restrict Block Crossing: No
 Optimize Critical Slip Surface Location: No
 Tension Crack

file:///G:/SLOPE%20RESULTS/Section%2015-15%20results/section%2015-15%20static... 3/24/2016

Tension Crack Option: (none)
 F of S Distribution
 F of S Calculation Option: Constant
 Advanced
 Number of Slices: 30
 F of S Tolerance: 0.01
 Minimum Slip Surface Depth: 0.1 ft

Materials

Tmc 150-17° (A- Bed 0°-18°)

Model: Anisotropic Fn.
 Unit Weight: 120 pcf
 Cohesion': 200 psf
 Phi': 40 °
 Phi-Anisotropic Strength Fn.: Tmc 150-17° (A- Bed 0°-18°)
 C-Anisotropic Strength Fn.: 150psf-17° (A- Bed 0°-18°)
 Phi-B: 0 °

Tmc 100-25° (A-Bed -6°-(-11°))

Model: Anisotropic Fn.
 Unit Weight: 120 pcf
 Cohesion': 200 psf
 Phi': 40 °
 Phi-Anisotropic Strength Fn.: Tmc 100-25° (A-Bed -6°-(-11°))
 C-Anisotropic Strength Fn.: 100psf (A-Bed -6°-(-11°))
 Phi-B: 0 °

Tmc 150-17° (A- Bed 0°-(-11°))

Model: Anisotropic Fn.
 Unit Weight: 120 pcf
 Cohesion': 200 psf
 Phi': 40 °
 Phi-Anisotropic Strength Fn.: Tmc 150-17° (A- Bed 0°-(-11°))
 C-Anisotropic Strength Fn.: 150psf-17° (A- Bed 0°-(-11°))
 Phi-B: 0 °

Slip Surface Limits

Left Coordinate: (-200, 2,024) ft
 Right Coordinate: (811, 2,175) ft

Slip Surface Block

Left Grid
 Upper Left: (341.5832, 2,050.0454) ft
 Lower Left: (367.0512, 1,947.4848) ft
 Lower Right: (484.9793, 1,987.7541) ft

file:///G:/SLOPE%20RESULTS/Section%2015-15%20results/section%2015-15%20static... 3/24/2016

X Increments: 10
 Y Increments: 10
 Starting Angle: 135 °
 Ending Angle: 180 °
 Angle Increments: 2

Right Grid

Upper Left: (520.6643, 2,104.9641) ft
 Lower Left: (549.385, 1,991.8817) ft
 Lower Right: (678.6285, 2,022.7223) ft
 X Increments: 10
 Y Increments: 10
 Starting Angle: 45 °
 Ending Angle: 65 °
 Angle Increments: 2

Seismic Coefficients

Horz Seismic Coef.: 0
 Vert Seismic Coef.: 0

Anisotropic Strength Functions

Tmc 150-17° (A- Bed 0°-(-11°))

Model: Spline Data Point Function
 Function: Modifier Factor vs. Inclination
 Curve Fit to Data: 100 %
 Segment Curvature: 0 %

Y-Intercept: 0.425

Data Points: Inclination (°), Modifier Factor
 Data Point: (-90, 1)
 Data Point: (-11.1, 1)
 Data Point: (-11, 0.425)
 Data Point: (0, 0.425)
 Data Point: (0.9, 1)

150psf-17° (A- Bed 0°-18°)

Model: Spline Data Point Function
 Function: Modifier Factor vs. Inclination
 Curve Fit to Data: 100 %
 Segment Curvature: 0 %

Y-Intercept: 0.75

Data Points: Inclination (°), Modifier Factor
 Data Point: (-90, 1)
 Data Point: (-0.9, 1)
 Data Point: (0, 0.75)
 Data Point: (18, 0.75)
 Data Point: (18.1, 1)

Tmc 100-25° (A-Bed -6°-(-11°))

Model: Spline Data Point Function
 Function: Modifier Factor vs. Inclination
 Curve Fit to Data: 100 %
 Segment Curvature: 0 %

Y-Intercept: 1

Data Points: Inclination (°), Modifier Factor
 Data Point: (-90, 1)
 Data Point: (-11.1, 1)
 Data Point: (-11, 0.625)
 Data Point: (-6, 0.625)
 Data Point: (-5.9, 1)

100psf (A-Bed -6°-(-11°))

Model: Spline Data Point Function
 Function: Modifier Factor vs. Inclination
 Curve Fit to Data: 100 %
 Segment Curvature: 0 %

Y-Intercept: 1

Data Points: Inclination (°), Modifier Factor
 Data Point: (-90, 1)
 Data Point: (-11.1, 1)
 Data Point: (-11, 0.5)
 Data Point: (-6, 0.5)
 Data Point: (-5.9, 1)

150psf-17° (A- Bed 0°-(-11°))

Model: Spline Data Point Function
 Function: Modifier Factor vs. Inclination
 Curve Fit to Data: 100 %
 Segment Curvature: 0 %

Y-Intercept: 0.75

Data Points: Inclination (°), Modifier Factor
 Data Point: (-90, 1)
 Data Point: (-11.1, 1)
 Data Point: (-11, 0.75)
 Data Point: (0, 0.75)
 Data Point: (0.9, 1)

Tmc 150-17° (A- Bed 0°-18°)

Model: Spline Data Point Function
 Function: Modifier Factor vs. Inclination
 Curve Fit to Data: 100 %
 Segment Curvature: 0 %

Y-Intercept: 0.425

Data Points: Inclination (°), Modifier Factor
 Data Point: (-90, 1)
 Data Point: (-0.9, 1)
 Data Point: (0, 0.425)
 Data Point: (18, 0.425)
 Data Point: (18.1, 1)

Slice 25	691.33002	2,102.4296	0	3,482.4527	2,922.1248	200
Slice 26	701.37635	2,116.7772	0	2,872.0522	2,409.938	200
Slice 27	711.62581	2,131.415	0	2,249.3096	1,887.3948	200
Slice 28	721.87527	2,146.0527	0	1,626.5669	1,364.8517	200
Slice 29	730.7861	2,158.7787	0	959.47662	805.09648	200
Slice 30	738.35829	2,169.5929	0	248.03868	208.12916	200

Section 17-17 Static Final for low key SSA for Skyline Ranch.gsz

Section 17-17 Static Final for low key SSA for Skyline Ranch.gsz Run By: Dr. Alexander Bykovtsev, Ph.D., P.E. 3/25/2016 4:29:32 PM

Name: Fill
 Model: Mohr-Coulomb
 Unit Weight: 120 pcf
 Cohesion: 200 psf
 Phi: 33 °

Name: TQs150-17° (A-Bed 8°-21°)
 Model: Anisotropic Fn.
 Unit Weight: 120 pcf
 Cohesion: 225 psf
 Phi: 40 °
 Phi-Anisotropic Strength Fn.: TQs 150-17° (A-Bed 8°-21°)
 C-Anisotropic Strength Fn.: 150psf-11° (A-Bed 8°-21°)

Materials	
	Fill
	TQs150-17° (A-Bed 8°-21°)
	TQs 150-11° (A-Bed 8°-21°)
	TQs150-17°(A- bed 3-13°)

Low Key parameters	Upper Key parameters
Slope 2H:1V	Slope 2H:1V
Depth- 5'	Depth- 15'
Width-15'	Width-45'

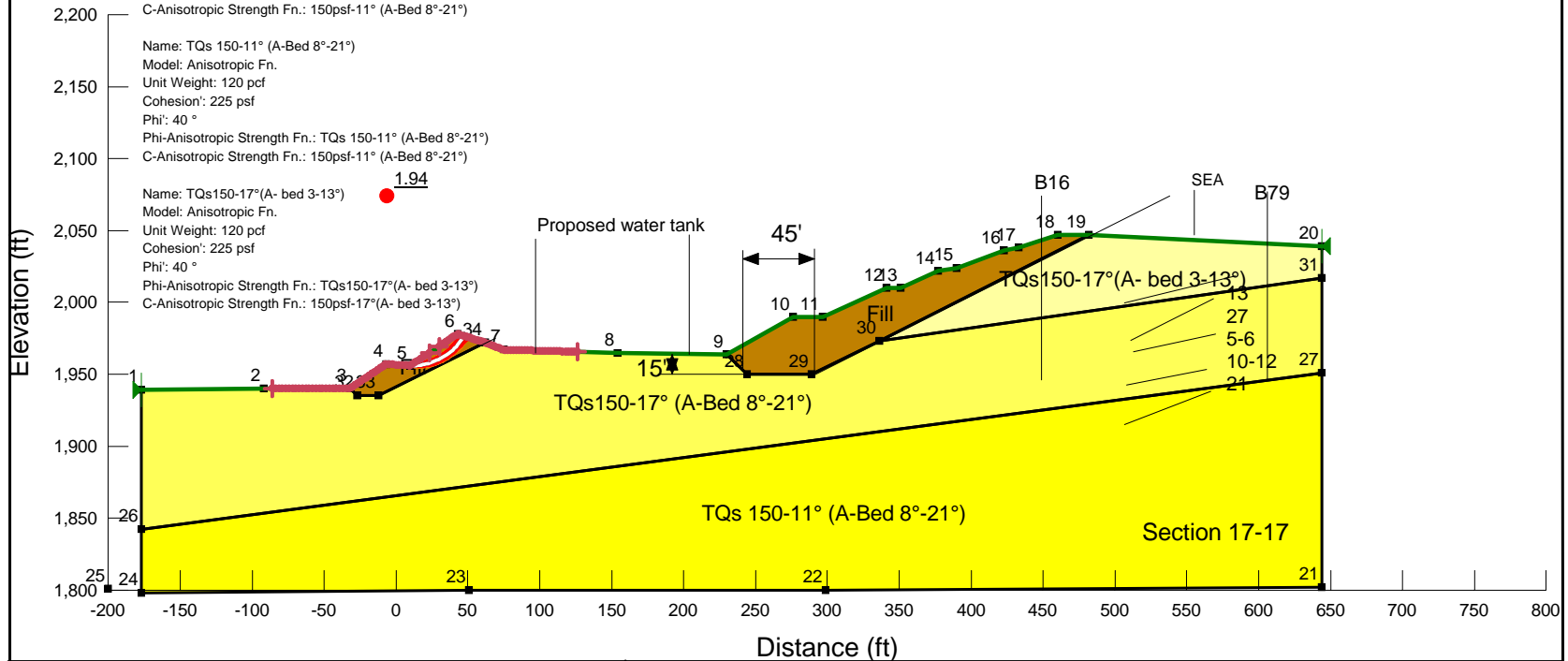

LGC Valley, Inc
 GEOTECHNICAL CONSULTING
 28532 Constellation Road, Valencia, CA 91355
 Phone 661-702-8474, Fax 661-702-8475

Skyline Ranch
 Development project, Tract 60922
 Los Angeles CA

Project No: **153035-01**
 Engineer: **BAS**
 Date: **March 2016**

1 - Circular Mode of Failure

Report generated using GeoStudio 2012. Copyright © 1991-2015 GEO-SLOPE International Ltd.

File Information

File Version: 8.15
 Title: Static Slope Stability Analyses for Skyline Ranch Development project, Tract 60922, Los Angeles CA
 Comments: Run By: Dr. Alexander Bykovtsev, Ph.D., P.E.
 Last Edited By: Alexander Bykovtsev
 Revision Number: 143
 Date: 3/25/2016
 Time: 4:29:32 PM
 Tool Version: 8.15.1.11236
 File Name: Section 17-17 Static Final for low key SSA for Skyline Ranch.gsx
 Directory: G:\SLOPE RESULTS\Section 17-17\Latest Update 3-25-2016\
 Last Solved Date: 3/25/2016
 Last Solved Time: 4:34:30 PM

Project Settings

Length(L) Units: Feet
 Time(t) Units: Seconds
 Force(F) Units: Pounds
 Pressure(p) Units: psf
 Strength Units: psf
 Unit Weight of Water: 62.4 pcf
 View: 2D
 Element Thickness: 1

Analysis Settings

1 - Circular Mode of Failure

Kind: [SLOPE/W](#)
 Method: [Bishop](#)
 Settings
 PWP Conditions Source: [\(none\)](#)
 Slip Surface
 Direction of movement: [Right to Left](#)
 Use Passive Mode: [No](#)
 Slip Surface Option: [Entry and Exit](#)
 Critical slip surfaces saved: [10](#)
 Resisting Side Maximum Convex Angle: [1 °](#)
 Driving Side Maximum Convex Angle: [5 °](#)
 Optimize Critical Slip Surface Location: [No](#)
 Tension Crack
 Tension Crack Option: [\(none\)](#)

F of S Distribution
 F of S Calculation Option: [Constant](#)
 Advanced
 Number of Slices: [30](#)
 F of S Tolerance: [0.01](#)
 Minimum Slip Surface Depth: [0.1 ft](#)

Materials

Fill

Model: [Mohr-Coulomb](#)
 Unit Weight: [120 pcf](#)
 Cohesion': [200 psf](#)
 Phi': [33 °](#)
 Phi-B: [0 °](#)

TQs150-17° (A-Bed 8°-21°)

Model: [Anisotropic Fn.](#)
 Unit Weight: [120 pcf](#)
 Cohesion': [225 psf](#)
 Phi': [40 °](#)
 Phi-Anisotropic Strength Fn.: [TQs 150-17° \(A-Bed 8°-21°\)](#)
 C-Anisotropic Strength Fn.: [150psf-11° \(A-Bed 8°-21°\)](#)
 Phi-B: [0 °](#)

TQs 150-11° (A-Bed 8°-21°)

Model: [Anisotropic Fn.](#)
 Unit Weight: [120 pcf](#)
 Cohesion': [225 psf](#)
 Phi': [40 °](#)
 Phi-Anisotropic Strength Fn.: [TQs 150-11° \(A-Bed 8°-21°\)](#)
 C-Anisotropic Strength Fn.: [150psf-11° \(A-Bed 8°-21°\)](#)
 Phi-B: [0 °](#)

TQs150-17°(A- bed 3-13°)

Model: [Anisotropic Fn.](#)
 Unit Weight: [120 pcf](#)
 Cohesion': [225 psf](#)
 Phi': [40 °](#)
 Phi-Anisotropic Strength Fn.: [TQs150-17°\(A- bed 3-13°\)](#)
 C-Anisotropic Strength Fn.: [150psf-17°\(A- bed 3-13°\)](#)
 Phi-B: [0 °](#)

Slip Surface Entry and Exit

Left Projection: [Range](#)
 Left-Zone Left Coordinate: [\(-86, 1,940\) ft](#)
 Left-Zone Right Coordinate: [\(23, 1,964.6667\) ft](#)
 Left-Zone Increment: [50](#)

Right Projection: Range
 Right-Zone Left Coordinate: (30, 1,969.3333) ft
 Right-Zone Right Coordinate: (126, 1,965.7089) ft
 Right-Zone Increment: 50
 Radius Increments: 50

Slip Surface Limits

Left Coordinate: (-177, 1,939) ft
 Right Coordinate: (644, 2,039) ft

Seismic Coefficients

Horz Seismic Coef.: 0
 Vert Seismic Coef.: 0

Anisotropic Strength Functions

TQs 150-17° (A-Bed 8°-21°)

Model: Spline Data Point Function
 Function: Modifier Factor vs. Inclination
 Curve Fit to Data: 100 %
 Segment Curvature: 0 %
 Y-Intercept: 1
 Data Points: Inclination (°), Modifier Factor
 Data Point: (-90, 1)
 Data Point: (7.9, 1)
 Data Point: (8, 0.425)
 Data Point: (21, 0.425)
 Data Point: (21.1, 1)

150psf-11° (A-Bed 8°-21°)

Model: Spline Data Point Function
 Function: Modifier Factor vs. Inclination
 Curve Fit to Data: 100 %
 Segment Curvature: 0 %
 Y-Intercept: 1
 Data Points: Inclination (°), Modifier Factor
 Data Point: (-90, 1)
 Data Point: (7.9, 1)
 Data Point: (8, 0.667)
 Data Point: (21, 0.667)
 Data Point: (21.1, 1)

TQs 150-11° (A-Bed 8°-21°)

Model: Spline Data Point Function
 Function: Modifier Factor vs. Inclination
 Curve Fit to Data: 100 %

Segment Curvature: 0 %
 Y-Intercept: 1
 Data Points: Inclination (°), Modifier Factor
 Data Point: (-90, 1)
 Data Point: (7.9, 1)
 Data Point: (8, 0.275)
 Data Point: (21, 0.275)
 Data Point: (21.1, 1)

150psf-17°(A- bed 3-13°)

Model: Spline Data Point Function
 Function: Modifier Factor vs. Inclination
 Curve Fit to Data: 100 %
 Segment Curvature: 0 %
 Y-Intercept: 1
 Data Points: Inclination (°), Modifier Factor
 Data Point: (-90, 1)
 Data Point: (2.9, 1)
 Data Point: (3, 0.667)
 Data Point: (13, 0.667)
 Data Point: (13.1, 1)

TQs150-17°(A- bed 3-13°)

Model: Spline Data Point Function
 Function: Modifier Factor vs. Inclination
 Curve Fit to Data: 100 %
 Segment Curvature: 0 %
 Y-Intercept: 1
 Data Points: Inclination (°), Modifier Factor
 Data Point: (-90, 1)
 Data Point: (2.9, 1)
 Data Point: (3, 0.425)
 Data Point: (13, 0.425)
 Data Point: (13.1, 1)

Points

	X (ft)	Y (ft)
Point 1	-177	1,939
Point 2	-92	1,940
Point 3	-32	1,940
Point 4	-7	1,957
Point 5	10	1,956
Point 6	43	1,978
Point 7	75	1,967
Point 8	154	1,965
Point 9	230	1,964
Point 10	276	1,990

Point 11	297	1,990
Point 12	341	2,010
Point 13	351	2,010
Point 14	377	2,022
Point 15	390	2,024
Point 16	423	2,036
Point 17	433	2,038
Point 18	460	2,047
Point 19	482	2,047
Point 20	644	2,039
Point 21	644	1,802
Point 22	299	1,800
Point 23	51	1,800
Point 24	-177	1,798
Point 25	-200	1,801
Point 26	-177	1,842
Point 27	644	1,951
Point 28	244	1,950
Point 29	289	1,950
Point 30	336	1,973
Point 31	644	2,017
Point 32	-27	1,935
Point 33	-12	1,935
Point 34	62	1,972

Regions

	Material	Points	Area (ft ²)
Region 1	TQs 150-11° (A-Bed 8°-21°)	24,23,22,21,27,26	79,110
Region 2	TQs150-17° (A-Bed 8°-21°)	26,27,31,30,29,28,9,8,7,34,33,32,3,2,1	59,521
Region 3	Fill	9,28,29,30,19,18,17,16,15,14,13,12,11,10	6,290
Region 4	Fill	3,32,33,34,6,5,4	1,137.5
Region 5	TQs150-17°(A- bed 3-13°)	30,31,20,19	9,966

Current Slip Surface

Slip Surface: 112,377
 F of S: 1.94
 Volume: 235.2005 ft³
 Weight: 28,224.06 lbs
 Resisting Moment: 1,082,510.1 lbs-ft
 Activating Moment: 559,103.75 lbs-ft
 F of S Rank (Analysis): 1 of 132,651 slip surfaces
 F of S Rank (Query): 1 of 500 slip surfaces
 Exit: (10.027233, 1,956.0182) ft
 Entry: (47.266956, 1,976.6525) ft
 Radius: 42.115532 ft
 Center: (11.034434, 1,998.1216) ft

Slip Slices

	X (ft)	Y (ft)	PWP (psf)	Base Normal Stress (psf)	Frictional Strength (psf)	Cohesive Strength (psf)
Slice 1	10.63784	1,956.0124	0	50.669416	32.905103	200
Slice 2	11.859054	1,956.0186	0	143.53035	93.209698	200
Slice 3	13.080267	1,956.0603	0	230.42213	149.63788	200
Slice 4	14.301481	1,956.1375	0	311.483	202.27943	200
Slice 5	15.522694	1,956.2505	0	386.82845	251.20933	200
Slice 6	16.743908	1,956.3995	0	456.55284	296.48888	200
Slice 7	17.965121	1,956.5849	0	520.73075	338.1665	200
Slice 8	19.186335	1,956.8073	0	579.41791	376.27839	200
Slice 9	20.407549	1,957.0672	0	632.65189	410.84894	200
Slice 10	21.628762	1,957.3653	0	680.45247	441.891	200
	22.849976	1,957.7025	0	722.82179	469.40596	200

Slice 11						
Slice 12	24.071189	1,958.0798	0	759.74417	493.38363	200
Slice 13	25.292403	1,958.4983	0	791.18568	513.80199	200
Slice 14	26.513617	1,958.9594	0	817.09342	530.62667	200
Slice 15	27.73483	1,959.4645	0	837.39437	543.81026	200
Slice 16	28.956044	1,960.0155	0	851.99401	553.29138	200
Slice 17	30.177257	1,960.6143	0	860.77431	558.99337	200
Slice 18	31.398471	1,961.2633	0	863.59129	560.82274	200
Slice 19	32.619685	1,961.9652	0	860.27189	558.6671	200
Slice 20	33.840898	1,962.7231	0	850.60992	552.39254	200
Slice 21	35.062112	1,963.5408	0	834.36104	541.8404	200
Slice 22	36.283325	1,964.4225	0	811.23627	526.823	200
Slice 23	37.504539	1,965.3736	0	780.8937	507.1183	200
Slice 24	38.725752	1,966.4002	0	742.92769	482.46288	200
Slice 25	39.946966	1,967.5099	0	696.85475	452.54277	200
Slice 26	41.16818	1,968.7123	0	642.09467	416.98115	200
Slice 27	42.389393	1,970.0192	0	577.94494	375.32183	200
Slice 28	43.711159	1,971.5759	0	436.96587	283.76896	200
Slice 29	45.133478	1,973.4335	0	222.05395	144.20352	200
Slice 30	46.555797	1,975.5342	0	-0.64302	-0.41758207	200

Section 17-17 Seismic Final for low key SSA for Skyline Ranch.gsz

Section 17-17 Seismic Final for low key SSA for Skyline Ranch.gsz Run By: Dr. Alexander Bykovtsev, Ph.D., P.E. 3/25/2016 4:18:37 PM

Name: Fill
 Model: Mohr-Coulomb
 Unit Weight: 120 pcf
 Cohesion: 200 psf
 Phi: 33°

Materials

- Fill
- TQs150-17° (A-Bed 8°-21°)
- TQs 150-11° (A-Bed 8°-21°)
- TQs150-17°(A- bed 3-13°)

Low Key parameters
 Slope 2H:1V
 Depth- 5'
 Width-15'

Upper Key parameters
 Slope 2H:1V
 Depth- 15'
 Width-45'

Seismic load
 Horizontal: 0.15
 Vertical: 0.0

Name: TQs150-17° (A-Bed 8°-21°)
 Model: Anisotropic Fn.
 Unit Weight: 120 pcf
 Cohesion: 225 psf
 Phi: 40°
 Phi-Anisotropic Strength Fn.: TQs 150-17° (A-Bed 8°-21°)
 C-Anisotropic Strength Fn.: 150psf-11° (A-Bed 8°-21°)

Name: TQs 150-11° (A-Bed 8°-21°)
 Model: Anisotropic Fn.
 Unit Weight: 120 pcf
 Cohesion: 225 psf
 Phi: 40°
 Phi-Anisotropic Strength Fn.: TQs 150-11° (A-Bed 8°-21°)
 C-Anisotropic Strength Fn.: 150psf-11° (A-Bed 8°-21°)

Name: TQs150-17°(A- bed 3-13°)
 Model: Anisotropic Fn.
 Unit Weight: 120 pcf
 Cohesion: 225 psf
 Phi: 40°
 Phi-Anisotropic Strength Fn.: TQs150-17°(A- bed 3-13°)
 C-Anisotropic Strength Fn.: 150psf-17°(A- bed 3-13°)

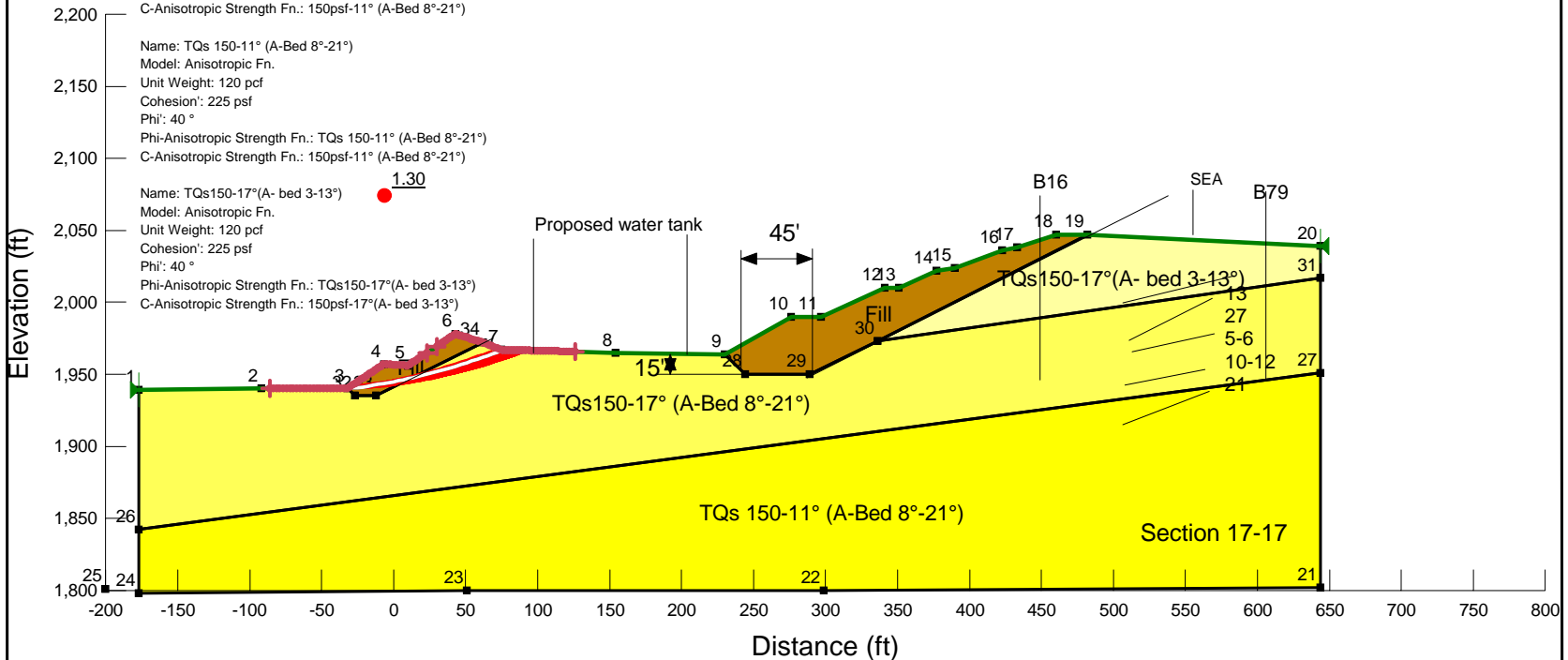

	<p>LGC Valley, Inc GEOTECHNICAL CONSULTING 28532 Constellation Road, Valencia, CA 91355 Phone 661-702-8474, Fax 661-702-8475</p>	<p>Skyline Ranch Development project, Tract 60922 Los Angeles CA</p>	<p>Project No: 153035-01 Engineer: BAS Date: March 2016</p>
--	--	---	--

1 - Circular Mode of Failure

Report generated using GeoStudio 2012. Copyright © 1991-2015 GEO-SLOPE International Ltd.

File Information

File Version: 8.15
 Title: Static Slope Stability Analyses for Skyline Ranch Development project, Tract 60922, Los Angeles CA
 Comments: Run By: Dr. Alexander Bykovtsev, Ph.D., P.E.
 Last Edited By: Alexander Bykovtsev
 Revision Number: 141
 Date: 3/25/2016
 Time: 4:18:37 PM
 Tool Version: 8.15.1.11236
 File Name: Section 17-17 Seismic Final for low key SSA for Skyline Ranch.gsz
 Directory: G:\SLOPE RESULTS\Section 17-17\Latest Update 3-25-2016\
 Last Solved Date: 3/25/2016
 Last Solved Time: 4:18:53 PM

Project Settings

Length(L) Units: Feet
 Time(t) Units: Seconds
 Force(F) Units: Pounds
 Pressure(p) Units: psf
 Strength Units: psf
 Unit Weight of Water: 62.4 pcf
 View: 2D
 Element Thickness: 1

Analysis Settings

1 - Circular Mode of Failure

Kind: [SLOPE/W](#)
 Method: [Bishop](#)
 Settings
 PWP Conditions Source: [\(none\)](#)
 Slip Surface
 Direction of movement: [Right to Left](#)
 Use Passive Mode: [No](#)
 Slip Surface Option: [Entry and Exit](#)
 Critical slip surfaces saved: [10](#)
 Resisting Side Maximum Convex Angle: [1 °](#)
 Driving Side Maximum Convex Angle: [5 °](#)
 Optimize Critical Slip Surface Location: [No](#)
 Tension Crack
 Tension Crack Option: [\(none\)](#)

file:///G:/SLOPE%20RESULTS/Section%2017-17/Latest%20Update%203-25-2016/sectio... 3/25/2016

F of S Distribution
 F of S Calculation Option: [Constant](#)
 Advanced
 Number of Slices: [30](#)
 F of S Tolerance: [0.01](#)
 Minimum Slip Surface Depth: [0.1 ft](#)

Materials

Fill

Model: [Mohr-Coulomb](#)
 Unit Weight: [120 pcf](#)
 Cohesion': [200 psf](#)
 Phi': [33 °](#)
 Phi-B: [0 °](#)

TQs150-17° (A-Bed 8°-21°)

Model: [Anisotropic Fn.](#)
 Unit Weight: [120 pcf](#)
 Cohesion': [225 psf](#)
 Phi': [40 °](#)
 Phi-Anisotropic Strength Fn.: [TQs 150-17° \(A-Bed 8°-21°\)](#)
 C-Anisotropic Strength Fn.: [150psf-11° \(A-Bed 8°-21°\)](#)
 Phi-B: [0 °](#)

TQs 150-11° (A-Bed 8°-21°)

Model: [Anisotropic Fn.](#)
 Unit Weight: [120 pcf](#)
 Cohesion': [225 psf](#)
 Phi': [40 °](#)
 Phi-Anisotropic Strength Fn.: [TQs 150-11° \(A-Bed 8°-21°\)](#)
 C-Anisotropic Strength Fn.: [150psf-11° \(A-Bed 8°-21°\)](#)
 Phi-B: [0 °](#)

TQs150-17°(A- bed 3-13°)

Model: [Anisotropic Fn.](#)
 Unit Weight: [120 pcf](#)
 Cohesion': [225 psf](#)
 Phi': [40 °](#)
 Phi-Anisotropic Strength Fn.: [TQs150-17°\(A- bed 3-13°\)](#)
 C-Anisotropic Strength Fn.: [150psf-17°\(A- bed 3-13°\)](#)
 Phi-B: [0 °](#)

Slip Surface Entry and Exit

Left Projection: [Range](#)
 Left-Zone Left Coordinate: [\(-86, 1,940\) ft](#)
 Left-Zone Right Coordinate: [\(23, 1,964.6667\) ft](#)
 Left-Zone Increment: [50](#)

file:///G:/SLOPE%20RESULTS/Section%2017-17/Latest%20Update%203-25-2016/sectio... 3/25/2016

Right Projection: Range
 Right-Zone Left Coordinate: (30, 1,969.3333) ft
 Right-Zone Right Coordinate: (126, 1,965.7089) ft
 Right-Zone Increment: 50
 Radius Increments: 50

Slip Surface Limits

Left Coordinate: (-177, 1,939) ft
 Right Coordinate: (644, 2,039) ft

Seismic Coefficients

Horz Seismic Coef.: 0.15
 Vert Seismic Coef.: 0

Anisotropic Strength Functions

TQs 150-17° (A-Bed 8°-21°)

Model: Spline Data Point Function
 Function: Modifier Factor vs. Inclination
 Curve Fit to Data: 100 %
 Segment Curvature: 0 %
 Y-Intercept: 1
 Data Points: Inclination (°), Modifier Factor
 Data Point: (-90, 1)
 Data Point: (7.9, 1)
 Data Point: (8, 0.425)
 Data Point: (21, 0.425)
 Data Point: (21.1, 1)

150psf-11° (A-Bed 8°-21°)

Model: Spline Data Point Function
 Function: Modifier Factor vs. Inclination
 Curve Fit to Data: 100 %
 Segment Curvature: 0 %
 Y-Intercept: 1
 Data Points: Inclination (°), Modifier Factor
 Data Point: (-90, 1)
 Data Point: (7.9, 1)
 Data Point: (8, 0.667)
 Data Point: (21, 0.667)
 Data Point: (21.1, 1)

TQs 150-11° (A-Bed 8°-21°)

Model: Spline Data Point Function
 Function: Modifier Factor vs. Inclination
 Curve Fit to Data: 100 %

Segment Curvature: 0 %
 Y-Intercept: 1
 Data Points: Inclination (°), Modifier Factor
 Data Point: (-90, 1)
 Data Point: (7.9, 1)
 Data Point: (8, 0.275)
 Data Point: (21, 0.275)
 Data Point: (21.1, 1)

150psf-17°(A- bed 3-13°)

Model: Spline Data Point Function
 Function: Modifier Factor vs. Inclination
 Curve Fit to Data: 100 %
 Segment Curvature: 0 %
 Y-Intercept: 1
 Data Points: Inclination (°), Modifier Factor
 Data Point: (-90, 1)
 Data Point: (2.9, 1)
 Data Point: (3, 0.667)
 Data Point: (13, 0.667)
 Data Point: (13.1, 1)

TQs150-17°(A- bed 3-13°)

Model: Spline Data Point Function
 Function: Modifier Factor vs. Inclination
 Curve Fit to Data: 100 %
 Segment Curvature: 0 %
 Y-Intercept: 1
 Data Points: Inclination (°), Modifier Factor
 Data Point: (-90, 1)
 Data Point: (2.9, 1)
 Data Point: (3, 0.425)
 Data Point: (13, 0.425)
 Data Point: (13.1, 1)

Points

	X (ft)	Y (ft)
Point 1	-177	1,939
Point 2	-92	1,940
Point 3	-32	1,940
Point 4	-7	1,957
Point 5	10	1,956
Point 6	43	1,978
Point 7	75	1,967
Point 8	154	1,965
Point 9	230	1,964
Point 10	276	1,990

Point 11	297	1,990
Point 12	341	2,010
Point 13	351	2,010
Point 14	377	2,022
Point 15	390	2,024
Point 16	423	2,036
Point 17	433	2,038
Point 18	460	2,047
Point 19	482	2,047
Point 20	644	2,039
Point 21	644	1,802
Point 22	299	1,800
Point 23	51	1,800
Point 24	-177	1,798
Point 25	-200	1,801
Point 26	-177	1,842
Point 27	644	1,951
Point 28	244	1,950
Point 29	289	1,950
Point 30	336	1,973
Point 31	644	2,017
Point 32	-27	1,935
Point 33	-12	1,935
Point 34	62	1,972

Regions

	Material	Points	Area (ft ²)
Region 1	TQs 150-11° (A-Bed 8°-21°)	24,23,22,21,27,26	79,110
Region 2	TQs150-17° (A-Bed 8°-21°)	26,27,31,30,29,28,9,8,7,34,33,32,3,2,1	59,521
Region 3	Fill	9,28,29,30,19,18,17,16,15,14,13,12,11,10	6,290
Region 4	Fill	3,32,33,34,6,5,4	1,137.5
Region 5	TQs150-17°(A- bed 3-13°)	30,31,20,19	9,966

Current Slip Surface

Slip Surface: 61,101
 F of S: 1.30
 Volume: 1,273.6586 ft³
 Weight: 152,839.03 lbs
 Resisting Moment: 32,573,573 lbs-ft
 Activating Moment: 25,018,478 lbs-ft
 F of S Rank (Analysis): 1 of 132,651 slip surfaces
 F of S Rank (Query): 1 of 500 slip surfaces
 Exit: (-31.95441, 1,940.031) ft
 Entry: (75.769263, 1,966.9805) ft
 Radius: 416.2632 ft
 Center: (-78.214197, 2,353.7158) ft

Slip Slices

	X (ft)	Y (ft)	PWP (psf)	Base Normal Stress (psf)	Frictional Strength (psf)	Cohesive Strength (psf)
Slice 1	-30.171952	1,940.2381	0	97.13462	63.07996	200
Slice 2	-26.607036	1,940.6679	0	320.76091	208.30457	200
Slice 3	-23.042121	1,941.129	0	539.03122	350.05097	200
Slice 4	-19.477205	1,941.6214	0	751.98975	488.34785	200
Slice 5	-15.912289	1,942.1453	0	959.67871	623.22264	200
Slice 6	-12.347374	1,942.7007	0	1,162.1384	754.70149	200
Slice 7	-8.7824579	1,943.2879	0	1,359.4071	882.80931	200
Slice 8	-5.3	1,943.8919	0	1,408.7329	914.84183	200
Slice 9	-1.9	1,944.5114	0	1,312.0412	852.04951	200
Slice 10	1.5	1,945.1601	0	1,212.8783	787.65237	200
	4.9	1,945.8382	0	1,111.2619	721.66192	200

Slice 11						
Slice 12	8.3	1,946.5459	0	1,007.2094	654.0894	200
Slice 13	11.6258	1,947.2664	0	1,030.6152	669.28934	200
Slice 14	15.110875	1,948.0535	0	1,267.52	387.51977	150.075
Slice 15	18.829425	1,948.927	0	1,446.1427	442.13019	150.075
Slice 16	22.547975	1,949.8366	0	1,619.8731	495.24491	150.075
Slice 17	26.266525	1,950.7826	0	1,788.7063	546.86239	150.075
Slice 18	29.985075	1,951.7652	0	1,952.6357	596.98063	150.075
Slice 19	33.703625	1,952.7847	0	2,111.6534	645.59722	150.075
Slice 20	37.422175	1,953.8414	0	2,265.75	692.70929	150.075
Slice 21	41.140725	1,954.9355	0	2,414.9147	738.31353	150.075
Slice 22	44.9	1,956.0803	0	2,351.8357	719.02832	150.075
Slice 23	48.7	1,957.2768	0	2,077.8196	635.25321	150.075
Slice 24	52.5	1,958.5135	0	1,800.5383	550.4798	150.075
Slice 25	56.3	1,959.7907	0	1,519.9878	464.7069	150.075
Slice 26	60.1	1,961.1089	0	1,236.1639	377.93323	150.075
Slice 27	63.625	1,962.3672	0	957.73545	292.80911	150.075
Slice 28	66.875	1,963.5604	0	685.12496	209.46372	150.075
Slice 29	70.125	1,964.7845	0	410.21128	125.41417	150.075
Slice 30	73.375	1,966.0397	0	98.022886	82.250967	225
Slice 31	75.384631	1,966.8278	0	-39.07695	-32.789455	225

Section 17-17 Static Final for low key SSA for Skyline Ranch.gsz

Section 17-17 Static Final for low key SSA for Skyline Ranch.gsz Run By: Dr. Alexander Bykovtsev, Ph.D., P.E. 3/25/2016 4:29:32 PM

Name: Fill
 Model: Mohr-Coulomb
 Unit Weight: 120 pcf
 Cohesion: 200 psf
 Phi: 33°

Materials

- Fill
- TQs150-17° (A-Bed 8°-21°)
- TQs 150-11° (A-Bed 8°-21°)
- TQs150-17°(A- bed 3-13°)

Low Key parameters
 Slope 2H:1V
 Depth- 5'
 Width-15'

Upper Key parameters
 Slope 2H:1V
 Depth- 15'
 Width-45'

Name: TQs150-17° (A-Bed 8°-21°)
 Model: Anisotropic Fn.
 Unit Weight: 120 pcf
 Cohesion: 225 psf
 Phi: 40°
 Phi-Anisotropic Strength Fn.: TQs 150-17° (A-Bed 8°-21°)
 C-Anisotropic Strength Fn.: 150psf-11° (A-Bed 8°-21°)

Name: TQs 150-11° (A-Bed 8°-21°)
 Model: Anisotropic Fn.
 Unit Weight: 120 pcf
 Cohesion: 225 psf
 Phi: 40°
 Phi-Anisotropic Strength Fn.: TQs 150-11° (A-Bed 8°-21°)
 C-Anisotropic Strength Fn.: 150psf-11° (A-Bed 8°-21°)

Name: TQs150-17°(A- bed 3-13°)
 Model: Anisotropic Fn.
 Unit Weight: 120 pcf
 Cohesion: 225 psf
 Phi: 40°
 Phi-Anisotropic Strength Fn.: TQs150-17°(A- bed 3-13°)
 C-Anisotropic Strength Fn.: 150psf-17°(A- bed 3-13°)

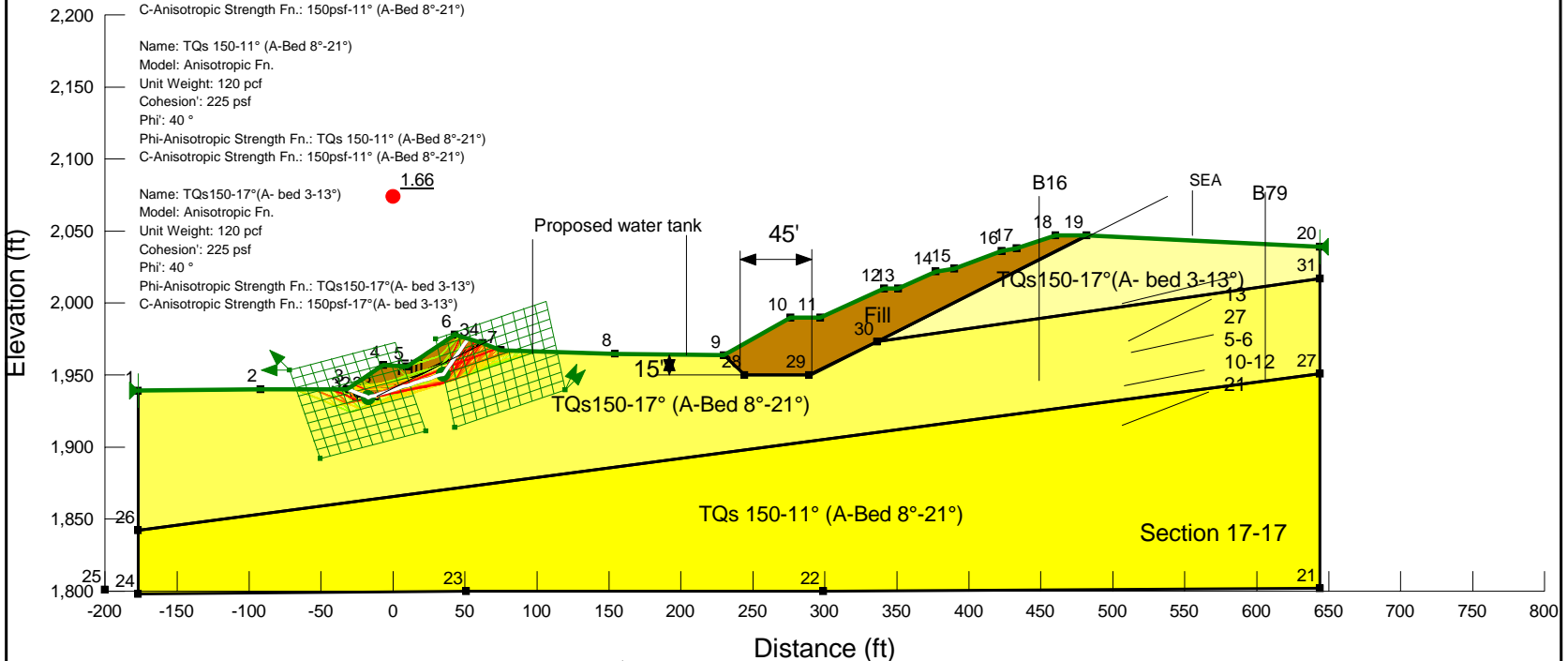

LGC Valley, Inc
 GEOTECHNICAL CONSULTING
 28532 Constellation Road, Valencia, CA 91355
 Phone 661-702-8474, Fax 661-702-8475

Skyline Ranch
 Development project, Tract 60922
 Los Angeles CA

Project No: **153035-01**
 Engineer: **BAS**
 Date: **March 2016**

2 - Translational

Report generated using GeoStudio 2012. Copyright © 1991-2015 GEO-SLOPE International Ltd.

File Information

File Version: 8.15

Title: Static Slope Stability Analyses for Skyline Ranch Development project, Tract 60922, Los Angeles CA

Comments: Run By: Dr. Alexander Bykovtsev, Ph.D., P.E.

Last Edited By: Alexander Bykovtsev

Revision Number: 143

Date: 3/25/2016

Time: 4:29:32 PM

Tool Version: 8.15.1.11236

File Name: Section 17-17 Static Final for low key SSA for Skyline Ranch.gsz

Directory: G:\SLOPE RESULTS\Section 17-17\Latest Update 3-25-2016\

Last Solved Date: 3/25/2016

Last Solved Time: 4:29:54 PM

Project Settings

Length(L) Units: Feet

Time(t) Units: Seconds

Force(F) Units: Pounds

Pressure(p) Units: psf

Strength Units: psf

Unit Weight of Water: 62.4 pcf

View: 2D

Element Thickness: 1

Analysis Settings

2 - Translational

Kind: SLOPE/W

Method: [Janbu](#)

Settings

PWP Conditions Source: [\(none\)](#)

Slip Surface

Direction of movement: [Right to Left](#)

Use Passive Mode: [No](#)

Slip Surface Option: [Block](#)

Critical slip surfaces saved: [10](#)

Resisting Side Maximum Convex Angle: [1 °](#)

Driving Side Maximum Convex Angle: [5 °](#)

Restrict Block Crossing: [No](#)

Optimize Critical Slip Surface Location: [No](#)

Tension Crack

Tension Crack Option: [\(none\)](#)

F of S Distribution

F of S Calculation Option: [Constant](#)

Advanced

Number of Slices: [30](#)

F of S Tolerance: [0.01](#)

Minimum Slip Surface Depth: [0.1 ft](#)

Materials

Fill

Model: [Mohr-Coulomb](#)

Unit Weight: [120 pcf](#)

Cohesion': [200 psf](#)

Phi': [33 °](#)

Phi-B: [0 °](#)

TQs150-17° (A-Bed 8°-21°)

Model: [Anisotropic Fn.](#)

Unit Weight: [120 pcf](#)

Cohesion': [225 psf](#)

Phi': [40 °](#)

Phi-Anisotropic Strength Fn.: [TQs 150-17° \(A-Bed 8°-21°\)](#)

C-Anisotropic Strength Fn.: 150psf-11° (A-Bed 8°-21°)
Phi-B: 0°

TQs 150-11° (A-Bed 8°-21°)

Model: Anisotropic Fn.
Unit Weight: 120 pcf
Cohesion': 225 psf
Phi': 40°
Phi-Anisotropic Strength Fn.: TQs 150-11° (A-Bed 8°-21°)
C-Anisotropic Strength Fn.: 150psf-11° (A-Bed 8°-21°)
Phi-B: 0°

TQs150-17°(A- bed 3-13°)

Model: Anisotropic Fn.
Unit Weight: 120 pcf
Cohesion': 225 psf
Phi': 40°
Phi-Anisotropic Strength Fn.: TQs150-17°(A- bed 3-13°)
C-Anisotropic Strength Fn.: 150psf-17°(A- bed 3-13°)
Phi-B: 0°

Slip Surface Limits

Left Coordinate: (-177, 1,939) ft
Right Coordinate: (644, 2,039) ft

Slip Surface Block

Left Grid
Upper Left: (-71.5929, 1,953.474) ft
Lower Left: (-50.5113, 1,892.0009) ft
Lower Right: (22.7194, 1,911.321) ft
X Increments: 10
Y Increments: 10
Starting Angle: 135°
Ending Angle: 180°

Angle Increments: 2

Right Grid

Upper Left: (29.5713, 1,975.3338) ft

Lower Left: (42.8782, 1,913.6751) ft

Lower Right: (119.5885, 1,939.6366) ft

X Increments: 10

Y Increments: 10

Starting Angle: 45 °

Ending Angle: 65 °

Angle Increments: 2

Seismic Coefficients

Horz Seismic Coef.: 0

Vert Seismic Coef.: 0

Anisotropic Strength Functions

TQs 150-17° (A-Bed 8°-21°)

Model: [Spline Data Point Function](#)

Function: [Modifier Factor vs. Inclination](#)

Curve Fit to Data: 100 %

Segment Curvature: 0 %

Y-Intercept: 1

Data Points: [Inclination \(°\), Modifier Factor](#)

Data Point: (-90, 1)

Data Point: (7.9, 1)

Data Point: (8, 0.425)

Data Point: (21, 0.425)

Data Point: (21.1, 1)

150psf-11° (A-Bed 8°-21°)

Model: [Spline Data Point Function](#)

Function: [Modifier Factor vs. Inclination](#)

Curve Fit to Data: 100 %

Segment Curvature: 0 %

Y-Intercept: 1

Data Points: Inclination (°), Modifier Factor

Data Point: (-90, 1)

Data Point: (7.9, 1)

Data Point: (8, 0.667)

Data Point: (21, 0.667)

Data Point: (21.1, 1)

TQs 150-11° (A-Bed 8°-21°)

Model: Spline Data Point Function

Function: Modifier Factor vs. Inclination

Curve Fit to Data: 100 %

Segment Curvature: 0 %

Y-Intercept: 1

Data Points: Inclination (°), Modifier Factor

Data Point: (-90, 1)

Data Point: (7.9, 1)

Data Point: (8, 0.275)

Data Point: (21, 0.275)

Data Point: (21.1, 1)

150psf-17°(A- bed 3-13°)

Model: Spline Data Point Function

Function: Modifier Factor vs. Inclination

Curve Fit to Data: 100 %

Segment Curvature: 0 %

Y-Intercept: 1

Data Points: Inclination (°), Modifier Factor

Data Point: (-90, 1)

Data Point: (2.9, 1)

Data Point: (3, 0.667)

Data Point: (13, 0.667)

Data Point: (13.1, 1)

TQs150-17°(A- bed 3-13°)

Model: Spline Data Point Function

Function: **Modifier Factor vs. Inclination**

Curve Fit to Data: 100 %

Segment Curvature: 0 %

Y-Intercept: 1

Data Points: **Inclination (°), Modifier Factor**

Data Point: (-90, 1)

Data Point: (2.9, 1)

Data Point: (3, 0.425)

Data Point: (13, 0.425)

Data Point: (13.1, 1)

Points

	X (ft)	Y (ft)
Point 1	-177	1,939
Point 2	-92	1,940
Point 3	-32	1,940
Point 4	-7	1,957
Point 5	10	1,956
Point 6	43	1,978
Point 7	75	1,967
Point 8	154	1,965
Point 9	230	1,964
Point 10	276	1,990
Point 11	297	1,990
Point 12	341	2,010
Point 13	351	2,010
Point 14	377	2,022
Point 15	390	2,024
Point 16	423	2,036
Point 17	433	2,038
Point 18	460	2,047
Point 19	482	2,047

Point 20	644	2,039
Point 21	644	1,802
Point 22	299	1,800
Point 23	51	1,800
Point 24	-177	1,798
Point 25	-200	1,801
Point 26	-177	1,842
Point 27	644	1,951
Point 28	244	1,950
Point 29	289	1,950
Point 30	336	1,973
Point 31	644	2,017
Point 32	-27	1,935
Point 33	-12	1,935
Point 34	62	1,972

Regions

	Material	Points	Area (ft ²)
Region 1	TQs 150-11° (A-Bed 8°-21°)	24,23,22,21,27,26	79,110

A-1127

Region 2	TQs150-17° (A-Bed 8° -21°)	26,27,31,30,29,28,9,8,7,34,33,32,3,2,1	59,521
Region 3	Fill	9,28,29,30,19,18,17,16,15,14,13,12,11,10	6,290
Region 4	Fill	3,32,33,34,6,5,4	1,137.5
Region 5	TQs150-17°(A- bed 3-13°)	30,31,20,19	9,966

Current Slip Surface

Slip Surface: 66,992

F of S: 1.66

Volume: 1,230.3528 ft³

Weight: 147,642.34 lbs

Resisting Force: 73,302.436 lbs

Activating Force: 44,088.634 lbs

F of S Rank (Analysis): 1 of 131,769 slip surfaces

F of S Rank (Query): 1 of 500 slip surfaces

Exit: (-31.547049, 1,940.308) ft

Entry: (52.033121, 1,975.1474) ft

Radius: 49.716909 ft

Center: (-0.648774, 1,983.8573) ft

Slip Slices

	X (ft)	Y (ft)	PWP (psf)	Base Normal Stress (psf)	Frictional Strength (psf)	Cohesive Strength (psf)
Slice 1	-30.265582	1,939.7772	0	260.43337	169.12741	200
Slice 2	-27.70265	1,938.7156	0	662.09149	429.96724	200
Slice 3	-25.139717	1,937.654	0	1,063.7496	690.80708	200
Slice 4	-22.576785	1,936.5924	0	1,465.4077	951.64691	200
Slice 5	-20.013852	1,935.5308	0	1,867.0659	1,212.4867	200
Slice 6	-17.923033	1,934.6648	0	2,334.1401	1,958.5761	225
Slice 7	-16.046699	1,934.6648	0	1,808.8485	553.02049	150.075
Slice 8	-13.649765	1,935.4179	0	1,789.2707	1,161.966	200
Slice 9	-10.989859	1,936.2536	0	1,893.2415	1,229.4854	200

Slice 10	-8.329953	1,937.0894	0	1,997.2123	1,297.0048	200
Slice 11	-5.5671332	1,937.9574	0	2,123.5976	649.24894	150.075
Slice 12	-2.7208397	1,938.8517	0	2,003.1636	612.42857	150.075
Slice 13	0.10601357	1,939.7399	0	1,883.5521	575.85968	150.075
Slice 14	2.9328668	1,940.6281	0	1,763.9407	539.29079	150.075
Slice 15	5.7597201	1,941.5163	0	1,644.3293	502.72191	150.075
Slice 16	8.5865734	1,942.4045	0	1,524.7178	466.15302	150.075
Slice 17	11.383003	1,943.2832	0	1,520.2058	464.77355	150.075
Slice 18	14.14901	1,944.1522	0	1,630.7931	498.5835	150.075
Slice 19	16.915017	1,945.0213	0	1,741.3805	532.39345	150.075
Slice 20	19.681023	1,945.8904	0	1,851.9679	566.2034	150.075
Slice 21	22.44703	1,946.7595	0	1,962.5552	600.01335	150.075
Slice 22	25.213037	1,947.6285	0	2,073.1426	633.8233	150.075
Slice 23	27.979043	1,948.4976	0	2,183.73	667.63325	150.075
Slice 24	30.74505	1,949.3667	0	2,294.3173	701.4432	150.075
Slice 25	33.511057	1,950.2358	0	2,404.9047	735.25315	150.075
Slice 26	36.24505	1,952.5997	0	1,343.4384	1,127.2787	225
	38.94703	1,956.4586	0	1,200.0909	1,006.9958	225

Slice 27						
Slice 28	41.64901	1,960.3174	0	1,056.7434	886.71296	225
Slice 29	43.1364	1,962.4416	0	968.49692	812.66541	225
Slice 30	44.732853	1,964.7216	0	869.46013	564.63401	200
Slice 31	47.65296	1,968.8919	0	477.50066	310.09255	200
Slice 32	50.573067	1,973.0623	0	85.541187	55.551096	200

Section 17-17 Seismic Final for low key SSA for Skyline Ranch.gsz

Section 17-17 Seismic Final for low key SSA for Skyline Ranch.gsz Run By: Dr. Alexander Bykovtsev, Ph.D., P.E. 3/25/2016 4:07:47 PM

Name: Fill
 Model: Mohr-Coulomb
 Unit Weight: 120 pcf
 Cohesion: 200 psf
 Phi: 33 °

Name: TQs150-17° (A-Bed 8°-21°)
 Model: Anisotropic Fn.
 Unit Weight: 120 pcf
 Cohesion: 225 psf
 Phi: 40 °
 Phi-Anisotropic Strength Fn.: TQs 150-17° (A-Bed 8°-21°)
 C-Anisotropic Strength Fn.: 150psf-11° (A-Bed 8°-21°)

Name: TQs 150-11° (A-Bed 8°-21°)
 Model: Anisotropic Fn.
 Unit Weight: 120 pcf
 Cohesion: 225 psf
 Phi: 40 °
 Phi-Anisotropic Strength Fn.: TQs 150-11° (A-Bed 8°-21°)
 C-Anisotropic Strength Fn.: 150psf-11° (A-Bed 8°-21°)

Name: TQs150-17°(A- bed 3-13°)
 Model: Anisotropic Fn.
 Unit Weight: 120 pcf
 Cohesion: 225 psf
 Phi: 40 °
 Phi-Anisotropic Strength Fn.: TQs150-17°(A- bed 3-13°)
 C-Anisotropic Strength Fn.: 150psf-17°(A- bed 3-13°)

Materials

- Fill
- TQs150-17° (A-Bed 8°-21°)
- TQs 150-11° (A-Bed 8°-21°)
- TQs150-17°(A- bed 3-13°)

Low Key parameters
 Slope 2H:1V
 Depth- 5'
 Width-15'

Upper Key parameters
 Slope 2H:1V
 Depth- 15'
 Width-45'

Seismic load
 Horizontal: 0.15
 Vertical: 0.0

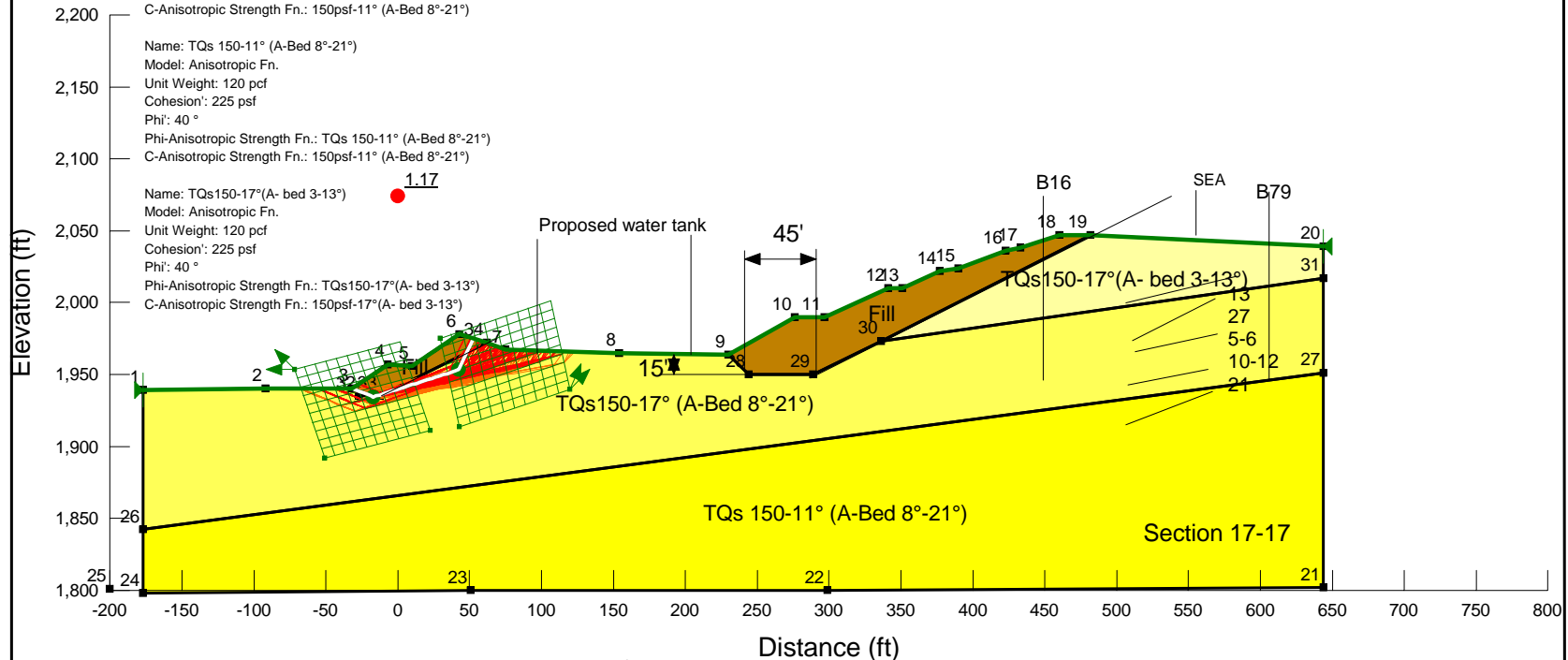

LGC **LGC Valley, Inc**
 GEOTECHNICAL CONSULTING
 28532 Constellation Road, Valencia, CA 91355
 Phone 661-702-8474, Fax 661-702-8475

Skyline Ranch
 Development project, Tract 60922
 Los Angeles CA

Project No: **153035-01**
 Engineer: **BAS**
 Date: **March 2016**

2 - Translational

Report generated using GeoStudio 2012. Copyright © 1991-2015 GEO-SLOPE International Ltd.

File Information

File Version: 8.15
 Title: Static Slope Stability Analyses for Skyline Ranch Development project, Tract 60922, Los Angeles CA
 Comments: Run By: Dr. Alexander Bykovtsev, Ph.D., P.E.
 Last Edited By: Alexander Bykovtsev
 Revision Number: 139
 Date: 3/25/2016
 Time: 4:07:47 PM
 Tool Version: 8.15.1.11236
 File Name: Section 17-17 Seismic Final for low key SSA for Skyline Ranch.gsz
 Directory: G:\SLOPE RESULTS\Section 17-17\Latest Update 3-25-2016\
 Last Solved Date: 3/25/2016
 Last Solved Time: 4:08:38 PM

Project Settings

Length(L) Units: Feet
 Time(t) Units: Seconds
 Force(F) Units: Pounds
 Pressure(p) Units: psf
 Strength Units: psf
 Unit Weight of Water: 62.4 pcf
 View: 2D
 Element Thickness: 1

Analysis Settings

2 - Translational

Kind: SLOPE/W
 Method: Janbu
 Settings
 PWP Conditions Source: (none)
 Slip Surface
 Direction of movement: Right to Left
 Use Passive Mode: No
 Slip Surface Option: Block
 Critical slip surfaces saved: 10
 Resisting Side Maximum Convex Angle: 1 °
 Driving Side Maximum Convex Angle: 5 °
 Restrict Block Crossing: No
 Optimize Critical Slip Surface Location: No
 Tension Crack

file:///G:/SLOPE%20RESULTS/Section%2017-17/Latest%20Update%203-25-2016/sectio... 3/25/2016

Tension Crack Option: (none)
 F of S Distribution
 F of S Calculation Option: Constant
 Advanced
 Number of Slices: 30
 F of S Tolerance: 0.01
 Minimum Slip Surface Depth: 0.1 ft

Materials

Fill

Model: Mohr-Coulomb
 Unit Weight: 120 pcf
 Cohesion': 200 psf
 Phi': 33 °
 Phi-B: 0 °

TQs150-17° (A-Bed 8°-21°)

Model: Anisotropic Fn.
 Unit Weight: 120 pcf
 Cohesion': 225 psf
 Phi': 40 °
 Phi-Anisotropic Strength Fn.: TQs 150-17° (A-Bed 8°-21°)
 C-Anisotropic Strength Fn.: 150psf-11° (A-Bed 8°-21°)
 Phi-B: 0 °

TQs 150-11° (A-Bed 8°-21°)

Model: Anisotropic Fn.
 Unit Weight: 120 pcf
 Cohesion': 225 psf
 Phi': 40 °
 Phi-Anisotropic Strength Fn.: TQs 150-11° (A-Bed 8°-21°)
 C-Anisotropic Strength Fn.: 150psf-11° (A-Bed 8°-21°)
 Phi-B: 0 °

TQs150-17°(A- bed 3-13°)

Model: Anisotropic Fn.
 Unit Weight: 120 pcf
 Cohesion': 225 psf
 Phi': 40 °
 Phi-Anisotropic Strength Fn.: TQs150-17°(A- bed 3-13°)
 C-Anisotropic Strength Fn.: 150psf-17°(A- bed 3-13°)
 Phi-B: 0 °

Slip Surface Limits

Left Coordinate: (-177, 1,939) ft
 Right Coordinate: (644, 2,039) ft

file:///G:/SLOPE%20RESULTS/Section%2017-17/Latest%20Update%203-25-2016/sectio... 3/25/2016

Slip Surface Block

Left Grid

Upper Left: (-71.5929, 1,953.474) ft
 Lower Left: (-50.5113, 1,892.0009) ft
 Lower Right: (22.7194, 1,911.321) ft
 X Increments: 10
 Y Increments: 10
 Starting Angle: 135 °
 Ending Angle: 180 °
 Angle Increments: 2

Right Grid

Upper Left: (29.5713, 1,975.3338) ft
 Lower Left: (42.8782, 1,913.6751) ft
 Lower Right: (119.5885, 1,939.6366) ft
 X Increments: 10
 Y Increments: 10
 Starting Angle: 45 °
 Ending Angle: 65 °
 Angle Increments: 2

Seismic Coefficients

Horz Seismic Coef.: 0.15
 Vert Seismic Coef.: 0

Anisotropic Strength Functions

TQs 150-17° (A-Bed 8°-21°)

Model: Spline Data Point Function
 Function: Modifier Factor vs. Inclination
 Curve Fit to Data: 100 %
 Segment Curvature: 0 %

Y-Intercept: 1

Data Points: Inclination (°), Modifier Factor
 Data Point: (-90, 1)
 Data Point: (7.9, 1)
 Data Point: (8, 0.425)
 Data Point: (21, 0.425)
 Data Point: (21.1, 1)

150psf-11° (A-Bed 8°-21°)

Model: Spline Data Point Function
 Function: Modifier Factor vs. Inclination
 Curve Fit to Data: 100 %
 Segment Curvature: 0 %

Y-Intercept: 1

Data Points: Inclination (°), Modifier Factor
 Data Point: (-90, 1)

Data Point: (7.9, 1)
 Data Point: (8, 0.667)
 Data Point: (21, 0.667)
 Data Point: (21.1, 1)

TQs 150-11° (A-Bed 8°-21°)

Model: Spline Data Point Function
 Function: Modifier Factor vs. Inclination
 Curve Fit to Data: 100 %
 Segment Curvature: 0 %

Y-Intercept: 1

Data Points: Inclination (°), Modifier Factor
 Data Point: (-90, 1)
 Data Point: (7.9, 1)
 Data Point: (8, 0.275)
 Data Point: (21, 0.275)
 Data Point: (21.1, 1)

150psf-17°(A- bed 3-13°)

Model: Spline Data Point Function
 Function: Modifier Factor vs. Inclination
 Curve Fit to Data: 100 %
 Segment Curvature: 0 %

Y-Intercept: 1

Data Points: Inclination (°), Modifier Factor
 Data Point: (-90, 1)
 Data Point: (2.9, 1)
 Data Point: (3, 0.667)
 Data Point: (13, 0.667)
 Data Point: (13.1, 1)

TQs150-17°(A- bed 3-13°)

Model: Spline Data Point Function
 Function: Modifier Factor vs. Inclination
 Curve Fit to Data: 100 %
 Segment Curvature: 0 %

Y-Intercept: 1

Data Points: Inclination (°), Modifier Factor
 Data Point: (-90, 1)
 Data Point: (2.9, 1)
 Data Point: (3, 0.425)
 Data Point: (13, 0.425)
 Data Point: (13.1, 1)

Points

	X (ft)	Y (ft)
Point 1	-177	1,939
Point 2	-92	1,940

Point 3	-32	1,940
Point 4	-7	1,957
Point 5	10	1,956
Point 6	43	1,978
Point 7	75	1,967
Point 8	154	1,965
Point 9	230	1,964
Point 10	276	1,990
Point 11	297	1,990
Point 12	341	2,010
Point 13	351	2,010
Point 14	377	2,022
Point 15	390	2,024
Point 16	423	2,036
Point 17	433	2,038
Point 18	460	2,047
Point 19	482	2,047
Point 20	644	2,039
Point 21	644	1,802
Point 22	299	1,800
Point 23	51	1,800
Point 24	-177	1,798
Point 25	-200	1,801
Point 26	-177	1,842

Point 27	644	1,951
Point 28	244	1,950
Point 29	289	1,950
Point 30	336	1,973
Point 31	644	2,017
Point 32	-27	1,935
Point 33	-12	1,935
Point 34	62	1,972

Regions

	Material	Points	Area (ft ²)
Region 1	TQs 150-11° (A-Bed 8°-21°)	24,23,22,21,27,26	79,110
Region 2	TQs150-17° (A-Bed 8°-21°)	26,27,31,30,29,28,9,8,7,34,33,32,3,2,1	59,521
Region 3	Fill	9,28,29,30,19,18,17,16,15,14,13,12,11,10	6,290
Region 4	Fill	3,32,33,34,6,5,4	1,137.5
Region 5	TQs150-17°(A- bed 3-13°)	30,31,20,19	9,966

Current Slip Surface

Slip Surface: 66,996
 F of S: 1.17
 Volume: 1,305.1222 ft³
 Weight: 156,614.67 lbs
 Resisting Force: 71,619.411 lbs
 Activating Force: 61,416.48 lbs
 F of S Rank (Analysis): 1 of 131,769 slip surfaces
 F of S Rank (Query): 1 of 500 slip surfaces
 Exit: (-31.547049, 1,940.308) ft
 Entry: (52.673982, 1,974.9451) ft
 Radius: 49.625828 ft
 Center: (-0.12025445, 1,983.6043) ft

Slip Slices

	X (ft)	Y (ft)	PWP (psf)	Base Normal Stress (psf)	Frictional Strength (psf)	Cohesive Strength (psf)
Slice 1	-30.265582	1,939.7772	0	309.49193	200.98641	200
	-27.70265	1,938.7156	0	745.81675	484.33906	200

Slice 2						
Slice 3	-25.139717	1,937.654	0	1,182.1416	767.69171	200
Slice 4	-22.576785	1,936.5924	0	1,618.4664	1,051.0444	200
Slice 5	-20.013852	1,935.5308	0	2,054.7912	1,334.397	200
Slice 6	-17.923033	1,934.6648	0	2,651.8689	2,225.1822	225
Slice 7	-16.057174	1,934.6648	0	1,755.8349	536.81261	150.075
Slice 8	-13.667224	1,935.4231	0	1,694.3413	1,100.3181	200
Slice 9	-11.000334	1,936.2694	0	1,793.1051	1,164.4561	200
Slice 10	-8.3334447	1,937.1156	0	1,891.869	1,228.5941	200
Slice 11	-6.8939956	1,937.5724	0	1,937.1796	1,258.0192	200
Slice 12	-5.3889919	1,938.0499	0	2,052.8105	627.60716	150.075
Slice 13	-2.5909934	1,938.9378	0	1,936.1422	591.93809	150.075
Slice 14	0.20700514	1,939.8256	0	1,819.474	556.26901	150.075
Slice 15	3.0050037	1,940.7135	0	1,702.8057	520.59994	150.075
Slice 16	5.8030022	1,941.6013	0	1,586.1374	484.93086	150.075
Slice 17	8.6010007	1,942.4892	0	1,469.4691	449.26179	150.075
Slice 18	11.356879	1,943.3636	0	1,463.6836	447.49299	150.075
Slice 19	14.070636	1,944.2248	0	1,568.781	479.62447	150.075
Slice 20	16.784394	1,945.0859	0	1,673.8783	511.75595	150.075
Slice 21	19.498151	1,945.947	0	1,778.9756	543.88744	150.075
Slice 22	22.211909	1,946.8081	0	1,884.073	576.01892	150.075
Slice 23	24.925666	1,947.6692	0	1,989.1703	608.1504	150.075
Slice 24	27.639424	1,948.5303	0	2,094.2677	640.28188	150.075
Slice 25	30.353181	1,949.3915	0	2,199.365	672.41336	150.075

Slice 26	33.066939	1,950.2526	0	2,304.4624	704.54485	150.075
Slice 27	35.780696	1,951.1137	0	2,409.5597	736.67633	150.075
Slice 28	38.494454	1,951.9748	0	2,514.657	768.80781	150.075
Slice 29	41.208211	1,952.8359	0	2,619.7544	800.93929	150.075
Slice 30	42.782545	1,953.7328	0	981.94904	823.95308	225
Slice 31	44.261908	1,956.9053	0	819.45343	687.60307	225
Slice 32	46.785723	1,962.3176	0	524.94659	440.48249	225
Slice 33	49.204218	1,967.5041	0	302.04072	196.14754	200
Slice 34	51.517394	1,972.4647	0	-10.633346	-6.9053757	200

Section 17-17 Static Final for upper key SSA for Skyline Ranch.gsz

Section 17-17 Static Final for upper key SSA for Skyline Ranch.gsz Run By: Dr. Alexander Bykovtsev, Ph.D., P.E. 3/25/2016 3:53:58 PM

Name: Fill
 Model: Mohr-Coulomb
 Unit Weight: 120 pcf
 Cohesion: 200 psf
 Phi: 33 °

Name: TQs150-17° (A-Bed 8°-21°)
 Model: Anisotropic Fn.
 Unit Weight: 120 pcf
 Cohesion: 225 psf
 Phi: 40 °
 Phi-Anisotropic Strength Fn.: TQs 150-17° (A-Bed 8°-21°)
 C-Anisotropic Strength Fn.: 150psf-11° (A-Bed 8°-21°)

Name: TQs 150-11° (A-Bed 8°-21°)
 Model: Anisotropic Fn.
 Unit Weight: 120 pcf
 Cohesion: 225 psf
 Phi: 40 °
 Phi-Anisotropic Strength Fn.: TQs 150-11° (A-Bed 8°-21°)
 C-Anisotropic Strength Fn.: 150psf-11° (A-Bed 8°-21°)

Name: TQs150-17°(A- bed 3-13°)
 Model: Anisotropic Fn.
 Unit Weight: 120 pcf
 Cohesion: 225 psf
 Phi: 40 °
 Phi-Anisotropic Strength Fn.: TQs150-17°(A- bed 3-13°)
 C-Anisotropic Strength Fn.: 150psf-17°(A- bed 3-13°)

Materials

- Fill
- TQs150-17° (A-Bed 8°-21°)
- TQs 150-11° (A-Bed 8°-21°)
- TQs150-17°(A- bed 3-13°)

Low Key parameters
 Slope 2H:1V
 Depth- 5'
 Width-15'

Upper Key parameters
 Slope 2H:1V
 Depth- 15'
 Width-45'

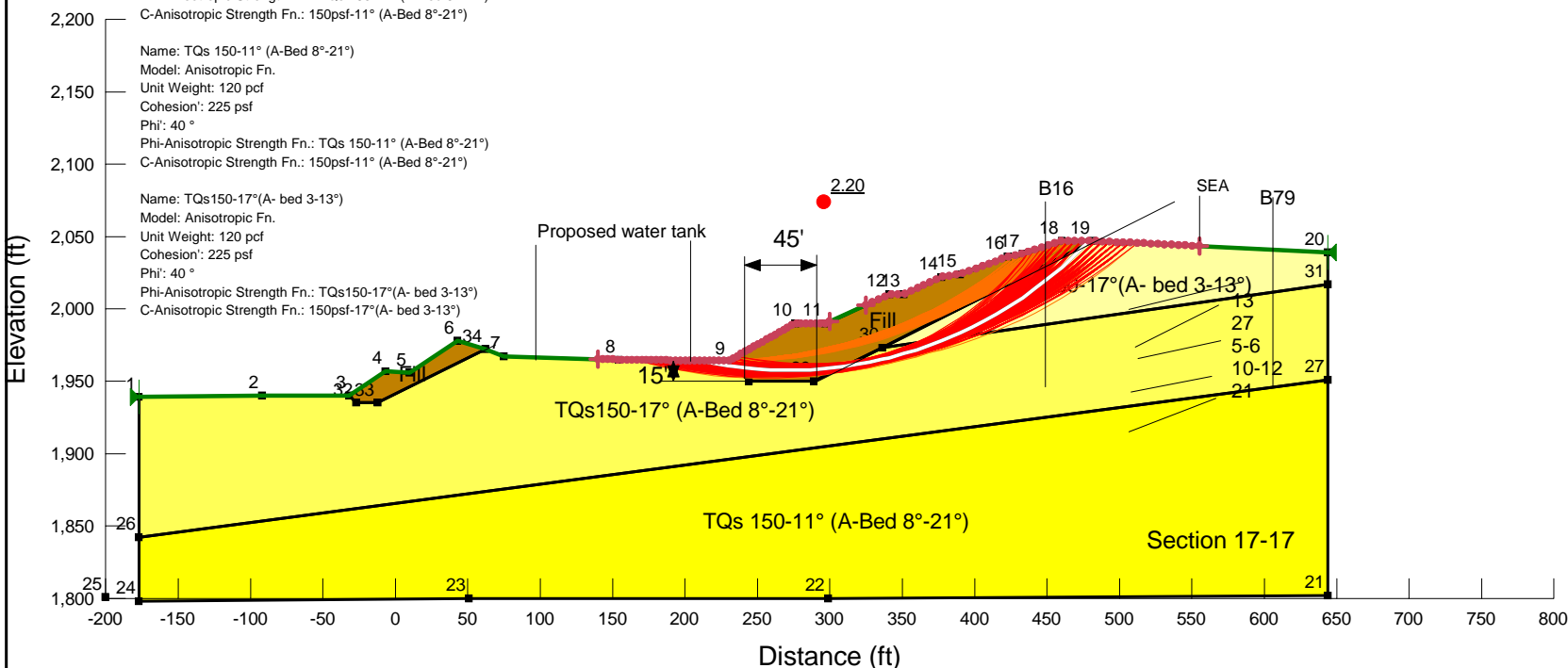

LGC **LGC Valley, Inc**
 GEOTECHNICAL CONSULTING
 28532 Constellation Road, Valencia, CA 91355
 Phone 661-702-8474, Fax 661-702-8475

Skyline Ranch
 Development project, Tract 60922
 Los Angeles CA

Project No: **153035-01**
 Engineer: **BAS**
 Date: **March 2016**

1 - Circular Mode of Failure

Report generated using GeoStudio 2012. Copyright © 1991-2015 GEO-SLOPE International Ltd.

File Information

File Version: 8.15
 Title: Static Slope Stability Analyses for Skyline Ranch Development project, Tract 60922, Los Angeles CA
 Comments: Run By: Dr. Alexander Bykovtsev, Ph.D., P.E.
 Last Edited By: Alexander Bykovtsev
 Revision Number: 136
 Date: 3/25/2016
 Time: 3:53:58 PM
 Tool Version: 8.15.1.11236
 File Name: Section 17-17 Static Final for upper key SSA for Skyline Ranch.gsz
 Directory: G:\SLOPE RESULTS\Section 17-17\Latest Update 3-25-2016\
 Last Solved Date: 3/25/2016
 Last Solved Time: 3:57:45 PM

Project Settings

Length(L) Units: Feet
 Time(t) Units: Seconds
 Force(F) Units: Pounds
 Pressure(p) Units: psf
 Strength Units: psf
 Unit Weight of Water: 62.4 pcf
 View: 2D
 Element Thickness: 1

Analysis Settings

1 - Circular Mode of Failure

Kind: [SLOPE/W](#)
 Method: [Bishop](#)
 Settings
 PWP Conditions Source: [\(none\)](#)
 Slip Surface
 Direction of movement: [Right to Left](#)
 Use Passive Mode: [No](#)
 Slip Surface Option: [Entry and Exit](#)
 Critical slip surfaces saved: [10](#)
 Resisting Side Maximum Convex Angle: [1 °](#)
 Driving Side Maximum Convex Angle: [5 °](#)
 Optimize Critical Slip Surface Location: [No](#)
 Tension Crack
 Tension Crack Option: [\(none\)](#)

F of S Distribution
 F of S Calculation Option: [Constant](#)
 Advanced
 Number of Slices: [30](#)
 F of S Tolerance: [0.01](#)
 Minimum Slip Surface Depth: [0.1 ft](#)

Materials

Fill

Model: [Mohr-Coulomb](#)
 Unit Weight: [120 pcf](#)
 Cohesion': [200 psf](#)
 Phi': [33 °](#)
 Phi-B: [0 °](#)

TQs150-17° (A-Bed 8°-21°)

Model: [Anisotropic Fn.](#)
 Unit Weight: [120 pcf](#)
 Cohesion': [225 psf](#)
 Phi': [40 °](#)
 Phi-Anisotropic Strength Fn.: [TQs 150-17° \(A-Bed 8°-21°\)](#)
 C-Anisotropic Strength Fn.: [150psf-11° \(A-Bed 8°-21°\)](#)
 Phi-B: [0 °](#)

TQs 150-11° (A-Bed 8°-21°)

Model: [Anisotropic Fn.](#)
 Unit Weight: [120 pcf](#)
 Cohesion': [225 psf](#)
 Phi': [40 °](#)
 Phi-Anisotropic Strength Fn.: [TQs 150-11° \(A-Bed 8°-21°\)](#)
 C-Anisotropic Strength Fn.: [150psf-11° \(A-Bed 8°-21°\)](#)
 Phi-B: [0 °](#)

TQs150-17°(A- bed 3-13°)

Model: [Anisotropic Fn.](#)
 Unit Weight: [120 pcf](#)
 Cohesion': [225 psf](#)
 Phi': [40 °](#)
 Phi-Anisotropic Strength Fn.: [TQs150-17°\(A- bed 3-13°\)](#)
 C-Anisotropic Strength Fn.: [150psf-17°\(A- bed 3-13°\)](#)
 Phi-B: [0 °](#)

Slip Surface Entry and Exit

Left Projection: [Range](#)
 Left-Zone Left Coordinate: [\(140.0889, 1,965.3522\) ft](#)
 Left-Zone Right Coordinate: [\(300, 1,991.3636\) ft](#)
 Left-Zone Increment: [50](#)

Right Projection: Range
 Right-Zone Left Coordinate: (325, 2,002.7273) ft
 Right-Zone Right Coordinate: (554.9691, 2,043.3966) ft
 Right-Zone Increment: 50
 Radius Increments: 50

Slip Surface Limits

Left Coordinate: (-177, 1,939) ft
 Right Coordinate: (644, 2,039) ft

Seismic Coefficients

Horz Seismic Coef.: 0
 Vert Seismic Coef.: 0

Anisotropic Strength Functions

TQs 150-17° (A-Bed 8°-21°)

Model: Spline Data Point Function
 Function: Modifier Factor vs. Inclination
 Curve Fit to Data: 100 %
 Segment Curvature: 0 %
 Y-Intercept: 1
 Data Points: Inclination (°), Modifier Factor
 Data Point: (-90, 1)
 Data Point: (7.9, 1)
 Data Point: (8, 0.425)
 Data Point: (21, 0.425)
 Data Point: (21.1, 1)

150psf-11° (A-Bed 8°-21°)

Model: Spline Data Point Function
 Function: Modifier Factor vs. Inclination
 Curve Fit to Data: 100 %
 Segment Curvature: 0 %
 Y-Intercept: 1
 Data Points: Inclination (°), Modifier Factor
 Data Point: (-90, 1)
 Data Point: (7.9, 1)
 Data Point: (8, 0.667)
 Data Point: (21, 0.667)
 Data Point: (21.1, 1)

TQs 150-11° (A-Bed 8°-21°)

Model: Spline Data Point Function
 Function: Modifier Factor vs. Inclination
 Curve Fit to Data: 100 %

Segment Curvature: 0 %
 Y-Intercept: 1
 Data Points: Inclination (°), Modifier Factor
 Data Point: (-90, 1)
 Data Point: (7.9, 1)
 Data Point: (8, 0.275)
 Data Point: (21, 0.275)
 Data Point: (21.1, 1)

150psf-17°(A- bed 3-13°)

Model: Spline Data Point Function
 Function: Modifier Factor vs. Inclination
 Curve Fit to Data: 100 %
 Segment Curvature: 0 %
 Y-Intercept: 1
 Data Points: Inclination (°), Modifier Factor
 Data Point: (-90, 1)
 Data Point: (2.9, 1)
 Data Point: (3, 0.667)
 Data Point: (13, 0.667)
 Data Point: (13.1, 1)

TQs150-17°(A- bed 3-13°)

Model: Spline Data Point Function
 Function: Modifier Factor vs. Inclination
 Curve Fit to Data: 100 %
 Segment Curvature: 0 %
 Y-Intercept: 1
 Data Points: Inclination (°), Modifier Factor
 Data Point: (-90, 1)
 Data Point: (2.9, 1)
 Data Point: (3, 0.425)
 Data Point: (13, 0.425)
 Data Point: (13.1, 1)

Points

	X (ft)	Y (ft)
Point 1	-177	1,939
Point 2	-92	1,940
Point 3	-32	1,940
Point 4	-7	1,957
Point 5	10	1,956
Point 6	43	1,978
Point 7	75	1,967
Point 8	154	1,965
Point 9	230	1,964
Point 10	276	1,990

Point 11	297	1,990
Point 12	341	2,010
Point 13	351	2,010
Point 14	377	2,022
Point 15	390	2,024
Point 16	423	2,036
Point 17	433	2,038
Point 18	460	2,047
Point 19	482	2,047
Point 20	644	2,039
Point 21	644	1,802
Point 22	299	1,800
Point 23	51	1,800
Point 24	-177	1,798
Point 25	-200	1,801
Point 26	-177	1,842
Point 27	644	1,951
Point 28	244	1,950
Point 29	289	1,950
Point 30	336	1,973
Point 31	644	2,017
Point 32	-27	1,935
Point 33	-12	1,935
Point 34	62	1,972

Regions

	Material	Points	Area (ft ²)
Region 1	TQs 150-11° (A-Bed 8°-21°)	24,23,22,21,27,26	79,110
Region 2	TQs150-17° (A-Bed 8°-21°)	26,27,31,30,29,28,9,8,7,34,33,32,3,2,1	59,521
Region 3	Fill	9,28,29,30,19,18,17,16,15,14,13,12,11,10	6,290
Region 4	Fill	3,32,33,34,6,5,4	1,137.5
Region 5	TQs150-17°(A- bed 3-13°)	30,31,20,19	9,966

Current Slip Surface

Slip Surface: 56,373
 F of S: 2.20
 Volume: 7,725.7384 ft³
 Weight: 927,088.61 lbs
 Resisting Moment: 1.7022767e+008 lbs-ft
 Activating Moment: 77,536,641 lbs-ft
 F of S Rank (Analysis): 1 of 132,651 slip surfaces
 F of S Rank (Query): 1 of 500 slip surfaces
 Exit: (210.24346, 1,964.26) ft
 Entry: (478.83576, 2,047) ft
 Radius: 285.78335 ft
 Center: (271.27916, 2,243.4494) ft

Slip Slices

	X (ft)	Y (ft)	PWP (psf)	Base Normal Stress (psf)	Frictional Strength (psf)	Cohesive Strength (psf)
Slice 1	215.1826	1,963.2711	0	142.24681	119.35925	225
Slice 2	225.06087	1,961.4726	0	349.76389	293.48675	225
Slice 3	231.93782	1,960.3937	0	610.84461	512.55949	225
Slice 4	238.08808	1,959.6317	0	1,122.2048	728.76831	200
Slice 5	246.51295	1,958.7726	0	1,801.5307	1,169.9277	200
Slice 6	254.93782	1,958.1649	0	2,438.1386	1,583.3457	200
Slice 7	263.36269	1,957.8068	0	3,033.4091	1,969.9189	200
Slice 8	271.78756	1,957.6976	0	3,588.5277	2,330.4171	200
Slice 9	281.25	1,957.8884	0	3,810.8886	2,474.82	200
Slice 10	291.75	1,958.4488	0	3,701.0402	2,403.4836	200
	303.53516	1,959.5685	0	3,868.0147	2,511.9181	200

Slice 11						
Slice 12	314.39194	1,960.9706	0	4,329.8108	1,323.756	150.075
Slice 13	323.03516	1,962.4261	0	4,598.5548	1,405.9193	150.075
Slice 14	331.67839	1,964.1566	0	4,832.5803	1,477.4681	150.075
Slice 15	338.5	1,965.6962	0	4,995.3531	1,527.2327	150.075
Slice 16	346	1,967.6559	0	4,878.8734	1,491.6213	150.075
Slice 17	355.33333	1,970.3442	0	4,773.2702	1,459.3352	150.075
Slice 18	364	1,973.1644	0	4,883.7333	1,493.1071	150.075
Slice 19	372.66667	1,976.2955	0	4,956.8749	1,515.4687	150.075
Slice 20	378.74367	1,978.6477	0	4,496.1241	3,772.6961	225
Slice 21	385.24367	1,981.424	0	4,267.9123	3,581.2036	225
Slice 22	394.125	1,985.4569	0	4,024.6106	3,377.0493	225
Slice 23	402.375	1,989.5509	0	3,859.943	3,238.8767	225
Slice 24	410.625	1,993.9849	0	3,663.2232	3,073.8092	225
Slice 25	418.875	1,998.7774	0	3,433.9022	2,881.3861	225
Slice 26	428	2,004.5458	0	3,060.6204	2,568.1655	225
Slice 27	437.5	2,011.0443	0	2,624.608	2,202.3076	225
Slice 28	446.5	2,017.7565	0	2,228.9149	1,870.2817	225
Slice 29	455.5	2,025.0458	0	1,791.1848	1,502.9825	225
Slice 30	463.95776	2,032.4557	0	1,224.7179	1,027.6603	225
Slice 31	471.87329	2,039.9716	0	539.40003	452.61036	225
Slice 32	477.3334	2,045.4366	0	71.039899	46.13385	200

Section 17-17 Seismic Final for upper key SSA for Skyline Ranch.gsz

Section 17-17 Seismic Final for upper key SSA for Skyline Ranch.gsz Run By: Dr. Alexander Bykovtsev, Ph.D., P.E. 3/25/2016 2:09:52 PM

Name: Fill
 Model: Mohr-Coulomb
 Unit Weight: 120 pcf
 Cohesion: 200 psf
 Phi: 33 °

Name: TQs150-17° (A-Bed 8°-21°)
 Model: Anisotropic Fn.
 Unit Weight: 120 pcf
 Cohesion: 225 psf
 Phi: 40 °
 Phi-Anisotropic Strength Fn.: TQs 150-17° (A-Bed 8°-21°)
 C-Anisotropic Strength Fn.: 150psf-11° (A-Bed 8°-21°)

Name: TQs 150-11° (A-Bed 8°-21°)
 Model: Anisotropic Fn.
 Unit Weight: 120 pcf
 Cohesion: 225 psf
 Phi: 40 °
 Phi-Anisotropic Strength Fn.: TQs 150-11° (A-Bed 8°-21°)
 C-Anisotropic Strength Fn.: 150psf-11° (A-Bed 8°-21°)

Name: TQs150-17°(A- bed 3-13°)
 Model: Anisotropic Fn.
 Unit Weight: 120 pcf
 Cohesion: 225 psf
 Phi: 40 °
 Phi-Anisotropic Strength Fn.: TQs150-17°(A- bed 3-13°)
 C-Anisotropic Strength Fn.: 150psf-17°(A- bed 3-13°)

Materials

- Fill
- TQs150-17° (A-Bed 8°-21°)
- TQs 150-11° (A-Bed 8°-21°)
- TQs150-17°(A- bed 3-13°)

Low Key parameters
 Slope 2H:1V
 Depth- 5'
 Width-15'

Upper Key parameters
 Slope 2H:1V
 Depth- 15'
 Width-45'

Seimic load
 Horizontal: 0.15
 Vertical: 0.0

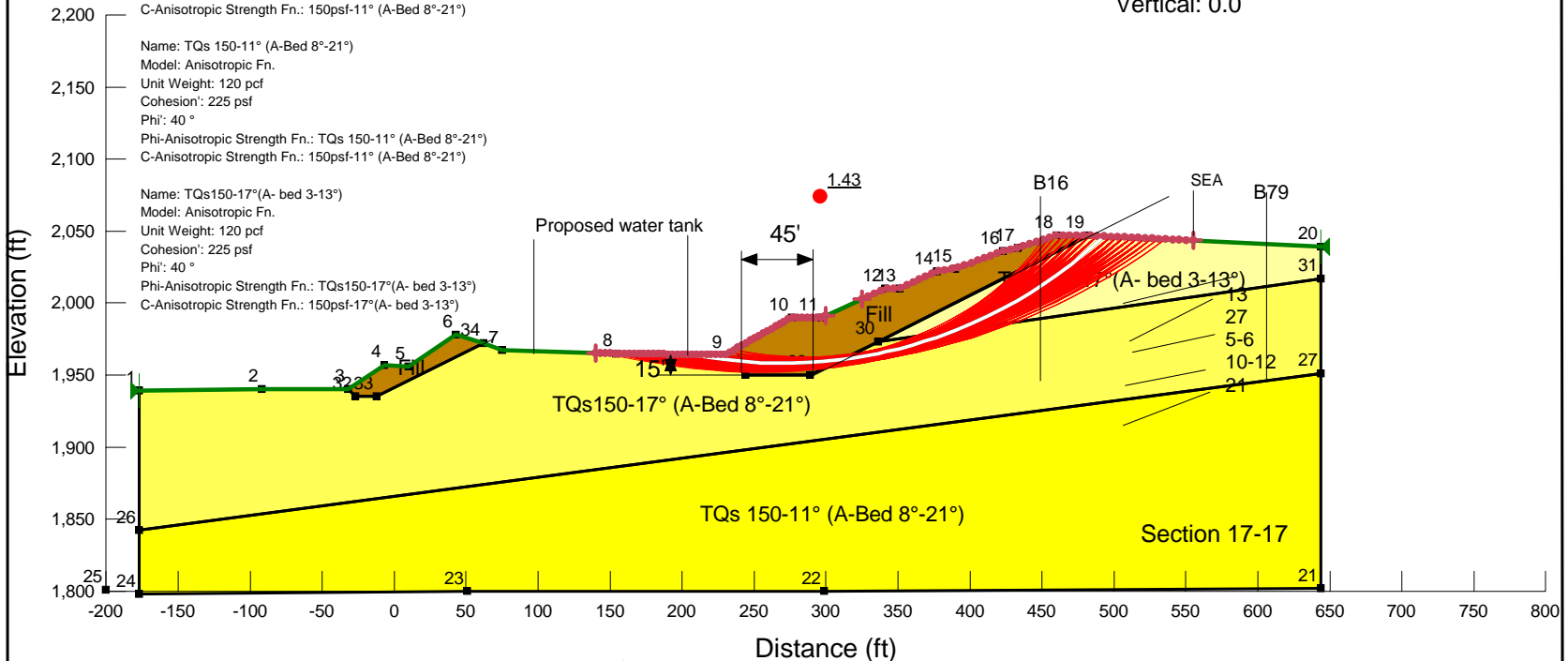

LGC Valley, Inc
 GEOTECHNICAL CONSULTING
 28532 Constellation Road, Valencia, CA 91355
 Phone 661-702-8474, Fax 661-702-8475

Skyline Ranch
 Development project, Tract 60922
 Los Angeles CA

Project No: **153035-01**
 Engineer: **BAS**
 Date: **March 2016**

1 - Circular Mode of Failure

Report generated using GeoStudio 2012. Copyright © 1991-2015 GEO-SLOPE International Ltd.

File Information

File Version: 8.15
 Title: Static Slope Stability Analyses for Skyline Ranch Development project, Tract 60922, Los Angeles CA
 Comments: Run By: Dr. Alexander Bykovtsev, Ph.D., P.E.
 Last Edited By: Alexander Bykovtsev
 Revision Number: 133
 Date: 3/25/2016
 Time: 2:09:52 PM
 Tool Version: 8.15.1.11236
 File Name: Section 17-17 Seismic Final for upper key SSA for Skyline Ranch.gsx
 Directory: G:\SLOPE RESULTS\Section 17-17\Latest Update 3-25-2016\
 Last Solved Date: 3/25/2016
 Last Solved Time: 2:14:27 PM

Project Settings

Length(L) Units: Feet
 Time(t) Units: Seconds
 Force(F) Units: Pounds
 Pressure(p) Units: psf
 Strength Units: psf
 Unit Weight of Water: 62.4 pcf
 View: 2D
 Element Thickness: 1

Analysis Settings

1 - Circular Mode of Failure

Kind: SLOPE/W
 Method: Bishop
 Settings
 PWP Conditions Source: (none)
 Slip Surface
 Direction of movement: Right to Left
 Use Passive Mode: No
 Slip Surface Option: Entry and Exit
 Critical slip surfaces saved: 10
 Resisting Side Maximum Convex Angle: 1 °
 Driving Side Maximum Convex Angle: 5 °
 Optimize Critical Slip Surface Location: No
 Tension Crack
 Tension Crack Option: (none)

file:///G:/SLOPE%20RESULTS/Section%2017-17/Latest%20Update%203-25-2016/sectio... 3/25/2016

F of S Distribution
 F of S Calculation Option: Constant
 Advanced
 Number of Slices: 30
 F of S Tolerance: 0.01
 Minimum Slip Surface Depth: 0.1 ft

Materials

Fill

Model: Mohr-Coulomb
 Unit Weight: 120 pcf
 Cohesion': 200 psf
 Phi': 33 °
 Phi-B: 0 °

TQs150-17° (A-Bed 8°-21°)

Model: Anisotropic Fn.
 Unit Weight: 120 pcf
 Cohesion': 225 psf
 Phi': 40 °
 Phi-Anisotropic Strength Fn.: TQs 150-17° (A-Bed 8°-21°)
 C-Anisotropic Strength Fn.: 150psf-11° (A-Bed 8°-21°)
 Phi-B: 0 °

TQs 150-11° (A-Bed 8°-21°)

Model: Anisotropic Fn.
 Unit Weight: 120 pcf
 Cohesion': 225 psf
 Phi': 40 °
 Phi-Anisotropic Strength Fn.: TQs 150-11° (A-Bed 8°-21°)
 C-Anisotropic Strength Fn.: 150psf-11° (A-Bed 8°-21°)
 Phi-B: 0 °

TQs150-17°(A- bed 3-13°)

Model: Anisotropic Fn.
 Unit Weight: 120 pcf
 Cohesion': 225 psf
 Phi': 40 °
 Phi-Anisotropic Strength Fn.: TQs150-17°(A- bed 3-13°)
 C-Anisotropic Strength Fn.: 150psf-17°(A- bed 3-13°)
 Phi-B: 0 °

Slip Surface Entry and Exit

Left Projection: Range
 Left-Zone Left Coordinate: (140.0889, 1,965.3522) ft
 Left-Zone Right Coordinate: (300, 1,991.3636) ft
 Left-Zone Increment: 50

file:///G:/SLOPE%20RESULTS/Section%2017-17/Latest%20Update%203-25-2016/sectio... 3/25/2016

Right Projection: Range
 Right-Zone Left Coordinate: (325, 2,002.7273) ft
 Right-Zone Right Coordinate: (554.9691, 2,043.3966) ft
 Right-Zone Increment: 50
 Radius Increments: 50

Slip Surface Limits

Left Coordinate: (-177, 1,939) ft
 Right Coordinate: (644, 2,039) ft

Seismic Coefficients

Horz Seismic Coef.: 0.15
 Vert Seismic Coef.: 0

Anisotropic Strength Functions

TQs 150-17° (A-Bed 8°-21°)

Model: Spline Data Point Function
 Function: Modifier Factor vs. Inclination
 Curve Fit to Data: 100 %
 Segment Curvature: 0 %
 Y-Intercept: 1
 Data Points: Inclination (°), Modifier Factor
 Data Point: (-90, 1)
 Data Point: (7.9, 1)
 Data Point: (8, 0.425)
 Data Point: (21, 0.425)
 Data Point: (21.1, 1)

150psf-11° (A-Bed 8°-21°)

Model: Spline Data Point Function
 Function: Modifier Factor vs. Inclination
 Curve Fit to Data: 100 %
 Segment Curvature: 0 %
 Y-Intercept: 1
 Data Points: Inclination (°), Modifier Factor
 Data Point: (-90, 1)
 Data Point: (7.9, 1)
 Data Point: (8, 0.667)
 Data Point: (21, 0.667)
 Data Point: (21.1, 1)

TQs 150-11° (A-Bed 8°-21°)

Model: Spline Data Point Function
 Function: Modifier Factor vs. Inclination
 Curve Fit to Data: 100 %

Segment Curvature: 0 %
 Y-Intercept: 1
 Data Points: Inclination (°), Modifier Factor
 Data Point: (-90, 1)
 Data Point: (7.9, 1)
 Data Point: (8, 0.275)
 Data Point: (21, 0.275)
 Data Point: (21.1, 1)

150psf-17°(A- bed 3-13°)

Model: Spline Data Point Function
 Function: Modifier Factor vs. Inclination
 Curve Fit to Data: 100 %
 Segment Curvature: 0 %
 Y-Intercept: 1
 Data Points: Inclination (°), Modifier Factor
 Data Point: (-90, 1)
 Data Point: (2.9, 1)
 Data Point: (3, 0.667)
 Data Point: (13, 0.667)
 Data Point: (13.1, 1)

TQs150-17°(A- bed 3-13°)

Model: Spline Data Point Function
 Function: Modifier Factor vs. Inclination
 Curve Fit to Data: 100 %
 Segment Curvature: 0 %
 Y-Intercept: 1
 Data Points: Inclination (°), Modifier Factor
 Data Point: (-90, 1)
 Data Point: (2.9, 1)
 Data Point: (3, 0.425)
 Data Point: (13, 0.425)
 Data Point: (13.1, 1)

Points

	X (ft)	Y (ft)
Point 1	-177	1,939
Point 2	-92	1,940
Point 3	-32	1,940
Point 4	-7	1,957
Point 5	10	1,956
Point 6	43	1,978
Point 7	75	1,967
Point 8	154	1,965
Point 9	230	1,964
Point 10	276	1,990

Point 11	297	1,990
Point 12	341	2,010
Point 13	351	2,010
Point 14	377	2,022
Point 15	390	2,024
Point 16	423	2,036
Point 17	433	2,038
Point 18	460	2,047
Point 19	482	2,047
Point 20	644	2,039
Point 21	644	1,802
Point 22	299	1,800
Point 23	51	1,800
Point 24	-177	1,798
Point 25	-200	1,801
Point 26	-177	1,842
Point 27	644	1,951
Point 28	244	1,950
Point 29	289	1,950
Point 30	336	1,973
Point 31	644	2,017
Point 32	-27	1,935
Point 33	-12	1,935
Point 34	62	1,972

Regions

	Material	Points	Area (ft ²)
Region 1	TQs 150-11° (A-Bed 8°-21°)	24,23,22,21,27,26	79,110
Region 2	TQs150-17° (A-Bed 8°-21°)	26,27,31,30,29,28,9,8,7,34,33,32,3,2,1	59,521
Region 3	Fill	9,28,29,30,19,18,17,16,15,14,13,12,11,10	6,290
Region 4	Fill	3,32,33,34,6,5,4	1,137.5
Region 5	TQs150-17°(A- bed 3-13°)	30,31,20,19	9,966

Current Slip Surface

Slip Surface: 53,923
 F of S: 1.43
 Volume: 8,437.7293 ft³
 Weight: 1,012,527.5 lbs
 Resisting Moment: 1.9751456e+008 lbs-ft
 Activating Moment: 1.3820597e+008 lbs-ft
 F of S Rank (Analysis): 1 of 132,651 slip surfaces
 F of S Rank (Query): 1 of 500 slip surfaces
 Exit: (206.90261, 1,964.3039) ft
 Entry: (493.11389, 2,046.4512) ft
 Radius: 326.7372 ft
 Center: (269.77051, 2,284.9358) ft

Slip Slices

	X (ft)	Y (ft)	PWP (psf)	Base Normal Stress (psf)	Frictional Strength (psf)	Cohesive Strength (psf)
Slice 1	212.67696	1,963.279	0	158.24193	132.78075	225
Slice 2	224.22565	1,961.4411	0	368.75512	309.42229	225
Slice 3	231.90862	1,960.4054	0	621.6594	521.63417	225
Slice 4	239.09009	1,959.6854	0	1,198.7847	778.49991	200
Slice 5	249.63578	1,958.8624	0	2,013.3632	1,307.4934	200
Slice 6	260.18147	1,958.382	0	2,762.156	1,793.7651	200
Slice 7	270.72716	1,958.2426	0	3,448.2639	2,239.3287	200
Slice 8	281.25	1,958.4426	0	3,722.5916	2,417.4793	200
Slice 9	291.75	1,958.9812	0	3,602.6169	2,339.5668	200
Slice 10	304.06132	1,960.0806	0	3,779.7273	2,454.5836	200
	315.26886	1,961.4091	0	4,283.9685	1,309.7406	150.075

Slice 11						
Slice 12	323.56132	1,962.6843	0	4,547.0693	1,390.1786	150.075
Slice 13	331.85377	1,964.1789	0	4,781.6767	1,461.9053	150.075
Slice 14	338.5	1,965.5193	0	4,951.2061	1,513.7356	150.075
Slice 15	346	1,967.257	0	4,855.1557	1,484.3701	150.075
Slice 16	355.33333	1,969.6327	0	4,778.64	1,460.9769	150.075
Slice 17	364	1,972.114	0	4,918.3017	1,503.6757	150.075
Slice 18	372.66667	1,974.8572	0	5,026.0973	1,536.6321	150.075
Slice 19	382.68126	1,978.3878	0	4,913.1984	1,502.1155	150.075
Slice 20	389.18126	1,980.8018	0	4,151.4333	3,483.4661	225
Slice 21	395.5	1,983.4167	0	4,053.5684	3,401.3478	225
Slice 22	406.5	1,988.2448	0	3,887.8469	3,262.2909	225
Slice 23	417.5	1,993.5681	0	3,678.7198	3,086.8124	225
Slice 24	428	1,999.1248	0	3,365.697	2,824.1551	225
Slice 25	437.5	2,004.5851	0	3,032.2483	2,544.3585	225
Slice 26	446.5	2,010.1718	0	2,743.7251	2,302.2587	225
Slice 27	455.5	2,016.176	0	2,427.0248	2,036.5156	225
Slice 28	465.5	2,023.4019	0	1,886.4833	1,582.9474	225
Slice 29	476.5	2,032.0136	0	1,128.945	947.29731	225
Slice 30	487.55694	2,041.4801	0	320.67201	269.07577	225

Section 17-17 Static Final for upper key SSA for Skyline Ranch.gsz

Section 17-17 Static Final for upper key SSA for Skyline Ranch.gsz Run By: Dr. Alexander Bykovtsev, Ph.D., P.E. 3/25/2016 3:53:58 PM

Name: Fill
 Model: Mohr-Coulomb
 Unit Weight: 120 pcf
 Cohesion: 200 psf
 Phi: 33 °

Name: TQs150-17° (A-Bed 8°-21°)
 Model: Anisotropic Fn.
 Unit Weight: 120 pcf
 Cohesion: 225 psf
 Phi: 40 °
 Phi-Anisotropic Strength Fn.: TQs 150-17° (A-Bed 8°-21°)
 C-Anisotropic Strength Fn.: 150psf-11° (A-Bed 8°-21°)

Name: TQs 150-11° (A-Bed 8°-21°)
 Model: Anisotropic Fn.
 Unit Weight: 120 pcf
 Cohesion: 225 psf
 Phi: 40 °
 Phi-Anisotropic Strength Fn.: TQs 150-11° (A-Bed 8°-21°)
 C-Anisotropic Strength Fn.: 150psf-11° (A-Bed 8°-21°)

Name: TQs150-17°(A- bed 3-13°)
 Model: Anisotropic Fn.
 Unit Weight: 120 pcf
 Cohesion: 225 psf
 Phi: 40 °
 Phi-Anisotropic Strength Fn.: TQs150-17°(A- bed 3-13°)
 C-Anisotropic Strength Fn.: 150psf-17°(A- bed 3-13°)

- Materials**
- Fill
 - TQs150-17° (A-Bed 8°-21°)
 - TQs 150-11° (A-Bed 8°-21°)
 - TQs150-17°(A- bed 3-13°)

Low Key parameters
 Slope 2H:1V
 Depth- 5'
 Width-15'

Upper Key parameters
 Slope 2H:1V
 Depth- 15'
 Width-45'

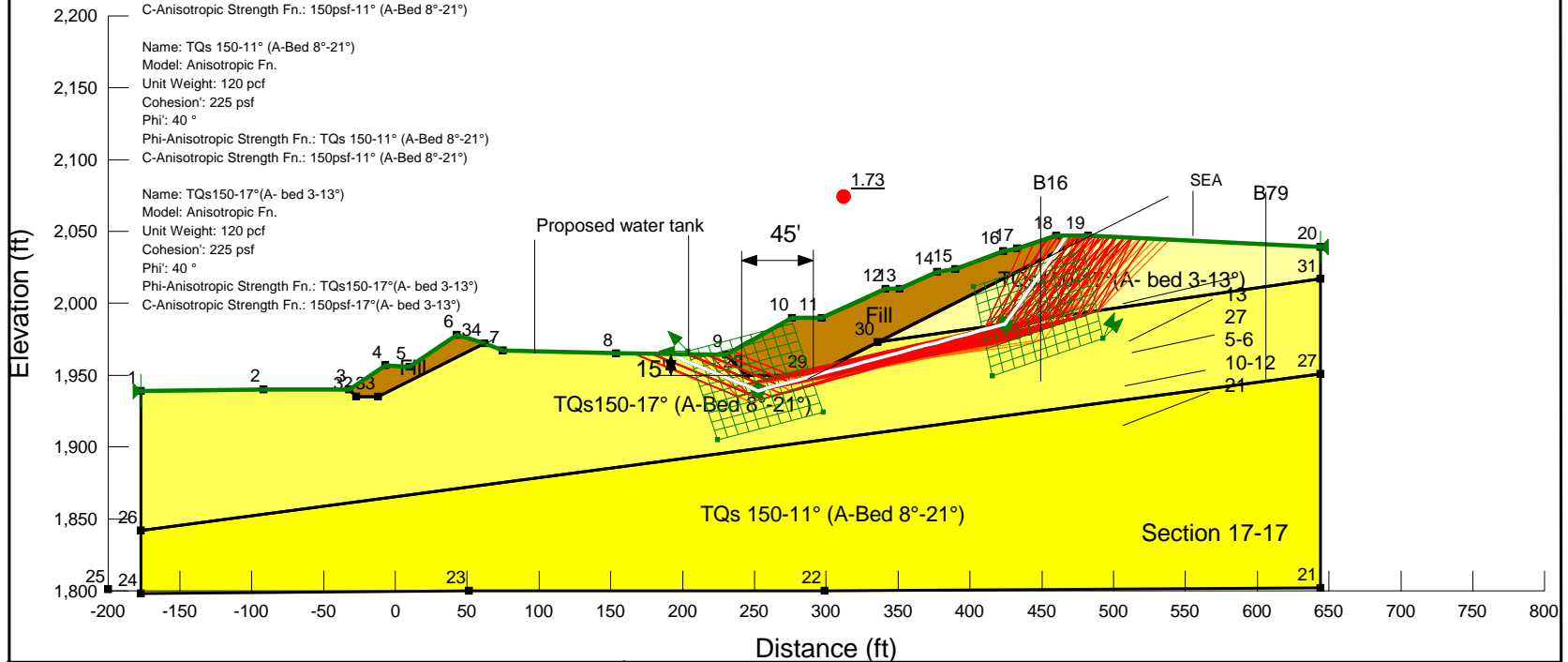

LGC Valley, Inc
 GEOTECHNICAL CONSULTING
 28532 Constellation Road, Valencia, CA 91355
 Phone 661-702-8474, Fax 661-702-8475

Skyline Ranch
 Development project, Tract 60922
 Los Angeles CA

Project No: **153035-01**
 Engineer: **BAS**
 Date: **March 2016**

2 - Translational

Report generated using GeoStudio 2012. Copyright © 1991-2015 GEO-SLOPE International Ltd.

File Information

File Version: 8.15
 Title: Static Slope Stability Analyses for Skyline Ranch Development project, Tract 60922, Los Angeles CA
 Comments: Run By: Dr. Alexander Bykovtsev, Ph.D., P.E.
 Last Edited By: Alexander Bykovtsev
 Revision Number: 136
 Date: 3/25/2016
 Time: 3:53:58 PM
 Tool Version: 8.15.1.11236
 File Name: Section 17-17 Static Final for upper key SSA for Skyline Ranch.gsz
 Directory: G:\SLOPE RESULTS\Section 17-17\Latest Update 3-25-2016\
 Last Solved Date: 3/25/2016
 Last Solved Time: 3:54:26 PM

Project Settings

Length(L) Units: Feet
 Time(t) Units: Seconds
 Force(F) Units: Pounds
 Pressure(p) Units: psf
 Strength Units: psf
 Unit Weight of Water: 62.4 pcf
 View: 2D
 Element Thickness: 1

Analysis Settings

2 - Translational

Kind: [SLOPE/W](#)
 Method: [Janbu](#)
 Settings
 PWP Conditions Source: [\(none\)](#)
 Slip Surface
 Direction of movement: [Right to Left](#)
 Use Passive Mode: [No](#)
 Slip Surface Option: [Block](#)
 Critical slip surfaces saved: [10](#)
 Resisting Side Maximum Convex Angle: [1 °](#)
 Driving Side Maximum Convex Angle: [5 °](#)
 Restrict Block Crossing: [No](#)
 Optimize Critical Slip Surface Location: [No](#)
 Tension Crack

Tension Crack Option: [\(none\)](#)
 F of S Distribution
 F of S Calculation Option: [Constant](#)
 Advanced
 Number of Slices: [30](#)
 F of S Tolerance: [0.01](#)
 Minimum Slip Surface Depth: [0.1 ft](#)

Materials

Fill

Model: [Mohr-Coulomb](#)
 Unit Weight: [120 pcf](#)
 Cohesion': [200 psf](#)
 Phi': [33 °](#)
 Phi-B: [0 °](#)

TQs150-17° (A-Bed 8°-21°)

Model: [Anisotropic Fn.](#)
 Unit Weight: [120 pcf](#)
 Cohesion': [225 psf](#)
 Phi': [40 °](#)
 Phi-Anisotropic Strength Fn.: [TQs 150-17° \(A-Bed 8°-21°\)](#)
 C-Anisotropic Strength Fn.: [150psf-11° \(A-Bed 8°-21°\)](#)
 Phi-B: [0 °](#)

TQs 150-11° (A-Bed 8°-21°)

Model: [Anisotropic Fn.](#)
 Unit Weight: [120 pcf](#)
 Cohesion': [225 psf](#)
 Phi': [40 °](#)
 Phi-Anisotropic Strength Fn.: [TQs 150-11° \(A-Bed 8°-21°\)](#)
 C-Anisotropic Strength Fn.: [150psf-11° \(A-Bed 8°-21°\)](#)
 Phi-B: [0 °](#)

TQs150-17°(A- bed 3-13°)

Model: [Anisotropic Fn.](#)
 Unit Weight: [120 pcf](#)
 Cohesion': [225 psf](#)
 Phi': [40 °](#)
 Phi-Anisotropic Strength Fn.: [TQs150-17°\(A- bed 3-13°\)](#)
 C-Anisotropic Strength Fn.: [150psf-17°\(A- bed 3-13°\)](#)
 Phi-B: [0 °](#)

Slip Surface Limits

Left Coordinate: [\(-177, 1,939\) ft](#)
 Right Coordinate: [\(644, 2,039\) ft](#)

Slip Surface Block

Left Grid

Upper Left: (203.4071, 1,966.474) ft
 Lower Left: (224.4887, 1,905.0009) ft
 Lower Right: (297.7194, 1,924.321) ft
 X Increments: 10
 Y Increments: 10
 Starting Angle: 135 °
 Ending Angle: 180 °
 Angle Increments: 2

Right Grid

Upper Left: (402.5713, 2,011.3338) ft
 Lower Left: (415.8782, 1,949.6751) ft
 Lower Right: (492.5885, 1,975.6366) ft
 X Increments: 10
 Y Increments: 10
 Starting Angle: 45 °
 Ending Angle: 65 °
 Angle Increments: 2

Seismic Coefficients

Horz Seismic Coef.: 0
 Vert Seismic Coef.: 0

Anisotropic Strength Functions

TQs 150-17° (A-Bed 8°-21°)

Model: Spline Data Point Function
 Function: Modifier Factor vs. Inclination
 Curve Fit to Data: 100 %
 Segment Curvature: 0 %

Y-Intercept: 1

Data Points: Inclination (°), Modifier Factor
 Data Point: (-90, 1)
 Data Point: (7.9, 1)
 Data Point: (8, 0.425)
 Data Point: (21, 0.425)
 Data Point: (21.1, 1)

150psf-11° (A-Bed 8°-21°)

Model: Spline Data Point Function
 Function: Modifier Factor vs. Inclination
 Curve Fit to Data: 100 %
 Segment Curvature: 0 %

Y-Intercept: 1

Data Points: Inclination (°), Modifier Factor
 Data Point: (-90, 1)

Data Point: (7.9, 1)
 Data Point: (8, 0.667)
 Data Point: (21, 0.667)
 Data Point: (21.1, 1)

TQs 150-11° (A-Bed 8°-21°)

Model: Spline Data Point Function
 Function: Modifier Factor vs. Inclination
 Curve Fit to Data: 100 %
 Segment Curvature: 0 %

Y-Intercept: 1

Data Points: Inclination (°), Modifier Factor
 Data Point: (-90, 1)
 Data Point: (7.9, 1)
 Data Point: (8, 0.275)
 Data Point: (21, 0.275)
 Data Point: (21.1, 1)

150psf-17°(A- bed 3-13°)

Model: Spline Data Point Function
 Function: Modifier Factor vs. Inclination
 Curve Fit to Data: 100 %
 Segment Curvature: 0 %

Y-Intercept: 1

Data Points: Inclination (°), Modifier Factor
 Data Point: (-90, 1)
 Data Point: (2.9, 1)
 Data Point: (3, 0.667)
 Data Point: (13, 0.667)
 Data Point: (13.1, 1)

TQs150-17°(A- bed 3-13°)

Model: Spline Data Point Function
 Function: Modifier Factor vs. Inclination
 Curve Fit to Data: 100 %
 Segment Curvature: 0 %

Y-Intercept: 1

Data Points: Inclination (°), Modifier Factor
 Data Point: (-90, 1)
 Data Point: (2.9, 1)
 Data Point: (3, 0.425)
 Data Point: (13, 0.425)
 Data Point: (13.1, 1)

Points

	X (ft)	Y (ft)
Point 1	-177	1,939
Point 2	-92	1,940

Point 3	-32	1,940
Point 4	-7	1,957
Point 5	10	1,956
Point 6	43	1,978
Point 7	75	1,967
Point 8	154	1,965
Point 9	230	1,964
Point 10	276	1,990
Point 11	297	1,990
Point 12	341	2,010
Point 13	351	2,010
Point 14	377	2,022
Point 15	390	2,024
Point 16	423	2,036
Point 17	433	2,038
Point 18	460	2,047
Point 19	482	2,047
Point 20	644	2,039
Point 21	644	1,802
Point 22	299	1,800
Point 23	51	1,800
Point 24	-177	1,798
Point 25	-200	1,801
Point 26	-177	1,842

Point 27	644	1,951
Point 28	244	1,950
Point 29	289	1,950
Point 30	336	1,973
Point 31	644	2,017
Point 32	-27	1,935
Point 33	-12	1,935
Point 34	62	1,972

Regions

	Material	Points	Area (ft ²)
Region 1	TQs 150-11° (A-Bed 8°-21°)	24,23,22,21,27,26	79,110
Region 2	TQs150-17° (A-Bed 8°-21°)	26,27,31,30,29,28,9,8,7,34,33,32,3,2,1	59,521
Region 3	Fill	9,28,29,30,19,18,17,16,15,14,13,12,11,10	6,290
Region 4	Fill	3,32,33,34,6,5,4	1,137.5
Region 5	TQs150-17°(A- bed 3-13°)	30,31,20,19	9,966

Current Slip Surface

Slip Surface: 53,897
 F of S: 1.73
 Volume: 9,718.7286 ft³
 Weight: 1,166,247.4 lbs
 Resisting Force: 496,685.99 lbs
 Activating Force: 287,333.37 lbs
 F of S Rank (Analysis): 1 of 131,769 slip surfaces
 F of S Rank (Query): 1 of 500 slip surfaces
 Exit: (191.70356, 1,964.5039) ft
 Entry: (467.49181, 2,047) ft
 Radius: 141.55999 ft
 Center: (311.08999, 2,067.624) ft

Slip Slices

	X (ft)	Y (ft)	PWP (psf)	Base Normal Stress (psf)	Frictional Strength (psf)	Cohesive Strength (psf)
Slice 1	196.49061	1,962.521	0	355.02851	297.90429	225
	206.06472	1,958.5553	0	931.00138	781.20291	225

Slice 2						
Slice 3	215.63883	1,954.5896	0	1,506.9742	1,264.5015	225
Slice 4	225.21294	1,950.6239	0	2,082.9471	1,747.8002	225
Slice 5	233.5	1,947.1912	0	2,885.1439	2,420.9232	225
Slice 6	240.5	1,944.2918	0	3,913.5646	3,283.8706	225
Slice 7	248.3357	1,941.0461	0	5,064.7648	4,249.8423	225
Slice 8	256.55951	1,940.3008	0	4,412.2459	1,348.9589	150.075
Slice 9	264.33571	1,942.4019	0	4,675.044	1,429.3044	150.075
Slice 10	272.1119	1,944.5031	0	4,937.8421	1,509.6498	150.075
Slice 11	282.5	1,947.3099	0	4,868.0477	1,488.3116	150.075
Slice 12	293	1,950.1471	0	4,543.0431	1,388.9477	150.075
Slice 13	301.875	1,952.5451	0	4,522.1784	1,382.5687	150.075
Slice 14	311.625	1,955.1796	0	4,728.0718	1,445.5166	150.075
Slice 15	321.375	1,957.8141	0	4,933.9651	1,508.4645	150.075
Slice 16	331.125	1,960.4485	0	5,139.8584	1,571.4124	150.075
Slice 17	338.5	1,962.4413	0	5,295.5982	1,619.0268	150.075
Slice 18	346	1,964.4678	0	5,193.6272	1,587.8512	150.075
Slice 19	355.33333	1,966.9897	0	5,133.8426	1,569.5732	150.075
Slice 20	364	1,969.3314	0	5,323.8015	1,627.6495	150.075
Slice 21	372.66667	1,971.6732	0	5,513.7605	1,685.7258	150.075
Slice 22	383.5	1,974.6004	0	5,522.1008	1,688.2756	150.075
Slice 23	394.125	1,977.4713	0	5,479.6125	1,675.2857	150.075
Slice 24	402.375	1,979.7005	0	5,567.9143	1,702.2822	150.075
Slice 25	410.625	1,981.9296	0	5,656.2161	1,729.2788	150.075

Slice 26	418.875	1,984.1588	0	5,744.5179	1,756.2754	150.075
Slice 27	423.60928	1,985.438	0	5,783.7689	1,768.2756	150.075
Slice 28	428.60928	1,991.6716	0	3,163.5561	2,654.5388	225
Slice 29	437.41836	2,004.0507	0	2,406.3027	2,019.1277	225
Slice 30	446.25509	2,016.6708	0	1,719.1959	1,442.5766	225
Slice 31	455.09181	2,029.291	0	1,032.0891	866.02559	225
Slice 32	459.75509	2,035.9508	0	750.94143	487.66707	200
Slice 33	463.7459	2,041.6503	0	311.39534	202.2225	200

Section 17-17 Seismic Final for upper key SSA for Skyline Ranch.gsz

Section 17-17 Seismic Final for upper key SSA for Skyline Ranch.gsz Run By: Dr. Alexander Bykovtsev, Ph.D., P.E. 3/25/2016 2:09:52 PM

Name: Fill
 Model: Mohr-Coulomb
 Unit Weight: 120 pcf
 Cohesion: 200 psf
 Phi: 33 °

Name: TQs150-17° (A-Bed 8°-21°)
 Model: Anisotropic Fn.
 Unit Weight: 120 pcf
 Cohesion: 225 psf
 Phi: 40 °
 Phi-Anisotropic Strength Fn.: TQs 150-17° (A-Bed 8°-21°)
 C-Anisotropic Strength Fn.: 150psf-11° (A-Bed 8°-21°)

Name: TQs 150-11° (A-Bed 8°-21°)
 Model: Anisotropic Fn.
 Unit Weight: 120 pcf
 Cohesion: 225 psf
 Phi: 40 °
 Phi-Anisotropic Strength Fn.: TQs 150-11° (A-Bed 8°-21°)
 C-Anisotropic Strength Fn.: 150psf-11° (A-Bed 8°-21°)

Name: TQs150-17°(A- bed 3-13°)
 Model: Anisotropic Fn.
 Unit Weight: 120 pcf
 Cohesion: 225 psf
 Phi: 40 °
 Phi-Anisotropic Strength Fn.: TQs150-17°(A- bed 3-13°)
 C-Anisotropic Strength Fn.: 150psf-17°(A- bed 3-13°)

Materials

- Fill
- TQs150-17° (A-Bed 8°-21°)
- TQs 150-11° (A-Bed 8°-21°)
- TQs150-17°(A- bed 3-13°)

Low Key parameters
 Slope 2H:1V
 Depth- 5'
 Width-15'

Upper Key parameters
 Slope 2H:1V
 Depth- 15'
 Width-45'

Seimic load
 Horizontal: 0.15
 Vertical: 0.0

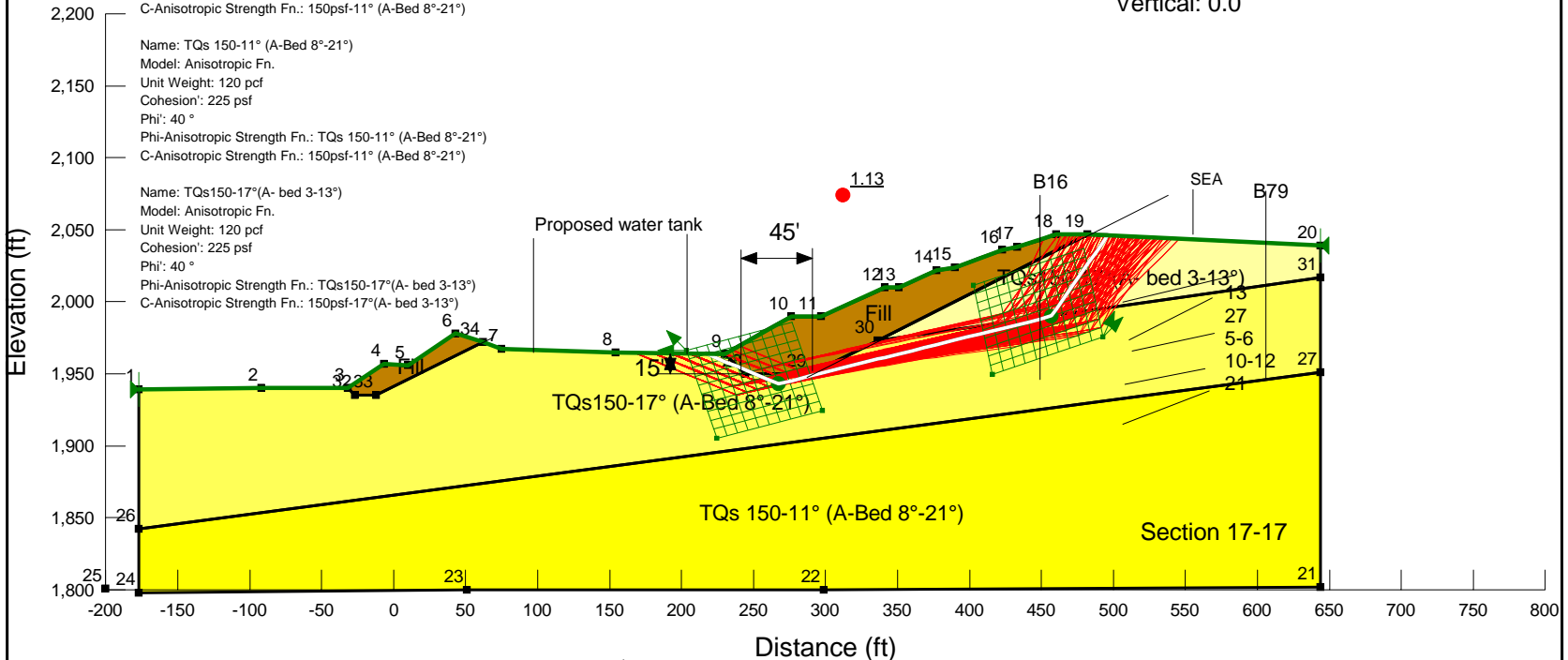

LGC **LGC Valley, Inc**
 GEOTECHNICAL CONSULTING
 28532 Constellation Road, Valencia, CA 91355
 Phone 661-702-8474, Fax 661-702-8475

Skyline Ranch
 Development project, Tract 60922
 Los Angeles CA

Project No: **153035-01**
 Engineer: **BAS**
 Date: **March 2016**

2 - Translational

Report generated using GeoStudio 2012. Copyright © 1991-2015 GEO-SLOPE International Ltd.

File Information

File Version: 8.15
 Title: Static Slope Stability Analyses for Skyline Ranch Development project, Tract 60922, Los Angeles CA
 Comments: Run By: Dr. Alexander Bykovtsev, Ph.D., P.E.
 Last Edited By: Alexander Bykovtsev
 Revision Number: 133
 Date: 3/25/2016
 Time: 2:09:52 PM
 Tool Version: 8.15.1.11236
 File Name: Section 17-17 Seismic Final for upper key SSA for Skyline Ranch.gs
 Directory: G:\SLOPE RESULTS\Section 17-17\Latest Update 3-25-2016\
 Last Solved Date: 3/25/2016
 Last Solved Time: 2:10:09 PM

Project Settings

Length(L) Units: Feet
 Time(t) Units: Seconds
 Force(F) Units: Pounds
 Pressure(p) Units: psf
 Strength Units: psf
 Unit Weight of Water: 62.4 pcf
 View: 2D
 Element Thickness: 1

Analysis Settings

2 - Translational

Kind: SLOPE/W
 Method: Janbu
 Settings
 PWP Conditions Source: (none)
 Slip Surface
 Direction of movement: Right to Left
 Use Passive Mode: No
 Slip Surface Option: Block
 Critical slip surfaces saved: 10
 Resisting Side Maximum Convex Angle: 1 °
 Driving Side Maximum Convex Angle: 5 °
 Restrict Block Crossing: No
 Optimize Critical Slip Surface Location: No
 Tension Crack

file:///G:/SLOPE%20RESULTS/Section%2017-17/Latest%20Update%203-25-2016/sectio... 3/25/2016

Tension Crack Option: (none)
 F of S Distribution
 F of S Calculation Option: Constant
 Advanced
 Number of Slices: 30
 F of S Tolerance: 0.01
 Minimum Slip Surface Depth: 0.1 ft

Materials

Fill

Model: Mohr-Coulomb
 Unit Weight: 120 pcf
 Cohesion': 200 psf
 Phi': 33 °
 Phi-B: 0 °

TQs150-17° (A-Bed 8°-21°)

Model: Anisotropic Fn.
 Unit Weight: 120 pcf
 Cohesion': 225 psf
 Phi': 40 °
 Phi-Anisotropic Strength Fn.: TQs 150-17° (A-Bed 8°-21°)
 C-Anisotropic Strength Fn.: 150psf-11° (A-Bed 8°-21°)
 Phi-B: 0 °

TQs 150-11° (A-Bed 8°-21°)

Model: Anisotropic Fn.
 Unit Weight: 120 pcf
 Cohesion': 225 psf
 Phi': 40 °
 Phi-Anisotropic Strength Fn.: TQs 150-11° (A-Bed 8°-21°)
 C-Anisotropic Strength Fn.: 150psf-11° (A-Bed 8°-21°)
 Phi-B: 0 °

TQs150-17°(A- bed 3-13°)

Model: Anisotropic Fn.
 Unit Weight: 120 pcf
 Cohesion': 225 psf
 Phi': 40 °
 Phi-Anisotropic Strength Fn.: TQs150-17°(A- bed 3-13°)
 C-Anisotropic Strength Fn.: 150psf-17°(A- bed 3-13°)
 Phi-B: 0 °

Slip Surface Limits

Left Coordinate: (-177, 1,939) ft
 Right Coordinate: (644, 2,039) ft

file:///G:/SLOPE%20RESULTS/Section%2017-17/Latest%20Update%203-25-2016/sectio... 3/25/2016

Slip Surface Block

Left Grid

Upper Left: (203.4071, 1,966.474) ft
 Lower Left: (224.4887, 1,905.0009) ft
 Lower Right: (297.7194, 1,924.321) ft
 X Increments: 10
 Y Increments: 10
 Starting Angle: 135 °
 Ending Angle: 180 °
 Angle Increments: 2

Right Grid

Upper Left: (402.5713, 2,011.3338) ft
 Lower Left: (415.8782, 1,949.6751) ft
 Lower Right: (492.5885, 1,975.6366) ft
 X Increments: 10
 Y Increments: 10
 Starting Angle: 45 °
 Ending Angle: 65 °
 Angle Increments: 2

Seismic Coefficients

Horz Seismic Coef.: 0.15
 Vert Seismic Coef.: 0

Anisotropic Strength Functions

TQs 150-17° (A-Bed 8°-21°)

Model: Spline Data Point Function
 Function: Modifier Factor vs. Inclination
 Curve Fit to Data: 100 %
 Segment Curvature: 0 %

Y-Intercept: 1

Data Points: Inclination (°), Modifier Factor
 Data Point: (-90, 1)
 Data Point: (7.9, 1)
 Data Point: (8, 0.425)
 Data Point: (21, 0.425)
 Data Point: (21.1, 1)

150psf-11° (A-Bed 8°-21°)

Model: Spline Data Point Function
 Function: Modifier Factor vs. Inclination
 Curve Fit to Data: 100 %
 Segment Curvature: 0 %

Y-Intercept: 1

Data Points: Inclination (°), Modifier Factor
 Data Point: (-90, 1)

Data Point: (7.9, 1)
 Data Point: (8, 0.667)
 Data Point: (21, 0.667)
 Data Point: (21.1, 1)

TQs 150-11° (A-Bed 8°-21°)

Model: Spline Data Point Function
 Function: Modifier Factor vs. Inclination
 Curve Fit to Data: 100 %
 Segment Curvature: 0 %

Y-Intercept: 1

Data Points: Inclination (°), Modifier Factor
 Data Point: (-90, 1)
 Data Point: (7.9, 1)
 Data Point: (8, 0.275)
 Data Point: (21, 0.275)
 Data Point: (21.1, 1)

150psf-17°(A- bed 3-13°)

Model: Spline Data Point Function
 Function: Modifier Factor vs. Inclination
 Curve Fit to Data: 100 %
 Segment Curvature: 0 %

Y-Intercept: 1

Data Points: Inclination (°), Modifier Factor
 Data Point: (-90, 1)
 Data Point: (2.9, 1)
 Data Point: (3, 0.667)
 Data Point: (13, 0.667)
 Data Point: (13.1, 1)

TQs150-17°(A- bed 3-13°)

Model: Spline Data Point Function
 Function: Modifier Factor vs. Inclination
 Curve Fit to Data: 100 %
 Segment Curvature: 0 %

Y-Intercept: 1

Data Points: Inclination (°), Modifier Factor
 Data Point: (-90, 1)
 Data Point: (2.9, 1)
 Data Point: (3, 0.425)
 Data Point: (13, 0.425)
 Data Point: (13.1, 1)

Points

	X (ft)	Y (ft)
Point 1	-177	1,939
Point 2	-92	1,940

Point 3	-32	1,940
Point 4	-7	1,957
Point 5	10	1,956
Point 6	43	1,978
Point 7	75	1,967
Point 8	154	1,965
Point 9	230	1,964
Point 10	276	1,990
Point 11	297	1,990
Point 12	341	2,010
Point 13	351	2,010
Point 14	377	2,022
Point 15	390	2,024
Point 16	423	2,036
Point 17	433	2,038
Point 18	460	2,047
Point 19	482	2,047
Point 20	644	2,039
Point 21	644	1,802
Point 22	299	1,800
Point 23	51	1,800
Point 24	-177	1,798
Point 25	-200	1,801
Point 26	-177	1,842

Point 27	644	1,951
Point 28	244	1,950
Point 29	289	1,950
Point 30	336	1,973
Point 31	644	2,017
Point 32	-27	1,935
Point 33	-12	1,935
Point 34	62	1,972

Regions

	Material	Points	Area (ft ²)
Region 1	TQs 150-11° (A-Bed 8°-21°)	24,23,22,21,27,26	79,110
Region 2	TQs150-17° (A-Bed 8°-21°)	26,27,31,30,29,28,9,8,7,34,33,32,3,2,1	59,521
Region 3	Fill	9,28,29,30,19,18,17,16,15,14,13,12,11,10	6,290
Region 4	Fill	3,32,33,34,6,5,4	1,137.5
Region 5	TQs150-17°(A- bed 3-13°)	30,31,20,19	9,966

Current Slip Surface

Slip Surface: 56,054
 F of S: 1.13
 Volume: 11,237.219 ft³
 Weight: 1,348,466.3 lbs
 Resisting Force: 541,566.83 lbs
 Activating Force: 477,623.83 lbs
 F of S Rank (Analysis): 1 of 131,769 slip surfaces
 F of S Rank (Query): 1 of 500 slip surfaces
 Exit: (216.46483, 1,964.1781) ft
 Entry: (496.06625, 2,046.3054) ft
 Radius: 140.58973 ft
 Center: (338.17312, 2,066.8372) ft

Slip Slices

	X (ft)	Y (ft)	PWP (psf)	Base Normal Stress (psf)	Frictional Strength (psf)	Cohesive Strength (psf)
Slice 1	223.23242	1,961.3749	0	585.73832	491.49281	225
	234.63339	1,956.6524	0	1,837.0901	1,541.5016	225

Slice 2						
Slice 3	244.98028	1,952.3666	0	3,250.8355	2,111.1173	200
Slice 4	254.84972	1,948.2786	0	5,253.5951	4,408.2897	225
Slice 5	263.16161	1,944.8357	0	6,658.2807	5,586.9608	225
Slice 6	271.65877	1,944.1877	0	4,849.2884	1,482.5762	150.075
Slice 7	282.5	1,946.8685	0	4,823.7311	1,474.7626	150.075
Slice 8	293	1,949.465	0	4,531.5147	1,385.4231	150.075
Slice 9	301.875	1,951.6596	0	4,533.9115	1,386.1559	150.075
Slice 10	311.625	1,954.0706	0	4,761.3463	1,455.6896	150.075
Slice 11	321.375	1,956.4816	0	4,988.781	1,525.2234	150.075
Slice 12	331.125	1,958.8925	0	5,216.2158	1,594.7572	150.075
Slice 13	338.5	1,960.7162	0	5,388.2497	1,647.3533	150.075
Slice 14	346	1,962.5708	0	5,307.4157	1,622.6398	150.075
Slice 15	355.33333	1,964.8788	0	5,272.7576	1,612.0438	150.075
Slice 16	364	1,967.0219	0	5,481.7427	1,675.9369	150.075
Slice 17	372.66667	1,969.165	0	5,690.7278	1,739.8301	150.075
Slice 18	383.5	1,971.8438	0	5,726.8694	1,750.8797	150.075
Slice 19	394.125	1,974.4712	0	5,712.5365	1,746.4977	150.075
Slice 20	402.375	1,976.5113	0	5,820.5726	1,779.5276	150.075
Slice 21	410.625	1,978.5513	0	5,928.6087	1,812.5576	150.075
Slice 22	418.875	1,980.5914	0	6,036.6448	1,845.5875	150.075
Slice 23	428	1,982.8478	0	6,064.0571	1,853.9683	150.075
Slice 24	436.93027	1,985.0561	0	6,075.5153	1,857.4714	150.075
Slice 25	444.79081	1,986.9998	0	6,151.6433	1,880.7461	150.075

Slice 26	452.77213	1,989.1161	0	6,154.1147	1,881.5017	150.075
Slice 27	458.41159	1,992.5289	0	3,020.2274	2,534.2717	225
Slice 28	465.5	2,002.6522	0	2,458.6349	2,063.0397	225
Slice 29	476.5	2,018.3619	0	1,539.0432	1,291.4105	225
Slice 30	485.51656	2,031.2389	0	775.10001	650.38613	225
Slice 31	492.54968	2,041.2832	0	166.80547	139.96641	225

Section 18-18 Static SSA for Skyline Ranch.gsz

Section 18-18 Static SSA for Skyline Ranch.gsz Run By: Dr. Alexander Bykovtsev, Ph.D., P.E. 3/25/2016 8:30:04 AM

- Materials**
- TQs 100-25° (A-Bed 0°-1°)
 - Tmc 100-25° (A-Bed 12°-24°)
 - Tmc 150-17° (A-Bed 12°-24°)
 - TQs 100-25° (A-Bed 8°-10°)

Seismic load
 Horizontal: 0.15
 Vertical: 0.0

Name: TQs 100-25° (A-Bed 0°-1°)
 Model: Anisotropic Fn.
 Unit Weight: 120 pcf
 Cohesion: 225 psf
 Phi: 40°
 Phi-Anisotropic Strength Fn.: TQs 100-25° (A-Bed 0°-1°)
 C-Anisotropic Strength Fn.: 100psf-25° (A-Bed 0°-1°)

Name: Tmc 100-25° (A-Bed 12°-24°)
 Model: Anisotropic Fn.
 Unit Weight: 120 pcf
 Cohesion: 200 psf
 Phi: 40°
 Phi-Anisotropic Strength Fn.: Tmc 100psf-25° (A-Bed 12°-24°)
 C-Anisotropic Strength Fn.: 100 psf (A-Bed 12°-24°)

Name: Tmc 150-17° (A-Bed 12°-24°)
 Model: Anisotropic Fn.
 Unit Weight: 120 pcf
 Cohesion: 200 psf
 Phi: 40°
 Phi-Anisotropic Strength Fn.: Tmc 150-17° (A-Bed 12°-24°)
 C-Anisotropic Strength Fn.: 150psf-17° (A-Bed 12°-24°)

Name: TQs 100-25° (A-Bed 8°-10°)
 Model: Anisotropic Fn.
 Unit Weight: 120 pcf
 Cohesion: 225 psf
 Phi: 40°
 Phi-Anisotropic Strength Fn.: TQs 100-25° (A-Bed 8°-10°)
 C-Anisotropic Strength Fn.: 100psf-25° (A-Bed 8°-10°)

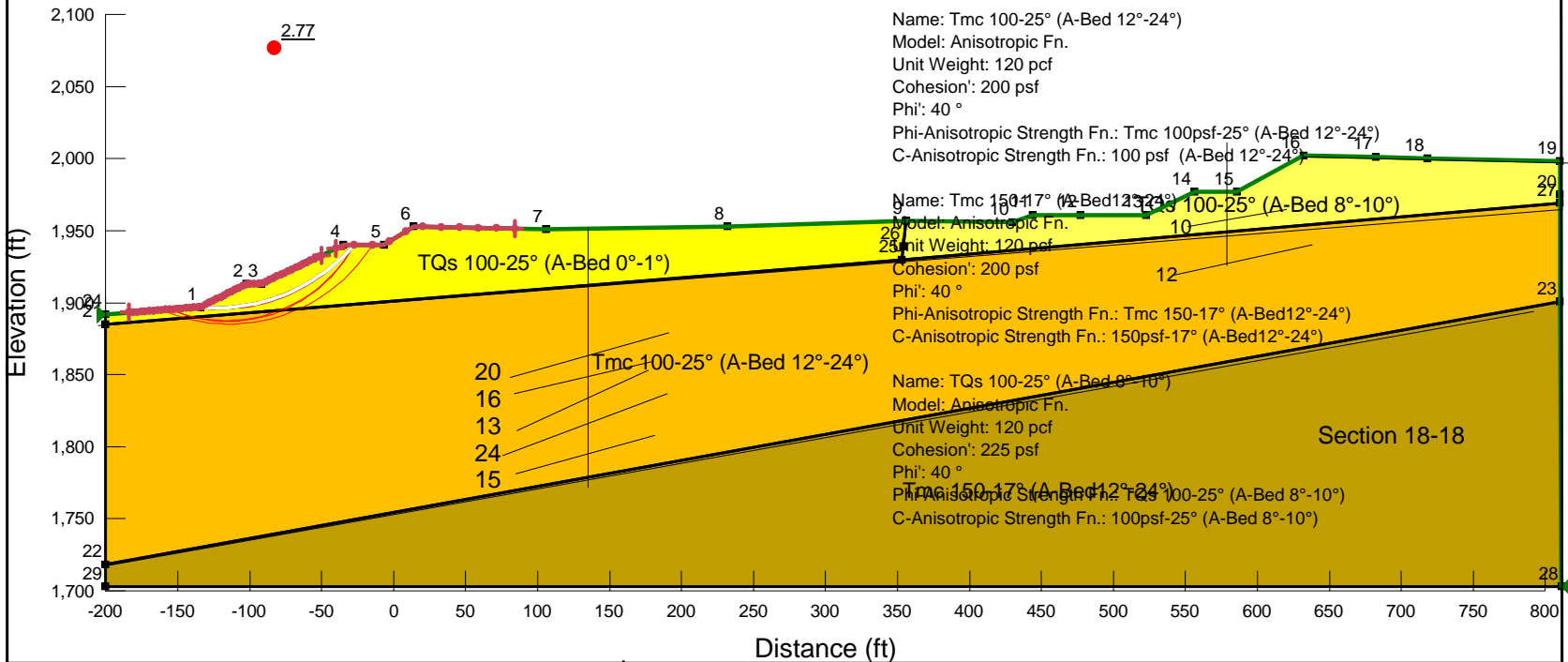

LGC Valley, Inc
 GEOTECHNICAL CONSULTING
 28532 Constellation Road, Valencia, CA 91355
 Phone 661-702-8474, Fax 661-702-8475

Skyline Ranch
 Development project, Tract 60922
 Los Angeles CA

Project No: **153035-01**
 Engineer: **BAS**
 Date: **March 2016**

1 - Circular Mode of Failure

Report generated using GeoStudio 2012. Copyright © 1991-2015 GEO-SLOPE International Ltd.

File Information

File Version: 8.15
 Title: Static Slope Stability Analyses for Skyline Ranch Development project, Tract 60922, Los Angeles CA
 Comments: Run By: Dr. Alexander Bykovtsev, Ph.D., P.E.
 Last Edited By: Alexander Bykovtsev
 Revision Number: 110
 Date: 3/25/2016
 Time: 8:30:04 AM
 Tool Version: 8.15.1.11236
 File Name: Section 18-18 Static SSA for Skyline Ranch.gsz
 Directory: G:\SLOPE RESULTS\Section 18-18 results\
 Last Solved Date: 3/25/2016
 Last Solved Time: 8:33:16 AM

Project Settings

Length(L) Units: Feet
 Time(t) Units: Seconds
 Force(F) Units: Pounds
 Pressure(p) Units: psf
 Strength Units: psf
 Unit Weight of Water: 62.4 pcf
 View: 2D
 Element Thickness: 1

Analysis Settings

1 - Circular Mode of Failure

Kind: SLOPE/W
 Method: Bishop
 Settings
 PWP Conditions Source: (none)
 Slip Surface
 Direction of movement: Right to Left
 Use Passive Mode: No
 Slip Surface Option: Entry and Exit
 Critical slip surfaces saved: 10
 Resisting Side Maximum Convex Angle: 1 °
 Driving Side Maximum Convex Angle: 5 °
 Optimize Critical Slip Surface Location: No
 Tension Crack
 Tension Crack Option: (none)

file:///G:/SLOPE%20RESULTS/Section%2018-18%20results/section%2018-18%20static... 3/25/2016

F of S Distribution
 F of S Calculation Option: Constant
 Advanced
 Number of Slices: 30
 F of S Tolerance: 0.01
 Minimum Slip Surface Depth: 0.1 ft

Materials

TQs 100-25° (A-Bed 0°-1°)

Model: Anisotropic Fn.
 Unit Weight: 120 pcf
 Cohesion': 225 psf
 Phi': 40 °
 Phi-Anisotropic Strength Fn.: TQs 100-25° (A-Bed 0°-1°)
 C-Anisotropic Strength Fn.: 100psf-25° (A-Bed 0°-1°)
 Phi-B: 0 °

Tmc 100-25° (A-Bed 12°-24°)

Model: Anisotropic Fn.
 Unit Weight: 120 pcf
 Cohesion': 200 psf
 Phi': 40 °
 Phi-Anisotropic Strength Fn.: Tmc 100psf-25° (A-Bed 12°-24°)
 C-Anisotropic Strength Fn.: 100 psf (A-Bed 12°-24°)
 Phi-B: 0 °

Tmc 150-17° (A-Bed 12°-24°)

Model: Anisotropic Fn.
 Unit Weight: 120 pcf
 Cohesion': 200 psf
 Phi': 40 °
 Phi-Anisotropic Strength Fn.: Tmc 150-17° (A-Bed 12°-24°)
 C-Anisotropic Strength Fn.: 150psf-17° (A-Bed 12°-24°)
 Phi-B: 0 °

TQs 100-25° (A-Bed 8°-10°)

Model: Anisotropic Fn.
 Unit Weight: 120 pcf
 Cohesion': 225 psf
 Phi': 40 °
 Phi-Anisotropic Strength Fn.: TQs 100-25° (A-Bed 8°-10°)
 C-Anisotropic Strength Fn.: 100psf-25° (A-Bed 8°-10°)
 Phi-B: 0 °

Slip Surface Entry and Exit

Left Projection: Range
 Left-Zone Left Coordinate: (-183.7817, 1,893.2287) ft

file:///G:/SLOPE%20RESULTS/Section%2018-18%20results/section%2018-18%20static... 3/25/2016

Left-Zone Right Coordinate: (-50, 1,932.8947) ft
Left-Zone Increment: 50
Right Projection: Range
Right-Zone Left Coordinate: (-40, 1,937.6316) ft
Right-Zone Right Coordinate: (84.5043, 1,951.4673) ft
Right-Zone Increment: 10
Radius Increments: 50

Slip Surface Limits

Left Coordinate: (-200, 1,892) ft
Right Coordinate: (811, 1,703) ft

Seismic Coefficients

Horz Seismic Coef.: 0
Vert Seismic Coef.: 0

Anisotropic Strength Functions

TQs 100-25° (A-Bed 0°-1°)

Model: Spline Data Point Function
Function: Modifier Factor vs. Inclination
Curve Fit to Data: 100 %
Segment Curvature: 0 %
Y-Intercept: 0.625
Data Points: Inclination (°), Modifier Factor
Data Point: (-90, 1)
Data Point: (-0.9, 1)
Data Point: (0, 0.625)
Data Point: (1, 0.625)
Data Point: (1.1, 1)

100 psf (A-Bed 12°-24°)

Model: Spline Data Point Function
Function: Modifier Factor vs. Inclination
Curve Fit to Data: 100 %
Segment Curvature: 0 %
Y-Intercept: 1
Data Points: Inclination (°), Modifier Factor
Data Point: (-90, 1)
Data Point: (11.9, 1)
Data Point: (12, 0.5)
Data Point: (24, 0.5)
Data Point: (24.1, 1)

100psf-25° (A-Bed 0°-1°)

Model: Spline Data Point Function

Function: Modifier Factor vs. Inclination
Curve Fit to Data: 100 %
Segment Curvature: 0 %
Y-Intercept: 0.444
Data Points: Inclination (°), Modifier Factor
Data Point: (-90, 1)
Data Point: (-0.9, 1)
Data Point: (0, 0.444)
Data Point: (1, 0.444)
Data Point: (1.1, 1)

Tmc 100psf-25° (A-Bed 12°-24°)

Model: Spline Data Point Function
Function: Modifier Factor vs. Inclination
Curve Fit to Data: 100 %
Segment Curvature: 0 %
Y-Intercept: 1
Data Points: Inclination (°), Modifier Factor
Data Point: (-90, 1)
Data Point: (11.9, 1)
Data Point: (12, 0.625)
Data Point: (24, 0.625)
Data Point: (24.1, 1)

Tmc 150-17° (A-Bed12°-24°)

Model: Spline Data Point Function
Function: Modifier Factor vs. Inclination
Curve Fit to Data: 100 %
Segment Curvature: 0 %
Y-Intercept: 1
Data Points: Inclination (°), Modifier Factor
Data Point: (-90, 1)
Data Point: (11.9, 1)
Data Point: (12, 0.425)
Data Point: (24, 0.425)
Data Point: (24.1, 1)

150psf-17° (A-Bed12°-24°)

Model: Spline Data Point Function
Function: Modifier Factor vs. Inclination
Curve Fit to Data: 100 %
Segment Curvature: 0 %
Y-Intercept: 1
Data Points: Inclination (°), Modifier Factor
Data Point: (-90, 1)
Data Point: (11.9, 1)
Data Point: (12, 0.75)
Data Point: (24, 0.75)
Data Point: (24.1, 1)

100psf-25° (A-Bed 8°-10°)

Model: Spline Data Point Function
 Function: Modifier Factor vs. Inclination
 Curve Fit to Data: 100 %
 Segment Curvature: 0 %
 Y-Intercept: 1
 Data Points: Inclination (°), Modifier Factor
 Data Point: (-90, 1)
 Data Point: (7.9, 1)
 Data Point: (8, 0.444)
 Data Point: (10, 0.444)
 Data Point: (10.1, 1)

TQs 100-25° (A-Bed 8°-10°)

Model: Spline Data Point Function
 Function: Modifier Factor vs. Inclination
 Curve Fit to Data: 100 %
 Segment Curvature: 0 %
 Y-Intercept: 1
 Data Points: Inclination (°), Modifier Factor
 Data Point: (-90, 1)
 Data Point: (7.9, 1)
 Data Point: (8, 0.625)
 Data Point: (10, 0.625)
 Data Point: (10.1, 1)

Points

	X (ft)	Y (ft)
Point 1	-134	1,897
Point 2	-102	1,913
Point 3	-92	1,913
Point 4	-35	1,940
Point 5	-7	1,940
Point 6	14	1,953
Point 7	106	1,951
Point 8	232	1,953
Point 9	356	1,957
Point 10	430	1,956
Point 11	444	1,961
Point 12	477	1,961
Point 13	523	1,961
Point 14	556	1,977
Point 15	586	1,977
Point 16	632	2,002
Point 17	682	2,001
Point 18	718	2,000

Point 19	810	1,998
Point 20	810	1,975
Point 21	-200	1,885
Point 22	-200	1,718
Point 23	810	1,901
Point 24	-200	1,892
Point 25	353	1,930
Point 26	354	1,939
Point 27	810	1,969
Point 28	811	1,703
Point 29	-200	1,703

Regions

	Material	Points	Area (ft²)
Region 1	Tmc 100-25° (A-Bed 12°-24°)	22,23,27,25,21	1.1817e+005
Region 2	TQs 100-25° (A-Bed 0°-1°)	24,21,25,26,9,8,7,6,5,4,3,2,1	17,412
Region 3	TQs 100-25° (A-Bed 8°-10°)	25,27,19,18,17,16,15,14,13,12,11,10,9,26	13,833
Region 4	Tmc 150-17° (A-Bed 12°-24°)	22,23,28,29	1.0766e+005

Current Slip Surface

Slip Surface: 9,606
 F of S: 2.77
 Volume: 1,196.0805 ft³
 Weight: 143,529.66 lbs
 Resisting Moment: 17,939,873 lbs-ft
 Activating Moment: 6,484,986.1 lbs-ft
 F of S Rank (Analysis): 1 of 28,611 slip surfaces
 F of S Rank (Query): 1 of 10 slip surfaces
 Exit: (-135.58029, 1,896.8803) ft
 Entry: (-27.657398, 1,940) ft
 Radius: 127.50094 ft
 Center: (-123.7261, 2,023.829) ft

Slip Slices

--	--	--	--	--	--	--	--	--	--

	X (ft)	Y (ft)	PWP (psf)	Base Normal Stress (psf)	Frictional Strength (psf)	Cohesive Strength (psf)
Slice 1	-134.79015	1,896.8115	0	23.130741	19.408996	225
Slice 2	-132.22222	1,896.6239	0	160.4751	134.6546	225
Slice 3	-128.66667	1,896.4362	0	395.45432	331.82557	225
Slice 4	-125.11111	1,896.3479	0	614.02221	435.95028	186.42259
Slice 5	-121.55556	1,896.3589	0	820.63137	382.66669	99.9
Slice 6	-118	1,896.4691	0	1,006.3444	844.42322	225
Slice 7	-114.44444	1,896.6788	0	1,179.8474	990.00949	225
Slice 8	-110.88889	1,896.9885	0	1,338.7653	1,123.3574	225
Slice 9	-107.33333	1,897.3989	0	1,483.3139	1,244.6481	225
Slice 10	-103.77778	1,897.9111	0	1,613.6657	1,354.0263	225
Slice 11	-100.33333	1,898.5038	0	1,632.0637	1,369.4641	225
Slice 12	-97	1,899.1722	0	1,541.747	1,293.6794	225
Slice 13	-93.66667	1,899.9339	0	1,442.1848	1,210.1368	225
Slice 14	-90.21875	1,900.8235	0	1,422.8438	1,193.9077	225
Slice 15	-86.65625	1,901.8501	0	1,480.6904	1,242.4467	225
Slice 16	-83.09375	1,902.9903	0	1,524.7266	1,279.3976	225
Slice 17	-79.53125	1,904.2476	0	1,554.8728	1,304.6932	225
Slice 18	-75.96875	1,905.6256	0	1,571.0094	1,318.2334	225
Slice 19	-72.40625	1,907.1286	0	1,572.9755	1,319.8832	225
Slice 20	-68.84375	1,908.7615	0	1,560.5666	1,309.4709	225
Slice 21	-65.28125	1,910.5299	0	1,533.5312	1,286.7855	225
Slice 22	-61.71875	1,912.4404	0	1,491.5672	1,251.5735	225
Slice 23	-58.15625	1,914.5002	0	1,434.3174	1,203.5352	225

Slice 24	-54.59375	1,916.7182	0	1,361.3636	1,142.3197	225
Slice 25	-51.03125	1,919.1043	0	1,272.2201	1,067.5194	225
Slice 26	-47.46875	1,921.6704	0	1,166.3259	978.66367	225
Slice 27	-43.90625	1,924.4305	0	1,043.035	875.21029	225
Slice 28	-40.34375	1,927.4011	0	901.60582	756.53711	225
Slice 29	-36.78125	1,930.6026	0	741.18954	621.93187	225
Slice 30	-33.16435	1,934.1169	0	477.79408	400.91683	225
Slice 31	-29.493049	1,937.985	0	114.51666	96.090885	225

Section 18-18 Seismic SSA for Skyline Ranch.gsz

Section 18-18 Seismic SSA for Skyline Ranch.gsz Run By: Dr. Alexander Bykovtsev, Ph.D., P.E. 3/25/2016 8:12:59 AM

Materials

- TQs 100-25° (A-Bed 0°-1°)
- Tmc 100-25° (A-Bed 12°-24°)
- Tmc 150-17° (A-Bed 12°-24°)
- TQs 100-25° (A-Bed 8°-10°)

Seismic load
Horizontal: 0.15
Vertical: 0.0

Name: TQs 100-25° (A-Bed 0°-1°)
Model: Anisotropic Fn.
Unit Weight: 120 pcf
Cohesion: 225 psf
Phi: 40°
Phi-Anisotropic Strength Fn.: TQs 100-25° (A-Bed 0°-1°)
C-Anisotropic Strength Fn.: 100psf-25° (A-Bed 0°-1°)

Name: Tmc 100-25° (A-Bed 12°-24°)
Model: Anisotropic Fn.
Unit Weight: 120 pcf
Cohesion: 200 psf
Phi: 40°
Phi-Anisotropic Strength Fn.: Tmc 100psf-25° (A-Bed 12°-24°)
C-Anisotropic Strength Fn.: 100 psf (A-Bed 12°-24°)

Name: Tmc 150-17° (A-Bed 12°-24°)
Model: Anisotropic Fn.
Unit Weight: 120 pcf
Cohesion: 200 psf
Phi: 40°
Phi-Anisotropic Strength Fn.: Tmc 150-17° (A-Bed 12°-24°)
C-Anisotropic Strength Fn.: 150psf-17° (A-Bed 12°-24°)

Name: TQs 100-25° (A-Bed 8°-10°)
Model: Anisotropic Fn.
Unit Weight: 120 pcf
Cohesion: 225 psf
Phi: 40°
Phi-Anisotropic Strength Fn.: TQs 100-25° (A-Bed 8°-10°)
C-Anisotropic Strength Fn.: 100psf-25° (A-Bed 8°-10°)

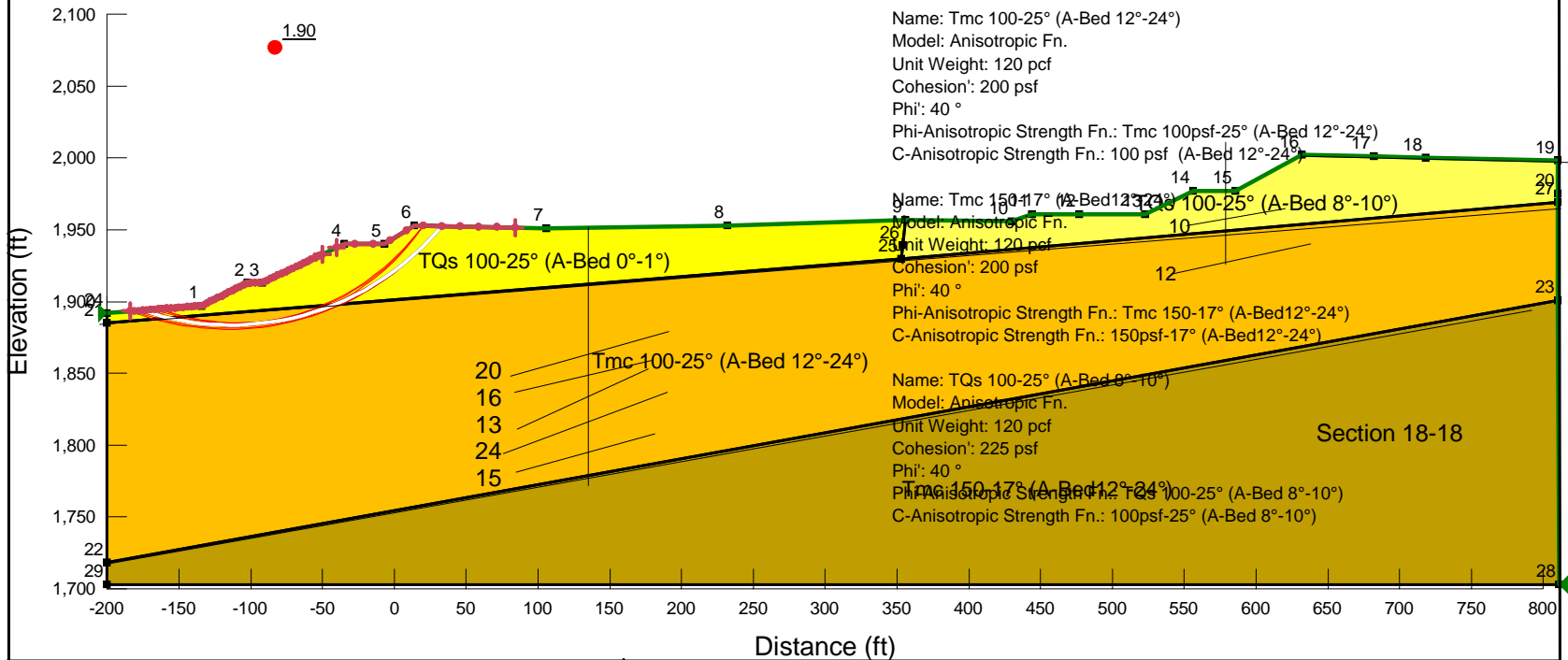

LGC **LGC Valley, Inc**
 GEOTECHNICAL CONSULTING
 28532 Constellation Road, Valencia, CA 91355
 Phone 661-702-8474, Fax 661-702-8475

Skyline Ranch
 Development project, Tract 60922
 Los Angeles CA

Project No: **153035-01**
 Engineer: **BAS**
 Date: **March 2016**

1 - Circular Mode of Failure

Report generated using GeoStudio 2012. Copyright © 1991-2015 GEO-SLOPE International Ltd.

File Information

File Version: 8.15
 Title: Static Slope Stability Analyses for Skyline Ranch Development project, Tract 60922, Los Angeles CA
 Comments: Run By: Dr. Alexander Bykovtsev, Ph.D., P.E.
 Last Edited By: Alexander Bykovtsev
 Revision Number: 107
 Date: 3/25/2016
 Time: 8:12:59 AM
 Tool Version: 8.15.1.11236
 File Name: Section 18-18 Seismic SSA for Skyline Ranch.gsz
 Directory: G:\SLOPE RESULTS\Section 18-18 results\
 Last Solved Date: 3/25/2016
 Last Solved Time: 8:16:26 AM

Project Settings

Length(L) Units: Feet
 Time(t) Units: Seconds
 Force(F) Units: Pounds
 Pressure(p) Units: psf
 Strength Units: psf
 Unit Weight of Water: 62.4 pcf
 View: 2D
 Element Thickness: 1

Analysis Settings

1 - Circular Mode of Failure

Kind: SLOPE/W
 Method: Bishop
 Settings
 PWP Conditions Source: (none)
 Slip Surface
 Direction of movement: Right to Left
 Use Passive Mode: No
 Slip Surface Option: Entry and Exit
 Critical slip surfaces saved: 10
 Resisting Side Maximum Convex Angle: 1 °
 Driving Side Maximum Convex Angle: 5 °
 Optimize Critical Slip Surface Location: No
 Tension Crack
 Tension Crack Option: (none)

file:///G:/SLOPE%20RESULTS/Section%2018-18%20results/Latest%20Update%20-%20... 3/25/2016

F of S Distribution
 F of S Calculation Option: Constant
 Advanced
 Number of Slices: 30
 F of S Tolerance: 0.01
 Minimum Slip Surface Depth: 0.1 ft

Materials

TQs 100-25° (A-Bed 0°-1°)

Model: Anisotropic Fn.
 Unit Weight: 120 pcf
 Cohesion': 225 psf
 Phi': 40 °
 Phi-Anisotropic Strength Fn.: TQs 100-25° (A-Bed 0°-1°)
 C-Anisotropic Strength Fn.: 100psf-25° (A-Bed 0°-1°)
 Phi-B: 0 °

Tmc 100-25° (A-Bed 12°-24°)

Model: Anisotropic Fn.
 Unit Weight: 120 pcf
 Cohesion': 200 psf
 Phi': 40 °
 Phi-Anisotropic Strength Fn.: Tmc 100psf-25° (A-Bed 12°-24°)
 C-Anisotropic Strength Fn.: 100 psf (A-Bed 12°-24°)
 Phi-B: 0 °

Tmc 150-17° (A-Bed 12°-24°)

Model: Anisotropic Fn.
 Unit Weight: 120 pcf
 Cohesion': 200 psf
 Phi': 40 °
 Phi-Anisotropic Strength Fn.: Tmc 150-17° (A-Bed 12°-24°)
 C-Anisotropic Strength Fn.: 150psf-17° (A-Bed 12°-24°)
 Phi-B: 0 °

TQs 100-25° (A-Bed 8°-10°)

Model: Anisotropic Fn.
 Unit Weight: 120 pcf
 Cohesion': 225 psf
 Phi': 40 °
 Phi-Anisotropic Strength Fn.: TQs 100-25° (A-Bed 8°-10°)
 C-Anisotropic Strength Fn.: 100psf-25° (A-Bed 8°-10°)
 Phi-B: 0 °

Slip Surface Entry and Exit

Left Projection: Range
 Left-Zone Left Coordinate: (-183.7817, 1,893.2287) ft

file:///G:/SLOPE%20RESULTS/Section%2018-18%20results/Latest%20Update%20-%20... 3/25/2016

Left-Zone Right Coordinate: (-50, 1,932.8947) ft
Left-Zone Increment: 50
Right Projection: Range
Right-Zone Left Coordinate: (-40, 1,937.6316) ft
Right-Zone Right Coordinate: (84.5043, 1,951.4673) ft
Right-Zone Increment: 10
Radius Increments: 50

Slip Surface Limits

Left Coordinate: (-200, 1,892) ft
Right Coordinate: (811, 1,703) ft

Seismic Coefficients

Horz Seismic Coef.: 0.15
Vert Seismic Coef.: 0

Anisotropic Strength Functions

TQs 100-25° (A-Bed 0°-1°)

Model: Spline Data Point Function
Function: Modifier Factor vs. Inclination
Curve Fit to Data: 100 %
Segment Curvature: 0 %
Y-Intercept: 0.625
Data Points: Inclination (°), Modifier Factor
Data Point: (-90, 1)
Data Point: (-0.9, 1)
Data Point: (0, 0.625)
Data Point: (1, 0.625)
Data Point: (1.1, 1)

100 psf (A-Bed 12°-24°)

Model: Spline Data Point Function
Function: Modifier Factor vs. Inclination
Curve Fit to Data: 100 %
Segment Curvature: 0 %
Y-Intercept: 1
Data Points: Inclination (°), Modifier Factor
Data Point: (-90, 1)
Data Point: (11.9, 1)
Data Point: (12, 0.5)
Data Point: (24, 0.5)
Data Point: (24.1, 1)

100psf-25° (A-Bed 0°-1°)

Model: Spline Data Point Function

Function: Modifier Factor vs. Inclination
Curve Fit to Data: 100 %
Segment Curvature: 0 %
Y-Intercept: 0.444
Data Points: Inclination (°), Modifier Factor
Data Point: (-90, 1)
Data Point: (-0.9, 1)
Data Point: (0, 0.444)
Data Point: (1, 0.444)
Data Point: (1.1, 1)

Tmc 100psf-25° (A-Bed 12°-24°)

Model: Spline Data Point Function
Function: Modifier Factor vs. Inclination
Curve Fit to Data: 100 %
Segment Curvature: 0 %
Y-Intercept: 1
Data Points: Inclination (°), Modifier Factor
Data Point: (-90, 1)
Data Point: (11.9, 1)
Data Point: (12, 0.625)
Data Point: (24, 0.625)
Data Point: (24.1, 1)

Tmc 150-17° (A-Bed12°-24°)

Model: Spline Data Point Function
Function: Modifier Factor vs. Inclination
Curve Fit to Data: 100 %
Segment Curvature: 0 %
Y-Intercept: 1
Data Points: Inclination (°), Modifier Factor
Data Point: (-90, 1)
Data Point: (11.9, 1)
Data Point: (12, 0.425)
Data Point: (24, 0.425)
Data Point: (24.1, 1)

150psf-17° (A-Bed12°-24°)

Model: Spline Data Point Function
Function: Modifier Factor vs. Inclination
Curve Fit to Data: 100 %
Segment Curvature: 0 %
Y-Intercept: 1
Data Points: Inclination (°), Modifier Factor
Data Point: (-90, 1)
Data Point: (11.9, 1)
Data Point: (12, 0.75)
Data Point: (24, 0.75)
Data Point: (24.1, 1)

100psf-25° (A-Bed 8°-10°)

Model: Spline Data Point Function
 Function: Modifier Factor vs. Inclination
 Curve Fit to Data: 100 %
 Segment Curvature: 0 %
 Y-Intercept: 1
 Data Points: Inclination (°), Modifier Factor
 Data Point: (-90, 1)
 Data Point: (7.9, 1)
 Data Point: (8, 0.444)
 Data Point: (10, 0.444)
 Data Point: (10.1, 1)

TQs 100-25° (A-Bed 8°-10°)

Model: Spline Data Point Function
 Function: Modifier Factor vs. Inclination
 Curve Fit to Data: 100 %
 Segment Curvature: 0 %
 Y-Intercept: 1
 Data Points: Inclination (°), Modifier Factor
 Data Point: (-90, 1)
 Data Point: (7.9, 1)
 Data Point: (8, 0.625)
 Data Point: (10, 0.625)
 Data Point: (10.1, 1)

Points

	X (ft)	Y (ft)
Point 1	-134	1,897
Point 2	-102	1,913
Point 3	-92	1,913
Point 4	-35	1,940
Point 5	-7	1,940
Point 6	14	1,953
Point 7	106	1,951
Point 8	232	1,953
Point 9	356	1,957
Point 10	430	1,956
Point 11	444	1,961
Point 12	477	1,961
Point 13	523	1,961
Point 14	556	1,977
Point 15	586	1,977
Point 16	632	2,002
Point 17	682	2,001
Point 18	718	2,000

Point 19	810	1,998
Point 20	810	1,975
Point 21	-200	1,885
Point 22	-200	1,718
Point 23	810	1,901
Point 24	-200	1,892
Point 25	353	1,930
Point 26	354	1,939
Point 27	810	1,969
Point 28	811	1,703
Point 29	-200	1,703

Regions

	Material	Points	Area (ft²)
Region 1	Tmc 100-25° (A-Bed 12°-24°)	22,23,27,25,21	1.1817e+005
Region 2	TQs 100-25° (A-Bed 0°-1°)	24,21,25,26,9,8,7,6,5,4,3,2,1	17,412
Region 3	TQs 100-25° (A-Bed 8°-10°)	25,27,19,18,17,16,15,14,13,12,11,10,9,26	13,833
Region 4	Tmc 150-17° (A-Bed 12°-24°)	22,23,28,29	1.0766e+005

Current Slip Surface

Slip Surface: 2,010
 F of S: 1.90
 Volume: 4,805.593 ft³
 Weight: 576,671.16 lbs
 Resisting Moment: 86,314,275 lbs-ft
 Activating Moment: 45,380,337 lbs-ft
 F of S Rank (Analysis): 1 of 28,611 slip surfaces
 F of S Rank (Query): 1 of 10 slip surfaces
 Exit: (-175.27557, 1,893.8731) ft
 Entry: (33.015783, 1,952.5866) ft
 Radius: 191.08825 ft
 Center: (-113.86136, 2,074.8234) ft

Slip Slices

--	--	--	--	--	--	--	--	--	--

	X (ft)	Y (ft)	PWP (psf)	Base Normal Stress (psf)	Frictional Strength (psf)	Cohesive Strength (psf)
Slice 1	-172.13922	1,892.8685	0	217.65997	182.6384	225
Slice 2	-165.86654	1,890.9768	0	533.00672	447.24575	225
Slice 3	-159.59385	1,889.3164	0	806.12499	676.41918	225
Slice 4	-152.71459	1,887.7658	0	1,056.5577	886.55718	200
Slice 5	-145.22875	1,886.3654	0	1,285.9335	1,079.0263	200
Slice 6	-137.74292	1,885.2709	0	1,468.2738	1,232.028	200
Slice 7	-130.8	1,884.5145	0	1,769.0414	1,484.402	200
Slice 8	-124.4	1,884.0529	0	2,188.773	1,836.5986	200
Slice 9	-118	1,883.8068	0	2,570.0169	2,156.5002	200
Slice 10	-111.6	1,883.7753	0	2,914.5093	2,445.5637	200
Slice 11	-105.2	1,883.9584	0	3,223.7228	2,705.0246	200
Slice 12	-97	1,884.5467	0	3,277.0477	2,749.7695	200
Slice 13	-88.407729	1,885.4727	0	3,297.8835	2,767.2528	200
Slice 14	-81.223188	1,886.5784	0	3,497.5775	2,934.816	200
Slice 15	-74.038646	1,887.9668	0	3,814.555	1,778.7562	100
Slice 16	-66.854105	1,889.6443	0	3,971.664	1,852.0174	100
Slice 17	-59.669564	1,891.6187	0	4,091.4028	1,907.8525	100
Slice 18	-52.485022	1,893.9	0	4,173.3937	1,946.0855	100
Slice 19	-45.300481	1,896.4998	0	4,217.0584	1,966.4466	100
Slice 20	-38.354105	1,899.324	0	3,899.8192	3,272.3369	225
Slice 21	-31.5	1,902.4393	0	3,676.3553	3,084.8284	225
Slice 22	-24.5	1,905.9637	0	3,260.9175	2,736.2346	225
	-17.5	1,909.8604	0	2,821.1088	2,367.1913	225

Slice 23						
Slice 24	-10.5	1,914.1565	0	2,356.6867	1,977.4949	225
Slice 25	-3.5	1,918.8852	0	2,065.56	1,733.2106	225
Slice 26	3.5	1,924.0873	0	1,933.6696	1,622.5414	225
Slice 27	10.5	1,929.814	0	1,756.6785	1,474.0283	225
Slice 28	17.169297	1,935.8028	0	1,373.2756	1,152.315	225
Slice 29	23.507892	1,942.0694	0	799.68355	671.01417	225
Slice 30	29.846486	1,948.9678	0	204.55157	171.63915	225

Section 18-18 Static SSA for Skyline Ranch.gsz

Section 18-18 Static SSA for Skyline Ranch.gsz Run By: Dr. Alexander Bykovtsev, Ph.D., P.E. 3/25/2016 8:30:04 AM

- Materials**
- TQs 100-25° (A-Bed 0°-1°)
 - Tmc 100-25° (A-Bed 12°-24°)
 - Tmc 150-17° (A-Bed 12°-24°)
 - TQs 100-25° (A-Bed 8°-10°)

Seismic load
 Horizontal: 0.15
 Vertical: 0.0

Name: TQs 100-25° (A-Bed 0°-1°)
 Model: Anisotropic Fn.
 Unit Weight: 120 pcf
 Cohesion: 225 psf
 Phi: 40 °
 Phi-Anisotropic Strength Fn.: TQs 100-25° (A-Bed 0°-1°)
 C-Anisotropic Strength Fn.: 100psf-25° (A-Bed 0°-1°)

Name: Tmc 100-25° (A-Bed 12°-24°)
 Model: Anisotropic Fn.
 Unit Weight: 120 pcf
 Cohesion: 200 psf
 Phi: 40 °
 Phi-Anisotropic Strength Fn.: Tmc 100psf-25° (A-Bed 12°-24°)
 C-Anisotropic Strength Fn.: 100 psf (A-Bed 12°-24°)

Name: Tmc 150-17° (A-Bed 12°-24°)
 Model: Anisotropic Fn.
 Unit Weight: 120 pcf
 Cohesion: 200 psf
 Phi: 40 °
 Phi-Anisotropic Strength Fn.: Tmc 150-17° (A-Bed 12°-24°)
 C-Anisotropic Strength Fn.: 150psf-17° (A-Bed 12°-24°)

Name: TQs 100-25° (A-Bed 8°-10°)
 Model: Anisotropic Fn.
 Unit Weight: 120 pcf
 Cohesion: 225 psf
 Phi: 40 °
 Phi-Anisotropic Strength Fn.: TQs 100-25° (A-Bed 8°-10°)
 C-Anisotropic Strength Fn.: 100psf-25° (A-Bed 8°-10°)

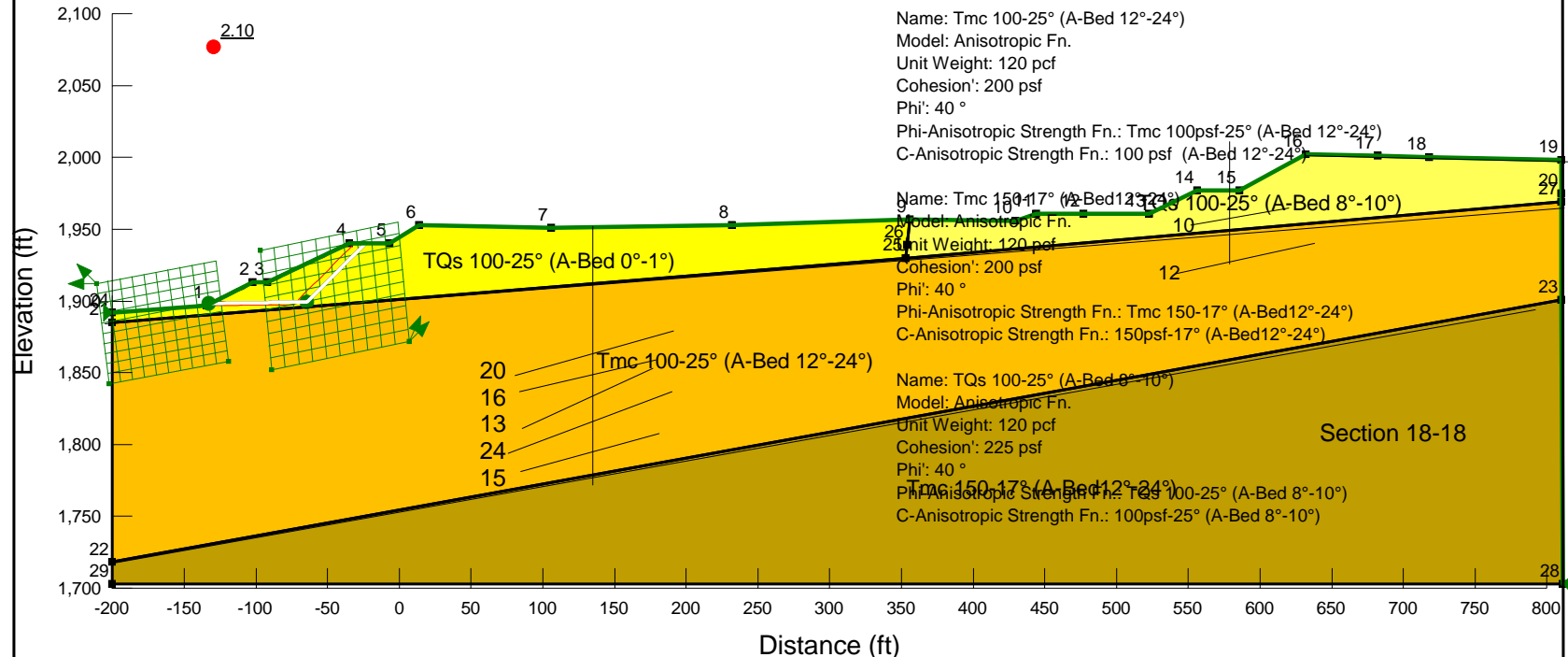

LGC Valley, Inc
 GEOTECHNICAL CONSULTING
 28532 Constellation Road, Valencia, CA 91355
 Phone 661-702-8474, Fax 661-702-8475

Skyline Ranch
 Development project, Tract 60922
 Los Angeles CA

Project No: **153035-01**
 Engineer: **BAS**
 Date: **March 2016**

2 - Translational

Report generated using GeoStudio 2012. Copyright © 1991-2015 GEO-SLOPE International Ltd.

File Information

File Version: 8.15
 Title: Static Slope Stability Analyses for Skyline Ranch Development project, Tract 60922, Los Angeles CA
 Comments: Run By: Dr. Alexander Bykovtsev, Ph.D., P.E.
 Last Edited By: Alexander Bykovtsev
 Revision Number: 110
 Date: 3/25/2016
 Time: 8:30:04 AM
 Tool Version: 8.15.1.11236
 File Name: Section 18-18 Static SSA for Skyline Ranch.gsz
 Directory: G:\SLOPE RESULTS\Section 18-18 results\
 Last Solved Date: 3/25/2016
 Last Solved Time: 8:30:49 AM

Project Settings

Length(L) Units: Feet
 Time(t) Units: Seconds
 Force(F) Units: Pounds
 Pressure(p) Units: psf
 Strength Units: psf
 Unit Weight of Water: 62.4 pcf
 View: 2D
 Element Thickness: 1

Analysis Settings

2 - Translational

Kind: SLOPE/W
 Method: Janbu
 Settings
 PWP Conditions Source: (none)
 Slip Surface
 Direction of movement: Right to Left
 Use Passive Mode: No
 Slip Surface Option: Block
 Critical slip surfaces saved: 10
 Resisting Side Maximum Convex Angle: 1 °
 Driving Side Maximum Convex Angle: 5 °
 Restrict Block Crossing: No
 Optimize Critical Slip Surface Location: No
 Tension Crack

file:///G:/SLOPE%20RESULTS/Section%2018-18%20results/section%2018-18%20static... 3/25/2016

Tension Crack Option: (none)
 F of S Distribution
 F of S Calculation Option: Constant
 Advanced
 Number of Slices: 30
 F of S Tolerance: 0.01
 Minimum Slip Surface Depth: 0.1 ft

Materials

TQs 100-25° (A-Bed 0°-1°)

Model: Anisotropic Fn.
 Unit Weight: 120 pcf
 Cohesion': 225 psf
 Phi': 40 °
 Phi-Anisotropic Strength Fn.: TQs 100-25° (A-Bed 0°-1°)
 C-Anisotropic Strength Fn.: 100psf-25° (A-Bed 0°-1°)
 Phi-B: 0 °

Tmc 100-25° (A-Bed 12°-24°)

Model: Anisotropic Fn.
 Unit Weight: 120 pcf
 Cohesion': 200 psf
 Phi': 40 °
 Phi-Anisotropic Strength Fn.: Tmc 100psf-25° (A-Bed 12°-24°)
 C-Anisotropic Strength Fn.: 100 psf (A-Bed 12°-24°)
 Phi-B: 0 °

Tmc 150-17° (A-Bed 12°-24°)

Model: Anisotropic Fn.
 Unit Weight: 120 pcf
 Cohesion': 200 psf
 Phi': 40 °
 Phi-Anisotropic Strength Fn.: Tmc 150-17° (A-Bed 12°-24°)
 C-Anisotropic Strength Fn.: 150psf-17° (A-Bed 12°-24°)
 Phi-B: 0 °

TQs 100-25° (A-Bed 8°-10°)

Model: Anisotropic Fn.
 Unit Weight: 120 pcf
 Cohesion': 225 psf
 Phi': 40 °
 Phi-Anisotropic Strength Fn.: TQs 100-25° (A-Bed 8°-10°)
 C-Anisotropic Strength Fn.: 100psf-25° (A-Bed 8°-10°)
 Phi-B: 0 °

Slip Surface Limits

Left Coordinate: (-200, 1,892) ft

file:///G:/SLOPE%20RESULTS/Section%2018-18%20results/section%2018-18%20static... 3/25/2016

Right Coordinate: (811, 1,703) ft

Slip Surface Block

Left Grid

Upper Left: (-211, 1,912) ft
 Lower Left: (-202, 1,842) ft
 Lower Right: (-119, 1,858) ft
 X Increments: 10
 Y Increments: 10
 Starting Angle: 135 °
 Ending Angle: 180 °
 Angle Increments: 2

Right Grid

Upper Left: (-97, 1,935) ft
 Lower Left: (-89, 1,852) ft
 Lower Right: (7, 1,872) ft
 X Increments: 10
 Y Increments: 10
 Starting Angle: 45 °
 Ending Angle: 65 °
 Angle Increments: 2

Seismic Coefficients

Horz Seismic Coef.: 0
 Vert Seismic Coef.: 0

Anisotropic Strength Functions

TQs 100-25° (A-Bed 0°-1°)

Model: Spline Data Point Function
 Function: Modifier Factor vs. Inclination
 Curve Fit to Data: 100 %
 Segment Curvature: 0 %

Y-Intercept: 0.625

Data Points: Inclination (°), Modifier Factor
 Data Point: (-90, 1)
 Data Point: (-0.9, 1)
 Data Point: (0, 0.625)
 Data Point: (1, 0.625)
 Data Point: (1.1, 1)

100 psf (A-Bed 12°-24°)

Model: Spline Data Point Function
 Function: Modifier Factor vs. Inclination
 Curve Fit to Data: 100 %
 Segment Curvature: 0 %

Y-Intercept: 1

Data Points: Inclination (°), Modifier Factor
 Data Point: (-90, 1)
 Data Point: (11.9, 1)
 Data Point: (12, 0.5)
 Data Point: (24, 0.5)
 Data Point: (24.1, 1)

100psf-25° (A-Bed 0°-1°)

Model: Spline Data Point Function
 Function: Modifier Factor vs. Inclination
 Curve Fit to Data: 100 %
 Segment Curvature: 0 %

Y-Intercept: 0.444

Data Points: Inclination (°), Modifier Factor
 Data Point: (-90, 1)
 Data Point: (-0.9, 1)
 Data Point: (0, 0.444)
 Data Point: (1, 0.444)
 Data Point: (1.1, 1)

Tmc 100psf-25° (A-Bed 12°-24°)

Model: Spline Data Point Function
 Function: Modifier Factor vs. Inclination
 Curve Fit to Data: 100 %
 Segment Curvature: 0 %

Y-Intercept: 1

Data Points: Inclination (°), Modifier Factor
 Data Point: (-90, 1)
 Data Point: (11.9, 1)
 Data Point: (12, 0.625)
 Data Point: (24, 0.625)
 Data Point: (24.1, 1)

Tmc 150-17° (A-Bed12°-24°)

Model: Spline Data Point Function
 Function: Modifier Factor vs. Inclination
 Curve Fit to Data: 100 %
 Segment Curvature: 0 %

Y-Intercept: 1

Data Points: Inclination (°), Modifier Factor
 Data Point: (-90, 1)
 Data Point: (11.9, 1)
 Data Point: (12, 0.425)
 Data Point: (24, 0.425)
 Data Point: (24.1, 1)

150psf-17° (A-Bed12°-24°)

Model: Spline Data Point Function
 Function: Modifier Factor vs. Inclination

Curve Fit to Data: 100 %
Segment Curvature: 0 %

Y-Intercept: 1

Data Points: Inclination (°), Modifier Factor

- Data Point: (-90, 1)
- Data Point: (11.9, 1)
- Data Point: (12, 0.75)
- Data Point: (24, 0.75)
- Data Point: (24.1, 1)

100psf-25° (A-Bed 8°-10°)

Model: Spline Data Point Function

Function: Modifier Factor vs. Inclination

Curve Fit to Data: 100 %
Segment Curvature: 0 %

Y-Intercept: 1

Data Points: Inclination (°), Modifier Factor

- Data Point: (-90, 1)
- Data Point: (7.9, 1)
- Data Point: (8, 0.444)
- Data Point: (10, 0.444)
- Data Point: (10.1, 1)

TQs 100-25° (A-Bed 8°-10°)

Model: Spline Data Point Function

Function: Modifier Factor vs. Inclination

Curve Fit to Data: 100 %
Segment Curvature: 0 %

Y-Intercept: 1

Data Points: Inclination (°), Modifier Factor

- Data Point: (-90, 1)
- Data Point: (7.9, 1)
- Data Point: (8, 0.625)
- Data Point: (10, 0.625)
- Data Point: (10.1, 1)

Points

	X (ft)	Y (ft)
Point 1	-134	1,897
Point 2	-102	1,913
Point 3	-92	1,913
Point 4	-35	1,940
Point 5	-7	1,940
Point 6	14	1,953
Point 7	106	1,951
Point 8	232	1,953
Point 9	356	1,957

Point 10	430	1,956
Point 11	444	1,961
Point 12	477	1,961
Point 13	523	1,961
Point 14	556	1,977
Point 15	586	1,977
Point 16	632	2,002
Point 17	682	2,001
Point 18	718	2,000
Point 19	810	1,998
Point 20	810	1,975
Point 21	-200	1,885
Point 22	-200	1,718
Point 23	810	1,901
Point 24	-200	1,892
Point 25	353	1,930
Point 26	354	1,939
Point 27	810	1,969
Point 28	811	1,703
Point 29	-200	1,703

Regions

	Material	Points	Area (ft²)
Region 1	Tmc 100-25° (A-Bed 12°-24°)	22,23,27,25,21	1.1817e+005
Region 2	TQs 100-25° (A-Bed 0°-1°)	24,21,25,26,9,8,7,6,5,4,3,2,1	17,412
Region 3	TQs 100-25° (A-Bed 8°-10°)	25,27,19,18,17,16,15,14,13,12,11,10,9,26	13,833

Region 4	Tmc 150-17° (A-Bed12° -24°)	22,23,28,29	1.0766e+005
-------------	--------------------------------	-------------	-------------

Current Slip Surface

Slip Surface: 82,576
 F of S: 2.10
 Volume: 1,528.6087 ft³
 Weight: 183,433.04 lbs
 Resisting Force: 108,394.45 lbs
 Activating Force: 51,627.123 lbs
 F of S Rank (Analysis): 1 of 131,769 slip surfaces
 F of S Rank (Query): 1 of 10 slip surfaces
 Exit: (-131.15023, 1,898.4249) ft
 Entry: (-23.7, 1,940) ft
 Radius: 61.907579 ft
 Center: (-89.489932, 1,950.3938) ft

Slip Slices

	X (ft)	Y (ft)	PWP (psf)	Base Normal Stress (psf)	Frictional Strength (psf)	Cohesive Strength (psf)
Slice 1	-129.32834	1,898.4541	0	104.6639	48.80558	99.9
Slice 2	-125.68456	1,898.5127	0	315.51615	147.1276	99.9
Slice 3	-122.04078	1,898.5712	0	526.3684	245.44962	99.9
Slice 4	-118.397	1,898.6297	0	737.22065	343.77164	99.9
Slice 5	-114.75322	1,898.6882	0	948.0729	442.09365	99.9
Slice 6	-111.10945	1,898.7467	0	1,158.9252	540.41567	99.9
Slice 7	-107.46567	1,898.8052	0	1,369.7774	638.73769	99.9
Slice 8	-103.82189	1,898.8637	0	1,580.6296	737.05971	99.9
Slice 9	-100.33333	1,898.9198	0	1,682.8555	784.72842	99.9
Slice 10	-97	1,898.9733	0	1,676.455	781.74381	99.9
Slice 11	-93.66667	1,899.0268	0	1,670.0545	778.75921	99.9
Slice 12	-90.2625	1,899.0815	0	1,761.9298	821.60135	99.9
Slice 13	-86.7875	1,899.1373	0	1,952.0808	910.27022	99.9
	-83.3125	1,899.1931	0	2,142.2318	998.9391	99.9

Slice 14						
Slice 15	-79.8375	1,899.2489	0	2,332.3828	1,087.608	99.9
Slice 16	-76.3625	1,899.3047	0	2,522.5339	1,176.2769	99.9
Slice 17	-72.8875	1,899.3605	0	2,712.6849	1,264.9457	99.9
Slice 18	-69.4125	1,899.4163	0	2,902.8359	1,353.6146	99.9
Slice 19	-65.9375	1,899.4721	0	3,092.9869	1,442.2835	99.9
Slice 20	-62.375	1,901.325	0	2,126.7401	1,784.5468	225
Slice 21	-58.725	1,904.975	0	1,962.0909	1,646.3897	225
Slice 22	-55.075	1,908.625	0	1,797.4417	1,508.2327	225
Slice 23	-51.425	1,912.275	0	1,632.7925	1,370.0756	225
Slice 24	-47.775	1,915.925	0	1,468.1433	1,231.9185	225
Slice 25	-44.125	1,919.575	0	1,303.4941	1,093.7614	225
Slice 26	-40.475	1,923.225	0	1,138.8448	955.60429	225
Slice 27	-36.825	1,926.875	0	974.19563	817.4472	225
Slice 28	-33.116667	1,930.5833	0	730.45466	612.92423	225
Slice 29	-29.35	1,934.35	0	407.62191	342.0354	225
Slice 30	-25.583333	1,938.1167	0	84.789167	71.146559	225

Section 18-18 Seismic SSA for Skyline Ranch.gsz

Section 18-18 Seismic SSA for Skyline Ranch.gsz Run By: Dr. Alexander Bykovtsev, Ph.D., P.E. 3/25/2016 8:12:59 AM

- Materials**
- TQs 100-25° (A-Bed 0°-1°)
 - Tmc 100-25° (A-Bed 12°-24°)
 - Tmc 150-17° (A-Bed 12°-24°)
 - TQs 100-25° (A-Bed 8°-10°)

Seismic load
 Horizontal: 0.15
 Vertical: 0.0

Name: TQs 100-25° (A-Bed 0°-1°)
 Model: Anisotropic Fn.
 Unit Weight: 120 pcf
 Cohesion: 225 psf
 Phi: 40°
 Phi-Anisotropic Strength Fn.: TQs 100-25° (A-Bed 0°-1°)
 C-Anisotropic Strength Fn.: 100psf-25° (A-Bed 0°-1°)

Name: Tmc 100-25° (A-Bed 12°-24°)
 Model: Anisotropic Fn.
 Unit Weight: 120 pcf
 Cohesion: 200 psf
 Phi: 40°
 Phi-Anisotropic Strength Fn.: Tmc 100psf-25° (A-Bed 12°-24°)
 C-Anisotropic Strength Fn.: 100 psf (A-Bed 12°-24°)

Name: Tmc 150-17° (A-Bed 12°-24°)
 Model: Anisotropic Fn.
 Unit Weight: 120 pcf
 Cohesion: 200 psf
 Phi: 40°
 Phi-Anisotropic Strength Fn.: Tmc 150-17° (A-Bed 12°-24°)
 C-Anisotropic Strength Fn.: 150psf-17° (A-Bed 12°-24°)

Name: TQs 100-25° (A-Bed 8°-10°)
 Model: Anisotropic Fn.
 Unit Weight: 120 pcf
 Cohesion: 225 psf
 Phi: 40°
 Phi-Anisotropic Strength Fn.: TQs 100-25° (A-Bed 8°-10°)
 C-Anisotropic Strength Fn.: 100psf-25° (A-Bed 8°-10°)

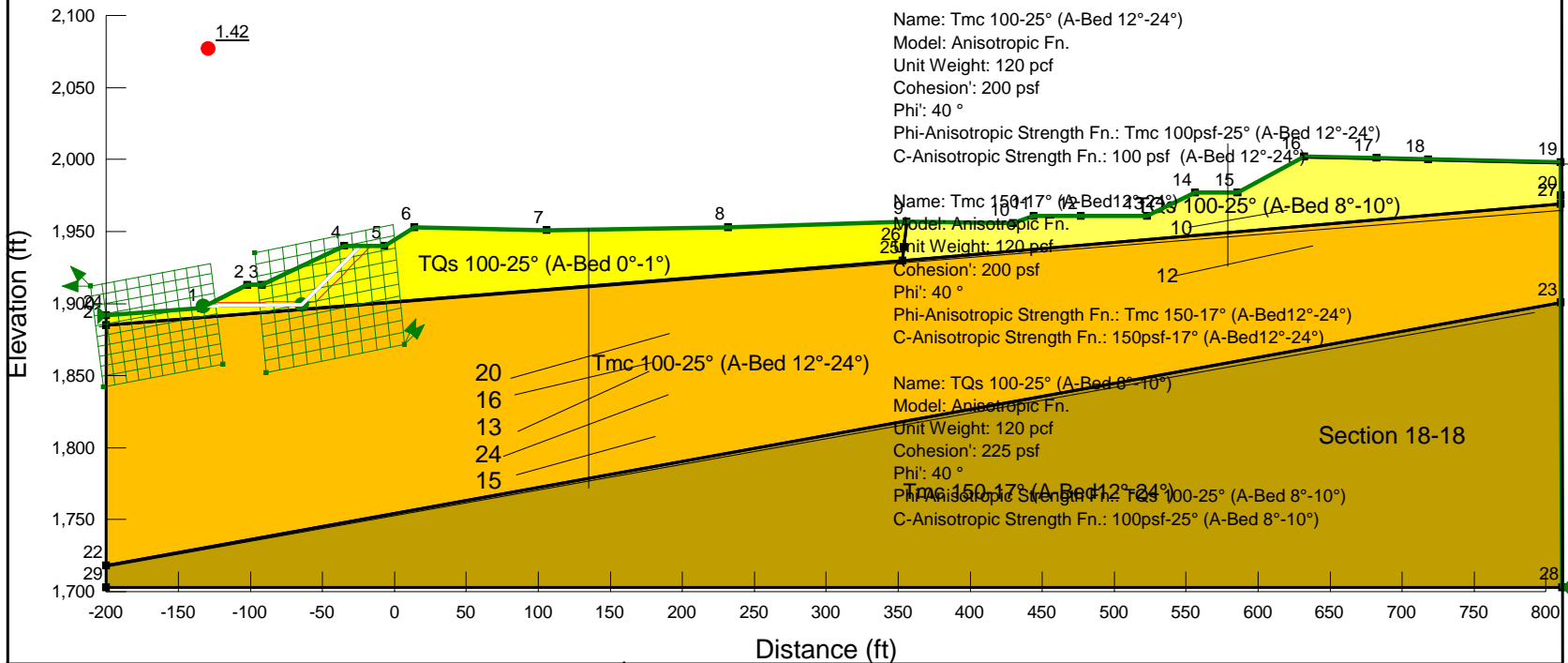

	<p>LGC Valley, Inc GEOTECHNICAL CONSULTING 28532 Constellation Road, Valencia, CA 91355 Phone 661-702-8474, Fax 661-702-8475</p>	<p>Skyline Ranch Development project, Tract 60922 Los Angeles CA</p>	<p>Project No: 153035-01 Engineer: BAS Date: March 2016</p>
--	--	---	--

2 - Translational

Report generated using GeoStudio 2012. Copyright © 1991-2015 GEO-SLOPE International Ltd.

File Information

File Version: 8.15
 Title: Static Slope Stability Analyses for Skyline Ranch Development project, Tract 60922, Los Angeles CA
 Comments: Run By: Dr. Alexander Bykovtsev, Ph.D., P.E.
 Last Edited By: Alexander Bykovtsev
 Revision Number: 107
 Date: 3/25/2016
 Time: 8:12:59 AM
 Tool Version: 8.15.1.11236
 File Name: Section 18-18 Seismic SSA for Skyline Ranch.gsz
 Directory: G:\SLOPE RESULTS\Section 18-18 results\
 Last Solved Date: 3/25/2016
 Last Solved Time: 8:13:12 AM

Project Settings

Length(L) Units: Feet
 Time(t) Units: Seconds
 Force(F) Units: Pounds
 Pressure(p) Units: psf
 Strength Units: psf
 Unit Weight of Water: 62.4 pcf
 View: 2D
 Element Thickness: 1

Analysis Settings

2 - Translational

Kind: SLOPE/W
 Method: Janbu
 Settings
 PWP Conditions Source: (none)
 Slip Surface
 Direction of movement: Right to Left
 Use Passive Mode: No
 Slip Surface Option: Block
 Critical slip surfaces saved: 10
 Resisting Side Maximum Convex Angle: 1 °
 Driving Side Maximum Convex Angle: 5 °
 Restrict Block Crossing: No
 Optimize Critical Slip Surface Location: No
 Tension Crack

file:///G:/SLOPE%20RESULTS/Section%2018-18%20results/section%2018-18%20seismi... 3/25/2016

Tension Crack Option: (none)
 F of S Distribution
 F of S Calculation Option: Constant
 Advanced
 Number of Slices: 30
 F of S Tolerance: 0.01
 Minimum Slip Surface Depth: 0.1 ft

Materials

TQs 100-25° (A-Bed 0°-1°)

Model: Anisotropic Fn.
 Unit Weight: 120 pcf
 Cohesion': 225 psf
 Phi': 40 °
 Phi-Anisotropic Strength Fn.: TQs 100-25° (A-Bed 0°-1°)
 C-Anisotropic Strength Fn.: 100psf-25° (A-Bed 0°-1°)
 Phi-B: 0 °

Tmc 100-25° (A-Bed 12°-24°)

Model: Anisotropic Fn.
 Unit Weight: 120 pcf
 Cohesion': 200 psf
 Phi': 40 °
 Phi-Anisotropic Strength Fn.: Tmc 100psf-25° (A-Bed 12°-24°)
 C-Anisotropic Strength Fn.: 100 psf (A-Bed 12°-24°)
 Phi-B: 0 °

Tmc 150-17° (A-Bed12°-24°)

Model: Anisotropic Fn.
 Unit Weight: 120 pcf
 Cohesion': 200 psf
 Phi': 40 °
 Phi-Anisotropic Strength Fn.: Tmc 150-17° (A-Bed12°-24°)
 C-Anisotropic Strength Fn.: 150psf-17° (A-Bed12°-24°)
 Phi-B: 0 °

TQs 100-25° (A-Bed 8°-10°)

Model: Anisotropic Fn.
 Unit Weight: 120 pcf
 Cohesion': 225 psf
 Phi': 40 °
 Phi-Anisotropic Strength Fn.: TQs 100-25° (A-Bed 8°-10°)
 C-Anisotropic Strength Fn.: 100psf-25° (A-Bed 8°-10°)
 Phi-B: 0 °

Slip Surface Limits

Left Coordinate: (-200, 1,892) ft

file:///G:/SLOPE%20RESULTS/Section%2018-18%20results/section%2018-18%20seismi... 3/25/2016

Right Coordinate: (811, 1,703) ft

Slip Surface Block

Left Grid

Upper Left: (-211, 1,912) ft
 Lower Left: (-202, 1,842) ft
 Lower Right: (-119, 1,858) ft
 X Increments: 10
 Y Increments: 10
 Starting Angle: 135 °
 Ending Angle: 180 °
 Angle Increments: 2

Right Grid

Upper Left: (-97, 1,935) ft
 Lower Left: (-89, 1,852) ft
 Lower Right: (7, 1,872) ft
 X Increments: 10
 Y Increments: 10
 Starting Angle: 45 °
 Ending Angle: 65 °
 Angle Increments: 2

Seismic Coefficients

Horz Seismic Coef.: 0.15
 Vert Seismic Coef.: 0

Anisotropic Strength Functions

TQs 100-25° (A-Bed 0°-1°)

Model: Spline Data Point Function
 Function: Modifier Factor vs. Inclination
 Curve Fit to Data: 100 %
 Segment Curvature: 0 %

Y-Intercept: 0.625

Data Points: Inclination (°), Modifier Factor
 Data Point: (-90, 1)
 Data Point: (-0.9, 1)
 Data Point: (0, 0.625)
 Data Point: (1, 0.625)
 Data Point: (1.1, 1)

100 psf (A-Bed 12°-24°)

Model: Spline Data Point Function
 Function: Modifier Factor vs. Inclination
 Curve Fit to Data: 100 %
 Segment Curvature: 0 %

Y-Intercept: 1

Data Points: Inclination (°), Modifier Factor
 Data Point: (-90, 1)
 Data Point: (11.9, 1)
 Data Point: (12, 0.5)
 Data Point: (24, 0.5)
 Data Point: (24.1, 1)

100psf-25° (A-Bed 0°-1°)

Model: Spline Data Point Function
 Function: Modifier Factor vs. Inclination
 Curve Fit to Data: 100 %
 Segment Curvature: 0 %

Y-Intercept: 0.444

Data Points: Inclination (°), Modifier Factor
 Data Point: (-90, 1)
 Data Point: (-0.9, 1)
 Data Point: (0, 0.444)
 Data Point: (1, 0.444)
 Data Point: (1.1, 1)

Tmc 100psf-25° (A-Bed 12°-24°)

Model: Spline Data Point Function
 Function: Modifier Factor vs. Inclination
 Curve Fit to Data: 100 %
 Segment Curvature: 0 %

Y-Intercept: 1

Data Points: Inclination (°), Modifier Factor
 Data Point: (-90, 1)
 Data Point: (11.9, 1)
 Data Point: (12, 0.625)
 Data Point: (24, 0.625)
 Data Point: (24.1, 1)

Tmc 150-17° (A-Bed12°-24°)

Model: Spline Data Point Function
 Function: Modifier Factor vs. Inclination
 Curve Fit to Data: 100 %
 Segment Curvature: 0 %

Y-Intercept: 1

Data Points: Inclination (°), Modifier Factor
 Data Point: (-90, 1)
 Data Point: (11.9, 1)
 Data Point: (12, 0.425)
 Data Point: (24, 0.425)
 Data Point: (24.1, 1)

150psf-17° (A-Bed12°-24°)

Model: Spline Data Point Function
 Function: Modifier Factor vs. Inclination

Curve Fit to Data: 100 %
Segment Curvature: 0 %

Y-Intercept: 1

Data Points: Inclination (°), Modifier Factor

- Data Point: (-90, 1)
- Data Point: (11.9, 1)
- Data Point: (12, 0.75)
- Data Point: (24, 0.75)
- Data Point: (24.1, 1)

100psf-25° (A-Bed 8°-10°)

Model: Spline Data Point Function

Function: Modifier Factor vs. Inclination

Curve Fit to Data: 100 %
Segment Curvature: 0 %

Y-Intercept: 1

Data Points: Inclination (°), Modifier Factor

- Data Point: (-90, 1)
- Data Point: (7.9, 1)
- Data Point: (8, 0.444)
- Data Point: (10, 0.444)
- Data Point: (10.1, 1)

TQs 100-25° (A-Bed 8°-10°)

Model: Spline Data Point Function

Function: Modifier Factor vs. Inclination

Curve Fit to Data: 100 %
Segment Curvature: 0 %

Y-Intercept: 1

Data Points: Inclination (°), Modifier Factor

- Data Point: (-90, 1)
- Data Point: (7.9, 1)
- Data Point: (8, 0.625)
- Data Point: (10, 0.625)
- Data Point: (10.1, 1)

Points

	X (ft)	Y (ft)
Point 1	-134	1,897
Point 2	-102	1,913
Point 3	-92	1,913
Point 4	-35	1,940
Point 5	-7	1,940
Point 6	14	1,953
Point 7	106	1,951
Point 8	232	1,953
Point 9	356	1,957

Point 10	430	1,956
Point 11	444	1,961
Point 12	477	1,961
Point 13	523	1,961
Point 14	556	1,977
Point 15	586	1,977
Point 16	632	2,002
Point 17	682	2,001
Point 18	718	2,000
Point 19	810	1,998
Point 20	810	1,975
Point 21	-200	1,885
Point 22	-200	1,718
Point 23	810	1,901
Point 24	-200	1,892
Point 25	353	1,930
Point 26	354	1,939
Point 27	810	1,969
Point 28	811	1,703
Point 29	-200	1,703

Regions

	Material	Points	Area (ft²)
Region 1	Tmc 100-25° (A-Bed 12°-24°)	22,23,27,25,21	1.1817e+005
Region 2	TQs 100-25° (A-Bed 0°-1°)	24,21,25,26,9,8,7,6,5,4,3,2,1	17,412
Region 3	TQs 100-25° (A-Bed 8°-10°)	25,27,19,18,17,16,15,14,13,12,11,10,9,26	13,833

Region 4	Tmc 150-17° (A-Bed12° -24°)	22,23,28,29	1.0766e+005
-------------	--------------------------------	-------------	-------------

Current Slip Surface

Slip Surface: 82,576
 F of S: 1.42
 Volume: 1,528.6087 ft³
 Weight: 183,433.04 lbs
 Resisting Force: 102,236.95 lbs
 Activating Force: 71,915.356 lbs
 F of S Rank (Analysis): 1 of 131,769 slip surfaces
 F of S Rank (Query): 1 of 10 slip surfaces
 Exit: (-131.15023, 1,898.4249) ft
 Entry: (-23.7, 1,940) ft
 Radius: 61.907579 ft
 Center: (-89.489932, 1,950.3938) ft

Slip Slices

	X (ft)	Y (ft)	PWP (psf)	Base Normal Stress (psf)	Frictional Strength (psf)	Cohesive Strength (psf)
Slice 1	-129.32834	1,898.4541	0	104.1289	48.556104	99.9
Slice 2	-125.68456	1,898.5127	0	314.62741	146.71317	99.9
Slice 3	-122.04078	1,898.5712	0	525.12593	244.87024	99.9
Slice 4	-118.397	1,898.6297	0	735.62444	343.02731	99.9
Slice 5	-114.75322	1,898.6882	0	946.12295	441.18438	99.9
Slice 6	-111.10945	1,898.7467	0	1,156.6215	539.34145	99.9
Slice 7	-107.46567	1,898.8052	0	1,367.12	637.49852	99.9
Slice 8	-103.82189	1,898.8637	0	1,577.6185	735.65559	99.9
Slice 9	-100.33333	1,898.9198	0	1,679.6729	783.24432	99.9
Slice 10	-97	1,898.9733	0	1,673.2831	780.26472	99.9
Slice 11	-93.666667	1,899.0268	0	1,666.8933	777.28513	99.9
Slice 12	-90.2625	1,899.0815	0	1,758.6145	820.05539	99.9
Slice 13	-86.7875	1,899.1373	0	1,948.4465	908.57551	99.9
	-83.3125	1,899.1931	0	2,138.2785	997.09563	99.9

Slice 14						
Slice 15	-79.8375	1,899.2489	0	2,328.1105	1,085.6158	99.9
Slice 16	-76.3625	1,899.3047	0	2,517.9425	1,174.1359	99.9
Slice 17	-72.8875	1,899.3605	0	2,707.7745	1,262.656	99.9
Slice 18	-69.4125	1,899.4163	0	2,897.6065	1,351.1761	99.9
Slice 19	-65.9375	1,899.4721	0	3,087.4386	1,439.6962	99.9
Slice 20	-62.375	1,901.325	0	1,841.9307	1,545.5634	225
Slice 21	-58.725	1,904.975	0	1,696.8622	1,423.8365	225
Slice 22	-55.075	1,908.625	0	1,551.7938	1,302.1096	225
Slice 23	-51.425	1,912.275	0	1,406.7253	1,180.3827	225
Slice 24	-47.775	1,915.925	0	1,261.6569	1,058.6558	225
Slice 25	-44.125	1,919.575	0	1,116.5884	936.92891	225
Slice 26	-40.475	1,923.225	0	971.51994	815.20202	225
Slice 27	-36.825	1,926.875	0	826.45148	693.47513	225
Slice 28	-33.116667	1,930.5833	0	611.69717	513.27487	225
Slice 29	-29.35	1,934.35	0	327.25701	274.60124	225
Slice 30	-25.583333	1,938.1167	0	42.816852	35.927605	225

Section 19 SSA for Skyline Ranch.gsz

Section 19 SSA for Skyline Ranch.gsz Run By: Dr. Alexander Bykovtsev, Ph.D., P.E. 3/25/2016 3:10:06 PM

- Materials**
- TQs 150-17° (A-Bed6°-7°)
 - Shear Layer
 - Fill
 - Tmc 100-25° (A-Bed0°-5°)
 - Tmc 150-17° (A-Bed0°-5°)
 - TQs 100-25° (A-Bed 6°-13°)

Lower Keyway depth 20'
width 50', backcut slope 2H:1V
Upper Keyway depth 10'
Width 25', Backcut Slope 2H:1V

Current Analysis
1 - Circular Mode of Failure

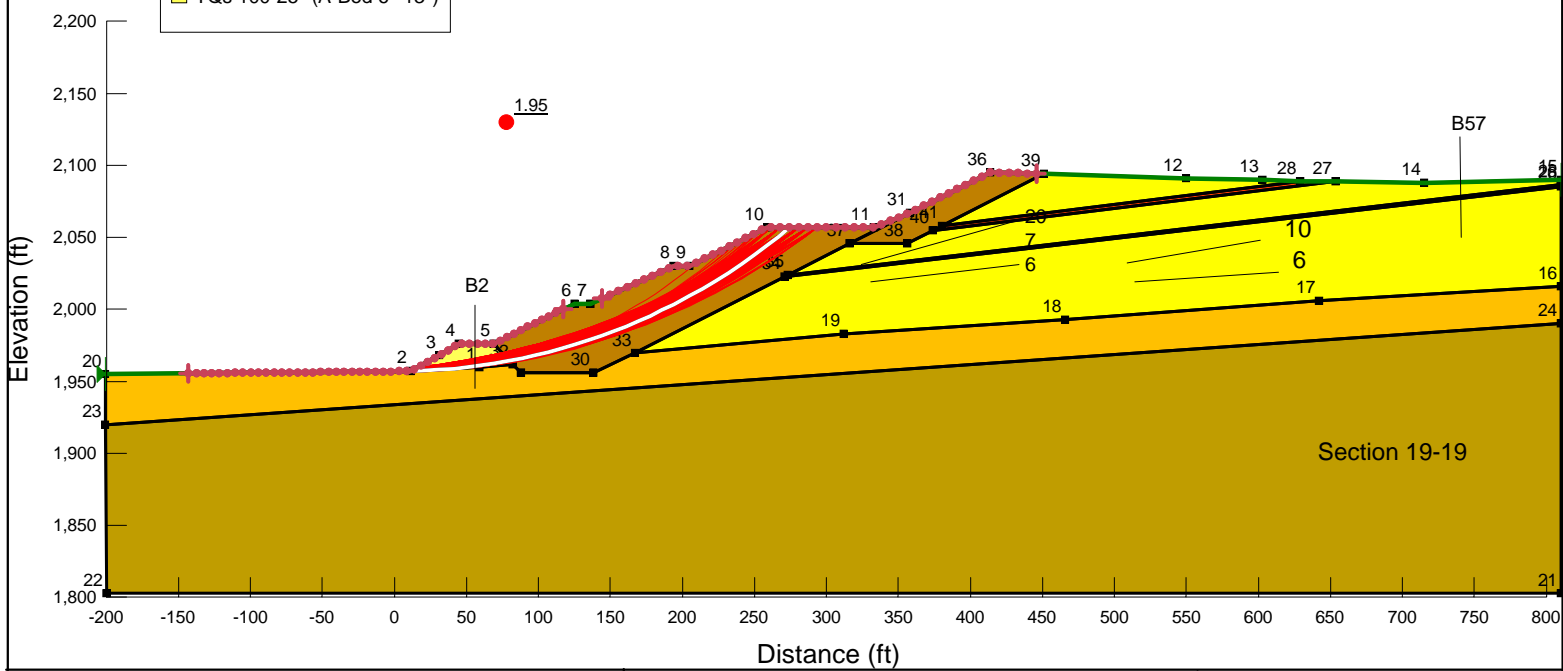

- Name: TQs 150-17° (A-Bed6°-7°)
- Model: Anisotropic Fn.
- Unit Weight: 120 pcf
- Cohesion: 225 psf
- Phi: 40 °
- Phi-Anisotropic Strength Fn.: TQs 150-17° (A-Bed6°-7°)
- C-Anisotropic Strength Fn.: 150psf-17° (A-Bed6°-7°)

- Name: Shear Layer
- Model: Mohr-Coulomb
- Unit Weight: 120 pcf
- Cohesion: 150 psf
- Phi: 11 °

- Name: Fill
- Model: Mohr-Coulomb
- Unit Weight: 120 pcf
- Cohesion: 200 psf
- Phi: 33 °

- Name: Tmc 100-25° (A-Bed0°-5°)
- Model: Anisotropic Fn.
- Unit Weight: 120 pcf
- Cohesion: 200 psf
- Phi: 40 °
- Phi-Anisotropic Strength Fn.: Tmc 100psf-25° (A-Bed0°-5°)
- C-Anisotropic Strength Fn.: 100 psf (A-Bed0°-5°)

- Name: Tmc 150-17° (A-Bed0°-5°)
- Model: Anisotropic Fn.
- Unit Weight: 120 pcf
- Cohesion: 200 psf
- Phi: 40 °
- Phi-Anisotropic Strength Fn.: Tmc 150-17° (A-Bed0°-5°)
- C-Anisotropic Strength Fn.: 150psf-17° (A-Bed0°-5°)

- Name: TQs 100-25° (A-Bed 6°-13°)
- Model: Anisotropic Fn.
- Unit Weight: 120 pcf
- Cohesion: 225 psf
- Phi: 40 °
- Phi-Anisotropic Strength Fn.: TQs 100-25° (A-Bed 6°-13°)
- C-Anisotropic Strength Fn.: 100psf-25° (A-Bed 6°-13°)



LGC Valley, Inc
GEOTECHNICAL CONSULTING
28532 Constellation Road, Valencia, CA 91355
Phone 661-702-8474, Fax 661-702-8475

Skyline Ranch
Development project, Tract 60922
Los Angeles CA

Project No: **153035-01**
Engineer: **BAS**
Date: **March 2016**

1 - Circular Mode of Failure

Report generated using GeoStudio 2012. Copyright © 1991-2015 GEO-SLOPE International Ltd.

File Information

File Version: 8.15
 Title: Static Slope Stability Analyses for Skyline Ranch Development project, Tract 60922, Los Angeles CA
 Comments: Run By: Dr. Alexander Bykovtsev, Ph.D., P.E.
 Last Edited By: Alexander Bykovtsev
 Revision Number: 161
 Date: 3/25/2016
 Time: 3:10:06 PM
 Tool Version: 8.15.1.11777
 File Name: Section 19 SSA for Skyline Ranch.gsz
 Directory: G:\SLOPE RESULTS\Section 19-19 results\Latest Update 3-25-16\
 Last Solved Date: 3/25/2016
 Last Solved Time: 3:12:52 PM

Project Settings

Length(L) Units: Feet
 Time(t) Units: Seconds
 Force(F) Units: Pounds
 Pressure(p) Units: psf
 Strength Units: psf
 Unit Weight of Water: 62.4 pcf
 View: 2D
 Element Thickness: 1

Analysis Settings

1 - Circular Mode of Failure

Kind: SLOPE/W
 Method: Bishop
 Settings
 PWP Conditions Source: (none)
 Slip Surface
 Direction of movement: Right to Left
 Use Passive Mode: No
 Slip Surface Option: Entry and Exit
 Critical slip surfaces saved: 1
 Resisting Side Maximum Convex Angle: 1 °
 Driving Side Maximum Convex Angle: 5 °
 Optimize Critical Slip Surface Location: No
 Tension Crack
 Tension Crack Option: (none)

F of S Distribution
 F of S Calculation Option: Constant
 Advanced
 Number of Slices: 30
 F of S Tolerance: 0.01
 Minimum Slip Surface Depth: 0.1 ft

Materials

TQs 150-17° (A-Bed6°-7°)

Model: Anisotropic Fn.
 Unit Weight: 120 pcf
 Cohesion': 225 psf
 Phi': 40 °
 Phi-Anisotropic Strength Fn.: TQs 150-17° (A-Bed6°-7°)
 C-Anisotropic Strength Fn.: 150psf-17° (A-Bed6°-7°)
 Phi-B: 0 °

Shear Layer

Model: Mohr-Coulomb
 Unit Weight: 120 pcf
 Cohesion': 150 psf
 Phi': 11 °
 Phi-B: 0 °

Fill

Model: Mohr-Coulomb
 Unit Weight: 120 pcf
 Cohesion': 200 psf
 Phi': 33 °
 Phi-B: 0 °

Tmc 100-25° (A-Bed0°-5°)

Model: Anisotropic Fn.
 Unit Weight: 120 pcf
 Cohesion': 200 psf
 Phi': 40 °
 Phi-Anisotropic Strength Fn.: Tmc 100psf-25° (A-Bed0°-5°)
 C-Anisotropic Strength Fn.: 100 psf (A-Bed0°-5°)
 Phi-B: 0 °

Tmc 150-17° (A-Bed0°-5°)

Model: Anisotropic Fn.
 Unit Weight: 120 pcf
 Cohesion': 200 psf
 Phi': 40 °
 Phi-Anisotropic Strength Fn.: Tmc 150-17° (A-Bed0°-5°)
 C-Anisotropic Strength Fn.: 150psf-17° (A-Bed0°-5°)
 Phi-B: 0 °

TQs 100-25° (A-Bed 6°-13°)

Model: [Anisotropic Fn.](#)
 Unit Weight: 120 pcf
 Cohesion: 225 psf
 Phi: 40 °
 Phi-Anisotropic Strength Fn.: TQs 100-25° (A-Bed 6°-13°)
 C-Anisotropic Strength Fn.: 100psf-25° (A-Bed 6°-13°)
 Phi-B: 0 °

Slip Surface Entry and Exit

Left Projection: [Range](#)
 Left-Zone Left Coordinate: (-143, 1,955.5472) ft
 Left-Zone Right Coordinate: (117, 2,000) ft
 Left-Zone Increment: 50
 Right Projection: [Range](#)
 Right-Zone Left Coordinate: (144, 2,007.5862) ft
 Right-Zone Right Coordinate: (446.0769, 2,094.1331) ft
 Right-Zone Increment: 50
 Radius Increments: 50

Slip Surface Limits

Left Coordinate: (-201, 1,955) ft
 Right Coordinate: (810, 2,090) ft

Seismic Coefficients

Horz Seismic Coef.: 0
 Vert Seismic Coef.: 0

Anisotropic Strength Functions**150psf-17° (A-Bed6°-7°)**

Model: [Spline Data Point Function](#)
 Function: [Modifier Factor vs. Inclination](#)
 Curve Fit to Data: 100 %
 Segment Curvature: 0 %
 Y-Intercept: 1
 Data Points: [Inclination \(°\), Modifier Factor](#)
 Data Point: (-90, 1)
 Data Point: (5.9, 1)
 Data Point: (6, 0.75)
 Data Point: (7, 0.75)
 Data Point: (7.1, 1)

TQs 150-17° (A-Bed6°-7°)

Model: [Spline Data Point Function](#)
 Function: [Modifier Factor vs. Inclination](#)
 Curve Fit to Data: 100 %
 Segment Curvature: 0 %
 Y-Intercept: 1
 Data Points: [Inclination \(°\), Modifier Factor](#)
 Data Point: (-90, 1)
 Data Point: (5.9, 1)
 Data Point: (6, 0.425)
 Data Point: (7, 0.425)
 Data Point: (7.1, 1)

TQs 100-25° (A-Bed 6°-13°)

Model: [Spline Data Point Function](#)
 Function: [Modifier Factor vs. Inclination](#)
 Curve Fit to Data: 100 %
 Segment Curvature: 0 %
 Y-Intercept: 1
 Data Points: [Inclination \(°\), Modifier Factor](#)
 Data Point: (-90, 1)
 Data Point: (5.9, 1)
 Data Point: (6, 0.625)
 Data Point: (13, 0.625)
 Data Point: (13.1, 1)

100 psf (A-Bed0°-5°)

Model: [Spline Data Point Function](#)
 Function: [Modifier Factor vs. Inclination](#)
 Curve Fit to Data: 100 %
 Segment Curvature: 0 %
 Y-Intercept: 0.5
 Data Points: [Inclination \(°\), Modifier Factor](#)
 Data Point: (-90, 1)
 Data Point: (-0.9, 1)
 Data Point: (0, 0.5)
 Data Point: (5, 0.5)
 Data Point: (5.1, 1)

Tmc 100psf-25° (A-Bed0°-5°)

Model: [Spline Data Point Function](#)
 Function: [Modifier Factor vs. Inclination](#)
 Curve Fit to Data: 100 %
 Segment Curvature: 0 %
 Y-Intercept: 0.625
 Data Points: [Inclination \(°\), Modifier Factor](#)
 Data Point: (-90, 1)
 Data Point: (-0.9, 1)
 Data Point: (0, 0.625)
 Data Point: (5, 0.625)
 Data Point: (5.1, 1)

150psf-17° (A-Bed0°-5°)

Model: Spline Data Point Function
 Function: Modifier Factor vs. Inclination
 Curve Fit to Data: 100 %
 Segment Curvature: 0 %
 Y-Intercept: 0.75
 Data Points: Inclination (°), Modifier Factor
 Data Point: (-90, 1)
 Data Point: (-0.9, 1)
 Data Point: (0, 0.75)
 Data Point: (5, 0.75)
 Data Point: (5.1, 1)

Tmc 150-17° (A-Bed0°-5°)

Model: Spline Data Point Function
 Function: Modifier Factor vs. Inclination
 Curve Fit to Data: 100 %
 Segment Curvature: 0 %
 Y-Intercept: 0.425
 Data Points: Inclination (°), Modifier Factor
 Data Point: (-90, 1)
 Data Point: (-0.9, 1)
 Data Point: (0, 0.425)
 Data Point: (5, 0.425)
 Data Point: (5.1, 1)

100psf-25° (A-Bed 6°-13°)

Model: Spline Data Point Function
 Function: Modifier Factor vs. Inclination
 Curve Fit to Data: 100 %
 Segment Curvature: 0 %
 Y-Intercept: 1
 Data Points: Inclination (°), Modifier Factor
 Data Point: (-90, 1)
 Data Point: (5.9, 1)
 Data Point: (6, 0.444)
 Data Point: (13, 0.444)
 Data Point: (13.1, 1)

Points

	X (ft)	Y (ft)
Point 1	59	1,960
Point 2	11	1,957
Point 3	31	1,968
Point 4	45	1,976
Point 5	69	1,976
Point 6	125	2,004
Point 7	136	2,004

Point 8	194	2,030
Point 9	205	2,030
Point 10	259	2,057
Point 11	333	2,057
Point 12	550	2,091
Point 13	603	2,090
Point 14	715	2,088
Point 15	810	2,090
Point 16	810	2,016
Point 17	642	2,006
Point 18	466	1,993
Point 19	312	1,983
Point 20	-201	1,955
Point 21	810	1,803
Point 22	-200	1,803
Point 23	-200.75	1,920
Point 24	810	1,990
Point 25	810	2,087
Point 26	810	2,085
Point 27	654	2,089.0893
Point 28	629	2,089
Point 29	88	1,956
Point 30	138	1,956
Point 31	358	2,067

Point 32	82.1967	1,962.1088
Point 33	167	1,970
Point 34	271	2,023
Point 35	273	2,024
Point 36	414	2,095
Point 37	316	2,045.9574
Point 38	356	2,046
Point 39	451	2,094
Point 40	374	2,055
Point 41	380	2,058

Regions

	Material	Points	Area (ft ²)
Region 1	Tmc 100-25° (A-Bed0°-5°)	20,23,24,16,17,18,19,33,30,29,32,1,2	26,270
Region 2	Tmc 150-17° (A-Bed0°-5°)	23,22,21,24	1.5359e+005
Region 3	TQs 150-17° (A-Bed6°-7°)	19,18,17,16,26,34,33	32,238
Region 4	Shear Layer	26,25,35,34	744.5
Region 5	TQs 150-17° (A-Bed6°-7°)	15,14,27,40,38,37,35,25	8,477.5
Region 6	TQs 150-17° (A-Bed6°-7°)	13,12,39,41,28	3,375.5
Region 7	Shear Layer	27,28,41,40	694.11
Region 8	TQs 100-25° (A-Bed 6°-13°)	2,1,32,5,4,3	769.03
Region 9	Fill	5,32,29,30,33,34,35,37,31,11,10,9,8,7,6	9,276.8
Region 10	Fill	37,38,40,41,39,36,31	1,921.5

Current Slip Surface

Slip Surface: 73,962
 F of S: 1.95
 Volume: 4,985.6137 ft³
 Weight: 598,273.65 lbs
 Resisting Moment: 1.7198055e+008 lbs-ft
 Activating Moment: 88,332,379 lbs-ft
 F of S Rank (Analysis): 1 of 132,651 slip surfaces
 F of S Rank (Query): 1 of 300 slip surfaces
 Exit: (11.062112, 1,957.0342) ft
 Entry: (274.42074, 2,057) ft

Radius: 425.87562 ft
 Center: (0.11326597, 2,382.769) ft

Slip Slices

	X (ft)	Y (ft)	PWP (psf)	Base Normal Stress (psf)	Frictional Strength (psf)	Cohesive Strength (psf)
Slice 1	11.485152	1,957.0455	0	23.214728	19.47947	225
Slice 2	16.681144	1,957.2426	0	340.67392	158.85886	100
Slice 3	26.227048	1,957.7217	0	901.97821	420.59934	100
Slice 4	36.208551	1,958.458	0	1,467.9654	684.52352	100
Slice 5	43.208551	1,959.0833	0	1,815.9215	1,523.7391	225
Slice 6	49	1,959.7277	0	1,894.3848	883.36615	99.9
Slice 7	57	1,960.7291	0	1,768.574	824.69962	99.9
Slice 8	65	1,961.885	0	1,625.9435	758.18992	99.9
Slice 9	74.487111	1,963.4749	0	1,748.9389	815.54359	99.9
Slice 10	84.476799	1,965.3583	0	2,047.0582	1,329.3752	200
Slice 11	93.481955	1,967.2801	0	2,318.6769	1,505.7664	200
Slice 12	102.48711	1,969.407	0	2,563.4837	1,664.7458	200
Slice 13	111.49227	1,971.7423	0	2,781.578	1,806.3779	200
Slice 14	120.49742	1,974.2893	0	2,973.0171	1,930.6999	200
Slice 15	130.5	1,977.3853	0	2,854.8839	1,853.9833	200
Slice 16	140.14286	1,980.5968	0	2,684.1928	1,743.1352	200
Slice 17	148.42857	1,983.5785	0	2,741.7028	1,780.4826	200
Slice 18	156.71429	1,986.756	0	2,777.1612	1,803.5096	200
Slice 19	165	1,990.134	0	2,790.4633	1,812.148	200
Slice 20	173.28571	1,993.7179	0	2,781.4751	1,806.311	200
Slice 21	181.57143	1,997.5132	0	2,750.0323	1,785.8919	200

Slice 22	189.85714	2,001.5265	0	2,695.9395	1,750.7636	200
Slice 23	199.5	2,006.5028	0	2,350.3947	1,526.3642	200
Slice 24	209.5	2,011.9584	0	2,000.7209	1,299.2834	200
Slice 25	218.5	2,017.1876	0	1,906.7696	1,238.2706	200
Slice 26	227.5	2,022.7176	0	1,783.8154	1,158.4232	200
Slice 27	236.5	2,028.5627	0	1,631.3352	1,059.4015	200
Slice 28	245.5	2,034.7387	0	1,448.7448	940.82588	200
Slice 29	254.5	2,041.2636	0	1,235.3954	802.27518	200
Slice 30	262.85519	2,047.6381	0	827.0096	537.06631	200
Slice 31	270.56556	2,053.8303	0	232.37144	150.90378	200

Section 19 SSA for Skyline Ranch.gsz

Section 19 SSA for Skyline Ranch.gsz Run By: Dr. Alexander Bykovtsev, Ph.D., P.E. 3/25/2016 3:10:06 PM

- Materials**
- TQs 150-17° (A-Bed6°-7°)
 - Shear Layer
 - Fill
 - Tmc 100-25° (A-Bed0°-5°)
 - Tmc 150-17° (A-Bed0°-5°)
 - TQs 100-25° (A-Bed 6°-13°)

Lower Keyway depth 20'
width 50', backcut slope 2H:1V
Upper Keyway depth 10'
Width 25', Backcut Slope 2H:1V

Current Analysis 1 - Circular Mode of Failure Seismic

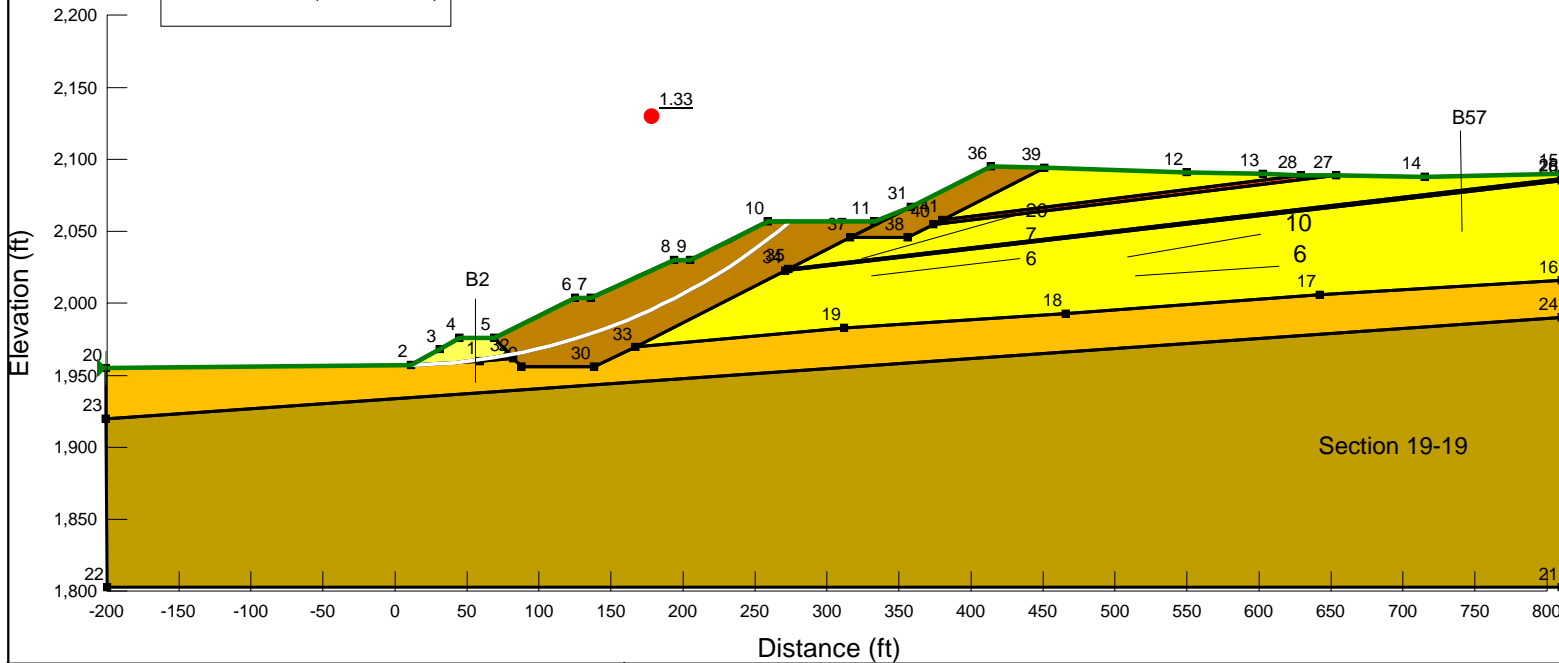

Name: TQs 150-17° (A-Bed6°-7°)
Model: Anisotropic Fn.
Unit Weight: 120 pcf
Cohesion: 225 psf
Phi: 40°
Phi-Anisotropic Strength Fn.: TQs 150-17° (A-Bed6°-7°)
C-Anisotropic Strength Fn.: 150psf-17° (A-Bed6°-7°)

Name: Shear Layer
Model: Mohr-Coulomb
Unit Weight: 120 pcf
Cohesion: 150 psf
Phi: 11°

Name: Fill
Model: Mohr-Coulomb
Unit Weight: 120 pcf
Cohesion: 200 psf
Phi: 33°

Name: Tmc 100-25° (A-Bed0°-5°)
Model: Anisotropic Fn.
Unit Weight: 120 pcf
Cohesion: 200 psf
Phi: 40°
Phi-Anisotropic Strength Fn.: Tmc 100psf-25° (A-Bed0°-5°)
C-Anisotropic Strength Fn.: 100 psf (A-Bed0°-5°)

Name: Tmc 150-17° (A-Bed0°-5°)
Model: Anisotropic Fn.
Unit Weight: 120 pcf
Cohesion: 200 psf
Phi: 40°
Phi-Anisotropic Strength Fn.: Tmc 150-17° (A-Bed0°-5°)
C-Anisotropic Strength Fn.: 150psf-17° (A-Bed0°-5°)

Name: TQs 100-25° (A-Bed 6°-13°)
Model: Anisotropic Fn.
Unit Weight: 120 pcf
Cohesion: 225 psf
Phi: 40°
Phi-Anisotropic Strength Fn.: TQs 100-25° (A-Bed 6°-13°)
C-Anisotropic Strength Fn.: 100psf-25° (A-Bed 6°-13°)

LGC **LGC Valley, Inc**
GEOTECHNICAL CONSULTING
28532 Constellation Road, Valencia, CA 91355
Phone 661-702-8474, Fax 661-702-8475

Skyline Ranch
Development project, Tract 60922
Los Angeles CA

Project No: **153035-01**
Engineer: **BAS**
Date: **March 2016**

1 - Circular Mode of Failure Seismic

Report generated using GeoStudio 2012. Copyright © 1991-2015 GEO-SLOPE International Ltd.

File Information

File Version: 8.15
 Title: Static Slope Stability Analyses for Skyline Ranch Development project, Tract 60922, Los Angeles CA
 Comments: Run By: Dr. Alexander Bykovtsev, Ph.D., P.E.
 Last Edited By: Alexander Bykovtsev
 Revision Number: 161
 Date: 3/25/2016
 Time: 3:10:06 PM
 Tool Version: 8.15.1.11777
 File Name: Section 19 SSA for Skyline Ranch.gsz
 Directory: G:\SLOPE RESULTS\Section 19-19 results\Latest Update 3-25-16\
 Last Solved Date: 3/25/2016
 Last Solved Time: 3:14:40 PM

Project Settings

Length(L) Units: Feet
 Time(t) Units: Seconds
 Force(F) Units: Pounds
 Pressure(p) Units: psf
 Strength Units: psf
 Unit Weight of Water: 62.4 pcf
 View: 2D
 Element Thickness: 1

Analysis Settings

1 - Circular Mode of Failure Seismic

Kind: SLOPE/W
 Parent: 1 - Circular Mode of Failure
 Method: Bishop
 Settings
 PWP Conditions Source: (none)
 Initial Slip Surface Source: Parent Analysis
 Slip Surface
 Direction of movement: Right to Left
 Use Passive Mode: No
 Slip Surface Option: Critical Slip Surfaces from Other
 Critical slip surfaces saved: 1
 Resisting Side Maximum Convex Angle: 1 °
 Driving Side Maximum Convex Angle: 5 °
 Optimize Critical Slip Surface Location: No

file:///G:/SLOPE%20RESULTS/Section%2019-19%20results/Latest%20Update%203-25-... 3/25/2016

Tension Crack
 Tension Crack Option: (none)
 F of S Distribution
 F of S Calculation Option: Constant
 Advanced
 Number of Slices: 30
 F of S Tolerance: 0.01
 Minimum Slip Surface Depth: 0.1 ft

Materials

TQs 150-17° (A-Bed6°-7°)

Model: Anisotropic Fn.
 Unit Weight: 120 pcf
 Cohesion': 225 psf
 Phi': 40 °
 Phi-Anisotropic Strength Fn.: TQs 150-17° (A-Bed6°-7°)
 C-Anisotropic Strength Fn.: 150psf-17° (A-Bed6°-7°)
 Phi-B: 0 °

Shear Layer

Model: Mohr-Coulomb
 Unit Weight: 120 pcf
 Cohesion': 150 psf
 Phi': 11 °
 Phi-B: 0 °

Fill

Model: Mohr-Coulomb
 Unit Weight: 120 pcf
 Cohesion': 200 psf
 Phi': 33 °
 Phi-B: 0 °

Tmc 100-25° (A-Bed0°-5°)

Model: Anisotropic Fn.
 Unit Weight: 120 pcf
 Cohesion': 200 psf
 Phi': 40 °
 Phi-Anisotropic Strength Fn.: Tmc 100psf-25° (A-Bed0°-5°)
 C-Anisotropic Strength Fn.: 100 psf (A-Bed0°-5°)
 Phi-B: 0 °

Tmc 150-17° (A-Bed0°-5°)

Model: Anisotropic Fn.
 Unit Weight: 120 pcf
 Cohesion': 200 psf
 Phi': 40 °
 Phi-Anisotropic Strength Fn.: Tmc 150-17° (A-Bed0°-5°)

file:///G:/SLOPE%20RESULTS/Section%2019-19%20results/Latest%20Update%203-25-... 3/25/2016

C-Anisotropic Strength Fn.: 150psf-17° (A-Bed0°-5°)
Phi-B: 0°

TQs 100-25° (A-Bed 6°-13°)

Model: Anisotropic Fn.
Unit Weight: 120 pcf
Cohesion: 225 psf
Phi: 40°
Phi-Anisotropic Strength Fn.: TQs 100-25° (A-Bed 6°-13°)
C-Anisotropic Strength Fn.: 100psf-25° (A-Bed 6°-13°)
Phi-B: 0°

Slip Surface Limits

Left Coordinate: (-201, 1,955) ft
Right Coordinate: (810, 2,090) ft

Seismic Coefficients

Horz Seismic Coef.: 0.15
Vert Seismic Coef.: 0

Anisotropic Strength Functions

150psf-17° (A-Bed6°-7°)

Model: Spline Data Point Function
Function: Modifier Factor vs. Inclination
Curve Fit to Data: 100 %
Segment Curvature: 0 %
Y-Intercept: 1
Data Points: Inclination (°), Modifier Factor
Data Point: (-90, 1)
Data Point: (5.9, 1)
Data Point: (6, 0.75)
Data Point: (7, 0.75)
Data Point: (7.1, 1)

TQs 150-17° (A-Bed6°-7°)

Model: Spline Data Point Function
Function: Modifier Factor vs. Inclination
Curve Fit to Data: 100 %
Segment Curvature: 0 %
Y-Intercept: 1
Data Points: Inclination (°), Modifier Factor
Data Point: (-90, 1)
Data Point: (5.9, 1)
Data Point: (6, 0.425)
Data Point: (7, 0.425)

Data Point: (7.1, 1)

TQs 100-25° (A-Bed 6°-13°)

Model: Spline Data Point Function
Function: Modifier Factor vs. Inclination
Curve Fit to Data: 100 %
Segment Curvature: 0 %
Y-Intercept: 1
Data Points: Inclination (°), Modifier Factor
Data Point: (-90, 1)
Data Point: (5.9, 1)
Data Point: (6, 0.625)
Data Point: (13, 0.625)
Data Point: (13.1, 1)

100 psf (A-Bed0°-5°)

Model: Spline Data Point Function
Function: Modifier Factor vs. Inclination
Curve Fit to Data: 100 %
Segment Curvature: 0 %
Y-Intercept: 0.5
Data Points: Inclination (°), Modifier Factor
Data Point: (-90, 1)
Data Point: (-0.9, 1)
Data Point: (0, 0.5)
Data Point: (5, 0.5)
Data Point: (5.1, 1)

Tmc 100psf-25° (A-Bed0°-5°)

Model: Spline Data Point Function
Function: Modifier Factor vs. Inclination
Curve Fit to Data: 100 %
Segment Curvature: 0 %
Y-Intercept: 0.625
Data Points: Inclination (°), Modifier Factor
Data Point: (-90, 1)
Data Point: (-0.9, 1)
Data Point: (0, 0.625)
Data Point: (5, 0.625)
Data Point: (5.1, 1)

150psf-17° (A-Bed0°-5°)

Model: Spline Data Point Function
Function: Modifier Factor vs. Inclination
Curve Fit to Data: 100 %
Segment Curvature: 0 %
Y-Intercept: 0.75
Data Points: Inclination (°), Modifier Factor
Data Point: (-90, 1)
Data Point: (-0.9, 1)

Data Point: (0, 0.75)
 Data Point: (5, 0.75)
 Data Point: (5.1, 1)

Tmc 150-17° (A-Bed0°-5°)

Model: Spline Data Point Function
 Function: Modifier Factor vs. Inclination
 Curve Fit to Data: 100 %
 Segment Curvature: 0 %

Y-Intercept: 0.425

Data Points: Inclination (°), Modifier Factor
 Data Point: (-90, 1)
 Data Point: (-0.9, 1)
 Data Point: (0, 0.425)
 Data Point: (5, 0.425)
 Data Point: (5.1, 1)

100psf-25° (A-Bed 6°-13°)

Model: Spline Data Point Function
 Function: Modifier Factor vs. Inclination
 Curve Fit to Data: 100 %
 Segment Curvature: 0 %

Y-Intercept: 1

Data Points: Inclination (°), Modifier Factor
 Data Point: (-90, 1)
 Data Point: (5.9, 1)
 Data Point: (6, 0.444)
 Data Point: (13, 0.444)
 Data Point: (13.1, 1)

Points

	X (ft)	Y (ft)
Point 1	59	1,960
Point 2	11	1,957
Point 3	31	1,968
Point 4	45	1,976
Point 5	69	1,976
Point 6	125	2,004
Point 7	136	2,004
Point 8	194	2,030
Point 9	205	2,030
Point 10	259	2,057
Point 11	333	2,057
Point 12	550	2,091
Point 13	603	2,090
Point 14	715	2,088
Point 15	810	2,090

Point 16	810	2,016
Point 17	642	2,006
Point 18	466	1,993
Point 19	312	1,983
Point 20	-201	1,955
Point 21	810	1,803
Point 22	-200	1,803
Point 23	-200.75	1,920
Point 24	810	1,990
Point 25	810	2,087
Point 26	810	2,085
Point 27	654	2,089.0893
Point 28	629	2,089
Point 29	88	1,956
Point 30	138	1,956
Point 31	358	2,067
Point 32	82.1967	1,962.1088
Point 33	167	1,970
Point 34	271	2,023
Point 35	273	2,024
Point 36	414	2,095
Point 37	316	2,045.9574
Point 38	356	2,046
Point 39	451	2,094

Point 40	374	2,055
Point 41	380	2,058

Regions

	Material	Points	Area (ft ²)
Region 1	Tmc 100-25° (A-Bed0°-5°)	20,23,24,16,17,18,19,33,30,29,32,1,2	26,270
Region 2	Tmc 150-17° (A-Bed0°-5°)	23,22,21,24	1.5359e+005
Region 3	TQs 150-17° (A-Bed6°-7°)	19,18,17,16,26,34,33	32,238
Region 4	Shear Layer	26,25,35,34	744.5
Region 5	TQs 150-17° (A-Bed6°-7°)	15,14,27,40,38,37,35,25	8,477.5
Region 6	TQs 150-17° (A-Bed6°-7°)	13,12,39,41,28	3,375.5
Region 7	Shear Layer	27,28,41,40	694.11
Region 8	TQs 100-25° (A-Bed 6°-13°)	2,1,32,5,4,3	769.03
Region 9	Fill	5,32,29,30,33,34,35,37,31,11,10,9,8,7,6	9,276.8
Region 10	Fill	37,38,40,41,39,36,31	1,921.5

Current Slip Surface

Slip Surface: 1
 F of S: 1.33
 Volume: 4,985.6138 ft³
 Weight: 598,273.65 lbs
 Resisting Moment: 1.635034e+008 lbs-ft
 Activating Moment: 1.2270073e+008 lbs-ft
 F of S Rank (Analysis): 1 of 1 slip surfaces
 F of S Rank (Query): 1 of 1 slip surfaces
 Exit: (11.062112, 1,957.0342) ft
 Entry: (274.42074, 2,057) ft
 Radius: 425.87562 ft
 Center: (0.11326597, 2,382.769) ft

Slip Slices

	X (ft)	Y (ft)	PWP (psf)	Base Normal Stress (psf)	Frictional Strength (psf)	Cohesive Strength (psf)
Slice 1	11.485152	1,957.0455	0	21.700369	18.208771	225
Slice 2	16.681144	1,957.2426	0	338.32928	157.76554	100
Slice 3	26.227048	1,957.7217	0	894.59485	417.15643	100
Slice 4	36.208551	1,958.458	0	1,452.6829	677.39714	100
Slice 5	43.208551	1,959.0833	0	1,776.4992	1,490.6599	225

Slice 6	49	1,959.7277	0	1,868.6313	871.35709	99.9
Slice 7	57	1,960.7291	0	1,740.5085	811.61246	99.9
Slice 8	65	1,961.885	0	1,596.3436	744.38722	99.9
Slice 9	74.487111	1,963.4749	0	1,712.8834	798.73067	99.9
Slice 10	84.476799	1,965.3583	0	1,980.6949	1,286.2783	200
Slice 11	93.481955	1,967.2801	0	2,237.1954	1,452.8517	200
Slice 12	102.48711	1,969.407	0	2,466.2917	1,601.6286	200
Slice 13	111.49227	1,971.7423	0	2,668.3053	1,732.8177	200
Slice 14	120.49742	1,974.2893	0	2,843.5097	1,846.5968	200
Slice 15	130.5	1,977.3853	0	2,720.1762	1,766.5031	200
Slice 16	140.14286	1,980.5968	0	2,547.7601	1,654.5347	200
Slice 17	148.42857	1,983.5785	0	2,594.7472	1,685.0485	200
Slice 18	156.71429	1,986.756	0	2,620.4747	1,701.7561	200
Slice 19	165	1,990.134	0	2,625.0033	1,704.697	200
Slice 20	173.28571	1,993.7179	0	2,608.3675	1,693.8937	200
Slice 21	181.57143	1,997.5132	0	2,570.5769	1,669.3522	200
Slice 22	189.85714	2,001.5265	0	2,511.6151	1,631.0619	200
Slice 23	199.5	2,006.5028	0	2,178.8795	1,414.9809	200
Slice 24	209.5	2,011.9584	0	1,844.0994	1,197.5722	200
Slice 25	218.5	2,017.1876	0	1,749.7803	1,136.3206	200
Slice 26	227.5	2,022.7176	0	1,629.0525	1,057.9191	200
Slice 27	236.5	2,028.5627	0	1,481.7076	962.23216	200
Slice 28	245.5	2,034.7387	0	1,307.5028	849.10223	200
Slice 29	254.5	2,041.2636	0	1,106.1616	718.34975	200

Slice 30	262.85519	2,047.6381	0	728.36017	473.00262	200
Slice 31	270.56556	2,053.8303	0	183.77153	119.34263	200

Section 19 SSA for Skyline Ranch.gsz

Section 19 SSA for Skyline Ranch.gsz Run By: Dr. Alexander Bykovtsev, Ph.D., P.E. 3/25/2016 3:10:06 PM

- Materials**
- TQs 150-17° (A-Bed6°-7°)
 - Shear Layer
 - Fill
 - Tmc 100-25° (A-Bed0°-5°)
 - Tmc 150-17° (A-Bed0°-5°)
 - TQs 100-25° (A-Bed 6°-13°)

Lower Keyway depth 20'
width 50', backcut slope 2H:1V
Upper Keyway depth 10'
Width 25', Backcut Slope 2H:1V

Current Analysis

2 - Translational Below Key

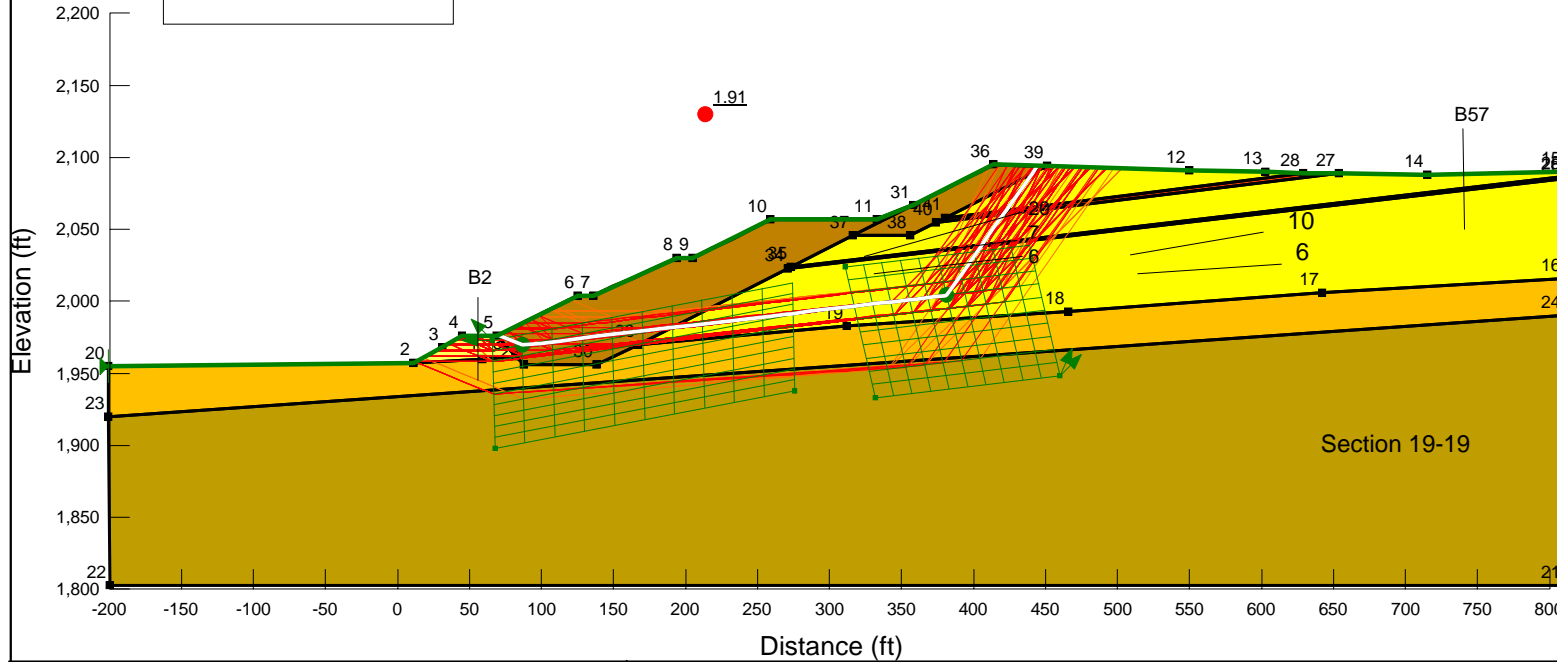

Name: TQs 150-17° (A-Bed6°-7°)
Model: Anisotropic Fn.
Unit Weight: 120 pcf
Cohesion: 225 psf
Phi: 40 °
Phi-Anisotropic Strength Fn.: TQs 150-17° (A-Bed6°-7°)
C-Anisotropic Strength Fn.: 150psf-17° (A-Bed6°-7°)

Name: Shear Layer
Model: Mohr-Coulomb
Unit Weight: 120 pcf
Cohesion: 150 psf
Phi: 11 °

Name: Fill
Model: Mohr-Coulomb
Unit Weight: 120 pcf
Cohesion: 200 psf
Phi: 33 °

Name: Tmc 100-25° (A-Bed0°-5°)
Model: Anisotropic Fn.
Unit Weight: 120 pcf
Cohesion: 200 psf
Phi: 40 °
Phi-Anisotropic Strength Fn.: Tmc 100psf-25° (A-Bed0°-5°)
C-Anisotropic Strength Fn.: 100 psf (A-Bed0°-5°)

Name: Tmc 150-17° (A-Bed0°-5°)
Model: Anisotropic Fn.
Unit Weight: 120 pcf
Cohesion: 200 psf
Phi: 40 °
Phi-Anisotropic Strength Fn.: Tmc 150-17° (A-Bed0°-5°)
C-Anisotropic Strength Fn.: 150psf-17° (A-Bed0°-5°)

Name: TQs 100-25° (A-Bed 6°-13°)
Model: Anisotropic Fn.
Unit Weight: 120 pcf
Cohesion: 225 psf
Phi: 40 °
Phi-Anisotropic Strength Fn.: TQs 100-25° (A-Bed 6°-13°)
C-Anisotropic Strength Fn.: 100psf-25° (A-Bed 6°-13°)



LGC Valley, Inc
GEOTECHNICAL CONSULTING
28532 Constellation Road, Valencia, CA 91355
Phone 661-702-8474, Fax 661-702-8475

Skyline Ranch
Development project, Tract 60922
Los Angeles CA

Project No: **153035-01**
Engineer: **BAS**
Date: **March 2016**

2 - Translational Below Key

Report generated using GeoStudio 2012. Copyright © 1991-2015 GEO-SLOPE International Ltd.

File Information

File Version: 8.15
 Title: Static Slope Stability Analyses for Skyline Ranch Development project, Tract 60922, Los Angeles CA
 Comments: Run By: Dr. Alexander Bykovtsev, Ph.D., P.E.
 Last Edited By: Alexander Bykovtsev
 Revision Number: 161
 Date: 3/25/2016
 Time: 3:10:06 PM
 Tool Version: 8.15.1.11777
 File Name: Section 19 SSA for Skyline Ranch.gsz
 Directory: G:\SLOPE RESULTS\Section 19-19 results\Latest Update 3-25-16\
 Last Solved Date: 3/25/2016
 Last Solved Time: 3:14:40 PM

Project Settings

Length(L) Units: Feet
 Time(t) Units: Seconds
 Force(F) Units: Pounds
 Pressure(p) Units: psf
 Strength Units: psf
 Unit Weight of Water: 62.4 pcf
 View: 2D
 Element Thickness: 1

Analysis Settings

2 - Translational Below Key

Kind: **SLOPE/W**
 Method: **Janbu**
 Settings
 PWP Conditions Source: **(none)**
 Slip Surface
 Direction of movement: **Right to Left**
 Use Passive Mode: **No**
 Slip Surface Option: **Block**
 Critical slip surfaces saved: **1**
 Resisting Side Maximum Convex Angle: **1 °**
 Driving Side Maximum Convex Angle: **5 °**
 Restrict Block Crossing: **No**
 Optimize Critical Slip Surface Location: **No**
 Tension Crack

Tension Crack Option: **(none)**
 F of S Distribution
 F of S Calculation Option: **Constant**
 Advanced
 Number of Slices: **30**
 F of S Tolerance: **0.01**
 Minimum Slip Surface Depth: **0.1 ft**

Materials

TQs 150-17° (A-Bed6°-7°)

Model: **Anisotropic Fn.**
 Unit Weight: **120 pcf**
 Cohesion': **225 psf**
 Phi': **40 °**
 Phi-Anisotropic Strength Fn.: **TQs 150-17° (A-Bed6°-7°)**
 C-Anisotropic Strength Fn.: **150psf-17° (A-Bed6°-7°)**
 Phi-B: **0 °**

Shear Layer

Model: **Mohr-Coulomb**
 Unit Weight: **120 pcf**
 Cohesion': **150 psf**
 Phi': **11 °**
 Phi-B: **0 °**

Fill

Model: **Mohr-Coulomb**
 Unit Weight: **120 pcf**
 Cohesion': **200 psf**
 Phi': **33 °**
 Phi-B: **0 °**

Tmc 100-25° (A-Bed0°-5°)

Model: **Anisotropic Fn.**
 Unit Weight: **120 pcf**
 Cohesion': **200 psf**
 Phi': **40 °**
 Phi-Anisotropic Strength Fn.: **Tmc 100psf-25° (A-Bed0°-5°)**
 C-Anisotropic Strength Fn.: **100 psf (A-Bed0°-5°)**
 Phi-B: **0 °**

Tmc 150-17° (A-Bed0°-5°)

Model: **Anisotropic Fn.**
 Unit Weight: **120 pcf**
 Cohesion': **200 psf**
 Phi': **40 °**
 Phi-Anisotropic Strength Fn.: **Tmc 150-17° (A-Bed0°-5°)**
 C-Anisotropic Strength Fn.: **150psf-17° (A-Bed0°-5°)**

Phi-B: 0 °

TQs 100-25° (A-Bed 6°-13°)

Model: Anisotropic Fn.
 Unit Weight: 120 pcf
 Cohesion: 225 psf
 Phi: 40 °
 Phi-Anisotropic Strength Fn.: TQs 100-25° (A-Bed 6°-13°)
 C-Anisotropic Strength Fn.: 100psf-25° (A-Bed 6°-13°)
 Phi-B: 0 °

Slip Surface Limits

Left Coordinate: (-201, 1,955) ft
 Right Coordinate: (810, 2,090) ft

Slip Surface Block

Left Grid
 Upper Left: (66, 1,973) ft
 Lower Left: (68, 1,898) ft
 Lower Right: (276, 1,938) ft
 X Increments: 10
 Y Increments: 10
 Starting Angle: 135 °
 Ending Angle: 180 °
 Angle Increments: 2
 Right Grid
 Upper Left: (311, 2,024) ft
 Lower Left: (332, 1,933) ft
 Lower Right: (460, 1,948) ft
 X Increments: 10
 Y Increments: 10
 Starting Angle: 45 °
 Ending Angle: 65 °
 Angle Increments: 2

Seismic Coefficients

Horz Seismic Coef.: 0
 Vert Seismic Coef.: 0

Anisotropic Strength Functions

150psf-17° (A-Bed6°-7°)

Model: Spline Data Point Function
 Function: Modifier Factor vs. Inclination
 Curve Fit to Data: 100 %

Segment Curvature: 0 %
 Y-Intercept: 1
 Data Points: Inclination (°), Modifier Factor
 Data Point: (-90, 1)
 Data Point: (5.9, 1)
 Data Point: (6, 0.75)
 Data Point: (7, 0.75)
 Data Point: (7.1, 1)

TQs 150-17° (A-Bed6°-7°)

Model: Spline Data Point Function
 Function: Modifier Factor vs. Inclination
 Curve Fit to Data: 100 %
 Segment Curvature: 0 %
 Y-Intercept: 1
 Data Points: Inclination (°), Modifier Factor
 Data Point: (-90, 1)
 Data Point: (5.9, 1)
 Data Point: (6, 0.425)
 Data Point: (7, 0.425)
 Data Point: (7.1, 1)

TQs 100-25° (A-Bed 6°-13°)

Model: Spline Data Point Function
 Function: Modifier Factor vs. Inclination
 Curve Fit to Data: 100 %
 Segment Curvature: 0 %
 Y-Intercept: 1
 Data Points: Inclination (°), Modifier Factor
 Data Point: (-90, 1)
 Data Point: (5.9, 1)
 Data Point: (6, 0.625)
 Data Point: (13, 0.625)
 Data Point: (13.1, 1)

100 psf (A-Bed0°-5°)

Model: Spline Data Point Function
 Function: Modifier Factor vs. Inclination
 Curve Fit to Data: 100 %
 Segment Curvature: 0 %
 Y-Intercept: 0.5
 Data Points: Inclination (°), Modifier Factor
 Data Point: (-90, 1)
 Data Point: (-0.9, 1)
 Data Point: (0, 0.5)
 Data Point: (5, 0.5)
 Data Point: (5.1, 1)

Tmc 100psf-25° (A-Bed0°-5°)

Model: Spline Data Point Function

Function: **Modifier Factor vs. Inclination**

Curve Fit to Data: 100 %

Segment Curvature: 0 %

Y-Intercept: 0.625

Data Points: **Inclination (°), Modifier Factor**

Data Point: (-90, 1)

Data Point: (-0.9, 1)

Data Point: (0, 0.625)

Data Point: (5, 0.625)

Data Point: (5.1, 1)

150psf-17° (A-Bed0°-5°)

Model: **Spline Data Point Function**

Function: **Modifier Factor vs. Inclination**

Curve Fit to Data: 100 %

Segment Curvature: 0 %

Y-Intercept: 0.75

Data Points: **Inclination (°), Modifier Factor**

Data Point: (-90, 1)

Data Point: (-0.9, 1)

Data Point: (0, 0.75)

Data Point: (5, 0.75)

Data Point: (5.1, 1)

Tmc 150-17° (A-Bed0°-5°)

Model: **Spline Data Point Function**

Function: **Modifier Factor vs. Inclination**

Curve Fit to Data: 100 %

Segment Curvature: 0 %

Y-Intercept: 0.425

Data Points: **Inclination (°), Modifier Factor**

Data Point: (-90, 1)

Data Point: (-0.9, 1)

Data Point: (0, 0.425)

Data Point: (5, 0.425)

Data Point: (5.1, 1)

100psf-25° (A-Bed 6°-13°)

Model: **Spline Data Point Function**

Function: **Modifier Factor vs. Inclination**

Curve Fit to Data: 100 %

Segment Curvature: 0 %

Y-Intercept: 1

Data Points: **Inclination (°), Modifier Factor**

Data Point: (-90, 1)

Data Point: (5.9, 1)

Data Point: (6, 0.444)

Data Point: (13, 0.444)

Data Point: (13.1, 1)

Points

	X (ft)	Y (ft)
Point 1	59	1,960
Point 2	11	1,957
Point 3	31	1,968
Point 4	45	1,976
Point 5	69	1,976
Point 6	125	2,004
Point 7	136	2,004
Point 8	194	2,030
Point 9	205	2,030
Point 10	259	2,057
Point 11	333	2,057
Point 12	550	2,091
Point 13	603	2,090
Point 14	715	2,088
Point 15	810	2,090
Point 16	810	2,016
Point 17	642	2,006
Point 18	466	1,993
Point 19	312	1,983
Point 20	-201	1,955
Point 21	810	1,803
Point 22	-200	1,803
Point 23	-200.75	1,920
Point 24	810	1,990
Point 25	810	2,087
Point 26	810	2,085
Point 27	654	2,089.0893
Point 28	629	2,089
Point 29	88	1,956
Point 30	138	1,956
Point 31	358	2,067
Point 32	82.1967	1,962.1088
Point 33	167	1,970
Point 34	271	2,023
Point 35	273	2,024
Point 36	414	2,095
Point 37	316	2,045.9574
Point 38	356	2,046
Point 39	451	2,094
Point 40	374	2,055
Point 41	380	2,058

Regions

	Material	Points	Area (ft²)
Region 1	Tmc 100-25° (A-Bed0°-5°)	20,23,24,16,17,18,19,33,30,29,32,1,2	26,270
Region 2	Tmc 150-17° (A-Bed0°-5°)	23,22,21,24	1.5359e+005
Region 3	TQs 150-17° (A-Bed6°-7°)	19,18,17,16,26,34,33	32,238
Region 4	Shear Layer	26,25,35,34	744.5
Region 5	TQs 150-17° (A-Bed6°-7°)	15,14,27,40,38,37,35,25	8,477.5
Region 6	TQs 150-17° (A-Bed6°-7°)	13,12,39,41,28	3,375.5
Region 7	Shear Layer	27,28,41,40	694.11
Region 8	TQs 100-25° (A-Bed 6°-13°)	2,1,32,5,4,3	769.03
Region 9	Fill	5,32,29,30,33,34,35,37,31,11,10,9,8,7,6	9,276.8
Region 10	Fill	37,38,40,41,39,36,31	1,921.5

Current Slip Surface

Slip Surface: 109,511
 F of S: 1.91
 Volume: 17,572.776 ft³
 Weight: 2,108,733.1 lbs
 Resisting Force: 892,277.22 lbs
 Activating Force: 466,878.37 lbs
 F of S Rank (Analysis): 1 of 131,769 slip surfaces
 F of S Rank (Query): 1 of 300 slip surfaces
 Exit: (70.045537, 1,976.5228) ft
 Entry: (444.30533, 2,094.1809) ft
 Radius: 190.20752 ft
 Center: (229.43379, 2,123.5955) ft

Slip Slices

	X (ft)	Y (ft)	PWP (psf)	Base Normal Stress (psf)	Frictional Strength (psf)	Cohesive Strength (psf)
Slice 1	78.522769	1,973.0114	0	1,132.4216	735.40318	200
Slice 2	93.333333	1,970.2467	0	2,055.832	1,335.0729	200
Slice 3	106	1,971.7402	0	2,614.2742	1,697.7295	200
Slice 4	118.66667	1,973.2337	0	3,172.7165	2,060.3862	200
Slice 5	130.5	1,974.629	0	3,377.1123	2,193.1224	200
Slice 6	142.72551	1,976.0704	0	3,558.6593	2,311.0204	200
Slice 7	156.17653	1,977.6564	0	4,071.4041	2,644.0007	200
Slice 8	169.62755	1,979.2424	0	4,584.1488	2,976.981	200

Slice 9	183.07857	1,980.8283	0	5,096.8935	3,309.9614	200
Slice 10	191.90204	1,981.8687	0	5,548.0244	1,696.2013	168.75
Slice 11	199.5	1,982.7645	0	5,553.279	1,697.8078	168.75
Slice 12	211.75	1,984.2089	0	5,780.6734	1,767.3292	168.75
Slice 13	225.25	1,985.8006	0	6,388.2225	1,953.0756	168.75
Slice 14	238.75	1,987.3924	0	6,995.7715	2,138.822	168.75
Slice 15	252.25	1,988.9841	0	7,603.3206	2,324.5684	168.75
Slice 16	265	1,990.4874	0	7,823.7713	2,391.9669	168.75
Slice 17	272	1,991.3128	0	7,726.5603	2,362.2465	168.75
Slice 18	280.16667	1,992.2757	0	7,613.1474	2,327.5727	168.75
Slice 19	294.5	1,993.9657	0	7,414.0962	2,266.7167	168.75
Slice 20	308.83333	1,995.6557	0	7,215.045	2,205.8606	168.75
Slice 21	324.5	1,997.5029	0	6,997.4774	2,139.3435	168.75
Slice 22	338.75	1,999.1831	0	7,070.4818	2,161.6632	168.75
Slice 23	350.25	2,000.539	0	7,452.5744	2,278.4807	168.75
Slice 24	357	2,001.3349	0	7,676.8462	2,347.0474	168.75
Slice 25	366	2,002.396	0	8,070.1007	2,467.2774	168.75
Slice 26	377	2,003.693	0	8,565.1407	2,618.6263	168.75
Slice 27	380.65	2,004.1234	0	8,729.4039	2,668.8466	168.75
Slice 28	387.2948	2,012.7615	0	4,980.3847	4,179.039	225
Slice 29	399.2844	2,029.8844	0	4,159.1546	3,489.9451	225
Slice 30	405.68846	2,039.0303	0	5,332.3913	1,036.5119	150
Slice 31	410.04886	2,045.2576	0	3,421.8405	2,871.2651	225
Slice 32	417.43289	2,055.8031	0	2,782.5531	2,334.8392	225

Slice 33	421.77934	2,062.0105	0	3,337.5479	648.75359	150
Slice 34	431.55828	2,075.9763	0	1,265.6468	1,062.0038	225
Slice 35	442.3645	2,091.4091	0	127.77485	82.97796	200

Section 19 SSA for Skyline Ranch.gsz

Section 19 SSA for Skyline Ranch.gsz Run By: Dr. Alexander Bykovtsev, Ph.D., P.E. 3/25/2016 3:10:06 PM

Materials

- TQs 150-17° (A-Bed6°-7°)
- Shear Layer
- Fill
- Tmc 100-25° (A-Bed0°-5°)
- Tmc 150-17° (A-Bed0°-5°)
- TQs 100-25° (A-Bed 6°-13°)

Lower Keyway depth 20'
width 50', backcut slope 2H:1V
Upper Keyway depth 10'
Width 25', Backcut Slope 2H:1V

Current Analysis 2 - Translational Below Key Seismic

Name: TQs 150-17° (A-Bed6°-7°)
Model: Anisotropic Fn.
Unit Weight: 120 pcf
Cohesion: 225 psf
Phi: 40 °
Phi-Anisotropic Strength Fn.: TQs 150-17° (A-Bed6°-7°)
C-Anisotropic Strength Fn.: 150psf-17° (A-Bed6°-7°)

Name: Shear Layer
Model: Mohr-Coulomb
Unit Weight: 120 pcf
Cohesion: 150 psf
Phi: 11 °

Name: Fill
Model: Mohr-Coulomb
Unit Weight: 120 pcf
Cohesion: 200 psf
Phi: 33 °

Name: Tmc 100-25° (A-Bed0°-5°)
Model: Anisotropic Fn.
Unit Weight: 120 pcf
Cohesion: 200 psf
Phi: 40 °
Phi-Anisotropic Strength Fn.: Tmc 100psf-25° (A-Bed0°-5°)
C-Anisotropic Strength Fn.: 100 psf (A-Bed0°-5°)

Name: Tmc 150-17° (A-Bed0°-5°)
Model: Anisotropic Fn.
Unit Weight: 120 pcf
Cohesion: 200 psf
Phi: 40 °
Phi-Anisotropic Strength Fn.: Tmc 150-17° (A-Bed0°-5°)
C-Anisotropic Strength Fn.: 150psf-17° (A-Bed0°-5°)

Name: TQs 100-25° (A-Bed 6°-13°)
Model: Anisotropic Fn.
Unit Weight: 120 pcf
Cohesion: 225 psf
Phi: 40 °
Phi-Anisotropic Strength Fn.: TQs 100-25° (A-Bed 6°-13°)
C-Anisotropic Strength Fn.: 100psf-25° (A-Bed 6°-13°)

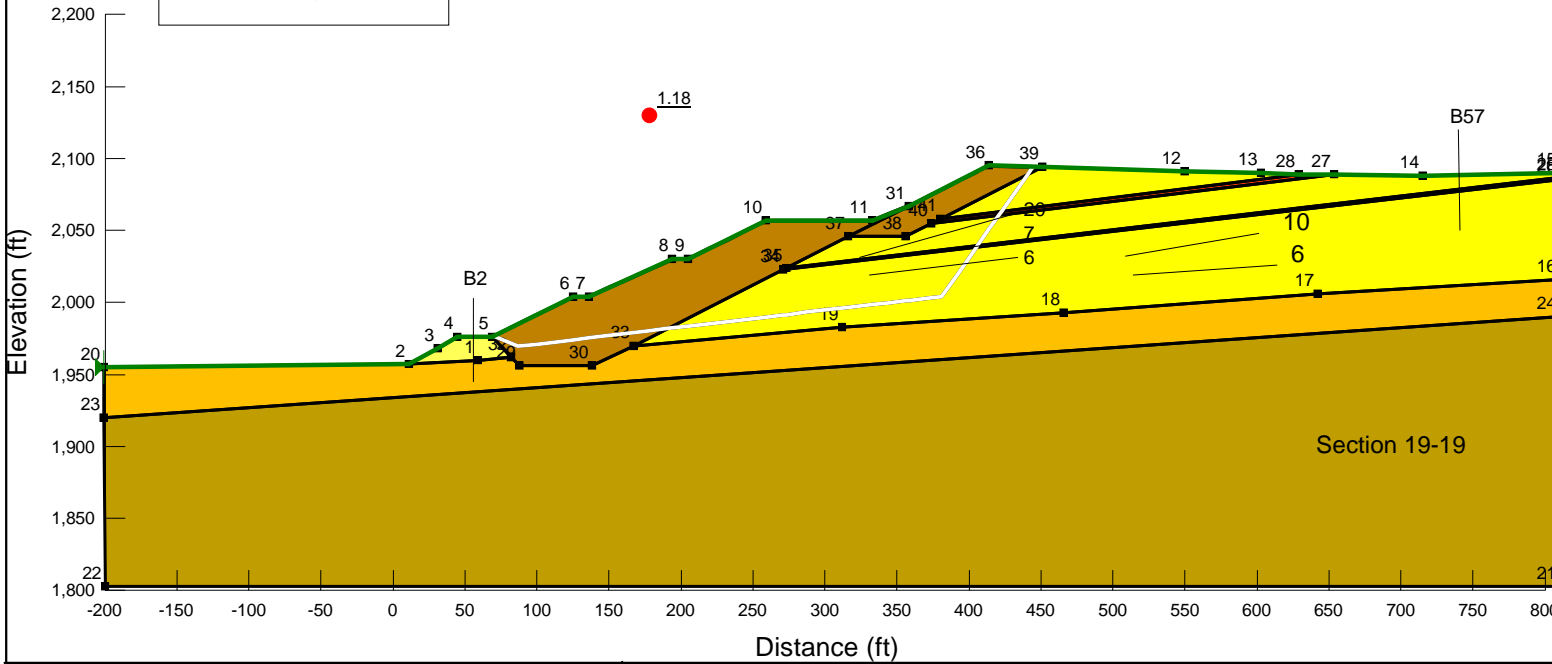

LGC Valley, Inc
GEOTECHNICAL CONSULTING
28532 Constellation Road, Valencia, CA 91355
Phone 661-702-8474, Fax 661-702-8475

Skyline Ranch
Development project, Tract 60922
Los Angeles CA

Project No: **153035-01**
Engineer: **BAS**
Date: **March 2016**

2 - Translational Below Key Seismic

Report generated using GeoStudio 2012. Copyright © 1991-2015 GEO-SLOPE International Ltd.

File Information

File Version: 8.15
 Title: Static Slope Stability Analyses for Skyline Ranch Development project, Tract 60922, Los Angeles CA
 Comments: Run By: Dr. Alexander Bykovtsev, Ph.D., P.E.
 Last Edited By: Alexander Bykovtsev
 Revision Number: 161
 Date: 3/25/2016
 Time: 3:10:06 PM
 Tool Version: 8.15.1.11777
 File Name: Section 19 SSA for Skyline Ranch.gsz
 Directory: G:\SLOPE RESULTS\Section 19-19 results\Latest Update 3-25-16\
 Last Solved Date: 3/25/2016
 Last Solved Time: 3:14:40 PM

Project Settings

Length(L) Units: Feet
 Time(t) Units: Seconds
 Force(F) Units: Pounds
 Pressure(p) Units: psf
 Strength Units: psf
 Unit Weight of Water: 62.4 pcf
 View: 2D
 Element Thickness: 1

Analysis Settings

2 - Translational Below Key Seismic

Kind: SLOPE/W
 Parent: 2 - Translational Below Key
 Method: Janbu
 Settings
 PWP Conditions Source: (none)
 Initial Slip Surface Source: Parent Analysis
 Slip Surface
 Direction of movement: Right to Left
 Use Passive Mode: No
 Slip Surface Option: Critical Slip Surfaces from Other
 Critical slip surfaces saved: 1
 Resisting Side Maximum Convex Angle: 1 °
 Driving Side Maximum Convex Angle: 5 °
 Optimize Critical Slip Surface Location: No

file:///G:/SLOPE%20RESULTS/Section%2019-19%20results/Latest%20Update%203-25-... 3/25/2016

Tension Crack
 Tension Crack Option: (none)
 F of S Distribution
 F of S Calculation Option: Constant
 Advanced
 Number of Slices: 30
 F of S Tolerance: 0.01
 Minimum Slip Surface Depth: 0.1 ft

Materials

TQs 150-17° (A-Bed6°-7°)

Model: Anisotropic Fn.
 Unit Weight: 120 pcf
 Cohesion': 225 psf
 Phi': 40 °
 Phi-Anisotropic Strength Fn.: TQs 150-17° (A-Bed6°-7°)
 C-Anisotropic Strength Fn.: 150psf-17° (A-Bed6°-7°)
 Phi-B: 0 °

Shear Layer

Model: Mohr-Coulomb
 Unit Weight: 120 pcf
 Cohesion': 150 psf
 Phi': 11 °
 Phi-B: 0 °

Fill

Model: Mohr-Coulomb
 Unit Weight: 120 pcf
 Cohesion': 200 psf
 Phi': 33 °
 Phi-B: 0 °

Tmc 100-25° (A-Bed0°-5°)

Model: Anisotropic Fn.
 Unit Weight: 120 pcf
 Cohesion': 200 psf
 Phi': 40 °
 Phi-Anisotropic Strength Fn.: Tmc 100psf-25° (A-Bed0°-5°)
 C-Anisotropic Strength Fn.: 100 psf (A-Bed0°-5°)
 Phi-B: 0 °

Tmc 150-17° (A-Bed0°-5°)

Model: Anisotropic Fn.
 Unit Weight: 120 pcf
 Cohesion': 200 psf
 Phi': 40 °
 Phi-Anisotropic Strength Fn.: Tmc 150-17° (A-Bed0°-5°)

file:///G:/SLOPE%20RESULTS/Section%2019-19%20results/Latest%20Update%203-25-... 3/25/2016

C-Anisotropic Strength Fn.: 150psf-17° (A-Bed0°-5°)
Phi-B: 0°

TQs 100-25° (A-Bed 6°-13°)

Model: Anisotropic Fn.
Unit Weight: 120 pcf
Cohesion': 225 psf
Phi': 40°
Phi-Anisotropic Strength Fn.: TQs 100-25° (A-Bed 6°-13°)
C-Anisotropic Strength Fn.: 100psf-25° (A-Bed 6°-13°)
Phi-B: 0°

Slip Surface Limits

Left Coordinate: (-201, 1,955) ft
Right Coordinate: (810, 2,090) ft

Seismic Coefficients

Horz Seismic Coef.: 0.15
Vert Seismic Coef.: 0

Anisotropic Strength Functions

150psf-17° (A-Bed6°-7°)

Model: Spline Data Point Function
Function: Modifier Factor vs. Inclination
Curve Fit to Data: 100 %
Segment Curvature: 0 %
Y-Intercept: 1
Data Points: Inclination (°), Modifier Factor
Data Point: (-90, 1)
Data Point: (5.9, 1)
Data Point: (6, 0.75)
Data Point: (7, 0.75)
Data Point: (7.1, 1)

TQs 150-17° (A-Bed6°-7°)

Model: Spline Data Point Function
Function: Modifier Factor vs. Inclination
Curve Fit to Data: 100 %
Segment Curvature: 0 %
Y-Intercept: 1
Data Points: Inclination (°), Modifier Factor
Data Point: (-90, 1)
Data Point: (5.9, 1)
Data Point: (6, 0.425)
Data Point: (7, 0.425)

Data Point: (7.1, 1)

TQs 100-25° (A-Bed 6°-13°)

Model: Spline Data Point Function
Function: Modifier Factor vs. Inclination
Curve Fit to Data: 100 %
Segment Curvature: 0 %
Y-Intercept: 1
Data Points: Inclination (°), Modifier Factor
Data Point: (-90, 1)
Data Point: (5.9, 1)
Data Point: (6, 0.625)
Data Point: (13, 0.625)
Data Point: (13.1, 1)

100 psf (A-Bed0°-5°)

Model: Spline Data Point Function
Function: Modifier Factor vs. Inclination
Curve Fit to Data: 100 %
Segment Curvature: 0 %
Y-Intercept: 0.5
Data Points: Inclination (°), Modifier Factor
Data Point: (-90, 1)
Data Point: (-0.9, 1)
Data Point: (0, 0.5)
Data Point: (5, 0.5)
Data Point: (5.1, 1)

Tmc 100psf-25° (A-Bed0°-5°)

Model: Spline Data Point Function
Function: Modifier Factor vs. Inclination
Curve Fit to Data: 100 %
Segment Curvature: 0 %
Y-Intercept: 0.625
Data Points: Inclination (°), Modifier Factor
Data Point: (-90, 1)
Data Point: (-0.9, 1)
Data Point: (0, 0.625)
Data Point: (5, 0.625)
Data Point: (5.1, 1)

150psf-17° (A-Bed0°-5°)

Model: Spline Data Point Function
Function: Modifier Factor vs. Inclination
Curve Fit to Data: 100 %
Segment Curvature: 0 %
Y-Intercept: 0.75
Data Points: Inclination (°), Modifier Factor
Data Point: (-90, 1)
Data Point: (-0.9, 1)

Data Point: (0, 0.75)
 Data Point: (5, 0.75)
 Data Point: (5.1, 1)

Tmc 150-17° (A-Bed0°-5°)

Model: Spline Data Point Function
 Function: Modifier Factor vs. Inclination
 Curve Fit to Data: 100 %
 Segment Curvature: 0 %
 Y-Intercept: 0.425
 Data Points: Inclination (°), Modifier Factor
 Data Point: (-90, 1)
 Data Point: (-0.9, 1)
 Data Point: (0, 0.425)
 Data Point: (5, 0.425)
 Data Point: (5.1, 1)

100psf-25° (A-Bed 6°-13°)

Model: Spline Data Point Function
 Function: Modifier Factor vs. Inclination
 Curve Fit to Data: 100 %
 Segment Curvature: 0 %
 Y-Intercept: 1
 Data Points: Inclination (°), Modifier Factor
 Data Point: (-90, 1)
 Data Point: (5.9, 1)
 Data Point: (6, 0.444)
 Data Point: (13, 0.444)
 Data Point: (13.1, 1)

Points

	X (ft)	Y (ft)
Point 1	59	1,960
Point 2	11	1,957
Point 3	31	1,968
Point 4	45	1,976
Point 5	69	1,976
Point 6	125	2,004
Point 7	136	2,004
Point 8	194	2,030
Point 9	205	2,030
Point 10	259	2,057
Point 11	333	2,057
Point 12	550	2,091
Point 13	603	2,090
Point 14	715	2,088
Point 15	810	2,090

Point 16	810	2,016
Point 17	642	2,006
Point 18	466	1,993
Point 19	312	1,983
Point 20	-201	1,955
Point 21	810	1,803
Point 22	-200	1,803
Point 23	-200.75	1,920
Point 24	810	1,990
Point 25	810	2,087
Point 26	810	2,085
Point 27	654	2,089.0893
Point 28	629	2,089
Point 29	88	1,956
Point 30	138	1,956
Point 31	358	2,067
Point 32	82.1967	1,962.1088
Point 33	167	1,970
Point 34	271	2,023
Point 35	273	2,024
Point 36	414	2,095
Point 37	316	2,045.9574
Point 38	356	2,046
Point 39	451	2,094

Point 40	374	2,055
Point 41	380	2,058

Regions

	Material	Points	Area (ft²)
Region 1	Tmc 100-25° (A-Bed0°-5°)	20,23,24,16,17,18,19,33,30,29,32,1,2	26,270
Region 2	Tmc 150-17° (A-Bed0°-5°)	23,22,21,24	1.5359e+005
Region 3	TQs 150-17° (A-Bed6°-7°)	19,18,17,16,26,34,33	32,238
Region 4	Shear Layer	26,25,35,34	744.5
Region 5	TQs 150-17° (A-Bed6°-7°)	15,14,27,40,38,37,35,25	8,477.5
Region 6	TQs 150-17° (A-Bed6°-7°)	13,12,39,41,28	3,375.5
Region 7	Shear Layer	27,28,41,40	694.11
Region 8	TQs 100-25° (A-Bed 6°-13°)	2,1,32,5,4,3	769.03
Region 9	Fill	5,32,29,30,33,34,35,37,31,11,10,9,8,7,6	9,276.8
Region 10	Fill	37,38,40,41,39,36,31	1,921.5

Current Slip Surface

Slip Surface: 1
 F of S: 1.18
 Volume: 17,572.776 ft³
 Weight: 2,108,733.1 lbs
 Resisting Force: 850,911.89 lbs
 Activating Force: 723,551.56 lbs
 F of S Rank (Analysis): 1 of 1 slip surfaces
 F of S Rank (Query): 1 of 1 slip surfaces
 Exit: (70.045537, 1,976.5228) ft
 Entry: (444.30533, 2,094.1809) ft
 Radius: 190.20752 ft
 Center: (229.43379, 2,123.5955) ft

Slip Slices

	X (ft)	Y (ft)	PWP (psf)	Base Normal Stress (psf)	Frictional Strength (psf)	Cohesive Strength (psf)
Slice 1	78.522769	1,973.0114	0	1,296.8419	842.17901	200
Slice 2	93.333333	1,970.2467	0	2,000.202	1,298.9464	200
Slice 3	106	1,971.7402	0	2,545.5017	1,653.0681	200
Slice 4	118.66667	1,973.2337	0	3,090.8016	2,007.19	200
Slice 5	130.5	1,974.629	0	3,290.3871	2,136.8024	200

Slice 6	142.72551	1,976.0704	0	3,467.6616	2,251.9258	200
Slice 7	156.17653	1,977.6564	0	3,968.3394	2,577.0697	200
Slice 8	169.62755	1,979.2424	0	4,469.0171	2,902.2136	200
Slice 9	183.07857	1,980.8283	0	4,969.6949	3,227.3576	200
Slice 10	191.90204	1,981.8687	0	5,478.1816	1,674.8482	168.75
Slice 11	199.5	1,982.7645	0	5,483.3761	1,676.4363	168.75
Slice 12	211.75	1,984.2089	0	5,708.1669	1,745.1618	168.75
Slice 13	225.25	1,985.8006	0	6,308.7598	1,928.7814	168.75
Slice 14	238.75	1,987.3924	0	6,909.3526	2,112.4011	168.75
Slice 15	252.25	1,988.9841	0	7,509.9455	2,296.0207	168.75
Slice 16	265	1,990.4874	0	7,727.8721	2,362.6476	168.75
Slice 17	272	1,991.3128	0	7,631.7739	2,333.2674	168.75
Slice 18	280.16667	1,992.2757	0	7,519.6597	2,298.9907	168.75
Slice 19	294.5	1,993.9657	0	7,322.8875	2,238.8314	168.75
Slice 20	308.83333	1,995.6557	0	7,126.1154	2,178.6721	168.75
Slice 21	324.5	1,997.5029	0	6,911.0389	2,112.9166	168.75
Slice 22	338.75	1,999.1831	0	6,983.2075	2,134.9808	168.75
Slice 23	350.25	2,000.539	0	7,360.9253	2,250.4607	168.75
Slice 24	357	2,001.3349	0	7,582.629	2,318.2423	168.75
Slice 25	366	2,002.396	0	7,971.381	2,437.0957	168.75
Slice 26	377	2,003.693	0	8,460.7531	2,586.7118	168.75
Slice 27	380.65	2,004.1234	0	8,623.1354	2,636.3571	168.75
Slice 28	387.2948	2,012.7615	0	3,960.2784	3,323.0681	225
Slice 29	399.2844	2,029.8844	0	3,298.6628	2,767.9067	225

Slice 30	405.68846	2,039.0303	0	4,883.5655	949.26896	150
Slice 31	410.04886	2,045.2576	0	2,704.6534	2,269.4736	225
Slice 32	417.43289	2,055.8031	0	2,189.6181	1,837.3078	225
Slice 33	421.77934	2,062.0105	0	3,035.4	590.022	150
Slice 34	431.55828	2,075.9763	0	967.53849	811.86119	225
Slice 35	442.3645	2,091.4091	0	53.789956	34.931606	200

Section 19 SSA for Skyline Ranch.gsz

Section 19 SSA for Skyline Ranch.gsz Run By: Dr. Alexander Bykovtsev, Ph.D., P.E. 3/25/2016 3:19:32 PM

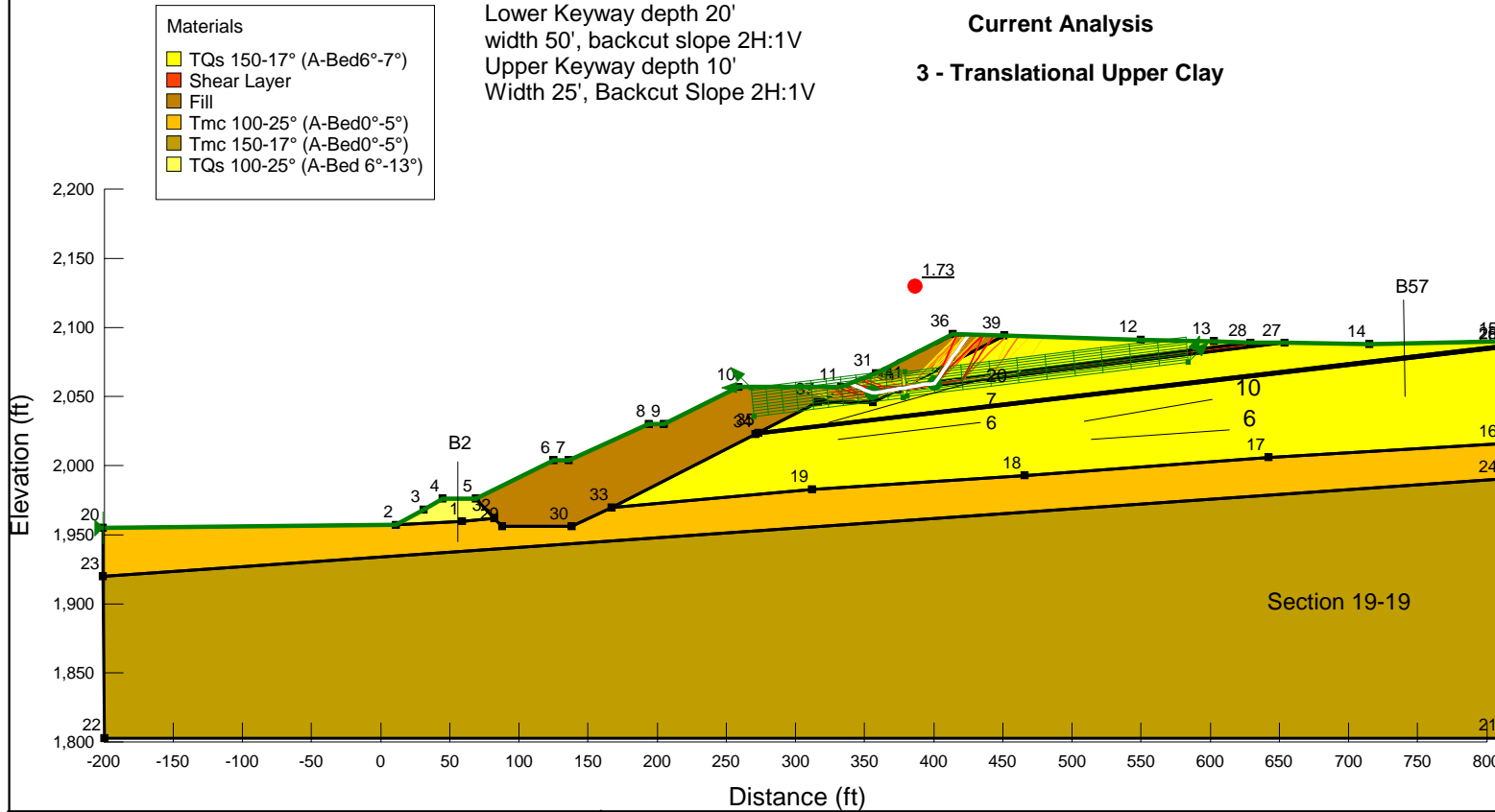

Current Analysis
3 - Translational Upper Clay

Lower Keyway depth 20'
width 50', backcut slope 2H:1V
Upper Keyway depth 10'
Width 25', Backcut Slope 2H:1V

Materials

- TQs 150-17° (A-Bed6°-7°)
- Shear Layer
- Fill
- Tmc 100-25° (A-Bed0°-5°)
- Tmc 150-17° (A-Bed0°-5°)
- TQs 100-25° (A-Bed 6°-13°)

Name: TQs 150-17° (A-Bed6°-7°)
Model: Anisotropic Fn.
Unit Weight: 120 pcf
Cohesion: 225 psf
Phi: 40 °
Phi-Anisotropic Strength Fn.: TQs 150-17° (A-Bed6°-7°)
C-Anisotropic Strength Fn.: 150psf-17° (A-Bed6°-7°)

Name: Shear Layer
Model: Mohr-Coulomb
Unit Weight: 120 pcf
Cohesion: 150 psf
Phi: 11 °

Name: Fill
Model: Mohr-Coulomb
Unit Weight: 120 pcf
Cohesion: 200 psf
Phi: 33 °

Name: Tmc 100-25° (A-Bed0°-5°)
Model: Anisotropic Fn.
Unit Weight: 120 pcf
Cohesion: 200 psf
Phi: 40 °
Phi-Anisotropic Strength Fn.: Tmc 100psf-25° (A-Bed0°-5°)
C-Anisotropic Strength Fn.: 100 psf (A-Bed0°-5°)

Name: Tmc 150-17° (A-Bed0°-5°)
Model: Anisotropic Fn.
Unit Weight: 120 pcf
Cohesion: 200 psf
Phi: 40 °
Phi-Anisotropic Strength Fn.: Tmc 150-17° (A-Bed0°-5°)
C-Anisotropic Strength Fn.: 150psf-17° (A-Bed0°-5°)

Name: TQs 100-25° (A-Bed 6°-13°)
Model: Anisotropic Fn.
Unit Weight: 120 pcf
Cohesion: 225 psf
Phi: 40 °
Phi-Anisotropic Strength Fn.: TQs 100-25° (A-Bed 6°-13°)
C-Anisotropic Strength Fn.: 100psf-25° (A-Bed 6°-13°)



LGC Valley, Inc
GEOTECHNICAL CONSULTING
28532 Constellation Road, Valencia, CA 91355
Phone 661-702-8474, Fax 661-702-8475

Skyline Ranch
Development project, Tract 60922
Los Angeles CA

Project No: **153035-01**
Engineer: **BAS**
Date: **March 2016**

3 - Translational Upper Clay

Report generated using GeoStudio 2012. Copyright © 1991-2015 GEO-SLOPE International Ltd.

File Information

File Version: 8.15
 Title: Static Slope Stability Analyses for Skyline Ranch Development project, Tract 60922, Los Angeles CA
 Comments: Run By: Dr. Alexander Bykovtsev, Ph.D., P.E.
 Last Edited By: Alexander Bykovtsev
 Revision Number: 164
 Date: 3/25/2016
 Time: 3:19:32 PM
 Tool Version: 8.15.1.11777
 File Name: Section 19 SSA for Skyline Ranch.gsz
 Directory: G:\SLOPE RESULTS\Section 19-19 results\Latest Update 3-25-16\
 Last Solved Date: 3/25/2016
 Last Solved Time: 3:19:54 PM

Project Settings

Length(L) Units: Feet
 Time(t) Units: Seconds
 Force(F) Units: Pounds
 Pressure(p) Units: psf
 Strength Units: psf
 Unit Weight of Water: 62.4 pcf
 View: 2D
 Element Thickness: 1

Analysis Settings

3 - Translational Upper Clay

Kind: SLOPE/W
 Method: Janbu
 Settings
 PWP Conditions Source: (none)
 Slip Surface
 Direction of movement: Right to Left
 Use Passive Mode: No
 Slip Surface Option: Block
 Critical slip surfaces saved: 1
 Resisting Side Maximum Convex Angle: 1 °
 Driving Side Maximum Convex Angle: 5 °
 Restrict Block Crossing: No
 Optimize Critical Slip Surface Location: No
 Tension Crack

Tension Crack Option: (none)
 F of S Distribution
 F of S Calculation Option: Constant
 Advanced
 Number of Slices: 30
 F of S Tolerance: 0.01
 Minimum Slip Surface Depth: 0.1 ft

Materials

TQs 150-17° (A-Bed6°-7°)

Model: Anisotropic Fn.
 Unit Weight: 120 pcf
 Cohesion': 225 psf
 Phi': 40 °
 Phi-Anisotropic Strength Fn.: TQs 150-17° (A-Bed6°-7°)
 C-Anisotropic Strength Fn.: 150psf-17° (A-Bed6°-7°)
 Phi-B: 0 °

Shear Layer

Model: Mohr-Coulomb
 Unit Weight: 120 pcf
 Cohesion': 150 psf
 Phi': 11 °
 Phi-B: 0 °

Fill

Model: Mohr-Coulomb
 Unit Weight: 120 pcf
 Cohesion': 200 psf
 Phi': 33 °
 Phi-B: 0 °

Tmc 100-25° (A-Bed0°-5°)

Model: Anisotropic Fn.
 Unit Weight: 120 pcf
 Cohesion': 200 psf
 Phi': 40 °
 Phi-Anisotropic Strength Fn.: Tmc 100psf-25° (A-Bed0°-5°)
 C-Anisotropic Strength Fn.: 100 psf (A-Bed0°-5°)
 Phi-B: 0 °

Tmc 150-17° (A-Bed0°-5°)

Model: Anisotropic Fn.
 Unit Weight: 120 pcf
 Cohesion': 200 psf
 Phi': 40 °
 Phi-Anisotropic Strength Fn.: Tmc 150-17° (A-Bed0°-5°)
 C-Anisotropic Strength Fn.: 150psf-17° (A-Bed0°-5°)

Phi-B: 0 °

TQs 100-25° (A-Bed 6°-13°)

Model: [Anisotropic Fn.](#)
 Unit Weight: 120 pcf
 Cohesion: 225 psf
 Phi: 40 °
 Phi-Anisotropic Strength Fn.: TQs 100-25° (A-Bed 6°-13°)
 C-Anisotropic Strength Fn.: 100psf-25° (A-Bed 6°-13°)
 Phi-B: 0 °

Slip Surface Limits

Left Coordinate: (-201, 1,955) ft
 Right Coordinate: (810, 2,090) ft

Slip Surface Block

Left Grid
 Upper Left: (268, 2,056.1838) ft
 Lower Left: (270, 2,035.5966) ft
 Lower Right: (378, 2,049) ft
 X Increments: 10
 Y Increments: 10
 Starting Angle: 135 °
 Ending Angle: 180 °
 Angle Increments: 2

Right Grid
 Upper Left: (379.3498, 2,068) ft
 Lower Left: (381, 2,050) ft
 Lower Right: (584, 2,075) ft
 X Increments: 10
 Y Increments: 10
 Starting Angle: 45 °
 Ending Angle: 65 °
 Angle Increments: 2

Seismic Coefficients

Horz Seismic Coef.: 0
 Vert Seismic Coef.: 0

Anisotropic Strength Functions

150psf-17° (A-Bed6°-7°)

Model: [Spline Data Point Function](#)
 Function: [Modifier Factor vs. Inclination](#)
 Curve Fit to Data: 100 %

Segment Curvature: 0 %
 Y-Intercept: 1
 Data Points: [Inclination \(°\), Modifier Factor](#)
 Data Point: (-90, 1)
 Data Point: (5.9, 1)
 Data Point: (6, 0.75)
 Data Point: (7, 0.75)
 Data Point: (7.1, 1)

TQs 150-17° (A-Bed6°-7°)

Model: [Spline Data Point Function](#)
 Function: [Modifier Factor vs. Inclination](#)
 Curve Fit to Data: 100 %
 Segment Curvature: 0 %
 Y-Intercept: 1
 Data Points: [Inclination \(°\), Modifier Factor](#)
 Data Point: (-90, 1)
 Data Point: (5.9, 1)
 Data Point: (6, 0.425)
 Data Point: (7, 0.425)
 Data Point: (7.1, 1)

TQs 100-25° (A-Bed 6°-13°)

Model: [Spline Data Point Function](#)
 Function: [Modifier Factor vs. Inclination](#)
 Curve Fit to Data: 100 %
 Segment Curvature: 0 %
 Y-Intercept: 1
 Data Points: [Inclination \(°\), Modifier Factor](#)
 Data Point: (-90, 1)
 Data Point: (5.9, 1)
 Data Point: (6, 0.625)
 Data Point: (13, 0.625)
 Data Point: (13.1, 1)

100 psf (A-Bed0°-5°)

Model: [Spline Data Point Function](#)
 Function: [Modifier Factor vs. Inclination](#)
 Curve Fit to Data: 100 %
 Segment Curvature: 0 %
 Y-Intercept: 0.5
 Data Points: [Inclination \(°\), Modifier Factor](#)
 Data Point: (-90, 1)
 Data Point: (-0.9, 1)
 Data Point: (0, 0.5)
 Data Point: (5, 0.5)
 Data Point: (5.1, 1)

Tmc 100psf-25° (A-Bed0°-5°)

Model: [Spline Data Point Function](#)

Function: **Modifier Factor vs. Inclination**

Curve Fit to Data: 100 %

Segment Curvature: 0 %

Y-Intercept: 0.625

Data Points: **Inclination (°), Modifier Factor**

Data Point: (-90, 1)

Data Point: (-0.9, 1)

Data Point: (0, 0.625)

Data Point: (5, 0.625)

Data Point: (5.1, 1)

150psf-17° (A-Bed0°-5°)

Model: **Spline Data Point Function**

Function: **Modifier Factor vs. Inclination**

Curve Fit to Data: 100 %

Segment Curvature: 0 %

Y-Intercept: 0.75

Data Points: **Inclination (°), Modifier Factor**

Data Point: (-90, 1)

Data Point: (-0.9, 1)

Data Point: (0, 0.75)

Data Point: (5, 0.75)

Data Point: (5.1, 1)

Tmc 150-17° (A-Bed0°-5°)

Model: **Spline Data Point Function**

Function: **Modifier Factor vs. Inclination**

Curve Fit to Data: 100 %

Segment Curvature: 0 %

Y-Intercept: 0.425

Data Points: **Inclination (°), Modifier Factor**

Data Point: (-90, 1)

Data Point: (-0.9, 1)

Data Point: (0, 0.425)

Data Point: (5, 0.425)

Data Point: (5.1, 1)

100psf-25° (A-Bed 6°-13°)

Model: **Spline Data Point Function**

Function: **Modifier Factor vs. Inclination**

Curve Fit to Data: 100 %

Segment Curvature: 0 %

Y-Intercept: 1

Data Points: **Inclination (°), Modifier Factor**

Data Point: (-90, 1)

Data Point: (5.9, 1)

Data Point: (6, 0.444)

Data Point: (13, 0.444)

Data Point: (13.1, 1)

Points

	X (ft)	Y (ft)
Point 1	59	1,960
Point 2	11	1,957
Point 3	31	1,968
Point 4	45	1,976
Point 5	69	1,976
Point 6	125	2,004
Point 7	136	2,004
Point 8	194	2,030
Point 9	205	2,030
Point 10	259	2,057
Point 11	333	2,057
Point 12	550	2,091
Point 13	603	2,090
Point 14	715	2,088
Point 15	810	2,090
Point 16	810	2,016
Point 17	642	2,006
Point 18	466	1,993
Point 19	312	1,983
Point 20	-201	1,955
Point 21	810	1,803
Point 22	-200	1,803
Point 23	-200.75	1,920
Point 24	810	1,990
Point 25	810	2,087
Point 26	810	2,085
Point 27	654	2,089.0893
Point 28	629	2,089
Point 29	88	1,956
Point 30	138	1,956
Point 31	358	2,067
Point 32	82.1967	1,962.1088
Point 33	167	1,970
Point 34	271	2,023
Point 35	273	2,024
Point 36	414	2,095
Point 37	316	2,045.9574
Point 38	356	2,046
Point 39	451	2,094
Point 40	374	2,055
Point 41	380	2,058

Regions

	Material	Points	Area (ft²)
Region 1	Tmc 100-25° (A-Bed0°-5°)	20,23,24,16,17,18,19,33,30,29,32,1,2	26,270
Region 2	Tmc 150-17° (A-Bed0°-5°)	23,22,21,24	1.5359e+005
Region 3	TQs 150-17° (A-Bed6°-7°)	19,18,17,16,26,34,33	32,238
Region 4	Shear Layer	26,25,35,34	744.5
Region 5	TQs 150-17° (A-Bed6°-7°)	15,14,27,40,38,37,35,25	8,477.5
Region 6	TQs 150-17° (A-Bed6°-7°)	13,12,39,41,28	3,375.5
Region 7	Shear Layer	27,28,41,40	694.11
Region 8	TQs 100-25° (A-Bed 6°-13°)	2,1,32,5,4,3	769.03
Region 9	Fill	5,32,29,30,33,34,35,37,31,11,10,9,8,7,6	9,276.8
Region 10	Fill	37,38,40,41,39,36,31	1,921.5

Current Slip Surface

Slip Surface: 45,149
 F of S: 1.73
 Volume: 1,446.3483 ft³
 Weight: 173,561.79 lbs
 Resisting Force: 84,158.986 lbs
 Activating Force: 48,538.805 lbs
 F of S Rank (Analysis): 1 of 131,769 slip surfaces
 F of S Rank (Query): 1 of 300 slip surfaces
 Exit: (339.06665, 2,059.4267) ft
 Entry: (425.14631, 2,094.6987) ft
 Radius: 52.408887 ft
 Center: (371.26663, 2,103.5168) ft

Slip Slices

	X (ft)	Y (ft)	PWP (psf)	Base Normal Stress (psf)	Frictional Strength (psf)	Cohesive Strength (psf)
Slice 1	340.11149	2,058.9939	0	177.87364	115.51249	200
Slice 2	342.6207	2,057.9545	0	468.34829	304.14893	200
Slice 3	345.54944	2,056.7414	0	807.38839	524.32415	200
Slice 4	348.47817	2,055.5283	0	1,146.4285	744.49937	200
Slice 5	351.4069	2,054.3152	0	1,485.4686	964.67458	200
Slice 6	354.33563	2,053.102	0	1,824.5087	1,184.8498	200
Slice 7	356.9	2,052.6722	0	1,553.8778	1,009.1	200
Slice 8	359.43641	2,053.0797	0	1,638.8191	1,064.2615	200

Slice 9	362.30922	2,053.5413	0	1,749.124	1,135.8944	200
Slice 10	365.18204	2,054.0029	0	1,859.4289	1,207.5272	200
Slice 11	368.05485	2,054.4645	0	1,969.7338	1,279.1601	200
Slice 12	370.92767	2,054.9261	0	2,080.0387	1,350.7929	200
Slice 13	373.80048	2,055.3877	0	2,190.3435	1,422.4257	200
Slice 14	376.42767	2,055.8098	0	2,391.2045	464.80306	150
Slice 15	378.80922	2,056.1924	0	2,486.4548	483.31785	150
Slice 16	381.47428	2,056.6206	0	2,593.0438	504.03666	150
Slice 17	384.42284	2,057.0944	0	2,710.9715	526.95948	150
Slice 18	387.3714	2,057.5681	0	2,828.8992	549.8823	150
Slice 19	390.31996	2,058.0419	0	2,946.8269	572.80512	150
Slice 20	393.26852	2,058.5156	0	3,064.7545	595.72793	150
Slice 21	396.21708	2,058.9894	0	3,182.6822	618.65075	150
Slice 22	399.16564	2,059.4631	0	3,300.6099	641.57357	150
Slice 23	400.97346	2,060.1763	0	2,819.1823	547.99354	150
Slice 24	402.78183	2,062.759	0	1,775.5906	1,489.8974	225
Slice 25	405.73149	2,066.9715	0	1,581.7606	1,327.2548	225
Slice 26	408.68116	2,071.1841	0	1,387.9307	1,164.6121	225
Slice 27	412.078	2,076.0353	0	1,297.1631	842.38757	200
Slice 28	415.39329	2,080.77	0	999.75259	649.24692	200
Slice 29	418.17987	2,084.7496	0	683.33531	443.76314	200
Slice 30	420.96644	2,088.7293	0	366.91804	238.27936	200
Slice 31	423.75302	2,092.7089	0	50.500762	32.795578	200

Section 19 SSA for Skyline Ranch.gsz

Section 19 SSA for Skyline Ranch.gsz Run By: Dr. Alexander Bykovtsev, Ph.D., P.E. 3/25/2016 3:19:32 PM

- Materials**
- TQs 150-17° (A-Bed6°-7°)
 - Shear Layer
 - Fill
 - Tmc 100-25° (A-Bed0°-5°)
 - Tmc 150-17° (A-Bed0°-5°)
 - TQs 100-25° (A-Bed 6°-13°)

Lower Keyway depth 20'
width 50', backcut slope 2H:1V
Upper Keyway depth 10'
Width 25', Backcut Slope 2H:1V

Current Analysis

3 - Translational Upper Clay Seismic

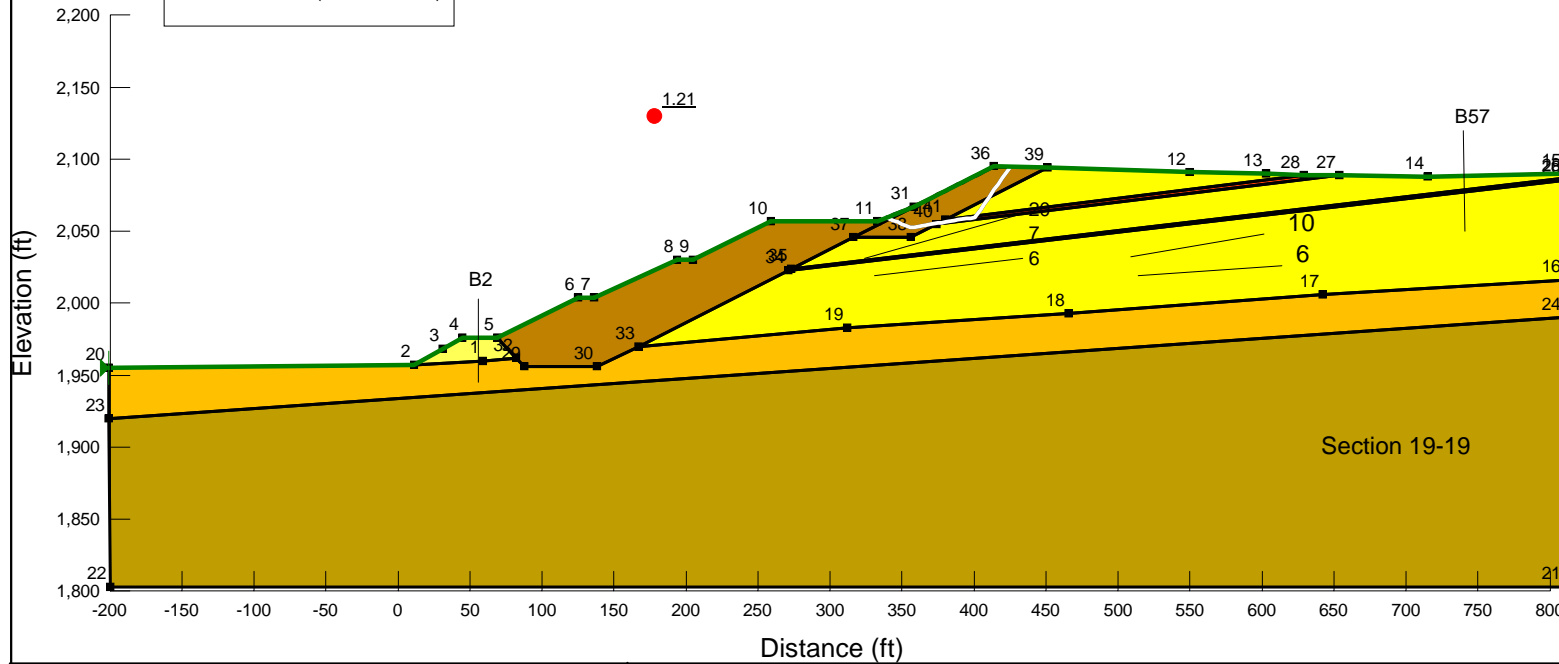

Name: TQs 150-17° (A-Bed6°-7°)
Model: Anisotropic Fn.
Unit Weight: 120 pcf
Cohesion': 225 psf
Phi': 40 °
Phi-Anisotropic Strength Fn.: TQs 150-17° (A-Bed6°-7°)
C-Anisotropic Strength Fn.: 150psf-17° (A-Bed6°-7°)

Name: Shear Layer
Model: Mohr-Coulomb
Unit Weight: 120 pcf
Cohesion': 150 psf
Phi': 11 °

Name: Fill
Model: Mohr-Coulomb
Unit Weight: 120 pcf
Cohesion': 200 psf
Phi': 33 °

Name: Tmc 100-25° (A-Bed0°-5°)
Model: Anisotropic Fn.
Unit Weight: 120 pcf
Cohesion': 200 psf
Phi': 40 °
Phi-Anisotropic Strength Fn.: Tmc 100psf-25° (A-Bed0°-5°)
C-Anisotropic Strength Fn.: 100 psf (A-Bed0°-5°)

Name: Tmc 150-17° (A-Bed0°-5°)
Model: Anisotropic Fn.
Unit Weight: 120 pcf
Cohesion': 200 psf
Phi': 40 °
Phi-Anisotropic Strength Fn.: Tmc 150-17° (A-Bed0°-5°)
C-Anisotropic Strength Fn.: 150psf-17° (A-Bed0°-5°)

Name: TQs 100-25° (A-Bed 6°-13°)
Model: Anisotropic Fn.
Unit Weight: 120 pcf
Cohesion': 225 psf
Phi': 40 °
Phi-Anisotropic Strength Fn.: TQs 100-25° (A-Bed 6°-13°)
C-Anisotropic Strength Fn.: 100psf-25° (A-Bed 6°-13°)

LGC **LGC Valley, Inc**
GEOTECHNICAL CONSULTING
28532 Constellation Road, Valencia, CA 91355
Phone 661-702-8474, Fax 661-702-8475

Skyline Ranch
Development project, Tract 60922
Los Angeles CA

Project No: **153035-01**
Engineer: **BAS**
Date: **March 2016**

3 - Translational Upper Clay Seismic

Report generated using GeoStudio 2012. Copyright © 1991-2015 GEO-SLOPE International Ltd.

File Information

File Version: 8.15
 Title: Static Slope Stability Analyses for Skyline Ranch Development project, Tract 60922, Los Angeles CA
 Comments: Run By: Dr. Alexander Bykovtsev, Ph.D., P.E.
 Last Edited By: Alexander Bykovtsev
 Revision Number: 164
 Date: 3/25/2016
 Time: 3:19:32 PM
 Tool Version: 8.15.1.11777
 File Name: Section 19 SSA for Skyline Ranch.gsz
 Directory: G:\SLOPE RESULTS\Section 19-19 results\Latest Update 3-25-16\
 Last Solved Date: 3/25/2016
 Last Solved Time: 3:19:54 PM

Project Settings

Length(L) Units: Feet
 Time(t) Units: Seconds
 Force(F) Units: Pounds
 Pressure(p) Units: psf
 Strength Units: psf
 Unit Weight of Water: 62.4 pcf
 View: 2D
 Element Thickness: 1

Analysis Settings

3 - Translational Upper Clay Seismic

Kind: SLOPE/W
 Parent: 3 - Translational Upper Clay
 Method: Janbu
 Settings

PWP Conditions Source: (none)
 Initial Slip Surface Source: Parent Analysis

Slip Surface

Direction of movement: Right to Left
 Use Passive Mode: No
 Slip Surface Option: Critical Slip Surfaces from Other
 Critical slip surfaces saved: 1
 Resisting Side Maximum Convex Angle: 1 °
 Driving Side Maximum Convex Angle: 5 °
 Optimize Critical Slip Surface Location: No

Tension Crack
 Tension Crack Option: (none)
 F of S Distribution
 F of S Calculation Option: Constant
 Advanced
 Number of Slices: 30
 F of S Tolerance: 0.01
 Minimum Slip Surface Depth: 0.1 ft

Materials

TQs 150-17° (A-Bed6°-7°)

Model: Anisotropic Fn.
 Unit Weight: 120 pcf
 Cohesion': 225 psf
 Phi': 40 °
 Phi-Anisotropic Strength Fn.: TQs 150-17° (A-Bed6°-7°)
 C-Anisotropic Strength Fn.: 150psf-17° (A-Bed6°-7°)
 Phi-B: 0 °

Shear Layer

Model: Mohr-Coulomb
 Unit Weight: 120 pcf
 Cohesion': 150 psf
 Phi': 11 °
 Phi-B: 0 °

Fill

Model: Mohr-Coulomb
 Unit Weight: 120 pcf
 Cohesion': 200 psf
 Phi': 33 °
 Phi-B: 0 °

Tmc 100-25° (A-Bed0°-5°)

Model: Anisotropic Fn.
 Unit Weight: 120 pcf
 Cohesion': 200 psf
 Phi': 40 °
 Phi-Anisotropic Strength Fn.: Tmc 100psf-25° (A-Bed0°-5°)
 C-Anisotropic Strength Fn.: 100 psf (A-Bed0°-5°)
 Phi-B: 0 °

Tmc 150-17° (A-Bed0°-5°)

Model: Anisotropic Fn.
 Unit Weight: 120 pcf
 Cohesion': 200 psf
 Phi': 40 °
 Phi-Anisotropic Strength Fn.: Tmc 150-17° (A-Bed0°-5°)

C-Anisotropic Strength Fn.: 150psf-17° (A-Bed0°-5°)
Phi-B: 0°

TQs 100-25° (A-Bed 6°-13°)

Model: Anisotropic Fn.
Unit Weight: 120 pcf
Cohesion': 225 psf
Phi': 40°
Phi-Anisotropic Strength Fn.: TQs 100-25° (A-Bed 6°-13°)
C-Anisotropic Strength Fn.: 100psf-25° (A-Bed 6°-13°)
Phi-B: 0°

Slip Surface Limits

Left Coordinate: (-201, 1,955) ft
Right Coordinate: (810, 2,090) ft

Seismic Coefficients

Horz Seismic Coef.: 0.15
Vert Seismic Coef.: 0

Anisotropic Strength Functions

150psf-17° (A-Bed6°-7°)

Model: Spline Data Point Function
Function: Modifier Factor vs. Inclination
Curve Fit to Data: 100 %
Segment Curvature: 0 %
Y-Intercept: 1
Data Points: Inclination (°), Modifier Factor
Data Point: (-90, 1)
Data Point: (5.9, 1)
Data Point: (6, 0.75)
Data Point: (7, 0.75)
Data Point: (7.1, 1)

TQs 150-17° (A-Bed6°-7°)

Model: Spline Data Point Function
Function: Modifier Factor vs. Inclination
Curve Fit to Data: 100 %
Segment Curvature: 0 %
Y-Intercept: 1
Data Points: Inclination (°), Modifier Factor
Data Point: (-90, 1)
Data Point: (5.9, 1)
Data Point: (6, 0.425)
Data Point: (7, 0.425)

Data Point: (7.1, 1)

TQs 100-25° (A-Bed 6°-13°)

Model: Spline Data Point Function
Function: Modifier Factor vs. Inclination
Curve Fit to Data: 100 %
Segment Curvature: 0 %
Y-Intercept: 1
Data Points: Inclination (°), Modifier Factor
Data Point: (-90, 1)
Data Point: (5.9, 1)
Data Point: (6, 0.625)
Data Point: (13, 0.625)
Data Point: (13.1, 1)

100 psf (A-Bed0°-5°)

Model: Spline Data Point Function
Function: Modifier Factor vs. Inclination
Curve Fit to Data: 100 %
Segment Curvature: 0 %
Y-Intercept: 0.5
Data Points: Inclination (°), Modifier Factor
Data Point: (-90, 1)
Data Point: (-0.9, 1)
Data Point: (0, 0.5)
Data Point: (5, 0.5)
Data Point: (5.1, 1)

Tmc 100psf-25° (A-Bed0°-5°)

Model: Spline Data Point Function
Function: Modifier Factor vs. Inclination
Curve Fit to Data: 100 %
Segment Curvature: 0 %
Y-Intercept: 0.625
Data Points: Inclination (°), Modifier Factor
Data Point: (-90, 1)
Data Point: (-0.9, 1)
Data Point: (0, 0.625)
Data Point: (5, 0.625)
Data Point: (5.1, 1)

150psf-17° (A-Bed0°-5°)

Model: Spline Data Point Function
Function: Modifier Factor vs. Inclination
Curve Fit to Data: 100 %
Segment Curvature: 0 %
Y-Intercept: 0.75
Data Points: Inclination (°), Modifier Factor
Data Point: (-90, 1)
Data Point: (-0.9, 1)

Data Point: (0, 0.75)
 Data Point: (5, 0.75)
 Data Point: (5.1, 1)

Tmc 150-17° (A-Bed0°-5°)

Model: Spline Data Point Function
 Function: Modifier Factor vs. Inclination
 Curve Fit to Data: 100 %
 Segment Curvature: 0 %

Y-Intercept: 0.425

Data Points: Inclination (°), Modifier Factor
 Data Point: (-90, 1)
 Data Point: (-0.9, 1)
 Data Point: (0, 0.425)
 Data Point: (5, 0.425)
 Data Point: (5.1, 1)

100psf-25° (A-Bed 6°-13°)

Model: Spline Data Point Function
 Function: Modifier Factor vs. Inclination
 Curve Fit to Data: 100 %
 Segment Curvature: 0 %

Y-Intercept: 1

Data Points: Inclination (°), Modifier Factor
 Data Point: (-90, 1)
 Data Point: (5.9, 1)
 Data Point: (6, 0.444)
 Data Point: (13, 0.444)
 Data Point: (13.1, 1)

Points

	X (ft)	Y (ft)
Point 1	59	1,960
Point 2	11	1,957
Point 3	31	1,968
Point 4	45	1,976
Point 5	69	1,976
Point 6	125	2,004
Point 7	136	2,004
Point 8	194	2,030
Point 9	205	2,030
Point 10	259	2,057
Point 11	333	2,057
Point 12	550	2,091
Point 13	603	2,090
Point 14	715	2,088
Point 15	810	2,090

Point 16	810	2,016
Point 17	642	2,006
Point 18	466	1,993
Point 19	312	1,983
Point 20	-201	1,955
Point 21	810	1,803
Point 22	-200	1,803
Point 23	-200.75	1,920
Point 24	810	1,990
Point 25	810	2,087
Point 26	810	2,085
Point 27	654	2,089.0893
Point 28	629	2,089
Point 29	88	1,956
Point 30	138	1,956
Point 31	358	2,067
Point 32	82.1967	1,962.1088
Point 33	167	1,970
Point 34	271	2,023
Point 35	273	2,024
Point 36	414	2,095
Point 37	316	2,045.9574
Point 38	356	2,046
Point 39	451	2,094

Point 40	374	2,055
Point 41	380	2,058

Regions

	Material	Points	Area (ft ²)
Region 1	Tmc 100-25° (A-Bed0°-5°)	20,23,24,16,17,18,19,33,30,29,32,1,2	26,270
Region 2	Tmc 150-17° (A-Bed0°-5°)	23,22,21,24	1.5359e+005
Region 3	TQs 150-17° (A-Bed6°-7°)	19,18,17,16,26,34,33	32,238
Region 4	Shear Layer	26,25,35,34	744.5
Region 5	TQs 150-17° (A-Bed6°-7°)	15,14,27,40,38,37,35,25	8,477.5
Region 6	TQs 150-17° (A-Bed6°-7°)	13,12,39,41,28	3,375.5
Region 7	Shear Layer	27,28,41,40	694.11
Region 8	TQs 100-25° (A-Bed 6°-13°)	2,1,32,5,4,3	769.03
Region 9	Fill	5,32,29,30,33,34,35,37,31,11,10,9,8,7,6	9,276.8
Region 10	Fill	37,38,40,41,39,36,31	1,921.5

Current Slip Surface

Slip Surface: 1
 F of S: 1.21
 Volume: 1,446.3483 ft³
 Weight: 173,561.79 lbs
 Resisting Force: 81,242.323 lbs
 Activating Force: 66,989.512 lbs
 F of S Rank (Analysis): 1 of 1 slip surfaces
 F of S Rank (Query): 1 of 1 slip surfaces
 Exit: (339.06665, 2,059.4267) ft
 Entry: (425.14631, 2,094.6987) ft
 Radius: 52.408887 ft
 Center: (371.26663, 2,103.5168) ft

Slip Slices

	X (ft)	Y (ft)	PWP (psf)	Base Normal Stress (psf)	Frictional Strength (psf)	Cohesive Strength (psf)
Slice 1	340.11149	2,058.9939	0	219.33856	142.44013	200
Slice 2	342.6207	2,057.9545	0	534.6041	347.17597	200
Slice 3	345.54944	2,056.7414	0	902.57992	586.14225	200
Slice 4	348.47817	2,055.5283	0	1,270.5553	825.10823	200
Slice 5	351.4069	2,054.3152	0	1,638.5314	1,064.0747	200

Slice 6	354.33563	2,053.102	0	2,006.5072	1,303.041	200
Slice 7	356.9	2,052.6722	0	1,509.7522	980.44452	200
Slice 8	359.43641	2,053.0797	0	1,592.6802	1,034.2986	200
Slice 9	362.30922	2,053.5413	0	1,700.3708	1,104.2337	200
Slice 10	365.18204	2,054.0029	0	1,808.0615	1,174.1689	200
Slice 11	368.05485	2,054.4645	0	1,915.7521	1,244.104	200
Slice 12	370.92767	2,054.9261	0	2,023.4428	1,314.0391	200
Slice 13	373.80048	2,055.3877	0	2,131.1335	1,383.9742	200
Slice 14	376.42767	2,055.8098	0	2,267.4456	460.18481	150
Slice 15	378.80922	2,056.1924	0	2,461.9802	478.56048	150
Slice 16	381.47428	2,056.6206	0	2,567.7687	499.12367	150
Slice 17	384.42284	2,057.0944	0	2,684.8105	521.8743	150
Slice 18	387.3714	2,057.5681	0	2,801.8524	544.62493	150
Slice 19	390.31996	2,058.0419	0	2,918.8942	567.37555	150
Slice 20	393.26852	2,058.5156	0	3,035.936	590.12618	150
Slice 21	396.21708	2,058.9894	0	3,152.9779	612.87681	150
Slice 22	399.16564	2,059.4631	0	3,270.0197	635.62744	150
Slice 23	400.97346	2,060.1763	0	2,619.1381	509.10888	150
Slice 24	402.78183	2,062.759	0	1,472.0275	1,235.1778	225
Slice 25	405.73149	2,066.9715	0	1,306.9878	1,096.693	225
Slice 26	408.68116	2,071.1841	0	1,141.948	958.20819	225
Slice 27	412.078	2,076.0353	0	1,089.2551	707.37052	200
Slice 28	415.39329	2,080.77	0	830.36721	539.24677	200
Slice 29	418.17987	2,084.7496	0	554.93442	360.37862	200

Slice 30	420.96644	2,088.7293	0	279.50165	181.51049	200
Slice 31	423.75302	2,092.7089	0	4.0688543	2.6423449	200

Section 19 SSA for Skyline Ranch.gsz

Section 19 SSA for Skyline Ranch.gsz Run By: Dr. Alexander Bykovtsev, Ph.D., P.E. 3/25/2016 3:10:06 PM

- Materials**
- TQs 150-17° (A-Bed6°-7°)
 - Shear Layer
 - Fill
 - Tmc 100-25° (A-Bed0°-5°)
 - Tmc 150-17° (A-Bed0°-5°)
 - TQs 100-25° (A-Bed 6°-13°)

Lower Keyway depth 20'
width 50', backcut slope 2H:1V
Upper Keyway depth 10'
Width 25', Backcut Slope 2H:1V

Current Analysis 4 - Translational Lower Clay

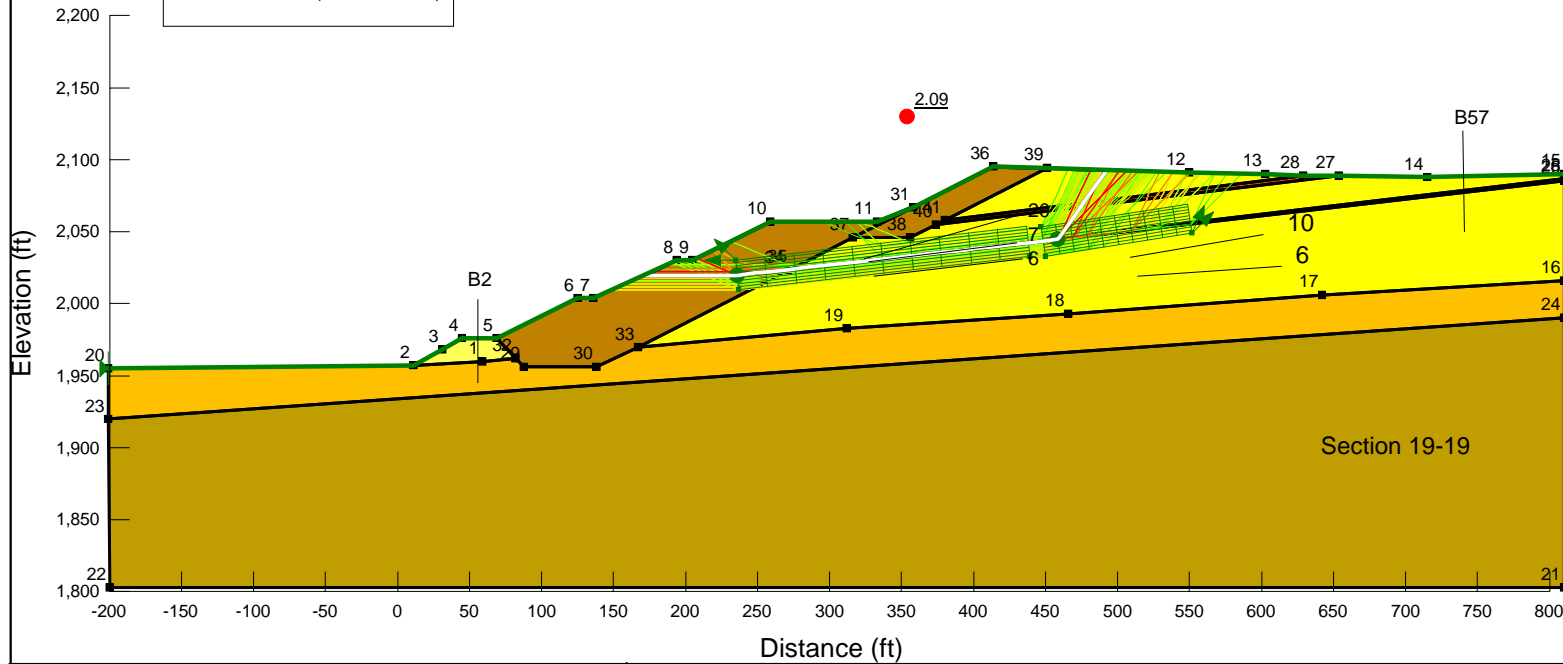

Name: TQs 150-17° (A-Bed6°-7°)
Model: Anisotropic Fn.
Unit Weight: 120 pcf
Cohesion: 225 psf
Phi: 40°
Phi-Anisotropic Strength Fn.: TQs 150-17° (A-Bed6°-7°)
C-Anisotropic Strength Fn.: 150psf-17° (A-Bed6°-7°)

Name: Shear Layer
Model: Mohr-Coulomb
Unit Weight: 120 pcf
Cohesion: 150 psf
Phi: 11°

Name: Fill
Model: Mohr-Coulomb
Unit Weight: 120 pcf
Cohesion: 200 psf
Phi: 33°

Name: Tmc 100-25° (A-Bed0°-5°)
Model: Anisotropic Fn.
Unit Weight: 120 pcf
Cohesion: 200 psf
Phi: 40°
Phi-Anisotropic Strength Fn.: Tmc 100psf-25° (A-Bed0°-5°)
C-Anisotropic Strength Fn.: 100 psf (A-Bed0°-5°)

Name: Tmc 150-17° (A-Bed0°-5°)
Model: Anisotropic Fn.
Unit Weight: 120 pcf
Cohesion: 200 psf
Phi: 40°
Phi-Anisotropic Strength Fn.: Tmc 150-17° (A-Bed0°-5°)
C-Anisotropic Strength Fn.: 150psf-17° (A-Bed0°-5°)

Name: TQs 100-25° (A-Bed 6°-13°)
Model: Anisotropic Fn.
Unit Weight: 120 pcf
Cohesion: 225 psf
Phi: 40°
Phi-Anisotropic Strength Fn.: TQs 100-25° (A-Bed 6°-13°)
C-Anisotropic Strength Fn.: 100psf-25° (A-Bed 6°-13°)

LGC **LGC Valley, Inc**
GEOTECHNICAL CONSULTING
28532 Constellation Road, Valencia, CA 91355
Phone 661-702-8474, Fax 661-702-8475

Skyline Ranch
Development project, Tract 60922
Los Angeles CA

Project No: **153035-01**
Engineer: **BAS**
Date: **March 2016**

4 - Translational Lower Clay

Report generated using GeoStudio 2012. Copyright © 1991-2015 GEO-SLOPE International Ltd.

File Information

File Version: 8.15
 Title: Static Slope Stability Analyses for Skyline Ranch Development project, Tract 60922, Los Angeles CA
 Comments: Run By: Dr. Alexander Bykovtsev, Ph.D., P.E.
 Last Edited By: Alexander Bykovtsev
 Revision Number: 161
 Date: 3/25/2016
 Time: 3:10:06 PM
 Tool Version: 8.15.1.11777
 File Name: Section 19 SSA for Skyline Ranch.gsz
 Directory: G:\SLOPE RESULTS\Section 19-19 results\Latest Update 3-25-16\
 Last Solved Date: 3/25/2016
 Last Solved Time: 3:14:06 PM

Project Settings

Length(L) Units: Feet
 Time(t) Units: Seconds
 Force(F) Units: Pounds
 Pressure(p) Units: psf
 Strength Units: psf
 Unit Weight of Water: 62.4 pcf
 View: 2D
 Element Thickness: 1

Analysis Settings

4 - Translational Lower Clay

Kind: SLOPE/W
 Method: Janbu
 Settings
 PWP Conditions Source: (none)
 Slip Surface
 Direction of movement: Right to Left
 Use Passive Mode: No
 Slip Surface Option: Block
 Critical slip surfaces saved: 1
 Resisting Side Maximum Convex Angle: 1 °
 Driving Side Maximum Convex Angle: 5 °
 Restrict Block Crossing: No
 Optimize Critical Slip Surface Location: No
 Tension Crack

Tension Crack Option: (none)
 F of S Distribution
 F of S Calculation Option: Constant
 Advanced
 Number of Slices: 30
 F of S Tolerance: 0.01
 Minimum Slip Surface Depth: 0.1 ft

Materials

TQs 150-17° (A-Bed6°-7°)

Model: Anisotropic Fn.
 Unit Weight: 120 pcf
 Cohesion': 225 psf
 Phi': 40 °
 Phi-Anisotropic Strength Fn.: TQs 150-17° (A-Bed6°-7°)
 C-Anisotropic Strength Fn.: 150psf-17° (A-Bed6°-7°)
 Phi-B: 0 °

Shear Layer

Model: Mohr-Coulomb
 Unit Weight: 120 pcf
 Cohesion': 150 psf
 Phi': 11 °
 Phi-B: 0 °

Fill

Model: Mohr-Coulomb
 Unit Weight: 120 pcf
 Cohesion': 200 psf
 Phi': 33 °
 Phi-B: 0 °

Tmc 100-25° (A-Bed0°-5°)

Model: Anisotropic Fn.
 Unit Weight: 120 pcf
 Cohesion': 200 psf
 Phi': 40 °
 Phi-Anisotropic Strength Fn.: Tmc 100psf-25° (A-Bed0°-5°)
 C-Anisotropic Strength Fn.: 100 psf (A-Bed0°-5°)
 Phi-B: 0 °

Tmc 150-17° (A-Bed0°-5°)

Model: Anisotropic Fn.
 Unit Weight: 120 pcf
 Cohesion': 200 psf
 Phi': 40 °
 Phi-Anisotropic Strength Fn.: Tmc 150-17° (A-Bed0°-5°)
 C-Anisotropic Strength Fn.: 150psf-17° (A-Bed0°-5°)

Phi-B: 0 °

TQs 100-25° (A-Bed 6°-13°)

Model: [Anisotropic Fn.](#)

Unit Weight: 120 pcf

Cohesion: 225 psf

Phi: 40 °

Phi-Anisotropic Strength Fn.: TQs 100-25° (A-Bed 6°-13°)

C-Anisotropic Strength Fn.: 100psf-25° (A-Bed 6°-13°)

Phi-B: 0 °

Slip Surface Limits

Left Coordinate: (-201, 1,955) ft

Right Coordinate: (810, 2,090) ft

Slip Surface Block

Left Grid

Upper Left: (235, 2,030.1838) ft

Lower Left: (237, 2,009.5966) ft

Lower Right: (439, 2,033) ft

X Increments: 10

Y Increments: 10

Starting Angle: 135 °

Ending Angle: 180 °

Angle Increments: 2

Right Grid

Upper Left: (447, 2,053) ft

Lower Left: (450, 2,033) ft

Lower Right: (552, 2,049) ft

X Increments: 10

Y Increments: 10

Starting Angle: 45 °

Ending Angle: 65 °

Angle Increments: 2

Seismic Coefficients

Horz Seismic Coef.: 0

Vert Seismic Coef.: 0

Anisotropic Strength Functions

150psf-17° (A-Bed6°-7°)

Model: [Spline Data Point Function](#)

Function: [Modifier Factor vs. Inclination](#)

Curve Fit to Data: 100 %

Segment Curvature: 0 %

Y-Intercept: 1

Data Points: [Inclination \(°\), Modifier Factor](#)

Data Point: (-90, 1)

Data Point: (5.9, 1)

Data Point: (6, 0.75)

Data Point: (7, 0.75)

Data Point: (7.1, 1)

TQs 150-17° (A-Bed6°-7°)

Model: [Spline Data Point Function](#)

Function: [Modifier Factor vs. Inclination](#)

Curve Fit to Data: 100 %

Segment Curvature: 0 %

Y-Intercept: 1

Data Points: [Inclination \(°\), Modifier Factor](#)

Data Point: (-90, 1)

Data Point: (5.9, 1)

Data Point: (6, 0.425)

Data Point: (7, 0.425)

Data Point: (7.1, 1)

TQs 100-25° (A-Bed 6°-13°)

Model: [Spline Data Point Function](#)

Function: [Modifier Factor vs. Inclination](#)

Curve Fit to Data: 100 %

Segment Curvature: 0 %

Y-Intercept: 1

Data Points: [Inclination \(°\), Modifier Factor](#)

Data Point: (-90, 1)

Data Point: (5.9, 1)

Data Point: (6, 0.625)

Data Point: (13, 0.625)

Data Point: (13.1, 1)

100 psf (A-Bed0°-5°)

Model: [Spline Data Point Function](#)

Function: [Modifier Factor vs. Inclination](#)

Curve Fit to Data: 100 %

Segment Curvature: 0 %

Y-Intercept: 0.5

Data Points: [Inclination \(°\), Modifier Factor](#)

Data Point: (-90, 1)

Data Point: (-0.9, 1)

Data Point: (0, 0.5)

Data Point: (5, 0.5)

Data Point: (5.1, 1)

Tmc 100psf-25° (A-Bed0°-5°)

Model: [Spline Data Point Function](#)

Function: **Modifier Factor vs. Inclination**

Curve Fit to Data: 100 %

Segment Curvature: 0 %

Y-Intercept: 0.625

Data Points: **Inclination (°), Modifier Factor**

Data Point: (-90, 1)

Data Point: (-0.9, 1)

Data Point: (0, 0.625)

Data Point: (5, 0.625)

Data Point: (5.1, 1)

150psf-17° (A-Bed0°-5°)

Model: **Spline Data Point Function**

Function: **Modifier Factor vs. Inclination**

Curve Fit to Data: 100 %

Segment Curvature: 0 %

Y-Intercept: 0.75

Data Points: **Inclination (°), Modifier Factor**

Data Point: (-90, 1)

Data Point: (-0.9, 1)

Data Point: (0, 0.75)

Data Point: (5, 0.75)

Data Point: (5.1, 1)

Tmc 150-17° (A-Bed0°-5°)

Model: **Spline Data Point Function**

Function: **Modifier Factor vs. Inclination**

Curve Fit to Data: 100 %

Segment Curvature: 0 %

Y-Intercept: 0.425

Data Points: **Inclination (°), Modifier Factor**

Data Point: (-90, 1)

Data Point: (-0.9, 1)

Data Point: (0, 0.425)

Data Point: (5, 0.425)

Data Point: (5.1, 1)

100psf-25° (A-Bed 6°-13°)

Model: **Spline Data Point Function**

Function: **Modifier Factor vs. Inclination**

Curve Fit to Data: 100 %

Segment Curvature: 0 %

Y-Intercept: 1

Data Points: **Inclination (°), Modifier Factor**

Data Point: (-90, 1)

Data Point: (5.9, 1)

Data Point: (6, 0.444)

Data Point: (13, 0.444)

Data Point: (13.1, 1)

Points

	X (ft)	Y (ft)
Point 1	59	1,960
Point 2	11	1,957
Point 3	31	1,968
Point 4	45	1,976
Point 5	69	1,976
Point 6	125	2,004
Point 7	136	2,004
Point 8	194	2,030
Point 9	205	2,030
Point 10	259	2,057
Point 11	333	2,057
Point 12	550	2,091
Point 13	603	2,090
Point 14	715	2,088
Point 15	810	2,090
Point 16	810	2,016
Point 17	642	2,006
Point 18	466	1,993
Point 19	312	1,983
Point 20	-201	1,955
Point 21	810	1,803
Point 22	-200	1,803
Point 23	-200.75	1,920
Point 24	810	1,990
Point 25	810	2,087
Point 26	810	2,085
Point 27	654	2,089.0893
Point 28	629	2,089
Point 29	88	1,956
Point 30	138	1,956
Point 31	358	2,067
Point 32	82.1967	1,962.1088
Point 33	167	1,970
Point 34	271	2,023
Point 35	273	2,024
Point 36	414	2,095
Point 37	316	2,045.9574
Point 38	356	2,046
Point 39	451	2,094
Point 40	374	2,055
Point 41	380	2,058

Regions

	Material	Points	Area (ft²)
Region 1	Tmc 100-25° (A-Bed0°-5°)	20,23,24,16,17,18,19,33,30,29,32,1,2	26,270
Region 2	Tmc 150-17° (A-Bed0°-5°)	23,22,21,24	1.5359e+005
Region 3	TQs 150-17° (A-Bed6°-7°)	19,18,17,16,26,34,33	32,238
Region 4	Shear Layer	26,25,35,34	744.5
Region 5	TQs 150-17° (A-Bed6°-7°)	15,14,27,40,38,37,35,25	8,477.5
Region 6	TQs 150-17° (A-Bed6°-7°)	13,12,39,41,28	3,375.5
Region 7	Shear Layer	27,28,41,40	694.11
Region 8	TQs 100-25° (A-Bed 6°-13°)	2,1,32,5,4,3	769.03
Region 9	Fill	5,32,29,30,33,34,35,37,31,11,10,9,8,7,6	9,276.8
Region 10	Fill	37,38,40,41,39,36,31	1,921.5

Current Slip Surface

Slip Surface: 60,791
 F of S: 2.09
 Volume: 10,128.773 ft³
 Weight: 1,215,452.8 lbs
 Resisting Force: 419,685.86 lbs
 Activating Force: 201,121.49 lbs
 F of S Rank (Analysis): 1 of 131,769 slip surfaces
 F of S Rank (Query): 1 of 300 slip surfaces
 Exit: (171.44737, 2,019.8902) ft
 Entry: (492.41156, 2,092.7451) ft
 Radius: 143.01965 ft
 Center: (319.5266, 2,110.9588) ft

Slip Slices

	X (ft)	Y (ft)	PWP (psf)	Base Normal Stress (psf)	Frictional Strength (psf)	Cohesive Strength (psf)
Slice 1	177.08553	2,019.8902	0	303.294	196.96143	200
Slice 2	188.36184	2,019.8902	0	909.882	590.88428	200
Slice 3	199.5	2,019.8902	0	1,213.176	787.84571	200
Slice 4	210.16667	2,019.8902	0	1,523.176	989.16206	200
Slice 5	220.5	2,019.8902	0	2,143.176	1,391.7948	200
Slice 6	230.83333	2,019.8902	0	2,763.176	1,794.4275	200
Slice 7	241.75	2,020.5282	0	3,219.6852	2,090.888	200
Slice 8	253.25	2,021.8042	0	3,738.6295	2,427.8944	200

Slice 9	265.99429	2,023.2182	0	3,908.0864	2,537.941	200
Slice 10	278.36929	2,024.5913	0	3,841.3179	746.67656	150
Slice 11	289.125	2,025.7847	0	3,699.5756	719.12465	150
Slice 12	299.875	2,026.9775	0	3,557.9086	691.58738	150
Slice 13	310.625	2,028.1703	0	3,416.2416	664.0501	150
Slice 14	320.25	2,029.2382	0	3,289.4003	639.39464	150
Slice 15	328.75	2,030.1813	0	3,177.3845	617.62098	150
Slice 16	338.75	2,031.2909	0	3,318.775	645.10452	150
Slice 17	350.25	2,032.5669	0	3,713.5719	721.84525	150
Slice 18	357	2,033.3158	0	3,945.3005	766.88873	150
Slice 19	366	2,034.3144	0	4,349.2889	845.41612	150
Slice 20	377	2,035.5349	0	4,857.569	944.21577	150
Slice 21	385.66667	2,036.4965	0	5,258.0321	1,022.0579	150
Slice 22	397	2,037.754	0	5,781.7147	1,123.8515	150
Slice 23	408.33333	2,039.0115	0	6,305.3972	1,225.6451	150
Slice 24	420.16667	2,040.3245	0	6,466.1769	1,256.8975	150
Slice 25	432.5	2,041.693	0	6,264.0539	1,217.6087	150
Slice 26	444.83333	2,043.0614	0	6,061.9308	1,178.32	150
Slice 27	454.85	2,044.1728	0	5,896.2761	1,146.12	150
Slice 28	459.1524	2,045.2461	0	5,046.1015	980.86276	150
Slice 29	467.07953	2,056.5672	0	2,717.3001	2,280.0855	225
Slice 30	475.52445	2,068.6278	0	2,517.4828	489.34909	150
Slice 31	484.45311	2,081.3792	0	786.55519	659.99817	225

Section 19 SSA for Skyline Ranch.gsz

Section 19 SSA for Skyline Ranch.gsz Run By: Dr. Alexander Bykovtsev, Ph.D., P.E. 3/25/2016 3:10:06 PM

- Materials**
- TQs 150-17° (A-Bed6°-7°)
 - Shear Layer
 - Fill
 - Tmc 100-25° (A-Bed0°-5°)
 - Tmc 150-17° (A-Bed0°-5°)
 - TQs 100-25° (A-Bed 6°-13°)

Lower Keyway depth 20'
width 50', backcut slope 2H:1V
Upper Keyway depth 10'
Width 25', Backcut Slope 2H:1V

Current Analysis 4 - Translational Lower Clay Seismic

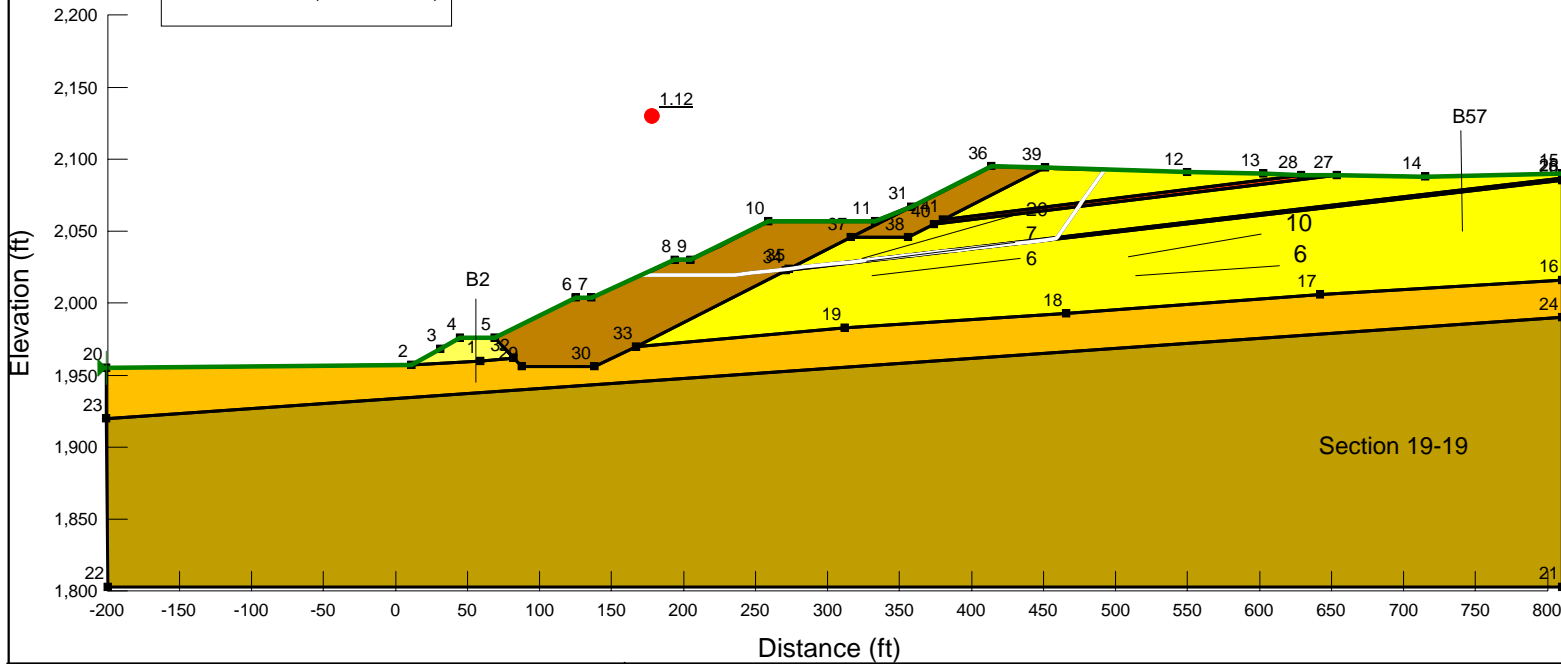

Name: TQs 150-17° (A-Bed6°-7°)
Model: Anisotropic Fn.
Unit Weight: 120 pcf
Cohesion: 225 psf
Phi: 40 °
Phi-Anisotropic Strength Fn.: TQs 150-17° (A-Bed6°-7°)
C-Anisotropic Strength Fn.: 150psf-17° (A-Bed6°-7°)

Name: Shear Layer
Model: Mohr-Coulomb
Unit Weight: 120 pcf
Cohesion: 150 psf
Phi: 11 °

Name: Fill
Model: Mohr-Coulomb
Unit Weight: 120 pcf
Cohesion: 200 psf
Phi: 33 °

Name: Tmc 100-25° (A-Bed0°-5°)
Model: Anisotropic Fn.
Unit Weight: 120 pcf
Cohesion: 200 psf
Phi: 40 °
Phi-Anisotropic Strength Fn.: Tmc 100psf-25° (A-Bed0°-5°)
C-Anisotropic Strength Fn.: 100 psf (A-Bed0°-5°)

Name: Tmc 150-17° (A-Bed0°-5°)
Model: Anisotropic Fn.
Unit Weight: 120 pcf
Cohesion: 200 psf
Phi: 40 °
Phi-Anisotropic Strength Fn.: Tmc 150-17° (A-Bed0°-5°)
C-Anisotropic Strength Fn.: 150psf-17° (A-Bed0°-5°)

Name: TQs 100-25° (A-Bed 6°-13°)
Model: Anisotropic Fn.
Unit Weight: 120 pcf
Cohesion: 225 psf
Phi: 40 °
Phi-Anisotropic Strength Fn.: TQs 100-25° (A-Bed 6°-13°)
C-Anisotropic Strength Fn.: 100psf-25° (A-Bed 6°-13°)



LGC Valley, Inc
GEOTECHNICAL CONSULTING

28532 Constellation Road, Valencia, CA 91355
Phone 661-702-8474, Fax 661-702-8475

Skyline Ranch
Development project, Tract 60922
Los Angeles CA

Project No: **153035-01**
Engineer: **BAS**
Date: **March 2016**

4 - Translational Lower Clay Seismic

Report generated using GeoStudio 2012. Copyright © 1991-2015 GEO-SLOPE International Ltd.

File Information

File Version: 8.15
 Title: Static Slope Stability Analyses for Skyline Ranch Development project, Tract 60922, Los Angeles CA
 Comments: Run By: Dr. Alexander Bykovtsev, Ph.D., P.E.
 Last Edited By: Alexander Bykovtsev
 Revision Number: 161
 Date: 3/25/2016
 Time: 3:10:06 PM
 Tool Version: 8.15.1.11777
 File Name: Section 19 SSA for Skyline Ranch.gsz
 Directory: G:\SLOPE RESULTS\Section 19-19 results\Latest Update 3-25-16\
 Last Solved Date: 3/25/2016
 Last Solved Time: 3:14:40 PM

Project Settings

Length(L) Units: Feet
 Time(t) Units: Seconds
 Force(F) Units: Pounds
 Pressure(p) Units: psf
 Strength Units: psf
 Unit Weight of Water: 62.4 pcf
 View: 2D
 Element Thickness: 1

Analysis Settings

4 - Translational Lower Clay Seismic

Kind: SLOPE/W
 Parent: 4 - Translational Lower Clay
 Method: Janbu
 Settings
 PWP Conditions Source: (none)
 Initial Slip Surface Source: Parent Analysis
 Slip Surface
 Direction of movement: Right to Left
 Use Passive Mode: No
 Slip Surface Option: Critical Slip Surfaces from Other
 Critical slip surfaces saved: 1
 Resisting Side Maximum Convex Angle: 1 °
 Driving Side Maximum Convex Angle: 5 °
 Optimize Critical Slip Surface Location: No

file:///G:/SLOPE%20RESULTS/Section%2019-19%20results/Latest%20Update%203-25-... 3/25/2016

Tension Crack
 Tension Crack Option: (none)
 F of S Distribution
 F of S Calculation Option: Constant
 Advanced
 Number of Slices: 30
 F of S Tolerance: 0.01
 Minimum Slip Surface Depth: 0.1 ft

Materials

TQs 150-17° (A-Bed6°-7°)

Model: Anisotropic Fn.
 Unit Weight: 120 pcf
 Cohesion': 225 psf
 Phi': 40 °
 Phi-Anisotropic Strength Fn.: TQs 150-17° (A-Bed6°-7°)
 C-Anisotropic Strength Fn.: 150psf-17° (A-Bed6°-7°)
 Phi-B: 0 °

Shear Layer

Model: Mohr-Coulomb
 Unit Weight: 120 pcf
 Cohesion': 150 psf
 Phi': 11 °
 Phi-B: 0 °

Fill

Model: Mohr-Coulomb
 Unit Weight: 120 pcf
 Cohesion': 200 psf
 Phi': 33 °
 Phi-B: 0 °

Tmc 100-25° (A-Bed0°-5°)

Model: Anisotropic Fn.
 Unit Weight: 120 pcf
 Cohesion': 200 psf
 Phi': 40 °
 Phi-Anisotropic Strength Fn.: Tmc 100psf-25° (A-Bed0°-5°)
 C-Anisotropic Strength Fn.: 100 psf (A-Bed0°-5°)
 Phi-B: 0 °

Tmc 150-17° (A-Bed0°-5°)

Model: Anisotropic Fn.
 Unit Weight: 120 pcf
 Cohesion': 200 psf
 Phi': 40 °
 Phi-Anisotropic Strength Fn.: Tmc 150-17° (A-Bed0°-5°)

file:///G:/SLOPE%20RESULTS/Section%2019-19%20results/Latest%20Update%203-25-... 3/25/2016

C-Anisotropic Strength Fn.: 150psf-17° (A-Bed0°-5°)
Phi-B: 0°

TQs 100-25° (A-Bed 6°-13°)

Model: Anisotropic Fn.
Unit Weight: 120 pcf
Cohesion': 225 psf
Phi': 40°
Phi-Anisotropic Strength Fn.: TQs 100-25° (A-Bed 6°-13°)
C-Anisotropic Strength Fn.: 100psf-25° (A-Bed 6°-13°)
Phi-B: 0°

Slip Surface Limits

Left Coordinate: (-201, 1,955) ft
Right Coordinate: (810, 2,090) ft

Seismic Coefficients

Horz Seismic Coef.: 0.15
Vert Seismic Coef.: 0

Anisotropic Strength Functions

150psf-17° (A-Bed6°-7°)

Model: Spline Data Point Function
Function: Modifier Factor vs. Inclination
Curve Fit to Data: 100 %
Segment Curvature: 0 %
Y-Intercept: 1
Data Points: Inclination (°), Modifier Factor
Data Point: (-90, 1)
Data Point: (5.9, 1)
Data Point: (6, 0.75)
Data Point: (7, 0.75)
Data Point: (7.1, 1)

TQs 150-17° (A-Bed6°-7°)

Model: Spline Data Point Function
Function: Modifier Factor vs. Inclination
Curve Fit to Data: 100 %
Segment Curvature: 0 %
Y-Intercept: 1
Data Points: Inclination (°), Modifier Factor
Data Point: (-90, 1)
Data Point: (5.9, 1)
Data Point: (6, 0.425)
Data Point: (7, 0.425)

Data Point: (7.1, 1)

TQs 100-25° (A-Bed 6°-13°)

Model: Spline Data Point Function
Function: Modifier Factor vs. Inclination
Curve Fit to Data: 100 %
Segment Curvature: 0 %
Y-Intercept: 1
Data Points: Inclination (°), Modifier Factor
Data Point: (-90, 1)
Data Point: (5.9, 1)
Data Point: (6, 0.625)
Data Point: (13, 0.625)
Data Point: (13.1, 1)

100 psf (A-Bed0°-5°)

Model: Spline Data Point Function
Function: Modifier Factor vs. Inclination
Curve Fit to Data: 100 %
Segment Curvature: 0 %
Y-Intercept: 0.5
Data Points: Inclination (°), Modifier Factor
Data Point: (-90, 1)
Data Point: (-0.9, 1)
Data Point: (0, 0.5)
Data Point: (5, 0.5)
Data Point: (5.1, 1)

Tmc 100psf-25° (A-Bed0°-5°)

Model: Spline Data Point Function
Function: Modifier Factor vs. Inclination
Curve Fit to Data: 100 %
Segment Curvature: 0 %
Y-Intercept: 0.625
Data Points: Inclination (°), Modifier Factor
Data Point: (-90, 1)
Data Point: (-0.9, 1)
Data Point: (0, 0.625)
Data Point: (5, 0.625)
Data Point: (5.1, 1)

150psf-17° (A-Bed0°-5°)

Model: Spline Data Point Function
Function: Modifier Factor vs. Inclination
Curve Fit to Data: 100 %
Segment Curvature: 0 %
Y-Intercept: 0.75
Data Points: Inclination (°), Modifier Factor
Data Point: (-90, 1)
Data Point: (-0.9, 1)

Data Point: (0, 0.75)
 Data Point: (5, 0.75)
 Data Point: (5.1, 1)

Tmc 150-17° (A-Bed0°-5°)

Model: Spline Data Point Function
 Function: Modifier Factor vs. Inclination
 Curve Fit to Data: 100 %
 Segment Curvature: 0 %
 Y-Intercept: 0.425
 Data Points: Inclination (°), Modifier Factor
 Data Point: (-90, 1)
 Data Point: (-0.9, 1)
 Data Point: (0, 0.425)
 Data Point: (5, 0.425)
 Data Point: (5.1, 1)

100psf-25° (A-Bed 6°-13°)

Model: Spline Data Point Function
 Function: Modifier Factor vs. Inclination
 Curve Fit to Data: 100 %
 Segment Curvature: 0 %
 Y-Intercept: 1
 Data Points: Inclination (°), Modifier Factor
 Data Point: (-90, 1)
 Data Point: (5.9, 1)
 Data Point: (6, 0.444)
 Data Point: (13, 0.444)
 Data Point: (13.1, 1)

Points

	X (ft)	Y (ft)
Point 1	59	1,960
Point 2	11	1,957
Point 3	31	1,968
Point 4	45	1,976
Point 5	69	1,976
Point 6	125	2,004
Point 7	136	2,004
Point 8	194	2,030
Point 9	205	2,030
Point 10	259	2,057
Point 11	333	2,057
Point 12	550	2,091
Point 13	603	2,090
Point 14	715	2,088
Point 15	810	2,090

Point 16	810	2,016
Point 17	642	2,006
Point 18	466	1,993
Point 19	312	1,983
Point 20	-201	1,955
Point 21	810	1,803
Point 22	-200	1,803
Point 23	-200.75	1,920
Point 24	810	1,990
Point 25	810	2,087
Point 26	810	2,085
Point 27	654	2,089.0893
Point 28	629	2,089
Point 29	88	1,956
Point 30	138	1,956
Point 31	358	2,067
Point 32	82.1967	1,962.1088
Point 33	167	1,970
Point 34	271	2,023
Point 35	273	2,024
Point 36	414	2,095
Point 37	316	2,045.9574
Point 38	356	2,046
Point 39	451	2,094

Point 40	374	2,055
Point 41	380	2,058

Regions

	Material	Points	Area (ft ²)
Region 1	Tmc 100-25° (A-Bed0°-5°)	20,23,24,16,17,18,19,33,30,29,32,1,2	26,270
Region 2	Tmc 150-17° (A-Bed0°-5°)	23,22,21,24	1.5359e+005
Region 3	TQs 150-17° (A-Bed6°-7°)	19,18,17,16,26,34,33	32,238
Region 4	Shear Layer	26,25,35,34	744.5
Region 5	TQs 150-17° (A-Bed6°-7°)	15,14,27,40,38,37,35,25	8,477.5
Region 6	TQs 150-17° (A-Bed6°-7°)	13,12,39,41,28	3,375.5
Region 7	Shear Layer	27,28,41,40	694.11
Region 8	TQs 100-25° (A-Bed 6°-13°)	2,1,32,5,4,3	769.03
Region 9	Fill	5,32,29,30,33,34,35,37,31,11,10,9,8,7,6	9,276.8
Region 10	Fill	37,38,40,41,39,36,31	1,921.5

Current Slip Surface

Slip Surface: 1
 F of S: 1.12
 Volume: 10,128.773 ft³
 Weight: 1,215,452.8 lbs
 Resisting Force: 402,601.72 lbs
 Activating Force: 359,261.89 lbs
 F of S Rank (Analysis): 1 of 1 slip surfaces
 F of S Rank (Query): 1 of 1 slip surfaces
 Exit: (171.44737, 2,019.8902) ft
 Entry: (492.41156, 2,092.7451) ft
 Radius: 143.01965 ft
 Center: (319.5266, 2,110.9588) ft

Slip Slices

	X (ft)	Y (ft)	PWP (psf)	Base Normal Stress (psf)	Frictional Strength (psf)	Cohesive Strength (psf)
Slice 1	177.08553	2,019.8902	0	303.294	196.96143	200
Slice 2	188.36184	2,019.8902	0	909.882	590.88428	200
Slice 3	199.5	2,019.8902	0	1,213.176	787.84571	200
Slice 4	210.16667	2,019.8902	0	1,523.176	989.16206	200
Slice 5	220.5	2,019.8902	0	2,143.176	1,391.7948	200

Slice 6	230.83333	2,019.8902	0	2,763.176	1,794.4275	200
Slice 7	241.75	2,020.5282	0	3,119.8364	2,026.0455	200
Slice 8	253.25	2,021.8042	0	3,624.0923	2,353.513	200
Slice 9	265.99429	2,023.2182	0	3,788.7528	2,460.4448	200
Slice 10	278.36929	2,024.5913	0	3,800.4981	738.74199	150
Slice 11	289.125	2,025.7847	0	3,660.0101	711.43389	150
Slice 12	299.875	2,026.9775	0	3,519.5966	684.14027	150
Slice 13	310.625	2,028.1703	0	3,379.1832	656.84667	150
Slice 14	320.25	2,029.2382	0	3,253.4642	632.40938	150
Slice 15	328.75	2,030.1813	0	3,142.4397	610.8284	150
Slice 16	338.75	2,031.2909	0	3,282.5791	638.06873	150
Slice 17	350.25	2,032.5669	0	3,673.8825	714.13042	150
Slice 18	357	2,033.3158	0	3,903.5601	758.77522	150
Slice 19	366	2,034.3144	0	4,303.9741	836.60782	150
Slice 20	377	2,035.5349	0	4,807.7564	934.53317	150
Slice 21	385.66667	2,036.4965	0	5,204.6759	1,011.6865	150
Slice 22	397	2,037.754	0	5,723.7245	1,112.5793	150
Slice 23	408.33333	2,039.0115	0	6,242.773	1,213.4722	150
Slice 24	420.16667	2,040.3245	0	6,402.13	1,244.448	150
Slice 25	432.5	2,041.693	0	6,201.7955	1,205.5069	150
Slice 26	444.83333	2,043.0614	0	6,001.4611	1,166.5659	150
Slice 27	454.85	2,044.1728	0	5,837.2721	1,134.6508	150
Slice 28	459.1524	2,045.2461	0	4,505.4158	875.76412	150
Slice 29	467.07953	2,056.5672	0	1,996.5612	1,675.3138	225

Slice 30	475.52445	2,068.6278	0	2,211.7987	429.93011	150
Slice 31	484.45311	2,081.3792	0	531.9321	446.34403	225

Section 19 SSA for Skyline Ranch.gsz

Section 19 SSA for Skyline Ranch.gsz Run By: Dr. Alexander Bykovtsev, Ph.D., P.E. 3/25/2016 2:28:52 PM

Materials

- TQs 150-17° (A-Bed6°-7°)
- Shear Layer
- Tmc 100-25° (A-Bed0°-5°)
- Tmc 150-17° (A-Bed0°-5°)
- TQs 100-25° (A-Bed 6°-13°)

Lower Keyway depth 20'
width 50', backcut slope 2H:1V
Upper Keyway depth 10'
Width 25', Backcut Slope 2H:1V

Current Analysis

5 - Translational Temporary upper clay

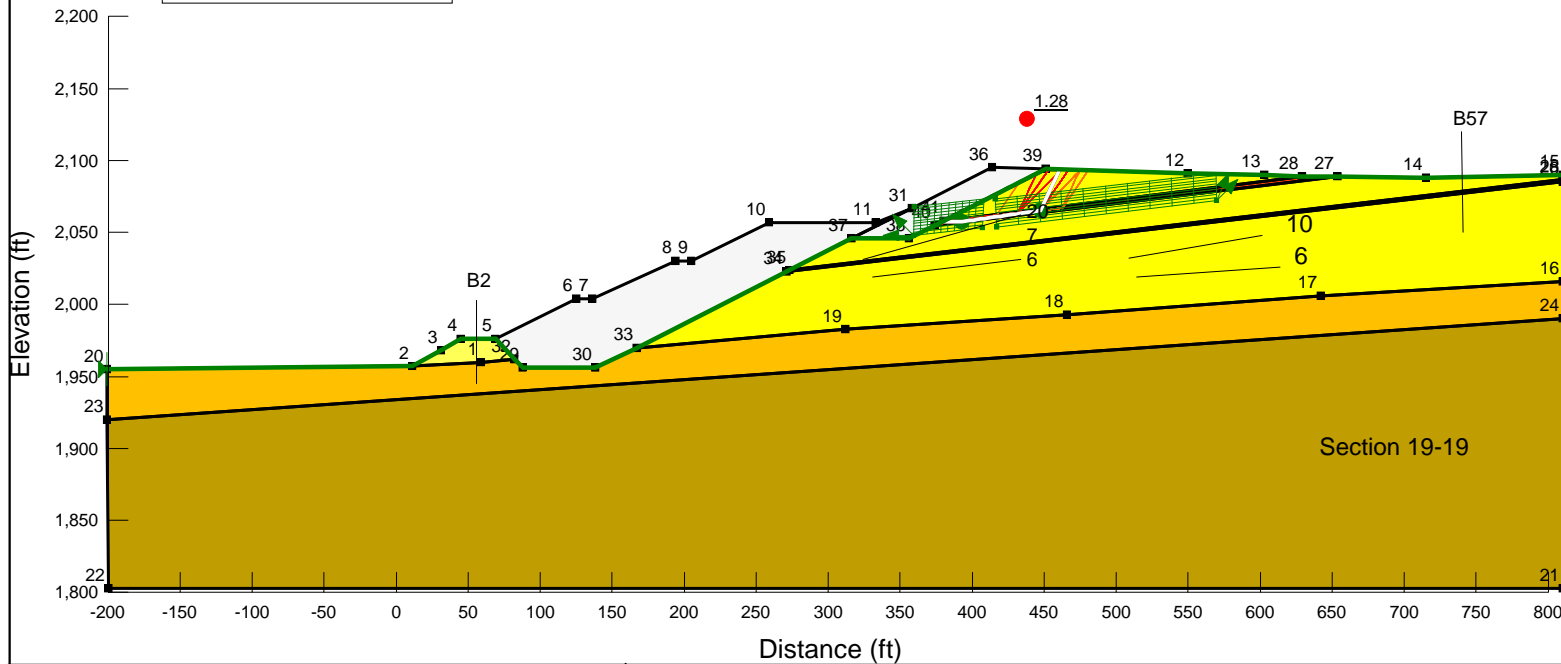

Name: TQs 150-17° (A-Bed6°-7°)
Model: Anisotropic Fn.
Unit Weight: 120 pcf
Cohesion: 225 psf
Phi: 40 °
Phi-Anisotropic Strength Fn.: TQs 150-17° (A-Bed6°-7°)
C-Anisotropic Strength Fn.: 150psf-17° (A-Bed6°-7°)

Name: Shear Layer
Model: Mohr-Coulomb
Unit Weight: 120 pcf
Cohesion: 150 psf
Phi: 11 °

Name: Tmc 100-25° (A-Bed0°-5°)
Model: Anisotropic Fn.
Unit Weight: 120 pcf
Cohesion: 200 psf
Phi: 40 °
Phi-Anisotropic Strength Fn.: Tmc 100psf-25° (A-Bed0°-5°)
C-Anisotropic Strength Fn.: 100 psf (A-Bed0°-5°)

Name: Tmc 150-17° (A-Bed0°-5°)
Model: Anisotropic Fn.
Unit Weight: 120 pcf
Cohesion: 200 psf
Phi: 40 °
Phi-Anisotropic Strength Fn.: Tmc 150-17° (A-Bed0°-5°)
C-Anisotropic Strength Fn.: 150psf-17° (A-Bed0°-5°)

Name: TQs 100-25° (A-Bed 6°-13°)
Model: Anisotropic Fn.
Unit Weight: 120 pcf
Cohesion: 225 psf
Phi: 40 °
Phi-Anisotropic Strength Fn.: TQs 100-25° (A-Bed 6°-13°)
C-Anisotropic Strength Fn.: 100psf-25° (A-Bed 6°-13°)



LGC Valley, Inc
GEOTECHNICAL CONSULTING

28532 Constellation Road, Valencia, CA 91355
Phone 661-702-8474, Fax 661-702-8475

Skyline Ranch
Development project, Tract 60922
Los Angeles CA

Project No: **153035-01**
Engineer: **BAS**
Date: **March 2016**

5 - Translational Temporary upper clay

Report generated using GeoStudio 2012. Copyright © 1991-2015 GEO-SLOPE International Ltd.

File Information

File Version: 8.15
 Title: Static Slope Stability Analyses for Skyline Ranch Development project, Tract 60922, Los Angeles CA
 Comments: Run By: Dr. Alexander Bykovtsev, Ph.D., P.E.
 Last Edited By: Alexander Bykovtsev
 Revision Number: 159
 Date: 3/25/2016
 Time: 2:28:52 PM
 Tool Version: 8.15.1.11777
 File Name: Section 19 SSA for Skyline Ranch.gsz
 Directory: G:\SLOPE RESULTS\Section 19-19 results\Latest Update 3-25-16\
 Last Solved Date: 3/25/2016
 Last Solved Time: 2:29:16 PM

Project Settings

Length(L) Units: Feet
 Time(t) Units: Seconds
 Force(F) Units: Pounds
 Pressure(p) Units: psf
 Strength Units: psf
 Unit Weight of Water: 62.4 pcf
 View: 2D
 Element Thickness: 1

Analysis Settings

5 - Translational Temporary upper clay

Kind: SLOPE/W
 Method: Janbu
 Settings
 PWP Conditions Source: (none)
 Slip Surface
 Direction of movement: Right to Left
 Use Passive Mode: No
 Slip Surface Option: Block
 Critical slip surfaces saved: 1
 Resisting Side Maximum Convex Angle: 1 °
 Driving Side Maximum Convex Angle: 5 °
 Restrict Block Crossing: No
 Optimize Critical Slip Surface Location: No
 Tension Crack

Tension Crack Option: (none)
 F of S Distribution
 F of S Calculation Option: Constant
 Advanced
 Number of Slices: 30
 F of S Tolerance: 0.01
 Minimum Slip Surface Depth: 0.1 ft

Materials

TQs 150-17° (A-Bed6°-7°)

Model: Anisotropic Fn.
 Unit Weight: 120 pcf
 Cohesion': 225 psf
 Phi': 40 °
 Phi-Anisotropic Strength Fn.: TQs 150-17° (A-Bed6°-7°)
 C-Anisotropic Strength Fn.: 150psf-17° (A-Bed6°-7°)
 Phi-B: 0 °

Shear Layer

Model: Mohr-Coulomb
 Unit Weight: 120 pcf
 Cohesion': 150 psf
 Phi': 11 °
 Phi-B: 0 °

Tmc 100-25° (A-Bed0°-5°)

Model: Anisotropic Fn.
 Unit Weight: 120 pcf
 Cohesion': 200 psf
 Phi': 40 °
 Phi-Anisotropic Strength Fn.: Tmc 100psf-25° (A-Bed0°-5°)
 C-Anisotropic Strength Fn.: 100 psf (A-Bed0°-5°)
 Phi-B: 0 °

Tmc 150-17° (A-Bed0°-5°)

Model: Anisotropic Fn.
 Unit Weight: 120 pcf
 Cohesion': 200 psf
 Phi': 40 °
 Phi-Anisotropic Strength Fn.: Tmc 150-17° (A-Bed0°-5°)
 C-Anisotropic Strength Fn.: 150psf-17° (A-Bed0°-5°)
 Phi-B: 0 °

TQs 100-25° (A-Bed 6°-13°)

Model: Anisotropic Fn.
 Unit Weight: 120 pcf
 Cohesion': 225 psf
 Phi': 40 °

Phi-Anisotropic Strength Fn.: TQs 100-25° (A-Bed 6°-13°)
 C-Anisotropic Strength Fn.: 100psf-25° (A-Bed 6°-13°)
 Phi-B: 0°

Slip Surface Limits

Left Coordinate: (-201, 1,955) ft
 Right Coordinate: (810, 2,090) ft

Slip Surface Block

Left Grid

Upper Left: (360, 2,068) ft
 Lower Left: (359, 2,048) ft
 Lower Right: (407, 2,053) ft
 X Increments: 10
 Y Increments: 10
 Starting Angle: 135°
 Ending Angle: 180°
 Angle Increments: 2

Right Grid

Upper Left: (416, 2,073) ft
 Lower Left: (417, 2,054) ft
 Lower Right: (570, 2,072) ft
 X Increments: 10
 Y Increments: 10
 Starting Angle: 45°
 Ending Angle: 65°
 Angle Increments: 2

Seismic Coefficients

Horz Seismic Coef.: 0
 Vert Seismic Coef.: 0

Anisotropic Strength Functions

150psf-17° (A-Bed6°-7°)

Model: Spline Data Point Function
 Function: Modifier Factor vs. Inclination
 Curve Fit to Data: 100 %
 Segment Curvature: 0 %
 Y-Intercept: 1
 Data Points: Inclination (°), Modifier Factor
 Data Point: (-90, 1)
 Data Point: (5.9, 1)
 Data Point: (6, 0.75)
 Data Point: (7, 0.75)

Data Point: (7.1, 1)

TQs 150-17° (A-Bed6°-7°)

Model: Spline Data Point Function
 Function: Modifier Factor vs. Inclination
 Curve Fit to Data: 100 %
 Segment Curvature: 0 %
 Y-Intercept: 1
 Data Points: Inclination (°), Modifier Factor
 Data Point: (-90, 1)
 Data Point: (5.9, 1)
 Data Point: (6, 0.425)
 Data Point: (7, 0.425)
 Data Point: (7.1, 1)

TQs 100-25° (A-Bed 6°-13°)

Model: Spline Data Point Function
 Function: Modifier Factor vs. Inclination
 Curve Fit to Data: 100 %
 Segment Curvature: 0 %
 Y-Intercept: 1
 Data Points: Inclination (°), Modifier Factor
 Data Point: (-90, 1)
 Data Point: (5.9, 1)
 Data Point: (6, 0.625)
 Data Point: (13, 0.625)
 Data Point: (13.1, 1)

100 psf (A-Bed0°-5°)

Model: Spline Data Point Function
 Function: Modifier Factor vs. Inclination
 Curve Fit to Data: 100 %
 Segment Curvature: 0 %
 Y-Intercept: 0.5
 Data Points: Inclination (°), Modifier Factor
 Data Point: (-90, 1)
 Data Point: (-0.9, 1)
 Data Point: (0, 0.5)
 Data Point: (5, 0.5)
 Data Point: (5.1, 1)

Tmc 100psf-25° (A-Bed0°-5°)

Model: Spline Data Point Function
 Function: Modifier Factor vs. Inclination
 Curve Fit to Data: 100 %
 Segment Curvature: 0 %
 Y-Intercept: 0.625
 Data Points: Inclination (°), Modifier Factor
 Data Point: (-90, 1)
 Data Point: (-0.9, 1)

Data Point: (0, 0.625)
 Data Point: (5, 0.625)
 Data Point: (5.1, 1)

150psf-17° (A-Bed0°-5°)

Model: Spline Data Point Function
 Function: Modifier Factor vs. Inclination
 Curve Fit to Data: 100 %
 Segment Curvature: 0 %
 Y-Intercept: 0.75
 Data Points: Inclination (°), Modifier Factor
 Data Point: (-90, 1)
 Data Point: (-0.9, 1)
 Data Point: (0, 0.75)
 Data Point: (5, 0.75)
 Data Point: (5.1, 1)

Tmc 150-17° (A-Bed0°-5°)

Model: Spline Data Point Function
 Function: Modifier Factor vs. Inclination
 Curve Fit to Data: 100 %
 Segment Curvature: 0 %
 Y-Intercept: 0.425
 Data Points: Inclination (°), Modifier Factor
 Data Point: (-90, 1)
 Data Point: (-0.9, 1)
 Data Point: (0, 0.425)
 Data Point: (5, 0.425)
 Data Point: (5.1, 1)

100psf-25° (A-Bed 6°-13°)

Model: Spline Data Point Function
 Function: Modifier Factor vs. Inclination
 Curve Fit to Data: 100 %
 Segment Curvature: 0 %
 Y-Intercept: 1
 Data Points: Inclination (°), Modifier Factor
 Data Point: (-90, 1)
 Data Point: (5.9, 1)
 Data Point: (6, 0.444)
 Data Point: (13, 0.444)
 Data Point: (13.1, 1)

Points

	X (ft)	Y (ft)
Point 1	59	1,960
Point 2	11	1,957
Point 3	31	1,968

Point 4	45	1,976
Point 5	69	1,976
Point 6	125	2,004
Point 7	136	2,004
Point 8	194	2,030
Point 9	205	2,030
Point 10	259	2,057
Point 11	333	2,057
Point 12	550	2,091
Point 13	603	2,090
Point 14	715	2,088
Point 15	810	2,090
Point 16	810	2,016
Point 17	642	2,006
Point 18	466	1,993
Point 19	312	1,983
Point 20	-201	1,955
Point 21	810	1,803
Point 22	-200	1,803
Point 23	-200.75	1,920
Point 24	810	1,990
Point 25	810	2,087
Point 26	810	2,085
Point 27	654	2,089.0893

Point 28	629	2,089
Point 29	88	1,956
Point 30	138	1,956
Point 31	358	2,067
Point 32	82.1967	1,962.1088
Point 33	167	1,970
Point 34	271	2,023
Point 35	273	2,024
Point 36	414	2,095
Point 37	316	2,045.9574
Point 38	356	2,046
Point 39	451	2,094
Point 40	374	2,055
Point 41	380	2,058

Regions

	Material	Points	Area (ft²)
Region 1	Tmc 100-25° (A-Bed0°-5°)	20,23,24,16,17,18,19,33,30,29,32,1,2	26,270
Region 2	Tmc 150-17° (A-Bed0°-5°)	23,22,21,24	1.5359e+005
Region 3	TQs 150-17° (A-Bed6°-7°)	19,18,17,16,26,34,33	32,238
Region 4	Shear Layer	26,25,35,34	744.5
Region 5	TQs 150-17° (A-Bed6°-7°)	15,14,27,40,38,37,35,25	8,477.5
Region 6	TQs 150-17° (A-Bed6°-7°)	13,12,39,41,28	3,375.5
Region 7	Shear Layer	27,28,41,40	694.11
Region 8	TQs 100-25° (A-Bed 6°-13°)	2,1,32,5,4,3	769.03
Region 9		5,32,29,30,33,34,35,37,31,11,10,9,8,7,6	9,276.8
Region 10		37,38,40,41,39,36,31	1,921.5

Current Slip Surface

Slip Surface: 44,427

F of S: 1.28
 Volume: 1,157.9967 ft³
 Weight: 138,959.6 lbs
 Resisting Force: 40,952.797 lbs
 Activating Force: 32,083.997 lbs
 F of S Rank (Analysis): 1 of 131,769 slip surfaces
 F of S Rank (Query): 1 of 300 slip surfaces
 Exit: (379, 2,057.5) ft
 Entry: (460.49548, 2,093.7123) ft
 Radius: 50.117051 ft
 Center: (407.67964, 2,102.7653) ft

Slip Slices

	X (ft)	Y (ft)	PWP (psf)	Base Normal Stress (psf)	Frictional Strength (psf)	Cohesive Strength (psf)
Slice 1	379.5	2,057.5	0	30	5.8314093	150
Slice 2	381.29	2,057.5	0	138.49014	26.919756	150
Slice 3	383.87	2,057.5	0	295.47042	57.433632	150
Slice 4	386.45	2,057.5	0	452.4507	87.947508	150
Slice 5	389.03	2,057.5	0	609.43099	118.46138	150
Slice 6	391.61	2,057.5	0	766.41127	148.97526	150
Slice 7	394.21875	2,057.687	0	867.1672	168.56023	150
Slice 8	396.85625	2,058.061	0	980.3117	190.55329	150
Slice 9	399.49375	2,058.435	0	1,093.4562	212.54635	150
Slice 10	402.13125	2,058.809	0	1,206.6007	234.53941	150
Slice 11	404.76875	2,059.183	0	1,319.7452	256.53248	150
Slice 12	407.40625	2,059.5571	0	1,432.8897	278.52554	150
Slice 13	410.04375	2,059.9311	0	1,546.0342	300.5186	150
Slice 14	412.68125	2,060.3051	0	1,659.1787	322.51166	150
Slice 15	415.38333	2,060.6882	0	1,775.0937	345.04326	150
Slice 16	418.15	2,061.0806	0	1,893.7792	368.11339	150
	420.91667	2,061.4729	0	2,012.4648	391.18352	150

Slice 17						
Slice 18	423.68333	2,061.8652	0	2,131.1503	414.25365	150
Slice 19	426.45	2,062.2576	0	2,249.8358	437.32378	150
Slice 20	429.21667	2,062.6499	0	2,368.5214	460.39392	150
Slice 21	431.98333	2,063.0422	0	2,487.2069	483.46405	150
Slice 22	434.75	2,063.4345	0	2,605.8924	506.53418	150
Slice 23	437.51667	2,063.8269	0	2,724.578	529.60431	150
Slice 24	440.28333	2,064.2192	0	2,843.2635	552.67444	150
Slice 25	443.05	2,064.6115	0	2,961.949	575.74457	150
Slice 26	445.81667	2,065.0038	0	3,080.6346	598.8147	150
Slice 27	447.48868	2,065.8191	0	2,195.2379	426.71102	150
Slice 28	449.38868	2,069.8936	0	999.89357	839.01033	225
Slice 29	452.58258	2,076.743	0	697.82189	585.54209	225
Slice 30	455.74774	2,083.5307	0	355.84044	298.58558	225
Slice 31	458.9129	2,090.3184	0	13.858984	11.629069	225

Section 19 SSA for Skyline Ranch.gsz

Section 19 SSA for Skyline Ranch.gsz Run By: Dr. Alexander Bykovtsev, Ph.D., P.E. 3/25/2016 2:09:28 PM

- Materials**
- TQs 150-17° (A-Bed6°-7°)
 - Shear Layer
 - Tmc 100-25° (A-Bed0°-5°)
 - Tmc 150-17° (A-Bed0°-5°)
 - TQs 100-25° (A-Bed 6°-13°)

Lower Keyway depth 20'
width 50', backcut slope 2H:1V
Upper Keyway depth 10'
Width 25', Backcut Slope 2H:1V

Current Analysis 5 - Translational Temporary

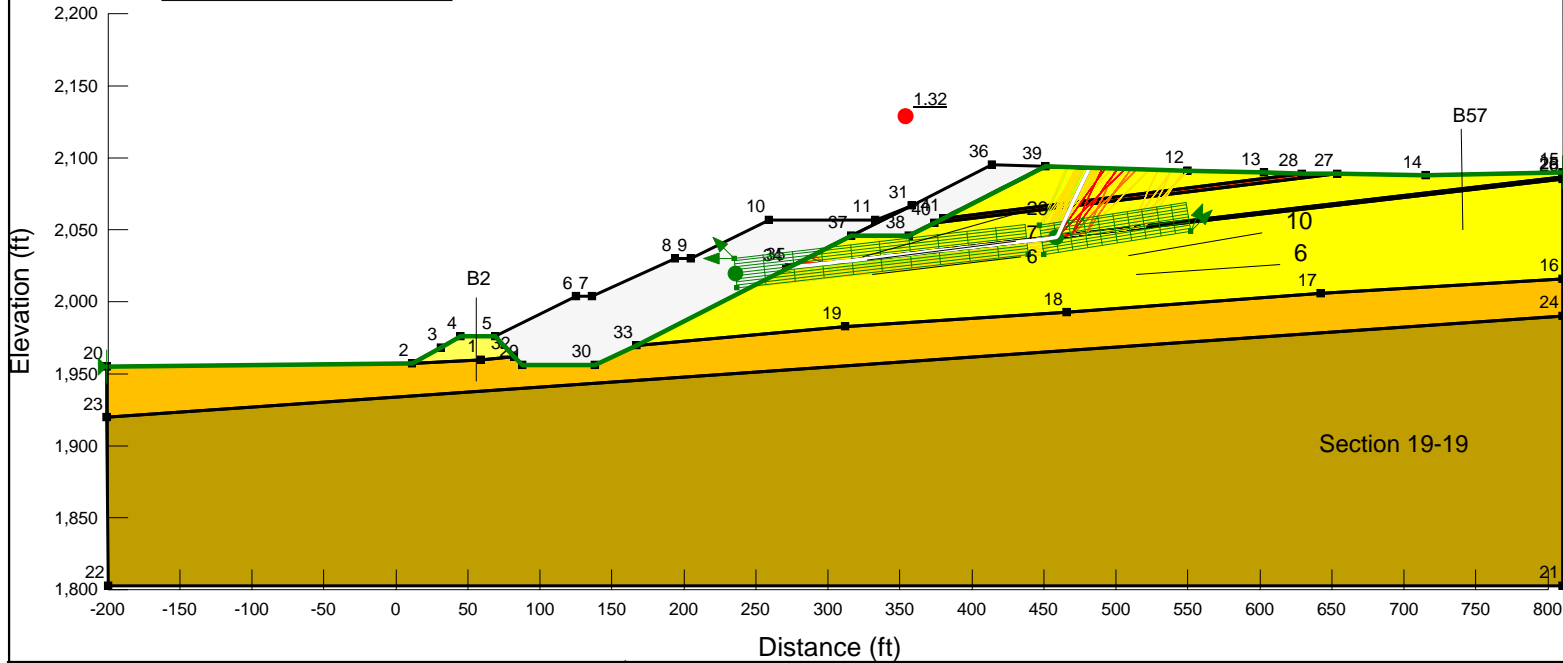

- Name: TQs 150-17° (A-Bed6°-7°)
Model: Anisotropic Fn.
Unit Weight: 120 pcf
Cohesion: 225 psf
Phi: 40 °
Phi-Anisotropic Strength Fn.: TQs 150-17° (A-Bed6°-7°)
C-Anisotropic Strength Fn.: 150psf-17° (A-Bed6°-7°)
- Name: Shear Layer
Model: Mohr-Coulomb
Unit Weight: 120 pcf
Cohesion: 150 psf
Phi: 11 °
- Name: Tmc 100-25° (A-Bed0°-5°)
Model: Anisotropic Fn.
Unit Weight: 120 pcf
Cohesion: 200 psf
Phi: 40 °
Phi-Anisotropic Strength Fn.: Tmc 100psf-25° (A-Bed0°-5°)
C-Anisotropic Strength Fn.: 100 psf (A-Bed0°-5°)
- Name: Tmc 150-17° (A-Bed0°-5°)
Model: Anisotropic Fn.
Unit Weight: 120 pcf
Cohesion: 200 psf
Phi: 40 °
Phi-Anisotropic Strength Fn.: Tmc 150-17° (A-Bed0°-5°)
C-Anisotropic Strength Fn.: 150psf-17° (A-Bed0°-5°)
- Name: TQs 100-25° (A-Bed 6°-13°)
Model: Anisotropic Fn.
Unit Weight: 120 pcf
Cohesion: 225 psf
Phi: 40 °
Phi-Anisotropic Strength Fn.: TQs 100-25° (A-Bed 6°-13°)
C-Anisotropic Strength Fn.: 100psf-25° (A-Bed 6°-13°)

LGC **LGC Valley, Inc**
 GEOTECHNICAL CONSULTING
 28532 Constellation Road, Valencia, CA 91355
 Phone 661-702-8474, Fax 661-702-8475

Skyline Ranch
 Development project, Tract 60922
 Los Angeles CA

Project No: **153035-01**
 Engineer: **BAS**
 Date: **March 2016**

5 - Translational Temporary

Report generated using GeoStudio 2012. Copyright © 1991-2015 GEO-SLOPE International Ltd.

File Information

File Version: 8.15
 Title: Static Slope Stability Analyses for Skyline Ranch Development project, Tract 60922, Los Angeles CA
 Comments: Run By: Dr. Alexander Bykovtsev, Ph.D., P.E.
 Last Edited By: Alexander Bykovtsev
 Revision Number: 156
 Date: 3/25/2016
 Time: 2:09:28 PM
 Tool Version: 8.15.1.11777
 File Name: Section 19 SSA for Skyline Ranch.gsz
 Directory: G:\SLOPE RESULTS\Section 19-19 results\Latest Update 3-25-16\
 Last Solved Date: 3/25/2016
 Last Solved Time: 2:11:48 PM

Project Settings

Length(L) Units: Feet
 Time(t) Units: Seconds
 Force(F) Units: Pounds
 Pressure(p) Units: psf
 Strength Units: psf
 Unit Weight of Water: 62.4 pcf
 View: 2D
 Element Thickness: 1

Analysis Settings

5 - Translational Temporary

Kind: SLOPE/W
 Method: Janbu
 Settings
 PWP Conditions Source: (none)
 Slip Surface
 Direction of movement: Right to Left
 Use Passive Mode: No
 Slip Surface Option: Block
 Critical slip surfaces saved: 1
 Resisting Side Maximum Convex Angle: 1 °
 Driving Side Maximum Convex Angle: 5 °
 Restrict Block Crossing: No
 Optimize Critical Slip Surface Location: No
 Tension Crack

Tension Crack Option: (none)
 F of S Distribution
 F of S Calculation Option: Constant
 Advanced
 Number of Slices: 30
 F of S Tolerance: 0.01
 Minimum Slip Surface Depth: 0.1 ft

Materials

TQs 150-17° (A-Bed6°-7°)

Model: Anisotropic Fn.
 Unit Weight: 120 pcf
 Cohesion': 225 psf
 Phi': 40 °
 Phi-Anisotropic Strength Fn.: TQs 150-17° (A-Bed6°-7°)
 C-Anisotropic Strength Fn.: 150psf-17° (A-Bed6°-7°)
 Phi-B: 0 °

Shear Layer

Model: Mohr-Coulomb
 Unit Weight: 120 pcf
 Cohesion': 150 psf
 Phi': 11 °
 Phi-B: 0 °

Tmc 100-25° (A-Bed0°-5°)

Model: Anisotropic Fn.
 Unit Weight: 120 pcf
 Cohesion': 200 psf
 Phi': 40 °
 Phi-Anisotropic Strength Fn.: Tmc 100psf-25° (A-Bed0°-5°)
 C-Anisotropic Strength Fn.: 100 psf (A-Bed0°-5°)
 Phi-B: 0 °

Tmc 150-17° (A-Bed0°-5°)

Model: Anisotropic Fn.
 Unit Weight: 120 pcf
 Cohesion': 200 psf
 Phi': 40 °
 Phi-Anisotropic Strength Fn.: Tmc 150-17° (A-Bed0°-5°)
 C-Anisotropic Strength Fn.: 150psf-17° (A-Bed0°-5°)
 Phi-B: 0 °

TQs 100-25° (A-Bed 6°-13°)

Model: Anisotropic Fn.
 Unit Weight: 120 pcf
 Cohesion': 225 psf
 Phi': 40 °

Phi-Anisotropic Strength Fn.: TQs 100-25° (A-Bed 6°-13°)
 C-Anisotropic Strength Fn.: 100psf-25° (A-Bed 6°-13°)
 Phi-B: 0°

Slip Surface Limits

Left Coordinate: (-201, 1,955) ft
 Right Coordinate: (810, 2,090) ft

Slip Surface Block

Left Grid

Upper Left: (235, 2,030.1838) ft
 Lower Left: (237, 2,009.5966) ft
 Lower Right: (439, 2,033) ft
 X Increments: 10
 Y Increments: 10
 Starting Angle: 135°
 Ending Angle: 180°
 Angle Increments: 2

Right Grid

Upper Left: (447, 2,053) ft
 Lower Left: (450, 2,033) ft
 Lower Right: (552, 2,049) ft
 X Increments: 10
 Y Increments: 10
 Starting Angle: 45°
 Ending Angle: 65°
 Angle Increments: 2

Seismic Coefficients

Horz Seismic Coef.: 0
 Vert Seismic Coef.: 0

Anisotropic Strength Functions

150psf-17° (A-Bed6°-7°)

Model: Spline Data Point Function
 Function: Modifier Factor vs. Inclination
 Curve Fit to Data: 100 %
 Segment Curvature: 0 %
 Y-Intercept: 1
 Data Points: Inclination (°), Modifier Factor
 Data Point: (-90, 1)
 Data Point: (5.9, 1)
 Data Point: (6, 0.75)
 Data Point: (7, 0.75)

Data Point: (7.1, 1)

TQs 150-17° (A-Bed6°-7°)

Model: Spline Data Point Function
 Function: Modifier Factor vs. Inclination
 Curve Fit to Data: 100 %
 Segment Curvature: 0 %
 Y-Intercept: 1
 Data Points: Inclination (°), Modifier Factor
 Data Point: (-90, 1)
 Data Point: (5.9, 1)
 Data Point: (6, 0.425)
 Data Point: (7, 0.425)
 Data Point: (7.1, 1)

TQs 100-25° (A-Bed 6°-13°)

Model: Spline Data Point Function
 Function: Modifier Factor vs. Inclination
 Curve Fit to Data: 100 %
 Segment Curvature: 0 %
 Y-Intercept: 1
 Data Points: Inclination (°), Modifier Factor
 Data Point: (-90, 1)
 Data Point: (5.9, 1)
 Data Point: (6, 0.625)
 Data Point: (13, 0.625)
 Data Point: (13.1, 1)

100 psf (A-Bed0°-5°)

Model: Spline Data Point Function
 Function: Modifier Factor vs. Inclination
 Curve Fit to Data: 100 %
 Segment Curvature: 0 %
 Y-Intercept: 0.5
 Data Points: Inclination (°), Modifier Factor
 Data Point: (-90, 1)
 Data Point: (-0.9, 1)
 Data Point: (0, 0.5)
 Data Point: (5, 0.5)
 Data Point: (5.1, 1)

Tmc 100psf-25° (A-Bed0°-5°)

Model: Spline Data Point Function
 Function: Modifier Factor vs. Inclination
 Curve Fit to Data: 100 %
 Segment Curvature: 0 %
 Y-Intercept: 0.625
 Data Points: Inclination (°), Modifier Factor
 Data Point: (-90, 1)
 Data Point: (-0.9, 1)

Data Point: (0, 0.625)
 Data Point: (5, 0.625)
 Data Point: (5.1, 1)

150psf-17° (A-Bed0°-5°)

Model: Spline Data Point Function
 Function: Modifier Factor vs. Inclination
 Curve Fit to Data: 100 %
 Segment Curvature: 0 %
 Y-Intercept: 0.75
 Data Points: Inclination (°), Modifier Factor
 Data Point: (-90, 1)
 Data Point: (-0.9, 1)
 Data Point: (0, 0.75)
 Data Point: (5, 0.75)
 Data Point: (5.1, 1)

Tmc 150-17° (A-Bed0°-5°)

Model: Spline Data Point Function
 Function: Modifier Factor vs. Inclination
 Curve Fit to Data: 100 %
 Segment Curvature: 0 %
 Y-Intercept: 0.425
 Data Points: Inclination (°), Modifier Factor
 Data Point: (-90, 1)
 Data Point: (-0.9, 1)
 Data Point: (0, 0.425)
 Data Point: (5, 0.425)
 Data Point: (5.1, 1)

100psf-25° (A-Bed 6°-13°)

Model: Spline Data Point Function
 Function: Modifier Factor vs. Inclination
 Curve Fit to Data: 100 %
 Segment Curvature: 0 %
 Y-Intercept: 1
 Data Points: Inclination (°), Modifier Factor
 Data Point: (-90, 1)
 Data Point: (5.9, 1)
 Data Point: (6, 0.444)
 Data Point: (13, 0.444)
 Data Point: (13.1, 1)

Points

	X (ft)	Y (ft)
Point 1	59	1,960
Point 2	11	1,957
Point 3	31	1,968

Point 4	45	1,976
Point 5	69	1,976
Point 6	125	2,004
Point 7	136	2,004
Point 8	194	2,030
Point 9	205	2,030
Point 10	259	2,057
Point 11	333	2,057
Point 12	550	2,091
Point 13	603	2,090
Point 14	715	2,088
Point 15	810	2,090
Point 16	810	2,016
Point 17	642	2,006
Point 18	466	1,993
Point 19	312	1,983
Point 20	-201	1,955
Point 21	810	1,803
Point 22	-200	1,803
Point 23	-200.75	1,920
Point 24	810	1,990
Point 25	810	2,087
Point 26	810	2,085
Point 27	654	2,089.0893

Point 28	629	2,089
Point 29	88	1,956
Point 30	138	1,956
Point 31	358	2,067
Point 32	82.1967	1,962.1088
Point 33	167	1,970
Point 34	271	2,023
Point 35	273	2,024
Point 36	414	2,095
Point 37	316	2,045.9574
Point 38	356	2,046
Point 39	451	2,094
Point 40	374	2,055
Point 41	380	2,058

Regions

	Material	Points	Area (ft²)
Region 1	Tmc 100-25° (A-Bed0°-5°)	20,23,24,16,17,18,19,33,30,29,32,1,2	26,270
Region 2	Tmc 150-17° (A-Bed0°-5°)	23,22,21,24	1.5359e+005
Region 3	TQs 150-17° (A-Bed6°-7°)	19,18,17,16,26,34,33	32,238
Region 4	Shear Layer	26,25,35,34	744.5
Region 5	TQs 150-17° (A-Bed6°-7°)	15,14,27,40,38,37,35,25	8,477.5
Region 6	TQs 150-17° (A-Bed6°-7°)	13,12,39,41,28	3,375.5
Region 7	Shear Layer	27,28,41,40	694.11
Region 8	TQs 100-25° (A-Bed 6°-13°)	2,1,32,5,4,3	769.03
Region 9		5,32,29,30,33,34,35,37,31,11,10,9,8,7,6	9,276.8
Region 10		37,38,40,41,39,36,31	1,921.5

Current Slip Surface

Slip Surface: 60,792

F of S: 1.32
 Volume: 4,896.8003 ft³
 Weight: 587,616.03 lbs
 Resisting Force: 151,439.98 lbs
 Activating Force: 114,811.73 lbs
 F of S Rank (Analysis): 1 of 131,769 slip surfaces
 F of S Rank (Query): 1 of 300 slip surfaces
 Exit: (272.98858, 2,023.9943) ft
 Entry: (481.30734, 2,093.0816) ft
 Radius: 107.29461 ft
 Center: (359.96375, 2,110.3534) ft

Slip Slices

	X (ft)	Y (ft)	PWP (psf)	Base Normal Stress (psf)	Frictional Strength (psf)	Cohesive Strength (psf)
Slice 1	272.99429	2,023.9949	0	-12.118371	-2.3555727	150
Slice 2	276.58333	2,024.3931	0	157.24981	30.566266	150
Slice 3	283.75	2,025.1883	0	495.46134	96.307928	150
Slice 4	290.91667	2,025.9835	0	833.67287	162.04959	150
Slice 5	298.08333	2,026.7787	0	1,171.8844	227.79125	150
Slice 6	305.25	2,027.5739	0	1,510.0959	293.53292	150
Slice 7	312.41667	2,028.3691	0	1,848.3075	359.27458	150
Slice 8	320.25	2,029.2382	0	1,962.2682	381.4263	150
Slice 9	328.75	2,030.1813	0	1,851.9782	359.98809	150
Slice 10	336.83333	2,031.0782	0	1,747.0945	339.60078	150
Slice 11	344.5	2,031.9289	0	1,647.6173	320.26435	150
Slice 12	352.16667	2,032.7795	0	1,548.14	300.92793	150
Slice 13	357	2,033.3158	0	1,544.3377	300.18883	150
Slice 14	362	2,033.8706	0	1,774.0193	344.83442	150
Slice 15	370	2,034.7582	0	2,141.5098	416.26735	150
Slice 16	377	2,035.5349	0	2,463.0641	478.77116	150
	383.4	2,036.245	0	2,759.8837	536.46705	150

Slice 17						
Slice 18	390.2	2,036.9995	0	3,077.905	598.28412	150
Slice 19	397	2,037.754	0	3,395.9262	660.10119	150
Slice 20	403.8	2,038.5085	0	3,713.9475	721.91826	150
Slice 21	410.6	2,039.263	0	4,031.9688	783.73533	150
Slice 22	417.7	2,040.0508	0	4,364.0204	848.27963	150
Slice 23	425.1	2,040.8719	0	4,710.1023	915.55115	150
Slice 24	432.5	2,041.693	0	5,056.1843	982.82267	150
Slice 25	439.9	2,042.514	0	5,402.2663	1,050.0942	150
Slice 26	447.3	2,043.3351	0	5,748.3483	1,117.3657	150
Slice 27	454.85	2,044.1728	0	5,857.1748	1,138.5195	150
Slice 28	458.99253	2,045.2273	0	4,243.2272	824.79981	150
Slice 29	464.11227	2,056.2067	0	1,746.609	1,465.5789	225
Slice 30	469.56179	2,067.8932	0	2,145.8657	417.11405	150
Slice 31	472.96491	2,075.1912	0	767.82686	644.28324	225
Slice 32	478.52653	2,087.1181	0	152.91282	128.30909	225

Section 19 SSA for Skyline Ranch.gsz

Section 19 SSA for Skyline Ranch.gsz Run By: Dr. Alexander Bykovtsev, Ph.D., P.E. 3/25/2016 2:18:40 PM

- Materials**
- TQs 150-17° (A-Bed6°-7°)
 - Shear Layer
 - Tmc 100-25° (A-Bed0°-5°)
 - Tmc 150-17° (A-Bed0°-5°)
 - TQs 100-25° (A-Bed 6°-13°)

Lower Keyway depth 20'
width 50', backcut slope 2H:1V
Upper Keyway depth 10'
Width 25', Backcut Slope 2H:1V

Current Analysis 5 - Translational Temporary lower portion of slope

- Name: TQs 150-17° (A-Bed6°-7°)
Model: Anisotropic Fn.
Unit Weight: 120 pcf
Cohesion: 225 psf
Phi: 40 °
Phi-Anisotropic Strength Fn.: TQs 150-17° (A-Bed6°-7°)
C-Anisotropic Strength Fn.: 150psf-17° (A-Bed6°-7°)
- Name: Shear Layer
Model: Mohr-Coulomb
Unit Weight: 120 pcf
Cohesion: 150 psf
Phi: 11 °
- Name: Tmc 100-25° (A-Bed0°-5°)
Model: Anisotropic Fn.
Unit Weight: 120 pcf
Cohesion: 200 psf
Phi: 40 °
Phi-Anisotropic Strength Fn.: Tmc 100psf-25° (A-Bed0°-5°)
C-Anisotropic Strength Fn.: 100 psf (A-Bed0°-5°)
- Name: Tmc 150-17° (A-Bed0°-5°)
Model: Anisotropic Fn.
Unit Weight: 120 pcf
Cohesion: 200 psf
Phi: 40 °
Phi-Anisotropic Strength Fn.: Tmc 150-17° (A-Bed0°-5°)
C-Anisotropic Strength Fn.: 150psf-17° (A-Bed0°-5°)

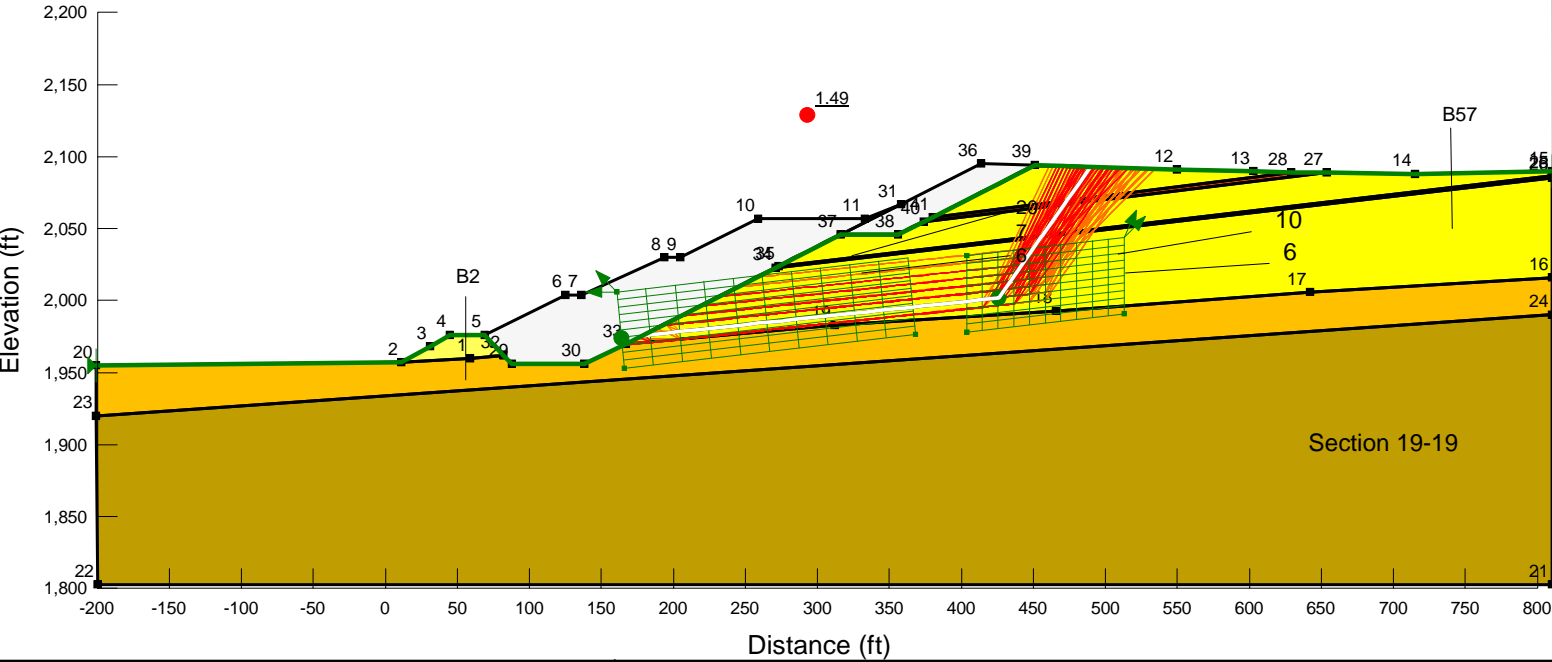

LGC **LGC Valley, Inc**
 GEOTECHNICAL CONSULTING
 28532 Constellation Road, Valencia, CA 91355
 Phone 661-702-8474, Fax 661-702-8475

Skyline Ranch
 Development project, Tract 60922
 Los Angeles CA

Project No: **153035-01**
 Engineer: **BAS**
 Date: **March 2016**

5 - Translational Temporary lower portion of slope

Report generated using GeoStudio 2012. Copyright © 1991-2015 GEO-SLOPE International Ltd.

File Information

File Version: 8.15
 Title: Static Slope Stability Analyses for Skyline Ranch Development project, Tract 60922, Los Angeles CA
 Comments: Run By: Dr. Alexander Bykovtsev, Ph.D., P.E.
 Last Edited By: Alexander Bykovtsec
 Revision Number: 157
 Date: 3/25/2016
 Time: 2:18:40 PM
 Tool Version: 8.15.1.11777
 File Name: Section 19 SSA for Skyline Ranch.gsz
 Directory: G:\SLOPE RESULTS\Section 19-19 results\Latest Update 3-25-16\
 Last Solved Date: 3/25/2016
 Last Solved Time: 2:19:50 PM

Project Settings

Length(L) Units: Feet
 Time(t) Units: Seconds
 Force(F) Units: Pounds
 Pressure(p) Units: psf
 Strength Units: psf
 Unit Weight of Water: 62.4 pcf
 View: 2D
 Element Thickness: 1

Analysis Settings

5 - Translational Temporary lower portion of slope

Kind: SLOPE/W
 Method: Janbu
 Settings
 PWP Conditions Source: (none)
 Slip Surface
 Direction of movement: Right to Left
 Use Passive Mode: No
 Slip Surface Option: Block
 Critical slip surfaces saved: 1
 Resisting Side Maximum Convex Angle: 1 °
 Driving Side Maximum Convex Angle: 5 °
 Restrict Block Crossing: No

file:///G:/SLOPE%20RESULTS/Section%2019-19%20results/Latest%20Update%203-25-... 3/25/2016

Optimize Critical Slip Surface Location: No
 Tension Crack
 Tension Crack Option: (none)
 F of S Distribution
 F of S Calculation Option: Constant
 Advanced
 Number of Slices: 30
 F of S Tolerance: 0.01
 Minimum Slip Surface Depth: 0.1 ft

Materials

TQs 150-17° (A-Bed6°-7°)

Model: Anisotropic Fn.
 Unit Weight: 120 pcf
 Cohesion': 225 psf
 Phi': 40 °
 Phi-Anisotropic Strength Fn.: TQs 150-17° (A-Bed6°-7°)
 C-Anisotropic Strength Fn.: 150psf-17° (A-Bed6°-7°)
 Phi-B: 0 °

Shear Layer

Model: Mohr-Coulomb
 Unit Weight: 120 pcf
 Cohesion': 150 psf
 Phi': 11 °
 Phi-B: 0 °

Tmc 100-25° (A-Bed0°-5°)

Model: Anisotropic Fn.
 Unit Weight: 120 pcf
 Cohesion': 200 psf
 Phi': 40 °
 Phi-Anisotropic Strength Fn.: Tmc 100psf-25° (A-Bed0°-5°)
 C-Anisotropic Strength Fn.: 100 psf (A-Bed0°-5°)
 Phi-B: 0 °

Tmc 150-17° (A-Bed0°-5°)

Model: Anisotropic Fn.
 Unit Weight: 120 pcf
 Cohesion': 200 psf
 Phi': 40 °
 Phi-Anisotropic Strength Fn.: Tmc 150-17° (A-Bed0°-5°)
 C-Anisotropic Strength Fn.: 150psf-17° (A-Bed0°-5°)
 Phi-B: 0 °

TQs 100-25° (A-Bed 6°-13°)

Model: Anisotropic Fn.
 Unit Weight: 120 pcf

file:///G:/SLOPE%20RESULTS/Section%2019-19%20results/Latest%20Update%203-25-... 3/25/2016

Cohesion: 225 psf
 Phi: 40 °
 Phi-Anisotropic Strength Fn.: TQs 100-25° (A-Bed 6°-13°)
 C-Anisotropic Strength Fn.: 100psf-25° (A-Bed 6°-13°)
 Phi-B: 0 °

Slip Surface Limits

Left Coordinate: (-201, 1,955) ft
 Right Coordinate: (810, 2,090) ft

Slip Surface Block

Left Grid
 Upper Left: (161, 2,006) ft
 Lower Left: (166, 1,953) ft
 Lower Right: (368, 1,976.4034) ft
 X Increments: 10
 Y Increments: 10
 Starting Angle: 135 °
 Ending Angle: 180 °
 Angle Increments: 2

Right Grid
 Upper Left: (404, 2,031) ft
 Lower Left: (404, 1,978) ft
 Lower Right: (513, 1,991) ft
 X Increments: 10
 Y Increments: 10
 Starting Angle: 45 °
 Ending Angle: 65 °
 Angle Increments: 2

Seismic Coefficients

Horz Seismic Coef.: 0
 Vert Seismic Coef.: 0

Anisotropic Strength Functions

150psf-17° (A-Bed6°-7°)
 Model: Spline Data Point Function
 Function: Modifier Factor vs. Inclination
 Curve Fit to Data: 100 %
 Segment Curvature: 0 %
 Y-Intercept: 1
 Data Points: Inclination (°), Modifier Factor
 Data Point: (-90, 1)
 Data Point: (5.9, 1)

Data Point: (6, 0.75)
 Data Point: (7, 0.75)
 Data Point: (7.1, 1)

TQs 150-17° (A-Bed6°-7°)

Model: Spline Data Point Function
 Function: Modifier Factor vs. Inclination
 Curve Fit to Data: 100 %
 Segment Curvature: 0 %
 Y-Intercept: 1
 Data Points: Inclination (°), Modifier Factor
 Data Point: (-90, 1)
 Data Point: (5.9, 1)
 Data Point: (6, 0.425)
 Data Point: (7, 0.425)
 Data Point: (7.1, 1)

TQs 100-25° (A-Bed 6°-13°)

Model: Spline Data Point Function
 Function: Modifier Factor vs. Inclination
 Curve Fit to Data: 100 %
 Segment Curvature: 0 %
 Y-Intercept: 1
 Data Points: Inclination (°), Modifier Factor
 Data Point: (-90, 1)
 Data Point: (5.9, 1)
 Data Point: (6, 0.625)
 Data Point: (13, 0.625)
 Data Point: (13.1, 1)

100 psf (A-Bed0°-5°)

Model: Spline Data Point Function
 Function: Modifier Factor vs. Inclination
 Curve Fit to Data: 100 %
 Segment Curvature: 0 %
 Y-Intercept: 0.5
 Data Points: Inclination (°), Modifier Factor
 Data Point: (-90, 1)
 Data Point: (-0.9, 1)
 Data Point: (0, 0.5)
 Data Point: (5, 0.5)
 Data Point: (5.1, 1)

Tmc 100psf-25° (A-Bed0°-5°)

Model: Spline Data Point Function
 Function: Modifier Factor vs. Inclination
 Curve Fit to Data: 100 %
 Segment Curvature: 0 %
 Y-Intercept: 0.625
 Data Points: Inclination (°), Modifier Factor

Data Point: (-90, 1)
 Data Point: (-0.9, 1)
 Data Point: (0, 0.625)
 Data Point: (5, 0.625)
 Data Point: (5.1, 1)

150psf-17° (A-Bed0°-5°)

Model: Spline Data Point Function
 Function: Modifier Factor vs. Inclination
 Curve Fit to Data: 100 %
 Segment Curvature: 0 %
 Y-Intercept: 0.75
 Data Points: Inclination (°), Modifier Factor
 Data Point: (-90, 1)
 Data Point: (-0.9, 1)
 Data Point: (0, 0.75)
 Data Point: (5, 0.75)
 Data Point: (5.1, 1)

Tmc 150-17° (A-Bed0°-5°)

Model: Spline Data Point Function
 Function: Modifier Factor vs. Inclination
 Curve Fit to Data: 100 %
 Segment Curvature: 0 %
 Y-Intercept: 0.425
 Data Points: Inclination (°), Modifier Factor
 Data Point: (-90, 1)
 Data Point: (-0.9, 1)
 Data Point: (0, 0.425)
 Data Point: (5, 0.425)
 Data Point: (5.1, 1)

100psf-25° (A-Bed 6°-13°)

Model: Spline Data Point Function
 Function: Modifier Factor vs. Inclination
 Curve Fit to Data: 100 %
 Segment Curvature: 0 %
 Y-Intercept: 1
 Data Points: Inclination (°), Modifier Factor
 Data Point: (-90, 1)
 Data Point: (5.9, 1)
 Data Point: (6, 0.444)
 Data Point: (13, 0.444)
 Data Point: (13.1, 1)

Points

	X (ft)	Y (ft)
Point 1	59	1,960
Point 2	11	1,957

Point 3	31	1,968
Point 4	45	1,976
Point 5	69	1,976
Point 6	125	2,004
Point 7	136	2,004
Point 8	194	2,030
Point 9	205	2,030
Point 10	259	2,057
Point 11	333	2,057
Point 12	550	2,091
Point 13	603	2,090
Point 14	715	2,088
Point 15	810	2,090
Point 16	810	2,016
Point 17	642	2,006
Point 18	466	1,993
Point 19	312	1,983
Point 20	-201	1,955
Point 21	810	1,803
Point 22	-200	1,803
Point 23	-200.75	1,920
Point 24	810	1,990
Point 25	810	2,087
Point 26	810	2,085

Point 27	654	2,089.0893
Point 28	629	2,089
Point 29	88	1,956
Point 30	138	1,956
Point 31	358	2,067
Point 32	82.1967	1,962.1088
Point 33	167	1,970
Point 34	271	2,023
Point 35	273	2,024
Point 36	414	2,095
Point 37	316	2,045.9574
Point 38	356	2,046
Point 39	451	2,094
Point 40	374	2,055
Point 41	380	2,058

Regions

	Material	Points	Area (ft²)
Region 1	Tmc 100-25° (A-Bed0°-5°)	20,23,24,16,17,18,19,33,30,29,32,1,2	26,270
Region 2	Tmc 150-17° (A-Bed0°-5°)	23,22,21,24	1.5359e+005
Region 3	TQs 150-17° (A-Bed6°-7°)	19,18,17,16,26,34,33	32,238
Region 4	Shear Layer	26,25,35,34	744.5
Region 5	TQs 150-17° (A-Bed6°-7°)	15,14,27,40,38,37,35,25	8,477.5
Region 6	TQs 150-17° (A-Bed6°-7°)	13,12,39,41,28	3,375.5
Region 7	Shear Layer	27,28,41,40	694.11
Region 8	TQs 100-25° (A-Bed 6°-13°)	2,1,32,5,4,3	769.03
Region 9		5,32,29,30,33,34,35,37,31,11,10,9,8,7,6	9,276.8
Region 10		37,38,40,41,39,36,31	1,921.5

Current Slip Surface

Slip Surface: 48,782
 F of S: 1.49
 Volume: 13,344.53 ft³
 Weight: 1,601,343.6 lbs
 Resisting Force: 580,417.7 lbs
 Activating Force: 389,532.89 lbs
 F of S Rank (Analysis): 1 of 131,769 slip surfaces
 F of S Rank (Query): 1 of 300 slip surfaces
 Exit: (178.1736, 1,975.6942) ft
 Entry: (489.54135, 2,092.8321) ft
 Radius: 172.04365 ft
 Center: (300.80667, 2,122.1165) ft

Slip Slices

	X (ft)	Y (ft)	PWP (psf)	Base Normal Stress (psf)	Frictional Strength (psf)	Cohesive Strength (psf)
Slice 1	182.1302	1,976.1114	0	176.18597	53.865457	168.75
Slice 2	190.0434	1,976.9456	0	551.88815	168.72914	168.75
Slice 3	199.5	1,977.9426	0	1,000.8677	305.99596	168.75
Slice 4	210.4	1,979.0917	0	1,518.3768	464.21437	168.75
Slice 5	221.2	1,980.2303	0	2,031.1381	620.98124	168.75
Slice 6	232	1,981.3688	0	2,543.8994	777.74811	168.75
Slice 7	242.8	1,982.5074	0	3,056.6607	934.51497	168.75
Slice 8	253.6	1,983.646	0	3,569.4221	1,091.2818	168.75
Slice 9	265	1,984.8478	0	4,110.6701	1,256.758	168.75
Slice 10	272	1,985.5858	0	4,441.886	1,358.0208	168.75
Slice 11	278.375	1,986.2579	0	4,744.0733	1,450.4087	168.75
Slice 12	289.125	1,987.3912	0	5,255.751	1,606.8443	168.75
Slice 13	299.875	1,988.5245	0	5,767.4287	1,763.2799	168.75
Slice 14	310.625	1,989.6578	0	6,279.1064	1,919.7155	168.75
Slice 15	320.25	1,990.6725	0	6,482.847	1,982.0052	168.75
	328.75	1,991.5686	0	6,378.6505	1,950.1492	168.75

Slice 16						
Slice 17	338.75	1,992.6228	0	6,256.0663	1,912.6714	168.75
Slice 18	350.25	1,993.8352	0	6,115.0946	1,869.572	168.75
Slice 19	357	1,994.5468	0	6,090.9571	1,862.1925	168.75
Slice 20	362	1,995.074	0	6,322.6993	1,933.0432	168.75
Slice 21	370	1,995.9173	0	6,693.4868	2,046.4043	168.75
Slice 22	377	1,996.6553	0	7,017.9259	2,145.5953	168.75
Slice 23	385.66667	1,997.569	0	7,424.2999	2,269.8363	168.75
Slice 24	397	1,998.7638	0	7,958.9573	2,433.2974	168.75
Slice 25	408.33333	1,999.9586	0	8,493.6146	2,596.7586	168.75
Slice 26	419.9	2,001.178	0	9,039.2797	2,763.5851	168.75
Slice 27	432.1	2,010.7973	0	4,781.1383	4,011.8513	225
Slice 28	444.7	2,028.792	0	4,008.5811	3,363.5989	225
Slice 29	453.25253	2,041.0063	0	3,403.6207	2,855.9769	225
Slice 30	455.9582	2,044.8704	0	4,834.9442	939.81795	150
Slice 31	463.88066	2,056.1848	0	2,371.8111	1,990.1858	225
Slice 32	472.3168	2,068.2329	0	2,420.8687	470.5692	150
Slice 33	477.34804	2,075.4182	0	1,064.3596	893.10378	225
Slice 34	485.47691	2,087.0275	0	275.18592	230.9084	225

Section 20-20 Static Final SSA with key for Skyline Ranch.gsz

Section 20-20 Static Final SSA with key for Skyline Ranch.gsz Run By: Dr. Alexander Bykovtsev, Ph.D., P.E. 3/24/2016 2:17:59 PM

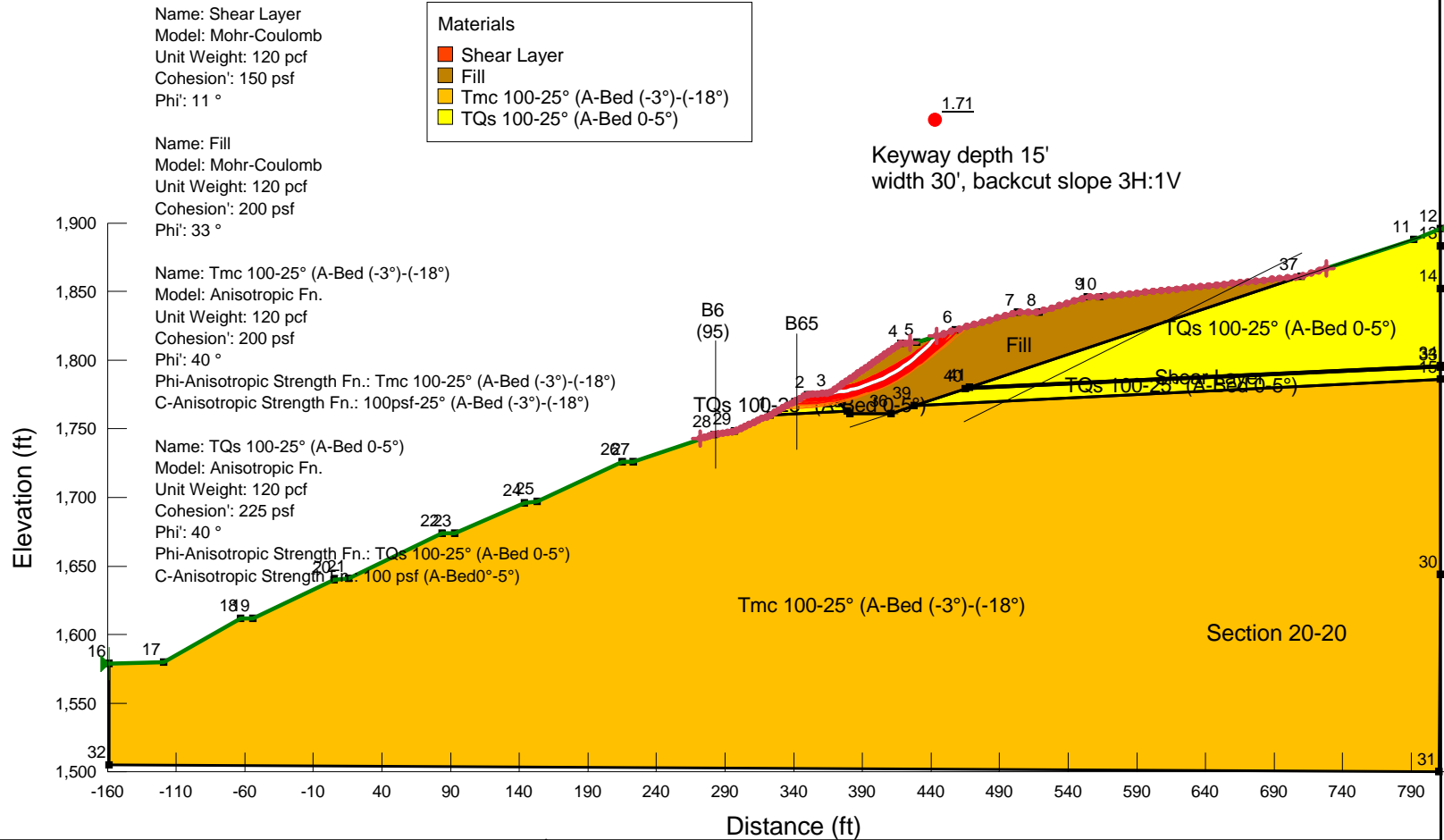

LGC **LGC Valley, Inc**
 GEOTECHNICAL CONSULTING
 28532 Constellation Road, Valencia, CA 91355
 Phone 661-702-8474, Fax 661-702-8475

Skyline Ranch
 Development project, Tract 60922
 Los Angeles CA

Project No: **153035-01**
 Engineer: **BAS**
 Date: **March 2016**

1 - Circular Mode of Failure

Report generated using GeoStudio 2012. Copyright © 1991-2015 GEO-SLOPE International Ltd.

File Information

File Version: 8.15
 Title: Static Slope Stability Analyses for Skyline Ranch Development project, Tract 60922, Los Angeles CA
 Comments: Run By: Dr. Alexander Bykovtsev, Ph.D., P.E.
 Last Edited By: Alexander Bykovtsev
 Revision Number: 180
 Date: 3/24/2016
 Time: 2:17:59 PM
 Tool Version: 8.15.1.11236
 File Name: Section 20-20 Static Final SSA with key for Skyline Ranch.gsz
 Directory: G:\SLOPE RESULTS\Section 20-20 results\
 Last Solved Date: 3/24/2016
 Last Solved Time: 2:39:39 PM

Project Settings

Length(L) Units: Feet
 Time(t) Units: Seconds
 Force(F) Units: Pounds
 Pressure(p) Units: psf
 Strength Units: psf
 Unit Weight of Water: 62.4 pcf
 View: 2D
 Element Thickness: 1

Analysis Settings

1 - Circular Mode of Failure

Kind: SLOPE/W
 Method: Bishop
 Settings
 PWP Conditions Source: (none)
 Slip Surface
 Direction of movement: Right to Left
 Use Passive Mode: No
 Slip Surface Option: Entry and Exit
 Critical slip surfaces saved: 1
 Resisting Side Maximum Convex Angle: 1 °
 Driving Side Maximum Convex Angle: 5 °
 Optimize Critical Slip Surface Location: No
 Tension Crack
 Tension Crack Option: (none)
 F of S Distribution
 F of S Calculation Option: Constant

Advanced

Number of Slices: 30
 F of S Tolerance: 0.01
 Minimum Slip Surface Depth: 0.1 ft

Materials

Shear Layer

Model: Mohr-Coulomb
 Unit Weight: 120 pcf
 Cohesion: 150 psf
 Phi: 11 °
 Phi-B: 0 °

Fill

Model: Mohr-Coulomb
 Unit Weight: 120 pcf
 Cohesion: 200 psf
 Phi: 33 °
 Phi-B: 0 °

Tmc 100-25° (A-Bed (-3°)-(-18°))

Model: Anisotropic Fn.
 Unit Weight: 120 pcf
 Cohesion: 200 psf
 Phi: 40 °
 Phi-Anisotropic Strength Fn.: Tmc 100-25° (A-Bed (-3°)-(-18°))
 C-Anisotropic Strength Fn.: 100psf-25° (A-Bed (-3°)-(-18°))
 Phi-B: 0 °

TQs 100-25° (A-Bed 0-5°)

Model: Anisotropic Fn.
 Unit Weight: 120 pcf
 Cohesion: 225 psf
 Phi: 40 °
 Phi-Anisotropic Strength Fn.: TQs 100-25° (A-Bed 0-5°)
 C-Anisotropic Strength Fn.: 100 psf (A-Bed 0°-5°)
 Phi-B: 0 °

Slip Surface Entry and Exit

Left Projection: Range
 Left-Zone Left Coordinate: (272, 1,742.6102) ft
 Left-Zone Right Coordinate: (425, 1,812.5833) ft
 Left-Zone Increment: 50
 Right Projection: Range
 Right-Zone Left Coordinate: (444, 1,817.5) ft
 Right-Zone Right Coordinate: (727.9594, 1,866.9135) ft
 Right-Zone Increment: 50
 Radius Increments: 50

Slip Surface Limits

Left Coordinate: (-159, 1,579) ft
 Right Coordinate: (811, 1,896) ft

Seismic Coefficients

Horz Seismic Coef.: 0
 Vert Seismic Coef.: 0

Anisotropic Strength Functions

100 psf (A-Bed 0°-5°)

Model: Spline Data Point Function
 Function: Modifier Factor vs. Inclination
 Curve Fit to Data: 100 %
 Segment Curvature: 0 %

Y-Intercept: 0.5
 Data Points: Inclination (°), Modifier Factor
 Data Point: (-90, 1)
 Data Point: (-0.9, 1)
 Data Point: (0, 0.5)
 Data Point: (5, 0.5)
 Data Point: (5.1, 1)

Tmc 100-25° (A-Bed (-3°)-(-18°))

Model: Spline Data Point Function
 Function: Modifier Factor vs. Inclination
 Curve Fit to Data: 100 %
 Segment Curvature: 0 %

Y-Intercept: 1
 Data Points: Inclination (°), Modifier Factor
 Data Point: (-90, 1)
 Data Point: (-18.1, 1)
 Data Point: (-18, 0.625)
 Data Point: (-3, 0.625)
 Data Point: (-2.9, 1)

TQs 100-25° (A-Bed 0-5°)

Model: Spline Data Point Function
 Function: Modifier Factor vs. Inclination
 Curve Fit to Data: 100 %
 Segment Curvature: 0 %

Y-Intercept: 0.625
 Data Points: Inclination (°), Modifier Factor
 Data Point: (-90, 1)
 Data Point: (-0.9, 1)
 Data Point: (0, 0.625)
 Data Point: (5, 0.625)
 Data Point: (5.1, 1)

100psf-25° (A-Bed (-3°)-(-18°))

Model: Spline Data Point Function
 Function: Modifier Factor vs. Inclination
 Curve Fit to Data: 100 %
 Segment Curvature: 0 %

Y-Intercept: 1
 Data Points: Inclination (°), Modifier Factor
 Data Point: (-90, 1)
 Data Point: (-18.1, 1)
 Data Point: (-18, 0.5)
 Data Point: (-3, 0.5)
 Data Point: (-2.9, 1)

Points

	X (ft)	Y (ft)
Point 1	323	1,760
Point 2	350	1,775
Point 3	366	1,776
Point 4	418	1,812
Point 5	430	1,813
Point 6	458	1,822
Point 7	503	1,835
Point 8	519	1,835
Point 9	554	1,846
Point 10	563	1,846
Point 11	792	1,888
Point 12	811	1,896
Point 13	811	1,883
Point 14	811	1,852
Point 15	811	1,786
Point 16	-159	1,579
Point 17	-119	1,580
Point 18	-63	1,612
Point 19	-54	1,612
Point 20	5	1,640
Point 21	16	1,641
Point 22	84	1,674
Point 23	93	1,674
Point 24	144	1,696
Point 25	153	1,697
Point 26	215	1,726
Point 27	223	1,726
Point 28	282	1,746
Point 29	297	1,748
Point 30	811	1,644
Point 31	810	1,500

Point 32	-159	1,505
Point 33	811	1,795
Point 34	811	1,796
Point 35	381	1,761
Point 36	411	1,761
Point 37	710	1,861
Point 38	379	1,763
Point 39	428	1,767
Point 40	465	1,779
Point 41	468	1,780

Regions

	Material	Points	Area (ft²)
Region 1	Tmc 100-25° (A-Bed (-3°)-(- 18°)	16,32,31,30,15,39,36,35,38,1,29,28,27,26,25,24,23,22,21,20,19,18,17	2.1207e+005
Region 2	Shear Layer	33,34,41,40	320.5
Region 3	TQs 100-25° (A-Bed 0-5°)	14,13,12,11,37,41,34	16,934
Region 4	Fill	3,38,35,36,39,40,41,37,10,9,8,7,6,5,4	10,221
Region 5	TQs 100-25° (A-Bed 0-5°)	1,38,3,2	490
Region 6	TQs 100-25° (A-Bed 0-5°)	15,33,40,39	3,503.5

Current Slip Surface

Slip Surface: 75,446
F of S: 1.71

Volume: 829.50517 ft³
 Weight: 99,540.62 lbs
 Resisting Moment: 8,779,718.6 lbs-ft
 Activating Moment: 5,143,754.7 lbs-ft
 F of S Rank (Analysis): 1 of 132,651 slip surfaces
 F of S Rank (Query): 1 of 500 slip surfaces
 Exit: (366.06486, 1,776.0449) ft
 Entry: (444, 1,817.5) ft
 Radius: 114.37316 ft
 Center: (355.48166, 1,889.9274) ft

Slip Slices

	X (ft)	Y (ft)	PWP (psf)	Base Normal Stress (psf)	Frictional Strength (psf)	Cohesive Strength (psf)
Slice 1	367.36324	1,776.1805	0	76.35423	49.585017	200
Slice 2	369.96	1,776.4819	0	244.4064	158.71938	200
Slice 3	372.55675	1,776.8436	0	402.75278	261.55071	200
Slice 4	375.15351	1,777.2664	0	551.52314	358.16332	200
Slice 5	377.75027	1,777.7508	0	690.82643	448.62793	200
Slice 6	380.34703	1,778.2978	0	820.75155	533.00229	200
Slice 7	382.94378	1,778.9082	0	941.36799	611.33152	200
Slice 8	385.54054	1,779.583	0	1,052.7263	683.64848	200
Slice 9	388.1373	1,780.3236	0	1,154.8586	749.97392	200
Slice 10	390.73405	1,781.1311	0	1,247.7781	810.31655	200
Slice 11	393.33081	1,782.0072	0	1,331.4797	864.67302	200
Slice 12	395.92757	1,782.9534	0	1,405.9395	913.02777	200
Slice 13	398.52432	1,783.9718	0	1,471.1142	955.35273	200
Slice 14	401.12108	1,785.0643	0	1,526.9408	991.60697	200
Slice 15	403.71784	1,786.2334	0	1,573.3356	1,021.7361	200
Slice 16	406.31459	1,787.4816	0	1,610.1932	1,045.6717	200
Slice 17	408.91135	1,788.8119	0	1,637.3849	1,063.3302	200
Slice 18	411.50811	1,790.2276	0	1,654.7576	1,074.6122	200

Slice 19	414.10486	1,791.7324	0	1,662.1315	1,079.4008	200
Slice 20	416.70162	1,793.3304	0	1,659.2976	1,077.5604	200
Slice 21	419.2	1,794.9584	0	1,577.0049	1,024.1189	200
Slice 22	421.6	1,796.6138	0	1,418.1585	920.96293	200
Slice 23	424	1,798.362	0	1,253.1884	813.83005	200
Slice 24	426.4	1,800.2085	0	1,081.992	702.65383	200
Slice 25	428.8	1,802.1595	0	904.46401	587.3658	200
Slice 26	431.4	1,804.4047	0	734.28963	476.85326	200
Slice 27	434.2	1,806.9761	0	569.01665	369.52373	200
Slice 28	437	1,809.7276	0	392.47425	254.87576	200
Slice 29	439.8	1,812.6788	0	204.32202	132.68827	200
Slice 30	442.6	1,815.8535	0	4.2300002	2.7469943	200

Section 20-20 Seismic Final SSA with key for Skyline Ranch.gsz

Section 20-20 Seismic Final SSA with key for Skyline Ranch.gsz Run By: Dr. Alexander Bykovtsev, Ph.D., P.E. 3/24/2016 2:11:22 PM

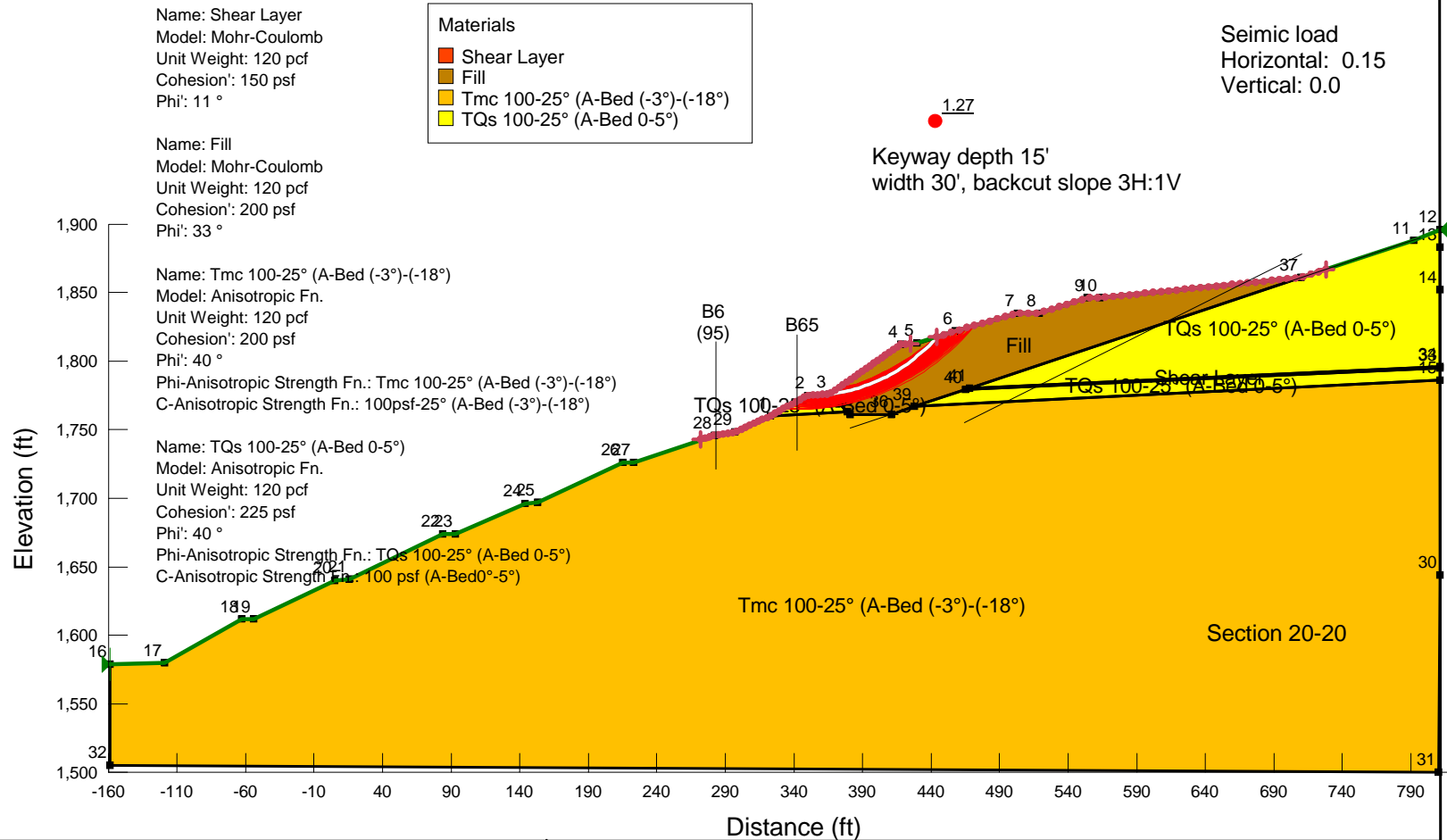

LGC **LGC Valley, Inc**
 GEOTECHNICAL CONSULTING
 28532 Constellation Road, Valencia, CA 91355
 Phone 661-702-8474, Fax 661-702-8475

Skyline Ranch
 Development project, Tract 60922
 Los Angeles CA

Project No: **153035-01**
 Engineer: **BAS**
 Date: **March 2016**

1 - Circular Mode of Failure

Report generated using GeoStudio 2012. Copyright © 1991-2015 GEO-SLOPE International Ltd.

File Information

File Version: 8.15
 Title: Static Slope Stability Analyses for Skyline Ranch Development project, Tract 60922, Los Angeles CA
 Comments: Run By: Dr. Alexander Bykovtsev, Ph.D., P.E.
 Last Edited By: Alexander Bykovtsev
 Revision Number: 177
 Date: 3/24/2016
 Time: 2:11:22 PM
 Tool Version: 8.15.1.11236
 File Name: Section 20-20 Seismic Final SSA with key for Skyline Ranch.gsz
 Directory: G:\SLOPE RESULTS\Section 20-20 results\
 Last Solved Date: 3/24/2016
 Last Solved Time: 2:31:46 PM

Project Settings

Length(L) Units: Feet
 Time(t) Units: Seconds
 Force(F) Units: Pounds
 Pressure(p) Units: psf
 Strength Units: psf
 Unit Weight of Water: 62.4 pcf
 View: 2D
 Element Thickness: 1

Analysis Settings

1 - Circular Mode of Failure

Kind: SLOPE/W
 Method: Bishop
 Settings
 PWP Conditions Source: (none)
 Slip Surface
 Direction of movement: Right to Left
 Use Passive Mode: No
 Slip Surface Option: Entry and Exit
 Critical slip surfaces saved: 1
 Resisting Side Maximum Convex Angle: 1 °
 Driving Side Maximum Convex Angle: 5 °
 Optimize Critical Slip Surface Location: No
 Tension Crack
 Tension Crack Option: (none)
 F of S Distribution
 F of S Calculation Option: Constant

file:///G:/SLOPE%20RESULTS/Section%2020-20%20results/section%2020-20%20seismi... 3/24/2016

Advanced

Number of Slices: 30
 F of S Tolerance: 0.01
 Minimum Slip Surface Depth: 0.1 ft

Materials

Shear Layer

Model: Mohr-Coulomb
 Unit Weight: 120 pcf
 Cohesion: 150 psf
 Phi: 11 °
 Phi-B: 0 °

Fill

Model: Mohr-Coulomb
 Unit Weight: 120 pcf
 Cohesion: 200 psf
 Phi: 33 °
 Phi-B: 0 °

Tmc 100-25° (A-Bed (-3°)-(-18°))

Model: Anisotropic Fn.
 Unit Weight: 120 pcf
 Cohesion: 200 psf
 Phi: 40 °
 Phi-Anisotropic Strength Fn.: Tmc 100-25° (A-Bed (-3°)-(-18°))
 C-Anisotropic Strength Fn.: 100psf-25° (A-Bed (-3°)-(-18°))
 Phi-B: 0 °

TQs 100-25° (A-Bed 0-5°)

Model: Anisotropic Fn.
 Unit Weight: 120 pcf
 Cohesion: 225 psf
 Phi: 40 °
 Phi-Anisotropic Strength Fn.: TQs 100-25° (A-Bed 0-5°)
 C-Anisotropic Strength Fn.: 100 psf (A-Bed 0°-5°)
 Phi-B: 0 °

Slip Surface Entry and Exit

Left Projection: Range
 Left-Zone Left Coordinate: (272, 1,742.6102) ft
 Left-Zone Right Coordinate: (425, 1,812.5833) ft
 Left-Zone Increment: 50
 Right Projection: Range
 Right-Zone Left Coordinate: (444, 1,817.5) ft
 Right-Zone Right Coordinate: (727.9594, 1,866.9135) ft
 Right-Zone Increment: 50
 Radius Increments: 50

file:///G:/SLOPE%20RESULTS/Section%2020-20%20results/section%2020-20%20seismi... 3/24/2016

Slip Surface Limits

Left Coordinate: (-159, 1,579) ft
 Right Coordinate: (811, 1,896) ft

Seismic Coefficients

Horz Seismic Coef.: 0.15
 Vert Seismic Coef.: 0

Anisotropic Strength Functions

100 psf (A-Bed 0°-5°)

Model: Spline Data Point Function
 Function: Modifier Factor vs. Inclination
 Curve Fit to Data: 100 %
 Segment Curvature: 0 %

Y-Intercept: 0.5
 Data Points: Inclination (°), Modifier Factor
 Data Point: (-90, 1)
 Data Point: (-0.9, 1)
 Data Point: (0, 0.5)
 Data Point: (5, 0.5)
 Data Point: (5.1, 1)

Tmc 100-25° (A-Bed (-3°)-(-18°))

Model: Spline Data Point Function
 Function: Modifier Factor vs. Inclination
 Curve Fit to Data: 100 %
 Segment Curvature: 0 %

Y-Intercept: 1
 Data Points: Inclination (°), Modifier Factor
 Data Point: (-90, 1)
 Data Point: (-18.1, 1)
 Data Point: (-18, 0.625)
 Data Point: (-3, 0.625)
 Data Point: (-2.9, 1)

TQs 100-25° (A-Bed 0-5°)

Model: Spline Data Point Function
 Function: Modifier Factor vs. Inclination
 Curve Fit to Data: 100 %
 Segment Curvature: 0 %

Y-Intercept: 0.625
 Data Points: Inclination (°), Modifier Factor
 Data Point: (-90, 1)
 Data Point: (-0.9, 1)
 Data Point: (0, 0.625)
 Data Point: (5, 0.625)
 Data Point: (5.1, 1)

100psf-25° (A-Bed (-3°)-(-18°))

Model: Spline Data Point Function
 Function: Modifier Factor vs. Inclination
 Curve Fit to Data: 100 %
 Segment Curvature: 0 %

Y-Intercept: 1
 Data Points: Inclination (°), Modifier Factor
 Data Point: (-90, 1)
 Data Point: (-18.1, 1)
 Data Point: (-18, 0.5)
 Data Point: (-3, 0.5)
 Data Point: (-2.9, 1)

Points

	X (ft)	Y (ft)
Point 1	323	1,760
Point 2	350	1,775
Point 3	366	1,776
Point 4	418	1,812
Point 5	430	1,813
Point 6	458	1,822
Point 7	503	1,835
Point 8	519	1,835
Point 9	554	1,846
Point 10	563	1,846
Point 11	792	1,888
Point 12	811	1,896
Point 13	811	1,883
Point 14	811	1,852
Point 15	811	1,786
Point 16	-159	1,579
Point 17	-119	1,580
Point 18	-63	1,612
Point 19	-54	1,612
Point 20	5	1,640
Point 21	16	1,641
Point 22	84	1,674
Point 23	93	1,674
Point 24	144	1,696
Point 25	153	1,697
Point 26	215	1,726
Point 27	223	1,726
Point 28	282	1,746
Point 29	297	1,748
Point 30	811	1,644
Point 31	810	1,500

Point 32	-159	1,505
Point 33	811	1,795
Point 34	811	1,796
Point 35	381	1,761
Point 36	411	1,761
Point 37	710	1,861
Point 38	379	1,763
Point 39	428	1,767
Point 40	465	1,779
Point 41	468	1,780

Regions

	Material	Points	Area (ft²)
Region 1	Tmc 100-25° (A-Bed (-3°)-(- 18°)	16,32,31,30,15,39,36,35,38,1,29,28,27,26,25,24,23,22,21,20,19,18,17	2.1207e+005
Region 2	Shear Layer	33,34,41,40	320.5
Region 3	TQs 100-25° (A-Bed 0-5°)	14,13,12,11,37,41,34	16,934
Region 4	Fill	3,38,35,36,39,40,41,37,10,9,8,7,6,5,4	10,221
Region 5	TQs 100-25° (A-Bed 0-5°)	1,38,3,2	490
Region 6	TQs 100-25° (A-Bed 0-5°)	15,33,40,39	3,503.5

Current Slip Surface

Slip Surface: 67,643
F of S: 1.27

Volume: 797.58287 ft³
 Weight: 95,709.944 lbs
 Resisting Moment: 8,515,823.8 lbs-ft
 Activating Moment: 6,701,235 lbs-ft
 F of S Rank (Analysis): 1 of 132,651 slip surfaces
 F of S Rank (Query): 1 of 500 slip surfaces
 Exit: (366.06489, 1,776.0449) ft
 Entry: (444, 1,817.5) ft
 Radius: 121.12055 ft
 Center: (352.06352, 1,896.3535) ft

Slip Slices

	X (ft)	Y (ft)	PWP (psf)	Base Normal Stress (psf)	Frictional Strength (psf)	Cohesive Strength (psf)
Slice 1	367.36327	1,776.2103	0	63.911433	41.50457	200
Slice 2	369.96002	1,776.5696	0	220.43805	143.15414	200
Slice 3	372.55678	1,776.9865	0	367.30928	238.53343	200
Slice 4	375.15353	1,777.4616	0	504.70052	327.75635	200
Slice 5	377.75029	1,777.9955	0	632.76615	410.92314	200
Slice 6	380.34704	1,778.5891	0	751.64066	488.12115	200
Slice 7	382.9438	1,779.2433	0	861.43962	559.42543	200
Slice 8	385.54056	1,779.9591	0	962.26049	624.89927	200
Slice 9	388.13731	1,780.7377	0	1,054.1832	684.59458	200
Slice 10	390.73407	1,781.5802	0	1,137.2707	738.55225	200
Slice 11	393.33082	1,782.4883	0	1,211.5694	786.80234	200
Slice 12	395.92758	1,783.4633	0	1,277.1089	829.36423	200
Slice 13	398.52433	1,784.5071	0	1,333.9029	866.24664	200
Slice 14	401.12109	1,785.6217	0	1,381.9482	897.44764	200
Slice 15	403.71784	1,786.8092	0	1,421.2252	922.95444	200
Slice 16	406.3146	1,788.0719	0	1,451.6973	942.74322	200
Slice 17	408.91136	1,789.4126	0	1,473.3101	956.77879	200
Slice 18	411.50811	1,790.8343	0	1,485.9915	965.01414	200

Slice 19	414.10487	1,792.3401	0	1,489.6498	967.38987	200
Slice 20	416.70162	1,793.934	0	1,484.1735	963.83356	200
Slice 21	419.2	1,795.5527	0	1,404.8394	912.31339	200
Slice 22	421.6	1,797.1934	0	1,254.8025	814.87826	200
Slice 23	424	1,798.9209	0	1,100.1482	714.44462	200
Slice 24	426.4	1,800.7399	0	940.86216	611.00303	200
Slice 25	428.8	1,802.6556	0	776.93524	504.54764	200
Slice 26	431.4	1,804.8522	0	621.43083	403.5619	200
Slice 27	434.2	1,807.3582	0	472.33446	306.73759	200
Slice 28	437	1,810.0278	0	314.71921	204.38105	200
Slice 29	439.8	1,812.8767	0	148.51278	96.445329	200
Slice 30	442.6	1,815.9241	0	-26.316766	-17.090308	200

Section 20-20 Static Final SSA with key for Skyline Ranch.gsz

Section 20-20 Static Final SSA with key for Skyline Ranch.gsz Run By: Dr. Alexander Bykovtsev, Ph.D., P.E. 3/24/2016 2:17:59 PM

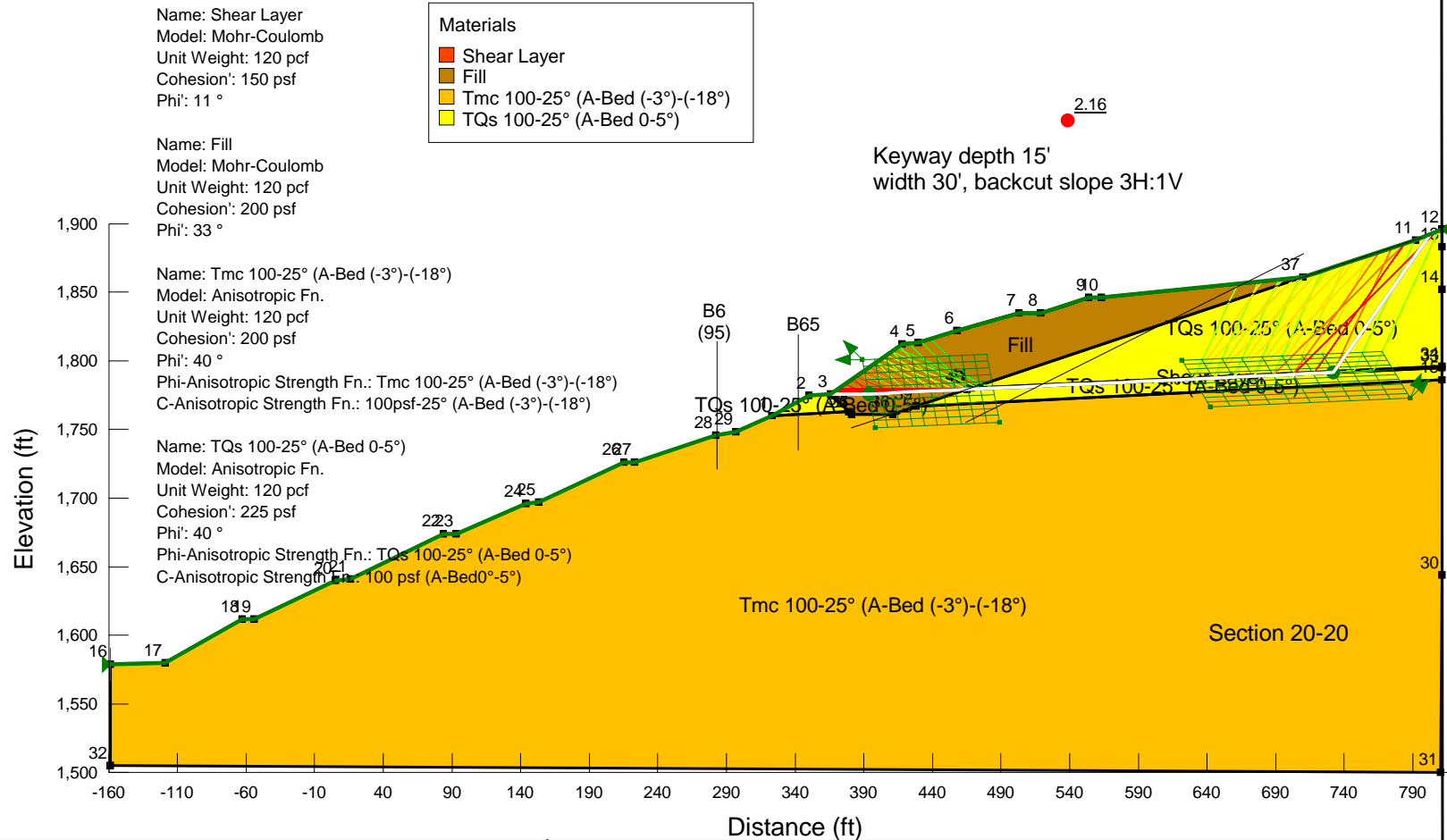

LGC **LGC Valley, Inc**
 GEOTECHNICAL CONSULTING
 28532 Constellation Road, Valencia, CA 91355
 Phone 661-702-8474, Fax 661-702-8475

Skyline Ranch
 Development project, Tract 60922
 Los Angeles CA

Project No: **153035-01**
 Engineer: **BAS**
 Date: **March 2016**

2 - Translational

Report generated using GeoStudio 2012. Copyright © 1991-2015 GEO-SLOPE International Ltd.

File Information

File Version: 8.15
 Title: Static Slope Stability Analyses for Skyline Ranch Development project, Tract 60922, Los Angeles CA
 Comments: Run By: Dr. Alexander Bykovtsev, Ph.D., P.E.
 Last Edited By: Alexander Bykovtsev
 Revision Number: 180
 Date: 3/24/2016
 Time: 2:17:59 PM
 Tool Version: 8.15.1.11236
 File Name: Section 20-20 Static Final SSA with key for Skyline Ranch.gsz
 Directory: G:\SLOPE RESULTS\Section 20-20 results\
 Last Solved Date: 3/24/2016
 Last Solved Time: 2:37:00 PM

Project Settings

Length(L) Units: Feet
 Time(t) Units: Seconds
 Force(F) Units: Pounds
 Pressure(p) Units: psf
 Strength Units: psf
 Unit Weight of Water: 62.4 pcf
 View: 2D
 Element Thickness: 1

Analysis Settings

2 - Translational

Kind: SLOPE/W
 Method: Janbu
 Settings
 PWP Conditions Source: (none)
 Slip Surface
 Direction of movement: Right to Left
 Use Passive Mode: No
 Slip Surface Option: Block
 Critical slip surfaces saved: 10
 Resisting Side Maximum Convex Angle: 1 °
 Driving Side Maximum Convex Angle: 5 °
 Restrict Block Crossing: No
 Optimize Critical Slip Surface Location: No
 Tension Crack
 Tension Crack Option: (none)
 F of S Distribution

file:///G:/SLOPE%20RESULTS/Section%2020-20%20results/section%2020-20%20static... 3/24/2016

F of S Calculation Option: Constant
 Advanced
 Number of Slices: 30
 F of S Tolerance: 0.01
 Minimum Slip Surface Depth: 0.1 ft

Materials

Shear Layer

Model: Mohr-Coulomb
 Unit Weight: 120 pcf
 Cohesion': 150 psf
 Phi': 11 °
 Phi-B: 0 °

Fill

Model: Mohr-Coulomb
 Unit Weight: 120 pcf
 Cohesion': 200 psf
 Phi': 33 °
 Phi-B: 0 °

Tmc 100-25° (A-Bed (-3°)-(-18°))

Model: Anisotropic Fn.
 Unit Weight: 120 pcf
 Cohesion': 200 psf
 Phi': 40 °
 Phi-Anisotropic Strength Fn.: Tmc 100-25° (A-Bed (-3°)-(-18°))
 C-Anisotropic Strength Fn.: 100psf-25° (A-Bed (-3°)-(-18°))
 Phi-B: 0 °

TQs 100-25° (A-Bed 0-5°)

Model: Anisotropic Fn.
 Unit Weight: 120 pcf
 Cohesion': 225 psf
 Phi': 40 °
 Phi-Anisotropic Strength Fn.: TQs 100-25° (A-Bed 0-5°)
 C-Anisotropic Strength Fn.: 100 psf (A-Bed 0°-5°)
 Phi-B: 0 °

Slip Surface Limits

Left Coordinate: (-159, 1,579) ft
 Right Coordinate: (811, 1,896) ft

Slip Surface Block

Left Grid
 Upper Left: (389, 1,801) ft
 Lower Left: (398.4302, 1,750.9572) ft

file:///G:/SLOPE%20RESULTS/Section%2020-20%20results/section%2020-20%20static... 3/24/2016

Lower Right: (489, 1,755) ft
 X Increments: 10
 Y Increments: 10
 Starting Angle: 135 °
 Ending Angle: 180 °
 Angle Increments: 2

Right Grid

Upper Left: (621.85, 1,800.3944) ft
 Lower Left: (642.3716, 1,766.6249) ft
 Lower Right: (788, 1,773) ft
 X Increments: 10
 Y Increments: 10
 Starting Angle: 45 °
 Ending Angle: 65 °
 Angle Increments: 2

Seismic Coefficients

Horz Seismic Coef.: 0
 Vert Seismic Coef.: 0

Anisotropic Strength Functions

100 psf (A-Bed0°-5°)

Model: Spline Data Point Function
 Function: Modifier Factor vs. Inclination
 Curve Fit to Data: 100 %
 Segment Curvature: 0 %

Y-Intercept: 0.5

Data Points: Inclination (°), Modifier Factor
 Data Point: (-90, 1)
 Data Point: (-0.9, 1)
 Data Point: (0, 0.5)
 Data Point: (5, 0.5)
 Data Point: (5.1, 1)

Tmc 100-25° (A-Bed (-3°)-(-18°))

Model: Spline Data Point Function
 Function: Modifier Factor vs. Inclination
 Curve Fit to Data: 100 %
 Segment Curvature: 0 %

Y-Intercept: 1

Data Points: Inclination (°), Modifier Factor
 Data Point: (-90, 1)
 Data Point: (-18.1, 1)
 Data Point: (-18, 0.625)
 Data Point: (-3, 0.625)
 Data Point: (-2.9, 1)

TQs 100-25° (A-Bed 0-5°)

Model: Spline Data Point Function

Function: Modifier Factor vs. Inclination
 Curve Fit to Data: 100 %
 Segment Curvature: 0 %

Y-Intercept: 0.625

Data Points: Inclination (°), Modifier Factor
 Data Point: (-90, 1)
 Data Point: (-0.9, 1)
 Data Point: (0, 0.625)
 Data Point: (5, 0.625)
 Data Point: (5.1, 1)

100psf-25° (A-Bed (-3°)-(-18°))

Model: Spline Data Point Function
 Function: Modifier Factor vs. Inclination
 Curve Fit to Data: 100 %
 Segment Curvature: 0 %

Y-Intercept: 1

Data Points: Inclination (°), Modifier Factor
 Data Point: (-90, 1)
 Data Point: (-18.1, 1)
 Data Point: (-18, 0.5)
 Data Point: (-3, 0.5)
 Data Point: (-2.9, 1)

Points

	X (ft)	Y (ft)
Point 1	323	1,760
Point 2	350	1,775
Point 3	366	1,776
Point 4	418	1,812
Point 5	430	1,813
Point 6	458	1,822
Point 7	503	1,835
Point 8	519	1,835
Point 9	554	1,846
Point 10	563	1,846
Point 11	792	1,888
Point 12	811	1,896
Point 13	811	1,883
Point 14	811	1,852
Point 15	811	1,786
Point 16	-159	1,579
Point 17	-119	1,580
Point 18	-63	1,612
Point 19	-54	1,612
Point 20	5	1,640
Point 21	16	1,641
Point 22	84	1,674

Point 23	93	1,674
Point 24	144	1,696
Point 25	153	1,697
Point 26	215	1,726
Point 27	223	1,726
Point 28	282	1,746
Point 29	297	1,748
Point 30	811	1,644
Point 31	810	1,500
Point 32	-159	1,505
Point 33	811	1,795
Point 34	811	1,796
Point 35	381	1,761
Point 36	411	1,761
Point 37	710	1,861
Point 38	379	1,763
Point 39	428	1,767
Point 40	465	1,779
Point 41	468	1,780

Regions

	Material	Points	Area (ft ²)
Region 1	Tmc 100-25° (A-Bed (-3°)-(- 18°)	16,32,31,30,15,39,36,35,38,1,29,28,27,26,25,24,23,22,21,20,19,18,17	2.1207e+005
Region 2	Shear Layer	33,34,41,40	320.5

Region 3	TQs 100-25° (A-Bed 0-5°)	14,13,12,11,37,41,34	16,934
Region 4	Fill	3,38,35,36,39,40,41,37,10,9,8,7,6,5,4	10,221
Region 5	TQs 100-25° (A-Bed 0-5°)	1,38,3,2	490
Region 6	TQs 100-25° (A-Bed 0-5°)	15,33,40,39	3,503.5

Current Slip Surface

Slip Surface: 60,842
 F of S: 2.16
 Volume: 22,175.401 ft³
 Weight: 2,661,048.2 lbs
 Resisting Force: 846,644.37 lbs
 Activating Force: 391,561.67 lbs
 F of S Rank (Analysis): 1 of 131,769 slip surfaces
 F of S Rank (Query): 1 of 500 slip surfaces
 Exit: (365.6576, 1,775.9786) ft
 Entry: (802.88262, 1,892.5822) ft
 Radius: 208.81205 ft
 Center: (560.94736, 1,921.733) ft

Slip Slices

	X (ft)	Y (ft)	PWP (psf)	Base Normal Stress (psf)	Frictional Strength (psf)	Cohesive Strength (psf)
Slice 1	365.8288	1,775.9786	0	1.284	0.59873903	112.5
Slice 2	372.93412	1,775.9786	0	578.63377	375.76916	200
Slice 3	386.79168	1,775.9786	0	1,729.8764	1,123.3949	200
Slice 4	399.78632	1,776.2545	0	2,734.7637	1,775.9763	200
Slice 5	411.92877	1,776.8062	0	3,664.6129	2,379.8274	200
Slice 6	424	1,777.3547	0	4,156.4552	2,699.2336	200
Slice 7	437	1,777.9453	0	4,412.0816	2,865.2393	200
Slice 8	451	1,778.5815	0	4,869.4989	3,162.2896	200
Slice 9	461.87786	1,779.0757	0	5,209.9696	3,383.3938	200

Slice 10	466.87786	1,779.3029	0	5,406.1583	1,050.8507	150
Slice 11	476.75	1,779.7515	0	5,693.3909	1,106.6831	150
Slice 12	494.25	1,780.5466	0	6,202.558	1,205.6551	150
Slice 13	511	1,781.3077	0	6,413.6997	1,246.6969	150
Slice 14	527.75	1,782.0687	0	6,651.3995	1,292.9011	150
Slice 15	545.25	1,782.8639	0	7,213.6828	1,402.1979	150
Slice 16	558.5	1,783.4659	0	7,470.3884	1,452.0964	150
Slice 17	570.35	1,784.0044	0	7,495.6737	1,457.0114	150
Slice 18	585.05	1,784.6723	0	7,595.1163	1,476.341	150
Slice 19	599.75	1,785.3402	0	7,694.5588	1,495.6707	150
Slice 20	614.45	1,786.0081	0	7,794.0014	1,515.0004	150
Slice 21	629.15	1,786.676	0	7,893.444	1,534.3301	150
Slice 22	643.85	1,787.344	0	7,992.8866	1,553.6598	150
Slice 23	658.55	1,788.0119	0	8,092.3292	1,572.9895	150
Slice 24	673.25	1,788.6798	0	8,191.7718	1,592.3191	150
Slice 25	687.95	1,789.3477	0	8,291.2144	1,611.6488	150
Slice 26	702.65	1,790.0157	0	8,390.657	1,630.9785	150
Slice 27	715.49963	1,790.5995	0	8,626.9316	1,676.9056	150
Slice 28	726.49889	1,791.0993	0	9,000.0382	1,749.4302	150
Slice 29	739.76082	1,802.4349	0	5,180.7499	4,347.1653	225
Slice 30	754.93593	1,824.1072	0	3,893.7093	3,267.2101	225
Slice 31	769.76156	1,845.2804	0	2,636.3095	2,212.1264	225
Slice 32	784.58719	1,866.4536	0	1,378.9097	1,157.0427	225
Slice 33	797.44131	1,884.8112	0	327.26453	274.60755	225

Section 20-20 Seismic Final SSA with key for Skyline Ranch.gsz

Section 20-20 Seismic Final SSA with key for Skyline Ranch.gsz Run By: Dr. Alexander Bykovtsev, Ph.D., P.E. 3/24/2016 2:11:22 PM

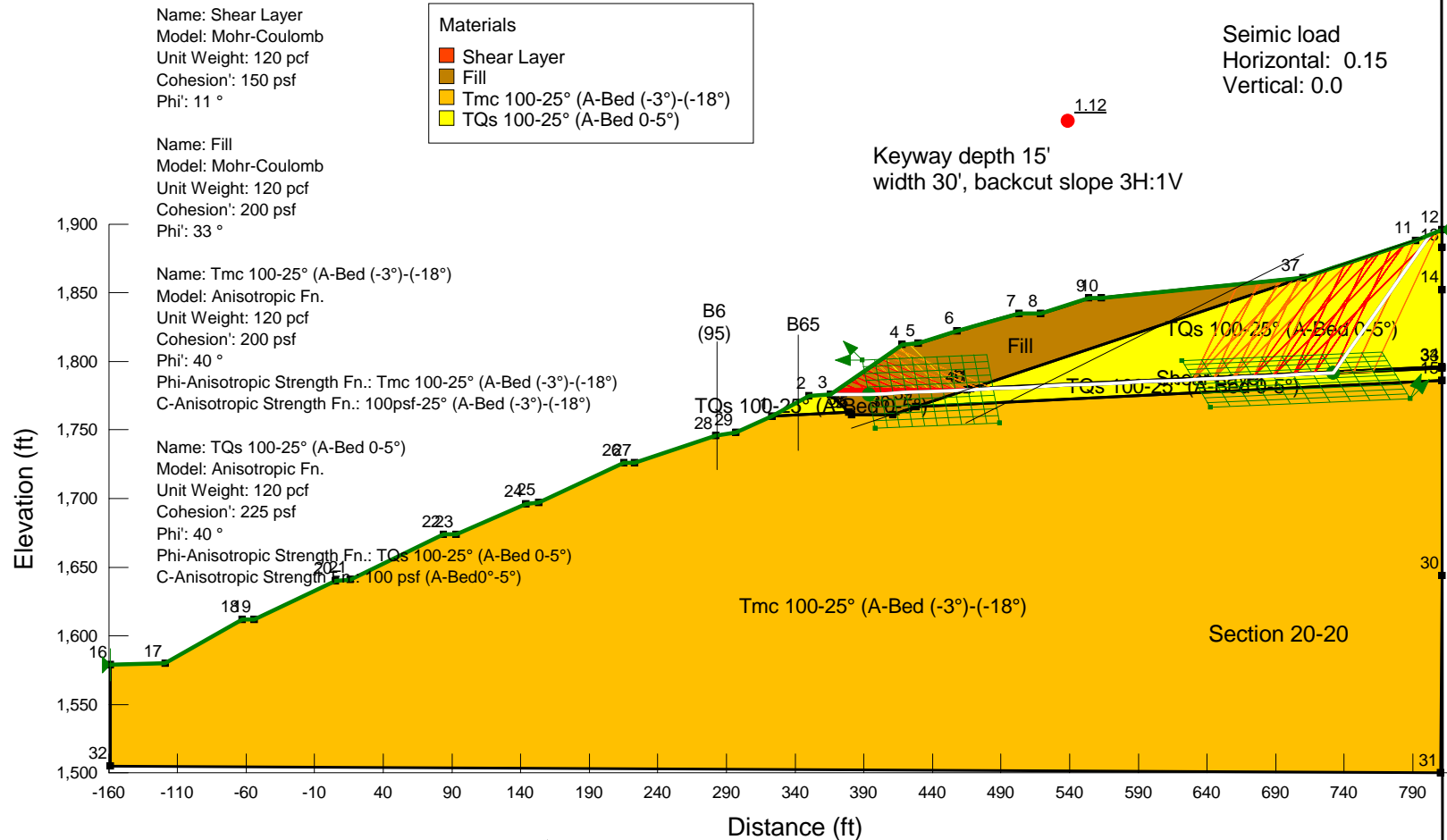

	<p>LGC Valley, Inc GEOTECHNICAL CONSULTING 28532 Constellation Road, Valencia, CA 91355 Phone 661-702-8474, Fax 661-702-8475</p>	<p>Skyline Ranch Development project, Tract 60922 Los Angeles CA</p>	<p>Project No: 153035-01 Engineer: BAS Date: March 2016</p>
---	---	---	--

2 - Translational

Report generated using GeoStudio 2012. Copyright © 1991-2015 GEO-SLOPE International Ltd.

File Information

File Version: 8.15
 Title: *Static Slope Stability Analyses for Skyline Ranch Development project, Tract 60922, Los Angeles CA*
 Comments: Run By: Dr. Alexander Bykovtsev, Ph.D., P.E.
 Last Edited By: Alexander Bykovtsev
 Revision Number: 177
 Date: 3/24/2016
 Time: 2:11:22 PM
 Tool Version: 8.15.1.11236
 File Name: Section 20-20 Seismic Final SSA with key for Skyline Ranch.gsz
 Directory: G:\SLOPE RESULTS\Section 20-20 results\
 Last Solved Date: 3/24/2016
 Last Solved Time: 2:27:54 PM

Project Settings

Length(L) Units: Feet
 Time(t) Units: Seconds
 Force(F) Units: Pounds
 Pressure(p) Units: psf
 Strength Units: psf
 Unit Weight of Water: 62.4 pcf
 View: 2D
 Element Thickness: 1

Analysis Settings

2 - Translational

Kind: SLOPE/W
 Method: Janbu
 Settings
 PWP Conditions Source: (none)
 Slip Surface
 Direction of movement: Right to Left
 Use Passive Mode: No
 Slip Surface Option: Block
 Critical slip surfaces saved: 10
 Resisting Side Maximum Convex Angle: 1 °
 Driving Side Maximum Convex Angle: 5 °
 Restrict Block Crossing: No
 Optimize Critical Slip Surface Location: No
 Tension Crack
 Tension Crack Option: (none)
 F of S Distribution

file:///G:/SLOPE%20RESULTS/Section%2020-20%20results/section%2020-20%20seismi... 3/24/2016

F of S Calculation Option: Constant
 Advanced
 Number of Slices: 30
 F of S Tolerance: 0.01
 Minimum Slip Surface Depth: 0.1 ft

Materials

Shear Layer

Model: Mohr-Coulomb
 Unit Weight: 120 pcf
 Cohesion': 150 psf
 Phi': 11 °
 Phi-B: 0 °

Fill

Model: Mohr-Coulomb
 Unit Weight: 120 pcf
 Cohesion': 200 psf
 Phi': 33 °
 Phi-B: 0 °

Tmc 100-25° (A-Bed (-3°)-(-18°))

Model: Anisotropic Fn.
 Unit Weight: 120 pcf
 Cohesion': 200 psf
 Phi': 40 °
 Phi-Anisotropic Strength Fn.: Tmc 100-25° (A-Bed (-3°)-(-18°))
 C-Anisotropic Strength Fn.: 100psf-25° (A-Bed (-3°)-(-18°))
 Phi-B: 0 °

TQs 100-25° (A-Bed 0-5°)

Model: Anisotropic Fn.
 Unit Weight: 120 pcf
 Cohesion': 225 psf
 Phi': 40 °
 Phi-Anisotropic Strength Fn.: TQs 100-25° (A-Bed 0-5°)
 C-Anisotropic Strength Fn.: 100 psf (A-Bed 0°-5°)
 Phi-B: 0 °

Slip Surface Limits

Left Coordinate: (-159, 1,579) ft
 Right Coordinate: (811, 1,896) ft

Slip Surface Block

Left Grid
 Upper Left: (389, 1,801) ft
 Lower Left: (398.4302, 1,750.9572) ft

file:///G:/SLOPE%20RESULTS/Section%2020-20%20results/section%2020-20%20seismi... 3/24/2016

Lower Right: (489, 1,755) ft
 X Increments: 10
 Y Increments: 10
 Starting Angle: 135 °
 Ending Angle: 180 °
 Angle Increments: 2

Right Grid

Upper Left: (621.85, 1,800.3944) ft
 Lower Left: (642.3716, 1,766.6249) ft
 Lower Right: (788, 1,773) ft
 X Increments: 10
 Y Increments: 10
 Starting Angle: 45 °
 Ending Angle: 65 °
 Angle Increments: 2

Seismic Coefficients

Horz Seismic Coef.: 0.15
 Vert Seismic Coef.: 0

Anisotropic Strength Functions

100 psf (A-Bed0°-5°)

Model: Spline Data Point Function
 Function: Modifier Factor vs. Inclination
 Curve Fit to Data: 100 %
 Segment Curvature: 0 %

Y-Intercept: 0.5

Data Points: Inclination (°), Modifier Factor
 Data Point: (-90, 1)
 Data Point: (-0.9, 1)
 Data Point: (0, 0.5)
 Data Point: (5, 0.5)
 Data Point: (5.1, 1)

Tmc 100-25° (A-Bed (-3°)-(-18°))

Model: Spline Data Point Function
 Function: Modifier Factor vs. Inclination
 Curve Fit to Data: 100 %
 Segment Curvature: 0 %

Y-Intercept: 1

Data Points: Inclination (°), Modifier Factor
 Data Point: (-90, 1)
 Data Point: (-18.1, 1)
 Data Point: (-18, 0.625)
 Data Point: (-3, 0.625)
 Data Point: (-2.9, 1)

TQs 100-25° (A-Bed 0-5°)

Model: Spline Data Point Function

Function: Modifier Factor vs. Inclination
 Curve Fit to Data: 100 %
 Segment Curvature: 0 %
 Y-Intercept: 0.625

Data Points: Inclination (°), Modifier Factor
 Data Point: (-90, 1)
 Data Point: (-0.9, 1)
 Data Point: (0, 0.625)
 Data Point: (5, 0.625)
 Data Point: (5.1, 1)

100psf-25° (A-Bed (-3°)-(-18°))

Model: Spline Data Point Function
 Function: Modifier Factor vs. Inclination
 Curve Fit to Data: 100 %
 Segment Curvature: 0 %

Y-Intercept: 1

Data Points: Inclination (°), Modifier Factor
 Data Point: (-90, 1)
 Data Point: (-18.1, 1)
 Data Point: (-18, 0.5)
 Data Point: (-3, 0.5)
 Data Point: (-2.9, 1)

Points

	X (ft)	Y (ft)
Point 1	323	1,760
Point 2	350	1,775
Point 3	366	1,776
Point 4	418	1,812
Point 5	430	1,813
Point 6	458	1,822
Point 7	503	1,835
Point 8	519	1,835
Point 9	554	1,846
Point 10	563	1,846
Point 11	792	1,888
Point 12	811	1,896
Point 13	811	1,883
Point 14	811	1,852
Point 15	811	1,786
Point 16	-159	1,579
Point 17	-119	1,580
Point 18	-63	1,612
Point 19	-54	1,612
Point 20	5	1,640
Point 21	16	1,641
Point 22	84	1,674

Point 23	93	1,674
Point 24	144	1,696
Point 25	153	1,697
Point 26	215	1,726
Point 27	223	1,726
Point 28	282	1,746
Point 29	297	1,748
Point 30	811	1,644
Point 31	810	1,500
Point 32	-159	1,505
Point 33	811	1,795
Point 34	811	1,796
Point 35	381	1,761
Point 36	411	1,761
Point 37	710	1,861
Point 38	379	1,763
Point 39	428	1,767
Point 40	465	1,779
Point 41	468	1,780

Regions

	Material	Points	Area (ft ²)
Region 1	Tmc 100-25° (A-Bed (-3°)-(-18°)	16,32,31,30,15,39,36,35,38,1,29,28,27,26,25,24,23,22,21,20,19,18,17	2.1207e+005
Region 2	Shear Layer	33,34,41,40	320.5

Region 3	TQs 100-25° (A-Bed 0-5°)	14,13,12,11,37,41,34	16,934
Region 4	Fill	3,38,35,36,39,40,41,37,10,9,8,7,6,5,4	10,221
Region 5	TQs 100-25° (A-Bed 0-5°)	1,38,3,2	490
Region 6	TQs 100-25° (A-Bed 0-5°)	15,33,40,39	3,503.5

Current Slip Surface

Slip Surface: 60,842
 F of S: 1.12
 Volume: 22,175.401 ft³
 Weight: 2,661,048.2 lbs
 Resisting Force: 795,760.17 lbs
 Activating Force: 710,791.63 lbs
 F of S Rank (Analysis): 1 of 131,769 slip surfaces
 F of S Rank (Query): 1 of 500 slip surfaces
 Exit: (365.6576, 1,775.9786) ft
 Entry: (802.88262, 1,892.5822) ft
 Radius: 208.81205 ft
 Center: (560.94736, 1,921.733) ft

Slip Slices

	X (ft)	Y (ft)	PWP (psf)	Base Normal Stress (psf)	Frictional Strength (psf)	Cohesive Strength (psf)
Slice 1	365.8288	1,775.9786	0	1.284	0.59873903	112.5
Slice 2	372.93412	1,775.9786	0	578.63377	375.76916	200
Slice 3	386.79168	1,775.9786	0	1,729.8764	1,123.3949	200
Slice 4	399.78632	1,776.2545	0	2,696.4754	1,751.1116	200
Slice 5	411.92877	1,776.8062	0	3,614.6239	2,347.3642	200
Slice 6	424	1,777.3547	0	4,100.2771	2,662.7511	200
Slice 7	437	1,777.9453	0	4,352.6868	2,826.6678	200
Slice 8	451	1,778.5815	0	4,804.3482	3,119.9802	200
Slice 9	461.87786	1,779.0757	0	5,140.5345	3,338.3022	200

Slice 10	466.87786	1,779.3029	0	5,382.4596	1,046.2442	150
Slice 11	476.75	1,779.7515	0	5,668.5903	1,101.8623	150
Slice 12	494.25	1,780.5466	0	6,175.8043	1,200.4547	150
Slice 13	511	1,781.3077	0	6,386.136	1,241.3391	150
Slice 14	527.75	1,782.0687	0	6,622.924	1,287.366	150
Slice 15	545.25	1,782.8639	0	7,183.0503	1,396.2435	150
Slice 16	558.5	1,783.4659	0	7,438.7712	1,445.9506	150
Slice 17	570.35	1,784.0044	0	7,463.9594	1,450.8467	150
Slice 18	585.05	1,784.6723	0	7,563.0206	1,470.1023	150
Slice 19	599.75	1,785.3402	0	7,662.0817	1,489.3578	150
Slice 20	614.45	1,786.0081	0	7,761.1428	1,508.6133	150
Slice 21	629.15	1,786.676	0	7,860.204	1,527.8689	150
Slice 22	643.85	1,787.344	0	7,959.2651	1,547.1244	150
Slice 23	658.55	1,788.0119	0	8,058.3262	1,566.3799	150
Slice 24	673.25	1,788.6798	0	8,157.3873	1,585.6355	150
Slice 25	687.95	1,789.3477	0	8,256.4485	1,604.891	150
Slice 26	702.65	1,790.0157	0	8,355.5096	1,624.1465	150
Slice 27	715.49963	1,790.5995	0	8,590.8778	1,669.8975	150
Slice 28	726.49889	1,791.0993	0	8,962.5531	1,742.1438	150
Slice 29	739.76082	1,802.4349	0	3,806.0107	3,193.6222	225
Slice 30	754.93593	1,824.1072	0	2,843.6865	2,386.1363	225
Slice 31	769.76156	1,845.2804	0	1,903.5247	1,597.2469	225
Slice 32	784.58719	1,866.4536	0	963.36303	808.35756	225
Slice 33	797.44131	1,884.8112	0	177.04466	148.55811	225

Section 20-20 Static Temporary Final SSA without key for Skyline Ranch.gsz

Section 20-20 Static Temporary Final SSA without key for Skyline Ranch.gsz Run By: Dr. Alexander Bykovtsev, Ph.D., P.E. 3/24/2016 2:21:39 PM

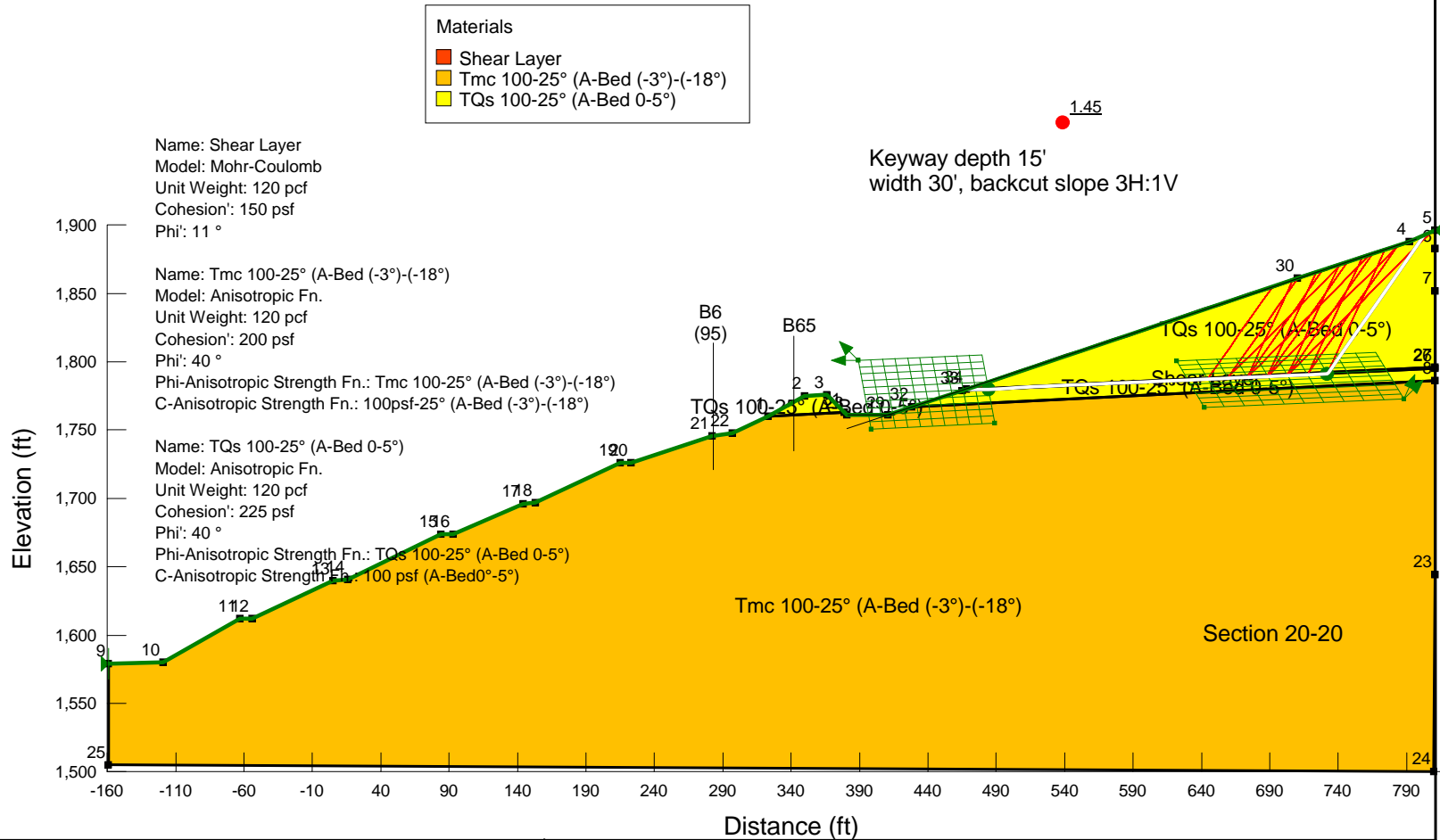

LGC Valley, Inc
 GEOTECHNICAL CONSULTING
 28532 Constellation Road, Valencia, CA 91355
 Phone 661-702-8474, Fax 661-702-8475

Skyline Ranch
 Development project, Tract 60922
 Los Angeles CA

Project No: **153035-01**
 Engineer: **BAS**
 Date: **March 2016**

2 - Translational

Report generated using GeoStudio 2012. Copyright © 1991-2015 GEO-SLOPE International Ltd.

File Information

File Version: 8.15
 Title: Static Slope Stability Analyses for Skyline Ranch Development project, Tract 60922, Los Angeles CA
 Comments: Run By: Dr. Alexander Bykovtsev, Ph.D., P.E.
 Last Edited By: Alexander Bykovtsev
 Revision Number: 183
 Date: 3/24/2016
 Time: 2:21:39 PM
 Tool Version: 8.15.1.11236
 File Name: Section 20-20 Static Temporary Final SSA without key for Skyline Ranch.gsz
 Directory: G:\SLOPE RESULTS\Section 20-20 results\
 Last Solved Date: 3/24/2016
 Last Solved Time: 2:21:52 PM

Project Settings

Length(L) Units: Feet
 Time(t) Units: Seconds
 Force(F) Units: Pounds
 Pressure(p) Units: psf
 Strength Units: psf
 Unit Weight of Water: 62.4 pcf
 View: 2D
 Element Thickness: 1

Analysis Settings

2 - Translational

Kind: SLOPE/W
 Method: Janbu
 Settings
 PWP Conditions Source: (none)
 Slip Surface
 Direction of movement: Right to Left
 Use Passive Mode: No
 Slip Surface Option: Block
 Critical slip surfaces saved: 10
 Resisting Side Maximum Convex Angle: 1 °
 Driving Side Maximum Convex Angle: 5 °
 Restrict Block Crossing: No
 Optimize Critical Slip Surface Location: No
 Tension Crack
 Tension Crack Option: (none)

F of S Distribution
 F of S Calculation Option: Constant
 Advanced
 Number of Slices: 30
 F of S Tolerance: 0.01
 Minimum Slip Surface Depth: 0.1 ft

Materials

Shear Layer

Model: Mohr-Coulomb
 Unit Weight: 120 pcf
 Cohesion: 150 psf
 Phi: 11 °
 Phi-B: 0 °

Tmc 100-25° (A-Bed (-3°)-(-18°))

Model: Anisotropic Fn.
 Unit Weight: 120 pcf
 Cohesion: 200 psf
 Phi: 40 °
 Phi-Anisotropic Strength Fn.: Tmc 100-25° (A-Bed (-3°)-(-18°))
 C-Anisotropic Strength Fn.: 100psf-25° (A-Bed (-3°)-(-18°))
 Phi-B: 0 °

TQs 100-25° (A-Bed 0-5°)

Model: Anisotropic Fn.
 Unit Weight: 120 pcf
 Cohesion: 225 psf
 Phi: 40 °
 Phi-Anisotropic Strength Fn.: TQs 100-25° (A-Bed 0-5°)
 C-Anisotropic Strength Fn.: 100 psf (A-Bed 0-5°)
 Phi-B: 0 °

Slip Surface Limits

Left Coordinate: (-159, 1,579) ft
 Right Coordinate: (811, 1,896) ft

Slip Surface Block

Left Grid
 Upper Left: (389, 1,801) ft
 Lower Left: (398.4302, 1,750.9572) ft
 Lower Right: (489, 1,755) ft
 X Increments: 10
 Y Increments: 10
 Starting Angle: 135 °
 Ending Angle: 180 °

Angle Increments: 2
 Right Grid
 Upper Left: (621.85, 1,800.3944) ft
 Lower Left: (642.3716, 1,766.6249) ft
 Lower Right: (788, 1,773) ft
 X Increments: 10
 Y Increments: 10
 Starting Angle: 45 °
 Ending Angle: 65 °
 Angle Increments: 2

Seismic Coefficients

Horz Seismic Coef.: 0
 Vert Seismic Coef.: 0

Anisotropic Strength Functions

100 psf (A-Bed 0°-5°)

Model: Spline Data Point Function
 Function: Modifier Factor vs. Inclination
 Curve Fit to Data: 100 %
 Segment Curvature: 0 %

Y-Intercept: 0.5
 Data Points: Inclination (°), Modifier Factor
 Data Point: (-90, 1)
 Data Point: (-0.9, 1)
 Data Point: (0, 0.5)
 Data Point: (5, 0.5)
 Data Point: (5.1, 1)

Tmc 100-25° (A-Bed (-3°)-(-18°))

Model: Spline Data Point Function
 Function: Modifier Factor vs. Inclination
 Curve Fit to Data: 100 %
 Segment Curvature: 0 %

Y-Intercept: 1
 Data Points: Inclination (°), Modifier Factor
 Data Point: (-90, 1)
 Data Point: (-18.1, 1)
 Data Point: (-18, 0.625)
 Data Point: (-3, 0.625)
 Data Point: (-2.9, 1)

TQs 100-25° (A-Bed 0-5°)

Model: Spline Data Point Function
 Function: Modifier Factor vs. Inclination
 Curve Fit to Data: 100 %
 Segment Curvature: 0 %

Y-Intercept: 0.625

Data Points: Inclination (°), Modifier Factor
 Data Point: (-90, 1)
 Data Point: (-0.9, 1)
 Data Point: (0, 0.625)
 Data Point: (5, 0.625)
 Data Point: (5.1, 1)

100psf-25° (A-Bed (-3°)-(-18°))

Model: Spline Data Point Function
 Function: Modifier Factor vs. Inclination
 Curve Fit to Data: 100 %
 Segment Curvature: 0 %

Y-Intercept: 1
 Data Points: Inclination (°), Modifier Factor
 Data Point: (-90, 1)
 Data Point: (-18.1, 1)
 Data Point: (-18, 0.5)
 Data Point: (-3, 0.5)
 Data Point: (-2.9, 1)

Points

	X (ft)	Y (ft)
Point 1	323	1,760
Point 2	350	1,775
Point 3	366	1,776
Point 4	792	1,888
Point 5	811	1,896
Point 6	811	1,883
Point 7	811	1,852
Point 8	811	1,786
Point 9	-159	1,579
Point 10	-119	1,580
Point 11	-63	1,612
Point 12	-54	1,612
Point 13	5	1,640
Point 14	16	1,641
Point 15	84	1,674
Point 16	93	1,674
Point 17	144	1,696
Point 18	153	1,697
Point 19	215	1,726
Point 20	223	1,726
Point 21	282	1,746
Point 22	297	1,748
Point 23	811	1,644
Point 24	810	1,500

Point 25	-159	1,505
Point 26	811	1,795
Point 27	811	1,796
Point 28	381	1,761
Point 29	411	1,761
Point 30	710	1,861
Point 31	379	1,763
Point 32	428	1,767
Point 33	465	1,779
Point 34	468	1,780

Regions

	Material	Points	Area (ft²)
Region 1	Tmc 100-25° (A-Bed (-3°)-(- 18°)	9,25,24,23,8,32,29,28,31,1,22,21,20,19,18,17,16,15,14,13,12,11,10	2.1207e+005
Region 2	Shear Layer	26,27,34,33	320.5
Region 3	TQs 100-25° (A-Bed 0-5°)	7,6,5,4,30,34,27	16,934
Region 4	TQs 100-25° (A-Bed 0-5°)	1,31,3,2	490
Region 5	TQs 100-25° (A-Bed 0-5°)	8,26,33,32	3,503.5

Current Slip Surface

Slip Surface: 71,732
 F of S: 1.45
 Volume: 12,949.205 ft³

Weight: 1,553,904.6 lbs
 Resisting Force: 432,084.76 lbs
 Activating Force: 298,222.81 lbs
 F of S Rank (Analysis): 1 of 131,769 slip surfaces
 F of S Rank (Query): 1 of 500 slip surfaces
 Exit: (468.06394, 1,780.0214) ft
 Entry: (802.88262, 1,892.5822) ft
 Radius: 177.45619 ft
 Center: (607.09242, 1,920.7223) ft

Slip Slices

	X (ft)	Y (ft)	PWP (psf)	Base Normal Stress (psf)	Frictional Strength (psf)	Cohesive Strength (psf)
Slice 1	468.26135	1,780.0214	0	7.9291643	3.69743	112.5
Slice 2	476.37183	1,780.0214	0	333.68902	64.862576	150
Slice 3	489.92778	1,780.2794	0	837.28115	162.75097	150
Slice 4	501.21353	1,780.7955	0	1,226.2476	238.35839	150
Slice 5	512.49929	1,781.3116	0	1,615.2141	313.96581	150
Slice 6	523.78504	1,781.8277	0	2,004.1805	389.57323	150
Slice 7	535.0708	1,782.3438	0	2,393.147	465.18065	150
Slice 8	546.35655	1,782.8599	0	2,782.1134	540.78807	150
Slice 9	557.64231	1,783.376	0	3,171.0799	616.39549	150
Slice 10	568.92806	1,783.8921	0	3,560.0464	692.00291	150
Slice 11	580.21382	1,784.4082	0	3,949.0128	767.61033	150
Slice 12	591.49957	1,784.9243	0	4,337.9793	843.21775	150
Slice 13	602.78533	1,785.4403	0	4,726.9457	918.82517	150
Slice 14	614.07108	1,785.9564	0	5,115.9122	994.43259	150
Slice 15	625.35684	1,786.4725	0	5,504.8786	1,070.04	150
Slice 16	636.64259	1,786.9886	0	5,893.8451	1,145.6474	150
Slice 17	647.92835	1,787.5047	0	6,282.8116	1,221.2549	150
Slice 18	659.2141	1,788.0208	0	6,671.778	1,296.8623	150

Slice 19	670.49986	1,788.5369	0	7,060.7445	1,372.4697	150
Slice 20	681.78561	1,789.053	0	7,449.7109	1,448.0771	150
Slice 21	693.07137	1,789.5691	0	7,838.6774	1,523.6845	150
Slice 22	704.35712	1,790.0851	0	8,227.6438	1,599.292	150
Slice 23	715.49963	1,790.5947	0	8,608.1035	1,673.2458	150
Slice 24	726.49889	1,791.0977	0	8,980.0563	1,745.5461	150
Slice 25	732.34801	1,791.8483	0	7,574.0834	1,472.2527	150
Slice 26	738.62774	1,800.8167	0	4,439.6407	3,725.3009	225
Slice 27	750.48824	1,817.7552	0	3,585.5992	3,008.675	225
Slice 28	762.34875	1,834.6938	0	2,731.5577	2,292.0491	225
Slice 29	774.20925	1,851.6323	0	1,877.5163	1,575.4232	225
Slice 30	786.06975	1,868.5709	0	1,023.4748	858.79732	225
Slice 31	797.44131	1,884.8112	0	237.36695	199.17452	225

Section 21-21 Static Final SSA with key for Skyline Ranch.gsz

Section 21-21 Static Final SSA with key for Skyline Ranch.gsz Run By: Dr. Alexander Bykovtsev, Ph.D., P.E. 3/24/2016 11:17:07 AM

Materials	
	TQs 100- 25° (A-bedding 4-21°)
	Fill
	Tmc 150-17° (A-bed (-2°)-(2°))

Keyway depth 25'
width 60', backcut slope 2H:1V

Name: TQs 100- 25° (A-bedding 4-21°)
Model: Anisotropic Fn.
Unit Weight: 120 pcf
Cohesion': 225 psf
Phi': 40 °
Phi-Anisotropic Strength Fn.: TQs 100- 25° (A-bedding 4-21°)
C-Anisotropic Strength Fn.: 100psf- 25° (A-bedding 4-21°)

Name: Fill
Model: Mohr-Coulomb
Unit Weight: 120 pcf
Cohesion': 200 psf
Phi': 33 °

Name: Tmc 150-17° (A-bed (-2°)-(2°))
Model: Anisotropic Fn.
Unit Weight: 120 pcf
Cohesion': 200 psf
Phi': 40 °
Phi-Anisotropic Strength Fn.: Tmc 150-17° (A-bed (-2°)-(2°))
C-Anisotropic Strength Fn.: 150psf-17° (A-bed (-2°)-(2°))

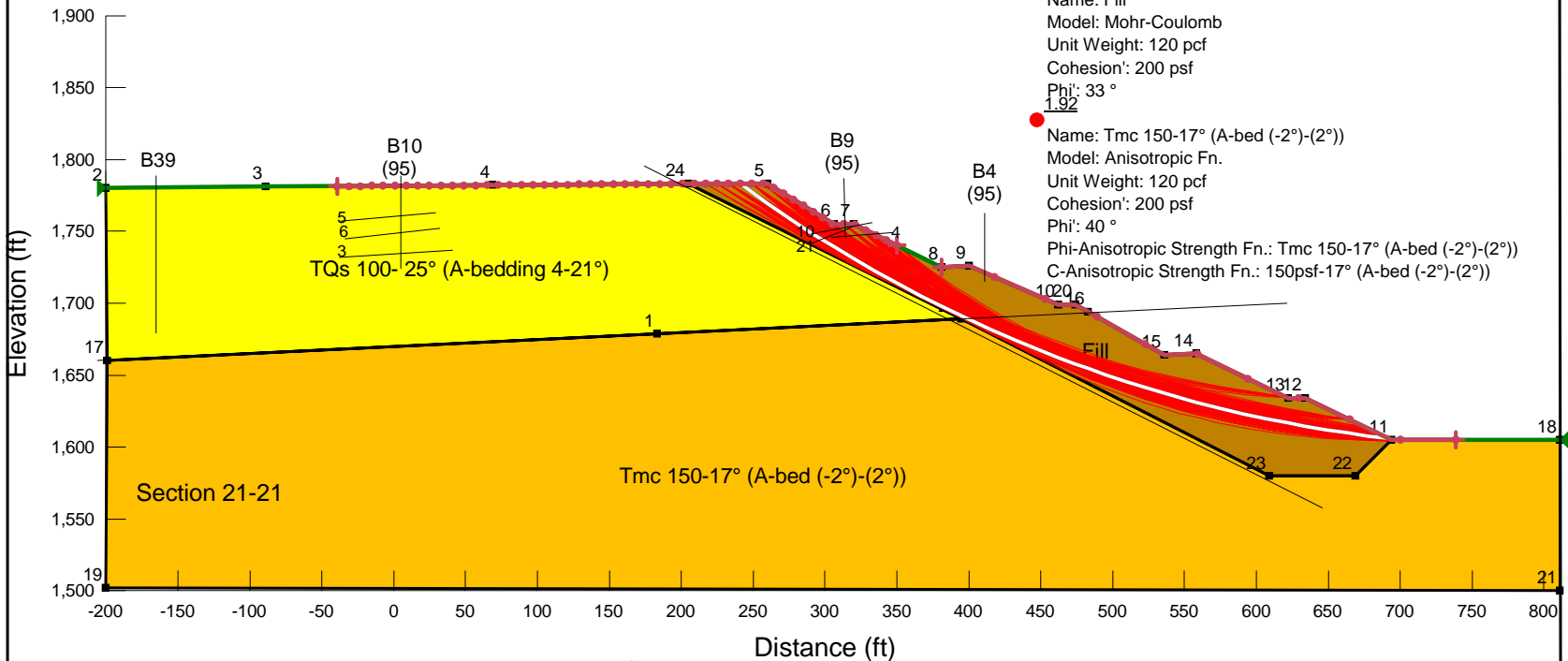

	LGC Valley, Inc GEOTECHNICAL CONSULTING 28532 Constellation Road, Valencia, CA 91355 Phone 661-702-8474, Fax 661-702-8475	Skyline Ranch Development project, Tract 60922 Los Angeles CA	Project No: 153035-01 Engineer: BAS Date: March 2016
---	---	--	---

1 - Circular Mode of Failure

Report generated using GeoStudio 2012. Copyright © 1991-2015 GEO-SLOPE International Ltd.

File Information

File Version: 8.15
 Title: Static Slope Stability Analyses for Skyline Ranch Development project, Tract 60922, Los Angeles CA
 Comments: Run By: Dr. Alexander Bykovtsev, Ph.D., P.E.
 Last Edited By: Alexander Bykovtsev
 Revision Number: 139
 Date: 3/24/2016
 Time: 11:17:07 AM
 Tool Version: 8.15.1.11236
 File Name: Section 21-21 Static Final SSA with key for Skyline Ranch.gsz
 Directory: G:\SLOPE RESULTS\Section 21-21 results\
 Last Solved Date: 3/24/2016
 Last Solved Time: 11:17:14 AM

Project Settings

Length(L) Units: Feet
 Time(t) Units: Seconds
 Force(F) Units: Pounds
 Pressure(p) Units: psf
 Strength Units: psf
 Unit Weight of Water: 62.4 pcf
 View: 2D
 Element Thickness: 1

Analysis Settings

1 - Circular Mode of Failure

Kind: SLOPE/W
 Method: Bishop
 Settings
 PWP Conditions Source: (none)
 Slip Surface
 Direction of movement: Left to Right
 Use Passive Mode: No
 Slip Surface Option: Entry and Exit
 Critical slip surfaces saved: 1
 Resisting Side Maximum Convex Angle: 1 °
 Driving Side Maximum Convex Angle: 5 °
 Optimize Critical Slip Surface Location: No
 Tension Crack
 Tension Crack Option: (none)

file:///G:/SLOPE%20RESULTS/Section%2021-21%20results/section%2021-21%20static... 3/24/2016

F of S Distribution
 F of S Calculation Option: Constant
 Advanced
 Number of Slices: 30
 F of S Tolerance: 0.01
 Minimum Slip Surface Depth: 0.1 ft

Materials

TQs 100- 25° (A-bedding 4-21°)

Model: Anisotropic Fn.
 Unit Weight: 120 pcf
 Cohesion': 225 psf
 Phi': 40 °
 Phi-Anisotropic Strength Fn.: TQs 100- 25° (A-bedding 4-21°)
 C-Anisotropic Strength Fn.: 100psf- 25° (A-bedding 4-21°)
 Phi-B: 0 °

Fill

Model: Mohr-Coulomb
 Unit Weight: 120 pcf
 Cohesion': 200 psf
 Phi': 33 °
 Phi-B: 0 °

Tmc 150-17° (A-bed (-2°)-(2°))

Model: Anisotropic Fn.
 Unit Weight: 120 pcf
 Cohesion': 200 psf
 Phi': 40 °
 Phi-Anisotropic Strength Fn.: Tmc 150-17° (A-bed (-2°)-(2°))
 C-Anisotropic Strength Fn.: 150psf-17° (A-bed (-2°)-(2°))
 Phi-B: 0 °

Slip Surface Entry and Exit

Left Projection: Range
 Left-Zone Left Coordinate: (-39.1067, 1,781.3158) ft
 Left-Zone Right Coordinate: (349.9651, 1,740.2631) ft
 Left-Zone Increment: 50
 Right Projection: Range
 Right-Zone Left Coordinate: (380.965, 1,725.0172) ft
 Right-Zone Right Coordinate: (739.0283, 1,605) ft
 Right-Zone Increment: 10
 Radius Increments: 50

Slip Surface Limits

file:///G:/SLOPE%20RESULTS/Section%2021-21%20results/section%2021-21%20static... 3/24/2016

Left Coordinate: (-200, 1,780) ft
 Right Coordinate: (811, 1,605) ft

Seismic Coefficients

Horz Seismic Coef.: 0
 Vert Seismic Coef.: 0

Anisotropic Strength Functions

Tmc 150-17° (A-bed (-2°)-(2°))

Model: Spline Data Point Function
 Function: Modifier Factor vs. Inclination
 Curve Fit to Data: 100 %
 Segment Curvature: 0 %

Y-Intercept: 0.425

Data Points: Inclination (°), Modifier Factor

- Data Point: (-90, 1)
- Data Point: (-2.1, 1)
- Data Point: (-2, 0.425)
- Data Point: (2, 0.425)
- Data Point: (2.1, 1)

TQs 100- 25° (A-bedding 4-21°)

Model: Spline Data Point Function
 Function: Modifier Factor vs. Inclination
 Curve Fit to Data: 100 %
 Segment Curvature: 0 %

Y-Intercept: 1

Data Points: Inclination (°), Modifier Factor

- Data Point: (-90, 1)
- Data Point: (3.9, 1)
- Data Point: (4, 0.625)
- Data Point: (21, 0.625)
- Data Point: (21.1, 1)

150psf-17° (A-bed (-2°)-(2°))

Model: Spline Data Point Function
 Function: Modifier Factor vs. Inclination
 Curve Fit to Data: 100 %
 Segment Curvature: 0 %

Y-Intercept: 0.75

Data Points: Inclination (°), Modifier Factor

- Data Point: (-90, 1)
- Data Point: (-2.1, 1)
- Data Point: (-2, 0.75)
- Data Point: (2, 0.75)
- Data Point: (2.1, 1)

100psf- 25° (A-bedding 4-21°)

Model: Spline Data Point Function
 Function: Modifier Factor vs. Inclination
 Curve Fit to Data: 100 %
 Segment Curvature: 0 %

Y-Intercept: 1

Data Points: Inclination (°), Modifier Factor

- Data Point: (-90, 1)
- Data Point: (3.9, 1)
- Data Point: (4, 0.444)
- Data Point: (21, 0.444)
- Data Point: (21.1, 1)

Points

	X (ft)	Y (ft)
Point 1	183	1,679
Point 2	-200	1,780
Point 3	-89	1,781
Point 4	69	1,782
Point 5	260	1,783
Point 6	306	1,755
Point 7	320	1,755
Point 8	381	1,725
Point 9	400	1,726
Point 10	462	1,699
Point 11	694	1,605
Point 12	634	1,634
Point 13	622	1,634
Point 14	558	1,665
Point 15	536	1,664
Point 16	483	1,694
Point 17	-199	1,660
Point 18	811	1,605
Point 19	-200	1,502
Point 20	474	1,699
Point 21	811	1,500
Point 22	669	1,580
Point 23	609	1,580
Point 24	205	1,783
Point 25	394.7786	1,689.3389

Regions

	Material	Points	Area (ft²)

Region 1	Tmc 150-17° (A-bed (-2°)-(2°))	17,19,21,18,11,22,23,25,1	1.5107e+005
Region 2	TQs 100- 25° (A-bedding 4-21°)	17,1,25,24,4,3,2	54,880
Region 3	Fill	11,12,13,14,15,16,20,10,9,8,7,6,5,24,25,23,22	18,436

Current Slip Surface

Slip Surface: 20,103
 F of S: 1.92
 Volume: 11,340,004 ft³
 Weight: 1,360,800.4 lbs
 Resisting Moment: 8.7742978e+008 lbs-ft
 Activating Moment: 4.5727768e+008 lbs-ft
 F of S Rank (Analysis): 1 of 28,611 slip surfaces
 F of S Rank (Query): 1 of 150 slip surfaces
 Exit: (692.11664, 1,605.9103) ft
 Entry: (241.1374, 1,783) ft
 Radius: 943.06163 ft
 Center: (799.75699, 2,542.8088) ft

Slip Slices

	X (ft)	Y (ft)	PWP (psf)	Base Normal Stress (psf)	Frictional Strength (psf)	Cohesive Strength (psf)
Slice 1	250.5687	1,776.2432	0	592.73178	384.92452	200
Slice 2	267.66667	1,764.2467	0	1,315.4245	854.24665	200
Slice 3	283	1,753.9847	0	1,419.3917	921.76373	200
Slice 4	298.33333	1,744.1489	0	1,482.2639	962.59344	200
Slice 5	313	1,735.117	0	1,930.1136	1,253.4304	200
Slice 6	327.625	1,726.4884	0	2,435.1886	1,581.43	200
Slice 7	342.875	1,717.8554	0	2,568.8728	1,668.2455	200
Slice 8	358.125	1,709.591	0	2,666.2898	1,731.5089	200
Slice 9	373.375	1,701.6842	0	2,727.7958	1,771.4513	200
Slice 10	390.5	1,693.2426	0	3,285.7949	2,133.8202	200
Slice 11	407.75	1,685.124	0	3,856.7852	2,504.6256	200
	423.25	1,678.207	0	3,900.7414	2,533.1711	200

Slice						
Slice 12						
Slice 13	438.75	1,671.6206	0	3,909.8234	2,539.069	200
Slice 14	454.25	1,665.3575	0	3,884.2063	2,522.4331	200
Slice 15	468	1,660.0509	0	4,112.4291	2,670.6427	200
Slice 16	478.5	1,656.1655	0	4,278.4935	2,778.4861	200
Slice 17	489.625	1,652.228	0	4,049.7653	2,629.9483	200
Slice 18	502.875	1,647.7235	0	3,748.4572	2,434.2765	200
Slice 19	516.125	1,643.4369	0	3,420.2104	2,221.1106	200
Slice 20	529.375	1,639.3648	0	3,065.0483	1,990.4656	200
Slice 21	547	1,634.3217	0	3,283.675	2,132.4435	200
Slice 22	566	1,629.2144	0	3,499.9805	2,272.9139	200
Slice 23	582	1,625.2689	0	3,099.4311	2,012.7941	200
Slice 24	598	1,621.6181	0	2,661.0562	1,728.1101	200
Slice 25	614	1,618.2586	0	2,184.7026	1,418.7625	200
Slice 26	628	1,615.5399	0	2,066.5586	1,342.0388	200
Slice 27	641.26458	1,613.19	0	1,945.9787	1,263.7334	200
Slice 28	655.79374	1,610.8293	0	1,425.9278	926.00832	200
Slice 29	670.3229	1,608.7005	0	873.86398	567.4939	200
Slice 30	684.85206	1,606.8021	0	289.53849	188.0285	200

Section 21-21 Seismic Final SSA with key for Skyline Ranch.gsz

Section 21-21 Seismic Final SSA with key for Skyline Ranch.gsz Run By: Dr. Alexander Bykovtsev, Ph.D., P.E. 3/24/2016 11:09:07 AM

- Materials**
- TQs 100- 25° (A-bedding 4-21°)
 - Fill
 - Tmc 150-17° (A-bed (-2°)-(2°))

Seismic load
 Horizontal: 0.15
 Vertical: 0.0

Keyway depth 25'
 width 60', backcut slope 2H:1V

Name: TQs 100- 25° (A-bedding 4-21°)
 Model: Anisotropic Fn.
 Unit Weight: 120 pcf
 Cohesion: 225 psf
 Phi: 40 °
 Phi-Anisotropic Strength Fn.: TQs 100- 25° (A-bedding 4-21°)
 C-Anisotropic Strength Fn.: 100psf- 25° (A-bedding 4-21°)

Name: Fill
 Model: Mohr-Coulomb
 Unit Weight: 120 pcf
 Cohesion: 200 psf
 Phi: 33 °

Name: Tmc 150-17° (A-bed (-2°)-(2°))
 Model: Anisotropic Fn.
 Unit Weight: 120 pcf
 Cohesion: 200 psf
 Phi: 40 °
 Phi-Anisotropic Strength Fn.: Tmc 150-17° (A-bed (-2°)-(2°))
 C-Anisotropic Strength Fn.: 150psf-17° (A-bed (-2°)-(2°))

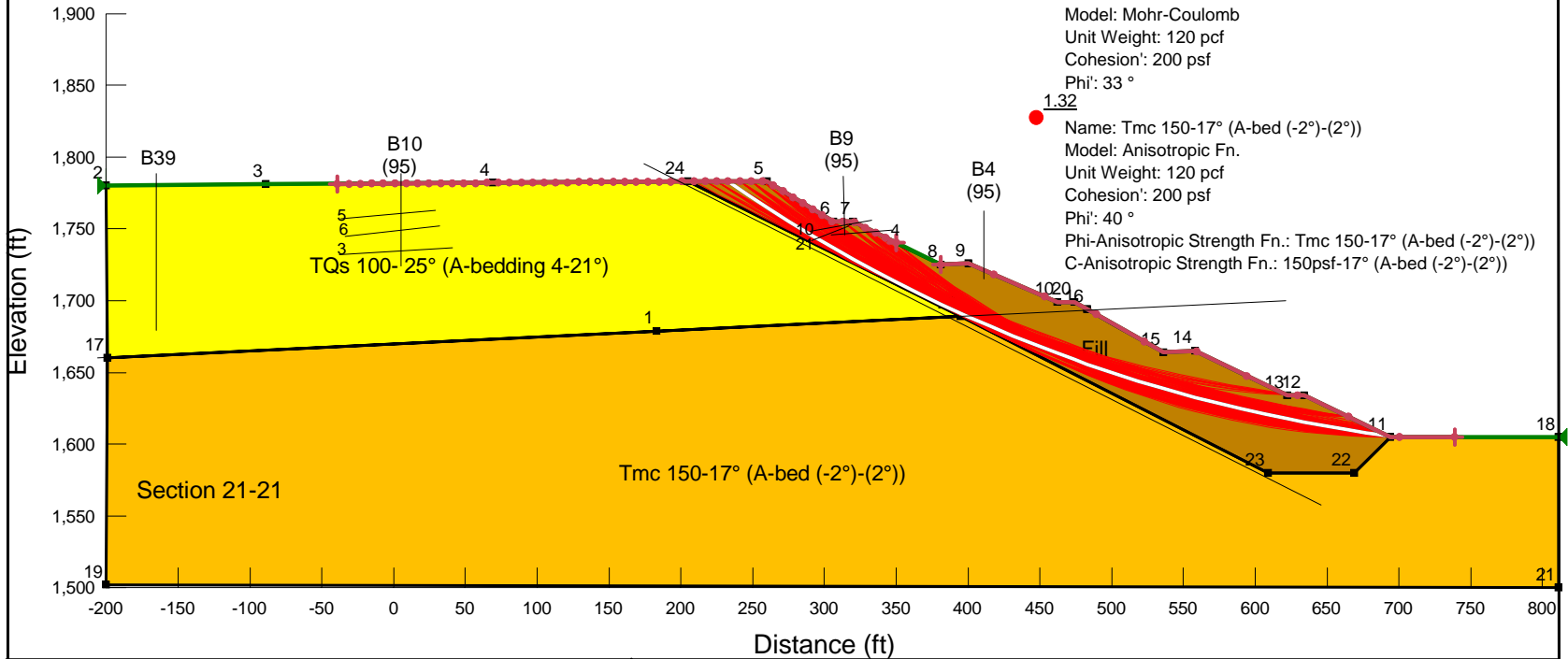

LGC Valley, Inc
 GEOTECHNICAL CONSULTING
 28532 Constellation Road, Valencia, CA 91355
 Phone 661-702-8474, Fax 661-702-8475

Skyline Ranch
 Development project, Tract 60922
 Los Angeles CA

Project No: **153035-01**
 Engineer: **BAS**
 Date: **March 2016**

1 - Circular Mode of Failure

Report generated using GeoStudio 2012. Copyright © 1991-2015 GEO-SLOPE International Ltd.

File Information

File Version: 8.15
 Title: Static Slope Stability Analyses for Skyline Ranch Development project, Tract 60922, Los Angeles CA
 Comments: Run By: Dr. Alexander Bykovtsev, Ph.D., P.E.
 Last Edited By: Alexander Bykovtsev
 Revision Number: 136
 Date: 3/24/2016
 Time: 11:09:07 AM
 Tool Version: 8.15.1.11236
 File Name: Section 21-21 Seismic Final SSA with key for Skyline Ranch.gsz
 Directory: G:\SLOPE RESULTS\Section 21-21 results\
 Last Solved Date: 3/24/2016
 Last Solved Time: 11:09:12 AM

Project Settings

Length(L) Units: Feet
 Time(t) Units: Seconds
 Force(F) Units: Pounds
 Pressure(p) Units: psf
 Strength Units: psf
 Unit Weight of Water: 62.4 pcf
 View: 2D
 Element Thickness: 1

Analysis Settings

1 - Circular Mode of Failure

Kind: SLOPE/W
 Method: Bishop
 Settings
 PWP Conditions Source: (none)
 Slip Surface
 Direction of movement: Left to Right
 Use Passive Mode: No
 Slip Surface Option: Entry and Exit
 Critical slip surfaces saved: 1
 Resisting Side Maximum Convex Angle: 1 °
 Driving Side Maximum Convex Angle: 5 °
 Optimize Critical Slip Surface Location: No
 Tension Crack
 Tension Crack Option: (none)

F of S Distribution
 F of S Calculation Option: Constant
 Advanced
 Number of Slices: 30
 F of S Tolerance: 0.01
 Minimum Slip Surface Depth: 0.1 ft

Materials

TQs 100- 25° (A-bedding 4-21°)

Model: Anisotropic Fn.
 Unit Weight: 120 pcf
 Cohesion': 225 psf
 Phi': 40 °
 Phi-Anisotropic Strength Fn.: TQs 100- 25° (A-bedding 4-21°)
 C-Anisotropic Strength Fn.: 100psf- 25° (A-bedding 4-21°)
 Phi-B: 0 °

Fill

Model: Mohr-Coulomb
 Unit Weight: 120 pcf
 Cohesion': 200 psf
 Phi': 33 °
 Phi-B: 0 °

Tmc 150-17° (A-bed (-2°)-(2°))

Model: Anisotropic Fn.
 Unit Weight: 120 pcf
 Cohesion': 200 psf
 Phi': 40 °
 Phi-Anisotropic Strength Fn.: Tmc 150-17° (A-bed (-2°)-(2°))
 C-Anisotropic Strength Fn.: 150psf-17° (A-bed (-2°)-(2°))
 Phi-B: 0 °

Slip Surface Entry and Exit

Left Projection: Range
 Left-Zone Left Coordinate: (-39.1067, 1,781.3158) ft
 Left-Zone Right Coordinate: (349.9651, 1,740.2631) ft
 Left-Zone Increment: 50
 Right Projection: Range
 Right-Zone Left Coordinate: (380.965, 1,725.0172) ft
 Right-Zone Right Coordinate: (739.0283, 1,605) ft
 Right-Zone Increment: 10
 Radius Increments: 50

Slip Surface Limits

Left Coordinate: (-200, 1,780) ft
 Right Coordinate: (811, 1,605) ft

Seismic Coefficients

Horz Seismic Coef.: 0.15
 Vert Seismic Coef.: 0

Anisotropic Strength Functions

Tmc 150-17° (A-bed (-2°)-(2°))

Model: Spline Data Point Function
 Function: Modifier Factor vs. Inclination
 Curve Fit to Data: 100 %
 Segment Curvature: 0 %

Y-Intercept: 0.425

Data Points: Inclination (°), Modifier Factor

- Data Point: (-90, 1)
- Data Point: (-2.1, 1)
- Data Point: (-2, 0.425)
- Data Point: (2, 0.425)
- Data Point: (2.1, 1)

TQs 100- 25° (A-bedding 4-21°)

Model: Spline Data Point Function
 Function: Modifier Factor vs. Inclination
 Curve Fit to Data: 100 %
 Segment Curvature: 0 %

Y-Intercept: 1

Data Points: Inclination (°), Modifier Factor

- Data Point: (-90, 1)
- Data Point: (3.9, 1)
- Data Point: (4, 0.625)
- Data Point: (21, 0.625)
- Data Point: (21.1, 1)

150psf-17° (A-bed (-2°)-(2°))

Model: Spline Data Point Function
 Function: Modifier Factor vs. Inclination
 Curve Fit to Data: 100 %
 Segment Curvature: 0 %

Y-Intercept: 0.75

Data Points: Inclination (°), Modifier Factor

- Data Point: (-90, 1)
- Data Point: (-2.1, 1)
- Data Point: (-2, 0.75)
- Data Point: (2, 0.75)
- Data Point: (2.1, 1)

100psf- 25° (A-bedding 4-21°)

Model: Spline Data Point Function
 Function: Modifier Factor vs. Inclination
 Curve Fit to Data: 100 %
 Segment Curvature: 0 %

Y-Intercept: 1

Data Points: Inclination (°), Modifier Factor

- Data Point: (-90, 1)
- Data Point: (3.9, 1)
- Data Point: (4, 0.444)
- Data Point: (21, 0.444)
- Data Point: (21.1, 1)

Points

	X (ft)	Y (ft)
Point 1	183	1,679
Point 2	-200	1,780
Point 3	-89	1,781
Point 4	69	1,782
Point 5	260	1,783
Point 6	306	1,755
Point 7	320	1,755
Point 8	381	1,725
Point 9	400	1,726
Point 10	462	1,699
Point 11	694	1,605
Point 12	634	1,634
Point 13	622	1,634
Point 14	558	1,665
Point 15	536	1,664
Point 16	483	1,694
Point 17	-199	1,660
Point 18	811	1,605
Point 19	-200	1,502
Point 20	474	1,699
Point 21	811	1,500
Point 22	669	1,580
Point 23	609	1,580
Point 24	205	1,783
Point 25	394.7786	1,689.3389

Regions

	Material	Points	Area (ft²)

Region 1	Tmc 150-17° (A-bed (-2°)-(-2°))	17,19,21,18,11,22,23,25,1	1.5107e+005
Region 2	TQs 100- 25° (A-bedding 4-21°)	17,1,25,24,4,3,2	54,880
Region 3	Fill	11,12,13,14,15,16,20,10,9,8,7,6,5,24,25,23,22	18,436

Current Slip Surface

Slip Surface: 19,541
 F of S: 1.32
 Volume: 11,409.938 ft³
 Weight: 1,369,192.5 lbs
 Resisting Moment: 9.3039048e+008 lbs-ft
 Activating Moment: 7.0610888e+008 lbs-ft
 F of S Rank (Analysis): 1 of 28,611 slip surfaces
 F of S Rank (Query): 1 of 150 slip surfaces
 Exit: (691.72283, 1,606.1006) ft
 Entry: (233.13026, 1,783) ft
 Radius: 1,045.7308 ft
 Center: (828.23993, 2,642.8821) ft

Slip Slices

	X (ft)	Y (ft)	PWP (psf)	Base Normal Stress (psf)	Frictional Strength (psf)	Cohesive Strength (psf)
Slice 1	239.84769	1,778.4278	0	333.88252	216.82585	200
Slice 2	253.28256	1,769.4337	0	1,154.6236	749.82134	200
Slice 3	267.66667	1,760.1432	0	1,590.1902	1,032.6816	200
Slice 4	283	1,750.5899	0	1,627.7071	1,057.0454	200
Slice 5	298.33333	1,741.3985	0	1,631.6461	1,059.6033	200
Slice 6	313	1,732.9283	0	2,004.7822	1,301.9208	200
Slice 7	327.625	1,724.8069	0	2,437.2277	1,582.7542	200
Slice 8	342.875	1,716.6534	0	2,522.4028	1,638.0675	200
Slice 9	358.125	1,708.8201	0	2,577.5842	1,673.9027	200
Slice 10	373.375	1,701.2989	0	2,602.8155	1,690.2881	200
Slice 11	390.5	1,693.2363	0	3,099.4505	2,012.8067	200
	407.75	1,685.4536	0	3,613.7828	2,346.818	200

Slice						
Slice 12						
Slice 13	423.25	1,678.7943	0	3,635.3004	2,360.7917	200
Slice 14	438.75	1,672.4283	0	3,627.1409	2,355.4928	200
Slice 15	454.25	1,666.3498	0	3,589.2406	2,330.8801	200
Slice 16	468	1,661.18	0	3,797.7081	2,466.2605	200
Slice 17	478.5	1,657.3813	0	3,951.1439	2,565.9029	200
Slice 18	491.83333	1,652.783	0	3,679.8981	2,389.7538	200
Slice 19	509.5	1,646.9546	0	3,280.7772	2,130.5616	200
Slice 20	527.16667	1,641.4718	0	2,838.3276	1,843.2315	200
Slice 21	547	1,635.7444	0	2,996.9507	1,946.2425	200
Slice 22	566	1,630.6002	0	3,214.3646	2,087.4328	200
Slice 23	582	1,626.5894	0	2,839.3644	1,843.9048	200
Slice 24	598	1,622.8453	0	2,429.7554	1,577.9016	200
Slice 25	614	1,619.365	0	1,985.2095	1,289.2101	200
Slice 26	628	1,616.5199	0	1,887.0695	1,225.4773	200
Slice 27	641.21535	1,614.0377	0	1,789.5293	1,162.1339	200
Slice 28	655.64606	1,611.5186	0	1,309.2381	850.22917	200
Slice 29	670.07677	1,609.2072	0	799.38585	519.12724	200
Slice 30	684.50748	1,607.1019	0	259.61725	168.59741	200

Section 21-21 Static Final SSA with key for Skyline Ranch.gsz

Section 21-21 Static Final SSA with key for Skyline Ranch.gsz Run By: Dr. Alexander Bykovtsev, Ph.D., P.E. 3/24/2016 10:48:15 AM

- Materials**
- TQs 100- 25° (A-bedding 4-21°)
 - Fill
 - Tmc 150-17° (A-bed (-2°)-(2°))

Keyway depth 25'
width 60', backcut slope 2H:1V

Name: TQs 100- 25° (A-bedding 4-21°)
Model: Anisotropic Fn.
Unit Weight: 120 pcf
Cohesion: 225 psf
Phi: 40 °
Phi-Anisotropic Strength Fn.: TQs 100- 25° (A-bedding 4-21°)
C-Anisotropic Strength Fn.: 100psf- 25° (A-bedding 4-21°)

Name: Fill
Model: Mohr-Coulomb
Unit Weight: 120 pcf
Cohesion: 200 psf
Phi: 33 °

Name: Tmc 150-17° (A-bed (-2°)-(2°))
Model: Anisotropic Fn.
Unit Weight: 120 pcf
Cohesion: 200 psf
Phi: 40 °
Phi-Anisotropic Strength Fn.: Tmc 150-17° (A-bed (-2°)-(2°))
C-Anisotropic Strength Fn.: 150psf-17° (A-bed (-2°)-(2°))

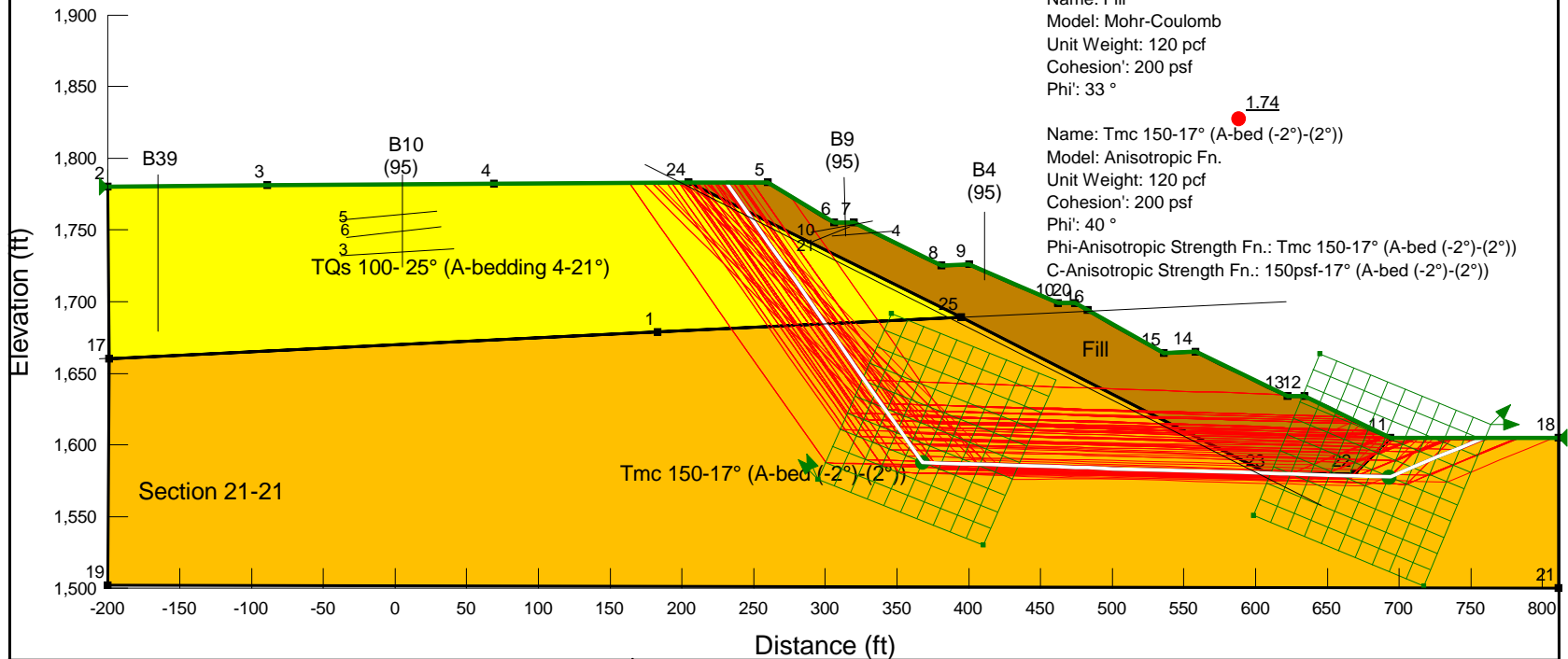

LGC Valley, Inc
GEOTECHNICAL CONSULTING
28532 Constellation Road, Valencia, CA 91355
Phone 661-702-8474, Fax 661-702-8475

Skyline Ranch
Development project, Tract 60922
Los Angeles CA

Project No: **153035-01**
Engineer: **BAS**
Date: **March 2016**

2 - Translational

Report generated using GeoStudio 2012. Copyright © 1991-2015 GEO-SLOPE International Ltd.

File Information

File Version: 8.15
 Title: Static Slope Stability Analyses for Skyline Ranch Development project, Tract 60922, Los Angeles CA
 Comments: Run By: Dr. Alexander Bykovtsev, Ph.D., P.E.
 Last Edited By: Alexander Bykovtsev
 Revision Number: 138
 Date: 3/24/2016
 Time: 10:48:15 AM
 Tool Version: 8.15.1.11236
 File Name: Section 21-21 Static Final SSA with key for Skyline Ranch.gsz
 Directory: G:\SLOPE RESULTS\Section 21-21 results\
 Last Solved Date: 3/24/2016
 Last Solved Time: 11:13:44 AM

Project Settings

Length(L) Units: Feet
 Time(t) Units: Seconds
 Force(F) Units: Pounds
 Pressure(p) Units: psf
 Strength Units: psf
 Unit Weight of Water: 62.4 pcf
 View: 2D
 Element Thickness: 1

Analysis Settings

2 - Translational

Kind: [SLOPE/W](#)
 Method: [Janbu](#)
 Settings
 PWP Conditions Source: [\(none\)](#)
 Slip Surface
 Direction of movement: [Left to Right](#)
 Use Passive Mode: [No](#)
 Slip Surface Option: [Block](#)
 Critical slip surfaces saved: [10](#)
 Resisting Side Maximum Convex Angle: [1 °](#)
 Driving Side Maximum Convex Angle: [5 °](#)
 Restrict Block Crossing: [No](#)
 Optimize Critical Slip Surface Location: [No](#)
 Tension Crack

file:///G:/SLOPE%20RESULTS/Section%2021-21%20results/section%2021-21%20static... 3/24/2016

Tension Crack Option: [\(none\)](#)
 F of S Distribution
 F of S Calculation Option: [Constant](#)
 Advanced
 Number of Slices: [30](#)
 F of S Tolerance: [0.01](#)
 Minimum Slip Surface Depth: [0.1 ft](#)

Materials

TQs 100- 25° (A-bedding 4-21°)

Model: [Anisotropic Fn.](#)
 Unit Weight: [120 pcf](#)
 Cohesion': [225 psf](#)
 Phi': [40 °](#)
 Phi-Anisotropic Strength Fn.: [TQs 100- 25° \(A-bedding 4-21°\)](#)
 C-Anisotropic Strength Fn.: [100psf- 25° \(A-bedding 4-21°\)](#)
 Phi-B: [0 °](#)

Fill

Model: [Mohr-Coulomb](#)
 Unit Weight: [120 pcf](#)
 Cohesion': [200 psf](#)
 Phi': [33 °](#)
 Phi-B: [0 °](#)

Tmc 150-17° (A-bed (-2°)-(2°))

Model: [Anisotropic Fn.](#)
 Unit Weight: [120 pcf](#)
 Cohesion': [200 psf](#)
 Phi': [40 °](#)
 Phi-Anisotropic Strength Fn.: [Tmc 150-17° \(A-bed \(-2°\)-\(2°\)\)](#)
 C-Anisotropic Strength Fn.: [150psf-17° \(A-bed \(-2°\)-\(2°\)\)](#)
 Phi-B: [0 °](#)

Slip Surface Limits

Left Coordinate: [\(-200, 1,780\) ft](#)
 Right Coordinate: [\(811, 1,605\) ft](#)

Slip Surface Block

Left Grid
 Upper Left: [\(345.9397, 1,691.465\) ft](#)
 Lower Left: [\(295.0306, 1,576.1191\) ft](#)
 Lower Right: [\(409.9866, 1,529.9807\) ft](#)
 X Increments: [10](#)
 Y Increments: [10](#)

file:///G:/SLOPE%20RESULTS/Section%2021-21%20results/section%2021-21%20static... 3/24/2016

Starting Angle: 115 °
 Ending Angle: 135 °
 Angle Increments: 2
 Right Grid
 Upper Left: (644.9611, 1,663.7267) ft
 Lower Left: (598.3451, 1,550.8695) ft
 Lower Right: (717.2158, 1,501.4945) ft
 X Increments: 10
 Y Increments: 10
 Starting Angle: 0 °
 Ending Angle: 45 °
 Angle Increments: 2

Seismic Coefficients

Horz Seismic Coef.: 0
 Vert Seismic Coef.: 0

Anisotropic Strength Functions

Tmc 150-17° (A-bed (-2°)-(2°))

Model: Spline Data Point Function
 Function: Modifier Factor vs. Inclination
 Curve Fit to Data: 100 %
 Segment Curvature: 0 %
 Y-Intercept: 0.425
 Data Points: Inclination (°), Modifier Factor
 Data Point: (-90, 1)
 Data Point: (-2.1, 1)
 Data Point: (-2, 0.425)
 Data Point: (2, 0.425)
 Data Point: (2.1, 1)

TQs 100- 25° (A-bedding 4-21°)

Model: Spline Data Point Function
 Function: Modifier Factor vs. Inclination
 Curve Fit to Data: 100 %
 Segment Curvature: 0 %
 Y-Intercept: 1
 Data Points: Inclination (°), Modifier Factor
 Data Point: (-90, 1)
 Data Point: (3.9, 1)
 Data Point: (4, 0.625)
 Data Point: (21, 0.625)
 Data Point: (21.1, 1)

150psf-17° (A-bed (-2°)-(2°))

Model: Spline Data Point Function
 Function: Modifier Factor vs. Inclination

Curve Fit to Data: 100 %
 Segment Curvature: 0 %
 Y-Intercept: 0.75
 Data Points: Inclination (°), Modifier Factor
 Data Point: (-90, 1)
 Data Point: (-2.1, 1)
 Data Point: (-2, 0.75)
 Data Point: (2, 0.75)
 Data Point: (2.1, 1)

100psf- 25° (A-bedding 4-21°)

Model: Spline Data Point Function
 Function: Modifier Factor vs. Inclination
 Curve Fit to Data: 100 %
 Segment Curvature: 0 %
 Y-Intercept: 1
 Data Points: Inclination (°), Modifier Factor
 Data Point: (-90, 1)
 Data Point: (3.9, 1)
 Data Point: (4, 0.444)
 Data Point: (21, 0.444)
 Data Point: (21.1, 1)

Points

	X (ft)	Y (ft)
Point 1	183	1,679
Point 2	-200	1,780
Point 3	-89	1,781
Point 4	69	1,782
Point 5	260	1,783
Point 6	306	1,755
Point 7	320	1,755
Point 8	381	1,725
Point 9	400	1,726
Point 10	462	1,699
Point 11	694	1,605
Point 12	634	1,634
Point 13	622	1,634
Point 14	558	1,665
Point 15	536	1,664
Point 16	483	1,694
Point 17	-199	1,660
Point 18	811	1,605
Point 19	-200	1,502
Point 20	474	1,699
Point 21	811	1,500

Point 22	669	1,580
Point 23	609	1,580
Point 24	205	1,783
Point 25	394.7786	1,689.3389

Regions

	Material	Points	Area (ft²)
Region 1	Tmc 150-17° (A-bed (-2°) (-2°))	17,19,21,18,11,22,23,25,1	1.5107e+005
Region 2	TQs 100- 25° (A-bedding 4-21°)	17,1,25,24,4,3,2	54,880
Region 3	Fill	11,12,13,14,15,16,20,10,9,8,7,6,5,24,25,23,22	18,436

Current Slip Surface

Slip Surface: 41,930
 F of S: 1.74
 Volume: 40,416.641 ft³
 Weight: 4,849,996.9 lbs
 Resisting Force: 1,895,838.6 lbs
 Activating Force: 1,087,812.1 lbs
 F of S Rank (Analysis): 1 of 131,769 slip surfaces
 F of S Rank (Query): 1 of 150 slip surfaces
 Exit: (758.94849, 1,605) ft
 Entry: (230.99836, 1,783) ft
 Radius: 290.73895 ft
 Center: (539.98336, 1,827.5) ft

Slip Slices

	X (ft)	Y (ft)	PWP (psf)	Base Normal Stress (psf)	Frictional Strength (psf)	Cohesive Strength (psf)
Slice 1	237.86261	1,773.1968	0	660.01214	428.6169	200
Slice 2	252.36343	1,752.4875	0	2,058.0993	1,726.9504	225
Slice 3	269.9566	1,727.3619	0	3,412.4242	2,863.3638	225
Slice 4	289.86979	1,698.9229	0	4,571.5966	3,836.025	225
Slice 5	302.91319	1,680.295	0	5,343.0266	4,483.3316	200
	313	1,665.8895	0	6,232.8712	5,229.9999	200

Slice						
Slice 6						
Slice 7	327.96355	1,644.5193	0	7,472.7242	6,270.3601	200
Slice 8	343.89067	1,621.7731	0	8,532.115	7,159.2946	200
Slice 9	359.81777	1,599.0268	0	9,591.5059	8,048.229	200
Slice 10	374.39067	1,587.4508	0	16,802.629	5,137.0792	150
Slice 11	387.8893	1,587.0365	0	16,507.389	5,046.8154	150
Slice 12	397.3893	1,586.745	0	16,601.867	5,075.7002	150
Slice 13	407.75	1,586.427	0	16,253.394	4,969.1613	150
Slice 14	423.25	1,585.9513	0	15,504.521	4,740.2079	150
Slice 15	438.75	1,585.4756	0	14,755.649	4,511.2545	150
Slice 16	454.25	1,584.9999	0	14,006.776	4,282.3011	150
Slice 17	468	1,584.5778	0	13,654.318	4,174.544	150
Slice 18	478.5	1,584.2556	0	13,394.392	4,095.0765	150
Slice 19	491.83333	1,583.8464	0	12,548.065	3,836.3285	150
Slice 20	509.5	1,583.3042	0	11,419.223	3,491.2067	150
Slice 21	527.16667	1,582.762	0	10,290.38	3,146.0849	150
Slice 22	547	1,582.1533	0	9,825.9316	3,004.0888	150
Slice 23	566.413	1,581.5574	0	9,470.3418	2,895.374	150
Slice 24	583.23901	1,581.041	0	8,559.2166	2,616.8151	150
Slice 25	600.06501	1,580.5246	0	7,648.0915	2,338.2562	150
Slice 26	612.81839	1,580.1332	0	6,914.8939	4,490.5846	200
Slice 27	619.57939	1,579.9257	0	6,591.3916	2,015.1906	150
Slice 28	628	1,579.6673	0	6,482.2948	1,981.8364	150
Slice 29	642.75	1,579.2146	0	6,031.5507	1,844.0301	150

Slice 30	660.25	1,578.6775	0	5,086.1046	1,554.9782	150
Slice 31	681.5	1,578.2532	0	3,924.9424	1,199.9753	150
Slice 32	702.11856	1,581.4603	0	3,590.1224	3,012.4704	200
Slice 33	718.35568	1,588.1859	0	2,581.3887	2,166.0423	200
Slice 34	734.59281	1,594.9115	0	1,572.6551	1,319.6143	200
Slice 35	750.82993	1,601.6372	0	563.92146	473.18629	200

Section 21-21 Seismic Final SSA with key for Skyline Ranch.gsz

Section 21-21 Seismic Final SSA with key for Skyline Ranch.gsz Run By: Dr. Alexander Bykovtsev, Ph.D., P.E. 3/24/2016 10:46:22 AM

Materials	
	TQs 100- 25° (A-bedding 4-21°)
	Fill
	Tmc 150-17° (A-bed (-2°)-(2°))

Seismic load
 Horizontal: 0.15
 Vertical: 0.0

Keyway depth 25'
 width 60', backcut slope 2H:1V

Name: TQs 100- 25° (A-bedding 4-21°)
 Model: Anisotropic Fn.
 Unit Weight: 120 pcf
 Cohesion: 225 psf
 Phi: 40 °
 Phi-Anisotropic Strength Fn.: TQs 100- 25° (A-bedding 4-21°)
 C-Anisotropic Strength Fn.: 100psf- 25° (A-bedding 4-21°)

Name: Fill
 Model: Mohr-Coulomb
 Unit Weight: 120 pcf
 Cohesion: 200 psf
 Phi: 33 °

Name: Tmc 150-17° (A-bed (-2°)-(2°))
 Model: Anisotropic Fn.
 Unit Weight: 120 pcf
 Cohesion: 200 psf
 Phi: 40 °
 Phi-Anisotropic Strength Fn.: Tmc 150-17° (A-bed (-2°)-(2°))
 C-Anisotropic Strength Fn.: 150psf-17° (A-bed (-2°)-(2°))

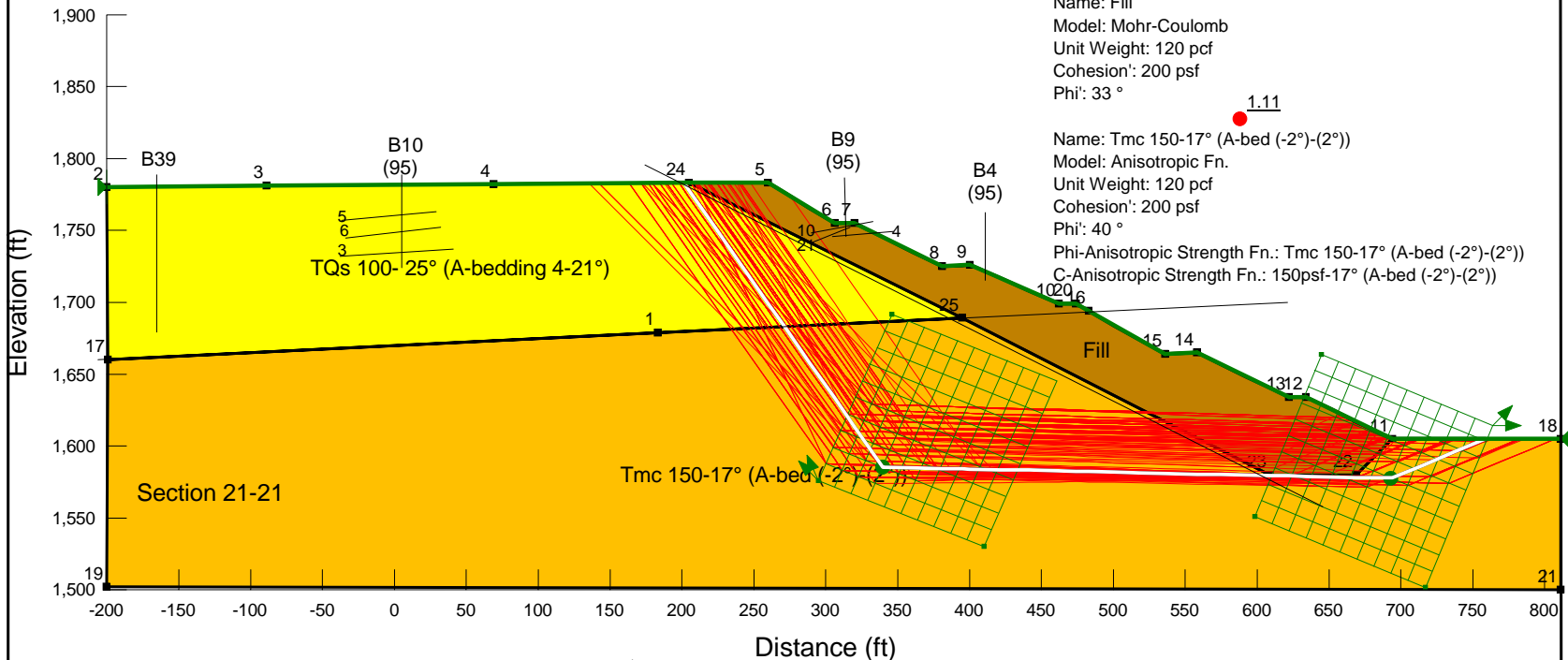

LGC Valley, Inc
 GEOTECHNICAL CONSULTING
 28532 Constellation Road, Valencia, CA 91355
 Phone 661-702-8474, Fax 661-702-8475

Skyline Ranch
 Development project, Tract 60922
 Los Angeles CA

Project No: **153035-01**
 Engineer: **BAS**
 Date: **March 2016**

2 - Translational

Report generated using GeoStudio 2012. Copyright © 1991-2015 GEO-SLOPE International Ltd.

File Information

File Version: 8.15
 Title: Static Slope Stability Analyses for Skyline Ranch Development project, Tract 60922, Los Angeles CA
 Comments: Run By: Dr. Alexander Bykovtsev, Ph.D., P.E.
 Last Edited By: Alexander Bykovtsev
 Revision Number: 135
 Date: 3/24/2016
 Time: 10:46:22 AM
 Tool Version: 8.15.1.11236
 File Name: Section 21-21 Seismic Final SSA with key for Skyline Ranch.gsz
 Directory: G:\SLOPE RESULTS\Section 21-21 results\
 Last Solved Date: 3/24/2016
 Last Solved Time: 11:06:27 AM

Project Settings

Length(L) Units: Feet
 Time(t) Units: Seconds
 Force(F) Units: Pounds
 Pressure(p) Units: psf
 Strength Units: psf
 Unit Weight of Water: 62.4 pcf
 View: 2D
 Element Thickness: 1

Analysis Settings

2 - Translational

Kind: SLOPE/W
 Method: Janbu
 Settings
 PWP Conditions Source: (none)
 Slip Surface
 Direction of movement: Left to Right
 Use Passive Mode: No
 Slip Surface Option: Block
 Critical slip surfaces saved: 10
 Resisting Side Maximum Convex Angle: 1 °
 Driving Side Maximum Convex Angle: 5 °
 Restrict Block Crossing: No
 Optimize Critical Slip Surface Location: No
 Tension Crack

file:///G:/SLOPE%20RESULTS/Section%2021-21%20results/section%2021-21%20seismi... 3/24/2016

Tension Crack Option: (none)
 F of S Distribution
 F of S Calculation Option: Constant
 Advanced
 Number of Slices: 30
 F of S Tolerance: 0.01
 Minimum Slip Surface Depth: 0.1 ft

Materials

TQs 100- 25° (A-bedding 4-21°)

Model: Anisotropic Fn.
 Unit Weight: 120 pcf
 Cohesion': 225 psf
 Phi': 40 °
 Phi-Anisotropic Strength Fn.: TQs 100- 25° (A-bedding 4-21°)
 C-Anisotropic Strength Fn.: 100psf- 25° (A-bedding 4-21°)
 Phi-B: 0 °

Fill

Model: Mohr-Coulomb
 Unit Weight: 120 pcf
 Cohesion': 200 psf
 Phi': 33 °
 Phi-B: 0 °

Tmc 150-17° (A-bed (-2°)-(2°))

Model: Anisotropic Fn.
 Unit Weight: 120 pcf
 Cohesion': 200 psf
 Phi': 40 °
 Phi-Anisotropic Strength Fn.: Tmc 150-17° (A-bed (-2°)-(2°))
 C-Anisotropic Strength Fn.: 150psf-17° (A-bed (-2°)-(2°))
 Phi-B: 0 °

Slip Surface Limits

Left Coordinate: (-200, 1,780) ft
 Right Coordinate: (811, 1,605) ft

Slip Surface Block

Left Grid
 Upper Left: (345.9397, 1,691.465) ft
 Lower Left: (295.0306, 1,576.1191) ft
 Lower Right: (409.9866, 1,529.9807) ft
 X Increments: 10
 Y Increments: 10

file:///G:/SLOPE%20RESULTS/Section%2021-21%20results/section%2021-21%20seismi... 3/24/2016

Starting Angle: 115 °
 Ending Angle: 135 °
 Angle Increments: 2
 Right Grid
 Upper Left: (644.9611, 1,663.7267) ft
 Lower Left: (598.3451, 1,550.8695) ft
 Lower Right: (717.2158, 1,501.4945) ft
 X Increments: 10
 Y Increments: 10
 Starting Angle: 0 °
 Ending Angle: 45 °
 Angle Increments: 2

Seismic Coefficients

Horz Seismic Coef.: 0.15
 Vert Seismic Coef.: 0

Anisotropic Strength Functions

Tmc 150-17° (A-bed (-2°)-(2°))

Model: Spline Data Point Function
 Function: Modifier Factor vs. Inclination
 Curve Fit to Data: 100 %
 Segment Curvature: 0 %
 Y-Intercept: 0.425
 Data Points: Inclination (°), Modifier Factor
 Data Point: (-90, 1)
 Data Point: (-2.1, 1)
 Data Point: (-2, 0.425)
 Data Point: (2, 0.425)
 Data Point: (2.1, 1)

TQs 100- 25° (A-bedding 4-21°)

Model: Spline Data Point Function
 Function: Modifier Factor vs. Inclination
 Curve Fit to Data: 100 %
 Segment Curvature: 0 %
 Y-Intercept: 1
 Data Points: Inclination (°), Modifier Factor
 Data Point: (-90, 1)
 Data Point: (3.9, 1)
 Data Point: (4, 0.625)
 Data Point: (21, 0.625)
 Data Point: (21.1, 1)

150psf-17° (A-bed (-2°)-(2°))

Model: Spline Data Point Function
 Function: Modifier Factor vs. Inclination

Curve Fit to Data: 100 %
 Segment Curvature: 0 %
 Y-Intercept: 0.75
 Data Points: Inclination (°), Modifier Factor
 Data Point: (-90, 1)
 Data Point: (-2.1, 1)
 Data Point: (-2, 0.75)
 Data Point: (2, 0.75)
 Data Point: (2.1, 1)

100psf- 25° (A-bedding 4-21°)

Model: Spline Data Point Function
 Function: Modifier Factor vs. Inclination
 Curve Fit to Data: 100 %
 Segment Curvature: 0 %
 Y-Intercept: 1
 Data Points: Inclination (°), Modifier Factor
 Data Point: (-90, 1)
 Data Point: (3.9, 1)
 Data Point: (4, 0.444)
 Data Point: (21, 0.444)
 Data Point: (21.1, 1)

Points

	X (ft)	Y (ft)
Point 1	183	1,679
Point 2	-200	1,780
Point 3	-89	1,781
Point 4	69	1,782
Point 5	260	1,783
Point 6	306	1,755
Point 7	320	1,755
Point 8	381	1,725
Point 9	400	1,726
Point 10	462	1,699
Point 11	694	1,605
Point 12	634	1,634
Point 13	622	1,634
Point 14	558	1,665
Point 15	536	1,664
Point 16	483	1,694
Point 17	-199	1,660
Point 18	811	1,605
Point 19	-200	1,502
Point 20	474	1,699
Point 21	811	1,500

Point 22	669	1,580
Point 23	609	1,580
Point 24	205	1,783
Point 25	394.7786	1,689.3389

Regions

	Material	Points	Area (ft²)
Region 1	Tmc 150-17° (A-bed (-2°) (-2°))	17,19,21,18,11,22,23,25,1	1.5107e+005
Region 2	TQs 100- 25° (A-bedding 4-21°)	17,1,25,24,4,3,2	54,880
Region 3	Fill	11,12,13,14,15,16,20,10,9,8,7,6,5,24,25,23,22	18,436

Current Slip Surface

Slip Surface: 27,773
 F of S: 1.11
 Volume: 46,767.473 ft³
 Weight: 5,612,096.8 lbs
 Resisting Force: 2,032,506.4 lbs
 Activating Force: 1,827,168.4 lbs
 F of S Rank (Analysis): 1 of 131,769 slip surfaces
 F of S Rank (Query): 1 of 150 slip surfaces
 Exit: (758.94849, 1,605) ft
 Entry: (201.31988, 1,782.9729) ft
 Radius: 299.26834 ft
 Center: (522.73561, 1,827.4662) ft

Slip Slices

	X (ft)	Y (ft)	PWP (psf)	Base Normal Stress (psf)	Frictional Strength (psf)	Cohesive Strength (psf)
Slice 1	203.15994	1,780.3451	0	13.993672	11.742085	225
Slice 2	214.16667	1,764.6258	0	924.34296	775.61584	225
Slice 3	232.5	1,738.4431	0	2,439.3604	2,046.8664	225
Slice 4	250.83333	1,712.2604	0	3,954.3779	3,318.117	225
Slice 5	265.55529	1,691.2353	0	4,975.2971	4,174.77	225
	279.83293	1,670.8447	0	5,667.716	4,755.7784	200

Slice						
Slice 6						
Slice 7	297.27764	1,645.9311	0	6,494.878	5,449.8497	200
Slice 8	313	1,623.4772	0	7,486.9202	6,282.272	200
Slice 9	329.84961	1,599.4135	0	8,599.033	7,215.4454	200
Slice 10	350.02441	1,585.1225	0	18,500.355	5,656.1262	150
Slice 11	370.6748	1,584.6739	0	17,342.361	5,302.092	150
Slice 12	387.8893	1,584.3	0	16,824.47	5,143.7566	150
Slice 13	397.3893	1,584.0937	0	16,908.731	5,169.5178	150
Slice 14	410.33333	1,583.8125	0	16,421.856	5,020.6653	150
Slice 15	431	1,583.3636	0	15,401.796	4,708.8015	150
Slice 16	451.66667	1,582.9147	0	14,381.735	4,396.9377	150
Slice 17	468	1,582.5599	0	13,887.252	4,245.7589	150
Slice 18	478.5	1,582.3318	0	13,616.234	4,162.9004	150
Slice 19	491.83333	1,582.0422	0	12,756.106	3,899.9331	150
Slice 20	509.5	1,581.6584	0	11,608.982	3,549.2221	150
Slice 21	527.16667	1,581.2747	0	10,461.858	3,198.511	150
Slice 22	547	1,580.8439	0	9,976.4437	3,050.1049	150
Slice 23	566.5	1,580.4203	0	9,595.4765	2,933.6316	150
Slice 24	583.5	1,580.0511	0	8,657.2465	2,646.7859	150
Slice 25	600.5	1,579.6818	0	7,719.0165	2,359.9402	150
Slice 26	615.5	1,579.356	0	6,891.1665	2,106.841	150
Slice 27	628	1,579.0845	0	6,547.9785	2,001.9179	150
Slice 28	642.75	1,578.7641	0	6,081.7002	1,859.3623	150
Slice 29	660.25	1,578.3839	0	5,118.0497	1,564.7448	150

Slice 30	681.5	1,578.1457	0	3,942.8349	1,205.4456	150
Slice 31	704.82475	1,582.5812	0	4,014.9791	3,368.9675	200
Slice 32	726.47425	1,591.5487	0	2,452.1136	2,057.5677	200
Slice 33	748.12374	1,600.5162	0	889.24821	746.16784	200

Section 21-21 Static Temporary Final SSA without key for Skyline Ranch.gsz

Section 21-21 Static Temporary Final SSA without key for Skyline Ranch.gsz Run By: Dr. Alexander Bykovtsev, Ph.D., P.E. 3/24/2016 10:53:54 AM

Materials	
	TQs 100- 25° (A-bedding 4-21°)
	Tmc 150-17° (A-bed (-2°)-(2°))

Keyway depth 25'
width 60', backcut slope 2H:1V

Name: TQs 100- 25° (A-bedding 4-21°)
Model: Anisotropic Fn.
Unit Weight: 120 pcf
Cohesion': 225 psf
Phi': 40 °
Phi-Anisotropic Strength Fn.: TQs 100- 25° (A-bedding 4-21°)
C-Anisotropic Strength Fn.: 100psf- 25° (A-bedding 4-21°)

Name: Tmc 150-17° (A-bed (-2°)-(2°))
Model: Anisotropic Fn.
Unit Weight: 120 pcf
Cohesion': 200 psf
Phi': 40 °
Phi-Anisotropic Strength Fn.: Tmc 150-17° (A-bed (-2°)-(2°))
C-Anisotropic Strength Fn.: 150psf-17° (A-bed (-2°)-(2°))

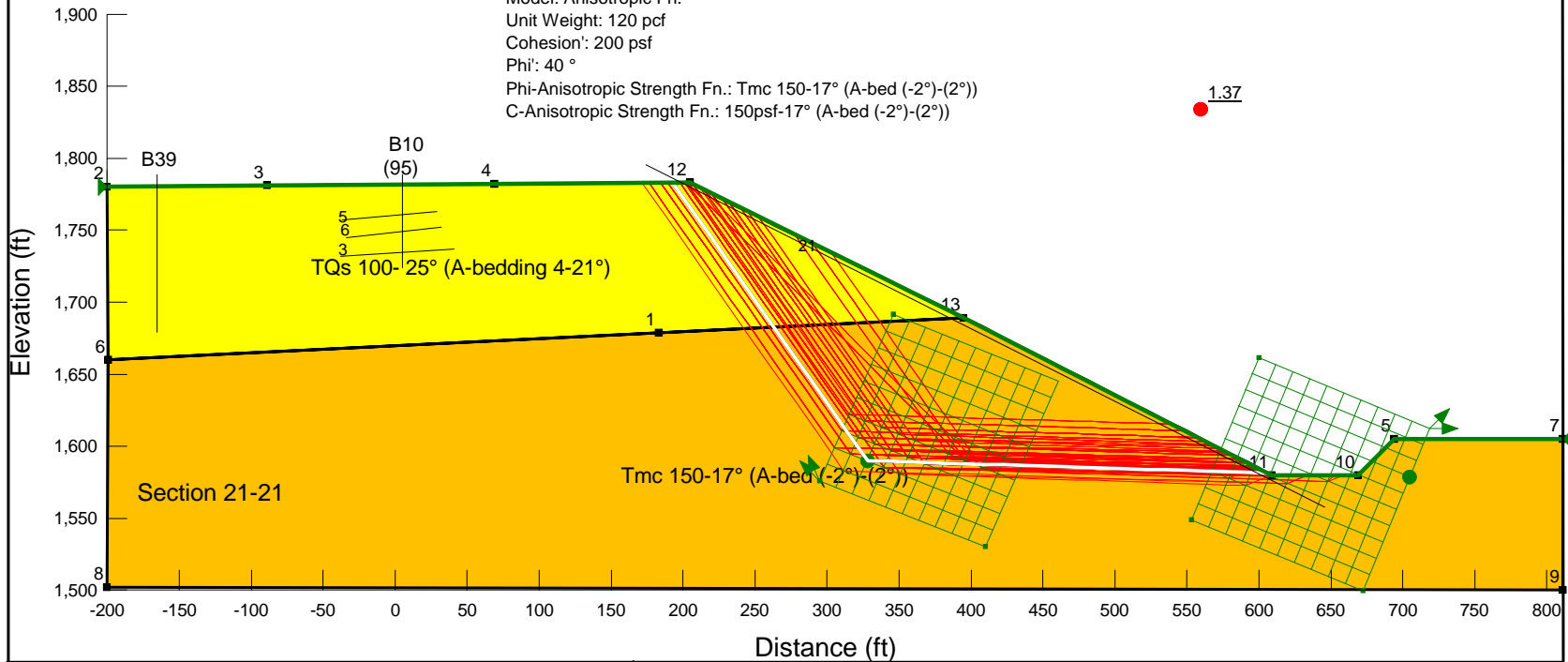

	<p>LGC Valley, Inc GEOTECHNICAL CONSULTING 28532 Constellation Road, Valencia, CA 91355 Phone 661-702-8474, Fax 661-702-8475</p>	<p>Skyline Ranch Development project, Tract 60922 Los Angeles CA</p>	<p>Project No: 153035-01 Engineer: BAS Date: March 2016</p>
---	---	---	--

2 - Translational

Report generated using GeoStudio 2012. Copyright © 1991-2015 GEO-SLOPE International Ltd.

File Information

File Version: 8.15
 Title: Static Slope Stability Analyses for Skyline Ranch Development project, Tract 60922, Los Angeles CA
 Comments: Run By: Dr. Alexander Bykovtsev, Ph.D., P.E.
 Last Edited By: Alexander Bykovtsev
 Revision Number: 142
 Date: 3/24/2016
 Time: 10:53:54 AM
 Tool Version: 8.15.1.11236
 File Name: Section 21-21 Static Temporary Final SSA without key for Skyline Ranch.gsz
 Directory: G:\SLOPE RESULTS\Section 21-21 results\
 Last Solved Date: 3/24/2016
 Last Solved Time: 10:54:07 AM

Project Settings

Length(L) Units: Feet
 Time(t) Units: Seconds
 Force(F) Units: Pounds
 Pressure(p) Units: psf
 Strength Units: psf
 Unit Weight of Water: 62.4 pcf
 View: 2D
 Element Thickness: 1

Analysis Settings

2 - Translational

Kind: [SLOPE/W](#)
 Method: [Janbu](#)
 Settings
 PWP Conditions Source: [\(none\)](#)
 Slip Surface
 Direction of movement: [Left to Right](#)
 Use Passive Mode: [No](#)
 Slip Surface Option: [Block](#)
 Critical slip surfaces saved: [10](#)
 Resisting Side Maximum Convex Angle: [1 °](#)
 Driving Side Maximum Convex Angle: [5 °](#)
 Restrict Block Crossing: [No](#)
 Optimize Critical Slip Surface Location: [No](#)
 Tension Crack

file:///G:/SLOPE%20RESULTS/Section%2021-21%20results/section%2021-21%20static... 3/24/2016

Tension Crack Option: [\(none\)](#)
 F of S Distribution
 F of S Calculation Option: [Constant](#)
 Advanced
 Number of Slices: [30](#)
 F of S Tolerance: [0.01](#)
 Minimum Slip Surface Depth: [0.1 ft](#)

Materials

TQs 100- 25° (A-bedding 4-21°)

Model: [Anisotropic Fn.](#)
 Unit Weight: [120 pcf](#)
 Cohesion': [225 psf](#)
 Phi': [40 °](#)
 Phi-Anisotropic Strength Fn.: [TQs 100- 25° \(A-bedding 4-21°\)](#)
 C-Anisotropic Strength Fn.: [100psf- 25° \(A-bedding 4-21°\)](#)
 Phi-B: [0 °](#)

Tmc 150-17° (A-bed (-2°)-(2°))

Model: [Anisotropic Fn.](#)
 Unit Weight: [120 pcf](#)
 Cohesion': [200 psf](#)
 Phi': [40 °](#)
 Phi-Anisotropic Strength Fn.: [Tmc 150-17° \(A-bed \(-2°\)-\(2°\)\)](#)
 C-Anisotropic Strength Fn.: [150psf-17° \(A-bed \(-2°\)-\(2°\)\)](#)
 Phi-B: [0 °](#)

Slip Surface Limits

Left Coordinate: [\(-200, 1,780\) ft](#)
 Right Coordinate: [\(811, 1,605\) ft](#)

Slip Surface Block

Left Grid
 Upper Left: [\(345.9397, 1,691.465\) ft](#)
 Lower Left: [\(295.0306, 1,576.1191\) ft](#)
 Lower Right: [\(409.9866, 1,529.9807\) ft](#)
 X Increments: [10](#)
 Y Increments: [10](#)
 Starting Angle: [115 °](#)
 Ending Angle: [135 °](#)
 Angle Increments: [2](#)
 Right Grid
 Upper Left: [\(599.9611, 1,661.7267\) ft](#)
 Lower Left: [\(553.3451, 1,548.8695\) ft](#)
 Lower Right: [\(672.2158, 1,499.4945\) ft](#)

file:///G:/SLOPE%20RESULTS/Section%2021-21%20results/section%2021-21%20static... 3/24/2016

X Increments: 10
 Y Increments: 10
 Starting Angle: 0 °
 Ending Angle: 45 °
 Angle Increments: 2

Seismic Coefficients

Horz Seismic Coef.: 0
 Vert Seismic Coef.: 0

Anisotropic Strength Functions

Tmc 150-17° (A-bed (-2°)-(2°))

Model: Spline Data Point Function
 Function: Modifier Factor vs. Inclination
 Curve Fit to Data: 100 %
 Segment Curvature: 0 %

Y-Intercept: 0.425
 Data Points: Inclination (°), Modifier Factor
 Data Point: (-90, 1)
 Data Point: (-2.1, 1)
 Data Point: (-2, 0.425)
 Data Point: (2, 0.425)
 Data Point: (2.1, 1)

TQs 100- 25° (A-bedding 4-21°)

Model: Spline Data Point Function
 Function: Modifier Factor vs. Inclination
 Curve Fit to Data: 100 %
 Segment Curvature: 0 %

Y-Intercept: 1
 Data Points: Inclination (°), Modifier Factor
 Data Point: (-90, 1)
 Data Point: (3.9, 1)
 Data Point: (4, 0.625)
 Data Point: (21, 0.625)
 Data Point: (21.1, 1)

150psf-17° (A-bed (-2°)-(2°))

Model: Spline Data Point Function
 Function: Modifier Factor vs. Inclination
 Curve Fit to Data: 100 %
 Segment Curvature: 0 %

Y-Intercept: 0.75
 Data Points: Inclination (°), Modifier Factor
 Data Point: (-90, 1)
 Data Point: (-2.1, 1)
 Data Point: (-2, 0.75)

Data Point: (2, 0.75)
 Data Point: (2.1, 1)

100psf- 25° (A-bedding 4-21°)

Model: Spline Data Point Function
 Function: Modifier Factor vs. Inclination
 Curve Fit to Data: 100 %
 Segment Curvature: 0 %

Y-Intercept: 1
 Data Points: Inclination (°), Modifier Factor
 Data Point: (-90, 1)
 Data Point: (3.9, 1)
 Data Point: (4, 0.444)
 Data Point: (21, 0.444)
 Data Point: (21.1, 1)

Points

	X (ft)	Y (ft)
Point 1	183	1,679
Point 2	-200	1,780
Point 3	-89	1,781
Point 4	69	1,782
Point 5	694	1,605
Point 6	-199	1,660
Point 7	811	1,605
Point 8	-200	1,502
Point 9	811	1,500
Point 10	669	1,580
Point 11	609	1,580
Point 12	205	1,783
Point 13	394.7786	1,689.3389

Regions

	Material	Points	Area (ft²)
Region 1	Tmc 150-17° (A-bed (-2°)-(2°))	6,8,9,7,5,10,11,13,1	1.5107e+005
Region 2	TQs 100- 25° (A-bedding 4-21°)	6,1,13,12,4,3,2	54,880

Current Slip Surface

Slip Surface: 26,763
 F of S: 1.37
 Volume: 27,789.799 ft³
 Weight: 3,334,775.9 lbs
 Resisting Force: 1,232,169.4 lbs

Activating Force: 897,971.46 lbs
 F of S Rank (Analysis): 1 of 131,769 slip surfaces
 F of S Rank (Query): 1 of 150 slip surfaces
 Exit: (606.05728, 1,581.502) ft
 Entry: (193.09726, 1,782.9125) ft
 Radius: 275.194 ft
 Center: (473.25182, 1,833.2651) ft

Slip Slices

	X (ft)	Y (ft)	PWP (psf)	Base Normal Stress (psf)	Frictional Strength (psf)	Cohesive Strength (psf)
Slice 1	199.04863	1,774.413	0	424.55202	356.24144	225
Slice 2	212.26485	1,755.5383	0	1,410.0248	1,183.1513	225
Slice 3	226.79455	1,734.7878	0	2,282.8096	1,915.5047	225
Slice 4	241.32425	1,714.0372	0	3,155.5943	2,647.858	225
Slice 5	255.85395	1,693.2866	0	4,028.379	3,380.2114	225
Slice 6	269.62729	1,673.6163	0	4,869.5659	4,086.051	200
Slice 7	282.64425	1,655.0261	0	5,651.482	4,742.1565	200
Slice 8	295.66121	1,636.436	0	6,433.3981	5,398.262	200
Slice 9	308.67818	1,617.8458	0	7,215.3142	6,054.3674	200
Slice 10	321.69514	1,599.2557	0	7,997.2302	6,710.4729	200
Slice 11	334.86112	1,589.7579	0	15,391.277	4,705.5857	150
Slice 12	348.17611	1,589.3526	0	14,656.309	4,480.8834	150
Slice 13	361.49111	1,588.9472	0	13,921.341	4,256.1811	150
Slice 14	374.80611	1,588.5419	0	13,186.373	4,031.4787	150
Slice 15	388.1211	1,588.1365	0	12,451.405	3,806.7764	150
Slice 16	401.82122	1,587.7195	0	11,681.014	3,571.2443	150
Slice 17	415.90647	1,587.2907	0	10,875.2	3,324.8824	150
Slice 18	429.99171	1,586.8619	0	10,069.387	3,078.5205	150
	444.07696	1,586.4331	0	9,263.5733	2,832.1586	150

Slice 19						
Slice 20	458.1622	1,586.0043	0	8,457.7598	2,585.7967	150
Slice 21	472.24745	1,585.5755	0	7,651.9463	2,339.4347	150
Slice 22	486.33269	1,585.1467	0	6,846.1328	2,093.0728	150
Slice 23	500.41794	1,584.7179	0	6,040.3193	1,846.7109	150
Slice 24	514.50318	1,584.2891	0	5,234.5058	1,600.349	150
Slice 25	528.58843	1,583.8603	0	4,428.6923	1,353.9871	150
Slice 26	542.67367	1,583.4315	0	3,622.8788	1,107.6252	150
Slice 27	556.75892	1,583.0027	0	2,817.0653	861.26328	150
Slice 28	570.84416	1,582.574	0	2,011.2518	614.90137	150
Slice 29	584.92941	1,582.1452	0	1,205.4383	368.53946	150
Slice 30	599.01465	1,581.7164	0	399.62475	122.17755	150

Section 22-22 Static Left SSA for Skyline Ranch.gsz

Section 22-22 Static Left SSA for Skyline Ranch.gsz Run By: Dr. Alexander Bykovtsev, Ph.D., P.E. 3/25/2016 3:25:12 PM

- Materials**
- TQs 100-25° (A-bed 10°-18°)
 - TQs 100-25° (A-bed 2°-10°)
 - Tmc150-17° (A-bed -1°-(-5°))
 - Tmc100-25° (A-bed -1°-(-5°))

Name: TQs 100-25° (A-bed 10°-18°)
 Model: Anisotropic Fn.
 Unit Weight: 120 pcf
 Cohesion: 225 psf
 Phi: 40°
 Phi-Anisotropic Strength Fn.: TQs 100-25° (A-bed 10°-18°)
 C-Anisotropic Strength Fn.: 100psf-25° (A-bed 10°-18°)

Name: TQs 100-25° (A-bed 2°-10°)
 Model: Anisotropic Fn.
 Unit Weight: 120 pcf
 Cohesion: 225 psf
 Phi: 40°
 Phi-Anisotropic Strength Fn.: TQs 100-25° (A-bed 2°-10°)
 C-Anisotropic Strength Fn.: 150pcf (Along Bedding 8°-20°)

Name: Tmc150-17° (A-bed -1°-(-5°))
 Model: Anisotropic Fn.
 Unit Weight: 120 pcf
 Cohesion: 200 psf
 Phi: 40°
 Phi-Anisotropic Strength Fn.: Tmc100-25° (A-bed -1°-(-5°))
 C-Anisotropic Strength Fn.: 150psf-17° (A-bed -1°-(-5°))

Name: Tmc100-25° (A-bed -1°-(-5°))
 Model: Anisotropic Fn.
 Unit Weight: 120 pcf
 Cohesion: 200 psf
 Phi: 40°
 Phi-Anisotropic Strength Fn.: Tmc100-25° (A-bed -1°-(-5°))
 C-Anisotropic Strength Fn.: 100psf-25° (A-bed -1°-(-5°))

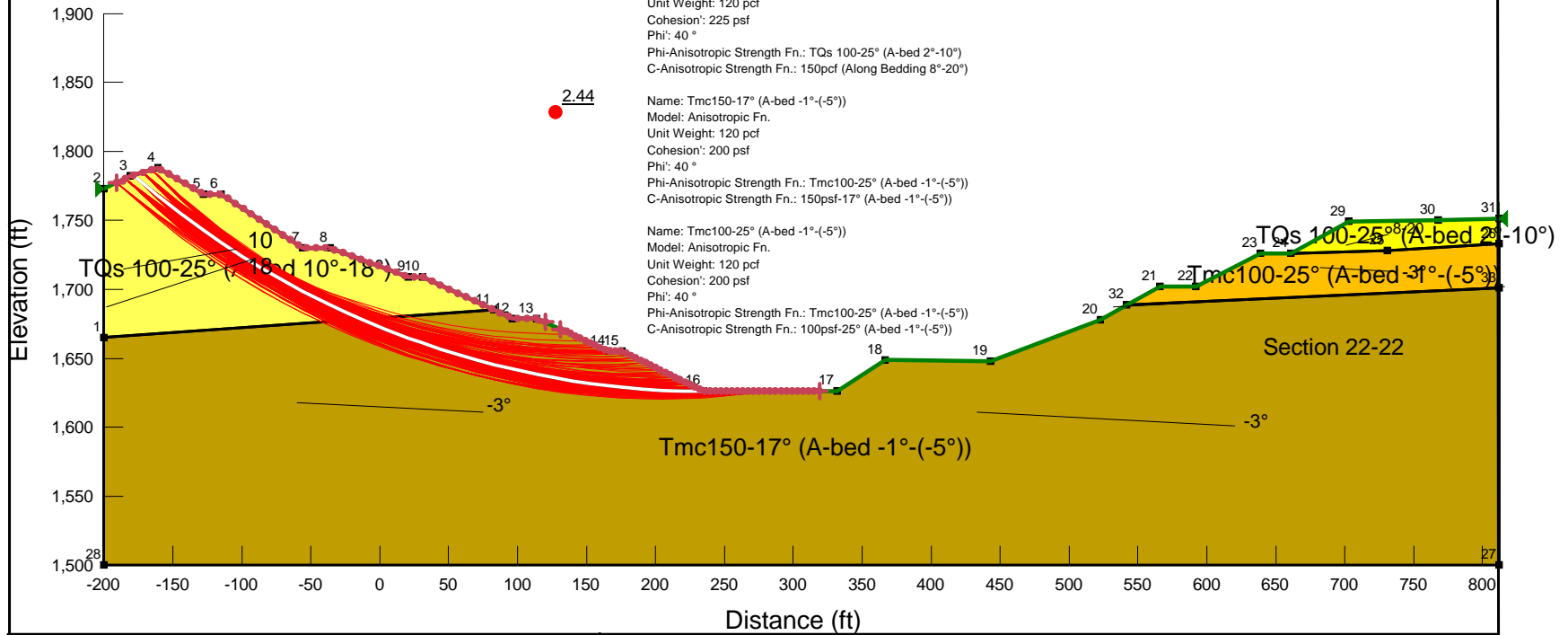

LGC **LGC Valley, Inc**
 GEOTECHNICAL CONSULTING
 28532 Constellation Road, Valencia, CA 91355
 Phone 661-702-8474, Fax 661-702-8475

Skyline Ranch
 Development project, Tract 60922
 Los Angeles CA

Project No: **153035-01**
 Engineer: **BAS**
 Date: **March 2016**

1 - Circular Mode of Failure

Report generated using GeoStudio 2012. Copyright © 1991-2015 GEO-SLOPE International Ltd.

File Information

File Version: 8.15
 Title: Static Slope Stability Analyses for Skyline Ranch Development project, Tract 60922, Los Angeles CA
 Comments: Run By: Dr. Alexander Bykovtsev, Ph.D., P.E.
 Last Edited By: Alexander Bykovtsev
 Revision Number: 163
 Date: 3/25/2016
 Time: 3:25:12 PM
 Tool Version: 8.15.1.11236
 File Name: Section 22-22 Static Left SSA for Skyline Ranch.gsz
 Directory: G:\SLOPE RESULTS\Section 22-22 results\Latest update 3-25-2016\Latest Results 3-25-2016\
 Last Solved Date: 3/25/2016
 Last Solved Time: 3:28:51 PM

Project Settings

Length(L) Units: Feet
 Time(t) Units: Seconds
 Force(F) Units: Pounds
 Pressure(p) Units: psf
 Strength Units: psf
 Unit Weight of Water: 62.4 pcf
 View: 2D
 Element Thickness: 1

Analysis Settings

1 - Circular Mode of Failure

Kind: SLOPE/W
 Method: Bishop
 Settings
 PWP Conditions Source: (none)
 Slip Surface
 Direction of movement: Left to Right
 Use Passive Mode: No
 Slip Surface Option: Entry and Exit
 Critical slip surfaces saved: 10
 Resisting Side Maximum Convex Angle: 1 °
 Driving Side Maximum Convex Angle: 5 °
 Optimize Critical Slip Surface Location: No
 Tension Crack
 Tension Crack Option: (none)

file:///G:/SLOPE%20RESULTS/Section%2022-22%20results/Latest%20update%203-25-2... 3/25/2016

F of S Distribution
 F of S Calculation Option: Constant
 Advanced
 Number of Slices: 30
 F of S Tolerance: 0.01
 Minimum Slip Surface Depth: 0.1 ft

Materials

TQs 100-25° (A-bed 10°-18°)

Model: Anisotropic Fn.
 Unit Weight: 120 pcf
 Cohesion': 225 psf
 Phi': 40 °
 Phi-Anisotropic Strength Fn.: TQs 100-25° (A-bed 10°-18°)
 C-Anisotropic Strength Fn.: 100psf-25° (A-bed 10°-18°)
 Phi-B: 0 °

TQs 100-25° (A-bed 2°-10°)

Model: Anisotropic Fn.
 Unit Weight: 120 pcf
 Cohesion': 225 psf
 Phi': 40 °
 Phi-Anisotropic Strength Fn.: TQs 100-25° (A-bed 2°-10°)
 C-Anisotropic Strength Fn.: 150pcf (Along Bedding 8°-20°)
 Phi-B: 0 °

Tmc150-17° (A-bed -1°-(-5°))

Model: Anisotropic Fn.
 Unit Weight: 120 pcf
 Cohesion': 200 psf
 Phi': 40 °
 Phi-Anisotropic Strength Fn.: Tmc100-25° (A-bed -1°-(-5°))
 C-Anisotropic Strength Fn.: 150psf-17° (A-bed -1°-(-5°))
 Phi-B: 0 °

Tmc100-25° (A-bed -1°-(-5°))

Model: Anisotropic Fn.
 Unit Weight: 120 pcf
 Cohesion': 200 psf
 Phi': 40 °
 Phi-Anisotropic Strength Fn.: Tmc100-25° (A-bed -1°-(-5°))
 C-Anisotropic Strength Fn.: 100psf-25° (A-bed -1°-(-5°))
 Phi-B: 0 °

Slip Surface Entry and Exit

Left Projection: Range
 Left-Zone Left Coordinate: (-190.7941, 1,777.3607) ft

file:///G:/SLOPE%20RESULTS/Section%2022-22%20results/Latest%20update%203-25-2... 3/25/2016

Left-Zone Right Coordinate: (120, 1,676.2308) ft
 Left-Zone Increment: 50
 Right Projection: Range
 Right-Zone Left Coordinate: (131, 1,671.1538) ft
 Right-Zone Right Coordinate: (319, 1,626) ft
 Right-Zone Increment: 50
 Radius Increments: 50

Slip Surface Limits

Left Coordinate: (-200, 1,773) ft
 Right Coordinate: (812, 1,751) ft

Seismic Coefficients

Horz Seismic Coef.: 0
 Vert Seismic Coef.: 0

Anisotropic Strength Functions

TQs 100-25° (A-bed 10°-18°)

Model: Spline Data Point Function
 Function: Modifier Factor vs. Inclination
 Curve Fit to Data: 100 %
 Segment Curvature: 0 %

Y-Intercept: 1

Data Points: Inclination (°), Modifier Factor

Data Point: (-90, 1)
 Data Point: (9.9, 1)
 Data Point: (10, 0.625)
 Data Point: (18, 0.625)
 Data Point: (18.1, 1)

Tmc100-25° (A-bed -1°-(-5°))

Model: Spline Data Point Function
 Function: Modifier Factor vs. Inclination
 Curve Fit to Data: 100 %
 Segment Curvature: 0 %

Y-Intercept: 1

Data Points: Inclination (°), Modifier Factor

Data Point: (-90, 1)
 Data Point: (-5.1, 1)
 Data Point: (-5, 0.625)
 Data Point: (-1, 0.625)
 Data Point: (-0.9, 1)

TQs 100-25° (A-bed 2°-10°)

Model: Spline Data Point Function

Function: Modifier Factor vs. Inclination
 Curve Fit to Data: 100 %
 Segment Curvature: 0 %

Y-Intercept: 1

Data Points: Inclination (°), Modifier Factor

Data Point: (-90, 1)
 Data Point: (1.9, 1)
 Data Point: (2, 0.625)
 Data Point: (10, 0.625)
 Data Point: (10.1, 1)

150pcf (Along Bedding 8°-20°)

Model: Spline Data Point Function
 Function: Modifier Factor vs. Inclination
 Curve Fit to Data: 100 %
 Segment Curvature: 0 %

Y-Intercept: 1

Data Points: Inclination (°), Modifier Factor

Data Point: (-90, 1)
 Data Point: (7.9, 1)
 Data Point: (8, 0.667)
 Data Point: (20, 0.667)
 Data Point: (20.1, 1)

150psf-17° (A-bed -1°-(-5°))

Model: Spline Data Point Function
 Function: Modifier Factor vs. Inclination
 Curve Fit to Data: 100 %
 Segment Curvature: 0 %

Y-Intercept: 1

Data Points: Inclination (°), Modifier Factor

Data Point: (-90, 1)
 Data Point: (-5.1, 1)
 Data Point: (-5, 0.75)
 Data Point: (-1, 0.75)
 Data Point: (-0.9, 1)

100psf-25° (A-bed 10°-18°)

Model: Spline Data Point Function
 Function: Modifier Factor vs. Inclination
 Curve Fit to Data: 100 %
 Segment Curvature: 0 %

Y-Intercept: 1

Data Points: Inclination (°), Modifier Factor

Data Point: (-90, 1)
 Data Point: (9.9, 1)
 Data Point: (10, 0.444)
 Data Point: (18, 0.444)
 Data Point: (18.1, 1)

100psf-25° (A-bed -1°(-5°))

Model: Spline Data Point Function
 Function: Modifier Factor vs. Inclination
 Curve Fit to Data: 100 %
 Segment Curvature: 0 %
 Y-Intercept: 1
 Data Points: Inclination (°), Modifier Factor
 Data Point: (-90, 1)
 Data Point: (-5.1, 1)
 Data Point: (-5, 0.5)
 Data Point: (-1, 0.5)
 Data Point: (-0.9, 1)

Points

	X (ft)	Y (ft)
Point 1	-200	1,665.0405
Point 2	-200	1,773
Point 3	-181	1,782
Point 4	-161	1,788
Point 5	-128	1,769
Point 6	-115	1,769
Point 7	-56	1,730
Point 8	-36	1,730
Point 9	21	1,709
Point 10	31	1,709
Point 11	83	1,685
Point 12	96	1,679
Point 13	114	1,679
Point 14	166	1,655
Point 15	176	1,655
Point 16	235	1,626
Point 17	332	1,626
Point 18	367	1,649
Point 19	443	1,648
Point 20	523	1,678
Point 21	566	1,702
Point 22	592	1,702
Point 23	639	1,726
Point 24	661	1,726
Point 25	731	1,728
Point 26	812	1,733
Point 27	812	1,500
Point 28	-200	1,500
Point 29	703	1,749

Point 30	768	1,750
Point 31	812	1,751
Point 32	542	1,688.6047
Point 33	812	1,701

Regions

	Material	Points	Area (ft²)
Region 1	TQs 100-25° (A-bed 10° -18°)	1,2,3,4,5,6,7,8,9,10,11	18,295
Region 2	TQs 100-25° (A-bed 2° -10°)	24,29,30,31,26,25	2,654
Region 3	Tmc100-25° (A-bed -1° (-5°))	32,33,26,25,24,23,22,21	6,933.1
Region 4	Tmc150-17° (A-bed -1° (-5°))	1,28,27,33,32,20,19,18,17,16,15,14,13,12,11	1.7108e+005

Current Slip Surface

Slip Surface: 6,847
 F of S: 2.44
 Volume: 13,249.685 ft³
 Weight: 1,589,962.2 lbs
 Resisting Moment: 8.4245847e+008 lbs-ft
 Activating Moment: 3.4512137e+008 lbs-ft
 F of S Rank (Analysis): 1 of 132,651 slip surfaces
 F of S Rank (Query): 1 of 300 slip surfaces
 Exit: (247.61564, 1,626) ft
 Entry: (-178.33604, 1,782.7992) ft
 Radius: 632.66709 ft
 Center: (238.65057, 2,258.6036) ft

Slip Slices

	X (ft)	Y (ft)	PWP (psf)	Base Normal Stress (psf)	Frictional Strength (psf)	Cohesive Strength (psf)
Slice 1	-169.66802	1,775.4734	0	862.95277	724.10335	225
Slice 2	-152.75	1,761.6499	0	1,983.248	1,664.1427	225
Slice 3	-136.25	1,749.0819	0	2,309.1293	1,937.5895	225
Slice 4	-121.5	1,738.5106	0	2,904.48	2,437.1481	225
	-107.625	1,729.1858	0	3,374.7018	2,831.7111	225

Slice 5						
Slice 6	-92.875	1,719.824	0	3,376.2433	2,833.0045	225
Slice 7	-78.125	1,711.0195	0	3,320.0237	2,785.8307	225
Slice 8	-63.375	1,702.7459	0	3,207.2002	2,691.1605	225
Slice 9	-46	1,693.6998	0	3,674.0528	3,082.8964	225
Slice 10	-30.294986	1,685.9813	0	4,294.3348	3,603.3748	225
Slice 11	-18.884957	1,680.7592	0	4,432.9194	3,719.661	225
Slice 12	-4.6349568	1,674.6566	0	4,567.1967	3,832.333	200
Slice 13	12.455014	1,667.8248	0	4,673.1875	3,921.2699	200
Slice 14	26	1,662.7687	0	4,916.1845	4,125.1686	200
Slice 15	37.5	1,658.8044	0	5,054.1264	4,240.9156	200
Slice 16	50.5	1,654.5997	0	4,898.6594	4,110.4633	200
Slice 17	63.5	1,650.7021	0	4,706.6047	3,949.3103	200
Slice 18	76.5	1,647.1057	0	4,477.9566	3,757.4517	200
Slice 19	89.5	1,643.8052	0	4,212.6566	3,534.8386	200
Slice 20	105	1,640.283	0	4,308.6247	3,615.3654	200
Slice 21	120.5	1,637.1019	0	4,367.1863	3,664.5044	200
Slice 22	133.5	1,634.7706	0	3,983.2329	3,342.3293	200
Slice 23	146.5	1,632.718	0	3,561.7565	2,988.6686	200
Slice 24	159.5	1,630.9413	0	3,102.4103	2,603.2313	200
Slice 25	171	1,629.5839	0	2,932.8426	2,460.9471	200
Slice 26	183.375	1,628.3993	0	2,702.2945	1,370.5115	156.30856
Slice 27	198.125	1,627.279	0	1,993.1701	929.4305	150
Slice 28	212.875	1,626.5049	0	1,232.3276	574.6438	150

Slice 29	227.625	1,626.0756	0	423.43617	199.31765	150.69019
Slice 30	241.30782	1,625.9735	0	3.5281804	2.9604949	200

Section 22-22 pseudostatic Left SSA for Skyline Ranch.gsz

Section 22-22 pseudostatic Left SSA for Skyline Ranch.gsz Run By: Dr. Alexander Bykovtsev, Ph.D., P.E. 3/25/2016 3:20:06 PM

- Materials**
- TQs 100-25° (A-bed 10°-18°)
 - TQs 100-25° (A-bed 2°-10°)
 - Tmc150-17° (A-bed -1°-(-5°))
 - Tmc100-25° (A-bed -1°-(-5°))

Name: TQs 100-25° (A-bed 10°-18°)
 Model: Anisotropic Fn.
 Unit Weight: 120 pcf
 Cohesion: 225 psf
 Phi: 40 °
 Phi-Anisotropic Strength Fn.: TQs 100-25° (A-bed 10°-18°)
 C-Anisotropic Strength Fn.: 100psf-25° (A-bed 10°-18°)

Name: TQs 100-25° (A-bed 2°-10°)
 Model: Anisotropic Fn.
 Unit Weight: 120 pcf
 Cohesion: 225 psf
 Phi: 40 °
 Phi-Anisotropic Strength Fn.: TQs 100-25° (A-bed 2°-10°)
 C-Anisotropic Strength Fn.: 150pcf (Along Bedding 8°-20°)

Name: Tmc150-17° (A-bed -1°-(-5°))
 Model: Anisotropic Fn.
 Unit Weight: 120 pcf
 Cohesion: 200 psf
 Phi: 40 °
 Phi-Anisotropic Strength Fn.: Tmc100-25° (A-bed -1°-(-5°))
 C-Anisotropic Strength Fn.: 150psf-17° (A-bed -1°-(-5°))

Name: Tmc100-25° (A-bed -1°-(-5°))
 Model: Anisotropic Fn.
 Unit Weight: 120 pcf
 Cohesion: 200 psf
 Phi: 40 °
 Phi-Anisotropic Strength Fn.: Tmc100-25° (A-bed -1°-(-5°))
 C-Anisotropic Strength Fn.: 100psf-25° (A-bed -1°-(-5°))

Seismic Load
 Horizontal: 0.15
 Vertical: 0.0

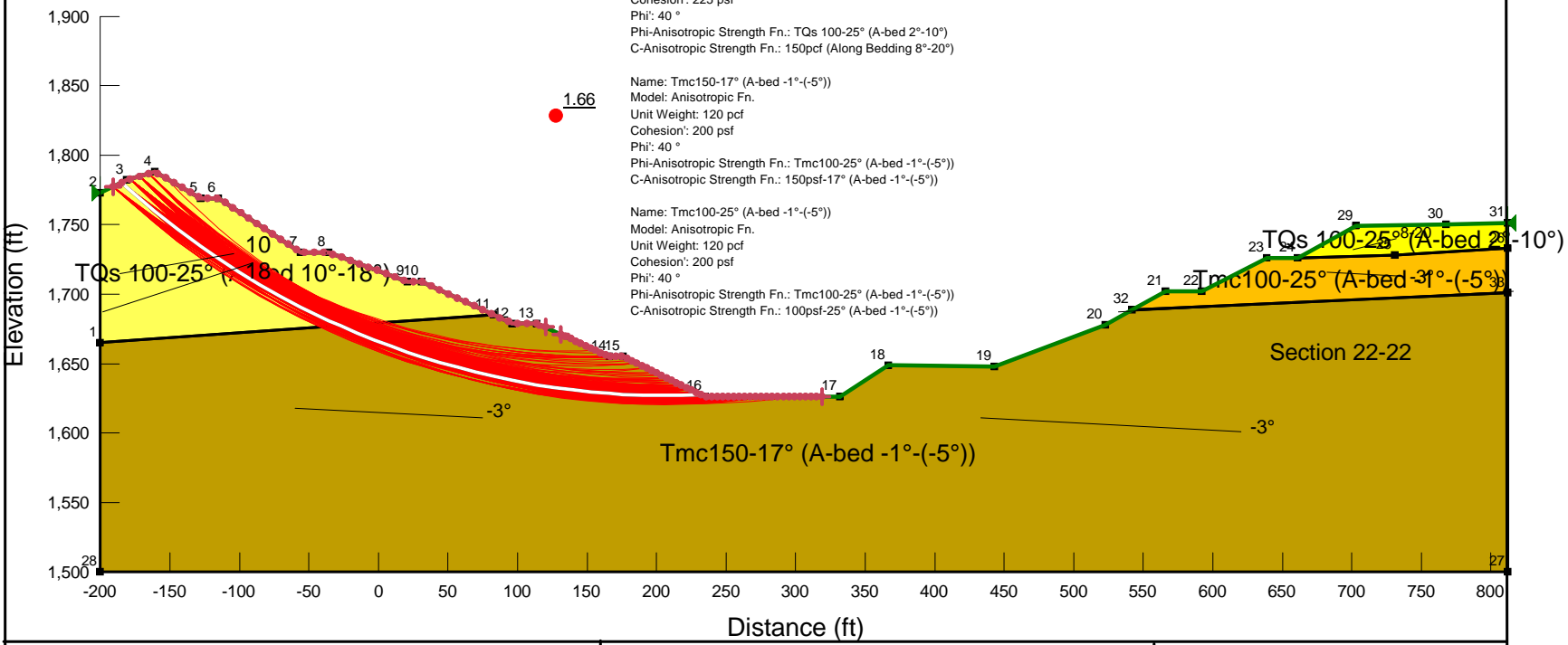

LGC **LGC Valley, Inc**
 GEOTECHNICAL CONSULTING
 28532 Constellation Road, Valencia, CA 91355
 Phone 661-702-8474, Fax 661-702-8475

Skyline Ranch
 Development project, Tract 60922
 Los Angeles CA

Project No: **153035-01**
 Engineer: **BAS**
 Date: **March 2016**

1 - Circular Mode of Failure

Report generated using GeoStudio 2012. Copyright © 1991-2015 GEO-SLOPE International Ltd.

File Information

File Version: 8.15
 Title: Static Slope Stability Analyses for Skyline Ranch Development project, Tract 60922, Los Angeles CA
 Comments: Run By: Dr. Alexander Bykovtsev, Ph.D., P.E.
 Last Edited By: Alexander Bykovtsev
 Revision Number: 161
 Date: 3/25/2016
 Time: 3:20:06 PM
 Tool Version: 8.15.1.11236
 File Name: Section 22-22 pseudostatic Left SSA for Skyline Ranch.gsz
 Directory: G:\SLOPE RESULTS\Section 22-22 results\Latest update 3-15-2016\Latest Results 3-25-2016\
 Last Solved Date: 3/25/2016
 Last Solved Time: 3:20:38 PM

Project Settings

Length(L) Units: Feet
 Time(t) Units: Seconds
 Force(F) Units: Pounds
 Pressure(p) Units: psf
 Strength Units: psf
 Unit Weight of Water: 62.4 pcf
 View: 2D
 Element Thickness: 1

Analysis Settings

1 - Circular Mode of Failure

Kind: SLOPE/W
 Method: Bishop
 Settings
 PWP Conditions Source: (none)
 Slip Surface
 Direction of movement: Left to Right
 Use Passive Mode: No
 Slip Surface Option: Entry and Exit
 Critical slip surfaces saved: 10
 Resisting Side Maximum Convex Angle: 1 °
 Driving Side Maximum Convex Angle: 5 °
 Optimize Critical Slip Surface Location: No
 Tension Crack
 Tension Crack Option: (none)

file:///G:/SLOPE%20RESULTS/Section%2022-22%20results/Latest%20update%203-15-2... 3/25/2016

F of S Distribution
 F of S Calculation Option: Constant
 Advanced
 Number of Slices: 30
 F of S Tolerance: 0.01
 Minimum Slip Surface Depth: 0.1 ft

Materials

TQs 100-25° (A-bed 10°-18°)

Model: Anisotropic Fn.
 Unit Weight: 120 pcf
 Cohesion': 225 psf
 Phi': 40 °
 Phi-Anisotropic Strength Fn.: TQs 100-25° (A-bed 10°-18°)
 C-Anisotropic Strength Fn.: 100psf-25° (A-bed 10°-18°)
 Phi-B: 0 °

TQs 100-25° (A-bed 2°-10°)

Model: Anisotropic Fn.
 Unit Weight: 120 pcf
 Cohesion': 225 psf
 Phi': 40 °
 Phi-Anisotropic Strength Fn.: TQs 100-25° (A-bed 2°-10°)
 C-Anisotropic Strength Fn.: 150pcf (Along Bedding 8°-20°)
 Phi-B: 0 °

Tmc150-17° (A-bed -1°-(-5°))

Model: Anisotropic Fn.
 Unit Weight: 120 pcf
 Cohesion': 200 psf
 Phi': 40 °
 Phi-Anisotropic Strength Fn.: Tmc100-25° (A-bed -1°-(-5°))
 C-Anisotropic Strength Fn.: 150psf-17° (A-bed -1°-(-5°))
 Phi-B: 0 °

Tmc100-25° (A-bed -1°-(-5°))

Model: Anisotropic Fn.
 Unit Weight: 120 pcf
 Cohesion': 200 psf
 Phi': 40 °
 Phi-Anisotropic Strength Fn.: Tmc100-25° (A-bed -1°-(-5°))
 C-Anisotropic Strength Fn.: 100psf-25° (A-bed -1°-(-5°))
 Phi-B: 0 °

Slip Surface Entry and Exit

Left Projection: Range
 Left-Zone Left Coordinate: (-190.7941, 1,777.3607) ft

file:///G:/SLOPE%20RESULTS/Section%2022-22%20results/Latest%20update%203-15-2... 3/25/2016

Left-Zone Right Coordinate: (120, 1,676.2308) ft
 Left-Zone Increment: 50
 Right Projection: Range
 Right-Zone Left Coordinate: (131, 1,671.1538) ft
 Right-Zone Right Coordinate: (319, 1,626) ft
 Right-Zone Increment: 50
 Radius Increments: 50

Slip Surface Limits

Left Coordinate: (-200, 1,773) ft
 Right Coordinate: (812, 1,751) ft

Seismic Coefficients

Horz Seismic Coef.: 0.15
 Vert Seismic Coef.: 0

Anisotropic Strength Functions

TQs 100-25° (A-bed 10°-18°)

Model: Spline Data Point Function
 Function: Modifier Factor vs. Inclination
 Curve Fit to Data: 100 %
 Segment Curvature: 0 %

Y-Intercept: 1

Data Points: Inclination (°), Modifier Factor

Data Point: (-90, 1)
 Data Point: (9.9, 1)
 Data Point: (10, 0.625)
 Data Point: (18, 0.625)
 Data Point: (18.1, 1)

Tmc100-25° (A-bed -1°-(-5°))

Model: Spline Data Point Function
 Function: Modifier Factor vs. Inclination
 Curve Fit to Data: 100 %
 Segment Curvature: 0 %

Y-Intercept: 1

Data Points: Inclination (°), Modifier Factor

Data Point: (-90, 1)
 Data Point: (-5.1, 1)
 Data Point: (-5, 0.625)
 Data Point: (-1, 0.625)
 Data Point: (-0.9, 1)

TQs 100-25° (A-bed 2°-10°)

Model: Spline Data Point Function

Function: Modifier Factor vs. Inclination
 Curve Fit to Data: 100 %
 Segment Curvature: 0 %

Y-Intercept: 1

Data Points: Inclination (°), Modifier Factor

Data Point: (-90, 1)
 Data Point: (1.9, 1)
 Data Point: (2, 0.625)
 Data Point: (10, 0.625)
 Data Point: (10.1, 1)

150pcf (Along Bedding 8°-20°)

Model: Spline Data Point Function
 Function: Modifier Factor vs. Inclination
 Curve Fit to Data: 100 %
 Segment Curvature: 0 %

Y-Intercept: 1

Data Points: Inclination (°), Modifier Factor

Data Point: (-90, 1)
 Data Point: (7.9, 1)
 Data Point: (8, 0.667)
 Data Point: (20, 0.667)
 Data Point: (20.1, 1)

150psf-17° (A-bed -1°-(-5°))

Model: Spline Data Point Function
 Function: Modifier Factor vs. Inclination
 Curve Fit to Data: 100 %
 Segment Curvature: 0 %

Y-Intercept: 1

Data Points: Inclination (°), Modifier Factor

Data Point: (-90, 1)
 Data Point: (-5.1, 1)
 Data Point: (-5, 0.75)
 Data Point: (-1, 0.75)
 Data Point: (-0.9, 1)

100psf-25° (A-bed 10°-18°)

Model: Spline Data Point Function
 Function: Modifier Factor vs. Inclination
 Curve Fit to Data: 100 %
 Segment Curvature: 0 %

Y-Intercept: 1

Data Points: Inclination (°), Modifier Factor

Data Point: (-90, 1)
 Data Point: (9.9, 1)
 Data Point: (10, 0.444)
 Data Point: (18, 0.444)
 Data Point: (18.1, 1)

100psf-25° (A-bed -1°(-5°))

Model: Spline Data Point Function
 Function: Modifier Factor vs. Inclination
 Curve Fit to Data: 100 %
 Segment Curvature: 0 %
 Y-Intercept: 1
 Data Points: Inclination (°), Modifier Factor
 Data Point: (-90, 1)
 Data Point: (-5.1, 1)
 Data Point: (-5, 0.5)
 Data Point: (-1, 0.5)
 Data Point: (-0.9, 1)

Points

	X (ft)	Y (ft)
Point 1	-200	1,665.0405
Point 2	-200	1,773
Point 3	-181	1,782
Point 4	-161	1,788
Point 5	-128	1,769
Point 6	-115	1,769
Point 7	-56	1,730
Point 8	-36	1,730
Point 9	21	1,709
Point 10	31	1,709
Point 11	83	1,685
Point 12	96	1,679
Point 13	114	1,679
Point 14	166	1,655
Point 15	176	1,655
Point 16	235	1,626
Point 17	332	1,626
Point 18	367	1,649
Point 19	443	1,648
Point 20	523	1,678
Point 21	566	1,702
Point 22	592	1,702
Point 23	639	1,726
Point 24	661	1,726
Point 25	731	1,728
Point 26	812	1,733
Point 27	812	1,500
Point 28	-200	1,500
Point 29	703	1,749

Point 30	768	1,750
Point 31	812	1,751
Point 32	542	1,688.6047
Point 33	812	1,701

Regions

	Material	Points	Area (ft²)
Region 1	TQs 100-25° (A-bed 10° -18°)	1,2,3,4,5,6,7,8,9,10,11	18,295
Region 2	TQs 100-25° (A-bed 2° -10°)	24,29,30,31,26,25	2,654
Region 3	Tmc100-25° (A-bed -1° (-5°))	32,33,26,25,24,23,22,21	6,933.1
Region 4	Tmc150-17° (A-bed -1° (-5°))	1,28,27,33,32,20,19,18,17,16,15,14,13,12,11	1.7108e+005

Current Slip Surface

Slip Surface: 4,043
 F of S: 1.66
 Volume: 15,477.816 ft³
 Weight: 1,857,337.9 lbs
 Resisting Moment: 8.4460924e+008 lbs-ft
 Activating Moment: 5.0779195e+008 lbs-ft
 F of S Rank (Analysis): 1 of 132,651 slip surfaces
 F of S Rank (Query): 1 of 300 slip surfaces
 Exit: (232.08549, 1,627.4326) ft
 Entry: (-184.64029, 1,780.2757) ft
 Radius: 581.50139 ft
 Center: (208.80039, 2,208.4675) ft

Slip Slices

	X (ft)	Y (ft)	PWP (psf)	Base Normal Stress (psf)	Frictional Strength (psf)	Cohesive Strength (psf)
Slice 1	-182.82014	1,778.6174	0	123.02745	103.23229	225
Slice 2	-171	1,768.33	0	1,313.3356	1,102.0194	225
Slice 3	-152.75	1,753.1499	0	2,503.8346	2,100.9667	225
Slice 4	-136.25	1,740.5156	0	2,835.8265	2,379.541	225
	-121.5	1,729.9457	0	3,408.7385	2,860.2712	225

Slice 5						
Slice 6	-107.625	1,720.675	0	3,864.362	3,242.5847	225
Slice 7	-92.875	1,711.4148	0	3,885.8893	3,260.6483	225
Slice 8	-78.125	1,702.7544	0	3,848.5455	3,229.3131	225
Slice 9	-63.375	1,694.6633	0	3,752.9778	3,149.1223	225
Slice 10	-46	1,685.8809	0	4,197.9731	3,522.5177	225
Slice 11	-31.811919	1,679.1015	0	4,769.7903	4,002.3293	225
Slice 12	-21.545858	1,674.5756	0	4,896.5226	4,108.6703	200
Slice 13	-9.3898984	1,669.4927	0	5,013.9371	4,207.1928	200
Slice 14	2.766061	1,664.7291	0	5,100.1884	4,279.5662	200
Slice 15	14.92202	1,660.2765	0	5,155.1702	4,325.7014	200
Slice 16	26	1,656.471	0	5,368.6344	4,504.8192	200
Slice 17	37.5	1,652.8114	0	5,493.0622	4,609.2264	200
Slice 18	50.5	1,648.9685	0	5,330.5209	4,472.8381	200
Slice 19	63.5	1,645.4519	0	5,128.4539	4,303.2838	200
Slice 20	76.5	1,642.2557	0	4,886.4485	4,100.2171	200
Slice 21	89.5	1,639.3743	0	4,604.0157	3,863.2279	200
Slice 22	105	1,636.3787	0	4,666.506	3,915.6635	200
Slice 23	120.5	1,633.747	0	4,689.1974	3,934.7038	200
Slice 24	133.5	1,631.8995	0	4,275.2794	3,587.3854	200
Slice 25	146.5	1,630.3501	0	3,817.9141	3,203.6103	200
Slice 26	159.5	1,629.0965	0	3,380.2808	1,576.2508	150
Slice 27	171	1,628.2177	0	3,150.5881	1,469.1433	150
Slice 28	183.01069	1,627.5807	0	2,837.5587	1,323.1753	150

Slice 29	197.03206	1,627.1275	0	2,090.4972	974.81483	150
Slice 30	211.05343	1,627.0128	0	1,293.8957	1,085.7074	200
Slice 31	225.07481	1,627.2363	0	446.72496	374.84675	200

Section 22-22 Static Left SSA for Skyline Ranch.gsz

Section 22-22 Static Left SSA for Skyline Ranch.gsz Run By: Dr. Alexander Bykovtsev, Ph.D., P.E. 3/25/2016 3:25:12 PM

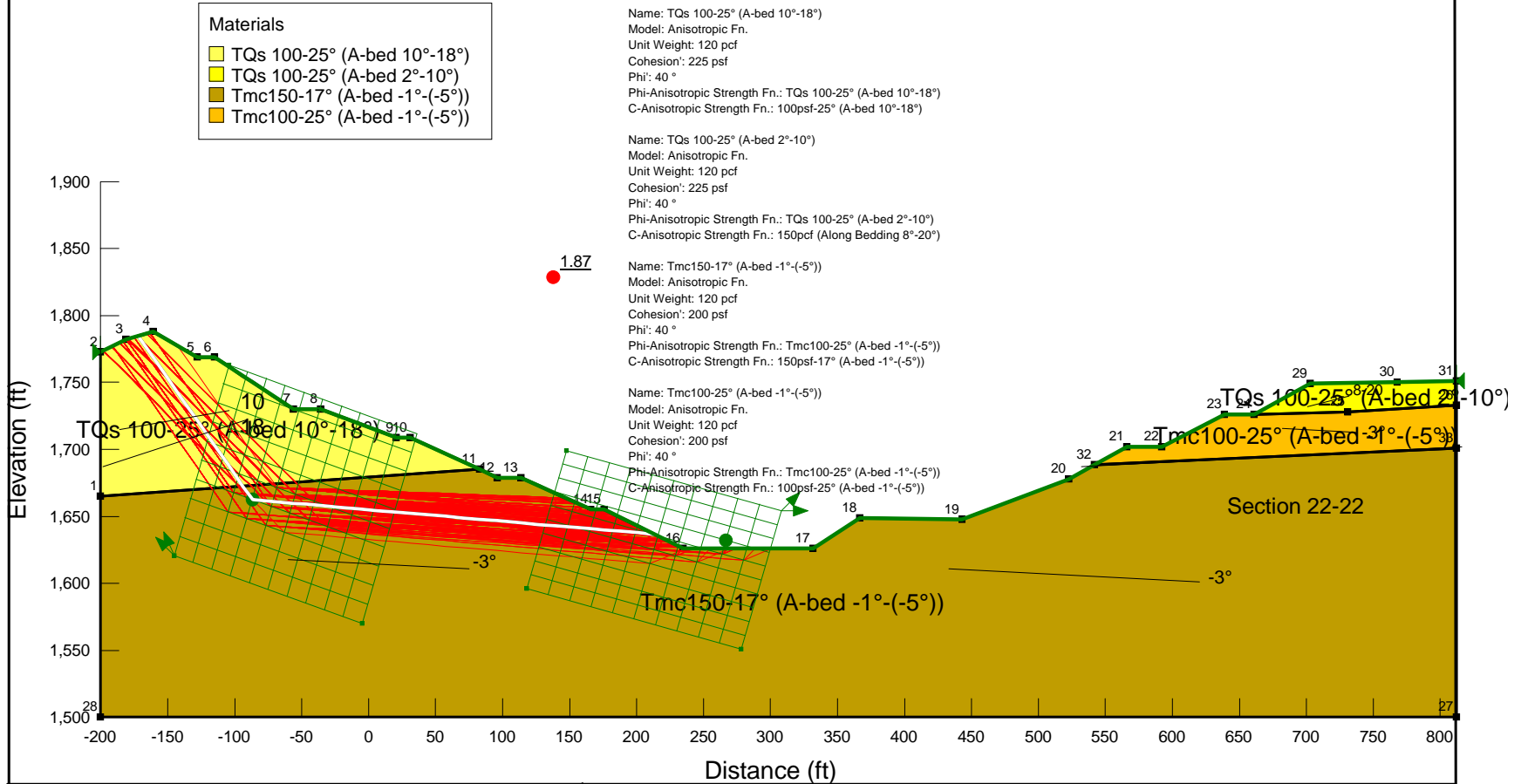

LGC **LGC Valley, Inc**
 GEOTECHNICAL CONSULTING
 28532 Constellation Road, Valencia, CA 91355
 Phone 661-702-8474, Fax 661-702-8475

Skyline Ranch
 Development project, Tract 60922
 Los Angeles CA

Project No: **153035-01**
 Engineer: **BAS**
 Date: **March 2016**

2 - Translational

Report generated using GeoStudio 2012. Copyright © 1991-2015 GEO-SLOPE International Ltd.

File Information

File Version: 8.15
 Title: Static Slope Stability Analyses for Skyline Ranch Development project, Tract 60922, Los Angeles CA
 Comments: Run By: Dr. Alexander Bykovtsev, Ph.D., P.E.
 Last Edited By: Alexander Bykovtsev
 Revision Number: 163
 Date: 3/25/2016
 Time: 3:25:12 PM
 Tool Version: 8.15.1.11236
 File Name: Section 22-22 Static Left SSA for Skyline Ranch.gsz
 Directory: G:\SLOPE RESULTS\Section 22-22 results\Latest update 3-25-2016\Latest Results 3-25-2016\
 Last Solved Date: 3/25/2016
 Last Solved Time: 3:25:36 PM

Project Settings

Length(L) Units: Feet
 Time(t) Units: Seconds
 Force(F) Units: Pounds
 Pressure(p) Units: psf
 Strength Units: psf
 Unit Weight of Water: 62.4 pcf
 View: 2D
 Element Thickness: 1

Analysis Settings

2 - Translational

Kind: SLOPE/W
 Method: Janbu
 Settings
 PWP Conditions Source: (none)
 Slip Surface
 Direction of movement: Left to Right
 Use Passive Mode: No
 Slip Surface Option: Block
 Critical slip surfaces saved: 10
 Resisting Side Maximum Convex Angle: 1 °
 Driving Side Maximum Convex Angle: 5 °
 Restrict Block Crossing: No
 Optimize Critical Slip Surface Location: No
 Tension Crack

file:///G:/SLOPE%20RESULTS/Section%2022-22%20results/Latest%20update%203-25-2... 3/25/2016

Tension Crack Option: (none)
 F of S Distribution
 F of S Calculation Option: Constant
 Advanced
 Number of Slices: 30
 F of S Tolerance: 0.01
 Minimum Slip Surface Depth: 0.1 ft

Materials

TQs 100-25° (A-bed 10°-18°)

Model: Anisotropic Fn.
 Unit Weight: 120 pcf
 Cohesion': 225 psf
 Phi': 40 °
 Phi-Anisotropic Strength Fn.: TQs 100-25° (A-bed 10°-18°)
 C-Anisotropic Strength Fn.: 100psf-25° (A-bed 10°-18°)
 Phi-B: 0 °

TQs 100-25° (A-bed 2°-10°)

Model: Anisotropic Fn.
 Unit Weight: 120 pcf
 Cohesion': 225 psf
 Phi': 40 °
 Phi-Anisotropic Strength Fn.: TQs 100-25° (A-bed 2°-10°)
 C-Anisotropic Strength Fn.: 150pcf (Along Bedding 8°-20°)
 Phi-B: 0 °

Tmc150-17° (A-bed -1°-(-5°))

Model: Anisotropic Fn.
 Unit Weight: 120 pcf
 Cohesion': 200 psf
 Phi': 40 °
 Phi-Anisotropic Strength Fn.: Tmc100-25° (A-bed -1°-(-5°))
 C-Anisotropic Strength Fn.: 150psf-17° (A-bed -1°-(-5°))
 Phi-B: 0 °

Tmc100-25° (A-bed -1°-(-5°))

Model: Anisotropic Fn.
 Unit Weight: 120 pcf
 Cohesion': 200 psf
 Phi': 40 °
 Phi-Anisotropic Strength Fn.: Tmc100-25° (A-bed -1°-(-5°))
 C-Anisotropic Strength Fn.: 100psf-25° (A-bed -1°-(-5°))
 Phi-B: 0 °

Slip Surface Limits

Left Coordinate: (-200, 1,773) ft

file:///G:/SLOPE%20RESULTS/Section%2022-22%20results/Latest%20update%203-25-2... 3/25/2016

Right Coordinate: (812, 1,751) ft

Slip Surface Block

Left Grid

Upper Left: (-104, 1,763) ft
 Lower Left: (-145, 1,621) ft
 Lower Right: (-5, 1,570) ft
 X Increments: 10
 Y Increments: 10
 Starting Angle: 115 °
 Ending Angle: 135 °
 Angle Increments: 2

Right Grid

Upper Left: (148, 1,699) ft
 Lower Left: (118, 1,596) ft
 Lower Right: (278, 1,551) ft
 X Increments: 10
 Y Increments: 10
 Starting Angle: 0 °
 Ending Angle: 45 °
 Angle Increments: 2

Seismic Coefficients

Horz Seismic Coef.: 0
 Vert Seismic Coef.: 0

Anisotropic Strength Functions

TQs 100-25° (A-bed 10°-18°)

Model: Spline Data Point Function
 Function: Modifier Factor vs. Inclination
 Curve Fit to Data: 100 %
 Segment Curvature: 0 %

Y-Intercept: 1

Data Points: Inclination (°), Modifier Factor
 Data Point: (-90, 1)
 Data Point: (9.9, 1)
 Data Point: (10, 0.625)
 Data Point: (18, 0.625)
 Data Point: (18.1, 1)

Tmc100-25° (A-bed -1°-(-5°))

Model: Spline Data Point Function
 Function: Modifier Factor vs. Inclination
 Curve Fit to Data: 100 %
 Segment Curvature: 0 %

Y-Intercept: 1

Data Points: Inclination (°), Modifier Factor
 Data Point: (-90, 1)
 Data Point: (-5.1, 1)
 Data Point: (-5, 0.625)
 Data Point: (-1, 0.625)
 Data Point: (-0.9, 1)

TQs 100-25° (A-bed 2°-10°)

Model: Spline Data Point Function
 Function: Modifier Factor vs. Inclination
 Curve Fit to Data: 100 %
 Segment Curvature: 0 %

Y-Intercept: 1

Data Points: Inclination (°), Modifier Factor
 Data Point: (-90, 1)
 Data Point: (1.9, 1)
 Data Point: (2, 0.625)
 Data Point: (10, 0.625)
 Data Point: (10.1, 1)

150pcf (Along Bedding 8°-20°)

Model: Spline Data Point Function
 Function: Modifier Factor vs. Inclination
 Curve Fit to Data: 100 %
 Segment Curvature: 0 %

Y-Intercept: 1

Data Points: Inclination (°), Modifier Factor
 Data Point: (-90, 1)
 Data Point: (7.9, 1)
 Data Point: (8, 0.667)
 Data Point: (20, 0.667)
 Data Point: (20.1, 1)

150psf-17° (A-bed -1°-(-5°))

Model: Spline Data Point Function
 Function: Modifier Factor vs. Inclination
 Curve Fit to Data: 100 %
 Segment Curvature: 0 %

Y-Intercept: 1

Data Points: Inclination (°), Modifier Factor
 Data Point: (-90, 1)
 Data Point: (-5.1, 1)
 Data Point: (-5, 0.75)
 Data Point: (-1, 0.75)
 Data Point: (-0.9, 1)

100psf-25° (A-bed 10°-18°)

Model: Spline Data Point Function
 Function: Modifier Factor vs. Inclination

Curve Fit to Data: 100 %
Segment Curvature: 0 %

Y-Intercept: 1

Data Points: Inclination (°), Modifier Factor

- Data Point: (-90, 1)
- Data Point: (9.9, 1)
- Data Point: (10, 0.444)
- Data Point: (18, 0.444)
- Data Point: (18.1, 1)

100psf-25° (A-bed -1°(-5°))

Model: Spline Data Point Function

Function: Modifier Factor vs. Inclination

Curve Fit to Data: 100 %
Segment Curvature: 0 %

Y-Intercept: 1

Data Points: Inclination (°), Modifier Factor

- Data Point: (-90, 1)
- Data Point: (-5.1, 1)
- Data Point: (-5, 0.5)
- Data Point: (-1, 0.5)
- Data Point: (-0.9, 1)

Points

	X (ft)	Y (ft)
Point 1	-200	1,665.0405
Point 2	-200	1,773
Point 3	-181	1,782
Point 4	-161	1,788
Point 5	-128	1,769
Point 6	-115	1,769
Point 7	-56	1,730
Point 8	-36	1,730
Point 9	21	1,709
Point 10	31	1,709
Point 11	83	1,685
Point 12	96	1,679
Point 13	114	1,679
Point 14	166	1,655
Point 15	176	1,655
Point 16	235	1,626
Point 17	332	1,626
Point 18	367	1,649
Point 19	443	1,648
Point 20	523	1,678
Point 21	566	1,702

Point 22	592	1,702
Point 23	639	1,726
Point 24	661	1,726
Point 25	731	1,728
Point 26	812	1,733
Point 27	812	1,500
Point 28	-200	1,500
Point 29	703	1,749
Point 30	768	1,750
Point 31	812	1,751
Point 32	542	1,688.6047
Point 33	812	1,701

Regions

	Material	Points	Area (ft²)
Region 1	TQs 100-25° (A-bed 10° -18°)	1,2,3,4,5,6,7,8,9,10,11	18,295
Region 2	TQs 100-25° (A-bed 2° -10°)	24,29,30,31,26,25	2,654
Region 3	Tmc100-25° (A-bed -1° (-5°))	32,33,26,25,24,23,22,21	6,933.1
Region 4	Tmc150-17° (A-bed -1° (-5°))	1,28,27,33,32,20,19,18,17,16,15,14,13,12,11	1.7108e+005

Current Slip Surface

Slip Surface: 51,804

F of S: 1.87

Volume: 17,312.036 ft³

Weight: 2,077,444.3 lbs

Resisting Force: 1,031,602.7 lbs

Activating Force: 551,786.92 lbs

F of S Rank (Analysis): 1 of 131,769 slip surfaces

F of S Rank (Query): 1 of 300 slip surfaces

Exit: (213.17513, 1,636.7275) ft
 Entry: (-172.13666, 1,784.659) ft
 Radius: 216.64633 ft
 Center: (63.115398, 1,821.6419) ft

Slip Slices

	X (ft)	Y (ft)	PWP (psf)	Base Normal Stress (psf)	Frictional Strength (psf)	Cohesive Strength (psf)
Slice 1	-166.56833	1,776.7066	0	600.17497	503.60659	225
Slice 2	-155.5	1,760.8994	0	1,648.1723	1,382.9807	225
Slice 3	-144.5	1,745.1898	0	2,334.7981	1,959.1283	225
Slice 4	-133.5	1,729.4801	0	3,021.424	2,535.2758	225
Slice 5	-121.5	1,712.3424	0	4,044.5281	3,393.762	225
Slice 6	-109.65795	1,695.4302	0	5,024.4194	4,215.9885	225
Slice 7	-98.973857	1,680.1717	0	5,624.6197	4,719.6164	225
Slice 8	-90.115905	1,667.5212	0	6,133.845	5,146.9071	200
Slice 9	-78.95	1,661.8423	0	9,783.4562	4,562.1006	150
Slice 10	-63.65	1,660.5269	0	8,749.7613	4,080.0807	150
Slice 11	-51	1,659.4394	0	8,283.4185	3,862.6215	150
Slice 12	-41	1,658.5796	0	8,384.4277	3,909.7229	150
Slice 13	-28.875	1,657.5372	0	8,198.491	3,823.0191	150
Slice 14	-14.625	1,656.3121	0	7,725.6082	3,602.5103	150
Slice 15	-0.375	1,655.087	0	7,252.7255	3,382.0014	150
Slice 16	13.875	1,653.8619	0	6,779.8427	3,161.4926	150
Slice 17	26	1,652.8195	0	6,593.906	3,074.7889	150
Slice 18	37.5	1,651.8308	0	6,357.5975	2,964.5964	150
Slice 19	50.5	1,650.7131	0	5,783.9713	2,697.1101	150
Slice 20	63.5	1,649.5955	0	5,210.3451	2,429.6238	150

Slice 21	76.5	1,648.4778	0	4,636.7189	2,162.1376	150
Slice 22	89.5	1,647.3602	0	4,063.0928	1,894.6513	150
Slice 23	105	1,646.0276	0	3,867.188	1,803.2994	150
Slice 24	120.5	1,644.695	0	3,671.2832	1,711.9475	150
Slice 25	133.5	1,643.5774	0	3,097.657	1,444.4612	150
Slice 26	146.5	1,642.4597	0	2,524.0309	1,176.9749	150
Slice 27	159.5	1,641.3421	0	1,950.4047	909.48863	150
Slice 28	171	1,640.3534	0	1,714.0962	799.29618	150
Slice 29	182.19586	1,639.3909	0	1,469.3792	685.18275	150
Slice 30	194.58757	1,638.3255	0	878.93581	409.8545	150
Slice 31	206.97928	1,637.2602	0	288.49248	134.52625	150

Section 22-22 pseudostatic Left SSA for Skyline Ranch.gsz

Section 22-22 pseudostatic Left SSA for Skyline Ranch.gsz Run By: Dr. Alexander Bykovtsev, Ph.D., P.E. 3/25/2016 3:14:27 PM

- Materials**
- TQs 100-25° (A-bed 10°-18°)
 - TQs 100-25° (A-bed 2°-10°)
 - Tmc150-17° (A-bed -1°-(-5°))
 - Tmc100-25° (A-bed -1°-(-5°))

Name: TQs 100-25° (A-bed 10°-18°)
 Model: Anisotropic Fn.
 Unit Weight: 120 pcf
 Cohesion: 225 psf
 Phi: 40°
 Phi-Anisotropic Strength Fn.: TQs 100-25° (A-bed 10°-18°)
 C-Anisotropic Strength Fn.: 100psf-25° (A-bed 10°-18°)

Name: TQs 100-25° (A-bed 2°-10°)
 Model: Anisotropic Fn.
 Unit Weight: 120 pcf
 Cohesion: 225 psf
 Phi: 40°
 Phi-Anisotropic Strength Fn.: TQs 100-25° (A-bed 2°-10°)
 C-Anisotropic Strength Fn.: 150psf (Along Bedding 8°-20°)

Name: Tmc150-17° (A-bed -1°-(-5°))
 Model: Anisotropic Fn.
 Unit Weight: 120 pcf
 Cohesion: 200 psf
 Phi: 40°
 Phi-Anisotropic Strength Fn.: Tmc100-25° (A-bed -1°-(-5°))
 C-Anisotropic Strength Fn.: 150psf-17° (A-bed -1°-(-5°))

Name: Tmc100-25° (A-bed -1°-(-5°))
 Model: Anisotropic Fn.
 Unit Weight: 120 pcf
 Cohesion: 200 psf
 Phi: 40°
 Phi-Anisotropic Strength Fn.: Tmc100-25° (A-bed -1°-(-5°))
 C-Anisotropic Strength Fn.: 100psf-25° (A-bed -1°-(-5°))

Seismic Load
 Horizontal: 0.15
 Vertical: 0.0

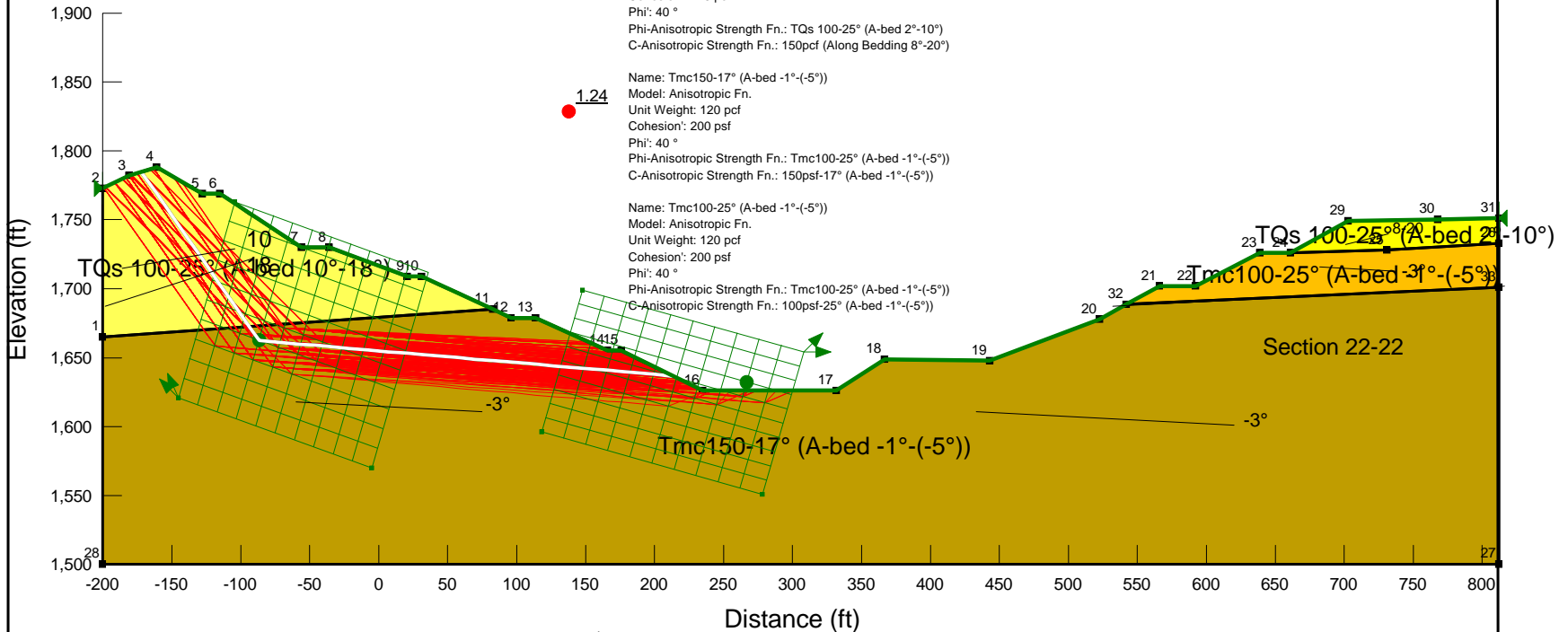

LGC **LGC Valley, Inc**
 GEOTECHNICAL CONSULTING
 28532 Constellation Road, Valencia, CA 91355
 Phone 661-702-8474, Fax 661-702-8475

Skyline Ranch
 Development project, Tract 60922
 Los Angeles CA

Project No: **153035-01**
 Engineer: **BAS**
 Date: **March 2016**

2 - Translational

Report generated using GeoStudio 2012. Copyright © 1991-2015 GEO-SLOPE International Ltd.

File Information

File Version: 8.15
 Title: Static Slope Stability Analyses for Skyline Ranch Development project, Tract 60922, Los Angeles CA
 Comments: Run By: Dr. Alexander Bykovtsev, Ph.D., P.E.
 Last Edited By: Alexander Bykovtsev
 Revision Number: 160
 Date: 3/25/2016
 Time: 3:14:27 PM
 Tool Version: 8.15.1.11236
 File Name: Section 22-22 pseudostatic Left SSA for Skyline Ranch.gsz
 Directory: G:\SLOPE RESULTS\Section 22-22 results\Latest update 3-15-2016\Latest Results 3-25-2016\
 Last Solved Date: 3/25/2016
 Last Solved Time: 3:16:44 PM

Project Settings

Length(L) Units: Feet
 Time(t) Units: Seconds
 Force(F) Units: Pounds
 Pressure(p) Units: psf
 Strength Units: psf
 Unit Weight of Water: 62.4 pcf
 View: 2D
 Element Thickness: 1

Analysis Settings

2 - Translational

Kind: SLOPE/W
 Method: Janbu
 Settings
 PWP Conditions Source: (none)
 Slip Surface
 Direction of movement: Left to Right
 Use Passive Mode: No
 Slip Surface Option: Block
 Critical slip surfaces saved: 10
 Resisting Side Maximum Convex Angle: 1 °
 Driving Side Maximum Convex Angle: 5 °
 Restrict Block Crossing: No
 Optimize Critical Slip Surface Location: No
 Tension Crack

file:///G:/SLOPE%20RESULTS/Section%2022-22%20results/Latest%20update%203-15-2... 3/25/2016

Tension Crack Option: (none)
 F of S Distribution
 F of S Calculation Option: Constant
 Advanced
 Number of Slices: 30
 F of S Tolerance: 0.01
 Minimum Slip Surface Depth: 0.1 ft

Materials

TQs 100-25° (A-bed 10°-18°)

Model: Anisotropic Fn.
 Unit Weight: 120 pcf
 Cohesion': 225 psf
 Phi': 40 °
 Phi-Anisotropic Strength Fn.: TQs 100-25° (A-bed 10°-18°)
 C-Anisotropic Strength Fn.: 100psf-25° (A-bed 10°-18°)
 Phi-B: 0 °

TQs 100-25° (A-bed 2°-10°)

Model: Anisotropic Fn.
 Unit Weight: 120 pcf
 Cohesion': 225 psf
 Phi': 40 °
 Phi-Anisotropic Strength Fn.: TQs 100-25° (A-bed 2°-10°)
 C-Anisotropic Strength Fn.: 150pcf (Along Bedding 8°-20°)
 Phi-B: 0 °

Tmc150-17° (A-bed -1°-(-5°))

Model: Anisotropic Fn.
 Unit Weight: 120 pcf
 Cohesion': 200 psf
 Phi': 40 °
 Phi-Anisotropic Strength Fn.: Tmc100-25° (A-bed -1°-(-5°))
 C-Anisotropic Strength Fn.: 150psf-17° (A-bed -1°-(-5°))
 Phi-B: 0 °

Tmc100-25° (A-bed -1°-(-5°))

Model: Anisotropic Fn.
 Unit Weight: 120 pcf
 Cohesion': 200 psf
 Phi': 40 °
 Phi-Anisotropic Strength Fn.: Tmc100-25° (A-bed -1°-(-5°))
 C-Anisotropic Strength Fn.: 100psf-25° (A-bed -1°-(-5°))
 Phi-B: 0 °

Slip Surface Limits

Left Coordinate: (-200, 1,773) ft

file:///G:/SLOPE%20RESULTS/Section%2022-22%20results/Latest%20update%203-15-2... 3/25/2016

Right Coordinate: (812, 1,751) ft

Slip Surface Block

Left Grid

Upper Left: (-104, 1,763) ft
 Lower Left: (-145, 1,621) ft
 Lower Right: (-5, 1,570) ft
 X Increments: 10
 Y Increments: 10
 Starting Angle: 115 °
 Ending Angle: 135 °
 Angle Increments: 2

Right Grid

Upper Left: (148, 1,699) ft
 Lower Left: (118, 1,596) ft
 Lower Right: (278, 1,551) ft
 X Increments: 10
 Y Increments: 10
 Starting Angle: 0 °
 Ending Angle: 45 °
 Angle Increments: 2

Seismic Coefficients

Horz Seismic Coef.: 0.15
 Vert Seismic Coef.: 0

Anisotropic Strength Functions

TQs 100-25° (A-bed 10°-18°)

Model: Spline Data Point Function
 Function: Modifier Factor vs. Inclination
 Curve Fit to Data: 100 %
 Segment Curvature: 0 %

Y-Intercept: 1

Data Points: Inclination (°), Modifier Factor
 Data Point: (-90, 1)
 Data Point: (9.9, 1)
 Data Point: (10, 0.625)
 Data Point: (18, 0.625)
 Data Point: (18.1, 1)

Tmc100-25° (A-bed -1°-(-5°))

Model: Spline Data Point Function
 Function: Modifier Factor vs. Inclination
 Curve Fit to Data: 100 %
 Segment Curvature: 0 %

Y-Intercept: 1

Data Points: Inclination (°), Modifier Factor
 Data Point: (-90, 1)
 Data Point: (-5.1, 1)
 Data Point: (-5, 0.625)
 Data Point: (-1, 0.625)
 Data Point: (-0.9, 1)

TQs 100-25° (A-bed 2°-10°)

Model: Spline Data Point Function
 Function: Modifier Factor vs. Inclination
 Curve Fit to Data: 100 %
 Segment Curvature: 0 %

Y-Intercept: 1

Data Points: Inclination (°), Modifier Factor
 Data Point: (-90, 1)
 Data Point: (1.9, 1)
 Data Point: (2, 0.625)
 Data Point: (10, 0.625)
 Data Point: (10.1, 1)

150pcf (Along Bedding 8°-20°)

Model: Spline Data Point Function
 Function: Modifier Factor vs. Inclination
 Curve Fit to Data: 100 %
 Segment Curvature: 0 %

Y-Intercept: 1

Data Points: Inclination (°), Modifier Factor
 Data Point: (-90, 1)
 Data Point: (7.9, 1)
 Data Point: (8, 0.667)
 Data Point: (20, 0.667)
 Data Point: (20.1, 1)

150psf-17° (A-bed -1°-(-5°))

Model: Spline Data Point Function
 Function: Modifier Factor vs. Inclination
 Curve Fit to Data: 100 %
 Segment Curvature: 0 %

Y-Intercept: 1

Data Points: Inclination (°), Modifier Factor
 Data Point: (-90, 1)
 Data Point: (-5.1, 1)
 Data Point: (-5, 0.75)
 Data Point: (-1, 0.75)
 Data Point: (-0.9, 1)

100psf-25° (A-bed 10°-18°)

Model: Spline Data Point Function
 Function: Modifier Factor vs. Inclination

Curve Fit to Data: 100 %
Segment Curvature: 0 %

Y-Intercept: 1

Data Points: Inclination (°), Modifier Factor

- Data Point: (-90, 1)
- Data Point: (9.9, 1)
- Data Point: (10, 0.444)
- Data Point: (18, 0.444)
- Data Point: (18.1, 1)

100psf-25° (A-bed -1°(-5°))

Model: Spline Data Point Function

Function: Modifier Factor vs. Inclination

Curve Fit to Data: 100 %
Segment Curvature: 0 %

Y-Intercept: 1

Data Points: Inclination (°), Modifier Factor

- Data Point: (-90, 1)
- Data Point: (-5.1, 1)
- Data Point: (-5, 0.5)
- Data Point: (-1, 0.5)
- Data Point: (-0.9, 1)

Points

	X (ft)	Y (ft)
Point 1	-200	1,665.0405
Point 2	-200	1,773
Point 3	-181	1,782
Point 4	-161	1,788
Point 5	-128	1,769
Point 6	-115	1,769
Point 7	-56	1,730
Point 8	-36	1,730
Point 9	21	1,709
Point 10	31	1,709
Point 11	83	1,685
Point 12	96	1,679
Point 13	114	1,679
Point 14	166	1,655
Point 15	176	1,655
Point 16	235	1,626
Point 17	332	1,626
Point 18	367	1,649
Point 19	443	1,648
Point 20	523	1,678
Point 21	566	1,702

Point 22	592	1,702
Point 23	639	1,726
Point 24	661	1,726
Point 25	731	1,728
Point 26	812	1,733
Point 27	812	1,500
Point 28	-200	1,500
Point 29	703	1,749
Point 30	768	1,750
Point 31	812	1,751
Point 32	542	1,688.6047
Point 33	812	1,701

Regions

	Material	Points	Area (ft²)
Region 1	TQs 100-25° (A-bed 10° -18°)	1,2,3,4,5,6,7,8,9,10,11	18,295
Region 2	TQs 100-25° (A-bed 2° -10°)	24,29,30,31,26,25	2,654
Region 3	Tmc100-25° (A-bed -1° (-5°))	32,33,26,25,24,23,22,21	6,933.1
Region 4	Tmc150-17° (A-bed -1° (-5°))	1,28,27,33,32,20,19,18,17,16,15,14,13,12,11	1.7108e+005

Current Slip Surface

Slip Surface: 51,804

F of S: 1.24

Volume: 17,312.036 ft³

Weight: 2,077,444.3 lbs

Resisting Force: 979,875.01 lbs

Activating Force: 787,554.94 lbs

F of S Rank (Analysis): 1 of 131,769 slip surfaces

F of S Rank (Query): 1 of 300 slip surfaces

Exit: (213.17513, 1,636.7275) ft
 Entry: (-172.13666, 1,784.659) ft
 Radius: 216.64633 ft
 Center: (63.115398, 1,821.6419) ft

Slip Slices

	X (ft)	Y (ft)	PWP (psf)	Base Normal Stress (psf)	Frictional Strength (psf)	Cohesive Strength (psf)
Slice 1	-166.56833	1,776.7066	0	457.06243	383.52092	225
Slice 2	-155.5	1,760.8994	0	1,332.3335	1,117.9606	225
Slice 3	-144.5	1,745.1898	0	1,905.7928	1,599.15	225
Slice 4	-133.5	1,729.4801	0	2,479.2521	2,080.3395	225
Slice 5	-121.5	1,712.3424	0	3,333.7327	2,797.3339	225
Slice 6	-109.65795	1,695.4302	0	4,152.1227	3,484.0446	225
Slice 7	-98.973857	1,680.1717	0	4,653.4007	3,904.6668	225
Slice 8	-90.115905	1,667.5212	0	5,083.6083	4,265.6538	200
Slice 9	-78.95	1,661.8423	0	9,677.5455	4,512.7136	150
Slice 10	-63.65	1,660.5269	0	8,654.6847	4,035.7457	150
Slice 11	-51	1,659.4394	0	8,193.2295	3,820.5657	150
Slice 12	-41	1,658.5796	0	8,293.1801	3,867.1734	150
Slice 13	-28.875	1,657.5372	0	8,109.1921	3,781.3784	150
Slice 14	-14.625	1,656.3121	0	7,641.2656	3,563.1807	150
Slice 15	-0.375	1,655.087	0	7,173.3391	3,344.9829	150
Slice 16	13.875	1,653.8619	0	6,705.4125	3,126.7852	150
Slice 17	26	1,652.8195	0	6,521.4246	3,040.9902	150
Slice 18	37.5	1,651.8308	0	6,287.5928	2,931.9527	150
Slice 19	50.5	1,650.7131	0	5,719.9787	2,667.2699	150
Slice 20	63.5	1,649.5955	0	5,152.3647	2,402.5871	150

Slice 21	76.5	1,648.4778	0	4,584.7506	2,137.9043	150
Slice 22	89.5	1,647.3602	0	4,017.1365	1,873.2215	150
Slice 23	105	1,646.0276	0	3,823.285	1,782.8271	150
Slice 24	120.5	1,644.695	0	3,629.4335	1,692.4326	150
Slice 25	133.5	1,643.5774	0	3,061.8194	1,427.7498	150
Slice 26	146.5	1,642.4597	0	2,494.2053	1,163.067	150
Slice 27	159.5	1,641.3421	0	1,926.5913	898.38426	150
Slice 28	171	1,640.3534	0	1,692.7595	789.34672	150
Slice 29	182.19586	1,639.3909	0	1,450.6073	676.4293	150
Slice 30	194.58757	1,638.3255	0	866.35234	403.98673	150
Slice 31	206.97928	1,637.2602	0	282.09737	131.54416	150

Section 22-22 Static Right SSA for Skyline Ranch.gsz

Section 22-22 Static Right SSA for Skyline Ranch.gsz Run By: Dr. Alexander Bykovtsev, Ph.D., P.E. 3/25/2016 3:43:56 PM

Materials

- TQs 100-25° (A-bed 10°-18°)
- TQs 100-25° (A-bed 2°-10°)
- Tmc150-17° (A-bed -1°-(-5°))
- Tmc100-25° (A-bed -1°-(-5°))

Name: TQs 100-25° (A-bed 10°-18°)
 Model: Anisotropic Fn.
 Unit Weight: 120 pcf
 Cohesion: 225 psf
 Phi: 40 °
 Phi-Anisotropic Strength Fn.: TQs 100-25° (A-bed 10°-18°)
 C-Anisotropic Strength Fn.: 100psf-25° (A-bed 10°-18°)

Name: TQs 100-25° (A-bed 2°-10°)
 Model: Anisotropic Fn.
 Unit Weight: 120 pcf
 Cohesion: 225 psf
 Phi: 40 °
 Phi-Anisotropic Strength Fn.: TQs 100-25° (A-bed 2°-10°)
 C-Anisotropic Strength Fn.: 150pcf (Along Bedding 8°-20°)

Name: Tmc150-17° (A-bed -1°-(-5°))
 Model: Anisotropic Fn.
 Unit Weight: 120 pcf
 Cohesion: 200 psf
 Phi: 40 °
 Phi-Anisotropic Strength Fn.: Tmc100-25° (A-bed -1°-(-5°))
 C-Anisotropic Strength Fn.: 150pcf-17° (A-bed -1°-(-5°))

Name: Tmc100-25° (A-bed -1°-(-5°))
 Model: Anisotropic Fn.
 Unit Weight: 120 pcf
 Cohesion: 200 psf
 Phi: 40 °
 Phi-Anisotropic Strength Fn.: Tmc100-25° (A-bed -1°-(-5°))
 C-Anisotropic Strength Fn.: 100psf-25° (A-bed -1°-(-5°))

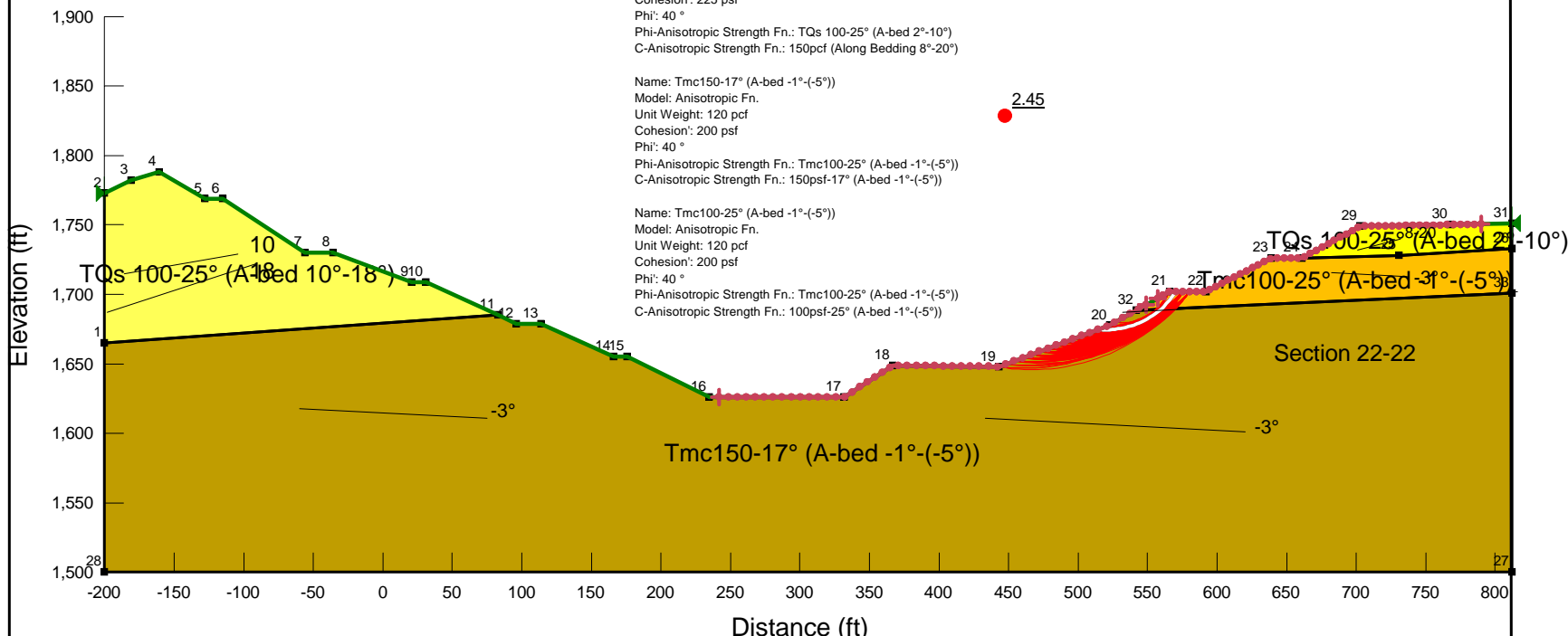

LGC **LGC Valley, Inc**
 GEOTECHNICAL CONSULTING
 28532 Constellation Road, Valencia, CA 91355
 Phone 661-702-8474, Fax 661-702-8475

Skyline Ranch
 Development project, Tract 60922
 Los Angeles CA

Project No: **153035-01**
 Engineer: **BAS**
 Date: **March 2016**

1 - Circular Mode of Failure

Report generated using GeoStudio 2012. Copyright © 1991-2015 GEO-SLOPE International Ltd.

File Information

File Version: 8.15
 Title: Static Slope Stability Analyses for Skyline Ranch Development project, Tract 60922, Los Angeles CA
 Comments: Run By: Dr. Alexander Bykovtsev, Ph.D., P.E.
 Last Edited By: Alexander Bykovtsev
 Revision Number: 174
 Date: 3/25/2016
 Time: 3:43:56 PM
 Tool Version: 8.15.1.11236
 File Name: Section 22-22 Static Right SSA for Skyline Ranch.gsz
 Directory: G:\SLOPE RESULTS\Section 22-22 results\Latest update 3-25-2016\
 Last Solved Date: 3/25/2016
 Last Solved Time: 3:47:34 PM

Project Settings

Length(L) Units: Feet
 Time(t) Units: Seconds
 Force(F) Units: Pounds
 Pressure(p) Units: psf
 Strength Units: psf
 Unit Weight of Water: 62.4 pcf
 View: 2D
 Element Thickness: 1

Analysis Settings

1 - Circular Mode of Failure

Kind: SLOPE/W
 Method: Bishop
 Settings
 PWP Conditions Source: (none)
 Slip Surface
 Direction of movement: Right to Left
 Use Passive Mode: No
 Slip Surface Option: Entry and Exit
 Critical slip surfaces saved: 10
 Resisting Side Maximum Convex Angle: 1 °
 Driving Side Maximum Convex Angle: 5 °
 Optimize Critical Slip Surface Location: No
 Tension Crack
 Tension Crack Option: (none)

file:///G:/SLOPE%20RESULTS/Section%2022-22%20results/Latest%20update%203-25-2... 3/25/2016

F of S Distribution
 F of S Calculation Option: Constant
 Advanced
 Number of Slices: 30
 F of S Tolerance: 0.01
 Minimum Slip Surface Depth: 0.1 ft

Materials

TQs 100-25° (A-bed 10°-18°)

Model: Anisotropic Fn.
 Unit Weight: 120 pcf
 Cohesion': 225 psf
 Phi': 40 °
 Phi-Anisotropic Strength Fn.: TQs 100-25° (A-bed 10°-18°)
 C-Anisotropic Strength Fn.: 100psf-25° (A-bed 10°-18°)
 Phi-B: 0 °

TQs 100-25° (A-bed 2°-10°)

Model: Anisotropic Fn.
 Unit Weight: 120 pcf
 Cohesion': 225 psf
 Phi': 40 °
 Phi-Anisotropic Strength Fn.: TQs 100-25° (A-bed 2°-10°)
 C-Anisotropic Strength Fn.: 150pcf (Along Bedding 8°-20°)
 Phi-B: 0 °

Tmc150-17° (A-bed -1°-(-5°))

Model: Anisotropic Fn.
 Unit Weight: 120 pcf
 Cohesion': 200 psf
 Phi': 40 °
 Phi-Anisotropic Strength Fn.: Tmc100-25° (A-bed -1°-(-5°))
 C-Anisotropic Strength Fn.: 150psf-17° (A-bed -1°-(-5°))
 Phi-B: 0 °

Tmc100-25° (A-bed -1°-(-5°))

Model: Anisotropic Fn.
 Unit Weight: 120 pcf
 Cohesion': 200 psf
 Phi': 40 °
 Phi-Anisotropic Strength Fn.: Tmc100-25° (A-bed -1°-(-5°))
 C-Anisotropic Strength Fn.: 100psf-25° (A-bed -1°-(-5°))
 Phi-B: 0 °

Slip Surface Entry and Exit

Left Projection: Range
 Left-Zone Left Coordinate: (242, 1,626) ft

file:///G:/SLOPE%20RESULTS/Section%2022-22%20results/Latest%20update%203-25-2... 3/25/2016

Left-Zone Right Coordinate: (549, 1,692.5117) ft
 Left-Zone Increment: 50
 Right Projection: Range
 Right-Zone Left Coordinate: (557, 1,696.9768) ft
 Right-Zone Right Coordinate: (790, 1,750.5) ft
 Right-Zone Increment: 50
 Radius Increments: 50

Slip Surface Limits

Left Coordinate: (-200, 1,773) ft
 Right Coordinate: (812, 1,751) ft

Seismic Coefficients

Horz Seismic Coef.: 0
 Vert Seismic Coef.: 0

Anisotropic Strength Functions

TQs 100-25° (A-bed 10°-18°)

Model: Spline Data Point Function
 Function: Modifier Factor vs. Inclination
 Curve Fit to Data: 100 %
 Segment Curvature: 0 %

Y-Intercept: 1

Data Points: Inclination (°), Modifier Factor

Data Point: (-90, 1)
 Data Point: (9.9, 1)
 Data Point: (10, 0.625)
 Data Point: (18, 0.625)
 Data Point: (18.1, 1)

Tmc100-25° (A-bed -1°-(-5°))

Model: Spline Data Point Function
 Function: Modifier Factor vs. Inclination
 Curve Fit to Data: 100 %
 Segment Curvature: 0 %

Y-Intercept: 1

Data Points: Inclination (°), Modifier Factor

Data Point: (-90, 1)
 Data Point: (-5.1, 1)
 Data Point: (-5, 0.625)
 Data Point: (-1, 0.625)
 Data Point: (-0.9, 1)

TQs 100-25° (A-bed 2°-10°)

Model: Spline Data Point Function

Function: Modifier Factor vs. Inclination
 Curve Fit to Data: 100 %
 Segment Curvature: 0 %

Y-Intercept: 1

Data Points: Inclination (°), Modifier Factor

Data Point: (-90, 1)
 Data Point: (1.9, 1)
 Data Point: (2, 0.625)
 Data Point: (10, 0.625)
 Data Point: (10.1, 1)

150pcf (Along Bedding 8°-20°)

Model: Spline Data Point Function
 Function: Modifier Factor vs. Inclination
 Curve Fit to Data: 100 %
 Segment Curvature: 0 %

Y-Intercept: 1

Data Points: Inclination (°), Modifier Factor

Data Point: (-90, 1)
 Data Point: (7.9, 1)
 Data Point: (8, 0.667)
 Data Point: (20, 0.667)
 Data Point: (20.1, 1)

150psf-17° (A-bed -1°-(-5°))

Model: Spline Data Point Function
 Function: Modifier Factor vs. Inclination
 Curve Fit to Data: 100 %
 Segment Curvature: 0 %

Y-Intercept: 1

Data Points: Inclination (°), Modifier Factor

Data Point: (-90, 1)
 Data Point: (-5.1, 1)
 Data Point: (-5, 0.75)
 Data Point: (-1, 0.75)
 Data Point: (-0.9, 1)

100psf-25° (A-bed 10°-18°)

Model: Spline Data Point Function
 Function: Modifier Factor vs. Inclination
 Curve Fit to Data: 100 %
 Segment Curvature: 0 %

Y-Intercept: 1

Data Points: Inclination (°), Modifier Factor

Data Point: (-90, 1)
 Data Point: (9.9, 1)
 Data Point: (10, 0.444)
 Data Point: (18, 0.444)
 Data Point: (18.1, 1)

100psf-25° (A-bed -1°(-5°))

Model: Spline Data Point Function
 Function: Modifier Factor vs. Inclination
 Curve Fit to Data: 100 %
 Segment Curvature: 0 %
 Y-Intercept: 1
 Data Points: Inclination (°), Modifier Factor
 Data Point: (-90, 1)
 Data Point: (-5.1, 1)
 Data Point: (-5, 0.5)
 Data Point: (-1, 0.5)
 Data Point: (-0.9, 1)

Points

	X (ft)	Y (ft)
Point 1	-200	1,665.0405
Point 2	-200	1,773
Point 3	-181	1,782
Point 4	-161	1,788
Point 5	-128	1,769
Point 6	-115	1,769
Point 7	-56	1,730
Point 8	-36	1,730
Point 9	21	1,709
Point 10	31	1,709
Point 11	83	1,685
Point 12	96	1,679
Point 13	114	1,679
Point 14	166	1,655
Point 15	176	1,655
Point 16	235	1,626
Point 17	332	1,626
Point 18	367	1,649
Point 19	443	1,648
Point 20	523	1,678
Point 21	566	1,702
Point 22	592	1,702
Point 23	639	1,726
Point 24	661	1,726
Point 25	731	1,728
Point 26	812	1,733
Point 27	812	1,500
Point 28	-200	1,500
Point 29	703	1,749

Point 30	768	1,750
Point 31	812	1,751
Point 32	542	1,688.6047
Point 33	812	1,701

Regions

	Material	Points	Area (ft²)
Region 1	TQs 100-25° (A-bed 10° -18°)	1,2,3,4,5,6,7,8,9,10,11	18,295
Region 2	TQs 100-25° (A-bed 2° -10°)	24,29,30,31,26,25	2,654
Region 3	Tmc100-25° (A-bed -1° (-5°))	32,33,26,25,24,23,22,21	6,933.1
Region 4	Tmc150-17° (A-bed -1° (-5°))	1,28,27,33,32,20,19,18,17,16,15,14,13,12,11	1.7108e+005

Current Slip Surface

Slip Surface: 114,620
 F of S: 2.45
 Volume: 391.35693 ft³
 Weight: 46,962.832 lbs
 Resisting Moment: 2,962,018.9 lbs-ft
 Activating Moment: 1,208,218.8 lbs-ft
 F of S Rank (Analysis): 1 of 132,651 slip surfaces
 F of S Rank (Query): 1 of 300 slip surfaces
 Exit: (514.57611, 1,674.841) ft
 Entry: (570.4518, 1,702) ft
 Radius: 59.981802 ft
 Center: (520.08275, 1,734.5695) ft

Slip Slices

	X (ft)	Y (ft)	PWP (psf)	Base Normal Stress (psf)	Frictional Strength (psf)	Cohesive Strength (psf)
Slice 1	515.4185	1,674.7753	0	51.318155	23.930049	150
Slice 2	517.10328	1,674.6677	0	138.8712	64.756702	150
Slice 3	518.78806	1,674.6076	0	219.76672	102.4789	150
Slice 4	520.47283	1,674.5949	0	293.70413	246.44703	200
	522.15761	1,674.6296	0	359.47327	301.63389	200

Slice 5						
Slice 6	523.95	1,674.7201	0	442.18814	371.03991	200
Slice 7	525.85	1,674.8733	0	540.38254	453.43479	200
Slice 8	527.75	1,675.0875	0	629.416	528.14274	200
Slice 9	529.65	1,675.3635	0	709.44259	595.29301	200
Slice 10	531.55	1,675.702	0	780.58027	654.98462	200
Slice 11	533.45	1,676.1043	0	842.91275	707.28778	200
Slice 12	535.35	1,676.5716	0	896.49061	752.24494	200
Slice 13	537.25	1,677.1055	0	941.33186	789.87121	200
Slice 14	539.15	1,677.7078	0	977.42199	820.15443	200
Slice 15	541.05	1,678.3809	0	1,004.7134	843.05461	200
Slice 16	542.9756	1,679.1383	0	1,023.2543	858.61231	200
Slice 17	544.92679	1,679.9853	0	1,032.6654	866.50917	200
Slice 18	546.87799	1,680.9166	0	1,032.4128	866.2972	200
Slice 19	548.82918	1,681.9366	0	1,022.2782	857.79326	200
Slice 20	550.78038	1,683.0508	0	1,001.991	840.77024	200
Slice 21	552.73157	1,684.2653	0	971.22121	814.95136	200
Slice 22	554.68276	1,685.5876	0	929.57122	780.00287	200
Slice 23	556.63396	1,687.0268	0	876.56427	735.52475	200
Slice 24	558.58515	1,688.5939	0	811.63049	681.03885	200
Slice 25	560.63396	1,690.3961	0	729.46155	612.09091	200
Slice 26	562.78038	1,692.4697	0	627.80021	526.78693	200
Slice 27	564.92679	1,694.7673	0	508.49233	426.67572	200
Slice 28	567.11295	1,697.3841	0	314.82507	264.1696	200

Slice 29	569.33885	1,700.3959	0	50.315563	42.21977	200
----------	-----------	------------	---	-----------	----------	-----

Section 22-22 pseudostatic Right SSA for Skyline Ranch.gsz

Section 22-22 pseudostatic Right SSA for Skyline Ranch.gsz Run By: Dr. Alexander Bykovtsev, Ph.D., P.E. 3/25/2016 3:34:46 PM

- Materials**
- TQs 100-25° (A-bed 10°-18°)
 - TQs 100-25° (A-bed 2°-10°)
 - Tmc150-17° (A-bed -1°-(-5°))
 - Tmc100-25° (A-bed -1°-(-5°))

Name: TQs 100-25° (A-bed 10°-18°)
 Model: Anisotropic Fn.
 Unit Weight: 120 pcf
 Cohesion: 225 psf
 Phi: 40°
 Phi-Anisotropic Strength Fn.: TQs 100-25° (A-bed 10°-18°)
 C-Anisotropic Strength Fn.: 100psf-25° (A-bed 10°-18°)

Seismic Load
 Horizontal: 0.15
 Vertical: 0.0

Name: TQs 100-25° (A-bed 2°-10°)
 Model: Anisotropic Fn.
 Unit Weight: 120 pcf
 Cohesion: 225 psf
 Phi: 40°
 Phi-Anisotropic Strength Fn.: TQs 100-25° (A-bed 2°-10°)
 C-Anisotropic Strength Fn.: 150pcf (Along Bedding 8°-20°)

Name: Tmc150-17° (A-bed -1°-(-5°))
 Model: Anisotropic Fn.
 Unit Weight: 120 pcf
 Cohesion: 200 psf
 Phi: 40°
 Phi-Anisotropic Strength Fn.: Tmc100-25° (A-bed -1°-(-5°))
 C-Anisotropic Strength Fn.: 150psf-17° (A-bed -1°-(-5°))

Name: Tmc100-25° (A-bed -1°-(-5°))
 Model: Anisotropic Fn.
 Unit Weight: 120 pcf
 Cohesion: 200 psf
 Phi: 40°
 Phi-Anisotropic Strength Fn.: Tmc100-25° (A-bed -1°-(-5°))
 C-Anisotropic Strength Fn.: 100psf-25° (A-bed -1°-(-5°))

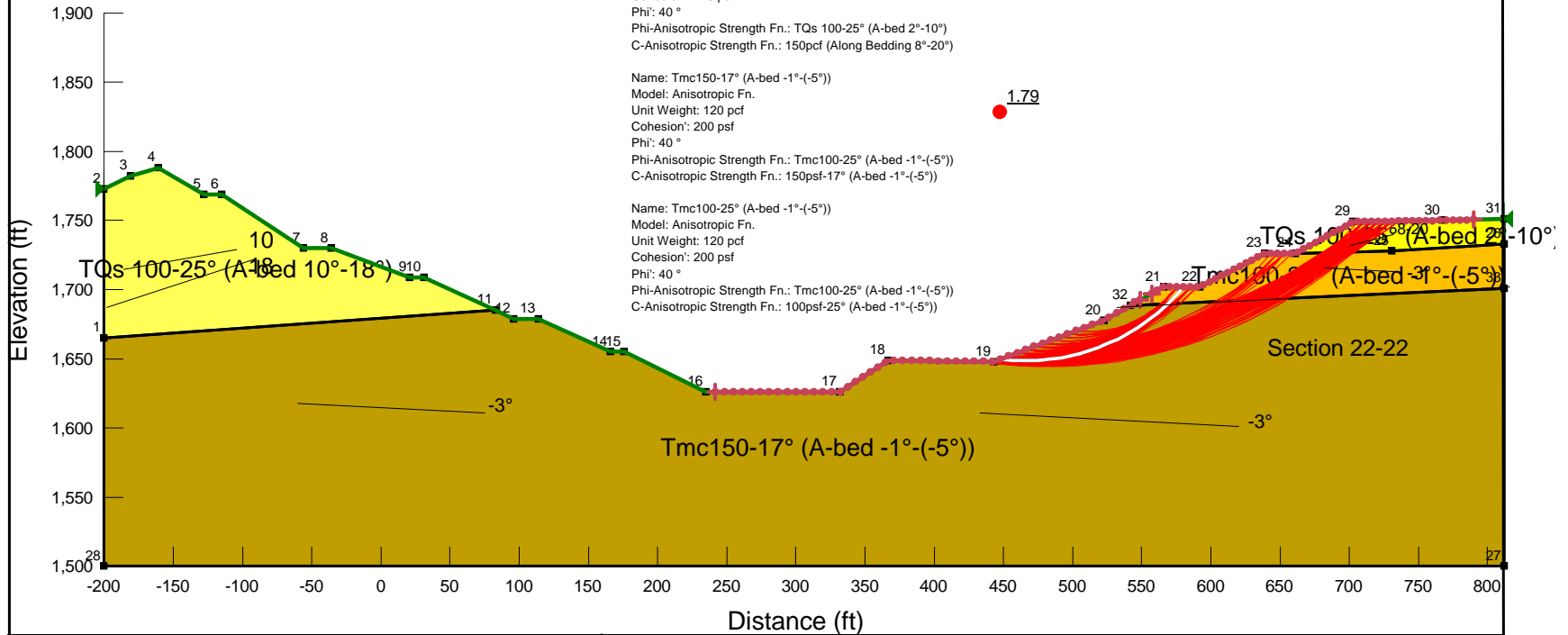

LGC Valley, Inc
 GEOTECHNICAL CONSULTING
 28532 Constellation Road, Valencia, CA 91355
 Phone 661-702-8474, Fax 661-702-8475

Skyline Ranch
 Development project, Tract 60922
 Los Angeles CA

Project No: **153035-01**
 Engineer: **BAS**
 Date: **March 2016**

1 - Circular Mode of Failure

Report generated using GeoStudio 2012. Copyright © 1991-2015 GEO-SLOPE International Ltd.

File Information

File Version: 8.15
 Title: Static Slope Stability Analyses for Skyline Ranch Development project, Tract 60922, Los Angeles CA
 Comments: Run By: Dr. Alexander Bykovtsev, Ph.D., P.E.
 Last Edited By: Alexander Bykovtsev
 Revision Number: 172
 Date: 3/25/2016
 Time: 3:34:46 PM
 Tool Version: 8.15.1.11236
 File Name: Section 22-22 pseudostatic Right SSA for Skyline Ranch.gsz
 Directory: G:\SLOPE RESULTS\Section 22-22 results\Latest update 3-25-2016\
 Last Solved Date: 3/25/2016
 Last Solved Time: 3:39:23 PM

Project Settings

Length(L) Units: Feet
 Time(t) Units: Seconds
 Force(F) Units: Pounds
 Pressure(p) Units: psf
 Strength Units: psf
 Unit Weight of Water: 62.4 pcf
 View: 2D
 Element Thickness: 1

Analysis Settings

1 - Circular Mode of Failure

Kind: SLOPE/W
 Method: Bishop
 Settings
 PWP Conditions Source: (none)
 Slip Surface
 Direction of movement: Right to Left
 Use Passive Mode: No
 Slip Surface Option: Entry and Exit
 Critical slip surfaces saved: 10
 Resisting Side Maximum Convex Angle: 1 °
 Driving Side Maximum Convex Angle: 5 °
 Optimize Critical Slip Surface Location: No
 Tension Crack
 Tension Crack Option: (none)

file:///G:/SLOPE%20RESULTS/Section%2022-22%20results/Latest%20update%203-25-2... 3/25/2016

F of S Distribution
 F of S Calculation Option: Constant
 Advanced
 Number of Slices: 30
 F of S Tolerance: 0.01
 Minimum Slip Surface Depth: 0.1 ft

Materials

TQs 100-25° (A-bed 10°-18°)

Model: Anisotropic Fn.
 Unit Weight: 120 pcf
 Cohesion': 225 psf
 Phi': 40 °
 Phi-Anisotropic Strength Fn.: TQs 100-25° (A-bed 10°-18°)
 C-Anisotropic Strength Fn.: 100psf-25° (A-bed 10°-18°)
 Phi-B: 0 °

TQs 100-25° (A-bed 2°-10°)

Model: Anisotropic Fn.
 Unit Weight: 120 pcf
 Cohesion': 225 psf
 Phi': 40 °
 Phi-Anisotropic Strength Fn.: TQs 100-25° (A-bed 2°-10°)
 C-Anisotropic Strength Fn.: 150pcf (Along Bedding 8°-20°)
 Phi-B: 0 °

Tmc150-17° (A-bed -1°-(-5°))

Model: Anisotropic Fn.
 Unit Weight: 120 pcf
 Cohesion': 200 psf
 Phi': 40 °
 Phi-Anisotropic Strength Fn.: Tmc100-25° (A-bed -1°-(-5°))
 C-Anisotropic Strength Fn.: 150psf-17° (A-bed -1°-(-5°))
 Phi-B: 0 °

Tmc100-25° (A-bed -1°-(-5°))

Model: Anisotropic Fn.
 Unit Weight: 120 pcf
 Cohesion': 200 psf
 Phi': 40 °
 Phi-Anisotropic Strength Fn.: Tmc100-25° (A-bed -1°-(-5°))
 C-Anisotropic Strength Fn.: 100psf-25° (A-bed -1°-(-5°))
 Phi-B: 0 °

Slip Surface Entry and Exit

Left Projection: Range
 Left-Zone Left Coordinate: (242, 1,626) ft

file:///G:/SLOPE%20RESULTS/Section%2022-22%20results/Latest%20update%203-25-2... 3/25/2016

Left-Zone Right Coordinate: (549, 1,692.5117) ft
Left-Zone Increment: 50
Right Projection: Range
Right-Zone Left Coordinate: (557, 1,696.9768) ft
Right-Zone Right Coordinate: (790, 1,750.5) ft
Right-Zone Increment: 50
Radius Increments: 50

Slip Surface Limits

Left Coordinate: (-200, 1,773) ft
Right Coordinate: (812, 1,751) ft

Seismic Coefficients

Horz Seismic Coef.: 0.15
Vert Seismic Coef.: 0

Anisotropic Strength Functions

TQs 100-25° (A-bed 10°-18°)

Model: Spline Data Point Function
Function: Modifier Factor vs. Inclination
Curve Fit to Data: 100 %
Segment Curvature: 0 %

Y-Intercept: 1
Data Points: Inclination (°), Modifier Factor
Data Point: (-90, 1)
Data Point: (9.9, 1)
Data Point: (10, 0.625)
Data Point: (18, 0.625)
Data Point: (18.1, 1)

Tmc100-25° (A-bed -1°-(-5°))

Model: Spline Data Point Function
Function: Modifier Factor vs. Inclination
Curve Fit to Data: 100 %
Segment Curvature: 0 %

Y-Intercept: 1
Data Points: Inclination (°), Modifier Factor
Data Point: (-90, 1)
Data Point: (-5.1, 1)
Data Point: (-5, 0.625)
Data Point: (-1, 0.625)
Data Point: (-0.9, 1)

TQs 100-25° (A-bed 2°-10°)

Model: Spline Data Point Function

Function: Modifier Factor vs. Inclination
Curve Fit to Data: 100 %
Segment Curvature: 0 %

Y-Intercept: 1
Data Points: Inclination (°), Modifier Factor
Data Point: (-90, 1)
Data Point: (1.9, 1)
Data Point: (2, 0.625)
Data Point: (10, 0.625)
Data Point: (10.1, 1)

150pcf (Along Bedding 8°-20°)

Model: Spline Data Point Function
Function: Modifier Factor vs. Inclination
Curve Fit to Data: 100 %
Segment Curvature: 0 %

Y-Intercept: 1
Data Points: Inclination (°), Modifier Factor
Data Point: (-90, 1)
Data Point: (7.9, 1)
Data Point: (8, 0.667)
Data Point: (20, 0.667)
Data Point: (20.1, 1)

150psf-17° (A-bed -1°-(-5°))

Model: Spline Data Point Function
Function: Modifier Factor vs. Inclination
Curve Fit to Data: 100 %
Segment Curvature: 0 %

Y-Intercept: 1
Data Points: Inclination (°), Modifier Factor
Data Point: (-90, 1)
Data Point: (-5.1, 1)
Data Point: (-5, 0.75)
Data Point: (-1, 0.75)
Data Point: (-0.9, 1)

100psf-25° (A-bed 10°-18°)

Model: Spline Data Point Function
Function: Modifier Factor vs. Inclination
Curve Fit to Data: 100 %
Segment Curvature: 0 %

Y-Intercept: 1
Data Points: Inclination (°), Modifier Factor
Data Point: (-90, 1)
Data Point: (9.9, 1)
Data Point: (10, 0.444)
Data Point: (18, 0.444)
Data Point: (18.1, 1)

100psf-25° (A-bed -1°(-5°))

Model: Spline Data Point Function
 Function: Modifier Factor vs. Inclination
 Curve Fit to Data: 100 %
 Segment Curvature: 0 %
 Y-Intercept: 1
 Data Points: Inclination (°), Modifier Factor
 Data Point: (-90, 1)
 Data Point: (-5.1, 1)
 Data Point: (-5, 0.5)
 Data Point: (-1, 0.5)
 Data Point: (-0.9, 1)

Points

	X (ft)	Y (ft)
Point 1	-200	1,665.0405
Point 2	-200	1,773
Point 3	-181	1,782
Point 4	-161	1,788
Point 5	-128	1,769
Point 6	-115	1,769
Point 7	-56	1,730
Point 8	-36	1,730
Point 9	21	1,709
Point 10	31	1,709
Point 11	83	1,685
Point 12	96	1,679
Point 13	114	1,679
Point 14	166	1,655
Point 15	176	1,655
Point 16	235	1,626
Point 17	332	1,626
Point 18	367	1,649
Point 19	443	1,648
Point 20	523	1,678
Point 21	566	1,702
Point 22	592	1,702
Point 23	639	1,726
Point 24	661	1,726
Point 25	731	1,728
Point 26	812	1,733
Point 27	812	1,500
Point 28	-200	1,500
Point 29	703	1,749

Point 30	768	1,750
Point 31	812	1,751
Point 32	542	1,688.6047
Point 33	812	1,701

Regions

	Material	Points	Area (ft²)
Region 1	TQs 100-25° (A-bed 10° -18°)	1,2,3,4,5,6,7,8,9,10,11	18,295
Region 2	TQs 100-25° (A-bed 2° -10°)	24,29,30,31,26,25	2,654
Region 3	Tmc100-25° (A-bed -1° (-5°))	32,33,26,25,24,23,22,21	6,933.1
Region 4	Tmc150-17° (A-bed -1° (-5°))	1,28,27,33,32,20,19,18,17,16,15,14,13,12,11	1.7108e+005

Current Slip Surface

Slip Surface: 86,107
 F of S: 1.79
 Volume: 1,812.5546 ft³
 Weight: 217,506.55 lbs
 Resisting Moment: 28,443,985 lbs-ft
 Activating Moment: 15,916,884 lbs-ft
 F of S Rank (Analysis): 1 of 132,651 slip surfaces
 F of S Rank (Query): 1 of 300 slip surfaces
 Exit: (448.01933, 1,649.8823) ft
 Entry: (580.29095, 1,702) ft
 Radius: 148.63848 ft
 Center: (466.30091, 1,797.3922) ft

Slip Slices

	X (ft)	Y (ft)	PWP (psf)	Base Normal Stress (psf)	Frictional Strength (psf)	Cohesive Strength (psf)
Slice 1	450.22465	1,649.6423	0	147.725	123.95599	200
Slice 2	454.63528	1,649.2287	0	390.75475	182.21193	150
Slice 3	459.0459	1,648.9473	0	620.38457	289.29008	150
Slice 4	463.45653	1,648.7973	0	830.61423	387.32178	150
	467.86716	1,648.7783	0	1,019.4097	855.3863	200

Slice 5						
Slice 6	472.27779	1,648.8903	0	1,183.8301	993.3514	200
Slice 7	476.68841	1,649.1336	0	1,328.4882	1,114.734	200
Slice 8	481.09904	1,649.5088	0	1,454.0196	1,220.0673	200
Slice 9	485.50967	1,650.0169	0	1,560.9737	1,309.8125	200
Slice 10	489.92029	1,650.6593	0	1,649.8227	1,384.3656	200
Slice 11	494.33092	1,651.4378	0	1,720.9684	1,444.064	200
Slice 12	498.74155	1,652.3546	0	1,774.7487	1,489.191	200
Slice 13	503.15218	1,653.4123	0	1,811.4417	1,519.9801	200
Slice 14	507.5628	1,654.6141	0	1,831.2701	1,536.6181	200
Slice 15	511.97343	1,655.9636	0	1,834.4038	1,539.2476	200
Slice 16	516.38406	1,657.4651	0	1,820.9629	1,527.9693	200
Slice 17	520.79469	1,659.1236	0	1,791.0187	1,502.8431	200
Slice 18	525.375	1,661.0215	0	1,785.52	1,498.2291	200
Slice 19	530.125	1,663.1798	0	1,801.03	1,511.2436	200
Slice 20	534.875	1,665.5444	0	1,794.428	1,505.7039	200
Slice 21	539.625	1,668.1269	0	1,765.4639	1,481.4001	200
Slice 22	544.4	1,670.9565	0	1,713.3964	1,437.7103	200
Slice 23	549.2	1,674.0521	0	1,637.5306	1,374.0514	200
Slice 24	554	1,677.4196	0	1,537.4465	1,290.0708	200
Slice 25	558.8	1,681.0826	0	1,412.4479	1,185.1845	200
Slice 26	563.6	1,685.0703	0	1,261.706	1,058.6971	200
Slice 27	567.44814	1,688.4944	0	1,056.7822	886.74553	200
Slice 28	570.7954	1,691.7174	0	767.62652	644.11513	200

Slice 29	574.59362	1,695.616	0	431.82252	362.34211	200
Slice 30	578.39184	1,699.8183	0	86.739501	72.783083	200

Section 22-22 Static Right SSA for Skyline Ranch.gsz

Section 22-22 Static Right SSA for Skyline Ranch.gsz Run By: Dr. Alexander Bykovtsev, Ph.D., P.E. 3/25/2016 3:43:56 PM

Materials

- TQs 100-25° (A-bed 10°-18°)
- TQs 100-25° (A-bed 2°-10°)
- Tmc150-17° (A-bed -1°-(-5°))
- Tmc100-25° (A-bed -1°-(-5°))

Name: TQs 100-25° (A-bed 10°-18°)
 Model: Anisotropic Fn.
 Unit Weight: 120 pcf
 Cohesion: 225 psf
 Phi: 40°
 Phi-Anisotropic Strength Fn.: TQs 100-25° (A-bed 10°-18°)
 C-Anisotropic Strength Fn.: 100psf-25° (A-bed 10°-18°)

Name: TQs 100-25° (A-bed 2°-10°)
 Model: Anisotropic Fn.
 Unit Weight: 120 pcf
 Cohesion: 225 psf
 Phi: 40°
 Phi-Anisotropic Strength Fn.: TQs 100-25° (A-bed 2°-10°)
 C-Anisotropic Strength Fn.: 150pcf (Along Bedding 8°-20°)

Name: Tmc150-17° (A-bed -1°-(-5°))
 Model: Anisotropic Fn.
 Unit Weight: 120 pcf
 Cohesion: 200 psf
 Phi: 40°
 Phi-Anisotropic Strength Fn.: Tmc100-25° (A-bed -1°-(-5°))
 C-Anisotropic Strength Fn.: 150psf-17° (A-bed -1°-(-5°))

Name: Tmc100-25° (A-bed -1°-(-5°))
 Model: Anisotropic Fn.
 Unit Weight: 120 pcf
 Cohesion: 200 psf
 Phi: 40°
 Phi-Anisotropic Strength Fn.: Tmc100-25° (A-bed -1°-(-5°))
 C-Anisotropic Strength Fn.: 100psf-25° (A-bed -1°-(-5°))

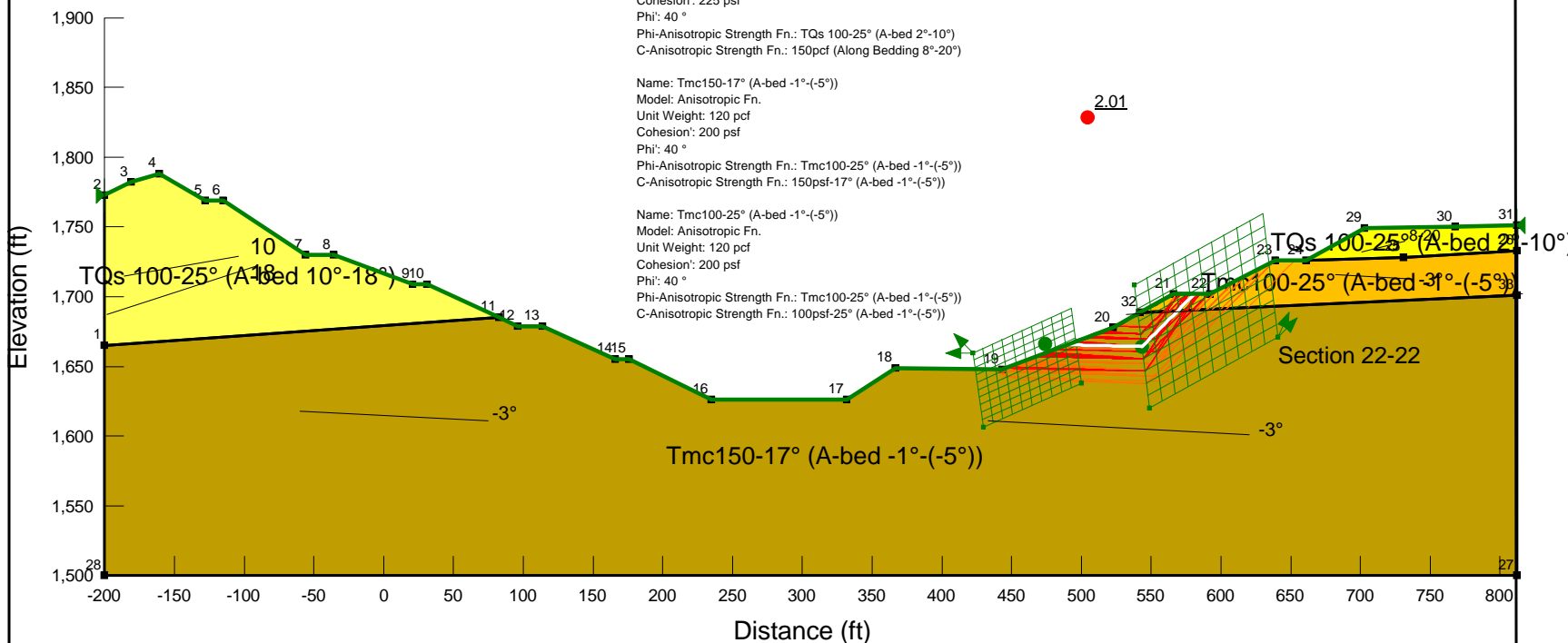

LGC Valley, Inc
 GEOTECHNICAL CONSULTING
 28532 Constellation Road, Valencia, CA 91355
 Phone 661-702-8474, Fax 661-702-8475

Skyline Ranch
 Development project, Tract 60922
 Los Angeles CA

Project No: **153035-01**
 Engineer: **BAS**
 Date: **March 2016**

2 - Translational

Report generated using GeoStudio 2012. Copyright © 1991-2015 GEO-SLOPE International Ltd.

File Information

File Version: 8.15
 Title: Static Slope Stability Analyses for Skyline Ranch Development project, Tract 60922, Los Angeles CA
 Comments: Run By: Dr. Alexander Bykovtsev, Ph.D., P.E.
 Last Edited By: Alexander Bykovtsev
 Revision Number: 174
 Date: 3/25/2016
 Time: 3:43:56 PM
 Tool Version: 8.15.1.11236
 File Name: Section 22-22 Static Right SSA for Skyline Ranch.gsz
 Directory: G:\SLOPE RESULTS\Section 22-22 results\Latest update 3-25-2016\
 Last Solved Date: 3/25/2016
 Last Solved Time: 3:44:27 PM

Project Settings

Length(L) Units: Feet
 Time(t) Units: Seconds
 Force(F) Units: Pounds
 Pressure(p) Units: psf
 Strength Units: psf
 Unit Weight of Water: 62.4 pcf
 View: 2D
 Element Thickness: 1

Analysis Settings

2 - Translational

Kind: SLOPE/W
 Method: Janbu
 Settings
 PWP Conditions Source: (none)
 Slip Surface
 Direction of movement: Right to Left
 Use Passive Mode: No
 Slip Surface Option: Block
 Critical slip surfaces saved: 10
 Resisting Side Maximum Convex Angle: 1 °
 Driving Side Maximum Convex Angle: 5 °
 Restrict Block Crossing: No
 Optimize Critical Slip Surface Location: No
 Tension Crack

file:///G:/SLOPE%20RESULTS/Section%2022-22%20results/Latest%20update%203-25-2... 3/25/2016

Tension Crack Option: (none)
 F of S Distribution
 F of S Calculation Option: Constant
 Advanced
 Number of Slices: 30
 F of S Tolerance: 0.01
 Minimum Slip Surface Depth: 0.1 ft

Materials

TQs 100-25° (A-bed 10°-18°)

Model: Anisotropic Fn.
 Unit Weight: 120 pcf
 Cohesion': 225 psf
 Phi': 40 °
 Phi-Anisotropic Strength Fn.: TQs 100-25° (A-bed 10°-18°)
 C-Anisotropic Strength Fn.: 100psf-25° (A-bed 10°-18°)
 Phi-B: 0 °

TQs 100-25° (A-bed 2°-10°)

Model: Anisotropic Fn.
 Unit Weight: 120 pcf
 Cohesion': 225 psf
 Phi': 40 °
 Phi-Anisotropic Strength Fn.: TQs 100-25° (A-bed 2°-10°)
 C-Anisotropic Strength Fn.: 150pcf (Along Bedding 8°-20°)
 Phi-B: 0 °

Tmc150-17° (A-bed -1°-(-5°))

Model: Anisotropic Fn.
 Unit Weight: 120 pcf
 Cohesion': 200 psf
 Phi': 40 °
 Phi-Anisotropic Strength Fn.: Tmc100-25° (A-bed -1°-(-5°))
 C-Anisotropic Strength Fn.: 150psf-17° (A-bed -1°-(-5°))
 Phi-B: 0 °

Tmc100-25° (A-bed -1°-(-5°))

Model: Anisotropic Fn.
 Unit Weight: 120 pcf
 Cohesion': 200 psf
 Phi': 40 °
 Phi-Anisotropic Strength Fn.: Tmc100-25° (A-bed -1°-(-5°))
 C-Anisotropic Strength Fn.: 100psf-25° (A-bed -1°-(-5°))
 Phi-B: 0 °

Slip Surface Limits

Left Coordinate: (-200, 1,773) ft

file:///G:/SLOPE%20RESULTS/Section%2022-22%20results/Latest%20update%203-25-2... 3/25/2016

Right Coordinate: (812, 1,751) ft

Slip Surface Block

Left Grid

Upper Left: (422.5932, 1,659.817) ft
 Lower Left: (429.7437, 1,606.3915) ft
 Lower Right: (500.0051, 1,637.9872) ft
 X Increments: 10
 Y Increments: 10
 Starting Angle: 135 °
 Ending Angle: 180 °
 Angle Increments: 2

Right Grid

Upper Left: (538.0094, 1,708.4308) ft
 Lower Left: (548.9525, 1,620.2038) ft
 Lower Right: (641.0569, 1,671.1037) ft
 X Increments: 10
 Y Increments: 10
 Starting Angle: 45 °
 Ending Angle: 65 °
 Angle Increments: 2

Seismic Coefficients

Horz Seismic Coef.: 0
 Vert Seismic Coef.: 0

Anisotropic Strength Functions

TQs 100-25° (A-bed 10°-18°)

Model: Spline Data Point Function
 Function: Modifier Factor vs. Inclination
 Curve Fit to Data: 100 %
 Segment Curvature: 0 %

Y-Intercept: 1

Data Points: Inclination (°), Modifier Factor
 Data Point: (-90, 1)
 Data Point: (9.9, 1)
 Data Point: (10, 0.625)
 Data Point: (18, 0.625)
 Data Point: (18.1, 1)

Tmc100-25° (A-bed -1°-(-5°))

Model: Spline Data Point Function
 Function: Modifier Factor vs. Inclination
 Curve Fit to Data: 100 %
 Segment Curvature: 0 %

Y-Intercept: 1

Data Points: Inclination (°), Modifier Factor
 Data Point: (-90, 1)
 Data Point: (-5.1, 1)
 Data Point: (-5, 0.625)
 Data Point: (-1, 0.625)
 Data Point: (-0.9, 1)

TQs 100-25° (A-bed 2°-10°)

Model: Spline Data Point Function
 Function: Modifier Factor vs. Inclination
 Curve Fit to Data: 100 %
 Segment Curvature: 0 %

Y-Intercept: 1

Data Points: Inclination (°), Modifier Factor
 Data Point: (-90, 1)
 Data Point: (1.9, 1)
 Data Point: (2, 0.625)
 Data Point: (10, 0.625)
 Data Point: (10.1, 1)

150pcf (Along Bedding 8°-20°)

Model: Spline Data Point Function
 Function: Modifier Factor vs. Inclination
 Curve Fit to Data: 100 %
 Segment Curvature: 0 %

Y-Intercept: 1

Data Points: Inclination (°), Modifier Factor
 Data Point: (-90, 1)
 Data Point: (7.9, 1)
 Data Point: (8, 0.667)
 Data Point: (20, 0.667)
 Data Point: (20.1, 1)

150psf-17° (A-bed -1°-(-5°))

Model: Spline Data Point Function
 Function: Modifier Factor vs. Inclination
 Curve Fit to Data: 100 %
 Segment Curvature: 0 %

Y-Intercept: 1

Data Points: Inclination (°), Modifier Factor
 Data Point: (-90, 1)
 Data Point: (-5.1, 1)
 Data Point: (-5, 0.75)
 Data Point: (-1, 0.75)
 Data Point: (-0.9, 1)

100psf-25° (A-bed 10°-18°)

Model: Spline Data Point Function
 Function: Modifier Factor vs. Inclination

Curve Fit to Data: 100 %
Segment Curvature: 0 %

Y-Intercept: 1

Data Points: Inclination (°), Modifier Factor

- Data Point: (-90, 1)
- Data Point: (9.9, 1)
- Data Point: (10, 0.444)
- Data Point: (18, 0.444)
- Data Point: (18.1, 1)

100psf-25° (A-bed -1°(-5°))

Model: Spline Data Point Function

Function: Modifier Factor vs. Inclination

Curve Fit to Data: 100 %
Segment Curvature: 0 %

Y-Intercept: 1

Data Points: Inclination (°), Modifier Factor

- Data Point: (-90, 1)
- Data Point: (-5.1, 1)
- Data Point: (-5, 0.5)
- Data Point: (-1, 0.5)
- Data Point: (-0.9, 1)

Points

	X (ft)	Y (ft)
Point 1	-200	1,665.0405
Point 2	-200	1,773
Point 3	-181	1,782
Point 4	-161	1,788
Point 5	-128	1,769
Point 6	-115	1,769
Point 7	-56	1,730
Point 8	-36	1,730
Point 9	21	1,709
Point 10	31	1,709
Point 11	83	1,685
Point 12	96	1,679
Point 13	114	1,679
Point 14	166	1,655
Point 15	176	1,655
Point 16	235	1,626
Point 17	332	1,626
Point 18	367	1,649
Point 19	443	1,648
Point 20	523	1,678
Point 21	566	1,702

Point 22	592	1,702
Point 23	639	1,726
Point 24	661	1,726
Point 25	731	1,728
Point 26	812	1,733
Point 27	812	1,500
Point 28	-200	1,500
Point 29	703	1,749
Point 30	768	1,750
Point 31	812	1,751
Point 32	542	1,688.6047
Point 33	812	1,701

Regions

	Material	Points	Area (ft²)
Region 1	TQs 100-25° (A-bed 10° -18°)	1,2,3,4,5,6,7,8,9,10,11	18,295
Region 2	TQs 100-25° (A-bed 2° -10°)	24,29,30,31,26,25	2,654
Region 3	Tmc100-25° (A-bed -1° (-5°))	32,33,26,25,24,23,22,21	6,933.1
Region 4	Tmc150-17° (A-bed -1° (-5°))	1,28,27,33,32,20,19,18,17,16,15,14,13,12,11	1.7108e+005

Current Slip Surface

Slip Surface: 92,368
 F of S: 2.01
 Volume: 1,180.4526 ft³
 Weight: 141,654.31 lbs
 Resisting Force: 88,231.604 lbs
 Activating Force: 43,801.645 lbs
 F of S Rank (Analysis): 1 of 131,769 slip surfaces
 F of S Rank (Query): 1 of 300 slip surfaces

Exit: (489.78392, 1,665.544) ft
 Entry: (581.16365, 1,702) ft
 Radius: 54.17577 ft
 Center: (524.56566, 1,711.114) ft

Slip Slices

	X (ft)	Y (ft)	PWP (psf)	Base Normal Stress (psf)	Frictional Strength (psf)	Cohesive Strength (psf)
Slice 1	491.29374	1,665.5095	0	74.177567	34.589567	150
Slice 2	494.31339	1,665.4405	0	219.10696	102.17125	150
Slice 3	497.33303	1,665.3715	0	364.03635	169.75294	150
Slice 4	500.35267	1,665.3025	0	508.96574	237.33462	150
Slice 5	503.37232	1,665.2336	0	653.89513	304.9163	150
Slice 6	506.39196	1,665.1646	0	798.82452	372.49799	150
Slice 7	509.4116	1,665.0956	0	943.7539	440.07967	150
Slice 8	512.43125	1,665.0266	0	1,088.6833	507.66136	150
Slice 9	515.45089	1,664.9576	0	1,233.6127	575.24304	150
Slice 10	518.47053	1,664.8886	0	1,378.5421	642.82473	150
Slice 11	521.49018	1,664.8197	0	1,523.4715	710.40641	150
Slice 12	524.58333	1,664.749	0	1,706.9114	795.94584	150
Slice 13	527.75	1,664.6767	0	1,928.8618	899.44302	150
Slice 14	530.91667	1,664.6043	0	2,150.8122	1,002.9402	150
Slice 15	534.08333	1,664.532	0	2,372.7626	1,106.4374	150
Slice 16	537.25	1,664.4596	0	2,594.713	1,209.9346	150
Slice 17	540.41667	1,664.3873	0	2,816.6635	1,313.4317	150
Slice 18	542.74047	1,664.3342	0	2,979.5379	1,389.3813	150
Slice 19	545.08945	1,665.9258	0	1,996.1248	1,674.9476	200
Slice 20	548.30646	1,669.1428	0	1,875.7643	1,573.9532	200

Slice 21	551.52347	1,672.3598	0	1,755.4039	1,472.9588	200
Slice 22	554.74047	1,675.5768	0	1,635.0435	1,371.9644	200
Slice 23	557.95748	1,678.7938	0	1,514.6831	1,270.97	200
Slice 24	561.17449	1,682.0108	0	1,394.3226	1,169.9756	200
Slice 25	564.3915	1,685.2278	0	1,273.9622	1,068.9812	200
Slice 26	567.50413	1,688.3405	0	1,086.4229	911.61708	200
Slice 27	570.52768	1,691.364	0	830.40982	696.79657	200
Slice 28	573.56653	1,694.4029	0	573.10169	480.88942	200
Slice 29	576.60538	1,697.4417	0	315.79357	264.98227	200
Slice 30	579.64423	1,700.4806	0	58.485447	49.075117	200

Section 22-22 pseudostatic Right SSA for Skyline Ranch.gsz

Section 22-22 pseudostatic Right SSA for Skyline Ranch.gsz Run By: Dr. Alexander Bykovtsev, Ph.D., P.E. 3/25/2016 3:34:46 PM

- Materials**
- TQs 100-25° (A-bed 10°-18°)
 - TQs 100-25° (A-bed 2°-10°)
 - Tmc150-17° (A-bed -1°-(-5°))
 - Tmc100-25° (A-bed -1°-(-5°))

Name: TQs 100-25° (A-bed 10°-18°)
 Model: Anisotropic Fn.
 Unit Weight: 120 pcf
 Cohesion: 225 psf
 Phi: 40°
 Phi-Anisotropic Strength Fn.: TQs 100-25° (A-bed 10°-18°)
 C-Anisotropic Strength Fn.: 100psf-25° (A-bed 10°-18°)

Name: TQs 100-25° (A-bed 2°-10°)
 Model: Anisotropic Fn.
 Unit Weight: 120 pcf
 Cohesion: 225 psf
 Phi: 40°
 Phi-Anisotropic Strength Fn.: TQs 100-25° (A-bed 2°-10°)
 C-Anisotropic Strength Fn.: 150pcf (Along Bedding 8°-20°)

Name: Tmc150-17° (A-bed -1°-(-5°))
 Model: Anisotropic Fn.
 Unit Weight: 120 pcf
 Cohesion: 200 psf
 Phi: 40°
 Phi-Anisotropic Strength Fn.: Tmc100-25° (A-bed -1°-(-5°))
 C-Anisotropic Strength Fn.: 150psf-17° (A-bed -1°-(-5°))

Name: Tmc100-25° (A-bed -1°-(-5°))
 Model: Anisotropic Fn.
 Unit Weight: 120 pcf
 Cohesion: 200 psf
 Phi: 40°
 Phi-Anisotropic Strength Fn.: Tmc100-25° (A-bed -1°-(-5°))
 C-Anisotropic Strength Fn.: 100psf-25° (A-bed -1°-(-5°))

Seismic Load
 Horizontal: 0.15
 Vertical: 0.0

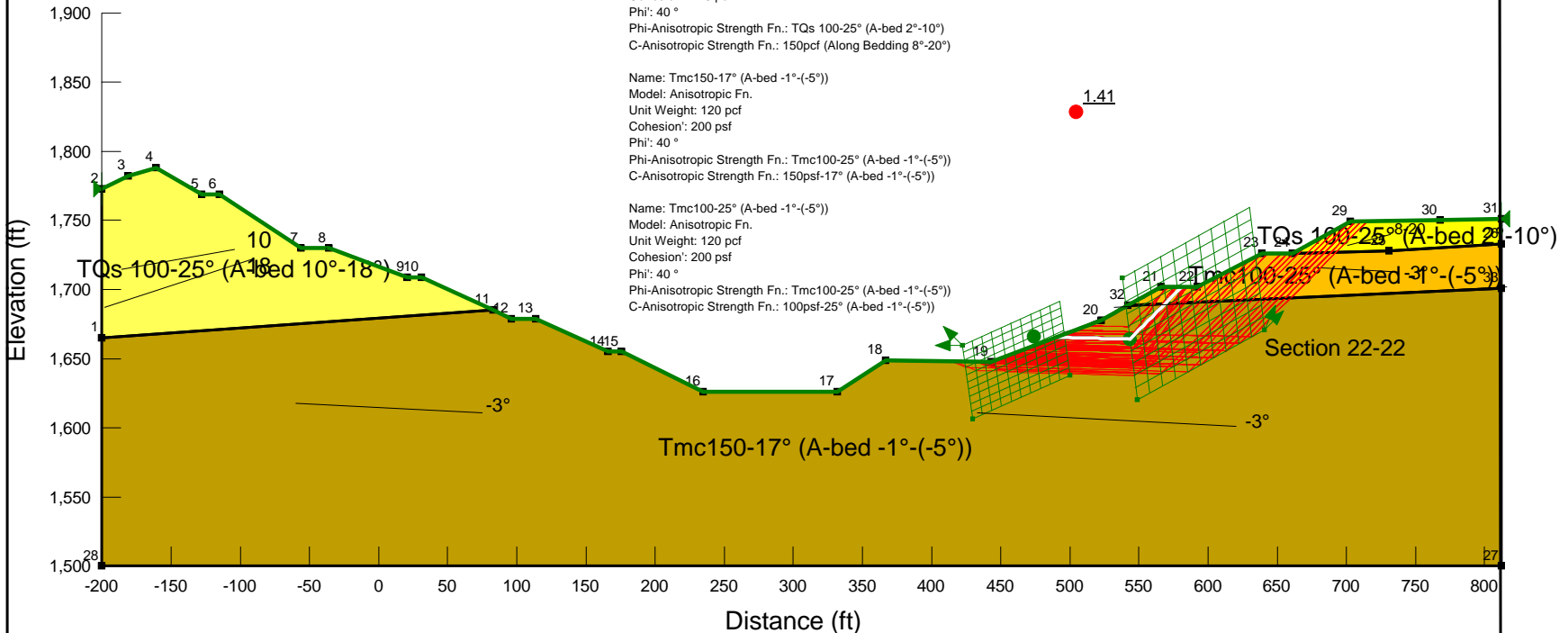

LGC Valley, Inc
 GEOTECHNICAL CONSULTING
 28532 Constellation Road, Valencia, CA 91355
 Phone 661-702-8474, Fax 661-702-8475

Skyline Ranch
 Development project, Tract 60922
 Los Angeles CA

Project No: **153035-01**
 Engineer: **BAS**
 Date: **March 2016**

2 - Translational

Report generated using GeoStudio 2012. Copyright © 1991-2015 GEO-SLOPE International Ltd.

File Information

File Version: 8.15
 Title: Static Slope Stability Analyses for Skyline Ranch Development project, Tract 60922, Los Angeles CA
 Comments: Run By: Dr. Alexander Bykovtsev, Ph.D., P.E.
 Last Edited By: Alexander Bykovtsev
 Revision Number: 172
 Date: 3/25/2016
 Time: 3:34:46 PM
 Tool Version: 8.15.1.11236
 File Name: Section 22-22 pseudostatic Right SSA for Skyline Ranch.gsz
 Directory: G:\SLOPE RESULTS\Section 22-22 results\Latest update 3-25-2016\
 Last Solved Date: 3/25/2016
 Last Solved Time: 3:35:09 PM

Project Settings

Length(L) Units: Feet
 Time(t) Units: Seconds
 Force(F) Units: Pounds
 Pressure(p) Units: psf
 Strength Units: psf
 Unit Weight of Water: 62.4 pcf
 View: 2D
 Element Thickness: 1

Analysis Settings

2 - Translational

Kind: SLOPE/W
 Method: Janbu
 Settings
 PWP Conditions Source: (none)
 Slip Surface
 Direction of movement: Right to Left
 Use Passive Mode: No
 Slip Surface Option: Block
 Critical slip surfaces saved: 10
 Resisting Side Maximum Convex Angle: 1 °
 Driving Side Maximum Convex Angle: 5 °
 Restrict Block Crossing: No
 Optimize Critical Slip Surface Location: No
 Tension Crack

file:///G:/SLOPE%20RESULTS/Section%2022-22%20results/Latest%20update%203-25-2... 3/25/2016

Tension Crack Option: (none)
 F of S Distribution
 F of S Calculation Option: Constant
 Advanced
 Number of Slices: 30
 F of S Tolerance: 0.01
 Minimum Slip Surface Depth: 0.1 ft

Materials

TQs 100-25° (A-bed 10°-18°)

Model: Anisotropic Fn.
 Unit Weight: 120 pcf
 Cohesion': 225 psf
 Phi': 40 °
 Phi-Anisotropic Strength Fn.: TQs 100-25° (A-bed 10°-18°)
 C-Anisotropic Strength Fn.: 100psf-25° (A-bed 10°-18°)
 Phi-B: 0 °

TQs 100-25° (A-bed 2°-10°)

Model: Anisotropic Fn.
 Unit Weight: 120 pcf
 Cohesion': 225 psf
 Phi': 40 °
 Phi-Anisotropic Strength Fn.: TQs 100-25° (A-bed 2°-10°)
 C-Anisotropic Strength Fn.: 150pcf (Along Bedding 8°-20°)
 Phi-B: 0 °

Tmc150-17° (A-bed -1°-(-5°))

Model: Anisotropic Fn.
 Unit Weight: 120 pcf
 Cohesion': 200 psf
 Phi': 40 °
 Phi-Anisotropic Strength Fn.: Tmc100-25° (A-bed -1°-(-5°))
 C-Anisotropic Strength Fn.: 150psf-17° (A-bed -1°-(-5°))
 Phi-B: 0 °

Tmc100-25° (A-bed -1°-(-5°))

Model: Anisotropic Fn.
 Unit Weight: 120 pcf
 Cohesion': 200 psf
 Phi': 40 °
 Phi-Anisotropic Strength Fn.: Tmc100-25° (A-bed -1°-(-5°))
 C-Anisotropic Strength Fn.: 100psf-25° (A-bed -1°-(-5°))
 Phi-B: 0 °

Slip Surface Limits

Left Coordinate: (-200, 1,773) ft

file:///G:/SLOPE%20RESULTS/Section%2022-22%20results/Latest%20update%203-25-2... 3/25/2016

Right Coordinate: (812, 1,751) ft

Slip Surface Block

Left Grid

Upper Left: (422.5932, 1,659.817) ft
 Lower Left: (429.7437, 1,606.3915) ft
 Lower Right: (500.0051, 1,637.9872) ft
 X Increments: 10
 Y Increments: 10
 Starting Angle: 135 °
 Ending Angle: 180 °
 Angle Increments: 2

Right Grid

Upper Left: (538.0094, 1,708.4308) ft
 Lower Left: (548.9525, 1,620.2038) ft
 Lower Right: (641.0569, 1,671.1037) ft
 X Increments: 10
 Y Increments: 10
 Starting Angle: 45 °
 Ending Angle: 65 °
 Angle Increments: 2

Seismic Coefficients

Horz Seismic Coef.: 0.15
 Vert Seismic Coef.: 0

Anisotropic Strength Functions

TQs 100-25° (A-bed 10°-18°)

Model: Spline Data Point Function
 Function: Modifier Factor vs. Inclination
 Curve Fit to Data: 100 %
 Segment Curvature: 0 %

Y-Intercept: 1

Data Points: Inclination (°), Modifier Factor
 Data Point: (-90, 1)
 Data Point: (9.9, 1)
 Data Point: (10, 0.625)
 Data Point: (18, 0.625)
 Data Point: (18.1, 1)

Tmc100-25° (A-bed -1°-(-5°))

Model: Spline Data Point Function
 Function: Modifier Factor vs. Inclination
 Curve Fit to Data: 100 %
 Segment Curvature: 0 %

Y-Intercept: 1

Data Points: Inclination (°), Modifier Factor
 Data Point: (-90, 1)
 Data Point: (-5.1, 1)
 Data Point: (-5, 0.625)
 Data Point: (-1, 0.625)
 Data Point: (-0.9, 1)

TQs 100-25° (A-bed 2°-10°)

Model: Spline Data Point Function
 Function: Modifier Factor vs. Inclination
 Curve Fit to Data: 100 %
 Segment Curvature: 0 %

Y-Intercept: 1

Data Points: Inclination (°), Modifier Factor
 Data Point: (-90, 1)
 Data Point: (1.9, 1)
 Data Point: (2, 0.625)
 Data Point: (10, 0.625)
 Data Point: (10.1, 1)

150pcf (Along Bedding 8°-20°)

Model: Spline Data Point Function
 Function: Modifier Factor vs. Inclination
 Curve Fit to Data: 100 %
 Segment Curvature: 0 %

Y-Intercept: 1

Data Points: Inclination (°), Modifier Factor
 Data Point: (-90, 1)
 Data Point: (7.9, 1)
 Data Point: (8, 0.667)
 Data Point: (20, 0.667)
 Data Point: (20.1, 1)

150psf-17° (A-bed -1°-(-5°))

Model: Spline Data Point Function
 Function: Modifier Factor vs. Inclination
 Curve Fit to Data: 100 %
 Segment Curvature: 0 %

Y-Intercept: 1

Data Points: Inclination (°), Modifier Factor
 Data Point: (-90, 1)
 Data Point: (-5.1, 1)
 Data Point: (-5, 0.75)
 Data Point: (-1, 0.75)
 Data Point: (-0.9, 1)

100psf-25° (A-bed 10°-18°)

Model: Spline Data Point Function
 Function: Modifier Factor vs. Inclination

Curve Fit to Data: 100 %
Segment Curvature: 0 %

Y-Intercept: 1

Data Points: Inclination (°), Modifier Factor

- Data Point: (-90, 1)
- Data Point: (9.9, 1)
- Data Point: (10, 0.444)
- Data Point: (18, 0.444)
- Data Point: (18.1, 1)

100psf-25° (A-bed -1°(-5°))

Model: Spline Data Point Function

Function: Modifier Factor vs. Inclination

Curve Fit to Data: 100 %
Segment Curvature: 0 %

Y-Intercept: 1

Data Points: Inclination (°), Modifier Factor

- Data Point: (-90, 1)
- Data Point: (-5.1, 1)
- Data Point: (-5, 0.5)
- Data Point: (-1, 0.5)
- Data Point: (-0.9, 1)

Points

	X (ft)	Y (ft)
Point 1	-200	1,665.0405
Point 2	-200	1,773
Point 3	-181	1,782
Point 4	-161	1,788
Point 5	-128	1,769
Point 6	-115	1,769
Point 7	-56	1,730
Point 8	-36	1,730
Point 9	21	1,709
Point 10	31	1,709
Point 11	83	1,685
Point 12	96	1,679
Point 13	114	1,679
Point 14	166	1,655
Point 15	176	1,655
Point 16	235	1,626
Point 17	332	1,626
Point 18	367	1,649
Point 19	443	1,648
Point 20	523	1,678
Point 21	566	1,702

Point 22	592	1,702
Point 23	639	1,726
Point 24	661	1,726
Point 25	731	1,728
Point 26	812	1,733
Point 27	812	1,500
Point 28	-200	1,500
Point 29	703	1,749
Point 30	768	1,750
Point 31	812	1,751
Point 32	542	1,688.6047
Point 33	812	1,701

Regions

	Material	Points	Area (ft²)
Region 1	TQs 100-25° (A-bed 10° -18°)	1,2,3,4,5,6,7,8,9,10,11	18,295
Region 2	TQs 100-25° (A-bed 2° -10°)	24,29,30,31,26,25	2,654
Region 3	Tmc100-25° (A-bed -1° (-5°))	32,33,26,25,24,23,22,21	6,933.1
Region 4	Tmc150-17° (A-bed -1° (-5°))	1,28,27,33,32,20,19,18,17,16,15,14,13,12,11	1.7108e+005

Current Slip Surface

Slip Surface: 92,368

F of S: 1.41

Volume: 1,180.4526 ft³

Weight: 141,654.31 lbs

Resisting Force: 83,280.304 lbs

Activating Force: 59,030.339 lbs

F of S Rank (Analysis): 1 of 131,769 slip surfaces

F of S Rank (Query): 1 of 300 slip surfaces

Exit: (489.78392, 1,665.544) ft
 Entry: (581.16365, 1,702) ft
 Radius: 54.17577 ft
 Center: (524.56566, 1,711.114) ft

Slip Slices

	X (ft)	Y (ft)	PWP (psf)	Base Normal Stress (psf)	Frictional Strength (psf)	Cohesive Strength (psf)
Slice 1	491.29374	1,665.5095	0	75.068306	35.004926	150
Slice 2	494.31339	1,665.4405	0	220.32381	102.73868	150
Slice 3	497.33303	1,665.3715	0	365.57932	170.47244	150
Slice 4	500.35267	1,665.3025	0	510.83482	238.20619	150
Slice 5	503.37232	1,665.2336	0	656.09033	305.93995	150
Slice 6	506.39196	1,665.1646	0	801.34584	373.6737	150
Slice 7	509.4116	1,665.0956	0	946.60134	441.40745	150
Slice 8	512.43125	1,665.0266	0	1,091.8568	509.14121	150
Slice 9	515.45089	1,664.9576	0	1,237.1124	576.87496	150
Slice 10	518.47053	1,664.8886	0	1,382.3679	644.60872	150
Slice 11	521.49018	1,664.8197	0	1,527.6234	712.34247	150
Slice 12	524.58333	1,664.749	0	1,711.476	798.07438	150
Slice 13	527.75	1,664.6767	0	1,933.9259	901.80445	150
Slice 14	530.91667	1,664.6043	0	2,156.3757	1,005.5345	150
Slice 15	534.08333	1,664.532	0	2,378.8256	1,109.2646	150
Slice 16	537.25	1,664.4596	0	2,601.2754	1,212.9947	150
Slice 17	540.41667	1,664.3873	0	2,823.7253	1,316.7247	150
Slice 18	542.74047	1,664.3342	0	2,986.9662	1,392.8452	150
Slice 19	545.08945	1,665.9258	0	1,749.3954	1,467.917	200
Slice 20	548.30646	1,669.1428	0	1,642.325	1,378.0743	200

Slice 21	551.52347	1,672.3598	0	1,535.2547	1,288.2317	200
Slice 22	554.74047	1,675.5768	0	1,428.1844	1,198.389	200
Slice 23	557.95748	1,678.7938	0	1,321.1141	1,108.5464	200
Slice 24	561.17449	1,682.0108	0	1,214.0438	1,018.7037	200
Slice 25	564.3915	1,685.2278	0	1,106.9735	928.86108	200
Slice 26	567.50413	1,688.3405	0	940.14223	788.873	200
Slice 27	570.52768	1,691.364	0	712.39793	597.77284	200
Slice 28	573.56653	1,694.4029	0	483.50161	405.70602	200
Slice 29	576.60538	1,697.4417	0	254.6053	213.63921	200
Slice 30	579.64423	1,700.4806	0	25.708978	21.572394	200

Section 23 SSA for Skyline Ranch.gsz

Section 23 SSA for Skyline Ranch.gsz Run By: Dr. Alexander Bykovtsev, Ph.D., P.E. 3/22/2016 1:17:24 PM

Name: TQs 25° A-Bed 6-8°
 Model: Anisotropic Fn.
 Unit Weight: 120 pcf
 Cohesion: 225 psf
 Phi: 40°
 Phi-Anisotropic Strength Fn.: TQs 25° (A-Bed 6°-8°)
 C-Anisotropic Strength Fn.: TQs 100 psf (Along Bedding 6°-8°)

Name: Tmc 25° A-bed 8-17°
 Model: Anisotropic Fn.
 Unit Weight: 120 pcf
 Cohesion: 200 psf
 Phi: 40°
 Phi-Anisotropic Strength Fn.: Tmc 25° (Along Bedding 8°-17°)
 C-Anisotropic Strength Fn.: Tmc 100 psf (A-Bed 8°-17°)

Name: Fill
 Model: Mohr-Coulomb
 Unit Weight: 120 pcf
 Cohesion: 200 psf
 Phi: 33°

Name: Tmc 17° A-Bed 8-17°
 Model: Anisotropic Fn.
 Unit Weight: 120 pcf
 Cohesion: 200 psf
 Phi: 40°
 Phi-Anisotropic Strength Fn.: Tmc 17° (Along Bedding 8°-17°)
 C-Anisotropic Strength Fn.: Tmc 150 psf (A-Bed 8°-17°)

Materials

- TQs 25° A-Bed 6-8°
- Tmc 25° A-bed 8-17°
- Fill
- Tmc 17° A-Bed 8-17°

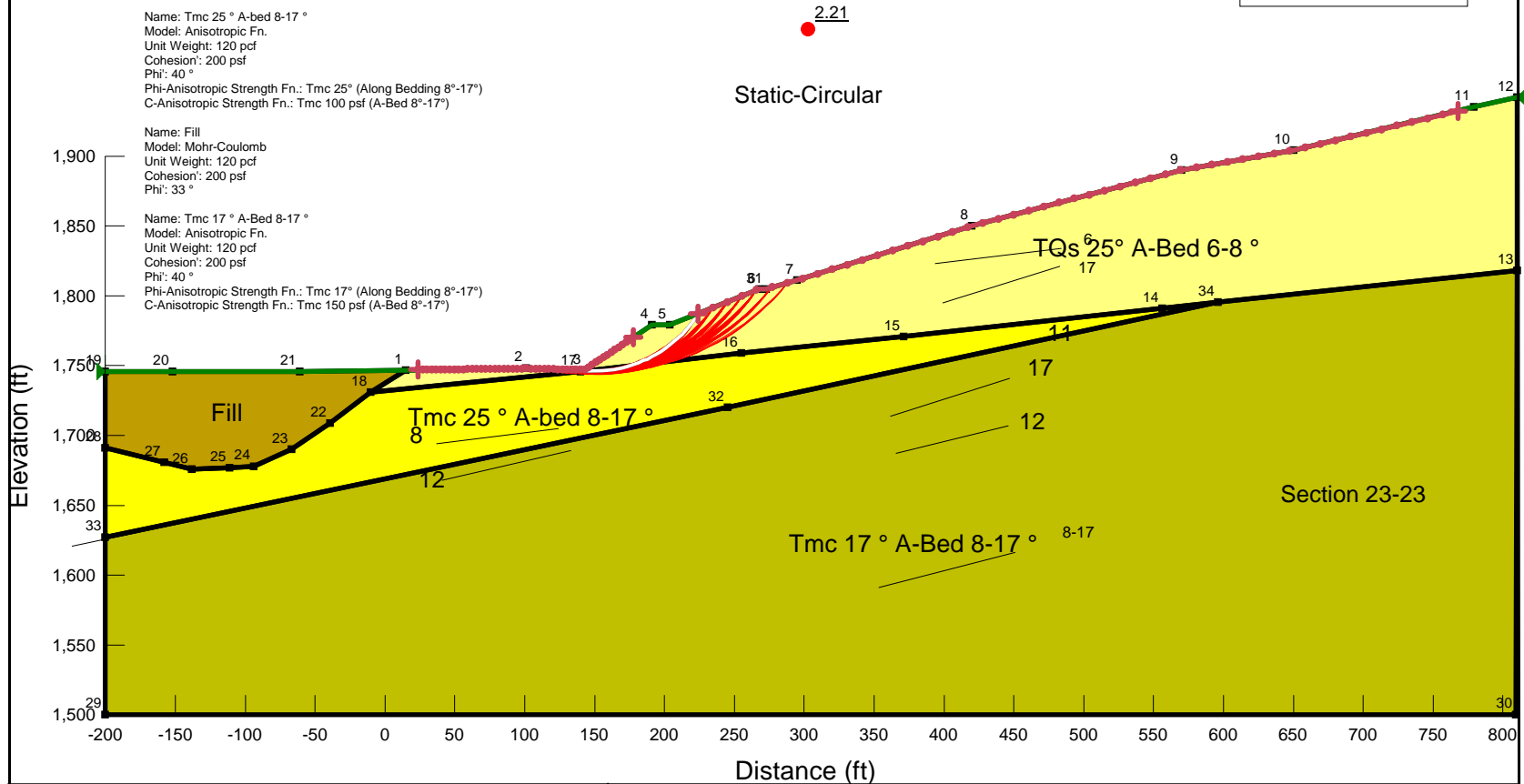

	<p>LGC Valley, Inc GEOTECHNICAL CONSULTING 28532 Constellation Road, Valencia, CA 91355 Phone 661-702-8474, Fax 661-702-8475</p>	<p>Skyline Ranch Development project, Tract 60922 Los Angeles CA</p>	<p>Project No: 153035-01 Engineer: BAS Date: March 2016</p>
--	--	---	--

1 - Circular Mode of Failure

Report generated using GeoStudio 2012. Copyright © 1991-2016 GEO-SLOPE International Ltd.

File Information

File Version: 8.15
 Title: *Static Slope Stability Analyses for Skyline Ranch Development project, Tract 60922, Los Angeles CA*
 Comments: Run By: Dr. Alexander Bykovtsev, Ph.D., P.E.
 Last Edited By: Alexander Bykovtsec
 Revision Number: 143
 Date: 3/22/2016
 Time: 1:17:24 PM
 Tool Version: 8.15.5.11777
 File Name: Section 23 SSA for Skyline Ranch.gsz
 Directory: P:\FINAL PROJECTS\PARDEE\Skyline Ranch\SLOPE RESULTS\Section 23-23 results\Latest Update 3-22-16\
 Last Solved Date: 3/22/2016
 Last Solved Time: 1:17:58 PM

Project Settings

Length(L) Units: Feet
 Time(t) Units: Seconds
 Force(F) Units: Pounds
 Pressure(p) Units: psf
 Strength Units: psf
 Unit Weight of Water: 62.4 pcf
 View: 2D
 Element Thickness: 1

Analysis Settings

1 - Circular Mode of Failure

Kind: SLOPE/W
 Method: Bishop
 Settings
 PWP Conditions Source: (none)
 Slip Surface
 Direction of movement: Right to Left
 Use Passive Mode: No
 Slip Surface Option: Entry and Exit
 Critical slip surfaces saved: 1
 Resisting Side Maximum Convex Angle: 1 °
 Driving Side Maximum Convex Angle: 5 °
 Optimize Critical Slip Surface Location: No
 Tension Crack
 Tension Crack Option: (none)

file:///P:/FINAL%20PROJECTS/PARDEE/Skyline%20Ranch/SLOPE%20RESULTS/Sect... 3/22/2016

F of S Distribution
 F of S Calculation Option: Constant
 Advanced
 Number of Slices: 30
 F of S Tolerance: 0.01
 Minimum Slip Surface Depth: 0.1 ft

Materials

TQs 25° A-Bed 6-8 °

Model: Anisotropic Fn.
 Unit Weight: 120 pcf
 Cohesion': 225 psf
 Phi': 40 °
 Phi-Anisotropic Strength Fn.: TQs 25° (A-Bed 6°-8°)
 C-Anisotropic Strength Fn.: TQs 100 psf (Along Bedding 6°-8°)
 Phi-B: 0 °

Tmc 25 ° A-bed 8-17 °

Model: Anisotropic Fn.
 Unit Weight: 120 pcf
 Cohesion': 200 psf
 Phi': 40 °
 Phi-Anisotropic Strength Fn.: Tmc 25° (Along Bedding 8°-17°)
 C-Anisotropic Strength Fn.: Tmc 100 psf (A-Bed 8°-17°)
 Phi-B: 0 °

Fill

Model: Mohr-Coulomb
 Unit Weight: 120 pcf
 Cohesion': 200 psf
 Phi': 33 °
 Phi-B: 0 °

Tmc 17 ° A-Bed 8-17 °

Model: Anisotropic Fn.
 Unit Weight: 120 pcf
 Cohesion': 200 psf
 Phi': 40 °
 Phi-Anisotropic Strength Fn.: Tmc 17° (Along Bedding 8°-17°)
 C-Anisotropic Strength Fn.: Tmc 150 psf (A-Bed 8°-17°)
 Phi-B: 0 °

Slip Surface Entry and Exit

Left Projection: Range
 Left-Zone Left Coordinate: (23.826, 1,747.1026) ft
 Left-Zone Right Coordinate: (178, 1,770.3333) ft
 Left-Zone Increment: 50

file:///P:/FINAL%20PROJECTS/PARDEE/Skyline%20Ranch/SLOPE%20RESULTS/Sect... 3/22/2016

Right Projection: Range
Right-Zone Left Coordinate: (224.2214, 1,787.2149) ft
Right-Zone Right Coordinate: (768, 1,932.3566) ft
Right-Zone Increment: 50
Radius Increments: 50

Slip Surface Limits

Left Coordinate: (-200, 1,746) ft
Right Coordinate: (810, 1,942) ft

Seismic Coefficients

Horz Seismic Coef.: 0
Vert Seismic Coef.: 0

Anisotropic Strength Functions

TQs 25° (A-Bed 6°-8°)

Model: Spline Data Point Function
Function: Modifier Factor vs. Inclination
Curve Fit to Data: 100 %
Segment Curvature: 0 %
Y-Intercept: 1
Data Points: Inclination (°), Modifier Factor
Data Point: (-90, 1)
Data Point: (5.9, 1)
Data Point: (6, 0.625)
Data Point: (8, 0.625)
Data Point: (8.1, 1)

TQs 100 psf (Along Bedding 6°-8°)

Model: Spline Data Point Function
Function: Modifier Factor vs. Inclination
Curve Fit to Data: 100 %
Segment Curvature: 0 %
Y-Intercept: 1
Data Points: Inclination (°), Modifier Factor
Data Point: (-90, 1)
Data Point: (5.9, 1)
Data Point: (6, 0.444)
Data Point: (8, 0.444)
Data Point: (8.1, 1)

Tmc 17° (Along Bedding 8°-17°)

Model: Spline Data Point Function
Function: Modifier Factor vs. Inclination
Curve Fit to Data: 100 %

Segment Curvature: 0 %
Y-Intercept: 1
Data Points: Inclination (°), Modifier Factor
Data Point: (-90, 1)
Data Point: (7.9, 1)
Data Point: (8, 0.425)
Data Point: (17, 0.425)
Data Point: (17.1, 1)

Tmc 150 psf (A-Bed 8°-17°)

Model: Spline Data Point Function
Function: Modifier Factor vs. Inclination
Curve Fit to Data: 100 %
Segment Curvature: 0 %
Y-Intercept: 1
Data Points: Inclination (°), Modifier Factor
Data Point: (-90, 1)
Data Point: (7.9, 1)
Data Point: (8, 0.75)
Data Point: (17, 0.75)
Data Point: (17.1, 1)

Tmc 25° (Along Bedding 8°-17°)

Model: Spline Data Point Function
Function: Modifier Factor vs. Inclination
Curve Fit to Data: 100 %
Segment Curvature: 0 %
Y-Intercept: 1
Data Points: Inclination (°), Modifier Factor
Data Point: (-90, 1)
Data Point: (7.9, 1)
Data Point: (8, 0.625)
Data Point: (17, 0.625)
Data Point: (17.1, 1)

Tmc 100 psf (A-Bed 8°-17°)

Model: Spline Data Point Function
Function: Modifier Factor vs. Inclination
Curve Fit to Data: 100 %
Segment Curvature: 0 %
Y-Intercept: 1
Data Points: Inclination (°), Modifier Factor
Data Point: (-90, 1)
Data Point: (7.9, 1)
Data Point: (8, 0.5)
Data Point: (17, 0.5)
Data Point: (17.1, 1)

Points



	X (ft)	Y (ft)
Point 1	15	1,747
Point 2	101	1,748
Point 3	143	1,747
Point 4	191	1,779
Point 5	204	1,779
Point 6	268	1,805
Point 7	295	1,811
Point 8	420	1,850
Point 9	570	1,890
Point 10	650	1,904
Point 11	779	1,935
Point 12	810	1,942
Point 13	810	1,818
Point 14	556	1,791
Point 15	371	1,770.9335
Point 16	255	1,759
Point 17	140	1,746
Point 18	-10	1,731
Point 19	-200	1,746
Point 20	-152	1,746
Point 21	-61	1,746
Point 22	-39	1,709
Point 23	-67	1,690
Point 24	-94	1,678
Point 25	-111	1,677
Point 26	-138	1,676
Point 27	-158	1,681
Point 28	-200	1,691
Point 29	-200	1,500
Point 30	809	1,500
Point 31	273	1,805
Point 32	245	1,720
Point 33	-200	1,627
Point 34	596	1,795.252

Regions

	Material	Points	Area (ft ²)
Region 1	TQs 25° A-Bed 6-8 °	1,2,3,4,5,6,31,7,8,9,10,11,12,13,34,14,15,16,17,18	52,306
Region 2	Fill	19,20,21,1,18,22,23,24,25,26,27,28	10,854
Region 3	Tmc 17° A-Bed 8-17 °	29,30,13,34,32,33	2.3309e+005
Region 4	Tmc 25° A-bed 8-17 °	28,33,32,34,14,15,16,17,18,22,23,24,25,26,27	27,717

Current Slip Surface

Slip Surface: 91,059
 F of S: 2.21
 Volume: 1,083.1046 ft³
 Weight: 129,972.55 lbs
 Resisting Moment: 9,943,306.7 lbs-ft
 Activating Moment: 4,508,734.5 lbs-ft
 F of S Rank (Analysis): 1 of 132,651 slip surfaces
 F of S Rank (Query): 1 of 150 slip surfaces
 Exit: (136.68977, 1,747.1502) ft
 Entry: (224.22138, 1,787.2149) ft
 Radius: 87.952048 ft
 Center: (149.81863, 1,834.1169) ft

Slip Slices

	X (ft)	Y (ft)	PWP (psf)	Base Normal Stress (psf)	Frictional Strength (psf)	Cohesive Strength (psf)
Slice 1	138.26733	1,746.9412	0	35.879375	30.106371	225
Slice 2	141.42244	1,746.5809	0	67.015711	56.232858	225
Slice 3	143.2404	1,746.4115	0	100.34905	84.202853	225
Slice 4	144.93983	1,746.3124	0	247.96103	208.064	200
Slice 5	147.85788	1,746.1988	0	490.95238	411.95796	200
Slice 6	150.77593	1,746.1821	0	716.26935	601.02134	200
Slice 7	153.69399	1,746.2624	0	924.54681	775.78689	200
Slice 8	156.61204	1,746.4398	0	1,116.3169	936.7011	200
Slice 9	159.53009	1,746.715	0	1,292.0201	1,084.1335	200
Slice 10	162.44815	1,747.0888	0	1,492.8914	696.14667	100
Slice 11	165.3662	1,747.5626	0	1,651.0438	769.89436	100
Slice 12	168.28425	1,748.1381	0	1,795.0676	837.05377	100
Slice 13	171.20231	1,748.8172	0	1,924.91	897.60026	100
Slice 14	174.12036	1,749.6025	0	2,040.46	951.48211	100
Slice	177.12145	1,750.5257	0	2,022.4419	1,697.0303	225

15						
Slice 16	180.20557	1,751.5972	0	2,094.3253	1,757.3476	225
Slice 17	183.28969	1,752.7998	0	2,149.2376	1,803.4245	225
Slice 18	186.37382	1,754.1393	0	2,186.935	1,835.0563	225
Slice 19	189.45794	1,755.6229	0	2,207.0754	1,851.9561	225
Slice 20	192.625	1,757.3073	0	2,101.4893	1,763.3589	225
Slice 21	195.875	1,759.212	0	1,874.1925	1,572.6342	225
Slice 22	199.125	1,761.3117	0	1,633.4157	1,370.5986	225
Slice 23	202.375	1,763.6237	0	1,378.7482	1,156.9071	225
Slice 24	205.44438	1,766.015	0	1,179.4645	989.68827	225
Slice 25	208.33315	1,768.4825	0	1,032.7814	866.60651	225
Slice 26	211.22192	1,771.1794	0	869.08801	729.25143	225
Slice 27	214.11069	1,774.1368	0	687.4133	576.80825	225
Slice 28	216.99946	1,777.3958	0	486.64944	408.34737	225
Slice 29	219.88823	1,781.0123	0	265.57241	222.84171	225
Slice 30	222.777	1,785.0665	0	22.934549	19.244372	225

Section 23 SSA for Skyline Ranch.gsz

Section 23 SSA for Skyline Ranch.gsz Run By: Dr. Alexander Bykovtsev, Ph.D., P.E. 3/22/2016 1:17:24 PM

Seismic - Circular

Materials	
	TQs 25° A-Bed 6-8 °
	Tmc 25 ° A-bed 8-17 °
	Fill
	Tmc 17 ° A-Bed 8-17 °

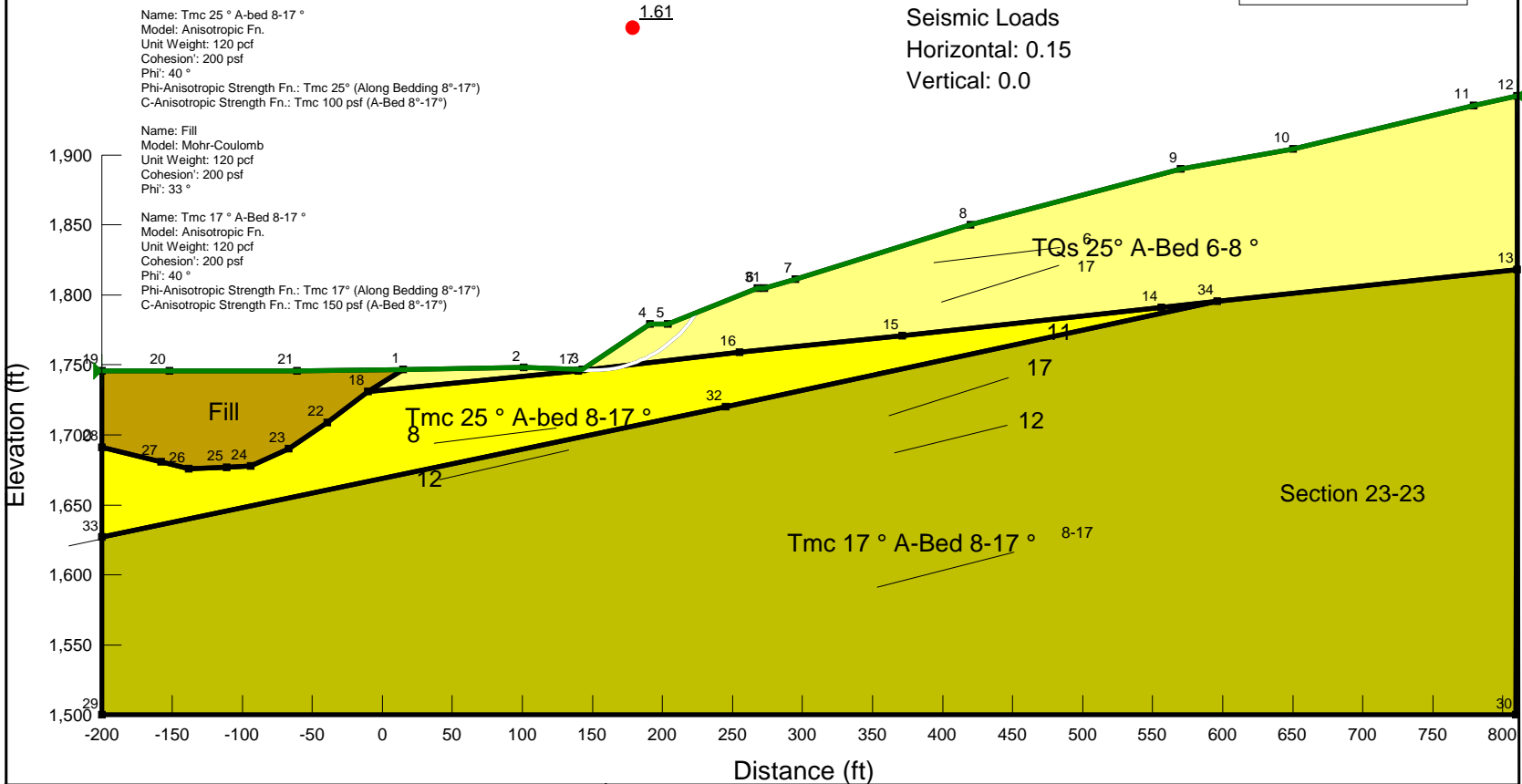

LGC **LGC Valley, Inc**
 GEOTECHNICAL CONSULTING
 28532 Constellation Road, Valencia, CA 91355
 Phone 661-702-8474, Fax 661-702-8475

Skyline Ranch
 Development project, Tract 60922
 Los Angeles CA

Project No: **153035-01**
 Engineer: **BAS**
 Date: **March 2016**

1 - Circular Mode of Failure Seismic

Report generated using GeoStudio 2012. Copyright © 1991-2016 GEO-SLOPE International Ltd.

File Information

File Version: 8.15
 Title: Static Slope Stability Analyses for Skyline Ranch Development project, Tract 60922, Los Angeles CA
 Comments: Run By: Dr. Alexander Bykovtsev, Ph.D., P.E.
 Last Edited By: Alexander Bykovtsev
 Revision Number: 143
 Date: 3/22/2016
 Time: 1:17:24 PM
 Tool Version: 8.15.5.11777
 File Name: Section 23 SSA for Skyline Ranch.gsz
 Directory: P:\FINAL PROJECTS\PARDEE\Skyline Ranch\SLOPE RESULTS\Section 23-23 results\Latest Update 3-22-16\
 Last Solved Date: 3/22/2016
 Last Solved Time: 1:18:00 PM

Project Settings

Length(L) Units: Feet
 Time(t) Units: Seconds
 Force(F) Units: Pounds
 Pressure(p) Units: psf
 Strength Units: psf
 Unit Weight of Water: 62.4 pcf
 View: 2D
 Element Thickness: 1

Analysis Settings

1 - Circular Mode of Failure Seismic

Kind: SLOPE/W
 Parent: 1 - Circular Mode of Failure
 Method: Bishop
 Settings
 PWP Conditions Source: (none)
 Initial Slip Surface Source: Parent Analysis
 Slip Surface
 Direction of movement: Right to Left
 Use Passive Mode: No
 Slip Surface Option: Critical Slip Surfaces from Other
 Critical slip surfaces saved: 1
 Resisting Side Maximum Convex Angle: 1 °
 Driving Side Maximum Convex Angle: 5 °
 Optimize Critical Slip Surface Location: No

file:///P:/FINAL%20PROJECTS/PARDEE/Skyline%20Ranch/SLOPE%20RESULTS/Sect... 3/22/2016

Tension Crack
 Tension Crack Option: (none)
 F of S Distribution
 F of S Calculation Option: Constant
 Advanced
 Number of Slices: 30
 F of S Tolerance: 0.01
 Minimum Slip Surface Depth: 0.1 ft

Materials

TQs 25° A-Bed 6-8 °

Model: Anisotropic Fn.
 Unit Weight: 120 pcf
 Cohesion': 225 psf
 Phi': 40 °
 Phi-Anisotropic Strength Fn.: TQs 25° (A-Bed 6°-8°)
 C-Anisotropic Strength Fn.: TQs 100 psf (Along Bedding 6°-8°)
 Phi-B: 0 °

Tmc 25 ° A-bed 8-17 °

Model: Anisotropic Fn.
 Unit Weight: 120 pcf
 Cohesion': 200 psf
 Phi': 40 °
 Phi-Anisotropic Strength Fn.: Tmc 25° (Along Bedding 8°-17°)
 C-Anisotropic Strength Fn.: Tmc 100 psf (A-Bed 8°-17°)
 Phi-B: 0 °

Fill

Model: Mohr-Coulomb
 Unit Weight: 120 pcf
 Cohesion': 200 psf
 Phi': 33 °
 Phi-B: 0 °

Tmc 17 ° A-Bed 8-17 °

Model: Anisotropic Fn.
 Unit Weight: 120 pcf
 Cohesion': 200 psf
 Phi': 40 °
 Phi-Anisotropic Strength Fn.: Tmc 17° (Along Bedding 8°-17°)
 C-Anisotropic Strength Fn.: Tmc 150 psf (A-Bed 8°-17°)
 Phi-B: 0 °

Slip Surface Limits

Left Coordinate: (-200, 1,746) ft
 Right Coordinate: (810, 1,942) ft

file:///P:/FINAL%20PROJECTS/PARDEE/Skyline%20Ranch/SLOPE%20RESULTS/Sect... 3/22/2016

Seismic Coefficients

Horz Seismic Coef.: 0.15
 Vert Seismic Coef.: 0

Anisotropic Strength Functions

TQs 25° (A-Bed 6°-8°)

Model: Spline Data Point Function
 Function: Modifier Factor vs. Inclination
 Curve Fit to Data: 100 %
 Segment Curvature: 0 %
 Y-Intercept: 1
 Data Points: Inclination (°), Modifier Factor
 Data Point: (-90, 1)
 Data Point: (5.9, 1)
 Data Point: (6, 0.625)
 Data Point: (8, 0.625)
 Data Point: (8.1, 1)

TQs 100 psf (Along Bedding 6°-8°)

Model: Spline Data Point Function
 Function: Modifier Factor vs. Inclination
 Curve Fit to Data: 100 %
 Segment Curvature: 0 %
 Y-Intercept: 1
 Data Points: Inclination (°), Modifier Factor
 Data Point: (-90, 1)
 Data Point: (5.9, 1)
 Data Point: (6, 0.444)
 Data Point: (8, 0.444)
 Data Point: (8.1, 1)

Tmc 17° (Along Bedding 8°-17°)

Model: Spline Data Point Function
 Function: Modifier Factor vs. Inclination
 Curve Fit to Data: 100 %
 Segment Curvature: 0 %
 Y-Intercept: 1
 Data Points: Inclination (°), Modifier Factor
 Data Point: (-90, 1)
 Data Point: (7.9, 1)
 Data Point: (8, 0.425)
 Data Point: (17, 0.425)
 Data Point: (17.1, 1)

Tmc 150 psf (A-Bed 8°-17°)

Model: Spline Data Point Function

Function: Modifier Factor vs. Inclination
 Curve Fit to Data: 100 %
 Segment Curvature: 0 %

Y-Intercept: 1
 Data Points: Inclination (°), Modifier Factor
 Data Point: (-90, 1)
 Data Point: (7.9, 1)
 Data Point: (8, 0.75)
 Data Point: (17, 0.75)
 Data Point: (17.1, 1)

Tmc 25° (Along Bedding 8°-17°)

Model: Spline Data Point Function
 Function: Modifier Factor vs. Inclination
 Curve Fit to Data: 100 %
 Segment Curvature: 0 %
 Y-Intercept: 1
 Data Points: Inclination (°), Modifier Factor
 Data Point: (-90, 1)
 Data Point: (7.9, 1)
 Data Point: (8, 0.625)
 Data Point: (17, 0.625)
 Data Point: (17.1, 1)

Tmc 100 psf (A-Bed 8°-17°)

Model: Spline Data Point Function
 Function: Modifier Factor vs. Inclination
 Curve Fit to Data: 100 %
 Segment Curvature: 0 %
 Y-Intercept: 1
 Data Points: Inclination (°), Modifier Factor
 Data Point: (-90, 1)
 Data Point: (7.9, 1)
 Data Point: (8, 0.5)
 Data Point: (17, 0.5)
 Data Point: (17.1, 1)

Points

	X (ft)	Y (ft)
Point 1	15	1,747
Point 2	101	1,748
Point 3	143	1,747
Point 4	191	1,779
Point 5	204	1,779
Point 6	268	1,805
Point 7	295	1,811
Point 8	420	1,850

Point 9	570	1,890
Point 10	650	1,904
Point 11	779	1,935
Point 12	810	1,942
Point 13	810	1,818
Point 14	556	1,791
Point 15	371	1,770.9335
Point 16	255	1,759
Point 17	140	1,746
Point 18	-10	1,731
Point 19	-200	1,746
Point 20	-152	1,746
Point 21	-61	1,746
Point 22	-39	1,709
Point 23	-67	1,690
Point 24	-94	1,678
Point 25	-111	1,677
Point 26	-138	1,676
Point 27	-158	1,681
Point 28	-200	1,691
Point 29	-200	1,500
Point 30	809	1,500
Point 31	273	1,805
Point 32	245	1,720
Point 33	-200	1,627
Point 34	596	1,795.252

Regions

	Material	Points	Area (ft ²)
Region 1	TQs 25° A-Bed 6-8 °	1,2,3,4,5,6,31,7,8,9,10,11,12,13,34,14,15,16,17,18	52,306
Region 2	Fill	19,20,21,1,18,22,23,24,25,26,27,28	10,854
Region 3	Tmc 17 ° A-Bed 8-17 °	29,30,13,34,32,33	2.3309e+005
Region 4	Tmc 25 ° A-bed 8-17 °	28,33,32,34,14,15,16,17,18,22,23,24,25,26,27	27,717

Current Slip Surface

Slip Surface: 1
 F of S: 1.61
 Volume: 1,083.1046 ft³
 Weight: 129,972.55 lbs
 Resisting Moment: 9,434,171.1 lbs-ft
 Activating Moment: 5,876,545.7 lbs-ft
 F of S Rank (Analysis): 1 of 1 slip surfaces
 F of S Rank (Query): 1 of 1 slip surfaces

Exit: (136.68977, 1,747.1502) ft
 Entry: (224.22138, 1,787.2149) ft
 Radius: 87.952048 ft
 Center: (149.81863, 1,834.1169) ft

Slip Slices

	X (ft)	Y (ft)	PWP (psf)	Base Normal Stress (psf)	Frictional Strength (psf)	Cohesive Strength (psf)
Slice 1	138.26733	1,746.9412	0	42.007126	35.248164	225
Slice 2	141.42244	1,746.5809	0	71.807421	60.253581	225
Slice 3	143.2404	1,746.4115	0	104.42197	87.620438	225
Slice 4	144.93983	1,746.3124	0	251.90147	211.37043	200
Slice 5	147.85788	1,746.1988	0	493.28254	413.91319	200
Slice 6	150.77593	1,746.1821	0	714.80618	599.79361	200
Slice 7	153.69399	1,746.2624	0	917.44647	769.829	200
Slice 8	156.61204	1,746.4398	0	1,102.0315	924.71419	200
Slice 9	159.53009	1,746.715	0	1,269.2606	1,065.0361	200
Slice 10	162.44815	1,747.0888	0	1,474.1811	687.42196	100
Slice 11	165.3662	1,747.5626	0	1,625.9798	758.20682	100
Slice 12	168.28425	1,748.1381	0	1,763.096	822.14516	100
Slice 13	171.20231	1,748.8172	0	1,885.5653	879.25354	100
Slice 14	174.12036	1,749.6025	0	1,993.3626	929.52026	100
Slice 15	177.12145	1,750.5257	0	1,931.9201	1,621.0734	225
Slice 16	180.20557	1,751.5972	0	1,990.9839	1,670.6339	225
Slice 17	183.28969	1,752.7998	0	2,033.24	1,706.0909	225
Slice 18	186.37382	1,754.1393	0	2,058.6223	1,727.3892	225
Slice 19	189.45794	1,755.6229	0	2,066.9723	1,734.3957	225
Slice 20	192.625	1,757.3073	0	1,956.5981	1,641.7807	225

Slice 21	195.875	1,759.212	0	1,732.9546	1,454.1216	225
Slice 22	199.125	1,761.3117	0	1,498.6536	1,257.5197	225
Slice 23	202.375	1,763.6237	0	1,253.5564	1,051.8587	225
Slice 24	205.44438	1,766.015	0	1,062.0467	891.163	225
Slice 25	208.33315	1,768.4825	0	920.67172	772.5353	225
Slice 26	211.22192	1,771.1794	0	764.95724	641.87534	225
Slice 27	214.11069	1,774.1368	0	594.37962	498.74372	225
Slice 28	216.99946	1,777.3958	0	408.39353	342.68286	225
Slice 29	219.88823	1,781.0123	0	206.49947	173.27363	225
Slice 30	222.777	1,785.0665	0	-11.59229	-9.7270859	225

Section 23 SSA for Skyline Ranch.gsz

Section 23 SSA for Skyline Ranch.gsz Run By: Dr. Alexander Bykovtsev, Ph.D., P.E. 3/22/2016 1:00:43 PM

Materials

- TQs 25° A-Bed 6-8 °
- Tmc 25 ° A-bed 8-17 °
- Fill
- Tmc 17 ° A-Bed 8-17 °

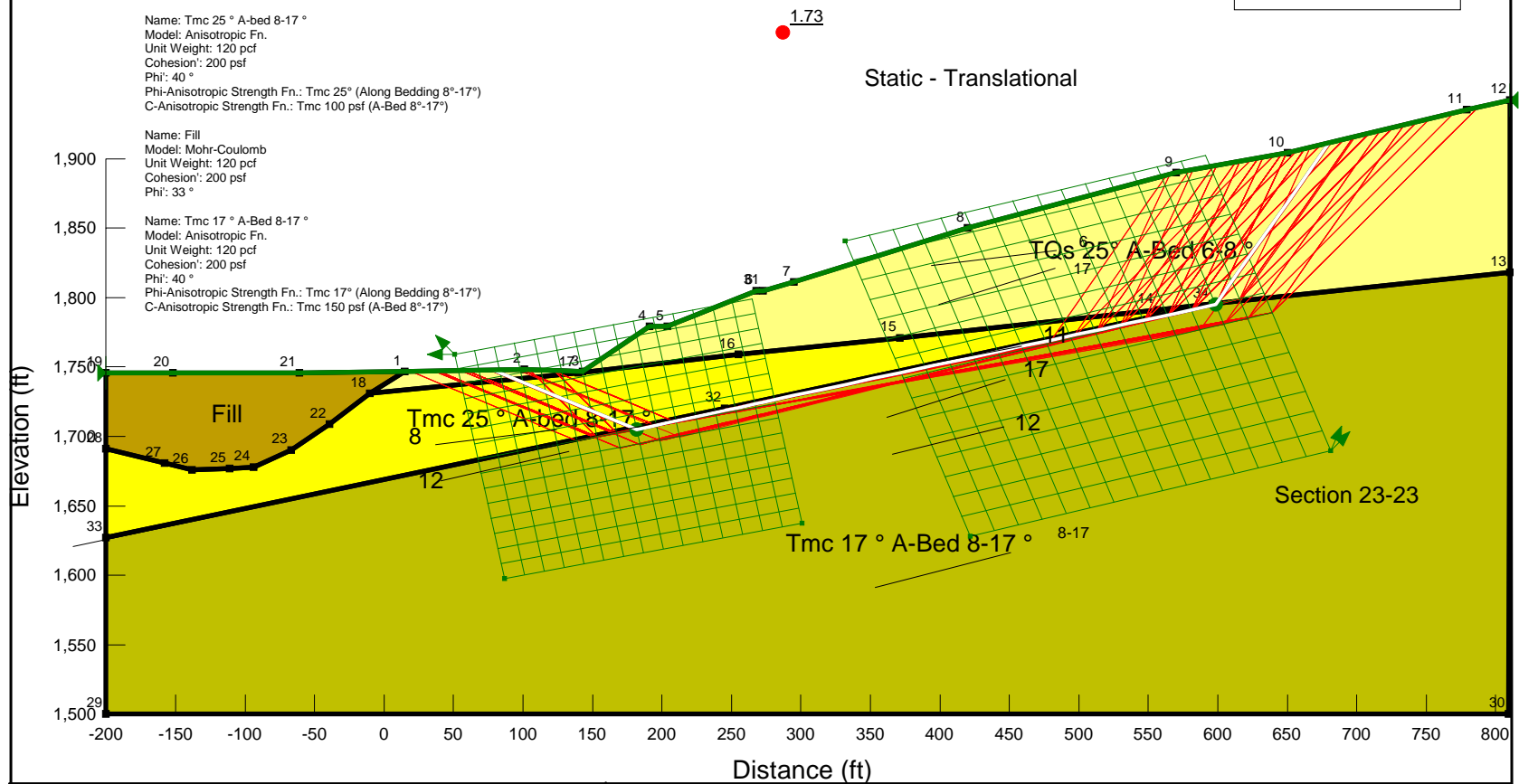

LGC **LGC Valley, Inc**
 GEOTECHNICAL CONSULTING
 28532 Constellation Road, Valencia, CA 91355
 Phone 661-702-8474, Fax 661-702-8475

Skyline Ranch
 Development project, Tract 60922
 Los Angeles CA

Project No: **153035-01**
 Engineer: **BAS**
 Date: **March 2016**

2 - Translational

Report generated using GeoStudio 2012. Copyright © 1991-2016 GEO-SLOPE International Ltd.

File Information

File Version: 8.15
 Title: Static Slope Stability Analyses for Skyline Ranch Development project, Tract 60922, Los Angeles CA
 Comments: Run By: Dr. Alexander Bykovtsev, Ph.D., P.E.
 Last Edited By: Alexander Bykovtsec
 Revision Number: 141
 Date: 3/22/2016
 Time: 1:00:43 PM
 Tool Version: 8.15.5.11777
 File Name: Section 23 SSA for Skyline Ranch.gsz
 Directory: P:\FINAL PROJECTS\PARDEE\Skyline Ranch\SLOPE RESULTS\Section 23-23 results\Latest Update 3-22-16\
 Last Solved Date: 3/22/2016
 Last Solved Time: 1:02:52 PM

Project Settings

Length(L) Units: Feet
 Time(t) Units: Seconds
 Force(F) Units: Pounds
 Pressure(p) Units: psf
 Strength Units: psf
 Unit Weight of Water: 62.4 pcf
 View: 2D
 Element Thickness: 1

Analysis Settings

2 - Translational

Kind: SLOPE/W
 Method: Janbu
 Settings
 PWP Conditions Source: (none)
 Slip Surface
 Direction of movement: Right to Left
 Use Passive Mode: No
 Slip Surface Option: Block
 Critical slip surfaces saved: 1
 Resisting Side Maximum Convex Angle: 1 °
 Driving Side Maximum Convex Angle: 5 °
 Restrict Block Crossing: No
 Optimize Critical Slip Surface Location: No
 Tension Crack

file:///P:/FINAL%20PROJECTS/PARDEE/Skyline%20Ranch/SLOPE%20RESULTS/Sect... 3/22/2016

Tension Crack Option: (none)
 F of S Distribution
 F of S Calculation Option: Constant
 Advanced
 Number of Slices: 30
 F of S Tolerance: 0.01
 Minimum Slip Surface Depth: 0.1 ft

Materials

TQs 25° A-Bed 6-8 °

Model: Anisotropic Fn.
 Unit Weight: 120 pcf
 Cohesion': 225 psf
 Phi': 40 °
 Phi-Anisotropic Strength Fn.: TQs 25° (A-Bed 6°-8°)
 C-Anisotropic Strength Fn.: TQs 100 psf (Along Bedding 6°-8°)
 Phi-B: 0 °

Tmc 25 ° A-bed 8-17 °

Model: Anisotropic Fn.
 Unit Weight: 120 pcf
 Cohesion': 200 psf
 Phi': 40 °
 Phi-Anisotropic Strength Fn.: Tmc 25° (Along Bedding 8°-17°)
 C-Anisotropic Strength Fn.: Tmc 100 psf (A-Bed 8°-17°)
 Phi-B: 0 °

Fill

Model: Mohr-Coulomb
 Unit Weight: 120 pcf
 Cohesion': 200 psf
 Phi': 33 °
 Phi-B: 0 °

Tmc 17 ° A-Bed 8-17 °

Model: Anisotropic Fn.
 Unit Weight: 120 pcf
 Cohesion': 200 psf
 Phi': 40 °
 Phi-Anisotropic Strength Fn.: Tmc 17° (Along Bedding 8°-17°)
 C-Anisotropic Strength Fn.: Tmc 150 psf (A-Bed 8°-17°)
 Phi-B: 0 °

Slip Surface Limits

Left Coordinate: (-200, 1,746) ft
 Right Coordinate: (810, 1,942) ft

file:///P:/FINAL%20PROJECTS/PARDEE/Skyline%20Ranch/SLOPE%20RESULTS/Sect... 3/22/2016

Slip Surface Block

Left Grid

Upper Left: (50.8505, 1,759.0368) ft
 Lower Left: (86.9521, 1,597.4756) ft
 Lower Right: (300.9825, 1,637.5428) ft
 X Increments: 15
 Y Increments: 15
 Starting Angle: 135 °
 Ending Angle: 180 °
 Angle Increments: 2

Right Grid

Upper Left: (331.9615, 1,840.5347) ft
 Lower Left: (422, 1,628) ft
 Lower Right: (681.0585, 1,689.7014) ft
 X Increments: 15
 Y Increments: 15
 Starting Angle: 45 °
 Ending Angle: 65 °
 Angle Increments: 2

Seismic Coefficients

Horz Seismic Coef.: 0
 Vert Seismic Coef.: 0

Anisotropic Strength Functions

TQs 25° (A-Bed 6°-8°)

Model: Spline Data Point Function
 Function: Modifier Factor vs. Inclination
 Curve Fit to Data: 100 %
 Segment Curvature: 0 %
 Y-Intercept: 1
 Data Points: Inclination (°), Modifier Factor
 Data Point: (-90, 1)
 Data Point: (5.9, 1)
 Data Point: (6, 0.625)
 Data Point: (8, 0.625)
 Data Point: (8.1, 1)

TQs 100 psf (Along Bedding 6°-8°)

Model: Spline Data Point Function
 Function: Modifier Factor vs. Inclination
 Curve Fit to Data: 100 %
 Segment Curvature: 0 %
 Y-Intercept: 1

Data Points: Inclination (°), Modifier Factor

Data Point: (-90, 1)
 Data Point: (5.9, 1)
 Data Point: (6, 0.444)
 Data Point: (8, 0.444)
 Data Point: (8.1, 1)

Tmc 17° (Along Bedding 8°-17°)

Model: Spline Data Point Function
 Function: Modifier Factor vs. Inclination
 Curve Fit to Data: 100 %
 Segment Curvature: 0 %

Y-Intercept: 1

Data Points: Inclination (°), Modifier Factor

Data Point: (-90, 1)
 Data Point: (7.9, 1)
 Data Point: (8, 0.425)
 Data Point: (17, 0.425)
 Data Point: (17.1, 1)

Tmc 150 psf (A-Bed 8°-17°)

Model: Spline Data Point Function
 Function: Modifier Factor vs. Inclination
 Curve Fit to Data: 100 %
 Segment Curvature: 0 %

Y-Intercept: 1

Data Points: Inclination (°), Modifier Factor

Data Point: (-90, 1)
 Data Point: (7.9, 1)
 Data Point: (8, 0.75)
 Data Point: (17, 0.75)
 Data Point: (17.1, 1)

Tmc 25° (Along Bedding 8°-17°)

Model: Spline Data Point Function
 Function: Modifier Factor vs. Inclination
 Curve Fit to Data: 100 %
 Segment Curvature: 0 %

Y-Intercept: 1

Data Points: Inclination (°), Modifier Factor

Data Point: (-90, 1)
 Data Point: (7.9, 1)
 Data Point: (8, 0.625)
 Data Point: (17, 0.625)
 Data Point: (17.1, 1)

Tmc 100 psf (A-Bed 8°-17°)

Model: Spline Data Point Function
 Function: Modifier Factor vs. Inclination
 Curve Fit to Data: 100 %

Segment Curvature: 0 %
 Y-Intercept: 1
 Data Points: Inclination (°), Modifier Factor
 Data Point: (-90, 1)
 Data Point: (7.9, 1)
 Data Point: (8, 0.5)
 Data Point: (17, 0.5)
 Data Point: (17.1, 1)

Points

	X (ft)	Y (ft)
Point 1	15	1,747
Point 2	101	1,748
Point 3	143	1,747
Point 4	191	1,779
Point 5	204	1,779
Point 6	268	1,805
Point 7	295	1,811
Point 8	420	1,850
Point 9	570	1,890
Point 10	650	1,904
Point 11	779	1,935
Point 12	810	1,942
Point 13	810	1,818
Point 14	556	1,791
Point 15	371	1,770.9335
Point 16	255	1,759
Point 17	140	1,746
Point 18	-10	1,731
Point 19	-200	1,746
Point 20	-152	1,746
Point 21	-61	1,746
Point 22	-39	1,709
Point 23	-67	1,690
Point 24	-94	1,678
Point 25	-111	1,677
Point 26	-138	1,676
Point 27	-158	1,681
Point 28	-200	1,691
Point 29	-200	1,500
Point 30	809	1,500
Point 31	273	1,805
Point 32	245	1,720
Point 33	-200	1,627

Point 34 | 596 | 1,795.252

Regions

	Material	Points	Area (ft²)
Region 1	TQs 25° A-Bed 6-8 °	1,2,3,4,5,6,31,7,8,9,10,11,12,13,34,14,15,16,17,18	52,306
Region 2	Fill	19,20,21,1,18,22,23,24,25,26,27,28	10,854
Region 3	Tmc 17 ° A-Bed 8-17 °	29,30,13,34,32,33	2.3309e+005
Region 4	Tmc 25 ° A-bed 8-17 °	28,33,32,34,14,15,16,17,18,22,23,24,25,26,27	27,717

Current Slip Surface

Slip Surface: 314,537
 F of S: 1.73
 Volume: 43,712.194 ft³
 Weight: 5,245,463.3 lbs
 Resisting Force: 1,981,755.5 lbs
 Activating Force: 1,147,535 lbs
 F of S Rank (Analysis): 1 of 589,824 slip surfaces
 F of S Rank (Query): 1 of 150 slip surfaces
 Exit: (78.688554, 1,747.7406) ft
 Entry: (679.98681, 1,911.2061) ft
 Radius: 293.37541 ft
 Center: (346.00856, 1,952.0725) ft

Slip Slices

	X (ft)	Y (ft)	PWP (psf)	Base Normal Stress (psf)	Frictional Strength (psf)	Cohesive Strength (psf)
Slice 1	86.342679	1,744.5701	0	556.60961	467.05092	225
Slice 2	97.498401	1,739.9493	0	1,262.2849	1,059.1828	200
Slice 3	110.75	1,734.4603	0	2,057.5531	1,726.4921	200
Slice 4	130.25	1,726.3831	0	3,200.3953	2,685.4505	200
Slice 5	141.5	1,721.7232	0	3,859.7272	3,238.6957	200
Slice 6	151.99337	1,717.3767	0	5,406.9132	4,536.9388	200
Slice 7	169.9801	1,709.9264	0	8,325.4632	6,985.8931	200
Slice 8	180.41046	1,705.606	0	10,017.907	8,406.0224	200
Slice 9	186.42373	1,705.9972	0	8,068.597	2,466.8177	150
Slice	197.5	1,708.3849	0	8,145.2612	2,490.2563	150

10						
Slice 11	214.25	1,711.9956	0	8,209.2266	2,509.8124	150
Slice 12	234.75	1,716.4148	0	8,661.116	2,647.9689	150
Slice 13	250	1,719.7022	0	8,997.2777	2,750.7438	150
Slice 14	261.5	1,722.1812	0	9,250.7767	2,828.2463	150
Slice 15	270.5	1,724.1213	0	9,331.7589	2,853.005	150
Slice 16	284	1,727.0314	0	9,342.146	2,856.1807	150
Slice 17	304.5	1,731.4505	0	9,520.738	2,910.7817	150
Slice 18	323.5	1,735.5463	0	9,732.5482	2,975.5386	150
Slice 19	342.5	1,739.642	0	9,944.3584	3,040.2955	150
Slice 20	361.5	1,743.7378	0	10,156.169	3,105.0523	150
Slice 21	383.25	1,748.4264	0	10,398.635	3,179.1819	150
Slice 22	407.75	1,753.7078	0	10,671.759	3,262.6842	150
Slice 23	429.71429	1,758.4425	0	10,865.706	3,321.9797	150
Slice 24	449.14286	1,762.6307	0	10,980.476	3,357.0684	150
Slice 25	468.57143	1,766.8188	0	11,095.246	3,392.1571	150
Slice 26	488	1,771.007	0	11,210.016	3,427.2458	150
Slice 27	507.42857	1,775.1951	0	11,324.786	3,462.3346	150
Slice 28	526.85714	1,779.3833	0	11,439.556	3,497.4233	150
Slice 29	546.28571	1,783.5714	0	11,554.326	3,532.512	150
Slice 30	563	1,787.1745	0	11,653.062	3,562.6986	150
Slice 31	583	1,791.4858	0	11,633.449	3,556.7022	150
Slice 32	597.24842	1,794.5573	0	11,566.63	3,536.2736	150
Slice 33	607.25495	1,807.3343	0	6,216.4244	5,216.1994	225

Slice 34	624.5098	1,831.9768	0	4,682.6763	3,929.2319	225
Slice 35	641.50327	1,856.2459	0	3,172.1622	2,661.7601	225
Slice 36	664.9934	1,889.7933	0	1,153.6301	968.01058	225

Section 23 SSA for Skyline Ranch.gsz

Section 23 SSA for Skyline Ranch.gsz Run By: Dr. Alexander Bykovtsev, Ph.D., P.E. 3/22/2016 1:04:29 PM

Materials

- TQs 25° A-Bed 6-8 °
- Tmc 25° A-bed 8-17 °
- Fill
- Tmc 17° A-Bed 8-17 °

Name: TQs 25° A-Bed 6-8 °
 Model: Anisotropic Fn.
 Unit Weight: 120 pcf
 Cohesion: 225 psf
 Phi: 40 °
 Phi-Anisotropic Strength Fn.: TQs 25° (A-Bed 6°-8°)
 C-Anisotropic Strength Fn.: TQs 100 psf (Along Bedding 6°-8°)

Name: Tmc 25° A-bed 8-17 °
 Model: Anisotropic Fn.
 Unit Weight: 120 pcf
 Cohesion: 200 psf
 Phi: 40 °
 Phi-Anisotropic Strength Fn.: Tmc 25° (Along Bedding 8°-17°)
 C-Anisotropic Strength Fn.: Tmc 100 psf (A-Bed 8°-17°)

Name: Fill
 Model: Mohr-Coulomb
 Unit Weight: 120 pcf
 Cohesion: 200 psf
 Phi: 33 °

Name: Tmc 17° A-Bed 8-17 °
 Model: Anisotropic Fn.
 Unit Weight: 120 pcf
 Cohesion: 200 psf
 Phi: 40 °
 Phi-Anisotropic Strength Fn.: Tmc 17° (Along Bedding 8°-17°)
 C-Anisotropic Strength Fn.: Tmc 150 psf (A-Bed 8°-17°)

Seismic-Translational

Seismic Loads
 Horizontal: 0.15
 Vertical: 0.0

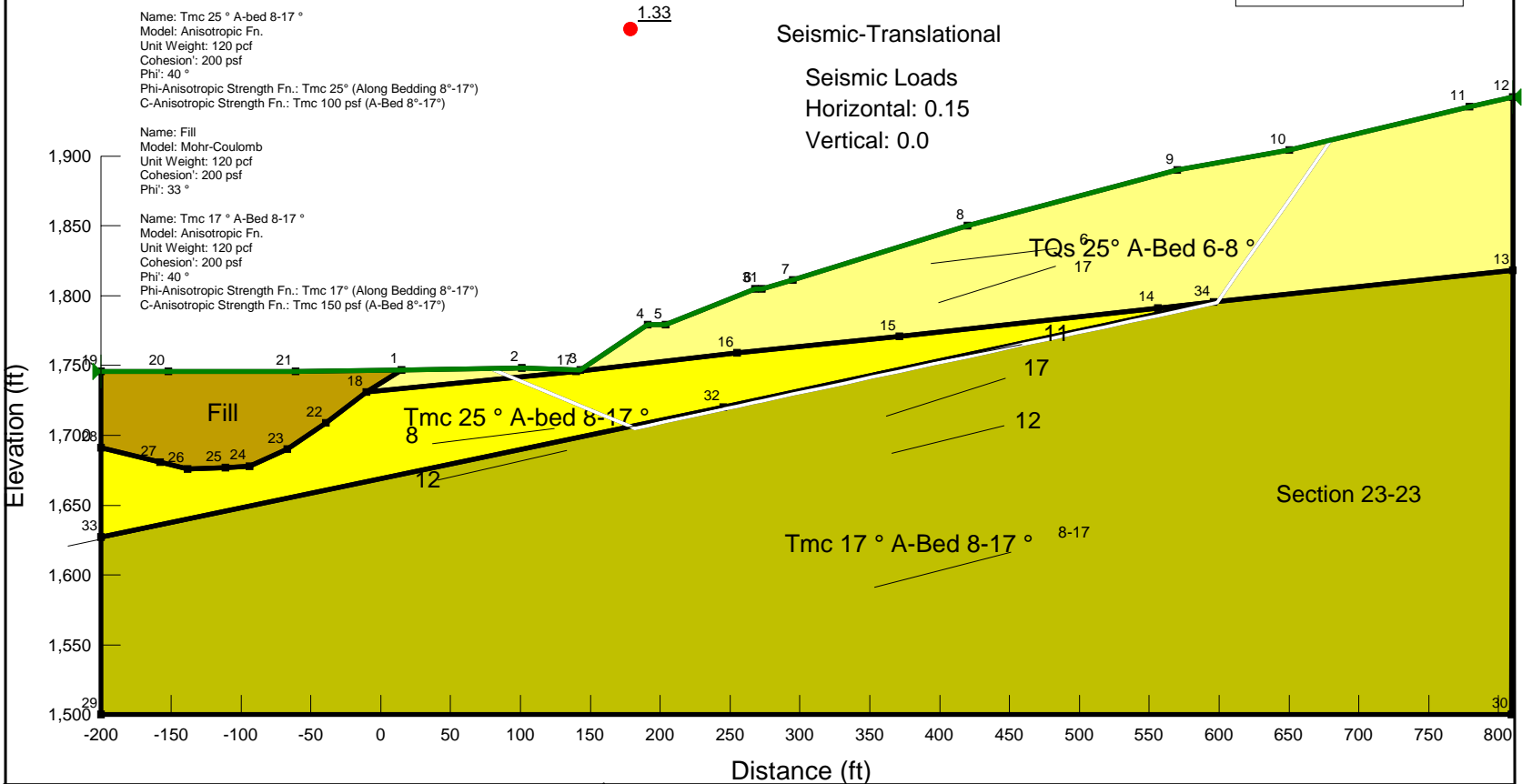

LGC **LGC Valley, Inc**
 GEOTECHNICAL CONSULTING
 28532 Constellation Road, Valencia, CA 91355
 Phone 661-702-8474, Fax 661-702-8475

Skyline Ranch
 Development project, Tract 60922
 Los Angeles CA

Project No: **153035-01**
 Engineer: **BAS**
 Date: **March 2016**

2 - Translational Seismic

Report generated using GeoStudio 2012. Copyright © 1991-2016 GEO-SLOPE International Ltd.

File Information

File Version: 8.15
 Title: *Static Slope Stability Analyses for Skyline Ranch Development project, Tract 60922, Los Angeles CA*
 Comments: Run By: Dr. Alexander Bykovtsev, Ph.D., P.E.
 Last Edited By: Alexander Bykovtsec
 Revision Number: 142
 Date: 3/22/2016
 Time: 1:04:29 PM
 Tool Version: 8.15.5.11777
 File Name: Section 23 SSA for Skyline Ranch.gsz
 Directory: P:\FINAL PROJECTS\PARDEE\Skyline Ranch\SLOPE RESULTS\Section 23-23 results\Latest Update 3-22-16\
 Last Solved Date: 3/22/2016
 Last Solved Time: 1:04:32 PM

Project Settings

Length(L) Units: Feet
 Time(t) Units: Seconds
 Force(F) Units: Pounds
 Pressure(p) Units: psf
 Strength Units: psf
 Unit Weight of Water: 62.4 pcf
 View: 2D
 Element Thickness: 1

Analysis Settings

2 - Translational Seismic

Kind: SLOPE/W
 Parent: 2 - Translational
 Method: Spencer
 Settings
 PWP Conditions Source: (none)
 Initial Slip Surface Source: Parent Analysis
 Slip Surface
 Direction of movement: Right to Left
 Use Passive Mode: No
 Slip Surface Option: Critical Slip Surfaces from Other
 Critical slip surfaces saved: 1
 Resisting Side Maximum Convex Angle: 1 °
 Driving Side Maximum Convex Angle: 5 °
 Optimize Critical Slip Surface Location: No

file:///P:/FINAL%20PROJECTS/PARDEE/Skyline%20Ranch/SLOPE%20RESULTS/Sect... 3/22/2016

Tension Crack
 Tension Crack Option: (none)
 F of S Distribution
 F of S Calculation Option: Constant
 Advanced
 Number of Slices: 30
 F of S Tolerance: 0.01
 Minimum Slip Surface Depth: 0.1 ft
 Search Method: Root Finder
 Tolerable difference between starting and converged F of S: 3
 Maximum iterations to calculate converged lambda: 20
 Max Absolute Lambda: 2

Materials

TQs 25° A-Bed 6-8 °

Model: Anisotropic Fn.
 Unit Weight: 120 pcf
 Cohesion': 225 psf
 Phi': 40 °
 Phi-Anisotropic Strength Fn.: TQs 25° (A-Bed 6°-8°)
 C-Anisotropic Strength Fn.: TQs 100 psf (Along Bedding 6°-8°)
 Phi-B: 0 °

Tmc 25° A-bed 8-17 °

Model: Anisotropic Fn.
 Unit Weight: 120 pcf
 Cohesion': 200 psf
 Phi': 40 °
 Phi-Anisotropic Strength Fn.: Tmc 25° (Along Bedding 8°-17°)
 C-Anisotropic Strength Fn.: Tmc 100 psf (A-Bed 8°-17°)
 Phi-B: 0 °

Fill

Model: Mohr-Coulomb
 Unit Weight: 120 pcf
 Cohesion': 200 psf
 Phi': 33 °
 Phi-B: 0 °

Tmc 17° A-Bed 8-17 °

Model: Anisotropic Fn.
 Unit Weight: 120 pcf
 Cohesion': 200 psf
 Phi': 40 °
 Phi-Anisotropic Strength Fn.: Tmc 17° (Along Bedding 8°-17°)
 C-Anisotropic Strength Fn.: Tmc 150 psf (A-Bed 8°-17°)
 Phi-B: 0 °

file:///P:/FINAL%20PROJECTS/PARDEE/Skyline%20Ranch/SLOPE%20RESULTS/Sect... 3/22/2016

Slip Surface Limits

Left Coordinate: (-200, 1,746) ft
 Right Coordinate: (810, 1,942) ft

Seismic Coefficients

Horz Seismic Coef.: 0.15
 Vert Seismic Coef.: 0

Anisotropic Strength Functions

TQs 25° (A-Bed 6°-8°)

Model: Spline Data Point Function
 Function: Modifier Factor vs. Inclination
 Curve Fit to Data: 100 %
 Segment Curvature: 0 %
 Y-Intercept: 1
 Data Points: Inclination (°), Modifier Factor
 Data Point: (-90, 1)
 Data Point: (5.9, 1)
 Data Point: (6, 0.625)
 Data Point: (8, 0.625)
 Data Point: (8.1, 1)

TQs 100 psf (Along Bedding 6°-8°)

Model: Spline Data Point Function
 Function: Modifier Factor vs. Inclination
 Curve Fit to Data: 100 %
 Segment Curvature: 0 %
 Y-Intercept: 1
 Data Points: Inclination (°), Modifier Factor
 Data Point: (-90, 1)
 Data Point: (5.9, 1)
 Data Point: (6, 0.444)
 Data Point: (8, 0.444)
 Data Point: (8.1, 1)

Tmc 17° (Along Bedding 8°-17°)

Model: Spline Data Point Function
 Function: Modifier Factor vs. Inclination
 Curve Fit to Data: 100 %
 Segment Curvature: 0 %
 Y-Intercept: 1
 Data Points: Inclination (°), Modifier Factor
 Data Point: (-90, 1)
 Data Point: (7.9, 1)

Data Point: (8, 0.425)
 Data Point: (17, 0.425)
 Data Point: (17.1, 1)

Tmc 150 psf (A-Bed 8°-17°)

Model: Spline Data Point Function
 Function: Modifier Factor vs. Inclination
 Curve Fit to Data: 100 %
 Segment Curvature: 0 %
 Y-Intercept: 1
 Data Points: Inclination (°), Modifier Factor
 Data Point: (-90, 1)
 Data Point: (7.9, 1)
 Data Point: (8, 0.75)
 Data Point: (17, 0.75)
 Data Point: (17.1, 1)

Tmc 25° (Along Bedding 8°-17°)

Model: Spline Data Point Function
 Function: Modifier Factor vs. Inclination
 Curve Fit to Data: 100 %
 Segment Curvature: 0 %
 Y-Intercept: 1
 Data Points: Inclination (°), Modifier Factor
 Data Point: (-90, 1)
 Data Point: (7.9, 1)
 Data Point: (8, 0.625)
 Data Point: (17, 0.625)
 Data Point: (17.1, 1)

Tmc 100 psf (A-Bed 8°-17°)

Model: Spline Data Point Function
 Function: Modifier Factor vs. Inclination
 Curve Fit to Data: 100 %
 Segment Curvature: 0 %
 Y-Intercept: 1
 Data Points: Inclination (°), Modifier Factor
 Data Point: (-90, 1)
 Data Point: (7.9, 1)
 Data Point: (8, 0.5)
 Data Point: (17, 0.5)
 Data Point: (17.1, 1)

Points

	X (ft)	Y (ft)
Point 1	15	1,747
Point 2	101	1,748
Point 3	143	1,747

Point 4	191	1,779
Point 5	204	1,779
Point 6	268	1,805
Point 7	295	1,811
Point 8	420	1,850
Point 9	570	1,890
Point 10	650	1,904
Point 11	779	1,935
Point 12	810	1,942
Point 13	810	1,818
Point 14	556	1,791
Point 15	371	1,770.9335
Point 16	255	1,759
Point 17	140	1,746
Point 18	-10	1,731
Point 19	-200	1,746
Point 20	-152	1,746
Point 21	-61	1,746
Point 22	-39	1,709
Point 23	-67	1,690
Point 24	-94	1,678
Point 25	-111	1,677
Point 26	-138	1,676
Point 27	-158	1,681
Point 28	-200	1,691
Point 29	-200	1,500
Point 30	809	1,500
Point 31	273	1,805
Point 32	245	1,720
Point 33	-200	1,627
Point 34	596	1,795.252

Regions

	Material	Points	Area (ft ²)
Region 1	TQs 25° A-Bed 6-8 °	1,2,3,4,5,6,31,7,8,9,10,11,12,13,34,14,15,16,17,18	52,306
Region 2	Fill	19,20,21,1,18,22,23,24,25,26,27,28	10,854
Region 3	Tmc 17 ° A-Bed 8-17 °	29,30,13,34,32,33	2.3309e+005
Region 4	Tmc 25 ° A-bed 8-17 °	28,33,32,34,14,15,16,17,18,22,23,24,25,26,27	27,717

Current Slip Surface

Slip Surface: 1
F of S: 1.33

Volume: 43,712.194 ft³
 Weight: 5,245,463.3 lbs
 Resisting Moment: 5.8921138e+008 lbs-ft
 Activating Moment: 4.4444677e+008 lbs-ft
 Resisting Force: 2,173,359.7 lbs
 Activating Force: 1,627,186.9 lbs
 F of S Rank (Analysis): 1 of 1 slip surfaces
 F of S Rank (Query): 1 of 1 slip surfaces
 Exit: (78.688554, 1,747.7406) ft
 Entry: (679.98681, 1,911.2061) ft
 Radius: 293.37541 ft
 Center: (346.00856, 1,952.0725) ft

Slip Slices

	X (ft)	Y (ft)	PWP (psf)	Base Normal Stress (psf)	Frictional Strength (psf)	Cohesive Strength (psf)
Slice 1	86.342679	1,744.5701	0	1,242.3928	1,042.4914	225
Slice 2	97.498401	1,739.9493	0	2,561.067	2,148.9904	200
Slice 3	110.75	1,734.4603	0	4,070.4482	3,415.5116	200
Slice 4	130.25	1,726.3831	0	6,239.5089	5,235.5696	200
Slice 5	141.5	1,721.7232	0	7,490.8912	6,285.6041	200
Slice 6	151.99337	1,717.3767	0	10,427.375	8,749.6064	200
Slice 7	169.9801	1,709.9264	0	15,966.644	13,397.605	200
Slice 8	180.41046	1,705.606	0	19,178.81	16,092.933	200
Slice 9	186.42373	1,705.9972	0	7,650.5963	2,339.022	150
Slice 10	197.5	1,708.3849	0	7,723.0176	2,361.1634	150
Slice 11	214.25	1,711.9956	0	7,783.4426	2,379.6372	150
Slice 12	234.75	1,716.4148	0	8,210.3216	2,510.1472	150
Slice 13	250	1,719.7022	0	8,527.8784	2,607.2341	150
Slice 14	261.5	1,722.1812	0	8,767.3464	2,680.4468	150
Slice 15	270.5	1,724.1213	0	8,843.8473	2,703.8355	150
Slice 16	284	1,727.0314	0	8,853.659	2,706.8352	150

Slice 17	304.5	1,731.4505	0	9,022.3667	2,758.4143	150
Slice 18	323.5	1,735.5463	0	9,222.454	2,819.5871	150
Slice 19	342.5	1,739.642	0	9,422.5412	2,880.76	150
Slice 20	361.5	1,743.7378	0	9,622.6285	2,941.9328	150
Slice 21	383.25	1,748.4264	0	9,851.6757	3,011.9595	150
Slice 22	407.75	1,753.7078	0	10,109.683	3,090.8402	150
Slice 23	429.71429	1,758.4425	0	10,292.895	3,146.8539	150
Slice 24	449.14286	1,762.6307	0	10,401.313	3,180.0006	150
Slice 25	468.57143	1,766.8188	0	10,509.731	3,213.1473	150
Slice 26	488	1,771.007	0	10,618.15	3,246.2941	150
Slice 27	507.42857	1,775.1951	0	10,726.567	3,279.4407	150
Slice 28	526.85714	1,779.3833	0	10,834.985	3,312.5874	150
Slice 29	546.28571	1,783.5714	0	10,943.403	3,345.7341	150
Slice 30	563	1,787.1745	0	11,036.674	3,374.2499	150
Slice 31	583	1,791.4858	0	11,018.147	3,368.5855	150
Slice 32	597.24842	1,794.5573	0	10,955.025	3,349.2872	150
Slice 33	607.25495	1,807.3343	0	4,605.1492	3,864.179	225
Slice 34	624.5098	1,831.9768	0	3,467.4955	2,909.5742	225
Slice 35	641.50327	1,856.2459	0	2,347.0754	1,969.4301	225
Slice 36	664.9934	1,889.7933	0	849.83429	713.09564	225

Section 24 SSA for Skyline Ranch.gsz

Section 24 SSA for Skyline Ranch.gsz Run By: Dr. Alexander Bykovtsev, Ph.D., P.E. 3/22/2016 11:39:33 AM

Name: TQs 17° bedding 6°-8°
 Model: Anisotropic Fn.
 Unit Weight: 120 pcf
 Cohesion: 225 psf
 Phi: 40°
 Phi-Anisotropic Strength Fn.: TQs 17° (Along Bedding bedding 6°-8°)
 C-Anisotropic Strength Fn.: TQs 150 psf (Along Bedding 6°-8°)

Name: Qls
 Model: Mohr-Coulomb
 Unit Weight: 100 pcf
 Cohesion: 150 psf
 Phi: 20°

Name: TQs 25° bedding 8-13
 Model: Anisotropic Fn.
 Unit Weight: 120 pcf
 Cohesion: 225 psf
 Phi: 40°
 Phi-Anisotropic Strength Fn.: TQs 25° (Along Bedding bedding 8°-13°) (2)
 C-Anisotropic Strength Fn.: TQs 100 psf (Along Bedding 8°-13°)

Name: Fill
 Model: Mohr-Coulomb
 Unit Weight: 120 pcf
 Cohesion: 200 psf
 Phi: 33°

Name: Tmc 17° bedding 8°-13°
 Model: Anisotropic Fn.
 Unit Weight: 120 pcf
 Cohesion: 200 psf
 Phi: 40°
 Phi-Anisotropic Strength Fn.: Tmc 17° (Along Bedding bedding 8°-13°)
 C-Anisotropic Strength Fn.: Tmc 150 psf (Along Bedding 8°-13°)

Materials

- TQs 17° bedding 6°-8°
- Qls
- TQs 25° bedding 8-13
- Fill
- Tmc 17° bedding 8°-13°

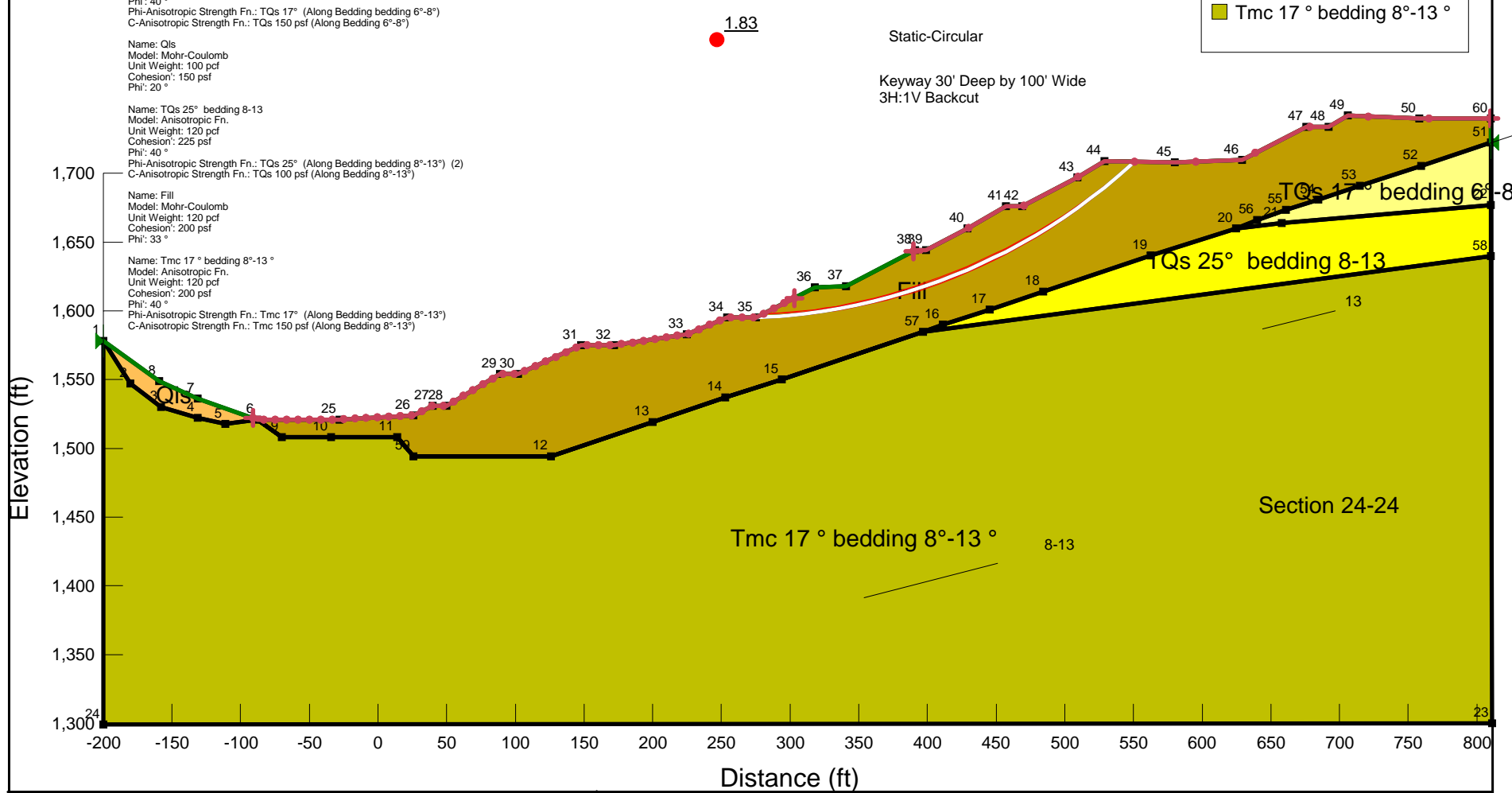

LGC Valley, Inc
 GEOTECHNICAL CONSULTING
 28532 Constellation Road, Valencia, CA 91355
 Phone 661-702-8474, Fax 661-702-8475

Skyline Ranch
 Development project, Tract 60922
 Los Angeles CA

Project No: **153035-01**
 Engineer: **BAS**
 Date: **March 2016**

1 - Circular Mode of Failure

Report generated using GeoStudio 2012. Copyright © 1991-2016 GEO-SLOPE International Ltd.

File Information

File Version: 8.15
 Title: Static Slope Stability Analyses for Skyline Ranch Development project, Tract 60922, Los Angeles CA
 Comments: Run By: Dr. Alexander Bykovtsev, Ph.D., P.E.
 Last Edited By: Alexander Bykovtsev
 Revision Number: 145
 Date: 3/22/2016
 Time: 11:39:33 AM
 Tool Version: 8.15.5.11777
 File Name: Section 24 SSA for Skyline Ranch.gsz
 Directory: P:\FINAL PROJECTS\PARDEE\Skyline Ranch\SLOPE RESULTS\Section 24-24 results\latest update 3-21-16\
 Last Solved Date: 3/22/2016
 Last Solved Time: 11:44:38 AM

Project Settings

Length(L) Units: Feet
 Time(t) Units: Seconds
 Force(F) Units: Pounds
 Pressure(p) Units: psf
 Strength Units: psf
 Unit Weight of Water: 62.4 pcf
 View: 2D
 Element Thickness: 1

Analysis Settings

1 - Circular Mode of Failure

Kind: SLOPE/W
 Method: Bishop
 Settings
 PWP Conditions Source: (none)
 Slip Surface
 Direction of movement: Right to Left
 Use Passive Mode: No
 Slip Surface Option: Entry and Exit
 Critical slip surfaces saved: 1
 Resisting Side Maximum Convex Angle: 1 °
 Driving Side Maximum Convex Angle: 5 °
 Optimize Critical Slip Surface Location: No
 Tension Crack
 Tension Crack Option: (none)
 F of S Distribution
 F of S Calculation Option: Constant
 Advanced
 Number of Slices: 30
 F of S Tolerance: 0.01
 Minimum Slip Surface Depth: 0.1 ft

Materials

TQs 17 ° bedding 6°-8 °

Model: Anisotropic Fn.
 Unit Weight: 120 pcf
 Cohesion: 225 psf
 Phi: 40 °
 Phi-Anisotropic Strength Fn.: TQs 17° (Along Bedding bedding 6°-8°)
 C-Anisotropic Strength Fn.: TQs 150 psf (Along Bedding 6°-8°)
 Phi-B: 0 °

QIs

Model: Mohr-Coulomb
 Unit Weight: 300 pcf
 Cohesion: 150 psf
 Phi: 20 °
 Phi-B: 0 °

TQs 25 ° bedding 8-13

Model: Anisotropic Fn.
 Unit Weight: 120 pcf
 Cohesion: 225 psf
 Phi: 40 °
 Phi-Anisotropic Strength Fn.: TQs 25° (Along Bedding bedding 8°-13°) (2)
 C-Anisotropic Strength Fn.: TQs 100 psf (Along Bedding 8°-13°)
 Phi-B: 0 °

Fill

Model: Mohr-Coulomb
 Unit Weight: 120 pcf
 Cohesion: 200 psf
 Phi: 33 °
 Phi-B: 0 °

Tmc 17 ° bedding 8°-13 °

Model: Anisotropic Fn.
 Unit Weight: 120 pcf
 Cohesion: 200 psf
 Phi: 40 °
 Phi-Anisotropic Strength Fn.: Tmc 17° (Along Bedding bedding 8°-13°)
 C-Anisotropic Strength Fn.: Tmc 150 psf (Along Bedding 8°-13°)
 Phi-B: 0 °

Slip Surface Entry and Exit

Left Projection: Range
 Left-Zone Left Coordinate: (-90.9829, 1,522.0406) ft
 Left-Zone Right Coordinate: (303, 1,609.3256) ft
 Left-Zone Increment: 50
 Right Projection: Range
 Right-Zone Left Coordinate: (389.8258, 1,643.3894) ft
 Right-Zone Right Coordinate: (809.8104, 1,740) ft
 Right-Zone Increment: 10
 Radius Increments: 50

Slip Surface Limits

Left Coordinate: (-200, 1,578) ft
 Right Coordinate: (810.1075, 1,722.407) ft

Seismic Coefficients

Horz Seismic Coef.: 0
 Vert Seismic Coef.: 0

Anisotropic Strength Functions

Tmc 17° (Along Bedding bedding 8°-13°)

Model: Spline Data Point Function
 Function: Modifier Factor vs. Inclination
 Curve Fit to Data: 100 %
 Segment Curvature: 0 %
 Y-Intercept: 1
 Data Points: Inclination (°), Modifier Factor
 Data Point: (-90, 1)
 Data Point: (7.9, 1)
 Data Point: (8, 0.425)
 Data Point: (13, 0.425)
 Data Point: (13.1, 1)

Tmc 150 psf (Along Bedding 8°-13°)

Model: Spline Data Point Function
 Function: Modifier Factor vs. Inclination
 Curve Fit to Data: 100 %
 Segment Curvature: 0 %
 Y-Intercept: 1
 Data Points: Inclination (°), Modifier Factor
 Data Point: (-90, 1)
 Data Point: (7.9, 1)
 Data Point: (8, 0.75)
 Data Point: (13, 0.75)
 Data Point: (13.1, 1)

TQs 17° (Along Bedding bedding 6°-8°)

Model: Spline Data Point Function
 Function: Modifier Factor vs. Inclination
 Curve Fit to Data: 100 %
 Segment Curvature: 0 %
 Y-Intercept: 1
 Data Points: Inclination (°), Modifier Factor
 Data Point: (-90, 1)
 Data Point: (5.9, 1)
 Data Point: (6, 0.425)
 Data Point: (8, 0.425)
 Data Point: (8.1, 1)

TQs 150 psf (Along Bedding 6°-8°)

Model: Spline Data Point Function

Function: Modifier Factor vs. Inclination
 Curve Fit to Data: 100 %
 Segment Curvature: 0 %
 Y-Intercept: 1
 Data Points: Inclination (*), Modifier Factor
 Data Point: (-90, 1)
 Data Point: (5.9, 1)
 Data Point: (6, 0.667)
 Data Point: (8, 0.667)
 Data Point: (8.1, 1)

TQs 100 psf (Along Bedding 8°-13°)

Model: Spline Data Point Function
 Function: Modifier Factor vs. Inclination
 Curve Fit to Data: 100 %
 Segment Curvature: 0 %
 Y-Intercept: 1
 Data Points: Inclination (*), Modifier Factor
 Data Point: (-90, 1)
 Data Point: (7.9, 1)
 Data Point: (8, 0.444)
 Data Point: (13, 0.444)
 Data Point: (13.1, 1)

TQs 25° (Along Bedding 8°-13°) (2)

Model: Spline Data Point Function
 Function: Modifier Factor vs. Inclination
 Curve Fit to Data: 100 %
 Segment Curvature: 0 %
 Y-Intercept: 1
 Data Points: Inclination (*), Modifier Factor
 Data Point: (-90, 1)
 Data Point: (7.9, 1)
 Data Point: (8, 0.625)
 Data Point: (13, 0.625)
 Data Point: (13.1, 1)

Points

Point	X (ft)	Y (ft)
Point 1	-200	1,578
Point 2	-180	1,547
Point 3	-158	1,530
Point 4	-131	1,522
Point 5	-111	1,518
Point 6	-88	1,521
Point 7	-131	1,536
Point 8	-159	1,549
Point 9	-70	1,508
Point 10	-34	1,508
Point 11	14	1,508
Point 12	126	1,494
Point 13	200	1,519
Point 14	253	1,537
Point 15	294	1,550
Point 16	411.0219	1,589.767
Point 17	445.1762	1,601.0103
Point 18	484.351	1,614.0214
Point 19	562.5197	1,640.3984
Point 20	624.593	1,659.8269
Point 21	657.92	1,663.8109
Point 22	810	1,677
Point 23	811	1,300
Point 24	-200	1,299
Point 25	-28	1,521
Point 26	26	1,524
Point 27	40	1,531
Point 28	50	1,531
Point 29	89	1,554
Point 30	102	1,554
Point 31	148	1,575
Point 32	172	1,575
Point 33	225	1,583
Point 34	254	1,595
Point 35	275	1,595
Point 36	318	1,617
Point 37	341	1,618
Point 38	391	1,644

Point 39	399	1,644
Point 40	429	1,660
Point 41	457	1,676
Point 42	469	1,676
Point 43	509	1,697
Point 44	529	1,709
Point 45	580	1,708
Point 46	629	1,710
Point 47	676	1,734
Point 48	692	1,734
Point 49	706	1,742
Point 50	758	1,740
Point 51	810.1075	1,722.407
Point 52	759.6215	1,705.3398
Point 53	714.9876	1,690.9993
Point 54	684.7791	1,680.8166
Point 55	661.1045	1,673.3494
Point 56	640.1453	1,666.1367
Point 57	396.8087	1,584.5342
Point 58	810.0981	1,640
Point 59	26	1,494
Point 60	810	1,740

Regions

Region	Material	Points	Area (ft²)
Region 1	Qts	1,2,3,4,5,6,7,8	1,371.5
Region 2	Tmc 17° bedding 8°-13°	6,5,4,3,2,1,24,23,58,57,15,14,13,12,59,11,10,9	2.6373e+08
Region 3	Fill	6,25,26,27,28,29,30,31,32,33,34,35,36,37,38,39,40,41,42,43,44,45,46,47,48,49,50,60,51,52,53,54,55,56,20,19,18,17,16,57,15,14,13,12,59,11,10,9	45,816
Region 4	TQs 17° bedding 6°-8°	20,21,22,51,52,53,54,55,56	4,213.8
Region 5	TQs 25° bedding 8-13	57,58,22,21,20,19,18,17,16	12,895

Current Slip Surface

Slip Surface: 26,023
 F of S: 1.83
 Volume: 5,837.2569 ft³
 Weight: 700,470.82 lbs
 Resisting Moment: 2.116067e+008 lbs-ft
 Activating Moment: 1.157674e+008 lbs-ft
 F of S Rank (Analysis): 1 of 28,611 slip surfaces
 F of S Rank (Query): 1 of 10 slip surfaces
 Ext: (275.12545, 1.595.0642) ft
 Entry: (550.87038, 1.708.5712) ft
 Radius: 433.18916 ft
 Center: (258.17933, 2.027.9218) ft

Slip Slices

	X (ft)	Y (ft)	PWP (psf)	Base Normal Stress (psf)	Frictional Strength (psf)	Cohesive Strength (psf)
Slice 1	279.4129	1,595.2746	0	228.63711	148.47868	200
Slice 2	287.98781	1,595.7808	0	679.53601	441.29584	200
Slice 3	296.56272	1,596.4579	0	1,104.3314	717.16121	200
Slice 4	305.13763	1,597.3069	0	1,503.4138	976.32833	200
Slice 5	313.71254	1,598.3287	0	1,877.1301	1,219.0225	200
Slice 6	321.83333	1,599.4524	0	2,003.8798	1,301.3348	200
Slice 7	329.5	1,600.6618	0	1,890.4142	1,227.6493	200
Slice 8	337.16667	1,602.0126	0	1,762.2966	1,144.4488	200
Slice 9	346	1,603.7587	0	1,861.6114	1,208.9446	200
Slice 10	356	1,605.953	0	2,177.2676	1,413.9341	200
Slice 11	366	1,608.3971	0	2,459.9914	1,597.5371	200
Slice 12	376	1,611.0955	0	2,709.9386	1,759.8547	200
Slice 13	386	1,614.053	0	2,927.2035	1,900.9482	200
Slice 14	395	1,616.9288	0	2,872.9054	1,865.6865	200
Slice 15	404	1,620.048	0	2,800.07	1,818.3867	200
Slice 16	414	1,623.7633	0	2,943.6902	1,911.6547	200
Slice 17	424	1,627.763	0	3,054.2147	1,983.4302	200
Slice 18	433.66667	1,631.9028	0	3,148.3532	2,044.5645	200

Slice 19	443	1,636.1724	0	3,227.6068	2,096.0324	200
Slice 20	452.33333	1,640.714	0	3,276.7078	2,127.9189	200
Slice 21	463	1,646.274	0	2,947.3745	1,914.0474	200
Slice 22	474	1,652.3675	0	2,565.1955	1,665.8575	200
Slice 23	484	1,658.2955	0	2,467.9366	1,602.6968	200
Slice 24	494	1,664.5956	0	2,335.0064	1,516.3709	200
Slice 25	504	1,671.2873	0	2,165.6942	1,406.4183	200
Slice 26	514	1,678.3932	0	1,994.9219	1,295.5174	200
Slice 27	524	1,685.9391	0	1,820.4358	1,182.2048	200
Slice 28	534.46759	1,694.3543	0	1,278.4859	830.25845	200
Slice 29	545.40278	1,703.7271	0	378.4311	245.75603	200

Section 24 SSA for Skyline Ranch.gsz

Section 24 SSA for Skyline Ranch.gsz Run By: Dr. Alexander Bykovtsev, Ph.D., P.E. 3/22/2016 11:39:33 AM

Materials

- TQs 17° bedding 6°-8°
- QIs
- TQs 25° bedding 8-13
- Fill
- Tmc 17° bedding 8°-13°

Name: TQs 17° bedding 6°-8°
 Model: Anisotropic Fn.
 Unit Weight: 120 pcf
 Cohesion: 225 psf
 Phi: 40°
 Phi-Anisotropic Strength Fn.: TQs 17° (Along Bedding bedding 6°-8°)
 C-Anisotropic Strength Fn.: TQs 150 psf (Along Bedding 6°-8°)

Name: QIs
 Model: Mohr-Coulomb
 Unit Weight: 100 pcf
 Cohesion: 150 psf
 Phi: 20°

Name: TQs 25° bedding 8-13
 Model: Anisotropic Fn.
 Unit Weight: 120 pcf
 Cohesion: 225 psf
 Phi: 40°
 Phi-Anisotropic Strength Fn.: TQs 25° (Along Bedding bedding 8°-13°) (2)
 C-Anisotropic Strength Fn.: TQs 100 psf (Along Bedding 8°-13°)

Name: Fill
 Model: Mohr-Coulomb
 Unit Weight: 120 pcf
 Cohesion: 200 psf
 Phi: 33°

Name: Tmc 17° bedding 8°-13°
 Model: Anisotropic Fn.
 Unit Weight: 120 pcf
 Cohesion: 200 psf
 Phi: 40°
 Phi-Anisotropic Strength Fn.: Tmc 17° (Along Bedding bedding 8°-13°)
 C-Anisotropic Strength Fn.: Tmc 150 psf (Along Bedding 8°-13°)

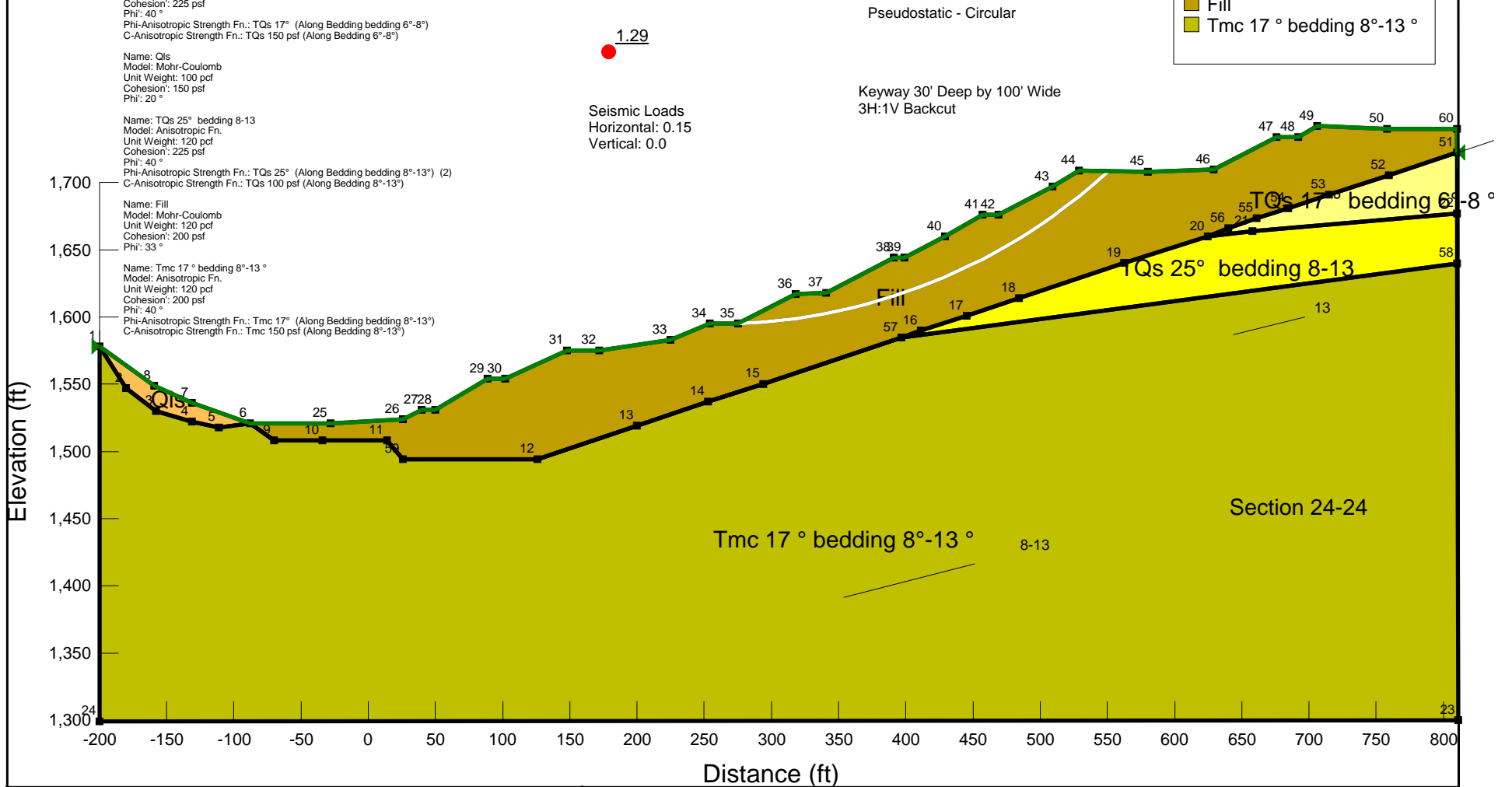

LGC **LGC Valley, Inc**
 GEOTECHNICAL CONSULTING
 28532 Constellation Road, Valencia, CA 91355
 Phone 661-702-8474, Fax 661-702-8475

Skyline Ranch
Development project, Tract 60922
Los Angeles CA

Project No: **153035-01**
 Engineer: **BAS**
 Date: **March 2016**

1 - Circular Mode of Failure Seismic

Report generated using GeoStudio 2012. Copyright © 1991-2016 GEO-SLOPE International Ltd.

File Information

File Version: 8.15
 Title: Static Slope Stability Analyses for Skyline Ranch Development project, Tract 60922, Los Angeles CA
 Comments: Run By: Dr. Alexander Bykovtsev, Ph.D., P.E.
 Last Edited By: Alexander Bykovtsev
 Revision Number: 145
 Date: 3/22/2016
 Time: 11:39:33 AM
 Tool Version: 8.15.5.11777
 File Name: Section 24 SSA for Skyline Ranch.gsz
 Directory: P:\FINAL PROJECTS\PARDEE\Skyline Ranch\SLOPE RESULTS\Section 24-24 results\latest update 3-21-16\
 Last Solved Date: 3/22/2016
 Last Solved Time: 11:44:39 AM

Project Settings

Length(L) Units: Feet
 Time(t) Units: Seconds
 Force(F) Units: Pounds
 Pressure(p) Units: psf
 Strength Units: psf
 Unit Weight of Water: 62.4 pcf
 View: 2D
 Element Thickness: 1

Analysis Settings

1 - Circular Mode of Failure Seismic

Kind: SLOPE/W
 Parent: 1 - Circular Mode of Failure
 Method: Bishop
 Settings
 PWP Conditions Source: (none)
 Initial Slip Surface Source: Parent Analysis
 Slip Surface
 Direction of movement: Right to Left
 Use Passive Mode: No
 Slip Surface Option: Critical Slip Surfaces from Other
 Critical slip surfaces saved: 1
 Resisting Side Maximum Convex Angle: 1 °
 Driving Side Maximum Convex Angle: 5 °
 Optimize Critical Slip Surface Location: No
 Tension Crack
 Tension Crack Option: (none)
 F of S Distribution
 F of S Calculation Option: Constant
 Advanced
 Number of Slices: 30
 F of S Tolerance: 0.01
 Minimum Slip Surface Depth: 0.1 ft

Materials

TQs 17 ° bedding 6°-8 °

Model: Anisotropic Fn.
 Unit Weight: 120 pcf
 Cohesion: 225 psf
 Phi: 40 °
 Phi-Anisotropic Strength Fn.: TQs 17° (Along Bedding bedding 6°-8°)
 C-Anisotropic Strength Fn.: TQs 150 psf (Along Bedding 6°-8°)
 Phi-B: 0 °

QJs

Model: Mohr-Coulomb
 Unit Weight: 100 pcf
 Cohesion: 150 psf
 Phi: 20 °
 Phi-B: 0 °

TQs 25° bedding 8-13

Model: Anisotropic Fn.
 Unit Weight: 120 pcf
 Cohesion: 225 psf
 Phi: 40 °
 Phi-Anisotropic Strength Fn.: TQs 25° (Along Bedding bedding 8°-13°) (2)

C-Anisotropic Strength Fn.: TQs 100 psf (Along Bedding 8°-13°)
 Phi-B: 0 °

Fill

Model: Mohr-Coulomb
 Unit Weight: 120 pcf
 Cohesion: 200 psf
 Phi: 33 °
 Phi-B: 0 °

Tmc 17 ° bedding 8°-13 °

Model: Anisotropic Fn.
 Unit Weight: 120 pcf
 Cohesion: 200 psf
 Phi: 40 °
 Phi-Anisotropic Strength Fn.: Tmc 17° (Along Bedding bedding 8°-13°)
 C-Anisotropic Strength Fn.: Tmc 150 psf (Along Bedding 8°-13°)
 Phi-B: 0 °

Slip Surface Limits

Left Coordinate: (-200, 1,578) ft
 Right Coordinate: (810.1075, 1,722.407) ft

Seismic Coefficients

Horz Seismic Coef.: 0.15
 Vert Seismic Coef.: 0

Anisotropic Strength Functions

Tmc 17° (Along Bedding bedding 8°-13°)

Model: Spline Data Point Function
 Function: Modifier Factor vs. Inclination
 Curve Fit to Data: 100 %
 Segment Curvature: 0 %
 Y-Intercept: 1
 Data Points: Inclination (°), Modifier Factor
 Data Point: (-90, 1)
 Data Point: (7.9, 1)
 Data Point: (8, 0.425)
 Data Point: (15, 0.425)
 Data Point: (13.1, 1)

Tmc 150 psf (Along Bedding 8°-13°)

Model: Spline Data Point Function
 Function: Modifier Factor vs. Inclination
 Curve Fit to Data: 100 %
 Segment Curvature: 0 %
 Y-Intercept: 1
 Data Points: Inclination (°), Modifier Factor
 Data Point: (-90, 1)
 Data Point: (7.9, 1)
 Data Point: (8, 0.75)
 Data Point: (15, 0.75)
 Data Point: (13.1, 1)

TQs 17° (Along Bedding bedding 6°-8°)

Model: Spline Data Point Function
 Function: Modifier Factor vs. Inclination
 Curve Fit to Data: 100 %
 Segment Curvature: 0 %
 Y-Intercept: 1
 Data Points: Inclination (°), Modifier Factor
 Data Point: (-90, 1)
 Data Point: (5.9, 1)
 Data Point: (6, 0.425)
 Data Point: (8, 0.425)
 Data Point: (8.1, 1)

TQs 150 psf (Along Bedding 6°-8°)

Model: Spline Data Point Function
 Function: Modifier Factor vs. Inclination
 Curve Fit to Data: 100 %
 Segment Curvature: 0 %
 Y-Intercept: 1
 Data Points: Inclination (°), Modifier Factor
 Data Point: (-90, 1)
 Data Point: (5.9, 1)
 Data Point: (6, 0.667)
 Data Point: (8, 0.667)
 Data Point: (8.1, 1)

TQs 100 psf (Along Bedding 8°-13°)

Model: Spline Data Point Function
 Function: Modifier Factor vs. Inclination
 Curve Fit to Data: 100%
 Segment Curvature: 0%
 Y-Intercept: 1
 Data Points: Inclination (*), Modifier Factor
 Data Point: (-90, 1)
 Data Point: (7.9, 1)
 Data Point: (8, 0.444)
 Data Point: (13, 0.444)
 Data Point: (13.1, 1)

TQs 25° (Along Bedding bedding 8°-13°) (2)

Model: Spline Data Point Function
 Function: Modifier Factor vs. Inclination
 Curve Fit to Data: 100%
 Segment Curvature: 0%
 Y-Intercept: 1
 Data Points: Inclination (*), Modifier Factor
 Data Point: (-90, 1)
 Data Point: (7.9, 1)
 Data Point: (8, 0.625)
 Data Point: (13, 0.625)
 Data Point: (13.1, 1)

Points

	X (ft)	Y (ft)
Point 1	-200	1,578
Point 2	-180	1,547
Point 3	-158	1,530
Point 4	-131	1,522
Point 5	-111	1,518
Point 6	-88	1,521
Point 7	-131	1,536
Point 8	-159	1,549
Point 9	-70	1,508
Point 10	-34	1,508
Point 11	14	1,508
Point 12	126	1,494
Point 13	200	1,519
Point 14	253	1,537
Point 15	294	1,550
Point 16	411.0219	1,589.767
Point 17	445.1762	1,601.0103
Point 18	484.351	1,614.0214
Point 19	562.5197	1,640.3984
Point 20	624.593	1,659.8269
Point 21	657.92	1,663.8109
Point 22	810	1,677
Point 23	811	1,300
Point 24	-200	1,299
Point 25	-28	1,521
Point 26	26	1,524
Point 27	40	1,531
Point 28	50	1,531
Point 29	89	1,554
Point 30	102	1,554
Point 31	148	1,575
Point 32	172	1,575
Point 33	225	1,583
Point 34	254	1,595
Point 35	275	1,595
Point 36	318	1,617
Point 37	341	1,618
Point 38	391	1,644
Point 39	399	1,644
Point 40	429	1,660
Point 41	457	1,676
Point 42	469	1,676
Point 43	509	1,697
Point 44	529	1,709
Point 45	580	1,708
Point 46	629	1,710
Point 47	676	1,734

Point 48	692	1,734
Point 49	706	1,742
Point 50	758	1,740
Point 51	810.1075	1,722.407
Point 52	759.6215	1,705.3398
Point 53	714.9876	1,690.9993
Point 54	684.7791	1,680.8166
Point 55	661.1045	1,673.3494
Point 56	640.1453	1,666.1367
Point 57	396.8087	1,584.5342
Point 58	810.0981	1,640
Point 59	26	1,494
Point 60	810	1,740

Regions

Region	Material	Points	Area (ft²)
Region 1	Qts	1,2,3,4,5,6,7,8	1,371.5
Region 2	Tmc 17 * bedding 8°-13 *	6,5,4,3,2,1,24,23,58,57,15,14,13,12,59,11,10,9	2.6373e+0
Region 3	Fill	6,25,26,27,28,29,30,31,32,33,34,35,36,37,38,39,40,41,42,43,44,45,46,47,48,49,50,60,51,52,53,54,55,56,20,19,18,17,16,57,15,14,13,12,59,11,10,9	45,816
Region 4	TQs 17 * bedding 6°-8 *	20,21,22,51,52,53,54,55,56	4,213.8
Region 5	TQs 25 * bedding 8-13	57,58,22,21,20,19,18,17,16	12,895

Current Slip Surface

Slip Surface: 1
 F of S: 1.29
 Volume: 5,837.2569 ft³
 Weight: 700,470.82 lbs
 Resisting Moment: 2.0083494e+008 lbs-ft
 Activating Moment: 1.5589143e+008 lbs-ft
 F of S Rank (Analysis): 1 of 1 slip surfaces
 F of S Rank (Query): 1 of 1 slip surfaces
 Ext: (275.32545, 1,595.0642) ft
 Entry: (550.87038, 1,708.5712) ft
 Radius: 433.18916 ft
 Center: (258.17933, 2,027.9218) ft

Slip Slices

	X (ft)	Y (ft)	PWP (psf)	Base Normal Stress (psf)	Frictional Strength (psf)	Cohesive Strength (psf)
Slice 1	279.4129	1,595.2746	0	224.8309	146.00689	200
Slice 2	287.98781	1,595.7808	0	669.78664	434.96453	200
Slice 3	296.56272	1,596.4579	0	1,086.522	705.59565	200
Slice 4	305.13763	1,597.3069	0	1,475.6818	958.31899	200
Slice 5	313.71254	1,598.3287	0	1,837.8523	1,193.5153	200
Slice 6	321.83333	1,599.4524	0	1,956.5531	1,270.6005	200
Slice 7	329.5	1,600.6618	0	1,840.2778	1,195.0904	200
Slice 8	337.16667	1,602.0126	0	1,710.288	1,110.674	200
Slice 9	346	1,603.7587	0	1,801.3813	1,169.8177	200
Slice 10	356	1,605.953	0	2,100.8554	1,364.3114	200
Slice 11	366	1,608.3971	0	2,366.6979	1,536.9516	200
Slice 12	376	1,611.0955	0	2,599.3306	1,688.0251	200
Slice 13	386	1,614.053	0	2,799.1262	1,817.7738	200
Slice 14	395	1,616.9288	0	2,738.5743	1,778.4509	200
Slice 15	404	1,620.048	0	2,660.5898	1,727.8072	200
Slice 16	414	1,623.7633	0	2,788.1817	1,810.6664	200
Slice 17	424	1,627.763	0	2,883.4655	1,872.5444	200
Slice 18	433.66667	1,631.9028	0	2,962.8668	1,924.1082	200
Slice 19	443	1,636.1724	0	3,027.9505	1,966.374	200
Slice 20	452.33333	1,640.714	0	3,064.1224	1,989.8644	200
Slice 21	463	1,646.274	0	2,743.6312	1,781.7349	200
Slice 22	474	1,652.3675	0	2,375.494	1,542.6638	200
Slice 23	484	1,658.2955	0	2,275.8073	1,477.9265	200
Slice 24	494	1,664.5956	0	2,143.4728	1,391.9875	200
Slice 25	504	1,671.2873	0	1,978.1815	1,284.6461	200
Slice 26	514	1,678.3932	0	1,812.4635	1,177.0276	200
Slice 27	524	1,685.9391	0	1,644.2826	1,067.8096	200

Slice 28	534.46759	1,694.3543	0	1,141.1053	741.04242	200
Slice 29	545.40278	1,703.7271	0	316.12798	205.29591	200

Section 24 SSA for Skyline Ranch.gsz

Section 24 SSA for Skyline Ranch.gsz Run By: Dr. Alexander Bykovtsev, Ph.D., P.E. 3/22/2016 11:39:33 AM

Name: TQs 17 ° bedding 6°-8 °
 Model: Anisotropic Fn.
 Unit Weight: 120 pcf
 Cohesion: 225 psf
 Phi: 40 °
 Phi-Anisotropic Strength Fn.: TQs 17° (Along Bedding bedding 6°-8°)
 C-Anisotropic Strength Fn.: TQs 150 psf (Along Bedding 6°-8°)

Name: QIs
 Model: Mohr-Coulomb
 Unit Weight: 100 pcf
 Cohesion: 150 psf
 Phi: 20 °

Name: TQs 25° bedding 8-13
 Model: Anisotropic Fn.
 Unit Weight: 120 pcf
 Cohesion: 225 psf
 Phi: 40 °
 Phi-Anisotropic Strength Fn.: TQs 25° (Along Bedding bedding 8°-13°) (2)
 C-Anisotropic Strength Fn.: TQs 100 psf (Along Bedding 8°-13°)

Name: Fill
 Model: Mohr-Coulomb
 Unit Weight: 120 pcf
 Cohesion: 200 psf
 Phi: 33 °

Name: Tmc 17 ° bedding 8°-13 °
 Model: Anisotropic Fn.
 Unit Weight: 120 pcf
 Cohesion: 200 psf
 Phi: 40 °
 Phi-Anisotropic Strength Fn.: Tmc 17° (Along Bedding bedding 8°-13°)
 C-Anisotropic Strength Fn.: Tmc 150 psf (Along Bedding 8°-13°)

Materials

- TQs 17 ° bedding 6°-8 °
- QIs
- TQs 25° bedding 8-13
- Fill
- Tmc 17 ° bedding 8°-13 °

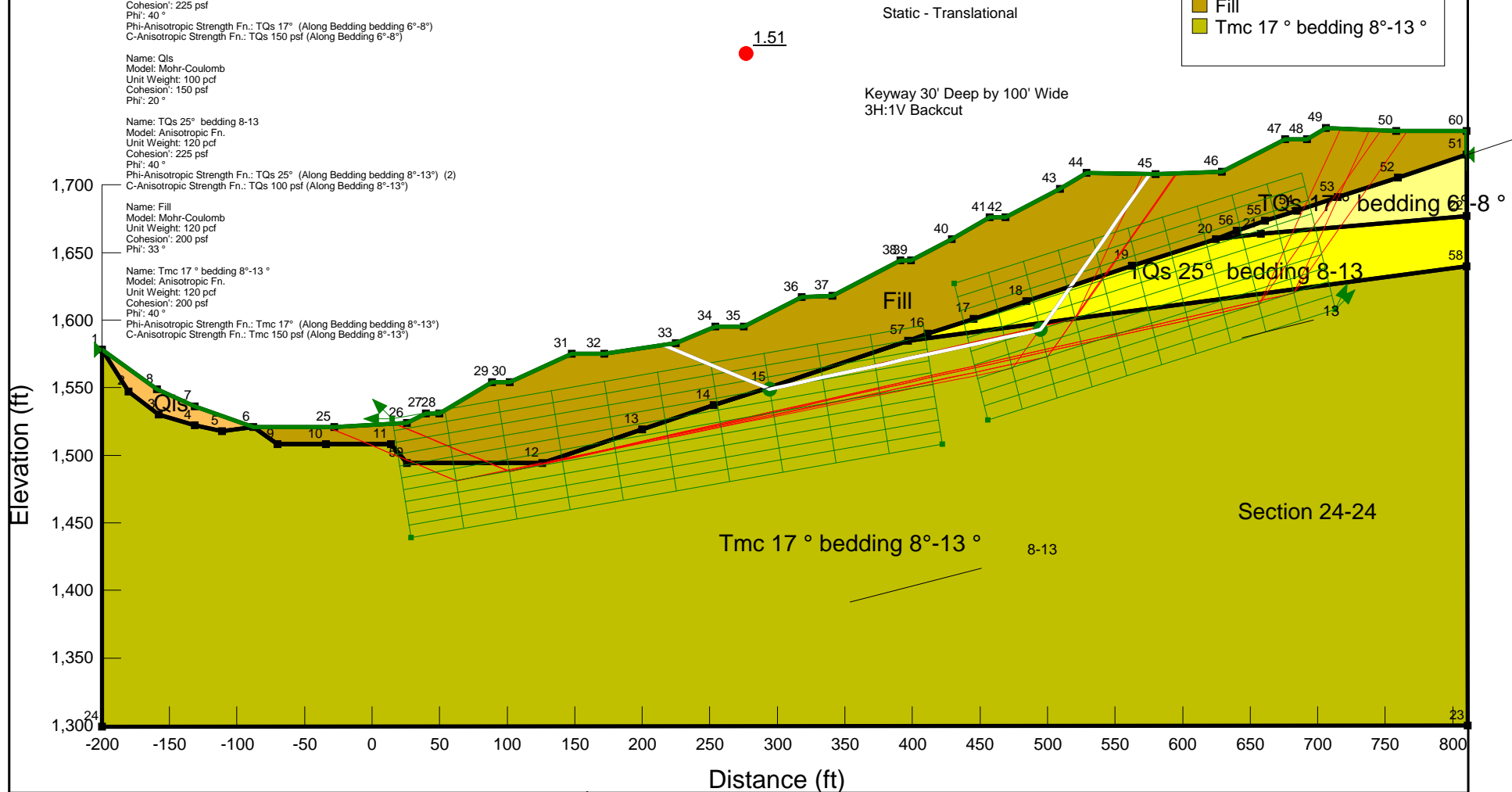

<p>LGC Valley, Inc GEOTECHNICAL CONSULTING 28532 Constellation Road, Valencia, CA 91355 Phone 661-702-8474, Fax 661-702-8475</p>	<p>Skyline Ranch Development project, Tract 60922 Los Angeles CA</p>	<p>Project No: 153035-01 Engineer: BAS Date: March 2016</p>
--	---	--

2 - Translational

Report generated using GeoStudio 2012. Copyright © 1991-2016 GEO-SLOPE International Ltd.

File Information

File Version: 8.15
 Title: Static Slope Stability Analyses for Skyline Ranch Development project, Tract 60922, Los Angeles CA
 Comments: Run By: Dr. Alexander Bykovtsev, Ph.D., P.E.
 Last Edited By: Alexander Bykovtsev
 Revision Number: 145
 Date: 3/22/2016
 Time: 11:39:33 AM
 Tool Version: 8.15.5.11777
 File Name: Section 24 SSA for Skyline Ranch.gsz
 Directory: P:\FINAL PROJECTS\PARDEE\Skyline Ranch\SLOPE RESULTS\Section 24-24 results\latest update 3-21-16\
 Last Solved Date: 3/22/2016
 Last Solved Time: 11:40:29 AM

Project Settings

Length(L) Units: Feet
 Time(t) Units: Seconds
 Force(F) Units: Pounds
 Pressure(p) Units: psf
 Strength Units: psf
 Unit Weight of Water: 62.4 pcf
 View: 2D
 Element Thickness: 1

Analysis Settings

2 - Translational

Kind: SLOPE/W
 Method: Janbu
 Settings
 PWP Conditions Source: (none)
 Slip Surface
 Direction of movement: Right to Left
 Use Passive Mode: No
 Slip Surface Option: Block
 Critical slip surfaces saved: 1
 Resisting Side Maximum Convex Angle: 1 °
 Driving Side Maximum Convex Angle: 5 °
 Restrict Block Crossing: No
 Optimize Critical Slip Surface Location: No
 Tension Crack
 Tension Crack Option: (none)
 F of S Distribution
 F of S Calculation Option: Constant
 Advanced
 Number of Slices: 30
 F of S Tolerance: 0.01
 Minimum Slip Surface Depth: 0.1 ft

Materials

TQs 17 ° bedding 6°-8 °

Model: Anisotropic Fn.
 Unit Weight: 120 pcf
 Cohesion: 225 psf
 Phi: 40 °
 Phi-Anisotropic Strength Fn.: TQs 17° (Along Bedding bedding 6°-8°)
 C-Anisotropic Strength Fn.: TQs 150 psf (Along Bedding 6°-8°)
 Phi-B: 0 °

QIs

Model: Mohr-Coulomb
 Unit Weight: 100 pcf
 Cohesion: 150 psf
 Phi: 20 °
 Phi-B: 0 °

TQs 25° bedding 8-13

Model: Anisotropic Fn.
 Unit Weight: 120 pcf
 Cohesion: 225 psf
 Phi: 40 °
 Phi-Anisotropic Strength Fn.: TQs 25° (Along Bedding bedding 8°-13°) (2)
 C-Anisotropic Strength Fn.: TQs 100 psf (Along Bedding 8°-13°)

file:///P:/FINAL%20PROJECTS/PARDEE/Skyline%20Ranch/SLOPE%20RESULTS/Sect... 3/22/2016

Phi-B: 0 °

Fill

Model: Mohr-Coulomb
 Unit Weight: 120 pcf
 Cohesion: 200 psf
 Phi: 33 °
 Phi-B: 0 °

Tmc 17 ° bedding 8°-13 °

Model: Anisotropic Fn.
 Unit Weight: 120 pcf
 Cohesion: 200 psf
 Phi: 40 °
 Phi-Anisotropic Strength Fn.: Tmc 17° (Along Bedding bedding 8°-13°)
 C-Anisotropic Strength Fn.: Tmc 150 psf (Along Bedding 8°-13°)
 Phi-B: 0 °

Slip Surface Limits

Left Coordinate: (-200, 1.578) ft
 Right Coordinate: (810.1075, 1,722.407) ft

Slip Surface Block

Left Grid
 Upper Left: (15, 1.527) ft
 Lower Left: (29, 1,439) ft
 Lower Right: (422, 1,508) ft
 X Increments: 10
 Y Increments: 10
 Starting Angle: 135 °
 Ending Angle: 180 °
 Angle Increments: 2
 Right Grid
 Upper Left: (431, 1,627) ft
 Lower Left: (456, 1,526) ft
 Lower Right: (713, 1,608) ft
 X Increments: 10
 Y Increments: 10
 Starting Angle: 45 °
 Ending Angle: 65 °
 Angle Increments: 2

Seismic Coefficients

Horz Seismic Coef.: 0
 Vert Seismic Coef.: 0

Anisotropic Strength Functions

Tmc 17° (Along Bedding bedding 8°-13°)

Model: Spline Data Point Function
 Function: Modifier Factor vs. Inclination
 Curve Fit to Data: 100 %
 Segment Curvature: 0 %
 Y-Intercept: 1
 Data Points: Inclination (°), Modifier Factor
 Data Point: (-90, 1)
 Data Point: (7.9, 1)
 Data Point: (8, 0.425)
 Data Point: (13, 0.425)
 Data Point: (13.1, 1)

Tmc 150 psf (Along Bedding 8°-13°)

Model: Spline Data Point Function
 Function: Modifier Factor vs. Inclination
 Curve Fit to Data: 100 %
 Segment Curvature: 0 %
 Y-Intercept: 1
 Data Points: Inclination (°), Modifier Factor
 Data Point: (-90, 1)
 Data Point: (7.9, 1)
 Data Point: (8, 0.75)
 Data Point: (13, 0.75)
 Data Point: (13.1, 1)

TQs 17° (Along Bedding bedding 6°-8°)

Model: Spline Data Point Function
 Function: Modifier Factor vs. Inclination
 Curve Fit to Data: 100 %
 Segment Curvature: 0 %

file:///P:/FINAL%20PROJECTS/PARDEE/Skyline%20Ranch/SLOPE%20RESULTS/Sect... 3/22/2016

Y-Intercept: 1
 Data Points: Inclination (*), Modifier Factor
 Data Point: (-90, 1)
 Data Point: (5.9, 1)
 Data Point: (6, 0.425)
 Data Point: (8, 0.425)
 Data Point: (8.1, 1)

TQs 150 psf (Along Bedding 6°-8°)

Model: Spline Data Point Function
 Function: Modifier Factor vs. Inclination
 Curve Fit to Data: 100 %
 Segment Curvature: 0 %

Y-Intercept: 1
 Data Points: Inclination (*), Modifier Factor
 Data Point: (-90, 1)
 Data Point: (5.9, 1)
 Data Point: (6, 0.667)
 Data Point: (8, 0.667)
 Data Point: (8.1, 1)

TQs 100 psf (Along Bedding 8°-13°)

Model: Spline Data Point Function
 Function: Modifier Factor vs. Inclination
 Curve Fit to Data: 100 %
 Segment Curvature: 0 %

Y-Intercept: 1
 Data Points: Inclination (*), Modifier Factor
 Data Point: (-90, 1)
 Data Point: (7.9, 1)
 Data Point: (8, 0.444)
 Data Point: (13, 0.444)
 Data Point: (13.1, 1)

TQs 25° (Along Bedding bedding 8°-13°) (2)

Model: Spline Data Point Function
 Function: Modifier Factor vs. Inclination
 Curve Fit to Data: 100 %
 Segment Curvature: 0 %

Y-Intercept: 1
 Data Points: Inclination (*), Modifier Factor
 Data Point: (-90, 1)
 Data Point: (7.9, 1)
 Data Point: (8, 0.625)
 Data Point: (13, 0.625)
 Data Point: (13.1, 1)

Points

	X (ft)	Y (ft)
Point 1	-200	1,578
Point 2	-180	1,547
Point 3	-158	1,530
Point 4	-131	1,522
Point 5	-111	1,518
Point 6	-88	1,521
Point 7	-131	1,536
Point 8	-159	1,549
Point 9	-70	1,508
Point 10	-34	1,508
Point 11	14	1,508
Point 12	126	1,494
Point 13	200	1,519
Point 14	253	1,537
Point 15	294	1,550
Point 16	411.0219	1,589.767
Point 17	445.1762	1,601.0103
Point 18	484.351	1,614.0214
Point 19	562.5197	1,640.9884
Point 20	624.593	1,659.8269
Point 21	657.92	1,663.8109
Point 22	810	1,677
Point 23	811	1,300
Point 24	-200	1,299
Point 25	-28	1,521
Point 26	26	1,524
Point 27	40	1,531
Point 28	50	1,531
Point 29	89	1,554

Point 30	102	1,554
Point 31	148	1,575
Point 32	172	1,575
Point 33	225	1,583
Point 34	254	1,595
Point 35	275	1,595
Point 36	318	1,617
Point 37	341	1,618
Point 38	391	1,644
Point 39	399	1,644
Point 40	429	1,660
Point 41	457	1,676
Point 42	469	1,676
Point 43	509	1,697
Point 44	529	1,709
Point 45	580	1,708
Point 46	629	1,710
Point 47	676	1,734
Point 48	692	1,734
Point 49	706	1,742
Point 50	758	1,740
Point 51	810.1075	1,722.407
Point 52	759.6215	1,705.3398
Point 53	714.9876	1,690.9993
Point 54	684.7791	1,680.8166
Point 55	661.1045	1,673.3494
Point 56	640.1453	1,666.1367
Point 57	396.8087	1,584.5342
Point 58	810.0981	1,640
Point 59	26	1,494
Point 60	810	1,740

Regions

Region	Material	Points	Area (ft²)
Region 1	Qts	1,2,3,4,5,6,7,8	1,371.5
Region 2	Tmc 17° bedding 8°-13°	6,5,4,3,2,1,24,23,58,57,15,14,13,12,59,11,10,9	2.6373e+0
Region 3	Fill	6,25,26,27,28,29,30,31,32,33,34,35,36,37,38,39,40,41,42,43,44,45,46,47,48,49,50,60,51,52,53,54,55,56,20,19,18,17,16,57,15,14,13,12,59,11,10,9	45,816
Region 4	TQs 17° bedding 6°-8°	20,21,22,51,52,53,54,55,56	4,213.8
Region 5	TQs 25° bedding 8-13	57,58,22,21,20,19,18,17,16	12,895

Current Slip Surface

Slip Surface: 92,012
 F of S: 1.53
 Volume: 21,423.868 ft³
 Weight: 2,570,864.1 lbs
 Resisting Force: 1,013,450.2 lbs
 Activating Force: 572,319.3 lbs
 F of S Rank (Analysis): 1 of 131,769 slip surfaces
 F of S Rank (Query): 1 of 10 slip surfaces
 Exit: (215.45398, 1,581.5591) ft
 Entry: (575.55492, 1,708.0872) ft
 Radius: 201.1124 ft
 Center: (362.16098, 1,739.7192) ft

Slip Slices

	X (ft)	Y (ft)	PWP (psf)	Base Normal Stress (psf)	Frictional Strength (psf)	Cohesive Strength (psf)
Slice 1	220.22699	1,579.582	0	459.837	298.62164	200
Slice 2	232.25	1,574.602	0	1,728.9179	1,122.7724	200
Slice 3	246.75	1,568.5959	0	3,480.1533	2,260.038	200
Slice 4	259.25	1,563.4182	0	4,672.966	3,034.6596	200
Slice 5	269.75	1,559.0689	0	5,307.356	3,446.6373	200
Slice 6	283.83286	1,553.2356	0	6,817.3872	4,427.263	200
Slice 7	293.33286	1,549.3006	0	8,644.5141	7,253.6086	200
Slice 8	300.075	1,550.2617	0	6,616.3428	2,022.819	150
Slice 9	312.075	1,552.7988	0	7,008.8831	2,142.8306	150

Slice 10	323.75	1,555.3596	0	7,091.6921	2,168.1479	150
Slice 11	335.25	1,557.8821	0	6,859.2735	2,097.0904	150
Slice 12	347.25	1,560.5142	0	6,959.0124	2,127.5836	150
Slice 13	359.75	1,563.2559	0	7,390.9088	2,259.6276	150
Slice 14	372.25	1,565.9977	0	7,822.8052	2,391.6716	150
Slice 15	384.75	1,568.7395	0	8,254.7016	2,523.7155	150
Slice 16	393.90435	1,570.7474	0	8,397.4402	2,567.3551	150
Slice 17	397.90435	1,571.6248	0	8,296.6129	2,536.5291	150
Slice 18	405.01095	1,573.1836	0	8,485.894	2,594.3982	150
Slice 19	420.01095	1,576.4737	0	9,027.1537	2,759.8779	150
Slice 20	437.0881	1,580.2194	0	9,678.7743	2,959.0983	150
Slice 21	451.0881	1,583.2902	0	10,245.241	3,132.2845	150
Slice 22	463	1,585.903	0	10,333.206	3,159.1782	150
Slice 23	476.6755	1,588.9026	0	10,451.577	3,195.3679	150
Slice 24	489.6255	1,591.7431	0	10,906.463	3,334.4404	150
Slice 25	496.75426	1,595.5482	0	6,265.4457	5,257.3332	200
Slice 26	503.80426	1,605.6166	0	5,825.4206	4,888.1083	225
Slice 27	513.26419	1,619.1268	0	5,274.0643	4,425.4654	225
Slice 28	523.26419	1,633.4083	0	5,256.3982	3,413.5449	200
Slice 29	534.81936	1,649.9108	0	4,275.2083	2,776.3528	200
Slice 30	546.45809	1,666.5326	0	3,020.3367	1,961.4296	200
Slice 31	558.09682	1,683.1544	0	1,765.465	1,146.5064	200
Slice 32	569.73555	1,699.7762	0	510.59327	331.58315	200

Section 24 SSA for Skyline Ranch.gsz

Section 24 SSA for Skyline Ranch.gsz Run By: Dr. Alexander Bykovtsev, Ph.D., P.E. 3/22/2016 11:39:33 AM

- Materials**
- TQs 17° bedding 6°-8°
 - Qls
 - TQs 25° bedding 8-13
 - Fill
 - Tmc 17° bedding 8°-13°

Name: TQs 17° bedding 6°-8°
 Model: Anisotropic Fn.
 Unit Weight: 120 pcf
 Cohesion: 225 psf
 Phi: 40°
 Phi-Anisotropic Strength Fn.: TQs 17° (Along Bedding bedding 6°-8°)
 C-Anisotropic Strength Fn.: TQs 150 psf (Along Bedding 6°-8°)

Name: Qls
 Model: Mohr-Coulomb
 Unit Weight: 100 pcf
 Cohesion: 150 psf
 Phi: 20°

Name: TQs 25° bedding 8-13
 Model: Anisotropic Fn.
 Unit Weight: 120 pcf
 Cohesion: 225 psf
 Phi: 40°
 Phi-Anisotropic Strength Fn.: TQs 25° (Along Bedding bedding 8°-13°) (2)
 C-Anisotropic Strength Fn.: TQs 100 psf (Along Bedding 8°-13°)

Name: Fill
 Model: Mohr-Coulomb
 Unit Weight: 120 pcf
 Cohesion: 200 psf
 Phi: 33°

Name: Tmc 17° bedding 8°-13°
 Model: Anisotropic Fn.
 Unit Weight: 120 pcf
 Cohesion: 200 psf
 Phi: 40°
 Phi-Anisotropic Strength Fn.: Tmc 17° (Along Bedding bedding 8°-13°)
 C-Anisotropic Strength Fn.: Tmc 150 psf (Along Bedding 8°-13°)

1.31

Pseudostatic - Translational

Seismic Loads
 Horizontal: 0.15
 Vertical: 0.0

Keyway 30' Deep by 100' Wide
 3H:1V Backcut

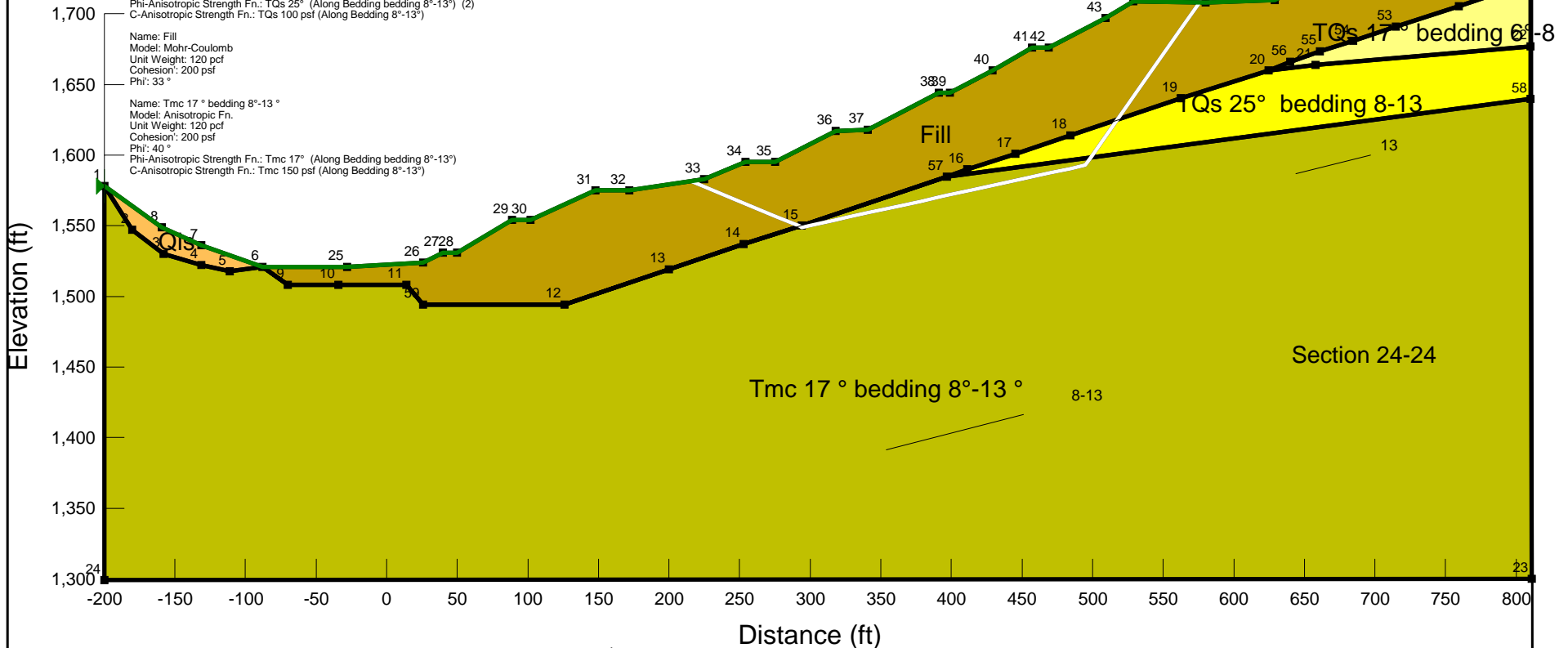

LGC **LGC Valley, Inc**
 GEOTECHNICAL CONSULTING
 28532 Constellation Road, Valencia, CA 91355
 Phone 661-702-8474, Fax 661-702-8475

Skyline Ranch
 Development project, Tract 60922
 Los Angeles CA

Project No: **153035-01**
 Engineer: **BAS**
 Date: **March 2016**

2 - Translational Seismic

Report generated using GeoStudio 2012. Copyright © 1991-2016 GEO-SLOPE International Ltd.

File Information

File Version: 8.15
 Title: Static Slope Stability Analyses for Skyline Ranch Development project, Tract 60922, Los Angeles CA
 Comments: Run By: Dr. Alexander Bykovtsev, Ph.D., P.E.
 Last Edited By: Alexander Bykovtsev
 Revision Number: 145
 Date: 3/22/2016
 Time: 11:39:33 AM
 Tool Version: 8.15.5.11777
 File Name: Section 24 SSA for Skyline Ranch.gsz
 Directory: P:\FINAL PROJECTS\PARDEE\Skyline Ranch\SLOPE RESULTS\Section 24-24 results\latest update 3-21-16\
 Last Solved Date: 3/22/2016
 Last Solved Time: 11:40:30 AM

Project Settings

Length(L) Units: Feet
 Time(t) Units: Seconds
 Force(F) Units: Pounds
 Pressure(p) Units: psf
 Strength Units: psf
 Unit Weight of Water: 62.4 pcf
 View: 2D
 Element Thickness: 1

Analysis Settings

2 - Translational Seismic

Kind: SLOPE/W
 Parent: 2 - Translational
 Method: Spencer
 Settings
 PWP Conditions Source: (none)
 Initial Slip Surface Source: Parent Analysis
 Slip Surface
 Direction of movement: Right to Left
 Use Passive Mode: No
 Slip Surface Option: Critical Slip Surfaces from Other
 Critical slip surfaces saved: 1
 Resisting Side Maximum Convex Angle: 1 °
 Driving Side Maximum Convex Angle: 5 °
 Optimize Critical Slip Surface Location: No
 Tension Crack
 Tension Crack Option: (none)
 F of S Distribution
 F of S Calculation Option: Constant
 Advanced
 Number of Slices: 30
 F of S Tolerance: 0.01
 Minimum Slip Surface Depth: 0.1 ft
 Search Method: Root Finder
 Tolerable difference between starting and converged F of S: 3
 Maximum iterations to calculate converged lambda: 20
 Max Absolute Lambda: 2

Materials

TQs 17 ° bedding 6°-8 °

Model: Anisotropic Fn.
 Unit Weight: 120 pcf
 Cohesion: 225 psf
 Phi: 40 °
 Phi-Anisotropic Strength Fn.: TQs 17° (Along Bedding bedding 6°-8°)
 C-Anisotropic Strength Fn.: TQs 150 psf (Along Bedding 6°-8°)
 Phi-B: 0 °

QIs

Model: Mohr-Coulomb
 Unit Weight: 100 pcf
 Cohesion: 150 psf
 Phi: 20 °
 Phi-B: 0 °

TQs 25° bedding 8-13

Model: Anisotropic Fn.

file:///P:/FINAL%20PROJECTS/PARDEE/Skyline%20Ranch/SLOPE%20RESULTS/Sect... 3/22/2016

Unit Weight: 120 pcf
 Cohesion: 225 psf
 Phi: 40 °
 Phi-Anisotropic Strength Fn.: TQs 25° (Along Bedding bedding 8°-13°) (2)
 C-Anisotropic Strength Fn.: TQs 100 psf (Along Bedding 8°-13°)
 Phi-B: 0 °

Fill

Model: Mohr-Coulomb
 Unit Weight: 120 pcf
 Cohesion: 200 psf
 Phi: 33 °
 Phi-B: 0 °

Tmc 17 ° bedding 8°-13 °

Model: Anisotropic Fn.
 Unit Weight: 120 pcf
 Cohesion: 200 psf
 Phi: 40 °
 Phi-Anisotropic Strength Fn.: Tmc 17° (Along Bedding bedding 8°-13°)
 C-Anisotropic Strength Fn.: Tmc 150 psf (Along Bedding 8°-13°)
 Phi-B: 0 °

Slip Surface Limits

Left Coordinate: (-200, 1.578) ft
 Right Coordinate: (810.1075, 1.722.407) ft

Seismic Coefficients

Horz Seismic Coef.: 0.15
 Vert Seismic Coef.: 0

Anisotropic Strength Functions

Tmc 17° (Along Bedding bedding 8°-13°)

Model: Spline Data Point Function
 Function: Modifier Factor vs. Inclination
 Curve Fit to Data: 100 %
 Segment Curvature: 0 %
 Y-intercept: 1
 Data Points: Inclination (°), Modifier Factor
 Data Point: (-90, 1)
 Data Point: (7.9, 1)
 Data Point: (8, 0.425)
 Data Point: (13, 0.425)
 Data Point: (13.1, 1)

Tmc 150 psf (Along Bedding 8°-13°)

Model: Spline Data Point Function
 Function: Modifier Factor vs. Inclination
 Curve Fit to Data: 100 %
 Segment Curvature: 0 %
 Y-intercept: 1
 Data Points: Inclination (°), Modifier Factor
 Data Point: (-90, 1)
 Data Point: (7.9, 1)
 Data Point: (8, 0.75)
 Data Point: (13, 0.75)
 Data Point: (13.1, 1)

TQs 17° (Along Bedding bedding 6°-8°)

Model: Spline Data Point Function
 Function: Modifier Factor vs. Inclination
 Curve Fit to Data: 100 %
 Segment Curvature: 0 %
 Y-intercept: 1
 Data Points: Inclination (°), Modifier Factor
 Data Point: (-90, 1)
 Data Point: (5.9, 1)
 Data Point: (6, 0.425)
 Data Point: (8, 0.425)
 Data Point: (8.1, 1)

TQs 150 psf (Along Bedding 6°-8°)

Model: Spline Data Point Function
 Function: Modifier Factor vs. Inclination
 Curve Fit to Data: 100 %
 Segment Curvature: 0 %
 Y-intercept: 1
 Data Points: Inclination (°), Modifier Factor
 Data Point: (-90, 1)

file:///P:/FINAL%20PROJECTS/PARDEE/Skyline%20Ranch/SLOPE%20RESULTS/Sect... 3/22/2016

Data Point: (5.9, 1)
 Data Point: (6, 0.667)
 Data Point: (8, 0.667)
 Data Point: (8.1, 1)

TQs 100 psf (Along Bedding 8°-13°)

Model: Spline Data Point Function
 Function: Modifier Factor vs. Inclination
 Curve Fit to Data: 100 %
 Segment Curvature: 0 %

Y-Intercept: 1
 Data Points: Inclination (*), Modifier Factor
 Data Point: (-90, 1)
 Data Point: (7.9, 1)
 Data Point: (8, 0.444)
 Data Point: (13, 0.444)
 Data Point: (13.1, 1)

TQs 25° (Along Bedding bedding 8°-13°) (2)

Model: Spline Data Point Function
 Function: Modifier Factor vs. Inclination
 Curve Fit to Data: 100 %
 Segment Curvature: 0 %

Y-Intercept: 1
 Data Points: Inclination (*), Modifier Factor
 Data Point: (-90, 1)
 Data Point: (7.9, 1)
 Data Point: (8, 0.625)
 Data Point: (13, 0.625)
 Data Point: (13.1, 1)

Points

	X (ft)	Y (ft)
Point 1	-200	1,578
Point 2	-180	1,547
Point 3	-158	1,530
Point 4	-131	1,522
Point 5	-111	1,518
Point 6	-88	1,521
Point 7	-131	1,536
Point 8	-159	1,549
Point 9	-70	1,508
Point 10	-34	1,508
Point 11	14	1,508
Point 12	126	1,494
Point 13	200	1,519
Point 14	253	1,537
Point 15	294	1,550
Point 16	411.0219	1,589.767
Point 17	445.1762	1,601.0103
Point 18	484.351	1,614.0214
Point 19	562.5197	1,640.3984
Point 20	624.593	1,659.8269
Point 21	657.92	1,663.8109
Point 22	810	1,677
Point 23	811	1,300
Point 24	-200	1,299
Point 25	-28	1,521
Point 26	26	1,524
Point 27	40	1,531
Point 28	50	1,531
Point 29	89	1,554
Point 30	102	1,554
Point 31	148	1,575
Point 32	172	1,575
Point 33	225	1,583
Point 34	254	1,595
Point 35	275	1,595
Point 36	318	1,617
Point 37	341	1,618
Point 38	391	1,644
Point 39	399	1,644
Point 40	429	1,660
Point 41	457	1,676
Point 42	469	1,676
Point 43	509	1,697

Point 44	529	1,709
Point 45	580	1,708
Point 46	629	1,710
Point 47	676	1,734
Point 48	692	1,734
Point 49	706	1,742
Point 50	758	1,740
Point 51	810.1075	1,722.407
Point 52	759.6215	1,705.3398
Point 53	714.9876	1,690.9993
Point 54	684.7791	1,680.8166
Point 55	661.1045	1,673.3494
Point 56	640.1453	1,666.1367
Point 57	396.8087	1,584.5342
Point 58	810.0981	1,640
Point 59	26	1,494
Point 60	810	1,740

Regions

Region	Material	Points	Area (ft²)
Region 1	Qts	1,2,3,4,5,6,7,8	1,371.5
Region 2	Tmc 17 * bedding 8°-13 *	6,5,4,3,2,1,24,23,58,57,15,14,13,12,59,11,10,9	2.6373e+08
Region 3	Fill	6,25,26,27,28,29,30,31,32,33,34,35,36,37,38,39,40,41,42,43,44,45,46,47,48,49,50,60,51,52,53,54,55,56,20,19,18,17,16,57,15,14,13,12,59,11,10,9	45,816
Region 4	TQs 17 * bedding 6°-8 *	20,21,22,51,52,53,54,55,56	4,213.8
Region 5	TQs 25 * bedding 8-13	57,58,22,21,20,19,18,17,16	12,895

Current Slip Surface

Slip Surface: 1
 F of S: 1.31
 Volume: 21,423.868 ft³
 Weight: 2,570,864.1 lbs
 Resisting Moment: 2.3756949e+008 lbs-ft
 Activating Moment: 1.8204325e+008 lbs-ft
 Resisting Force: 1,090,319.1 lbs
 Activating Force: 833,706.69 lbs
 F of S Rank (Analysis): 1 of 1 slip surfaces
 F of S Rank (Query): 1 of 1 slip surfaces
 Exit: (215.45398, 1,581.5591) ft
 Entry: (575.55492, 1,708.0872) ft
 Radius: 201.1124 ft
 Center: (362.16098, 1,739.7192) ft

Slip Slices

	X (ft)	Y (ft)	PWP (psf)	Base Normal Stress (psf)	Frictional Strength (psf)	Cohesive Strength (psf)
Slice 1	220.22699	1,579.582	0	941.7653	611.58954	200
Slice 2	232.25	1,574.602	0	3,109.7593	2,019.5013	200
Slice 3	246.75	1,568.5959	0	6,101.4255	3,962.3121	200
Slice 4	259.25	1,563.4182	0	8,139.1302	5,285.613	200
Slice 5	269.75	1,559.0689	0	9,222.8686	5,989.4009	200
Slice 6	283.83286	1,553.2356	0	11,802.483	7,664.622	200
Slice 7	293.33286	1,549.3006	0	18,029.3	15,128.379	200
Slice 8	300.075	1,550.2617	0	6,305.105	1,927.6641	150
Slice 9	312.075	1,552.7988	0	6,634.9871	2,028.5191	150
Slice 10	323.75	1,555.3596	0	6,712.9417	2,052.3523	150
Slice 11	335.25	1,557.8821	0	6,494.1489	1,985.4606	150
Slice 12	347.25	1,560.5142	0	6,588.0404	2,014.1661	150
Slice 13	359.75	1,563.2559	0	6,994.6158	2,138.4686	150
Slice 14	372.25	1,565.9977	0	7,401.1915	2,262.7713	150
Slice 15	384.75	1,568.7395	0	7,807.7666	2,387.0738	150
Slice 16	393.90435	1,570.7474	0	7,942.1368	2,428.1549	150
Slice 17	397.90435	1,571.6248	0	7,847.221	2,399.1362	150
Slice 18	405.01095	1,573.1836	0	8,025.4051	2,453.6126	150
Slice 19	420.01095	1,576.4737	0	8,534.932	2,609.3906	150
Slice 20	437.0881	1,580.2194	0	9,148.3497	2,796.9312	150
Slice 21	451.0881	1,583.2902	0	9,681.6062	2,959.9641	150
Slice 22	463	1,585.903	0	9,764.4142	2,985.281	150

Slice 23	476.6755	1,588.9026	0	9,875.8453	3,019.3489	150
Slice 24	489.6255	1,591.7431	0	10,304.063	3,150.2681	150
Slice 25	496.75426	1,595.5482	0	4,805.3658	4,032.1807	200
Slice 26	503.80426	1,605.6166	0	4,469.5552	3,750.4021	225
Slice 27	513.26419	1,619.1268	0	4,047.4391	3,396.2047	225
Slice 28	523.26419	1,633.4083	0	3,908.4458	2,538.1744	200
Slice 29	534.81936	1,649.9108	0	3,180.6244	2,065.5216	200
Slice 30	546.45809	1,666.5326	0	2,249.7927	1,461.0325	200
Slice 31	558.09682	1,683.1544	0	1,318.9611	856.54333	200
Slice 32	569.73555	1,699.7762	0	388.12944	252.05421	200

Section 24 SSA for Skyline Ranch.gsz

Section 24 SSA for Skyline Ranch.gsz Run By: Dr. Alexander Bykovtsev, Ph.D., P.E. 3/22/2016 11:58:10 AM

Materials

- TQs 17° bedding 6°-8°
- Qls
- TQs 25° bedding 8-13
- Tmc 17° bedding 8°-13°

Static- Translational - Temporary 3H:1V Backcut

Name: TQs 17° bedding 6°-8°
 Model: Anisotropic Fn.
 Unit Weight: 120 pcf
 Cohesion: 225 psf
 Phi: 40°
 Phi-Anisotropic Strength Fn.: TQs 17° (Along Bedding bedding 6°-8°)
 C-Anisotropic Strength Fn.: TQs 150 psf (Along Bedding 6°-8°)

Name: Qls
 Model: Mohr-Coulomb
 Unit Weight: 100 pcf
 Cohesion: 150 psf
 Phi: 20°

Name: TQs 25° bedding 8-13
 Model: Anisotropic Fn.
 Unit Weight: 120 pcf
 Cohesion: 225 psf
 Phi: 40°
 Phi-Anisotropic Strength Fn.: TQs 25° (Along Bedding bedding 8°-13°) (2)
 C-Anisotropic Strength Fn.: TQs 100 psf (Along Bedding 8°-13°)

Name: Tmc 17° bedding 8°-13°
 Model: Anisotropic Fn.
 Unit Weight: 120 pcf
 Cohesion: 200 psf
 Phi: 40°
 Phi-Anisotropic Strength Fn.: Tmc 17° (Along Bedding bedding 8°-13°)
 C-Anisotropic Strength Fn.: Tmc 150 psf (Along Bedding 8°-13°)

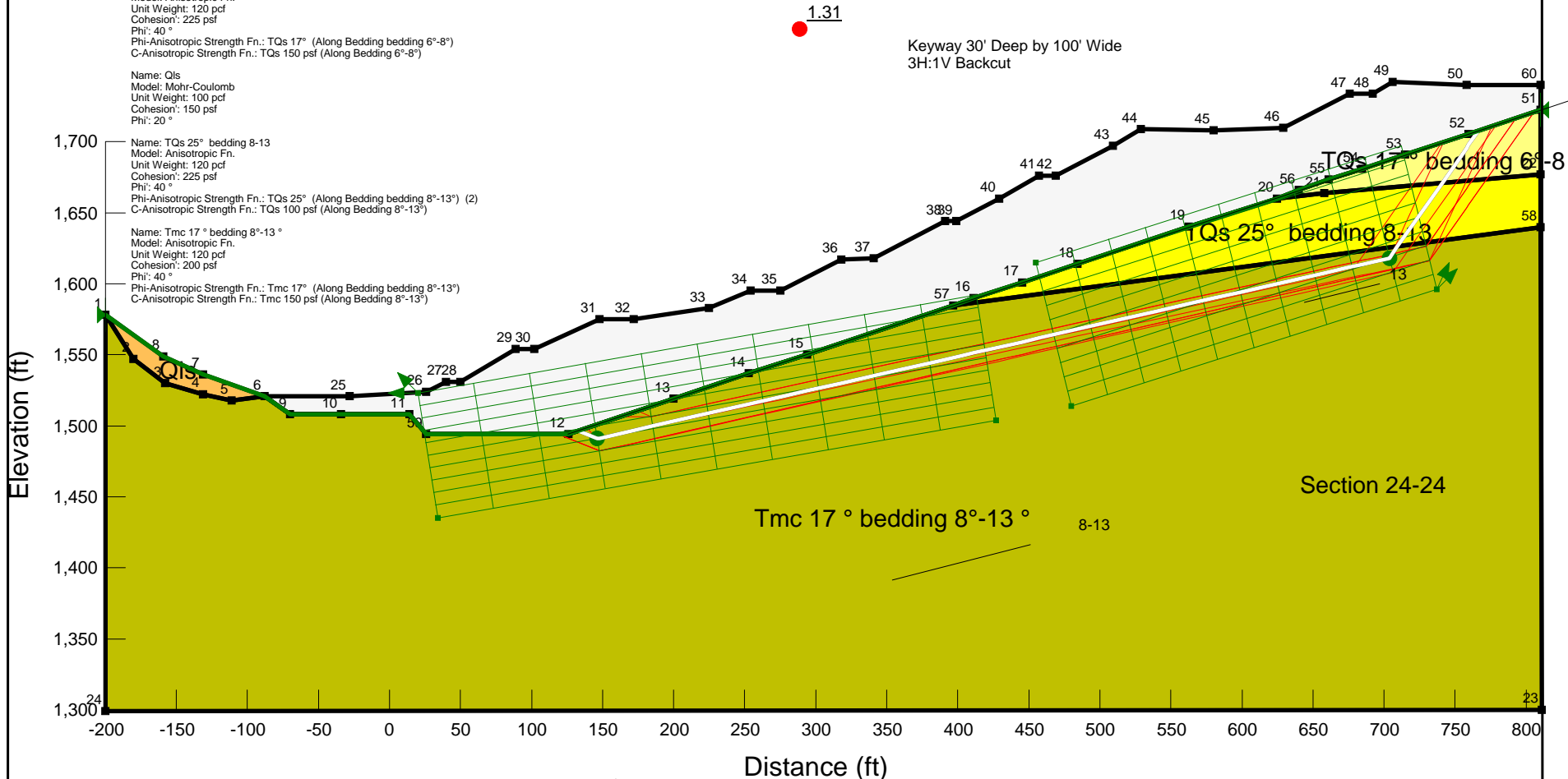

LGC **LGC Valley, Inc**
 GEOTECHNICAL CONSULTING
 28532 Constellation Road, Valencia, CA 91355
 Phone 661-702-8474, Fax 661-702-8475

Skyline Ranch
 Development project, Tract 60922
 Los Angeles CA

Project No: **153035-01**
 Engineer: **BAS**
 Date: **March 2016**

3 - Temporary

Report generated using GeoStudio 2012. Copyright © 1991-2016 GEO-SLOPE International Ltd.

File Information

File Version: 8.15
 Title: Static Slope Stability Analyses for Skyline Ranch Development project, Tract 60922, Los Angeles CA
 Comments: Run By: Dr. Alexander Bykovtsev, Ph.D., P.E.
 Last Edited By: Alexander Bykovtsev
 Revision Number: 147
 Date: 3/22/2016
 Time: 11:58:10 AM
 Tool Version: 8.15.5.11777
 File Name: Section 24 SSA for Skyline Ranch.gsz
 Directory: P:\FINAL PROJECTS\PARDEE\Skyline Ranch\SLOPE RESULTS\Section 24-24 results\latest update 3-21-16\
 Last Solved Date: 3/22/2016
 Last Solved Time: 11:58:37 AM

Project Settings

Length(L) Units: Feet
 Time(t) Units: Seconds
 Force(F) Units: Pounds
 Pressure(p) Units: psf
 Strength Units: psf
 Unit Weight of Water: 62.4 pcf
 View: 2D
 Element Thickness: 1

Analysis Settings

3 - Temporary

Kind: SLOPE/W
 Method: Janbu
 Settings
 PWP Conditions Source: (none)
 Slip Surface
 Direction of movement: Right to Left
 Use Passive Mode: No
 Slip Surface Option: Block
 Critical slip surfaces saved: 10
 Resisting Side Maximum Convex Angle: 1 °
 Driving Side Maximum Convex Angle: 5 °
 Restrict Block Crossing: No
 Optimize Critical Slip Surface Location: No
 Tension Crack
 Tension Crack Option: (none)
 F of S Distribution
 F of S Calculation Option: Constant
 Advanced
 Number of Slices: 30
 F of S Tolerance: 0.01
 Minimum Slip Surface Depth: 0.1 ft

Materials

TQs 17 ° bedding 6°-8 °

Model: Anisotropic Fn.
 Unit Weight: 120 pcf
 Cohesion: 225 psf
 Phi: 40 °
 Phi-Anisotropic Strength Fn.: TQs 17° (Along Bedding bedding 6°-8°)
 C-Anisotropic Strength Fn.: TQs 150 psf (Along Bedding 6°-8°)
 Phi-B: 0 °

QIs

Model: Mohr-Coulomb
 Unit Weight: 100 pcf
 Cohesion: 150 psf
 Phi: 20 °
 Phi-B: 0 °

TQs 25° bedding 8-13

Model: Anisotropic Fn.
 Unit Weight: 120 pcf
 Cohesion: 225 psf
 Phi: 40 °
 Phi-Anisotropic Strength Fn.: TQs 25° (Along Bedding bedding 8°-13°) (2)
 C-Anisotropic Strength Fn.: TQs 100 psf (Along Bedding 8°-13°)

file:///P:/FINAL%20PROJECTS/PARDEE/Skyline%20Ranch/SLOPE%20RESULTS/Sect... 3/22/2016

Phi-B: 0 °

Tmc 17 ° bedding 8°-13 °

Model: Anisotropic Fn.
 Unit Weight: 120 pcf
 Cohesion: 200 psf
 Phi: 40 °
 Phi-Anisotropic Strength Fn.: Tmc 17° (Along Bedding bedding 8°-13°)
 C-Anisotropic Strength Fn.: Tmc 150 psf (Along Bedding 8°-13°)
 Phi-B: 0 °

Slip Surface Limits

Left Coordinate: (-200, 1,578) ft
 Right Coordinate: (810,1075, 1,722,407) ft

Slip Surface Block

Left Grid
 Upper Left: (20, 1,523) ft
 Lower Left: (34, 1,435) ft
 Lower Right: (427, 1,504) ft
 X Increments: 10
 Y Increments: 10
 Starting Angle: 135 °
 Ending Angle: 180 °
 Angle Increments: 2
 Right Grid
 Upper Left: (455, 1,615) ft
 Lower Left: (480, 1,514) ft
 Lower Right: (737, 1,596) ft
 X Increments: 10
 Y Increments: 10
 Starting Angle: 45 °
 Ending Angle: 65 °
 Angle Increments: 2

Seismic Coefficients

Horz Seismic Coef.: 0
 Vert Seismic Coef.: 0

Anisotropic Strength Functions

Tmc 17° (Along Bedding bedding 8°-13°)

Model: Spline Data Point Function
 Function: Modifier Factor vs. Inclination
 Curve Fit to Data: 100 %
 Segment Curvature: 0 %
 Y-Intercept: 1
 Data Points: Inclination (?), Modifier Factor
 Data Point: (-90, 1)
 Data Point: (7.9, 1)
 Data Point: (8, 0,425)
 Data Point: (13, 0,425)
 Data Point: (13.1, 1)

Tmc 150 psf (Along Bedding 8°-13°)

Model: Spline Data Point Function
 Function: Modifier Factor vs. Inclination
 Curve Fit to Data: 100 %
 Segment Curvature: 0 %
 Y-Intercept: 1
 Data Points: Inclination (?), Modifier Factor
 Data Point: (-90, 1)
 Data Point: (7.9, 1)
 Data Point: (8, 0,75)
 Data Point: (13, 0,75)
 Data Point: (13.1, 1)

TQs 17° (Along Bedding bedding 6°-8°)

Model: Spline Data Point Function
 Function: Modifier Factor vs. Inclination
 Curve Fit to Data: 100 %
 Segment Curvature: 0 %
 Y-Intercept: 1
 Data Points: Inclination (?), Modifier Factor
 Data Point: (-90, 1)
 Data Point: (5.9, 1)
 Data Point: (6, 0,425)
 Data Point: (8, 0,425)
 Data Point: (8.1, 1)

file:///P:/FINAL%20PROJECTS/PARDEE/Skyline%20Ranch/SLOPE%20RESULTS/Sect... 3/22/2016

TQs 150 psf (Along Bedding 6°-8°)

Model: Spline Data Point Function
 Function: Modifier Factor vs. Inclination
 Curve Fit to Data: 100 %
 Segment Curvature: 0 %
 Y-Intercept: 1
 Data Points: Inclination (°), Modifier Factor
 Data Point: (-90, 1)
 Data Point: (5.9, 1)
 Data Point: (6, 0.667)
 Data Point: (8, 0.667)
 Data Point: (8.1, 1)

TQs 100 psf (Along Bedding 8°-13°)

Model: Spline Data Point Function
 Function: Modifier Factor vs. Inclination
 Curve Fit to Data: 100 %
 Segment Curvature: 0 %
 Y-Intercept: 1
 Data Points: Inclination (°), Modifier Factor
 Data Point: (-90, 1)
 Data Point: (7.9, 1)
 Data Point: (8, 0.444)
 Data Point: (13, 0.444)
 Data Point: (13.1, 1)

TQs 25° (Along Bedding bedding 8°-13°) (2)

Model: Spline Data Point Function
 Function: Modifier Factor vs. Inclination
 Curve Fit to Data: 100 %
 Segment Curvature: 0 %
 Y-Intercept: 1
 Data Points: Inclination (°), Modifier Factor
 Data Point: (-90, 1)
 Data Point: (7.9, 1)
 Data Point: (8, 0.625)
 Data Point: (13, 0.625)
 Data Point: (13.1, 1)

Points

	X (ft)	Y (ft)
Point 1	-200	1,578
Point 2	-180	1,547
Point 3	-158	1,530
Point 4	-131	1,522
Point 5	-111	1,518
Point 6	-88	1,521
Point 7	-131	1,536
Point 8	-159	1,549
Point 9	-70	1,508
Point 10	-34	1,508
Point 11	14	1,508
Point 12	126	1,494
Point 13	200	1,519
Point 14	253	1,537
Point 15	294	1,550
Point 16	411.0219	1,589.767
Point 17	445.1762	1,601.0103
Point 18	484.351	1,614.0214
Point 19	562.5197	1,640.3984
Point 20	624.593	1,659.8269
Point 21	657.92	1,663.8109
Point 22	810	1,677
Point 23	811	1,300
Point 24	-200	1,299
Point 25	-28	1,521
Point 26	26	1,524
Point 27	40	1,531
Point 28	50	1,531
Point 29	89	1,554
Point 30	102	1,554
Point 31	148	1,575
Point 32	172	1,575
Point 33	225	1,583
Point 34	254	1,595
Point 35	275	1,595

Point 36	318	1,617
Point 37	341	1,618
Point 38	391	1,644
Point 39	399	1,644
Point 40	429	1,660
Point 41	457	1,676
Point 42	469	1,676
Point 43	509	1,697
Point 44	529	1,709
Point 45	580	1,708
Point 46	629	1,710
Point 47	676	1,734
Point 48	692	1,734
Point 49	706	1,742
Point 50	758	1,740
Point 51	810.1075	1,722.407
Point 52	759.6215	1,705.3398
Point 53	714.9876	1,690.9993
Point 54	684.7791	1,680.8166
Point 55	661.1045	1,673.3494
Point 56	640.1453	1,666.1367
Point 57	396.8087	1,584.5342
Point 58	810.0981	1,640
Point 59	26	1,494
Point 60	810	1,740

Regions

Region	Material	Points	Area (ft ²)
Region 1	Qts	1,2,3,4,5,6,7,8	1,371.5
Region 2	Tmc 17° bedding 8°-13°	6,5,4,3,2,1,24,23,58,57,15,14,13,12,59,11,10,9	2.6373e+08
Region 3		6,25,26,27,28,29,30,31,32,33,34,35,36,37,38,39,40,41,42,43,44,45,46,47,48,49,50,60,51,52,53,54,55,56,20,19,18,17,16,57,15,14,13,12,59,11,10,9	45,816
Region 4	TQs 17° bedding 6°-8°	20,21,22,51,52,53,54,55,56	4,213.8
Region 5	TQs 25° bedding 8-13	57,58,22,21,20,19,18,17,16	12,895

Current Slip Surface

Slip Surface: 51.674
 F of S: 1.31
 Volume: 24,323.061 ft³
 Weight: 2,918,767.3 lbs
 Resisting Force: 982,441.72 lbs
 Activating Force: 748,405.93 lbs
 F of S Rank (Analysis): 1 of 131,769 slip surfaces
 F of S Rank (Query): 1 of 10 slip surfaces
 Ext: (133.05874, 1,496.3847) ft
 Entry: (766.51858, 1,707.6714) ft
 Radius: 317.96151 ft
 Center: (396.93361, 1,760.49311) ft

Slip Slices

	X (ft)	Y (ft)	PWP (psf)	Base Normal Stress (psf)	Frictional Strength (psf)	Cohesive Strength (psf)
Slice 1	139.67937	1,493.6424	0	900.80999	755.86933	200
Slice 2	147.15	1,491.0939	0	1,120.0839	342.44402	150
Slice 3	160	1,494.0258	0	1,280.6256	391.52654	150
Slice 4	186	1,499.958	0	1,605.4571	490.83749	150
Slice 5	212.5	1,506.0043	0	1,939.0767	592.83524	150
Slice 6	239	1,512.0506	0	2,275.5427	695.70321	150
Slice 7	264	1,517.7546	0	2,564.7081	784.10994	150
Slice 8	284.5	1,522.4319	0	2,772.3354	847.58799	150
Slice 9	306	1,527.3374	0	3,015.8363	922.03368	150
Slice 10	329.5	1,532.6992	0	3,304.2662	1,010.2156	150
Slice 11	353.5	1,538.175	0	3,598.8329	1,100.2736	150
Slice 12	378.5	1,543.8791	0	3,905.6732	1,194.0841	150
Slice 13	393.90435	1,547.3938	0	4,094.7403	1,251.8877	150
Slice 14	397.90435	1,548.3064	0	4,147.8607	1,268.1283	150
Slice 15	405.01095	1,549.9279	0	4,261.1978	1,302.7789	150

Slice 16	420.01095	1,553.3503	0	4,460.5124	1,363.7155	150
Slice 17	437.0881	1,557.2466	0	4,657.046	1,423.8019	150
Slice 18	451.0881	1,560.4409	0	4,820.1446	1,473.6661	150
Slice 19	463	1,563.1587	0	4,961.2202	1,516.7972	150
Slice 20	476.6755	1,566.2789	0	5,123.1825	1,566.3141	150
Slice 21	496.6755	1,570.8422	0	5,367.4988	1,641.0091	150
Slice 22	519	1,575.9358	0	5,645.3906	1,725.9691	150
Slice 23	537.37992	1,580.1294	0	5,874.1809	1,795.9173	150
Slice 24	554.13977	1,583.9533	0	6,082.8049	1,859.7001	150
Slice 25	571.25985	1,587.8594	0	6,271.5761	1,917.4132	150
Slice 26	591.14825	1,592.3972	0	6,463.7649	1,976.1713	150
Slice 27	613.44475	1,597.4844	0	6,679.2241	2,042.0437	150
Slice 28	626.7965	1,600.5308	0	6,831.5208	2,088.6055	150
Slice 29	634.57265	1,602.305	0	6,988.7978	2,136.6899	150
Slice 30	649.03265	1,605.6042	0	7,218.9127	2,207.0431	150
Slice 31	659.51225	1,607.9952	0	7,357.3516	2,249.3681	150
Slice 32	668.55225	1,610.0578	0	7,452.4066	2,278.4293	150
Slice 33	680.38955	1,612.7586	0	7,570.0537	2,314.3977	150
Slice 34	688.38955	1,614.5839	0	7,658.4758	2,341.431	150
Slice 35	697.9	1,616.7538	0	7,776.4745	2,377.5068	150
Slice 36	704.9	1,619.671	0	4,135.7154	3,470.2772	200
Slice 37	707.84997	1,623.884	0	3,934.348	3,301.31	200
Slice 38	712.34377	1,630.3018	0	3,613.3373	3,031.95	225
Slice 39	727.91511	1,652.5399	0	2,537.6559	2,129.3462	225
Slice 40	749.42131	1,683.254	0	1,048.3822	879.69714	225
Slice 41	758.81075	1,696.6635	0	398.17687	334.11007	225
Slice 42	763.07004	1,702.7464	0	106.84454	89.653215	225

Section 28 SSA for Skyline Ranch.gsz

Section 28-28'

Section 28 SSA for Skyline Ranch.gsz Run By: Dr. Alexander Bykovtsev, Ph.D., P.E. 3/22/2016 3:34:50 PM

Name: Tmc - 17 bedding 6-12
 Model: Anisotropic Fn.
 Unit Weight: 120 pcf
 Cohesion: 200 psf
 Phi: 40 °
 Phi-Anisotropic Strength Fn.: Tmc 17° (Along Bedding 6-12°)
 C-Anisotropic Strength Fn.: Tmc 150 psf (Along Bedding 6-12°)

Static - Circular

Materials

- Tmc - 17 bedding 6-12
- TQs-17 bedding 8-12
- Fill

Name: TQs-17 bedding 8-12
 Model: Anisotropic Fn.
 Unit Weight: 120 pcf
 Cohesion: 225 psf
 Phi: 40 °
 Phi-Anisotropic Strength Fn.: 17° (Along Bedding 8-12°)
 C-Anisotropic Strength Fn.: 150 psf (Along Bedding 8-12°)

Keyway 10' Deep by 55' wide
 2H:1V Backcut

Name: Fill
 Model: Mohr-Coulomb
 Unit Weight: 120 pcf
 Cohesion: 200 psf
 Phi: 33 °

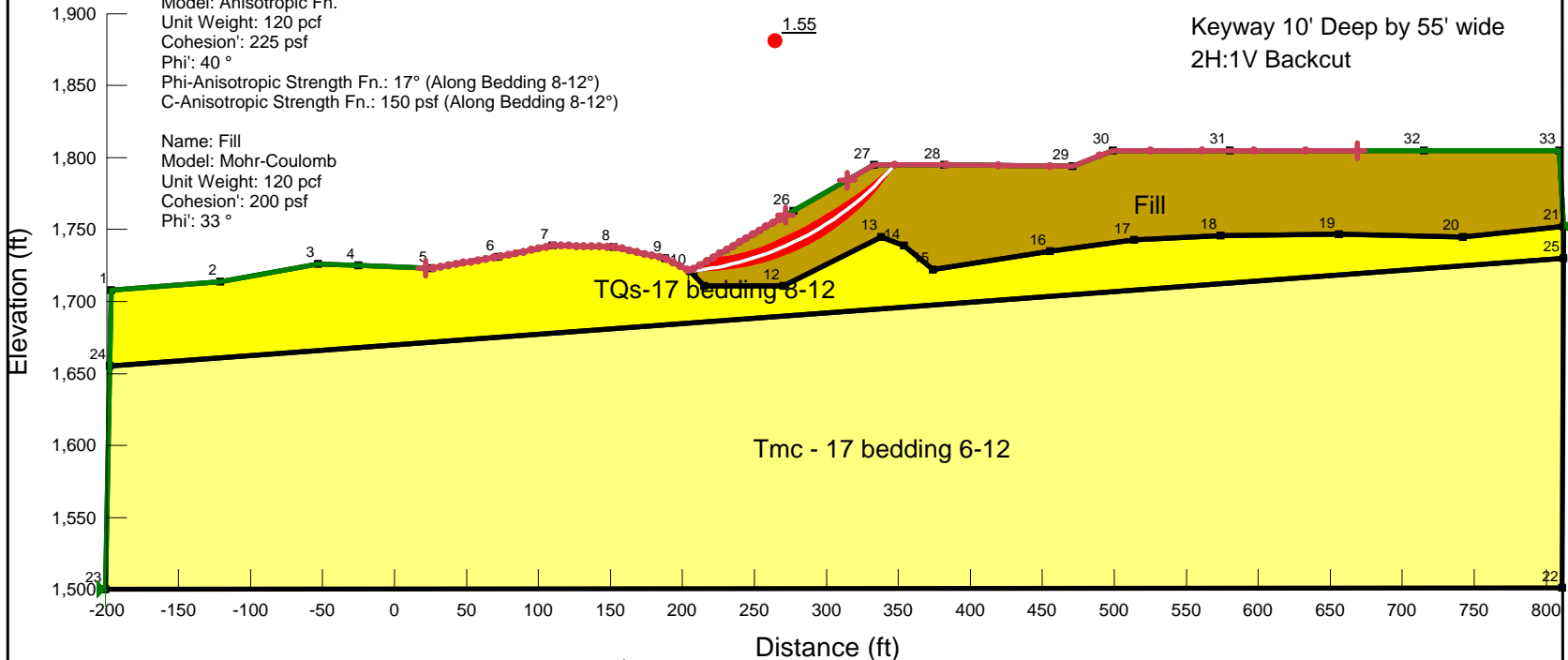

	<p>LGC Valley, Inc GEOTECHNICAL CONSULTING 28532 Constellation Road, Valencia, CA 91355 Phone 661-702-8474, Fax 661-702-8475</p>	<p>Skyline Ranch Development project, Tract 60922 Los Angeles CA</p>	<p>Project No: 153035-01 Engineer: BAS Date: March 2016</p>
--	--	---	--

1 - Circular Mode of Failure

Report generated using GeoStudio 2012. Copyright © 1991-2016 GEO-SLOPE International Ltd.

File Information

File Version: 8.15
 Title: Static Slope Stability Analyses for Skyline Ranch Development project, Tract 60922, Los Angeles CA
 Comments: Run By: Dr. Alexander Bykovtsev, Ph.D., P.E.
 Last Edited By: Alexander Bykovtsev
 Revision Number: 168
 Date: 3/22/2016
 Time: 3:34:50 PM
 Tool Version: 8.15.5.11777
 File Name: Section 28 SSA for Skyline Ranch.gsz
 Directory: P:\FINAL PROJECTS\PARDEE\Skyline Ranch\SLOPE RESULTS\Section 28-28 results\latest Update 3-21-16\
 Last Solved Date: 3/22/2016
 Last Solved Time: 3:35:16 PM

Project Settings

Length(L) Units: Feet
 Time(t) Units: Seconds
 Force(F) Units: Pounds
 Pressure(p) Units: psf
 Strength Units: psf
 Unit Weight of Water: 62.4 pcf
 View: 2D
 Element Thickness: 1

Analysis Settings

1 - Circular Mode of Failure

Kind: SLOPE/W
 Method: Bishop
 Settings
 PWP Conditions Source: (none)
 Slip Surface
 Direction of movement: Right to Left
 Use Passive Mode: No
 Slip Surface Option: Entry and Exit
 Critical slip surfaces saved: 1
 Resisting Side Maximum Convex Angle: 1 °
 Driving Side Maximum Convex Angle: 5 °
 Optimize Critical Slip Surface Location: No
 Tension Crack
 Tension Crack Option: (none)

file:///P:/FINAL%20PROJECTS/PARDEE/Skyline%20Ranch/SLOPE%20RESULTS/Sect... 3/22/2016

F of S Distribution
 F of S Calculation Option: Constant
 Advanced
 Number of Slices: 30
 F of S Tolerance: 0.01
 Minimum Slip Surface Depth: 0.1 ft

Materials

Tmc - 17 bedding 6-12

Model: Anisotropic Fn.
 Unit Weight: 120 pcf
 Cohesion': 200 psf
 Phi': 40 °
 Phi-Anisotropic Strength Fn.: Tmc 17° (Along Bedding 6-12°)
 C-Anisotropic Strength Fn.: Tmc 150 psf (Along Bedding 6-12°)
 Phi-B: 0 °

TQs-17 bedding 8-12

Model: Anisotropic Fn.
 Unit Weight: 120 pcf
 Cohesion': 225 psf
 Phi': 40 °
 Phi-Anisotropic Strength Fn.: 17° (Along Bedding 8-12°)
 C-Anisotropic Strength Fn.: 150 psf (Along Bedding 8-12°)
 Phi-B: 0 °

Fill

Model: Mohr-Coulomb
 Unit Weight: 120 pcf
 Cohesion': 200 psf
 Phi': 33 °
 Phi-B: 0 °

Slip Surface Entry and Exit

Left Projection: Range
 Left-Zone Left Coordinate: (21.6156, 1,723.1354) ft
 Left-Zone Right Coordinate: (271.8571, 1,760) ft
 Left-Zone Increment: 50
 Right Projection: Range
 Right-Zone Left Coordinate: (314.362, 1,784.3497) ft
 Right-Zone Right Coordinate: (669, 1,805) ft
 Right-Zone Increment: 10
 Radius Increments: 50

Slip Surface Limits

file:///P:/FINAL%20PROJECTS/PARDEE/Skyline%20Ranch/SLOPE%20RESULTS/Sect... 3/22/2016

Left Coordinate: (-201, 1,500) ft
 Right Coordinate: (812, 1,752) ft

Seismic Coefficients

Horz Seismic Coef.: 0
 Vert Seismic Coef.: 0

Anisotropic Strength Functions

Tmc 17° (Along Bedding 6-12°)

Model: Spline Data Point Function
 Function: Modifier Factor vs. Inclination
 Curve Fit to Data: 100 %
 Segment Curvature: 0 %
 Y-Intercept: 1
 Data Points: Inclination (°), Modifier Factor
 Data Point: (-90, 1)
 Data Point: (5.9, 1)
 Data Point: (6, 0.425)
 Data Point: (12, 0.425)
 Data Point: (12.1, 1)

150 psf (Along Bedding 8-12°)

Model: Spline Data Point Function
 Function: Modifier Factor vs. Inclination
 Curve Fit to Data: 100 %
 Segment Curvature: 0 %
 Y-Intercept: 1
 Data Points: Inclination (°), Modifier Factor
 Data Point: (-90, 1)
 Data Point: (7.9, 1)
 Data Point: (8, 0.667)
 Data Point: (12, 0.667)
 Data Point: (12.1, 1)

17° (Along Bedding 8-12°)

Model: Spline Data Point Function
 Function: Modifier Factor vs. Inclination
 Curve Fit to Data: 100 %
 Segment Curvature: 0 %
 Y-Intercept: 1
 Data Points: Inclination (°), Modifier Factor
 Data Point: (-90, 1)
 Data Point: (7.9, 1)
 Data Point: (8, 0.425)
 Data Point: (12, 0.425)
 Data Point: (12.1, 1)

Tmc 150 psf (Along Bedding 6-12°)

Model: Spline Data Point Function
 Function: Modifier Factor vs. Inclination
 Curve Fit to Data: 100 %
 Segment Curvature: 0 %
 Y-Intercept: 1
 Data Points: Inclination (°), Modifier Factor
 Data Point: (-90, 1)
 Data Point: (7.9, 1)
 Data Point: (8, 0.75)
 Data Point: (12, 0.75)
 Data Point: (12.1, 1)

Points

	X (ft)	Y (ft)
Point 1	-197	1,708
Point 2	-121	1,714
Point 3	-53	1,726
Point 4	-25	1,725
Point 5	25	1,723
Point 6	72	1,731
Point 7	110	1,739
Point 8	152	1,738
Point 9	188	1,730
Point 10	205	1,721
Point 11	215	1,711
Point 12	270	1,711
Point 13	338	1,745
Point 14	354	1,739
Point 15	374	1,722
Point 16	455	1,735
Point 17	514	1,743
Point 18	574	1,746
Point 19	656	1,747
Point 20	742	1,745
Point 21	812	1,752
Point 22	811	1,501
Point 23	-201	1,500
Point 24	-198.0192	1,655
Point 25	811.9124	1,730
Point 26	277	1,763
Point 27	333	1,795
Point 28	382	1,795

Point 29	471	1,794
Point 30	499	1,805
Point 31	580	1,805
Point 32	715	1,805
Point 33	809	1,805

Regions

	Material	Points	Area (ft ²)
Region 1	TQs-17 bedding 8-12	1,24,25,21,20,19,18,17,16,15,14,13,12,11,10,9,8,7,6,5,4,3,2	39,930
Region 2	Tmc - 17 bedding 6-12	24,23,22,25	1.9403e+005
Region 3	Fill	10,26,27,28,29,30,31,32,33,21,20,19,18,17,16,15,14,13,12,11	33,691

Current Slip Surface

Slip Surface: 8,487
 F of S: 1.55
 Volume: 2,219.2631 ft³
 Weight: 266,311.57 lbs
 Resisting Moment: 41,034,386 lbs-ft
 Activating Moment: 26,421,804 lbs-ft
 F of S Rank (Analysis): 1 of 28,611 slip surfaces
 F of S Rank (Query): 1 of 150 slip surfaces
 Exit: (205.11201, 1,721.0653) ft
 Entry: (347.48917, 1,795) ft
 Radius: 216.30974 ft
 Center: (183.72094, 1,936.3148) ft

Slip Slices

	X (ft)	Y (ft)	PWP (psf)	Base Normal Stress (psf)	Frictional Strength (psf)	Cohesive Strength (psf)
Slice 1	207.50828	1,721.3305	0	116.34409	75.554737	200
Slice 2	212.30081	1,721.915	0	363.90387	236.32194	200
Slice 3	217.09334	1,722.6087	0	594.71158	386.21022	200
Slice 4	221.88588	1,723.4124	0	809.02271	525.38549	200
Slice 5	226.67841	1,724.3276	0	1,007.0583	653.99128	200
Slice 6	231.47094	1,725.3555	0	1,189.0064	772.14976	200
Slice	236.26347	1,726.498	0	1,355.0237	879.9627	200

7						
Slice 8	241.05601	1,727.7568	0	1,505.2367	977.51216	200
Slice 9	245.84854	1,729.1342	0	1,639.7422	1,064.8611	200
Slice 10	250.64107	1,730.6324	0	1,758.6082	1,142.0535	200
Slice 11	255.4336	1,732.2541	0	1,861.8741	1,209.1152	200
Slice 12	260.22614	1,734.0024	0	1,949.5509	1,266.0532	200
Slice 13	265.01867	1,735.8805	0	2,021.6213	1,312.8562	200
Slice 14	269.8112	1,737.8921	0	2,078.0389	1,349.4942	200
Slice 15	274.60373	1,740.0414	0	2,118.7281	1,375.9181	200
Slice 16	279.33333	1,742.3009	0	2,140.6919	1,390.1816	200
Slice 17	284	1,744.6717	0	2,144.3123	1,392.5327	200
Slice 18	288.66667	1,747.1874	0	2,132.7539	1,385.0266	200
Slice 19	293.33333	1,749.8538	0	2,105.8339	1,367.5445	200
Slice 20	298	1,752.6775	0	2,063.3378	1,339.9473	200
Slice 21	302.66667	1,755.6659	0	2,005.018	1,302.0739	200
Slice 22	307.33333	1,758.8273	0	1,930.5913	1,253.7406	200
Slice 23	312	1,762.1712	0	1,839.7367	1,194.739	200
Slice 24	316.66667	1,765.7083	0	1,732.0934	1,124.8346	200
Slice 25	321.33333	1,769.4508	0	1,607.2578	1,043.7654	200
Slice 26	326	1,773.4131	0	1,464.7812	951.24005	200
Slice 27	330.66667	1,777.6115	0	1,304.168	846.93659	200
Slice 28	335.41486	1,782.1481	0	1,003.941	651.96689	200
Slice 29	340.24459	1,787.0566	0	569.49418	369.83384	200
Slice 30	345.07431	1,792.2945	0	123.21477	80.01661	200

Section 28 SSA for Skyline Ranch.gsz

Section 28-28'

Section 28 SSA for Skyline Ranch.gsz Run By: Dr. Alexander Bykovtsev, Ph.D., P.E. 3/22/2016 3:34:50 PM

Name: Tmc - 17 bedding 6-12
 Model: Anisotropic Fn.
 Unit Weight: 120 pcf
 Cohesion: 200 psf
 Phi: 40 °
 Phi-Anisotropic Strength Fn.: Tmc 17° (Along Bedding 6-12°)
 C-Anisotropic Strength Fn.: Tmc 150 psf (Along Bedding 6-12°)

Pseudostatic - Circular
 Seismic Load
 Horizontal: 0.15
 Vertical: 0.0

Materials

- Tmc - 17 bedding 6-12
- TQs-17 bedding 8-12
- Fill

Name: TQs-17 bedding 8-12
 Model: Anisotropic Fn.
 Unit Weight: 120 pcf
 Cohesion: 225 psf
 Phi: 40 °
 Phi-Anisotropic Strength Fn.: 17° (Along Bedding 8-12°)
 C-Anisotropic Strength Fn.: 150 psf (Along Bedding 8-12°)

Keyway 10' Deep by 55' wide
 2H:1V Backcut

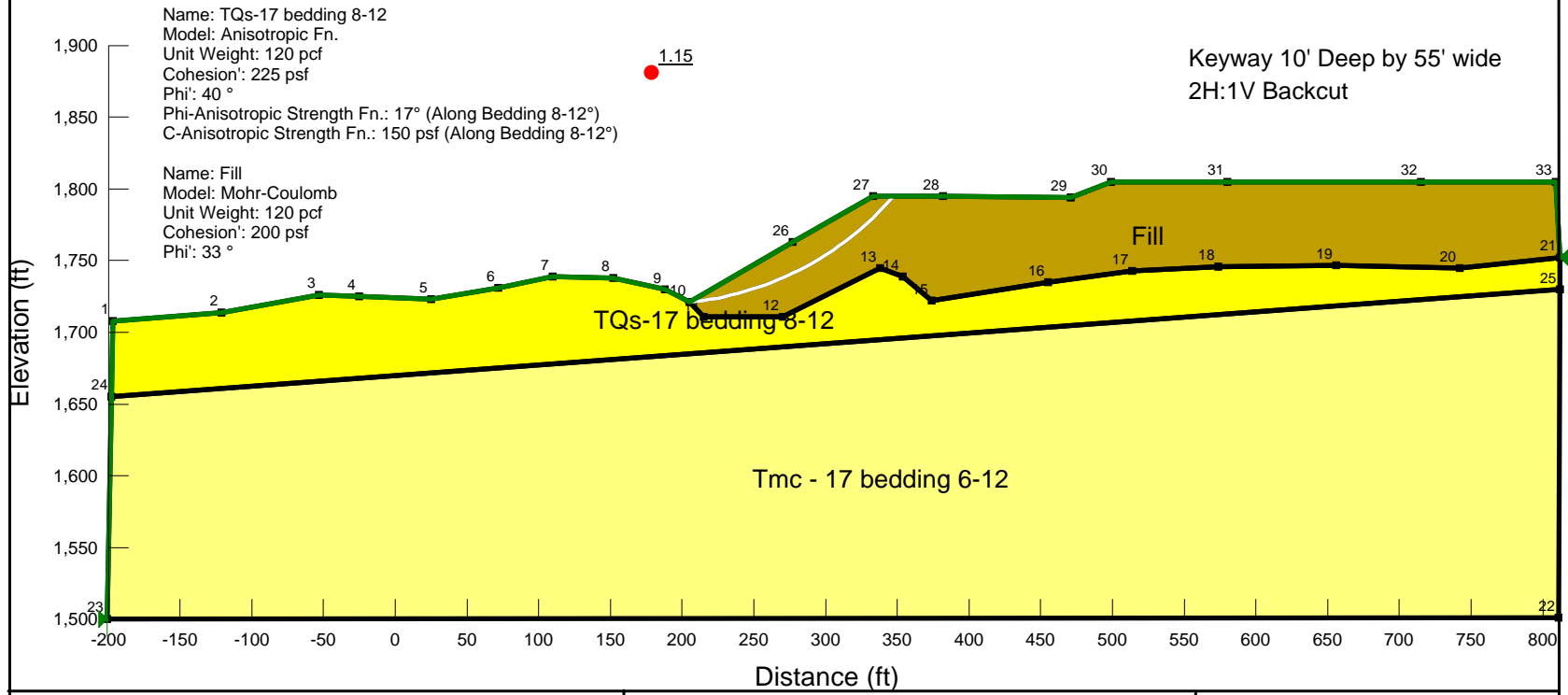

	<p>LGC Valley, Inc GEOTECHNICAL CONSULTING 28532 Constellation Road, Valencia, CA 91355 Phone 661-702-8474, Fax 661-702-8475</p>	<p>Skyline Ranch Development project, Tract 60922 Los Angeles CA</p>	<p>Project No: 153035-01 Engineer: BAS Date: March 2016</p>
--	--	---	--

1 - Circular Mode of Failure seismic

Report generated using GeoStudio 2012. Copyright © 1991-2016 GEO-SLOPE International Ltd.

File Information

File Version: 8.15
 Title: Static Slope Stability Analyses for Skyline Ranch Development project, Tract 60922, Los Angeles CA
 Comments: Run By: Dr. Alexander Bykovtsev, Ph.D., P.E.
 Last Edited By: Alexander Bykovtsev
 Revision Number: 168
 Date: 3/22/2016
 Time: 3:34:50 PM
 Tool Version: 8.15.5.11777
 File Name: Section 28 SSA for Skyline Ranch.gsz
 Directory: P:\FINAL PROJECTS\PARDEE\Skyline Ranch\SLOPE RESULTS\Section 28-28 results\latest Update 3-21-16\
 Last Solved Date: 3/22/2016
 Last Solved Time: 3:35:33 PM

Project Settings

Length(L) Units: Feet
 Time(t) Units: Seconds
 Force(F) Units: Pounds
 Pressure(p) Units: psf
 Strength Units: psf
 Unit Weight of Water: 62.4 pcf
 View: 2D
 Element Thickness: 1

Analysis Settings

1 - Circular Mode of Failure seismic

Kind: SLOPE/W
 Parent: 1 - Circular Mode of Failure
 Method: Bishop
 Settings
 PWP Conditions Source: (none)
 Initial Slip Surface Source: Parent Analysis
 Slip Surface
 Direction of movement: Right to Left
 Use Passive Mode: No
 Slip Surface Option: Critical Slip Surfaces from Other
 Critical slip surfaces saved: 1
 Resisting Side Maximum Convex Angle: 1 °
 Driving Side Maximum Convex Angle: 5 °
 Optimize Critical Slip Surface Location: No

file:///P:/FINAL%20PROJECTS/PARDEE/Skyline%20Ranch/SLOPE%20RESULTS/Sect... 3/22/2016

Tension Crack
 Tension Crack Option: (none)
 F of S Distribution
 F of S Calculation Option: Constant
 Advanced
 Number of Slices: 30
 F of S Tolerance: 0.01
 Minimum Slip Surface Depth: 0.1 ft

Materials

Tmc - 17 bedding 6-12

Model: Anisotropic Fn.
 Unit Weight: 120 pcf
 Cohesion': 200 psf
 Phi': 40 °
 Phi-Anisotropic Strength Fn.: Tmc 17° (Along Bedding 6-12°)
 C-Anisotropic Strength Fn.: Tmc 150 psf (Along Bedding 6-12°)
 Phi-B: 0 °

TQs-17 bedding 8-12

Model: Anisotropic Fn.
 Unit Weight: 120 pcf
 Cohesion': 225 psf
 Phi': 40 °
 Phi-Anisotropic Strength Fn.: 17° (Along Bedding 8-12°)
 C-Anisotropic Strength Fn.: 150 psf (Along Bedding 8-12°)
 Phi-B: 0 °

Fill

Model: Mohr-Coulomb
 Unit Weight: 120 pcf
 Cohesion': 200 psf
 Phi': 33 °
 Phi-B: 0 °

Slip Surface Limits

Left Coordinate: (-201, 1,500) ft
 Right Coordinate: (812, 1,752) ft

Seismic Coefficients

Horz Seismic Coef.: 0.15
 Vert Seismic Coef.: 0

Anisotropic Strength Functions

file:///P:/FINAL%20PROJECTS/PARDEE/Skyline%20Ranch/SLOPE%20RESULTS/Sect... 3/22/2016

Tmc 17° (Along Bedding 6-12°)

Model: Spline Data Point Function
 Function: Modifier Factor vs. Inclination
 Curve Fit to Data: 100 %
 Segment Curvature: 0 %

Y-Intercept: 1
 Data Points: Inclination (°), Modifier Factor
 Data Point: (-90, 1)
 Data Point: (5.9, 1)
 Data Point: (6, 0.425)
 Data Point: (12, 0.425)
 Data Point: (12.1, 1)

150 psf (Along Bedding 8-12°)

Model: Spline Data Point Function
 Function: Modifier Factor vs. Inclination
 Curve Fit to Data: 100 %
 Segment Curvature: 0 %

Y-Intercept: 1
 Data Points: Inclination (°), Modifier Factor
 Data Point: (-90, 1)
 Data Point: (7.9, 1)
 Data Point: (8, 0.667)
 Data Point: (12, 0.667)
 Data Point: (12.1, 1)

17° (Along Bedding 8-12°)

Model: Spline Data Point Function
 Function: Modifier Factor vs. Inclination
 Curve Fit to Data: 100 %
 Segment Curvature: 0 %

Y-Intercept: 1
 Data Points: Inclination (°), Modifier Factor
 Data Point: (-90, 1)
 Data Point: (7.9, 1)
 Data Point: (8, 0.425)
 Data Point: (12, 0.425)
 Data Point: (12.1, 1)

Tmc 150 psf (Along Bedding 6-12°)

Model: Spline Data Point Function
 Function: Modifier Factor vs. Inclination
 Curve Fit to Data: 100 %
 Segment Curvature: 0 %

Y-Intercept: 1
 Data Points: Inclination (°), Modifier Factor
 Data Point: (-90, 1)
 Data Point: (7.9, 1)
 Data Point: (8, 0.75)

Data Point: (12, 0.75)
 Data Point: (12.1, 1)

Points

	X (ft)	Y (ft)
Point 1	-197	1,708
Point 2	-121	1,714
Point 3	-53	1,726
Point 4	-25	1,725
Point 5	25	1,723
Point 6	72	1,731
Point 7	110	1,739
Point 8	152	1,738
Point 9	188	1,730
Point 10	205	1,721
Point 11	215	1,711
Point 12	270	1,711
Point 13	338	1,745
Point 14	354	1,739
Point 15	374	1,722
Point 16	455	1,735
Point 17	514	1,743
Point 18	574	1,746
Point 19	656	1,747
Point 20	742	1,745
Point 21	812	1,752
Point 22	811	1,501
Point 23	-201	1,500
Point 24	-198.0192	1,655
Point 25	811.9124	1,730
Point 26	277	1,763
Point 27	333	1,795
Point 28	382	1,795
Point 29	471	1,794
Point 30	499	1,805
Point 31	580	1,805
Point 32	715	1,805
Point 33	809	1,805

Regions

	Material	Points	Area (ft²)
Region	TQs-17		

1	bedding 8-12	1,24,25,21,20,19,18,17,16,15,14,13,12,11,10,9,8,7,6,5,4,3,2	39,930
Region 2	Tmc - 17 bedding 6-12	24,23,22,25	1.9403e+005
Region 3	Fill	10,26,27,28,29,30,31,32,33,21,20,19,18,17,16,15,14,13,12,11	33,691

Current Slip Surface

Slip Surface: 1
 F of S: 1.15
 Volume: 2,219.2631 ft³
 Weight: 266,311.58 lbs
 Resisting Moment: 38,620,651 lbs-ft
 Activating Moment: 33,588,095 lbs-ft
 F of S Rank (Analysis): 1 of 1 slip surfaces
 F of S Rank (Query): 1 of 1 slip surfaces
 Exit: (205.11201, 1,721.0653) ft
 Entry: (347.48917, 1,795) ft
 Radius: 216.30974 ft
 Center: (183.72094, 1,936.3148) ft

Slip Slices

	X (ft)	Y (ft)	PWP (psf)	Base Normal Stress (psf)	Frictional Strength (psf)	Cohesive Strength (psf)
Slice 1	207.50828	1,721.3305	0	109.90875	71.375575	200
Slice 2	212.30081	1,721.915	0	351.77308	228.44411	200
Slice 3	217.09334	1,722.6087	0	575.84446	373.95777	200
Slice 4	221.88588	1,723.4124	0	782.53903	508.18679	200
Slice 5	226.67841	1,724.3276	0	972.22869	631.3727	200
Slice 6	231.47094	1,725.3555	0	1,145.2434	743.72976	200
Slice 7	236.26347	1,726.498	0	1,301.8752	845.44763	200
Slice 8	241.05601	1,727.7568	0	1,442.3793	936.69208	200
Slice 9	245.84854	1,729.1342	0	1,566.9765	1,017.6065	200
Slice 10	250.64107	1,730.6324	0	1,675.8556	1,088.3133	200
Slice 11	255.4336	1,732.2541	0	1,769.1731	1,148.9145	200
Slice 12	260.22614	1,734.0024	0	1,847.0564	1,199.4925	200

Slice 13	265.01867	1,735.8805	0	1,909.6023	1,240.1103	200
Slice 14	269.8112	1,737.8921	0	1,956.8808	1,270.8132	200
Slice 15	274.60373	1,740.0414	0	1,988.9317	1,291.6274	200
Slice 16	279.33333	1,742.3009	0	2,003.1282	1,300.8466	200
Slice 17	284	1,744.6717	0	1,999.9694	1,298.7953	200
Slice 18	288.66667	1,747.1874	0	1,982.4722	1,287.4325	200
Slice 19	293.33333	1,749.8538	0	1,950.5753	1,266.7184	200
Slice 20	298	1,752.6775	0	1,904.1917	1,236.5966	200
Slice 21	302.66667	1,755.6659	0	1,843.21	1,196.9945	200
Slice 22	307.33333	1,758.8273	0	1,767.4928	1,147.8232	200
Slice 23	312	1,762.1712	0	1,676.8768	1,088.9765	200
Slice 24	316.66667	1,765.7083	0	1,571.1725	1,020.3313	200
Slice 25	321.33333	1,769.4508	0	1,450.1661	941.74887	200
Slice 26	326	1,773.4131	0	1,313.6176	853.07324	200
Slice 27	330.66667	1,777.6115	0	1,161.2658	754.13484	200
Slice 28	335.41486	1,782.1481	0	882.95874	573.40011	200
Slice 29	340.24459	1,787.0566	0	485.22856	315.11111	200
Slice 30	345.07431	1,792.2945	0	80.070653	51.99849	200

Section 28 SSA for Skyline Ranch.gsz

Section 28-28'

Section 28 SSA for Skyline Ranch.gsz Run By: Dr. Alexander Bykovtsev, Ph.D., P.E. 3/22/2016 3:34:50 PM

Name: Tmc - 17 bedding 6-12
 Model: Anisotropic Fn.
 Unit Weight: 120 pcf
 Cohesion: 200 psf
 Phi: 40 °
 Phi-Anisotropic Strength Fn.: Tmc 17° (Along Bedding 6-12°)
 C-Anisotropic Strength Fn.: Tmc 150 psf (Along Bedding 6-12°)

Name: TQs-17 bedding 8-12
 Model: Anisotropic Fn.
 Unit Weight: 120 pcf
 Cohesion: 225 psf
 Phi: 40 °
 Phi-Anisotropic Strength Fn.: 17° (Along Bedding 8-12°)
 C-Anisotropic Strength Fn.: 150 psf (Along Bedding 8-12°)

Name: Fill
 Model: Mohr-Coulomb
 Unit Weight: 120 pcf
 Cohesion: 200 psf
 Phi: 33 °

Materials

- Tmc - 17 bedding 6-12
- TQs-17 bedding 8-12
- Fill

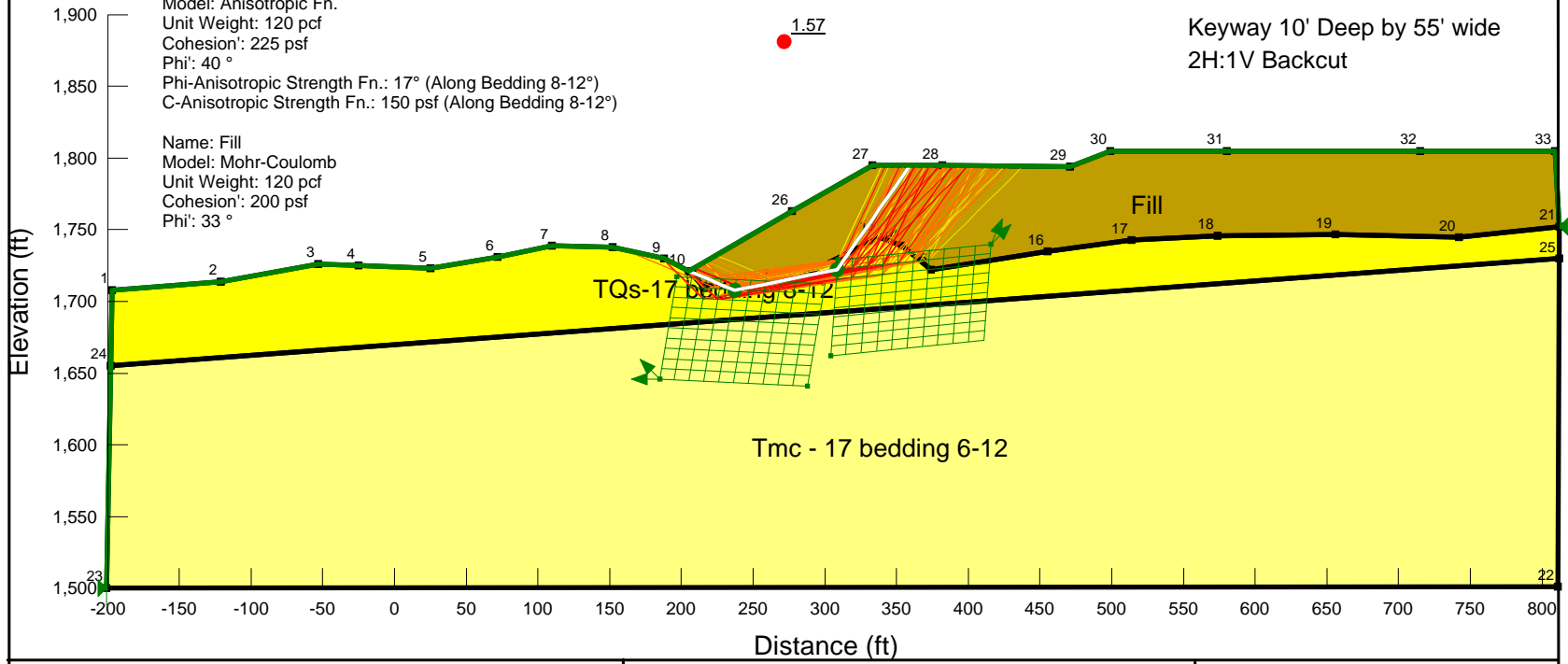

	<p>LGC Valley, Inc GEOTECHNICAL CONSULTING 28532 Constellation Road, Valencia, CA 91355 Phone 661-702-8474, Fax 661-702-8475</p>	<p>Skyline Ranch Development project, Tract 60922 Los Angeles CA</p>	<p>Project No: 153035-01 Engineer: BAS Date: March 2016</p>
--	--	---	--

2 - Translational

Report generated using GeoStudio 2012. Copyright © 1991-2016 GEO-SLOPE International Ltd.

File Information

File Version: 8.15
 Title: Static Slope Stability Analyses for Skyline Ranch Development project, Tract 60922, Los Angeles CA
 Comments: Run By: Dr. Alexander Bykovtsev, Ph.D., P.E.
 Last Edited By: Alexander Bykovtsev
 Revision Number: 168
 Date: 3/22/2016
 Time: 3:34:50 PM
 Tool Version: 8.15.5.11777
 File Name: Section 28 SSA for Skyline Ranch.gsz
 Directory: P:\FINAL PROJECTS\PARDEE\Skyline Ranch\SLOPE RESULTS\Section 28-28 results\latest Update 3-21-16\
 Last Solved Date: 3/22/2016
 Last Solved Time: 3:35:34 PM

Project Settings

Length(L) Units: Feet
 Time(t) Units: Seconds
 Force(F) Units: Pounds
 Pressure(p) Units: psf
 Strength Units: psf
 Unit Weight of Water: 62.4 pcf
 View: 2D
 Element Thickness: 1

Analysis Settings

2 - Translational

Kind: SLOPE/W
 Method: Janbu
 Settings
 PWP Conditions Source: (none)
 Slip Surface
 Direction of movement: Right to Left
 Use Passive Mode: No
 Slip Surface Option: Block
 Critical slip surfaces saved: 1
 Resisting Side Maximum Convex Angle: 1 °
 Driving Side Maximum Convex Angle: 5 °
 Restrict Block Crossing: No
 Optimize Critical Slip Surface Location: No
 Tension Crack

file:///P:/FINAL%20PROJECTS/PARDEE/Skyline%20Ranch/SLOPE%20RESULTS/Sect... 3/22/2016

Tension Crack Option: (none)
 F of S Distribution
 F of S Calculation Option: Constant
 Advanced
 Number of Slices: 30
 F of S Tolerance: 0.01
 Minimum Slip Surface Depth: 0.1 ft

Materials

Tmc - 17 bedding 6-12

Model: Anisotropic Fn.
 Unit Weight: 120 pcf
 Cohesion': 200 psf
 Phi': 40 °
 Phi-Anisotropic Strength Fn.: Tmc 17° (Along Bedding 6-12°)
 C-Anisotropic Strength Fn.: Tmc 150 psf (Along Bedding 6-12°)
 Phi-B: 0 °

TQs-17 bedding 8-12

Model: Anisotropic Fn.
 Unit Weight: 120 pcf
 Cohesion': 225 psf
 Phi': 40 °
 Phi-Anisotropic Strength Fn.: 17° (Along Bedding 8-12°)
 C-Anisotropic Strength Fn.: 150 psf (Along Bedding 8-12°)
 Phi-B: 0 °

Fill

Model: Mohr-Coulomb
 Unit Weight: 120 pcf
 Cohesion': 200 psf
 Phi': 33 °
 Phi-B: 0 °

Slip Surface Limits

Left Coordinate: (-201, 1,500) ft
 Right Coordinate: (812, 1,752) ft

Slip Surface Block

Left Grid
 Upper Left: (197, 1,717) ft
 Lower Left: (185.0015, 1,645.92) ft
 Lower Right: (288, 1,641) ft
 X Increments: 10
 Y Increments: 10

file:///P:/FINAL%20PROJECTS/PARDEE/Skyline%20Ranch/SLOPE%20RESULTS/Sect... 3/22/2016

Starting Angle: 135 °
 Ending Angle: 180 °
 Angle Increments: 2
Right Grid
 Upper Left: (304, 1,662) ft
 Lower Left: (309, 1,729) ft
 Lower Right: (416, 1,740) ft
 X Increments: 10
 Y Increments: 10
 Starting Angle: 45 °
 Ending Angle: 65 °
 Angle Increments: 2

Seismic Coefficients

Horz Seismic Coef.: 0
 Vert Seismic Coef.: 0

Anisotropic Strength Functions

Tmc 17° (Along Bedding 6-12°)

Model: Spline Data Point Function
 Function: Modifier Factor vs. Inclination
 Curve Fit to Data: 100 %
 Segment Curvature: 0 %
 Y-Intercept: 1
 Data Points: Inclination (°), Modifier Factor
 Data Point: (-90, 1)
 Data Point: (5.9, 1)
 Data Point: (6, 0.425)
 Data Point: (12, 0.425)
 Data Point: (12.1, 1)

150 psf (Along Bedding 8-12°)

Model: Spline Data Point Function
 Function: Modifier Factor vs. Inclination
 Curve Fit to Data: 100 %
 Segment Curvature: 0 %
 Y-Intercept: 1
 Data Points: Inclination (°), Modifier Factor
 Data Point: (-90, 1)
 Data Point: (7.9, 1)
 Data Point: (8, 0.667)
 Data Point: (12, 0.667)
 Data Point: (12.1, 1)

17° (Along Bedding 8-12°)

Model: Spline Data Point Function
 Function: Modifier Factor vs. Inclination

Curve Fit to Data: 100 %
 Segment Curvature: 0 %
 Y-Intercept: 1
 Data Points: Inclination (°), Modifier Factor
 Data Point: (-90, 1)
 Data Point: (7.9, 1)
 Data Point: (8, 0.425)
 Data Point: (12, 0.425)
 Data Point: (12.1, 1)

Tmc 150 psf (Along Bedding 6-12°)

Model: Spline Data Point Function
 Function: Modifier Factor vs. Inclination
 Curve Fit to Data: 100 %
 Segment Curvature: 0 %
 Y-Intercept: 1
 Data Points: Inclination (°), Modifier Factor
 Data Point: (-90, 1)
 Data Point: (7.9, 1)
 Data Point: (8, 0.75)
 Data Point: (12, 0.75)
 Data Point: (12.1, 1)

Points

	X (ft)	Y (ft)
Point 1	-197	1,708
Point 2	-121	1,714
Point 3	-53	1,726
Point 4	-25	1,725
Point 5	25	1,723
Point 6	72	1,731
Point 7	110	1,739
Point 8	152	1,738
Point 9	188	1,730
Point 10	205	1,721
Point 11	215	1,711
Point 12	270	1,711
Point 13	338	1,745
Point 14	354	1,739
Point 15	374	1,722
Point 16	455	1,735
Point 17	514	1,743
Point 18	574	1,746
Point 19	656	1,747
Point 20	742	1,745
Point 21	812	1,752

Point 22	811	1,501
Point 23	-201	1,500
Point 24	-198.0192	1,655
Point 25	811.9124	1,730
Point 26	277	1,763
Point 27	333	1,795
Point 28	382	1,795
Point 29	471	1,794
Point 30	499	1,805
Point 31	580	1,805
Point 32	715	1,805
Point 33	809	1,805

Regions

	Material	Points	Area (ft²)
Region 1	TQs-17 bedding 8-12	1,24,25,21,20,19,18,17,16,15,14,13,12,11,10,9,8,7,6,5,4,3,2	39,930
Region 2	Tmc - 17 bedding 6-12	24,23,22,25	1.9403e+005
Region 3	Fill	10,26,27,28,29,30,31,32,33,21,20,19,18,17,16,15,14,13,12,11	33,691

Current Slip Surface

Slip Surface: 112,565
 F of S: 1.57
 Volume: 5,424.7653 ft³
 Weight: 650,971.84 lbs
 Resisting Force: 328,059.33 lbs
 Activating Force: 208,918.39 lbs
 F of S Rank (Analysis): 1 of 131,769 slip surfaces
 F of S Rank (Query): 1 of 150 slip surfaces
 Exit: (205.17909, 1,721.1045) ft
 Entry: (359.40509, 1,795) ft
 Radius: 103.54463 ft
 Center: (255.73747, 1,813.4739) ft

Slip Slices

	X (ft)	Y (ft)	PWP (psf)	Base Normal Stress (psf)	Frictional Strength (psf)	Cohesive Strength (psf)
Slice 1	207.61852	1,720.094	0	416.80191	270.67433	200
Slice 2	212.49739	1,718.0731	0	1,122.2986	728.82924	200
Slice 3	217.37626	1,716.0522	0	1,827.7953	1,186.9841	200

Slice 4	222.25513	1,714.0313	0	2,533.292	1,645.1391	200
Slice 5	227.13399	1,712.0104	0	3,238.7887	2,103.294	200
Slice 6	233.28649	1,709.462	0	4,404.0155	3,695.4078	225
Slice 7	239.54935	1,708.4367	0	3,758.8467	1,149.1948	150.075
Slice 8	244.64894	1,709.462	0	3,983.9226	1,218.0074	150.075
Slice 9	249.74854	1,710.4873	0	4,208.9986	1,286.82	150.075
Slice 10	254.7685	1,711.4967	0	4,243.7852	2,755.9464	200
Slice 11	259.70884	1,712.49	0	4,452.9318	2,891.7677	200
Slice 12	264.64917	1,713.4833	0	4,662.0783	3,027.5891	200
Slice 13	269.5895	1,714.4766	0	4,871.2249	3,163.4104	200
Slice 14	274.52983	1,715.4699	0	5,080.3714	3,299.2318	200
Slice 15	279.45294	1,716.4598	0	5,285.5549	3,432.4795	200
Slice 16	284.5653	1,717.4876	0	5,735.274	1,753.4492	150.075
Slice 17	289.88412	1,718.5571	0	5,962.7151	1,822.985	150.075
Slice 18	295.20294	1,719.6265	0	6,190.1562	1,892.5207	150.075
Slice 19	300.52177	1,720.6959	0	6,417.5973	1,962.0564	150.075
Slice 20	305.84059	1,721.7653	0	6,645.0384	2,031.5921	150.075
Slice 21	310.64136	1,725.3582	0	3,745.3608	3,142.7309	225
Slice 22	314.92408	1,731.4745	0	3,496.1913	2,933.6528	225
Slice 23	319.7212	1,738.3255	0	3,581.4802	2,325.8405	200
Slice 24	325.03272	1,745.9112	0	3,238.8307	2,103.3212	200
Slice 25	330.34424	1,753.4968	0	2,896.1811	1,880.802	200
Slice 26	335.64051	1,761.0607	0	2,440.8986	1,585.1381	200
Slice 27	340.92153	1,768.6027	0	1,872.9832	1,216.3295	200

Slice 28	346.20254	1,776.1448	0	1,305.0677	847.5209	200
Slice 29	351.48356	1,783.6869	0	737.15229	478.71229	200
Slice 30	356.76458	1,791.229	0	169.23684	109.90369	200

Section 28 SSA for Skyline Ranch.gsz

Section 28-28'

Section 28 SSA for Skyline Ranch.gsz Run By: Dr. Alexander Bykovtsev, Ph.D., P.E. 3/22/2016 3:34:50 PM

Name: Tmc - 17 bedding 6-12
 Model: Anisotropic Fn.
 Unit Weight: 120 pcf
 Cohesion: 200 psf
 Phi: 40 °
 Phi-Anisotropic Strength Fn.: Tmc 17° (Along Bedding 6-12°)
 C-Anisotropic Strength Fn.: Tmc 150 psf (Along Bedding 6-12°)

Pseudostatic - Translational
 Seismic Load
 Horizontal: 0.15
 Vertical: 0.0

Materials

- Tmc - 17 bedding 6-12
- TQs-17 bedding 8-12
- Fill

Name: TQs-17 bedding 8-12
 Model: Anisotropic Fn.
 Unit Weight: 120 pcf
 Cohesion: 225 psf
 Phi: 40 °
 Phi-Anisotropic Strength Fn.: 17° (Along Bedding 8-12°)
 C-Anisotropic Strength Fn.: 150 psf (Along Bedding 8-12°)

Keyway 10' Deep by 55' wide
 2H:1V Backcut

Name: Fill
 Model: Mohr-Coulomb
 Unit Weight: 120 pcf
 Cohesion: 200 psf
 Phi: 33 °

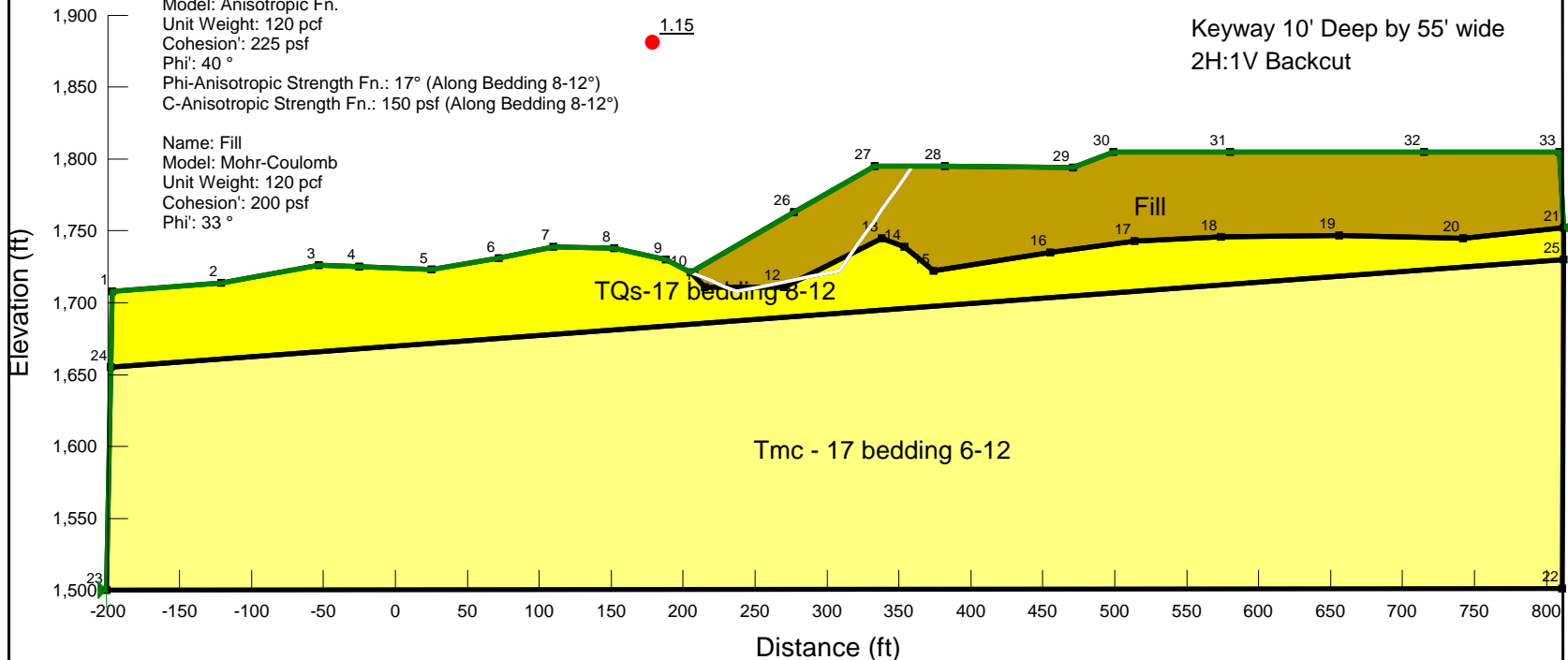

LGC **LGC Valley, Inc**
 GEOTECHNICAL CONSULTING
 28532 Constellation Road, Valencia, CA 91355
 Phone 661-702-8474, Fax 661-702-8475

Skyline Ranch
 Development project, Tract 60922
 Los Angeles CA

Project No: **153035-01**
 Engineer: **BAS**
 Date: **March 2016**

2 - Translational Seismic

Report generated using GeoStudio 2012. Copyright © 1991-2016 GEO-SLOPE International Ltd.

File Information

File Version: 8.15
 Title: Static Slope Stability Analyses for Skyline Ranch Development project, Tract 60922, Los Angeles CA
 Comments: Run By: Dr. Alexander Bykovtsev, Ph.D., P.E.
 Last Edited By: Alexander Bykovtsev
 Revision Number: 168
 Date: 3/22/2016
 Time: 3:34:50 PM
 Tool Version: 8.15.5.11777
 File Name: Section 28 SSA for Skyline Ranch.gsz
 Directory: P:\FINAL PROJECTS\PARDEE\Skyline Ranch\SLOPE RESULTS\Section 28-28 results\latest Update 3-21-16\
 Last Solved Date: 3/22/2016
 Last Solved Time: 3:35:34 PM

Project Settings

Length(L) Units: Feet
 Time(t) Units: Seconds
 Force(F) Units: Pounds
 Pressure(p) Units: psf
 Strength Units: psf
 Unit Weight of Water: 62.4 pcf
 View: 2D
 Element Thickness: 1

Analysis Settings

2 - Translational Seismic

Kind: SLOPE/W
 Parent: 2 - Translational
 Method: Janbu
 Settings
 PWP Conditions Source: (none)
 Initial Slip Surface Source: Parent Analysis
 Slip Surface
 Direction of movement: Right to Left
 Use Passive Mode: No
 Slip Surface Option: Critical Slip Surfaces from Other
 Critical slip surfaces saved: 1
 Resisting Side Maximum Convex Angle: 1 °
 Driving Side Maximum Convex Angle: 5 °
 Optimize Critical Slip Surface Location: No

file:///P:/FINAL%20PROJECTS/PARDEE/Skyline%20Ranch/SLOPE%20RESULTS/Sect... 3/22/2016

Tension Crack
 Tension Crack Option: (none)
 F of S Distribution
 F of S Calculation Option: Constant
 Advanced
 Number of Slices: 30
 F of S Tolerance: 0.01
 Minimum Slip Surface Depth: 0.1 ft

Materials

Tmc - 17 bedding 6-12

Model: Anisotropic Fn.
 Unit Weight: 120 pcf
 Cohesion': 200 psf
 Phi': 40 °
 Phi-Anisotropic Strength Fn.: Tmc 17° (Along Bedding 6-12°)
 C-Anisotropic Strength Fn.: Tmc 150 psf (Along Bedding 6-12°)
 Phi-B: 0 °

TQs-17 bedding 8-12

Model: Anisotropic Fn.
 Unit Weight: 120 pcf
 Cohesion': 225 psf
 Phi': 40 °
 Phi-Anisotropic Strength Fn.: 17° (Along Bedding 8-12°)
 C-Anisotropic Strength Fn.: 150 psf (Along Bedding 8-12°)
 Phi-B: 0 °

Fill

Model: Mohr-Coulomb
 Unit Weight: 120 pcf
 Cohesion': 200 psf
 Phi': 33 °
 Phi-B: 0 °

Slip Surface Limits

Left Coordinate: (-201, 1,500) ft
 Right Coordinate: (812, 1,752) ft

Seismic Coefficients

Horz Seismic Coef.: 0.15
 Vert Seismic Coef.: 0

Anisotropic Strength Functions

file:///P:/FINAL%20PROJECTS/PARDEE/Skyline%20Ranch/SLOPE%20RESULTS/Sect... 3/22/2016

Tmc 17° (Along Bedding 6-12°)

Model: Spline Data Point Function
 Function: Modifier Factor vs. Inclination
 Curve Fit to Data: 100 %
 Segment Curvature: 0 %

Y-Intercept: 1
 Data Points: Inclination (°), Modifier Factor
 Data Point: (-90, 1)
 Data Point: (5.9, 1)
 Data Point: (6, 0.425)
 Data Point: (12, 0.425)
 Data Point: (12.1, 1)

150 psf (Along Bedding 8-12°)

Model: Spline Data Point Function
 Function: Modifier Factor vs. Inclination
 Curve Fit to Data: 100 %
 Segment Curvature: 0 %

Y-Intercept: 1
 Data Points: Inclination (°), Modifier Factor
 Data Point: (-90, 1)
 Data Point: (7.9, 1)
 Data Point: (8, 0.667)
 Data Point: (12, 0.667)
 Data Point: (12.1, 1)

17° (Along Bedding 8-12°)

Model: Spline Data Point Function
 Function: Modifier Factor vs. Inclination
 Curve Fit to Data: 100 %
 Segment Curvature: 0 %

Y-Intercept: 1
 Data Points: Inclination (°), Modifier Factor
 Data Point: (-90, 1)
 Data Point: (7.9, 1)
 Data Point: (8, 0.425)
 Data Point: (12, 0.425)
 Data Point: (12.1, 1)

Tmc 150 psf (Along Bedding 6-12°)

Model: Spline Data Point Function
 Function: Modifier Factor vs. Inclination
 Curve Fit to Data: 100 %
 Segment Curvature: 0 %

Y-Intercept: 1
 Data Points: Inclination (°), Modifier Factor
 Data Point: (-90, 1)
 Data Point: (7.9, 1)
 Data Point: (8, 0.75)

Data Point: (12, 0.75)
 Data Point: (12.1, 1)

Points

	X (ft)	Y (ft)
Point 1	-197	1,708
Point 2	-121	1,714
Point 3	-53	1,726
Point 4	-25	1,725
Point 5	25	1,723
Point 6	72	1,731
Point 7	110	1,739
Point 8	152	1,738
Point 9	188	1,730
Point 10	205	1,721
Point 11	215	1,711
Point 12	270	1,711
Point 13	338	1,745
Point 14	354	1,739
Point 15	374	1,722
Point 16	455	1,735
Point 17	514	1,743
Point 18	574	1,746
Point 19	656	1,747
Point 20	742	1,745
Point 21	812	1,752
Point 22	811	1,501
Point 23	-201	1,500
Point 24	-198.0192	1,655
Point 25	811.9124	1,730
Point 26	277	1,763
Point 27	333	1,795
Point 28	382	1,795
Point 29	471	1,794
Point 30	499	1,805
Point 31	580	1,805
Point 32	715	1,805
Point 33	809	1,805

Regions

	Material	Points	Area (ft²)
Region	TQs-17		

1	bedding 8-12	1,24,25,21,20,19,18,17,16,15,14,13,12,11,10,9,8,7,6,5,4,3,2	39,930
Region 2	Tmc - 17 bedding 6-12	24,23,22,25	1.9403e+005
Region 3	Fill	10,26,27,28,29,30,31,32,33,21,20,19,18,17,16,15,14,13,12,11	33,691

Current Slip Surface

Slip Surface: 1
 F of S: 1.15
 Volume: 5,424.7653 ft³
 Weight: 650,971.84 lbs
 Resisting Force: 318,995 lbs
 Activating Force: 278,106.68 lbs
 F of S Rank (Analysis): 1 of 1 slip surfaces
 F of S Rank (Query): 1 of 1 slip surfaces
 Exit: (205.17909, 1,721.1045) ft
 Entry: (359.40509, 1,795) ft
 Radius: 103.54463 ft
 Center: (255.73747, 1,813.4739) ft

Slip Slices

	X (ft)	Y (ft)	PWP (psf)	Base Normal Stress (psf)	Frictional Strength (psf)	Cohesive Strength (psf)
Slice 1	207.61852	1,720.094	0	476.49161	309.43727	200
Slice 2	212.49739	1,718.0731	0	1,240.0906	805.32426	200
Slice 3	217.37626	1,716.0522	0	2,003.6891	1,301.2109	200
Slice 4	222.25513	1,714.0313	0	2,767.2883	1,797.098	200
Slice 5	227.13399	1,712.0104	0	3,530.8865	2,292.9845	200
Slice 6	233.28649	1,709.462	0	4,950.2504	4,153.7533	225
Slice 7	239.54935	1,708.4367	0	3,700.7945	1,131.4464	150.075
Slice 8	244.64894	1,709.462	0	3,922.7957	1,199.319	150.075
Slice 9	249.74854	1,710.4873	0	4,144.7973	1,267.1917	150.075
Slice 10	254.7685	1,711.4967	0	4,118.873	2,674.8274	200
Slice 11	259.70884	1,712.49	0	4,322.2796	2,806.9212	200
Slice 12	264.64917	1,713.4833	0	4,525.6871	2,939.0155	200

Slice 13	269.5895	1,714.4766	0	4,729.0935	3,071.1093	200
Slice 14	274.52983	1,715.4699	0	4,932.5011	3,203.2037	200
Slice 15	279.45294	1,716.4598	0	5,132.0533	3,332.7944	200
Slice 16	284.5653	1,717.4876	0	5,650.2235	1,727.4467	150.075
Slice 17	289.88412	1,718.5571	0	5,874.5574	1,796.0324	150.075
Slice 18	295.20294	1,719.6265	0	6,098.8919	1,864.6184	150.075
Slice 19	300.52177	1,720.6959	0	6,323.2258	1,933.2041	150.075
Slice 20	305.84059	1,721.7653	0	6,547.5603	2,001.7901	150.075
Slice 21	310.64136	1,725.3582	0	3,195.3405	2,681.209	225
Slice 22	314.92408	1,731.4745	0	2,980.3177	2,500.7835	225
Slice 23	319.7212	1,738.3255	0	3,115.0038	2,022.9071	200
Slice 24	325.03272	1,745.9112	0	2,813.4497	1,827.0756	200
Slice 25	330.34424	1,753.4968	0	2,511.8952	1,631.2438	200
Slice 26	335.64051	1,761.0607	0	2,111.2164	1,371.0399	200
Slice 27	340.92153	1,768.6027	0	1,611.4131	1,046.4639	200
Slice 28	346.20254	1,776.1448	0	1,111.6099	721.88793	200
Slice 29	351.48356	1,783.6869	0	611.8066	397.31185	200
Slice 30	356.76458	1,791.229	0	112.00332	72.735805	200

Section 29-29 Cir Static Left SSA for Skyline Ranch.gsz

Section 29-29 Cir Static Left SSA for Skyline Ranch.gsz Run By: Dr. Alexander Bykovtsev, Ph.D., P.E. 3/15/2016 10:31:37 AM

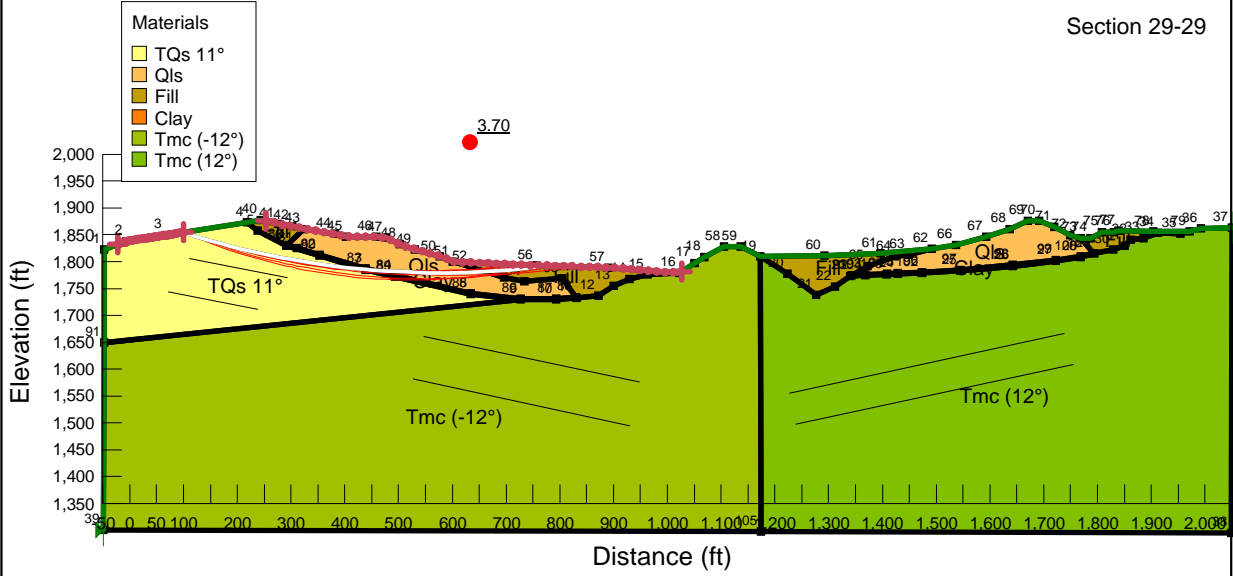

Section 29-29

- Name: TQs 11°
Model: Anisotropic Fn.
Unit Weight: 120 pcf
Cohesion: 225 psf
Phi: 40 °
Phi-Anisotropic Strength Fn.: 11° (Along Bedding -10°-(-25°))
C-Anisotropic Strength Fn.: 150 pcf (Along Bedding 10°-25°)
- Name: Qls
Model: Mohr-Coulomb
Unit Weight: 100 pcf
Cohesion: 0 psf
Phi: 20 °
- Name: Fill
Model: Mohr-Coulomb
Unit Weight: 120 pcf
Cohesion: 200 psf
Phi: 33 °
- Name: Clay
Model: Mohr-Coulomb
Unit Weight: 100 pcf
Cohesion: 150 psf
Phi: 9 °
- Name: Tmc (-12°)
Model: Anisotropic Fn.
Unit Weight: 120 pcf
Cohesion: 200 psf
Phi: 40 °
Phi-Anisotropic Strength Fn.: 12° (Along Bedding -10°-(-25°))
C-Anisotropic Strength Fn.: 150 pcf (Along Bedding 10°-25°)
- Name: Tmc (12°)
Model: Anisotropic Fn.
Unit Weight: 120 pcf
Cohesion: 200 psf
Phi: 40 °
Phi-Anisotropic Strength Fn.: 12° (Along Bedding 10°-25°)
C-Anisotropic Strength Fn.: 150 pcf (Along Bedding 10°-25°)

LGC LGC Valley, Inc
 GEOTECHNICAL CONSULTING
 28532 Constellation Road, Valencia, CA 91355
 Phone 661-702-8474, Fax 661-702-8475

Skyline Ranch
 Development project, Tract 60922
 Los Angeles CA

Project No: **153035-01**
 Engineer: **BAS**
 Date: **March 2016**

1 - Circular Mode of Failure

Report generated using GeoStudio 2012. Copyright © 1991-2016 GEO-SLOPE International Ltd.

File Information

File Version: 8.15
 Title: Static Slope Stability Analyses for Skyline Ranch Development project, Tract 60922, Los Angeles CA
 Comments: Run By: Dr. Alexander Bykovtsev, Ph.D., P.E.
 Last Edited By: Alexander Bykovtsec
 Revision Number: 126
 Date: 3/15/2016
 Time: 10:31:37 AM
 Tool Version: 8.15.5.11777
 File Name: Section 29-29 Cir Static Left SSA for Skyline Ranch.gsz
 Directory: P:\FINAL PROJECTS\PARDEE\Skyline Ranch\SLOPE RESULTS\Section 29-29 results\
 Last Solved Date: 3/15/2016
 Last Solved Time: 10:32:07 AM

Project Settings

Length(L) Units: Feet
 Time(t) Units: Seconds
 Force(F) Units: Pounds
 Pressure(p) Units: psf
 Strength Units: psf
 Unit Weight of Water: 62.4 pcf
 View: 2D
 Element Thickness: 1

Analysis Settings

1 - Circular Mode of Failure

Kind: [SLOPE/W](#)
 Method: [Bishop](#)
 Settings
 PWP Conditions Source: [\(none\)](#)
 Slip Surface
 Direction of movement: [Left to Right](#)
 Use Passive Mode: [No](#)
 Slip Surface Option: [Entry and Exit](#)
 Critical slip surfaces saved: [1](#)
 Resisting Side Maximum Convex Angle: [1°](#)
 Driving Side Maximum Convex Angle: [5°](#)
 Optimize Critical Slip Surface Location: [No](#)
 Tension Crack
 Tension Crack Option: [\(none\)](#)
 F of S Distribution
 F of S Calculation Option: [Constant](#)
 Advanced
 Number of Slices: [30](#)
 F of S Tolerance: [0.01](#)
 Minimum Slip Surface Depth: [0.1 ft](#)

file:///P:/FINAL%20PROJECTS/PARDEE/Skyline%20Ranch/SLOPE%20RESULTS/Sect... 3/15/2016

Materials

TQs 11°

Model: [Anisotropic Fn.](#)
 Unit Weight: [120 pcf](#)
 Cohesion: [225 psf](#)
 Phi: [40°](#)
 Phi-Anisotropic Strength Fn.: [11° \(Along Bedding -10°-\(-25°\)\)](#)
 C-Anisotropic Strength Fn.: [150 pcf \(Along Bedding 10°-25°\)](#)
 Phi-B: [0°](#)

QIs

Model: [Mohr-Coulomb](#)
 Unit Weight: [100 pcf](#)
 Cohesion: [0 psf](#)
 Phi: [20°](#)
 Phi-B: [0°](#)

Fill

Model: [Mohr-Coulomb](#)
 Unit Weight: [120 pcf](#)
 Cohesion: [200 psf](#)
 Phi: [33°](#)
 Phi-B: [0°](#)

Clay

Model: [Mohr-Coulomb](#)
 Unit Weight: [100 pcf](#)
 Cohesion: [150 psf](#)
 Phi: [9°](#)
 Phi-B: [0°](#)

Tmc (-12°)

Model: [Anisotropic Fn.](#)
 Unit Weight: [120 pcf](#)
 Cohesion: [200 psf](#)
 Phi: [40°](#)
 Phi-Anisotropic Strength Fn.: [12° \(Along Bedding -10°-\(-25°\)\)](#)
 C-Anisotropic Strength Fn.: [150 pcf \(Along Bedding 10°-25°\)](#)
 Phi-B: [0°](#)

Tmc (12°)

Model: [Anisotropic Fn.](#)
 Unit Weight: [120 pcf](#)
 Cohesion: [200 psf](#)
 Phi: [40°](#)
 Phi-Anisotropic Strength Fn.: [12° \(Along Bedding 10°-25°\)](#)
 C-Anisotropic Strength Fn.: [150 pcf \(Along Bedding 10°-25°\)](#)
 Phi-B: [0°](#)

Slip Surface Entry and Exit

Left Projection: [Range](#)
 Left-Zone Left Coordinate: [\(-22.2728, 1,831.8909\) ft](#)

file:///P:/FINAL%20PROJECTS/PARDEE/Skyline%20Ranch/SLOPE%20RESULTS/Sect... 3/15/2016

Left-Zone Right Coordinate: (100, 1,854.3684) ft
 Left-Zone Increment: 50
 Right Projection: Range
 Right-Zone Left Coordinate: (253, 1,876.0313) ft
 Right-Zone Right Coordinate: (1,026.6667, 1,782) ft
 Right-Zone Increment: 50
 Radius Increments: 50

Slip Surface Limits

Left Coordinate: (-49, 1,301) ft
 Right Coordinate: (2,050, 1,863) ft

Seismic Coefficients

Horz Seismic Coef.: 0
 Vert Seismic Coef.: 0

Anisotropic Strength Functions

12° (Along Bedding 10°-25°)

Model: Spline Data Point Function
 Function: Modifier Factor vs. Inclination
 Curve Fit to Data: 100 %
 Segment Curvature: 0 %
 Y-Intercept: 1
 Data Points: Inclination (°), Modifier Factor
 Data Point: (-90, 1)
 Data Point: (9.9, 1)
 Data Point: (10, 0.3)
 Data Point: (25, 0.3)
 Data Point: (25.1, 1)

150 pcf (Along Bedding 10°-25°)

Model: Spline Data Point Function
 Function: Modifier Factor vs. Inclination
 Curve Fit to Data: 100 %
 Segment Curvature: 0 %
 Y-Intercept: 1
 Data Points: Inclination (°), Modifier Factor
 Data Point: (-90, 1)
 Data Point: (-25.1, 1)
 Data Point: (-25, 0.667)
 Data Point: (-10, 0.667)
 Data Point: (-9.9, 1)

11° (Along Bedding -10°-(-25°))

Model: Spline Data Point Function
 Function: Modifier Factor vs. Inclination
 Curve Fit to Data: 100 %
 Segment Curvature: 0 %
 Y-Intercept: 1
 Data Points: Inclination (°), Modifier Factor
 Data Point: (-90, 1)
 Data Point: (-25.1, 1)

Data Point: (-25, 0.275)
 Data Point: (-10, 0.275)
 Data Point: (-9.9, 1)

12° (Along Bedding -10°-(-25°))

Model: Spline Data Point Function
 Function: Modifier Factor vs. Inclination
 Curve Fit to Data: 100 %
 Segment Curvature: 0 %
 Y-Intercept: 1
 Data Points: Inclination (°), Modifier Factor
 Data Point: (-90, 1)
 Data Point: (-25.1, 1)
 Data Point: (-25, 0.3)
 Data Point: (-10, 0.3)
 Data Point: (-9.9, 1)

Points

	X (ft)	Y (ft)
Point 1	-47	1,822
Point 2	-7	1,838
Point 3	66	1,849
Point 4	218	1,873
Point 5	238	1,857
Point 6	292	1,830
Point 7	439	1,785
Point 8	634	1,739
Point 9	727	1,729
Point 10	793	1,729
Point 11	831	1,733
Point 12	872	1,737
Point 13	900	1,755
Point 14	929	1,767
Point 15	964	1,776
Point 16	1,022	1,779
Point 17	1,050	1,797
Point 18	1,069	1,809
Point 19	1,173	1,810
Point 20	1,224	1,777
Point 21	1,277	1,738
Point 22	1,312	1,753
Point 23	1,340	1,773
Point 24	1,429	1,777
Point 25	1,546	1,783
Point 26	1,643	1,792
Point 27	1,723	1,801
Point 28	1,769	1,808
Point 29	1,794	1,815
Point 30	1,830	1,823
Point 31	1,851	1,830
Point 32	1,862	1,841

Point 33	1,886	1,843
Point 34	1,913	1,853
Point 35	1,955	1,852
Point 36	1,993	1,862
Point 37	2,050	1,863
Point 38	2,049	1,295
Point 39	-49	1,301
Point 40	244	1,878
Point 41	276	1,871
Point 42	302	1,866
Point 43	324	1,861
Point 44	381	1,852
Point 45	402	1,847
Point 46	458	1,846
Point 47	477	1,845
Point 48	502	1,832
Point 49	531	1,823
Point 50	577	1,810
Point 51	601	1,800
Point 52	634	1,790
Point 53	696	1,771
Point 54	734	1,763
Point 55	805	1,769
Point 56	757	1,793
Point 57	890	1,789
Point 58	1,105	1,828
Point 59	1,137	1,828
Point 60	1,293	1,811
Point 61	1,397	1,816
Point 62	1,492	1,824
Point 63	1,449	1,812
Point 64	1,423	1,810
Point 65	1,372	1,791
Point 66	1,537	1,831
Point 67	1,593	1,846
Point 68	1,637	1,860
Point 69	1,671	1,876
Point 70	1,692	1,876
Point 71	1,720	1,864
Point 72	1,749	1,849
Point 73	1,769	1,843
Point 74	1,788	1,843
Point 75	1,809	1,855
Point 76	1,831	1,855
Point 77	1,839	1,857
Point 78	1,904	1,856
Point 79	1,971	1,856.2105
Point 80	293.0323	1,831
Point 81	311	1,826
Point 82	353	1,813

	439	1,787
Point 84	494	1,774
Point 85	634	1,741
Point 86	727	1,731
Point 87	793	1,731
Point 88	830.2778	1,734
Point 89	494.1087	1,772
Point 90	353	1,811.3265
Point 91	-47.6603	1,650
Point 92	1,343.5556	1,775
Point 93	1,368	1,776
Point 94	1,409	1,778
Point 95	1,429	1,779
Point 96	1,474	1,781
Point 97	1,546	1,785
Point 98	1,643	1,794
Point 99	1,723	1,803
Point 100	1,769	1,810
Point 101	1,793	1,816.12
Point 102	1,474	1,779.3077
Point 103	1,408	1,776.0562
Point 104	1,368	1,774.2584
Point 105	1,175	1,297.4995

Regions

	Material	Points	Area (ft ²)
Region 1	Tmc (12°)	38,37,36,79,35,34,33,32,31,30,29,28,27,26,25,102,24,103,104,23,22,21,20,19,105	4.4177e+005
Region 2	Fill	4,40,41,42,43,80,6,5	2,420
Region 3	Qls	43,80,81,82,83,84,85,86,87,88,55,54,53,52,51,50,49,48,47,46,45,44	24,238
Region 4	Fill	51,56,57,16,15,14,13,12,11,88,55,54,53,52	10,071
Region 5	Fill	19,60,61,62,63,64,65,92,23,22,21,20	9,582
Region 6	Qls	62,63,64,65,92,93,94,95,96,97,98,99,100,101,73,72,71,70,69,68,67,66	20,085
Region 7	Fill	73,74,75,76,77,78,79,35,34,33,32,31,30,29,101	3,204.9
Region 8	Clay	80,6,90,7,89,8,9,10,11,88,87,86,85,84,83,82,81	1,023.3
Region 9	TQs 11°	91,9,8,89,7,90,6,5,4,3,2,1	90,409
Region 10	Clay	92,23,104,103,24,102,25,26,27,28,29,101,100,99,98,97,96,95,94,93	864.17
Region 11	Tmc (-12°)	91,39,105,19,59,58,18,17,16,15,14,13,12,11,10,9	5.1344e+005

Current Slip Surface

Slip Surface: 131,789
 F of S: 3.70
 Volume: 26,037.592 ft³
 Weight: 2,836,160.6 lbs
 Resisting Moment: 2.0433758e+009 lbs-ft
 Activating Moment: 5.5200072e+008 lbs-ft
 F of S Rank (Analysis): 1 of 132,651 slip surfaces
 F of S Rank (Query): 1 of 10 slip surfaces
 Exit: (776.3304, 1,792.4186) ft
 Entry: (99.999997, 1,854.3684) ft
 Radius: 1,543.9323 ft
 Center: (575.54649, 3,323.2396) ft

Slip Slices

	X (ft)	Y (ft)	PWP (psf)	Base Normal Stress (psf)	Frictional Strength (psf)	Cohesive Strength (psf)
Slice 1	111.8	1,850.6524	0	646.10331	125.58976	150.075
Slice 2	135.4	1,843.4266	0	1,941.4647	377.3825	150.075
Slice 3	159	1,836.6106	0	3,190.6562	620.20073	150.075
Slice 4	182.6	1,830.1987	0	4,394.1759	854.14127	150.075
Slice 5	206.2	1,824.1857	0	5,552.4809	1,079.293	150.075
Slice 6	228	1,818.968	0	6,625.0609	1,287.7814	150.075
Slice 7	241	1,815.9917	0	7,278.138	1,414.7267	150.075
Slice 8	260	1,811.9851	0	7,412.2497	1,440.7954	150.075
Slice 9	284	1,807.1059	0	7,400.3269	1,438.4778	150.075
Slice 10	292.51615	1,805.4713	0	7,389.3928	1,436.3525	150.075
Slice 11	297.51615	1,804.5542	0	7,259.2801	1,411.0611	150.075
Slice 12	306.5	1,802.937	0	7,003.0267	1,361.2505	150.075
Slice 13	317.5	1,801.0387	0	6,464.2888	5,424.1824	225
Slice 14	338.5	1,797.6838	0	6,235.7179	5,232.3886	225
Slice 15	367	1,793.5221	0	6,141.564	5,153.3841	225
Slice 16	391.5	1,790.3528	0	5,930.1512	4,975.9877	225
Slice 17	410.83801	1,788.1438	0	5,831.3502	4,893.0838	225
Slice 18	428.51402	1,786.35	0	5,920.9235	4,968.2447	225
Slice 19	438.17601	1,785.4309	0	6,065.567	960.69143	150
Slice 20	444.43466	1,784.8941	0	6,109.1394	967.59263	150
Slice 21	453.93466	1,784.1097	0	6,148.6262	2,237.9169	0
Slice 22	467.5	1,783.122	0	6,195.1591	2,254.8535	0

Slice 23	489.5	1,781.7578	0	5,643.3169	2,053.9994	0
Slice 24	516.5	1,780.505	0	4,681.9156	1,704.0779	0
Slice 25	542.5	1,779.7038	0	3,996.2211	1,454.5055	0
Slice 26	565.5	1,779.3828	0	3,384.5591	1,231.8788	0
Slice 27	589	1,779.4125	0	2,560.9359	932.10443	0
Slice 28	617.5	1,779.9657	0	2,019.9757	735.21104	0
Slice 29	647.57166	1,781.048	0	1,936.4795	704.82091	0
Slice 30	673.12541	1,782.4407	0	1,741.4682	1,130.9227	200
Slice 31	697.08958	1,784.1458	0	1,408.8363	914.90899	200
Slice 32	721.05375	1,786.2263	0	1,028.5467	667.94601	200
Slice 33	745.01792	1,788.6839	0	600.00183	389.64575	200
Slice 34	766.6652	1,791.2129	0	190.4536	123.68202	200

Section 29-29 Cir Seismic Left SSA for Skyline Ranch.gsz

Section 29-29 Cir Seismic Left SSA for Skyline Ranch.gsz Run By: Dr. Alexander Bykovtsev, Ph.D., P.E. 3/15/2016 10:20:28 AM

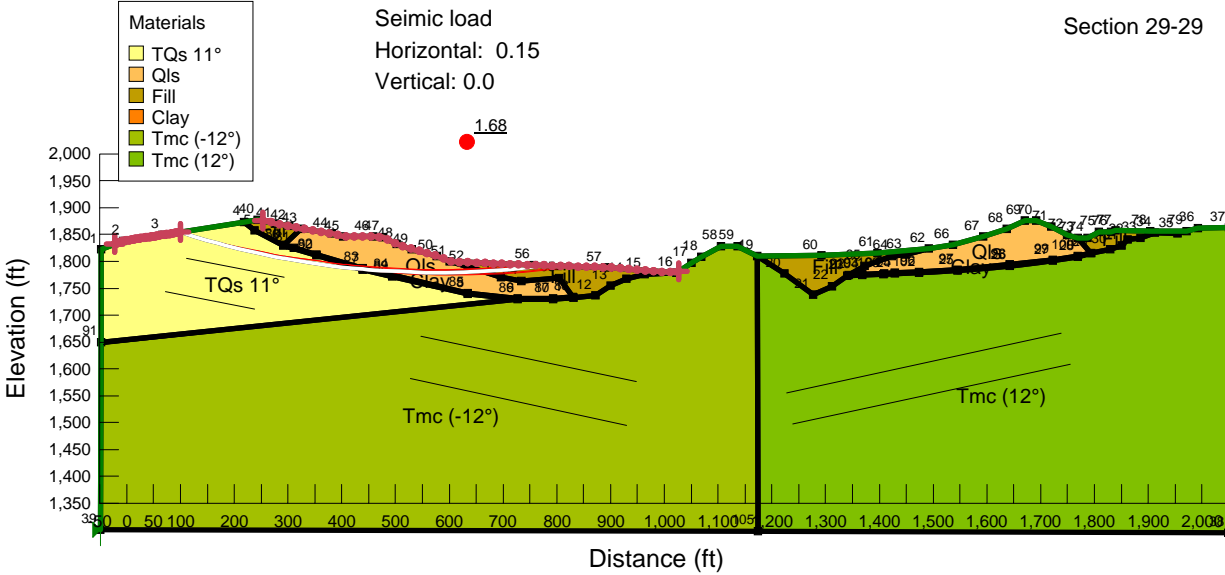

Section 29-29

Name: TQs 11°
 Model: Anisotropic Fn.
 Unit Weight: 120 pcf
 Cohesion: 225 psf
 Phi: 40°
 Phi-Anisotropic Strength Fn.: 11° (Along Bedding -10°-(-25°)
 C-Anisotropic Strength Fn.: 150 pcf (Along Bedding 10°-25°)

Name: Qls
 Model: Mohr-Coulomb
 Unit Weight: 100 pcf
 Cohesion: 0 psf
 Phi: 20°

Name: Fill
 Model: Mohr-Coulomb
 Unit Weight: 120 pcf
 Cohesion: 200 psf
 Phi: 33°

Name: Clay
 Model: Mohr-Coulomb
 Unit Weight: 100 pcf
 Cohesion: 150 psf
 Phi: 9°

Name: Tmc (-12°)
 Model: Anisotropic Fn.
 Unit Weight: 120 pcf
 Cohesion: 200 psf
 Phi: 40°
 Phi-Anisotropic Strength Fn.: 12° (Along Bedding -10°-(-25°)
 C-Anisotropic Strength Fn.: 150 pcf (Along Bedding 10°-25°)

Name: Tmc (12°)
 Model: Anisotropic Fn.
 Unit Weight: 120 pcf
 Cohesion: 200 psf
 Phi: 40°
 Phi-Anisotropic Strength Fn.: 12° (Along Bedding 10°-25°)
 C-Anisotropic Strength Fn.: 150 pcf (Along Bedding 10°-25°)

LGC LGC Valley, Inc
 GEOTECHNICAL CONSULTING
 28532 Constellation Road, Valencia, CA 91355
 Phone 661-702-8474, Fax 661-702-8475

Skyline Ranch
 Development project, Tract 60922
 Los Angeles CA

Project No: **153035-01**
 Engineer: **BAS**
 Date: **March 2016**

1 - Circular Mode of Failure

Report generated using GeoStudio 2012. Copyright © 1991-2016 GEO-SLOPE International Ltd.

File Information

File Version: 8.15
 Title: Static Slope Stability Analyses for Skyline Ranch Development project, Tract 60922, Los Angeles CA
 Comments: Run By: Dr. Alexander Bykovtsev, Ph.D., P.E.
 Last Edited By: Alexander Bykovtsev
 Revision Number: 120
 Date: 3/15/2016
 Time: 10:20:28 AM
 Tool Version: 8.15.5.11777
 File Name: Section 29-29 Cir Seismic Left SSA for Skyline Ranch.gsz
 Directory: P:\FINAL PROJECTS\PARDEE\Skyline Ranch\SLOPE RESULTS\Section 29-29 results\
 Last Solved Date: 3/15/2016
 Last Solved Time: 10:20:58 AM

Project Settings

Length(L) Units: Feet
 Time(t) Units: Seconds
 Force(F) Units: Pounds
 Pressure(p) Units: psf
 Strength Units: psf
 Unit Weight of Water: 62.4 pcf
 View: 2D
 Element Thickness: 1

Analysis Settings

1 - Circular Mode of Failure

Kind: [SLOPE/W](#)
 Method: [Bishop](#)
 Settings
 PWP Conditions Source: [\(none\)](#)
 Slip Surface
 Direction of movement: [Left to Right](#)
 Use Passive Mode: [No](#)
 Slip Surface Option: [Entry and Exit](#)
 Critical slip surfaces saved: [1](#)
 Resisting Side Maximum Convex Angle: [1°](#)
 Driving Side Maximum Convex Angle: [5°](#)
 Optimize Critical Slip Surface Location: [No](#)
 Tension Crack
 Tension Crack Option: [\(none\)](#)
 F of S Distribution
 F of S Calculation Option: [Constant](#)
 Advanced
 Number of Slices: [30](#)
 F of S Tolerance: [0.01](#)
 Minimum Slip Surface Depth: [0.1 ft](#)

file:///P:/FINAL%20PROJECTS/PARDEE/Skyline%20Ranch/SLOPE%20RESULTS/Sect... 3/15/2016

Materials

TQs 11°

Model: [Anisotropic Fn.](#)
 Unit Weight: [120 pcf](#)
 Cohesion: [225 psf](#)
 Phi: [40°](#)
 Phi-Anisotropic Strength Fn.: [11° \(Along Bedding -10°-\(-25°\)\)](#)
 C-Anisotropic Strength Fn.: [150 pcf \(Along Bedding 10°-25°\)](#)
 Phi-B: [0°](#)

QIs

Model: [Mohr-Coulomb](#)
 Unit Weight: [100 pcf](#)
 Cohesion: [0 psf](#)
 Phi: [20°](#)
 Phi-B: [0°](#)

Fill

Model: [Mohr-Coulomb](#)
 Unit Weight: [120 pcf](#)
 Cohesion: [200 psf](#)
 Phi: [33°](#)
 Phi-B: [0°](#)

Clay

Model: [Mohr-Coulomb](#)
 Unit Weight: [100 pcf](#)
 Cohesion: [150 psf](#)
 Phi: [9°](#)
 Phi-B: [0°](#)

Tmc (-12°)

Model: [Anisotropic Fn.](#)
 Unit Weight: [120 pcf](#)
 Cohesion: [200 psf](#)
 Phi: [40°](#)
 Phi-Anisotropic Strength Fn.: [12° \(Along Bedding -10°-\(-25°\)\)](#)
 C-Anisotropic Strength Fn.: [150 pcf \(Along Bedding 10°-25°\)](#)
 Phi-B: [0°](#)

Tmc (12°)

Model: [Anisotropic Fn.](#)
 Unit Weight: [120 pcf](#)
 Cohesion: [200 psf](#)
 Phi: [40°](#)
 Phi-Anisotropic Strength Fn.: [12° \(Along Bedding 10°-25°\)](#)
 C-Anisotropic Strength Fn.: [150 pcf \(Along Bedding 10°-25°\)](#)
 Phi-B: [0°](#)

Slip Surface Entry and Exit

Left Projection: [Range](#)
 Left-Zone Left Coordinate: [\(-22.2728, 1,831.8909\) ft](#)

file:///P:/FINAL%20PROJECTS/PARDEE/Skyline%20Ranch/SLOPE%20RESULTS/Sect... 3/15/2016

Left-Zone Right Coordinate: (100, 1,854.3684) ft
 Left-Zone Increment: 50
 Right Projection: Range
 Right-Zone Left Coordinate: (253, 1,876.0313) ft
 Right-Zone Right Coordinate: (1,026.6667, 1,782) ft
 Right-Zone Increment: 50
 Radius Increments: 50

Slip Surface Limits

Left Coordinate: (-49, 1,301) ft
 Right Coordinate: (2,050, 1,863) ft

Seismic Coefficients

Horz Seismic Coef.: 0.15
 Vert Seismic Coef.: 0

Anisotropic Strength Functions

12° (Along Bedding 10°-25°)

Model: Spline Data Point Function
 Function: Modifier Factor vs. Inclination
 Curve Fit to Data: 100 %
 Segment Curvature: 0 %
 Y-Intercept: 1
 Data Points: Inclination (°), Modifier Factor
 Data Point: (-90, 1)
 Data Point: (9.9, 1)
 Data Point: (10, 0.3)
 Data Point: (25, 0.3)
 Data Point: (25.1, 1)

150 pcf (Along Bedding 10°-25°)

Model: Spline Data Point Function
 Function: Modifier Factor vs. Inclination
 Curve Fit to Data: 100 %
 Segment Curvature: 0 %
 Y-Intercept: 1
 Data Points: Inclination (°), Modifier Factor
 Data Point: (-90, 1)
 Data Point: (-25.1, 1)
 Data Point: (-25, 0.667)
 Data Point: (-10, 0.667)
 Data Point: (-9.9, 1)

11° (Along Bedding -10°-(-25°))

Model: Spline Data Point Function
 Function: Modifier Factor vs. Inclination
 Curve Fit to Data: 100 %
 Segment Curvature: 0 %
 Y-Intercept: 1
 Data Points: Inclination (°), Modifier Factor
 Data Point: (-90, 1)
 Data Point: (-25.1, 1)

Data Point: (-25, 0.275)
 Data Point: (-10, 0.275)
 Data Point: (-9.9, 1)

12° (Along Bedding -10°-(-25°))

Model: Spline Data Point Function
 Function: Modifier Factor vs. Inclination
 Curve Fit to Data: 100 %
 Segment Curvature: 0 %
 Y-Intercept: 1
 Data Points: Inclination (°), Modifier Factor
 Data Point: (-90, 1)
 Data Point: (-25.1, 1)
 Data Point: (-25, 0.3)
 Data Point: (-10, 0.3)
 Data Point: (-9.9, 1)

Points

	X (ft)	Y (ft)
Point 1	-47	1,822
Point 2	-7	1,838
Point 3	66	1,849
Point 4	218	1,873
Point 5	238	1,857
Point 6	292	1,830
Point 7	439	1,785
Point 8	634	1,739
Point 9	727	1,729
Point 10	793	1,729
Point 11	831	1,733
Point 12	872	1,737
Point 13	900	1,755
Point 14	929	1,767
Point 15	964	1,776
Point 16	1,022	1,779
Point 17	1,050	1,797
Point 18	1,069	1,809
Point 19	1,173	1,810
Point 20	1,224	1,777
Point 21	1,277	1,738
Point 22	1,312	1,753
Point 23	1,340	1,773
Point 24	1,429	1,777
Point 25	1,546	1,783
Point 26	1,643	1,792
Point 27	1,723	1,801
Point 28	1,769	1,808
Point 29	1,794	1,815
Point 30	1,830	1,823
Point 31	1,851	1,830
Point 32	1,862	1,841

Point 33	1,886	1,843
Point 34	1,913	1,853
Point 35	1,955	1,852
Point 36	1,993	1,862
Point 37	2,050	1,863
Point 38	2,049	1,295
Point 39	-49	1,301
Point 40	244	1,878
Point 41	276	1,871
Point 42	302	1,866
Point 43	324	1,861
Point 44	381	1,852
Point 45	402	1,847
Point 46	458	1,846
Point 47	477	1,845
Point 48	502	1,832
Point 49	531	1,823
Point 50	577	1,810
Point 51	601	1,800
Point 52	634	1,790
Point 53	696	1,771
Point 54	734	1,763
Point 55	805	1,769
Point 56	757	1,793
Point 57	890	1,789
Point 58	1,105	1,828
Point 59	1,137	1,828
Point 60	1,293	1,811
Point 61	1,397	1,816
Point 62	1,492	1,824
Point 63	1,449	1,812
Point 64	1,423	1,810
Point 65	1,372	1,791
Point 66	1,537	1,831
Point 67	1,593	1,846
Point 68	1,637	1,860
Point 69	1,671	1,876
Point 70	1,692	1,876
Point 71	1,720	1,864
Point 72	1,749	1,849
Point 73	1,769	1,843
Point 74	1,788	1,843
Point 75	1,809	1,855
Point 76	1,831	1,855
Point 77	1,839	1,857
Point 78	1,904	1,856
Point 79	1,971	1,856.2105
Point 80	293.0323	1,831
Point 81	311	1,826
Point 82	353	1,813

	439	1,787
Point 84	494	1,774
Point 85	634	1,741
Point 86	727	1,731
Point 87	793	1,731
Point 88	830.2778	1,734
Point 89	494.1087	1,772
Point 90	353	1,811.3265
Point 91	-47.6603	1,650
Point 92	1,343.5556	1,775
Point 93	1,368	1,776
Point 94	1,409	1,778
Point 95	1,429	1,779
Point 96	1,474	1,781
Point 97	1,546	1,785
Point 98	1,643	1,794
Point 99	1,723	1,803
Point 100	1,769	1,810
Point 101	1,793	1,816.12
Point 102	1,474	1,779.3077
Point 103	1,408	1,776.0562
Point 104	1,368	1,774.2584
Point 105	1,175	1,297.4995

Regions

	Material	Points	Area (ft ²)
Region 1	Tmc (12°)	38,37,36,79,35,34,33,32,31,30,29,28,27,26,25,102,24,103,104,23,22,21,20,19,105	4.4177e+005
Region 2	Fill	4,40,41,42,43,80,6,5	2,420
Region 3	Qls	43,80,81,82,83,84,85,86,87,88,55,54,53,52,51,50,49,48,47,46,45,44	24,238
Region 4	Fill	51,56,57,16,15,14,13,12,11,88,55,54,53,52	10,071
Region 5	Fill	19,60,61,62,63,64,65,92,23,22,21,20	9,582
Region 6	Qls	62,63,64,65,92,93,94,95,96,97,98,99,100,101,73,72,71,70,69,68,67,66	20,085
Region 7	Fill	73,74,75,76,77,78,79,35,34,33,32,31,30,29,101	3,204.9
Region 8	Clay	80,6,90,7,89,8,9,10,11,88,87,86,85,84,83,82,81	1,023.3
Region 9	TQs 11°	91,9,8,89,7,90,6,5,4,3,2,1	90,409
Region 10	Clay	92,23,104,103,24,102,25,26,27,28,29,101,100,99,98,97,96,95,94,93	864.17
Region 11	Tmc (-12°)	91,39,105,19,59,58,18,17,16,15,14,13,12,11,10,9	5.1344e+005

Current Slip Surface

Slip Surface: 131,789
 F of S: 1.68
 Volume: 26,037.592 ft³
 Weight: 2,836,160.6 lbs
 Resisting Moment: 2.0043215e+009 lbs-ft
 Activating Moment: 1.1898783e+009 lbs-ft
 F of S Rank (Analysis): 1 of 132,651 slip surfaces
 F of S Rank (Query): 1 of 10 slip surfaces
 Exit: (776.3304, 1,792.4186) ft
 Entry: (99.999997, 1,854.3684) ft
 Radius: 1,543.9323 ft
 Center: (575.54649, 3,323.2396) ft

Slip Slices

	X (ft)	Y (ft)	PWP (psf)	Base Normal Stress (psf)	Frictional Strength (psf)	Cohesive Strength (psf)
Slice 1	111.8	1,850.6524	0	619.17359	120.35515	150.075
Slice 2	135.4	1,843.4266	0	1,892.7038	367.90435	150.075
Slice 3	159	1,836.6106	0	3,123.4463	607.13645	150.075
Slice 4	182.6	1,830.1987	0	4,311.7169	838.11286	150.075
Slice 5	206.2	1,824.1857	0	5,457.8001	1,060.8889	150.075
Slice 6	228	1,818.968	0	6,521.0424	1,267.5622	150.075
Slice 7	241	1,815.9917	0	7,169.2748	1,393.5658	150.075
Slice 8	260	1,811.9851	0	7,307.9816	1,420.5277	150.075
Slice 9	284	1,807.1059	0	7,304.2614	1,419.8046	150.075
Slice 10	292.51615	1,805.4713	0	7,296.2975	1,418.2566	150.075
Slice 11	297.51615	1,804.5542	0	7,169.3073	1,393.5722	150.075
Slice 12	306.5	1,802.937	0	6,918.7709	1,344.8728	150.075
Slice 13	317.5	1,801.0387	0	6,180.3396	5,185.9207	225
Slice 14	338.5	1,797.6838	0	5,982.6499	5,020.0393	225
Slice 15	367	1,793.5221	0	5,920.8056	4,968.1458	225
Slice 16	391.5	1,790.3528	0	5,740.7116	4,817.029	225
Slice 17	410.83801	1,788.1438	0	5,663.7561	4,752.4557	225
Slice 18	428.51402	1,786.35	0	5,768.4606	4,840.3132	225
Slice 19	438.17601	1,785.4309	0	6,033.9403	955.68226	150
Slice 20	444.43466	1,784.8941	0	6,078.7652	962.78182	150
Slice 21	453.93466	1,784.1097	0	6,092.7393	2,217.5757	0
Slice 22	467.5	1,783.122	0	6,145.0686	2,236.6221	0

Slice 23	489.5	1,781.7578	0	5,606.9006	2,040.7449	0
Slice 24	516.5	1,780.505	0	4,661.1226	1,696.5099	0
Slice 25	542.5	1,779.7038	0	3,986.2575	1,450.8791	0
Slice 26	565.5	1,779.3828	0	3,381.986	1,230.9422	0
Slice 27	589	1,779.4125	0	2,563.5517	933.0565	0
Slice 28	617.5	1,779.9657	0	2,026.4378	737.56303	0
Slice 29	647.57166	1,781.048	0	1,947.1675	708.71101	0
Slice 30	673.12541	1,782.4407	0	1,769.2355	1,148.955	200
Slice 31	697.08958	1,784.1458	0	1,438.0211	933.8618	200
Slice 32	721.05375	1,786.2263	0	1,055.9534	685.74418	200
Slice 33	745.01792	1,788.6839	0	621.85928	403.84014	200
Slice 34	766.6652	1,791.2129	0	204.08524	132.53451	200

Section 29-29 tran Static Left SSA for Skyline Ranch.gsz

Section 29-29 tran Static Left SSA for Skyline Ranch.gsz Run By: Dr. Alexander Bykovtsev, Ph.D., P.E. 3/15/2016 11:43:23 AM

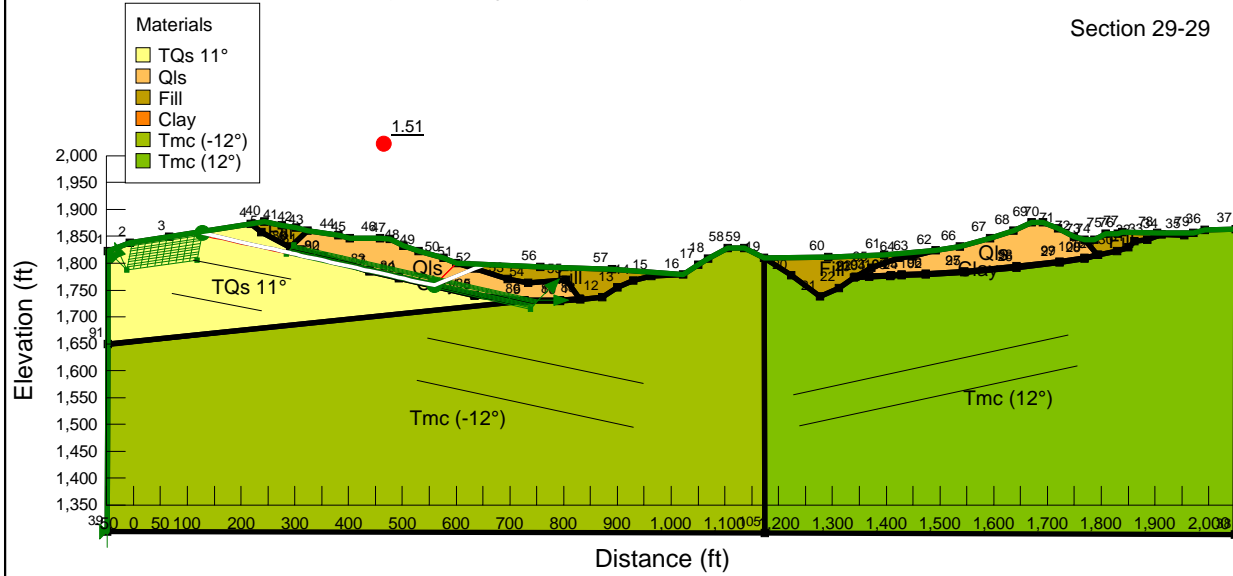

- Name: TQs 11°
Model: Anisotropic Fn.
Unit Weight: 120 pcf
Cohesion: 225 psf
Phi: 40°
Phi-Anisotropic Strength Fn.: 11° (Along Bedding -10°-(-2)
C-Anisotropic Strength Fn.: 150 pcf (Along Bedding 10°-2)
- Name: Qls
Model: Mohr-Coulomb
Unit Weight: 100 pcf
Cohesion: 0 psf
Phi: 20°
- Name: Fill
Model: Mohr-Coulomb
Unit Weight: 120 pcf
Cohesion: 200 psf
Phi: 33°
- Name: Clay
Model: Mohr-Coulomb
Unit Weight: 100 pcf
Cohesion: 150 psf
Phi: 9°
- Name: Tmc (-12°)
Model: Anisotropic Fn.
Unit Weight: 120 pcf
Cohesion: 200 psf
Phi: 40°
Phi-Anisotropic Strength Fn.: 12° (Along Bedding -10°-(-2)
C-Anisotropic Strength Fn.: 150 pcf (Along Bedding 10°-2)
- Name: Tmc (12°)
Model: Anisotropic Fn.
Unit Weight: 120 pcf
Cohesion: 200 psf
Phi: 40°
Phi-Anisotropic Strength Fn.: 12° (Along Bedding 10°-25°)
C-Anisotropic Strength Fn.: 150 pcf (Along Bedding 10°-2)

LGC LGC Valley, Inc
 GEOTECHNICAL CONSULTING
 28532 Constellation Road, Valencia, CA 91355
 Phone 661-702-8474, Fax 661-702-8475

Skyline Ranch
 Development project, Tract 60922
 Los Angeles CA

Project No: **153035-01**
 Engineer: **BAS**
 Date: **March 2016**

2 - Translational

Report generated using GeoStudio 2012. Copyright © 1991-2016 GEO-SLOPE International Ltd.

File Information

File Version: 8.15
 Title: Static Slope Stability Analyses for Skyline Ranch Development project, Tract 60922, Los Angeles CA
 Comments: Run By: Dr. Alexander Bykovtsev, Ph.D., P.E.
 Last Edited By: Alexander Bykovtsev
 Revision Number: 144
 Date: 3/15/2016
 Time: 11:43:23 AM
 Tool Version: 8.15.5.11777
 File Name: Section 29-29 tran Static Left SSA for Skyline Ranch.gsz
 Directory: P:\FINAL PROJECTS\PARDEE\Skyline Ranch\SLOPE RESULTS\Section 29-29 results\
 Last Solved Date: 3/15/2016
 Last Solved Time: 11:43:51 AM

Project Settings

Length(L) Units: Feet
 Time(t) Units: Seconds
 Force(F) Units: Pounds
 Pressure(p) Units: psf
 Strength Units: psf
 Unit Weight of Water: 62.4 pcf
 View: 2D
 Element Thickness: 1

Analysis Settings

2 - Translational

Kind: [SLOPE/W](#)
 Method: [Janbu](#)
 Settings
 PWP Conditions Source: [\(none\)](#)
 Slip Surface
 Direction of movement: [Left to Right](#)
 Use Passive Mode: [No](#)
 Slip Surface Option: [Block](#)
 Critical slip surfaces saved: [10](#)
 Resisting Side Maximum Convex Angle: [1°](#)
 Driving Side Maximum Convex Angle: [5°](#)
 Restrict Block Crossing: [No](#)
 Optimize Critical Slip Surface Location: [No](#)
 Tension Crack
 Tension Crack Option: [\(none\)](#)
 F of S Distribution
 F of S Calculation Option: [Constant](#)
 Advanced
 Number of Slices: [30](#)
 F of S Tolerance: [0.01](#)
 Minimum Slip Surface Depth: [0.1 ft](#)

file:///P:/FINAL%20PROJECTS/PARDEE/Skyline%20Ranch/SLOPE%20RESULTS/Sect... 3/15/2016

Materials

TQs 11°

Model: [Anisotropic Fn.](#)
 Unit Weight: [120 pcf](#)
 Cohesion: [225 psf](#)
 Phi: [40°](#)
 Phi-Anisotropic Strength Fn.: [11° \(Along Bedding -10°-\(-25°\)](#)
 C-Anisotropic Strength Fn.: [150 pcf \(Along Bedding 10°-25°\)](#)
 Phi-B: [0°](#)

QIs

Model: [Mohr-Coulomb](#)
 Unit Weight: [100 pcf](#)
 Cohesion: [0 psf](#)
 Phi: [20°](#)
 Phi-B: [0°](#)

Fill

Model: [Mohr-Coulomb](#)
 Unit Weight: [120 pcf](#)
 Cohesion: [200 psf](#)
 Phi: [33°](#)
 Phi-B: [0°](#)

Clay

Model: [Mohr-Coulomb](#)
 Unit Weight: [100 pcf](#)
 Cohesion: [150 psf](#)
 Phi: [9°](#)
 Phi-B: [0°](#)

Tmc (-12°)

Model: [Anisotropic Fn.](#)
 Unit Weight: [120 pcf](#)
 Cohesion: [200 psf](#)
 Phi: [40°](#)
 Phi-Anisotropic Strength Fn.: [12° \(Along Bedding -10°-\(-25°\)](#)
 C-Anisotropic Strength Fn.: [150 pcf \(Along Bedding 10°-25°\)](#)
 Phi-B: [0°](#)

Tmc (12°)

Model: [Anisotropic Fn.](#)
 Unit Weight: [120 pcf](#)
 Cohesion: [200 psf](#)
 Phi: [40°](#)
 Phi-Anisotropic Strength Fn.: [12° \(Along Bedding 10°-25°\)](#)
 C-Anisotropic Strength Fn.: [150 pcf \(Along Bedding 10°-25°\)](#)
 Phi-B: [0°](#)

Slip Surface Limits

Left Coordinate: [\(-49, 1,301\) ft](#)
 Right Coordinate: [\(2,050, 1,863\) ft](#)

file:///P:/FINAL%20PROJECTS/PARDEE/Skyline%20Ranch/SLOPE%20RESULTS/Sect... 3/15/2016

Slip Surface Block

Left Grid

Upper Left: (-3, 1,837) ft
 Lower Left: (-12.7508, 1,787.0822) ft
 Lower Right: (119, 1,806) ft
 X Increments: 10
 Y Increments: 10
 Starting Angle: 115 °
 Ending Angle: 135 °
 Angle Increments: 2

Right Grid

Upper Left: (298, 1,834) ft
 Lower Left: (284, 1,817) ft
 Lower Right: (738, 1,714) ft
 X Increments: 10
 Y Increments: 10
 Starting Angle: 0 °
 Ending Angle: 45 °
 Angle Increments: 2

Seismic Coefficients

Horz Seismic Coef.: 0
 Vert Seismic Coef.: 0

Anisotropic Strength Functions

12° (Along Bedding 10°-25°)

Model: Spline Data Point Function
 Function: Modifier Factor vs. Inclination
 Curve Fit to Data: 100 %
 Segment Curvature: 0 %
 Y-Intercept: 1
 Data Points: Inclination (°), Modifier Factor
 Data Point: (-90, 1)
 Data Point: (9.9, 1)
 Data Point: (10, 0.3)
 Data Point: (25, 0.3)
 Data Point: (25.1, 1)

150 pcf (Along Bedding 10°-25°)

Model: Spline Data Point Function
 Function: Modifier Factor vs. Inclination
 Curve Fit to Data: 100 %
 Segment Curvature: 0 %
 Y-Intercept: 1
 Data Points: Inclination (°), Modifier Factor
 Data Point: (-90, 1)
 Data Point: (-25.1, 1)
 Data Point: (-25, 0.667)
 Data Point: (-10, 0.667)
 Data Point: (-9.9, 1)

11° (Along Bedding -10°-(-25°))

Model: Spline Data Point Function
 Function: Modifier Factor vs. Inclination
 Curve Fit to Data: 100 %
 Segment Curvature: 0 %
 Y-Intercept: 1
 Data Points: Inclination (°), Modifier Factor
 Data Point: (-90, 1)
 Data Point: (-25.1, 1)
 Data Point: (-25, 0.275)
 Data Point: (-10, 0.275)
 Data Point: (-9.9, 1)

12° (Along Bedding -10°-(-25°))

Model: Spline Data Point Function
 Function: Modifier Factor vs. Inclination
 Curve Fit to Data: 100 %
 Segment Curvature: 0 %
 Y-Intercept: 1
 Data Points: Inclination (°), Modifier Factor
 Data Point: (-90, 1)
 Data Point: (-25.1, 1)
 Data Point: (-25, 0.3)
 Data Point: (-10, 0.3)
 Data Point: (-9.9, 1)

Points

	X (ft)	Y (ft)
Point 1	-47	1,822
Point 2	-7	1,838
Point 3	66	1,849
Point 4	218	1,873
Point 5	238	1,857
Point 6	292	1,830
Point 7	439	1,785
Point 8	634	1,739
Point 9	727	1,729
Point 10	793	1,729
Point 11	831	1,733
Point 12	872	1,737
Point 13	900	1,755
Point 14	929	1,767
Point 15	964	1,776
Point 16	1,022	1,779
Point 17	1,050	1,797
Point 18	1,069	1,809
Point 19	1,173	1,810
Point 20	1,224	1,777
Point 21	1,277	1,738
Point 22	1,312	1,753
Point 23	1,340	1,773

Point 24	1,429	1,777
Point 25	1,546	1,783
Point 26	1,643	1,792
Point 27	1,723	1,801
Point 28	1,769	1,808
Point 29	1,794	1,815
Point 30	1,830	1,823
Point 31	1,851	1,830
Point 32	1,862	1,841
Point 33	1,886	1,843
Point 34	1,913	1,853
Point 35	1,955	1,852
Point 36	1,993	1,862
Point 37	2,050	1,863
Point 38	2,049	1,295
Point 39	-49	1,301
Point 40	244	1,878
Point 41	276	1,871
Point 42	302	1,866
Point 43	324	1,861
Point 44	381	1,852
Point 45	402	1,847
Point 46	458	1,846
Point 47	477	1,845
Point 48	502	1,832
Point 49	531	1,823
Point 50	577	1,810
Point 51	601	1,800
Point 52	634	1,790
Point 53	696	1,771
Point 54	734	1,763
Point 55	805	1,769
Point 56	757	1,793
Point 57	890	1,789
Point 58	1,105	1,828
Point 59	1,137	1,828
Point 60	1,293	1,811
Point 61	1,397	1,816
Point 62	1,492	1,824
Point 63	1,449	1,812
Point 64	1,423	1,810
Point 65	1,372	1,791
Point 66	1,537	1,831
Point 67	1,593	1,846
Point 68	1,637	1,860
Point 69	1,671	1,876
Point 70	1,692	1,876
Point 71	1,720	1,864
Point 72	1,749	1,849
Point 73	1,769	1,843

	1,788	1,843
Point 75	1,809	1,855
Point 76	1,831	1,855
Point 77	1,839	1,857
Point 78	1,904	1,856
Point 79	1,971	1,856.2105
Point 80	293.0323	1,831
Point 81	311	1,826
Point 82	353	1,813
Point 83	439	1,787
Point 84	494	1,774
Point 85	634	1,741
Point 86	727	1,731
Point 87	793	1,731
Point 88	830.2778	1,734
Point 89	494.1087	1,772
Point 90	353	1,811.3265
Point 91	-47.6603	1,650
Point 92	1,343.5556	1,775
Point 93	1,368	1,776
Point 94	1,409	1,778
Point 95	1,429	1,779
Point 96	1,474	1,781
Point 97	1,546	1,785
Point 98	1,643	1,794
Point 99	1,723	1,803
Point 100	1,769	1,810
Point 101	1,793	1,816.12
Point 102	1,474	1,779.3077
Point 103	1,408	1,776.0562
Point 104	1,368	1,774.2584
Point 105	1,175	1,297.4995

Regions

	Material	Points	Area (ft ²)
Region 1	Tmc (12")	38,37,36,79,35,34,33,32,31,30,29,28,27,26,25,102,24,103,104,23,22,21,20,19,105	4.4177e+005
Region 2	Fill	4,40,41,42,43,80,6,5	2,420
Region 3	Qls	43,80,81,82,83,84,85,86,87,88,55,54,53,52,51,50,49,48,47,46,45,44	24,238
Region 4	Fill	51,56,57,16,15,14,13,12,11,88,55,54,53,52	10,071
Region 5	Fill	19,60,61,62,63,64,65,92,23,22,21,20	9,582
Region 6	Qls	62,63,64,65,92,93,94,95,96,97,98,99,100,101,73,72,71,70,69,68,67,66	20,085
Region 7	Fill	73,74,75,76,77,78,79,35,34,33,32,31,30,29,101	3,204.9
Region			

8	Clay	80,6,90,7,89,8,9,10,11,88,87,86,85,84,83,82,81	1,023.3
Region 9	TQs 11°	91,9,8,89,7,90,6,5,4,3,2,1	90,409
Region 10	Clay	92,23,104,103,24,102,25,26,27,28,29,101,100,99,98,97,96,95,94,93	864.17
Region 11	Tmc (-12°)	91,39,105,19,59,58,18,17,16,15,14,13,12,11,10,9	5.1344e+005

Current Slip Surface

Slip Surface: 131,129
 F of S: 1.51
 Volume: 22,657.342 ft³
 Weight: 2,402,188.3 lbs
 Resisting Force: 549,522.64 lbs
 Activating Force: 363,229.78 lbs
 F of S Rank (Analysis): 1 of 131,769 slip surfaces
 F of S Rank (Query): 1 of 10 slip surfaces
 Exit: (653.46491, 1,797.6458) ft
 Entry: (126.86547, 1,858.6103) ft
 Radius: 205.08914 ft
 Center: (395.4586, 1,873.8515) ft

Slip Slices

	X (ft)	Y (ft)	PWP (psf)	Base Normal Stress (psf)	Frictional Strength (psf)	Cohesive Strength (psf)
Slice 1	127.80813	1,857.2641	0	-18.087581	-15.177283	225
Slice 2	137.67572	1,853.9	0	726.65461	141.24735	150.075
Slice 3	155.52556	1,849.8644	0	1,525.9783	296.62013	150.075
Slice 4	173.3754	1,845.8289	0	2,325.302	451.99292	150.075
Slice 5	191.22524	1,841.7933	0	3,124.6257	607.36571	150.075
Slice 6	209.07508	1,837.7577	0	3,923.9494	762.73849	150.075
Slice 7	228	1,833.4791	0	4,811.5487	935.27033	150.075
Slice 8	241	1,830.54	0	5,445.8675	1,058.5694	150.075
Slice 9	252	1,828.0531	0	5,599.0915	1,088.3531	150.075
Slice 10	268	1,824.4357	0	5,612.7769	1,091.0133	150.075
Slice 11	284	1,820.8184	0	5,651.1324	1,098.4689	150.075
Slice 12	292.51615	1,818.893	0	5,671.8887	1,102.5035	150.075
Slice 13	297.51615	1,817.7626	0	5,567.6858	1,082.2485	150.075
Slice 14	306.5	1,815.7315	0	5,362.1069	1,042.288	150.075
Slice 15	317.5	1,813.2446	0	5,088.005	989.00799	150.075
Slice 16	331.25	1,810.1359	0	4,962.8026	964.67111	150.075
Slice 17	345.75	1,806.8577	0	5,036.3364	978.96462	150.075
Slice 18	360	1,803.636	0	5,108.6024	993.01172	150.075
Slice						

19	374	1,800.4708	0	5,179.6008	1,006.8124	150.075
Slice 20	391.5	1,796.5143	0	5,186.5087	1,008.1552	150.075
Slice 21	408.82823	1,792.5967	0	5,285.4748	1,027.3922	150.075
Slice 22	422.4847	1,789.5092	0	5,540.5896	1,076.9815	150.075
Slice 23	434.15647	1,786.8704	0	5,796.3894	918.05788	150
Slice 24	448.5	1,783.6275	0	6,088.1742	964.27207	150
Slice 25	467.5	1,779.3319	0	6,442.4099	1,020.3775	150
Slice 26	485.5	1,775.2624	0	6,359.3225	1,007.2177	150
Slice 27	498	1,772.4364	0	6,000.3987	950.3698	150
Slice 28	509.25	1,769.8929	0	5,825.8628	922.72601	150
Slice 29	523.75	1,766.6147	0	5,706.502	903.82112	150
Slice 30	538.05	1,763.3817	0	5,607.8907	888.20263	150
Slice 31	552.17418	1,760.2039	0	5,529.8284	875.83878	150
Slice 32	568.12418	1,762.2965	0	5,575.1629	2,029.1933	0
Slice 33	589	1,770.9436	0	3,781.3804	1,376.3099	0
Slice 34	609.25	1,779.3314	0	2,301.0854	837.52658	0
Slice 35	626.03919	1,786.2857	0	1,539.5842	560.36284	0
Slice 36	644.02165	1,793.7343	0	698.70594	453.74494	200

Section 29-29 tran Seismic Left SSA for Skyline Ranch.gsz

Section 29-29 tran Seismic Left SSA for Skyline Ranch.gsz Run By: Dr. Alexander Bykovtsev, Ph.D., P.E. 3/15/2016 12:23:33 PM

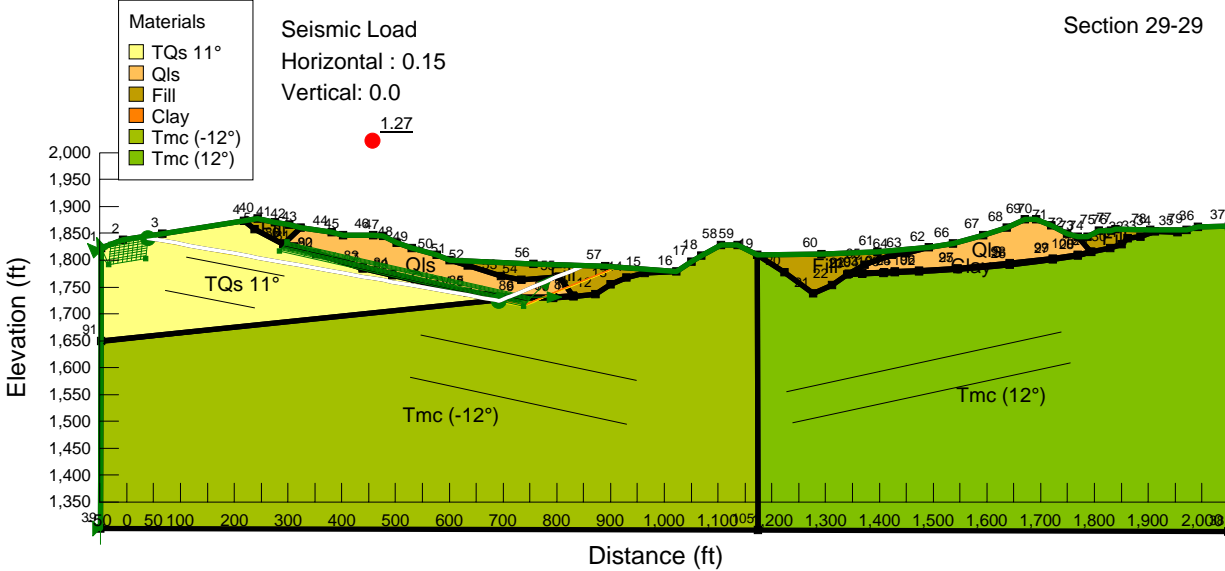

Name: TQs 11°
Model: Anisotropic Fn.
Unit Weight: 120 pcf
Cohesion: 225 psf
Phi: 40°
Phi-Anisotropic Strength Fn.: 11° (Along Bedding -10°-(-25)
C-Anisotropic Strength Fn.: 150 pcf (Along Bedding 10°-25)

Name: QIs
Model: Mohr-Coulomb
Unit Weight: 100 pcf
Cohesion: 0 psf
Phi: 20°

Name: Fill
Model: Mohr-Coulomb
Unit Weight: 120 pcf
Cohesion: 200 psf
Phi: 33°

Name: Clay
Model: Mohr-Coulomb
Unit Weight: 100 pcf
Cohesion: 150 psf
Phi: 9°

Name: Tmc (-12°)
Model: Anisotropic Fn.
Unit Weight: 120 pcf
Cohesion: 200 psf
Phi: 40°
Phi-Anisotropic Strength Fn.: 12° (Along Bedding -10°-(-25)
C-Anisotropic Strength Fn.: 150 pcf (Along Bedding 10°-25)

Name: Tmc (12°)
Model: Anisotropic Fn.
Unit Weight: 120 pcf
Cohesion: 200 psf
Phi: 40°
Phi-Anisotropic Strength Fn.: 12° (Along Bedding 10°-25°)
C-Anisotropic Strength Fn.: 150 pcf (Along Bedding 10°-25)

LGC **LGC Valley, Inc**
GEOTECHNICAL CONSULTING
28532 Constellation Road, Valencia, CA 91355
Phone 661-702-8474, Fax 661-702-8475

Skyline Ranch
Development project, Tract 60922
Los Angeles CA

Project No: **153035-01**
Engineer: **BAS**
Date: **March 2016**

2 - Translational

Report generated using GeoStudio 2012. Copyright © 1991-2016 GEO-SLOPE International Ltd.

File Information

File Version: 8.15
 Title: Static Slope Stability Analyses for Skyline Ranch Development project, Tract 60922, Los Angeles CA
 Comments: Run By: Dr. Alexander Bykovtsev, Ph.D., P.E.
 Last Edited By: Alexander Bykovtsev
 Revision Number: 153
 Date: 3/15/2016
 Time: 12:23:33 PM
 Tool Version: 8.15.5.11777
 File Name: Section 29-29 tran Seismic Left SSA for Skyline Ranch.gsz
 Directory: P:\FINAL PROJECTS\PARDEE\Skyline Ranch\SLOPE RESULTS\Section 29-29 results\
 Last Solved Date: 3/15/2016
 Last Solved Time: 12:26:16 PM

Project Settings

Length(L) Units: Feet
 Time(t) Units: Seconds
 Force(F) Units: Pounds
 Pressure(p) Units: psf
 Strength Units: psf
 Unit Weight of Water: 62.4 pcf
 View: 2D
 Element Thickness: 1

Analysis Settings

2 - Translational

Kind: SLOPE/W
 Method: Spencer
 Settings
 PWP Conditions Source: (none)
 Slip Surface
 Direction of movement: Left to Right
 Use Passive Mode: No
 Slip Surface Option: Block
 Critical slip surfaces saved: 10
 Resisting Side Maximum Convex Angle: 1 °
 Driving Side Maximum Convex Angle: 5 °
 Restrict Block Crossing: No
 Optimize Critical Slip Surface Location: No
 Tension Crack
 Tension Crack Option: (none)
 F of S Distribution
 F of S Calculation Option: Constant
 Advanced
 Number of Slices: 30
 F of S Tolerance: 0.01
 Minimum Slip Surface Depth: 0.1 ft
 Search Method: Root Finder

file:///P:/FINAL%20PROJECTS/PARDEE/Skyline%20Ranch/SLOPE%20RESULTS/Sect... 3/15/2016

Tolerable difference between starting and converged F of S: 3
 Maximum iterations to calculate converged lambda: 20
 Max Absolute Lambda: 2

Materials

TQs 11°

Model: Anisotropic Fn.
 Unit Weight: 120 pcf
 Cohesion: 225 psf
 Phi: 40 °
 Phi-Anisotropic Strength Fn.: 11° (Along Bedding -10°-(-25°)
 C-Anisotropic Strength Fn.: 150 pcf (Along Bedding 10°-25°)
 Phi-B: 0 °

QJs

Model: Mohr-Coulomb
 Unit Weight: 100 pcf
 Cohesion: 0 psf
 Phi: 20 °
 Phi-B: 0 °

Fill

Model: Mohr-Coulomb
 Unit Weight: 120 pcf
 Cohesion: 200 psf
 Phi: 33 °
 Phi-B: 0 °

Clay

Model: Mohr-Coulomb
 Unit Weight: 100 pcf
 Cohesion: 150 psf
 Phi: 9 °
 Phi-B: 0 °

Tmc (-12°)

Model: Anisotropic Fn.
 Unit Weight: 120 pcf
 Cohesion: 200 psf
 Phi: 40 °
 Phi-Anisotropic Strength Fn.: 12° (Along Bedding -10°-(-25°)
 C-Anisotropic Strength Fn.: 150 pcf (Along Bedding 10°-25°)
 Phi-B: 0 °

Tmc (12°)

Model: Anisotropic Fn.
 Unit Weight: 120 pcf
 Cohesion: 200 psf
 Phi: 40 °
 Phi-Anisotropic Strength Fn.: 12° (Along Bedding 10°-25°)
 C-Anisotropic Strength Fn.: 150 pcf (Along Bedding 10°-25°)
 Phi-B: 0 °

file:///P:/FINAL%20PROJECTS/PARDEE/Skyline%20Ranch/SLOPE%20RESULTS/Sect... 3/15/2016

Slip Surface Limits

Left Coordinate: (-49, 1,301) ft
 Right Coordinate: (2,050, 1,863) ft

Slip Surface Block

Left Grid
 Upper Left: (-29, 1,830) ft
 Lower Left: (-34, 1,792) ft
 Lower Right: (35, 1,803) ft
 X Increments: 8
 Y Increments: 8
 Starting Angle: 115 °
 Ending Angle: 135 °
 Angle Increments: 2

Right Grid
 Upper Left: (298, 1,834) ft
 Lower Left: (284, 1,817) ft
 Lower Right: (738, 1,714) ft
 X Increments: 10
 Y Increments: 10
 Starting Angle: 0 °
 Ending Angle: 45 °
 Angle Increments: 2

Seismic Coefficients

Horz Seismic Coef.: 0.15
 Vert Seismic Coef.: 0

Anisotropic Strength Functions

12° (Along Bedding 10°-25°)

Model: Spline Data Point Function
 Function: Modifier Factor vs. Inclination
 Curve Fit to Data: 100 %
 Segment Curvature: 0 %
 Y-Intercept: 1
 Data Points: Inclination (*), Modifier Factor
 Data Point: (-90, 1)
 Data Point: (9.9, 1)
 Data Point: (10, 0.3)
 Data Point: (25, 0.3)
 Data Point: (25.1, 1)

150 pcf (Along Bedding 10°-25°)

Model: Spline Data Point Function
 Function: Modifier Factor vs. Inclination
 Curve Fit to Data: 100 %
 Segment Curvature: 0 %
 Y-Intercept: 1
 Data Points: Inclination (*), Modifier Factor
 Data Point: (-90, 1)

Data Point: (-25.1, 1)
 Data Point: (-25, 0.667)
 Data Point: (-10, 0.667)
 Data Point: (-9.9, 1)

11° (Along Bedding -10°-(-25°))

Model: Spline Data Point Function
 Function: Modifier Factor vs. Inclination
 Curve Fit to Data: 100 %
 Segment Curvature: 0 %
 Y-Intercept: 1
 Data Points: Inclination (*), Modifier Factor
 Data Point: (-90, 1)
 Data Point: (-25.1, 1)
 Data Point: (-25, 0.275)
 Data Point: (-10, 0.275)
 Data Point: (-9.9, 1)

12° (Along Bedding -10°-(-25°))

Model: Spline Data Point Function
 Function: Modifier Factor vs. Inclination
 Curve Fit to Data: 100 %
 Segment Curvature: 0 %
 Y-Intercept: 1
 Data Points: Inclination (*), Modifier Factor
 Data Point: (-90, 1)
 Data Point: (-25.1, 1)
 Data Point: (-25, 0.3)
 Data Point: (-10, 0.3)
 Data Point: (-9.9, 1)

Points

	X (ft)	Y (ft)
Point 1	-47	1,822
Point 2	-7	1,838
Point 3	66	1,849
Point 4	218	1,873
Point 5	238	1,857
Point 6	292	1,830
Point 7	439	1,785
Point 8	634	1,739
Point 9	727	1,729
Point 10	793	1,729
Point 11	831	1,733
Point 12	872	1,737
Point 13	900	1,755
Point 14	929	1,767
Point 15	964	1,776
Point 16	1,022	1,779
Point 17	1,050	1,797
Point 18	1,069	1,809
Point 19	1,173	1,810
Point 20	1,224	1,777

Point 21	1,277	1,738
Point 22	1,312	1,753
Point 23	1,340	1,773
Point 24	1,429	1,777
Point 25	1,546	1,783
Point 26	1,643	1,792
Point 27	1,723	1,801
Point 28	1,769	1,808
Point 29	1,794	1,815
Point 30	1,830	1,823
Point 31	1,851	1,830
Point 32	1,862	1,841
Point 33	1,886	1,843
Point 34	1,913	1,853
Point 35	1,955	1,852
Point 36	1,993	1,862
Point 37	2,050	1,863
Point 38	2,049	1,295
Point 39	-49	1,301
Point 40	244	1,878
Point 41	276	1,871
Point 42	302	1,866
Point 43	324	1,861
Point 44	381	1,852
Point 45	402	1,847
Point 46	458	1,846
Point 47	477	1,845
Point 48	502	1,832
Point 49	531	1,823
Point 50	577	1,810
Point 51	601	1,800
Point 52	634	1,790
Point 53	696	1,771
Point 54	734	1,763
Point 55	805	1,769
Point 56	757	1,793
Point 57	890	1,789
Point 58	1,105	1,828
Point 59	1,137	1,828
Point 60	1,293	1,811
Point 61	1,397	1,816
Point 62	1,492	1,824
Point 63	1,449	1,812
Point 64	1,423	1,810
Point 65	1,372	1,791
Point 66	1,537	1,831
Point 67	1,593	1,846
Point 68	1,637	1,860
Point 69	1,671	1,876
Point 70	1,692	1,876

	1,720	1,864
Point 72	1,749	1,849
Point 73	1,769	1,843
Point 74	1,788	1,843
Point 75	1,809	1,855
Point 76	1,831	1,855
Point 77	1,839	1,857
Point 78	1,904	1,856
Point 79	1,971	1,856.2105
Point 80	293.0323	1,831
Point 81	311	1,826
Point 82	353	1,813
Point 83	439	1,787
Point 84	494	1,774
Point 85	634	1,741
Point 86	727	1,731
Point 87	793	1,731
Point 88	830.2778	1,734
Point 89	494.1087	1,772
Point 90	353	1,811.3265
Point 91	-47.6603	1,650
Point 92	1,343.5556	1,775
Point 93	1,368	1,776
Point 94	1,409	1,778
Point 95	1,429	1,779
Point 96	1,474	1,781
Point 97	1,546	1,785
Point 98	1,643	1,794
Point 99	1,723	1,803
Point 100	1,769	1,810
Point 101	1,793	1,816.12
Point 102	1,474	1,779.3077
Point 103	1,408	1,776.0562
Point 104	1,368	1,774.2584
Point 105	1,175	1,297.4995

Regions

	Material	Points	Area (ft ²)
Region 1	Tmc (12")	38,37,36,79,35,34,33,32,31,30,29,28,27,26,25,102,24,103,104,23,22,21,20,19,105	4.4177e+005
Region 2	Fill	4,40,41,42,43,80,6,5	2,420
Region 3	Qls	43,80,81,82,83,84,85,86,87,88,55,54,53,52,51,50,49,48,47,46,45,44	24,238
Region 4	Fill	51,56,57,16,15,14,13,12,11,88,55,54,53,52	10,071
Region 5	Fill	19,60,61,62,63,64,65,92,23,22,21,20	9,582
Region 6	Qls	62,63,64,65,92,93,94,95,96,97,98,99,100,101,73,72,71,70,69,68,67,66	20,085

Region 7	Fill	73,74,75,76,77,78,79,35,34,33,32,31,30,29,101	3,204.9
Region 8	Clay	80,6,90,7,89,8,9,10,11,88,87,86,85,84,83,82,81	1,023.3
Region 9	TQs 11°	91,9,8,89,7,90,6,5,4,3,2,1	90,409
Region 10	Clay	92,23,104,103,24,102,25,26,27,28,29,101,100,99,98,97,96,95,94,93	864.17
Region 11	Tmc (-12°)	91,39,105,19,59,58,18,17,16,15,14,13,12,11,10,9	5.1344e+005

Current Slip Surface

Slip Surface: 87,149
 F of S: 1.27
 Volume: 45,171.468 ft³
 Weight: 4,967,019.7 lbs
 Resisting Moment: 1.9515569e+008 lbs-ft
 Activating Moment: 1.5377598e+008 lbs-ft
 Resisting Force: 1,377,247.4 lbs
 Activating Force: 1,091,642.3 lbs
 F of S Rank (Analysis): 1 of 88,209 slip surfaces
 F of S Rank (Query): 1 of 10 slip surfaces
 Exit: (851.58859, 1,790.1552) ft
 Entry: (38.221416, 1,844.8142) ft
 Radius: 303.08677 ft
 Center: (447.65985, 1,858.4789) ft

Slip Slices

	X (ft)	Y (ft)	PWP (psf)	Base Normal Stress (psf)	Frictional Strength (psf)	Cohesive Strength (psf)
Slice 1	39.110708	1,842.9071	0	-36.768767	-30.852659	225
Slice 2	53	1,838.6753	0	946.45563	183.97234	150.075
Slice 3	78.666667	1,834.0855	0	1,912.2245	371.69879	150.075
Slice 4	104	1,829.5553	0	2,875.902	559.01873	150.075
Slice 5	129.33333	1,825.0251	0	3,839.5796	746.33867	150.075
Slice 6	154.66667	1,820.4949	0	4,803.2571	933.65861	150.075
Slice 7	180	1,815.9648	0	5,766.9347	1,120.9785	150.075
Slice 8	205.33333	1,811.4346	0	6,730.6122	1,308.2985	150.075
Slice 9	228	1,807.3812	0	7,631.7272	1,483.4575	150.075
Slice 10	241	1,805.0565	0	8,176.7863	1,589.4063	150.075
Slice 11	260	1,801.6589	0	8,230.399	1,599.8275	150.075
Slice 12	284	1,797.3671	0	8,146.0417	1,583.4301	150.075
Slice 13	292.51615	1,795.8443	0	8,120.679	1,578.5001	150.075
Slice 14	297.51615	1,794.9501	0	7,993.0409	1,553.6898	150.075
Slice 15	306.5	1,793.3436	0	7,745.9285	1,505.656	150.075
Slice 16	317.5	1,791.3766	0	7,421.6728	1,442.6271	150.075

Slice 17	338.5	1,787.6213	0	7,223.8813	1,404.1803	150.075
Slice 18	367	1,782.5248	0	7,211.723	1,401.8169	150.075
Slice 19	391.5	1,778.1437	0	7,121.9923	1,384.3751	150.075
Slice 20	420.5	1,772.9578	0	7,274.2399	1,413.969	150.075
Slice 21	448.5	1,767.9507	0	7,643.9994	1,485.843	150.075
Slice 22	467.5	1,764.5531	0	7,880.4055	1,531.7957	150.075
Slice 23	485.5	1,761.3343	0	7,700.9061	1,496.9045	150.075
Slice 24	498	1,759.099	0	7,285.7355	1,416.2035	150.075
Slice 25	516.5	1,755.7908	0	6,958.0789	1,352.5135	150.075
Slice 26	542.5	1,751.1414	0	6,638.2361	1,290.3424	150.075
Slice 27	565.5	1,747.0284	0	6,388.7918	1,241.8553	150.075
Slice 28	589	1,742.8261	0	5,982.4759	1,162.8755	150.075
Slice 29	617.5	1,737.7296	0	5,971.4305	1,160.7285	150.075
Slice 30	647.58886	1,732.349	0	6,498.5141	1,263.1832	150.075
Slice 31	674.76659	1,727.489	0	7,011.5846	1,362.914	150.075
Slice 32	690.47773	1,724.6795	0	7,309.2311	1,553.625	133.4
Slice 33	694.3	1,725.0042	0	14,486.502	12,155.618	200
Slice 34	702.34895	1,728.3381	0	13,724.759	11,516.44	225
Slice 35	710.61456	1,731.7619	0	7,982.9602	1,264.3767	150
Slice 36	723.26561	1,737.0021	0	8,237.4249	2,998.1775	0
Slice 37	745.5	1,746.2119	0	6,917.9506	2,517.9281	0
Slice 38	767.59147	1,755.3625	0	5,549.5905	2,019.8858	0
Slice 39	788.77441	1,764.1367	0	4,262.9598	1,551.5905	0
Slice 40	812.42156	1,773.9317	0	3,470.8949	2,254.0255	200
Slice 41	838.53291	1,784.7474	0	1,261.0242	818.91869	200

Section 29-29 tran Static right SSA for Skyline Ranch.gsz

Section 29-29 tran Static right SSA for Skyline Ranch.gsz Run By: Dr. Alexander Bykovtsev, Ph.D., P.E. 3/15/2016 1:51:23 PM

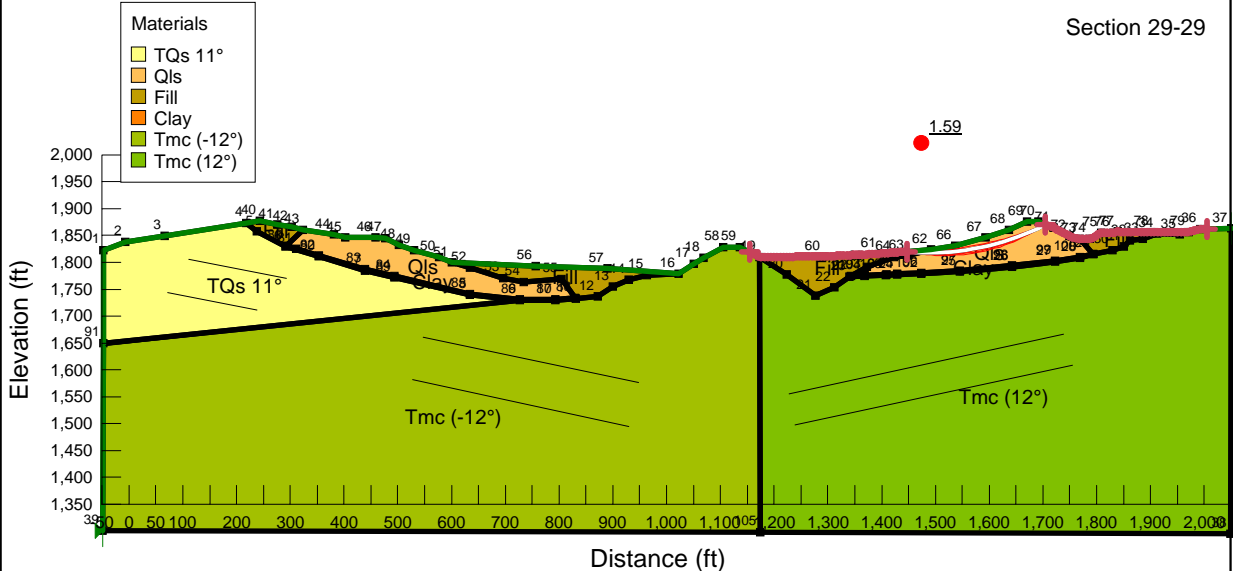

- Materials**
- TQs 11°
 - Qls
 - Fill
 - Clay
 - Tmc (-12°)
 - Tmc (12°)

Section 29-29

- Name: TQs 11°
- Model: Anisotropic Fn.
- Unit Weight: 120 pcf
- Cohesion: 225 psf
- Phi: 40°
- Phi-Anisotropic Strength Fn.: 11° (Along Bedding -10°-(-2)
- C-Anisotropic Strength Fn.: 150 pcf (Along Bedding 10°-2
- Name: Qls
- Model: Mohr-Coulomb
- Unit Weight: 100 pcf
- Cohesion: 0 psf
- Phi: 20°
- Name: Fill
- Model: Mohr-Coulomb
- Unit Weight: 120 pcf
- Cohesion: 200 psf
- Phi: 33°
- Name: Clay
- Model: Mohr-Coulomb
- Unit Weight: 100 pcf
- Cohesion: 150 psf
- Phi: 9°
- Name: Tmc (-12°)
- Model: Anisotropic Fn.
- Unit Weight: 120 pcf
- Cohesion: 200 psf
- Phi: 40°
- Phi-Anisotropic Strength Fn.: 12° (Along Bedding -10°-(-2)
- C-Anisotropic Strength Fn.: 150 pcf (Along Bedding 10°-2
- Name: Tmc (12°)
- Model: Anisotropic Fn.
- Unit Weight: 120 pcf
- Cohesion: 200 psf
- Phi: 40°
- Phi-Anisotropic Strength Fn.: 12° (Along Bedding 10°-25°)
- C-Anisotropic Strength Fn.: 150 pcf (Along Bedding 10°-2

LGC LGC Valley, Inc
 GEOTECHNICAL CONSULTING
 28532 Constellation Road, Valencia, CA 91355
 Phone 661-702-8474, Fax 661-702-8475

Skyline Ranch
 Development project, Tract 60922
 Los Angeles CA

Project No: **153035-01**
 Engineer: **BAS**
 Date: **March 2016**

1 - Circular Mode of Failure

Report generated using GeoStudio 2012. Copyright © 1991-2016 GEO-SLOPE International Ltd.

File Information

File Version: 8.15
Title: Static Slope Stability Analyses for Skyline Ranch Development project, Tract 60922, Los Angeles CA
Comments: Run By: Dr. Alexander Bykovtsev, Ph.D., P.E.
Last Edited By: Alexander Bykovtsec
Revision Number: 150
Date: 3/15/2016
Time: 1:51:23 PM
Tool Version: 8.15.5.11777
File Name: Section 29-29 tran Static right SSA for Skyline Ranch.gsz
Directory: P:\FINAL PROJECTS\PARDEE\Skyline Ranch\SLOPE RESULTS\Section 29-29 results\
Last Solved Date: 3/15/2016
Last Solved Time: 1:52:05 PM

Project Settings

Length(L) Units: Feet
Time(t) Units: Seconds
Force(F) Units: Pounds
Pressure(p) Units: psf
Strength Units: psf
Unit Weight of Water: 62.4 pcf
View: 2D
Element Thickness: 1

Analysis Settings

1 - Circular Mode of Failure

Kind: SLOPE/W
Method: Bishop
Settings
PWP Conditions Source: (none)
Slip Surface
Direction of movement: Right to Left
Use Passive Mode: No
Slip Surface Option: Entry and Exit
Critical slip surfaces saved: 1
Resisting Side Maximum Convex Angle: 1 °
Driving Side Maximum Convex Angle: 5 °
Optimize Critical Slip Surface Location: No
Tension Crack
Tension Crack Option: (none)
F of S Distribution
F of S Calculation Option: Constant
Advanced
Number of Slices: 30
F of S Tolerance: 0.01
Minimum Slip Surface Depth: 0.1 ft

Materials

TQs 11°

Model: [Anisotropic Fn.](#)
Unit Weight: [120 pcf](#)
Cohesion': [225 psf](#)
Phi': [40 °](#)
Phi-Anisotropic Strength Fn.: [11° \(Along Bedding -10°-\(-25°\)](#)
C-Anisotropic Strength Fn.: [150 pcf \(Along Bedding 10°-25°\)](#)
Phi-B: [0 °](#)

QIs

Model: [Mohr-Coulomb](#)
Unit Weight: [100 pcf](#)
Cohesion': [0 psf](#)
Phi': [20 °](#)
Phi-B: [0 °](#)

Fill

Model: [Mohr-Coulomb](#)
Unit Weight: [120 pcf](#)
Cohesion': [200 psf](#)
Phi': [33 °](#)
Phi-B: [0 °](#)

Clay

Model: [Mohr-Coulomb](#)
Unit Weight: [100 pcf](#)
Cohesion': [150 psf](#)
Phi': [9 °](#)
Phi-B: [0 °](#)

Tmc (-12°)

Model: [Anisotropic Fn.](#)
Unit Weight: [120 pcf](#)
Cohesion': [200 psf](#)
Phi': [40 °](#)
Phi-Anisotropic Strength Fn.: [12° \(Along Bedding -10°-\(-25°\)](#)
C-Anisotropic Strength Fn.: [150 pcf \(Along Bedding 10°-25°\)](#)
Phi-B: [0 °](#)

Tmc (12°)

Model: [Anisotropic Fn.](#)
Unit Weight: [120 pcf](#)
Cohesion': [200 psf](#)
Phi': [40 °](#)
Phi-Anisotropic Strength Fn.: [12° \(Along Bedding 10°-25°\)](#)
C-Anisotropic Strength Fn.: [150 pcf \(Along Bedding 10°-25°\)](#)
Phi-B: [0 °](#)

Slip Surface Entry and Exit

Left Projection: [Range](#)
Left-Zone Left Coordinate: [\(1,155, 1,819\) ft](#)

Left-Zone Right Coordinate: (1,447, 1,820.2105) ft
 Left-Zone Increment: 50
 Right Projection: Range
 Right-Zone Left Coordinate: (1,705, 1,870.4286) ft
 Right-Zone Right Coordinate: (2,006, 1,862.2281) ft
 Right-Zone Increment: 50
 Radius Increments: 50

Slip Surface Limits

Left Coordinate: (-49, 1,301) ft
 Right Coordinate: (2,050, 1,863) ft

Seismic Coefficients

Horz Seismic Coef.: 0
 Vert Seismic Coef.: 0

Anisotropic Strength Functions

12° (Along Bedding 10°-25°)

Model: Spline Data Point Function

Function: Modifier Factor vs. Inclination

Curve Fit to Data: 100 %

Segment Curvature: 0 %

Y-Intercept: 1

Data Points: Inclination (°), Modifier Factor

Data Point: (-90, 1)

Data Point: (9.9, 1)

Data Point: (10, 0.3)

Data Point: (25, 0.3)

Data Point: (25.1, 1)

150 pcf (Along Bedding 10°-25°)

Model: Spline Data Point Function

Function: Modifier Factor vs. Inclination

Curve Fit to Data: 100 %

Segment Curvature: 0 %

Y-Intercept: 1

Data Points: Inclination (°), Modifier Factor

Data Point: (-90, 1)

Data Point: (-25.1, 1)

Data Point: (-25, 0.667)

Data Point: (-10, 0.667)

Data Point: (-9.9, 1)

11° (Along Bedding -10°-(-25°))

Model: Spline Data Point Function

Function: Modifier Factor vs. Inclination

Curve Fit to Data: 100 %

Segment Curvature: 0 %

Y-Intercept: 1

Data Points: Inclination (°), Modifier Factor

Data Point: (-90, 1)

Data Point: (-25.1, 1)

Data Point: (-25, 0.275)
 Data Point: (-10, 0.275)
 Data Point: (-9.9, 1)

12° (Along Bedding -10°-(-25°)

Model: Spline Data Point Function

Function: Modifier Factor vs. Inclination

Curve Fit to Data: 100 %

Segment Curvature: 0 %

Y-Intercept: 1

Data Points: Inclination (°), Modifier Factor

Data Point: (-90, 1)
 Data Point: (-25.1, 1)
 Data Point: (-25, 0.3)
 Data Point: (-10, 0.3)
 Data Point: (-9.9, 1)

Points

	X (ft)	Y (ft)
Point 1	-47	1,822
Point 2	-7	1,838
Point 3	66	1,849
Point 4	218	1,873
Point 5	238	1,857
Point 6	292	1,830
Point 7	439	1,785
Point 8	634	1,739
Point 9	727	1,729
Point 10	793	1,729
Point 11	831	1,733
Point 12	872	1,737
Point 13	900	1,755
Point 14	929	1,767
Point 15	964	1,776
Point 16	1,022	1,779
Point 17	1,050	1,797
Point 18	1,069	1,809
Point 19	1,173	1,810
Point 20	1,224	1,777
Point 21	1,277	1,738
Point 22	1,312	1,753
Point 23	1,340	1,773
Point 24	1,429	1,777
Point 25	1,546	1,783
Point 26	1,643	1,792
Point 27	1,723	1,801
Point 28	1,769	1,808
Point 29	1,794	1,815
Point 30	1,830	1,823
Point 31	1,851	1,830
Point 32	1,862	1,841

Point 33	1,886	1,843
Point 34	1,913	1,853
Point 35	1,955	1,852
Point 36	1,993	1,862
Point 37	2,050	1,863
Point 38	2,049	1,295
Point 39	-49	1,301
Point 40	244	1,878
Point 41	276	1,871
Point 42	302	1,866
Point 43	324	1,861
Point 44	381	1,852
Point 45	402	1,847
Point 46	458	1,846
Point 47	477	1,845
Point 48	502	1,832
Point 49	531	1,823
Point 50	577	1,810
Point 51	601	1,800
Point 52	634	1,790
Point 53	696	1,771
Point 54	734	1,763
Point 55	805	1,769
Point 56	757	1,793
Point 57	890	1,789
Point 58	1,105	1,828
Point 59	1,137	1,828
Point 60	1,293	1,811
Point 61	1,397	1,816
Point 62	1,492	1,824
Point 63	1,449	1,812
Point 64	1,423	1,810
Point 65	1,372	1,791
Point 66	1,537	1,831
Point 67	1,593	1,846
Point 68	1,637	1,860
Point 69	1,671	1,876
Point 70	1,692	1,876
Point 71	1,720	1,864
Point 72	1,749	1,849
Point 73	1,769	1,843
Point 74	1,788	1,843
Point 75	1,809	1,855
Point 76	1,831	1,855
Point 77	1,839	1,857
Point 78	1,904	1,856
Point 79	1,971	1,856.2105
Point 80	293.0323	1,831
Point 81	311	1,826
Point 82	353	1,813

	439	1,787
Point 84	494	1,774
Point 85	634	1,741
Point 86	727	1,731
Point 87	793	1,731
Point 88	830.2778	1,734
Point 89	494.1087	1,772
Point 90	353	1,811.3265
Point 91	-47.6603	1,650
Point 92	1,343.5556	1,775
Point 93	1,368	1,776
Point 94	1,409	1,778
Point 95	1,429	1,779
Point 96	1,474	1,781
Point 97	1,546	1,785
Point 98	1,643	1,794
Point 99	1,723	1,803
Point 100	1,769	1,810
Point 101	1,793	1,816.12
Point 102	1,474	1,779.3077
Point 103	1,408	1,776.0562
Point 104	1,368	1,774.2584
Point 105	1,175	1,297.4995

Regions

	Material	Points	Area (ft ²)
Region 1	Tmc (12°)	38,37,36,79,35,34,33,32,31,30,29,28,27,26,25,102,24,103,104,23,22,21,20,19,105	4.4177e+005
Region 2	Fill	4,40,41,42,43,80,6,5	2,420
Region 3	Qls	43,80,81,82,83,84,85,86,87,88,55,54,53,52,51,50,49,48,47,46,45,44	24,238
Region 4	Fill	51,56,57,16,15,14,13,12,11,88,55,54,53,52	10,071
Region 5	Fill	19,60,61,62,63,64,65,92,23,22,21,20	9,582
Region 6	Qls	62,63,64,65,92,93,94,95,96,97,98,99,100,101,73,72,71,70,69,68,67,66	20,085
Region 7	Fill	73,74,75,76,77,78,79,35,34,33,32,31,30,29,101	3,204.9
Region 8	Clay	80,6,90,7,89,8,9,10,11,88,87,86,85,84,83,82,81	1,023.3
Region 9	TQs 11°	91,9,8,89,7,90,6,5,4,3,2,1	90,409
Region 10	Clay	92,23,104,103,24,102,25,26,27,28,29,101,100,99,98,97,96,95,94,93	864.17
Region 11	Tmc (-12°)	91,39,105,19,59,58,18,17,16,15,14,13,12,11,10,9	5.1344e+005

Current Slip Surface

Slip Surface: 130,058

F of S: 1.59

Volume: 3,237.8706 ft³

Weight: 325,573.28 lbs

Resisting Moment: 57,192,827 lbs-ft

Activating Moment: 36,024,456 lbs-ft

F of S Rank (Analysis): 1 of 132,651 slip surfaces

F of S Rank (Query): 1 of 10 slip surfaces

Exit: (1,447, 1,820.2105) ft

Entry: (1,705, 1,870.4286) ft

Radius: 462.56384 ft

Center: (1,491.2654, 2,280.6515) ft

Slip Slices

	X (ft)	Y (ft)	PWP (psf)	Base Normal Stress (psf)	Frictional Strength (psf)	Cohesive Strength (psf)
Slice 1	1,451.2033	1,819.8451	0	100.7886	65.452884	200
Slice 2	1,459.6098	1,819.1913	0	265.74556	172.57718	200
Slice 3	1,468.0164	1,818.6914	0	409.35663	265.8393	200
Slice 4	1,477.1648	1,818.3291	0	503.4809	183.25206	0
Slice 5	1,487.0549	1,818.1332	0	565.47841	205.81731	0
Slice 6	1,496.5	1,818.1392	0	654.39473	238.1802	0
Slice 7	1,505.5	1,818.3286	0	771.71651	280.88184	0
Slice 8	1,514.5	1,818.6935	0	870.65977	316.89424	0
Slice 9	1,523.5	1,819.2342	0	951.41788	346.28779	0
Slice 10	1,532.5	1,819.9514	0	1,014.1604	369.12421	0
Slice 11	1,541	1,820.7867	0	1,101.3036	400.84175	0
Slice 12	1,549	1,821.7225	0	1,214.3309	441.98032	0
Slice 13	1,557	1,822.8	0	1,312.7235	477.79227	0
Slice 14	1,565	1,824.0202	0	1,396.5431	508.30012	0
Slice 15	1,573	1,825.3843	0	1,465.8378	533.52131	0
Slice 16	1,581	1,826.8934	0	1,520.6417	553.46833	0
Slice 17	1,589	1,828.5492	0	1,560.9758	568.14872	0
Slice 18	1,597.4	1,830.4512	0	1,608.3996	585.40958	0
Slice 19	1,606.2	1,832.6172	0	1,661.09	604.5873	0
Slice 20	1,615	1,834.9675	0	1,695.8648	617.24431	0
Slice 21	1,623.8	1,837.505	0	1,712.6724	623.36179	0
Slice 22	1,632.6	1,840.233	0	1,711.4402	622.91327	0

Slice 23	1,641.25	1,843.1018	0	1,752.7865	637.96213	0
Slice 24	1,649.75	1,846.1087	0	1,836.3781	668.38695	0
Slice 25	1,658.25	1,849.304	0	1,901.6944	692.16017	0
Slice 26	1,666.75	1,852.6919	0	1,948.5683	709.22086	0
Slice 27	1,676.25	1,856.7256	0	1,752.9803	638.03267	0
Slice 28	1,686.75	1,861.4647	0	1,313.7877	478.1796	0
Slice 29	1,695.25	1,865.51	0	818.04084	297.74251	0
Slice 30	1,701.75	1,868.7677	0	273.49302	99.54332	0

Section 29-29 pseudostatic right SSA for Skyline Ranch.gsz

Section 29-29 pseudostatic right SSA for Skyline Ranch.gsz Run By: Dr. Alexander Bykovtsev, Ph.D., P.E. 3/15/2016 2:04:00 PM

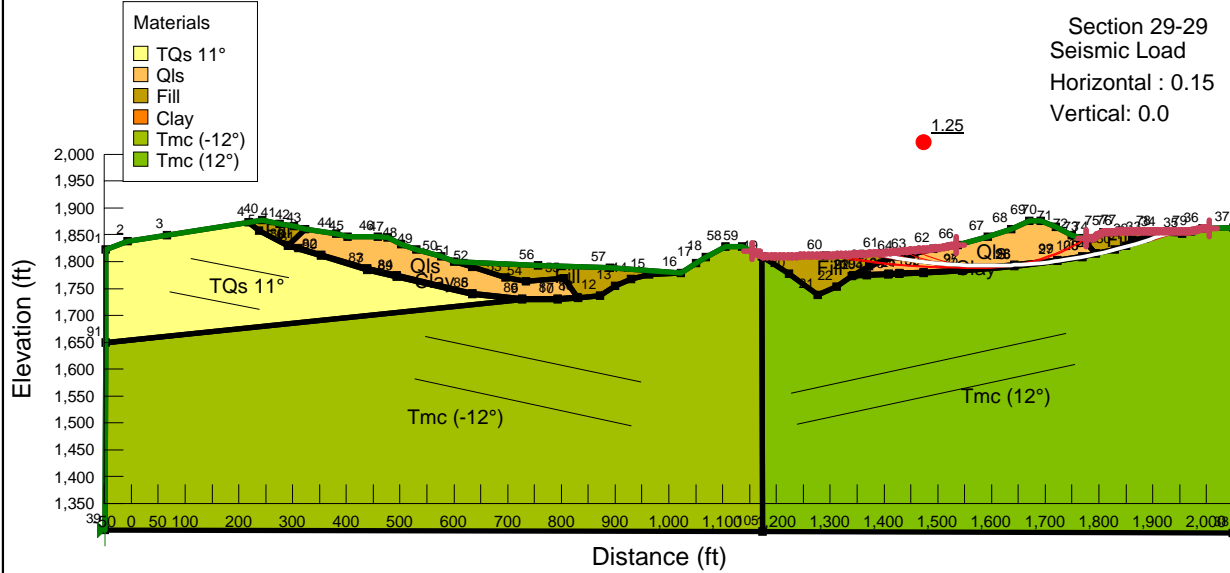

Section 29-29 Seismic Load
 Horizontal : 0.15
 Vertical: 0.0

Name: TQs 11°
 Model: Anisotropic Fn.
 Unit Weight: 120 pcf
 Cohesion: 225 psf
 Phi: 40°
 Phi-Anisotropic Strength Fn.: 11° (Along Bedding -10°-(-2
 C-Anisotropic Strength Fn.: 150 pcf (Along Bedding 10°-(-2

Name: Qls
 Model: Mohr-Coulomb
 Unit Weight: 100 pcf
 Cohesion: 0 psf
 Phi: 20°

Name: Fill
 Model: Mohr-Coulomb
 Unit Weight: 120 pcf
 Cohesion: 200 psf
 Phi: 33°

Name: Clay
 Model: Mohr-Coulomb
 Unit Weight: 100 pcf
 Cohesion: 150 psf
 Phi: 9°

Name: Tmc (-12°)
 Model: Anisotropic Fn.
 Unit Weight: 120 pcf
 Cohesion: 200 psf
 Phi: 40°
 Phi-Anisotropic Strength Fn.: 12° (Along Bedding -10°-(-2
 C-Anisotropic Strength Fn.: 150 pcf (Along Bedding 10°-(-2

Name: Tmc (12°)
 Model: Anisotropic Fn.
 Unit Weight: 120 pcf
 Cohesion: 200 psf
 Phi: 40°
 Phi-Anisotropic Strength Fn.: 12° (Along Bedding 10°-25°
 C-Anisotropic Strength Fn.: 150 pcf (Along Bedding 10°-(-2

LGC LGC Valley, Inc
 GEOTECHNICAL CONSULTING
 28532 Constellation Road, Valencia, CA 91355
 Phone 661-702-8474, Fax 661-702-8475

Skyline Ranch
 Development project, Tract 60922
 Los Angeles CA

Project No: **153035-01**
 Engineer: **BAS**
 Date: **March 2016**

1 - Circular Mode of Failure

Report generated using GeoStudio 2012. Copyright © 1991-2016 GEO-SLOPE International Ltd.

File Information

File Version: 8.15
 Title: Static Slope Stability Analyses for Skyline Ranch Development project, Tract 60922, Los Angeles CA
 Comments: Run By: Dr. Alexander Bykovtsev, Ph.D., P.E.
 Last Edited By: Alexander Bykovtsev
 Revision Number: 155
 Date: 3/15/2016
 Time: 2:04:00 PM
 Tool Version: 8.15.5.11777
 File Name: Section 29-29 pseudostatic right SSA for Skyline Ranch.gsz
 Directory: P:\FINAL PROJECTS\PARDEE\Skyline Ranch\SLOPE RESULTS\Section 29-29 results\
 Last Solved Date: 3/15/2016
 Last Solved Time: 2:05:08 PM

Project Settings

Length(L) Units: Feet
 Time(t) Units: Seconds
 Force(F) Units: Pounds
 Pressure(p) Units: psf
 Strength Units: psf
 Unit Weight of Water: 62.4 pcf
 View: 2D
 Element Thickness: 1

Analysis Settings

1 - Circular Mode of Failure

Kind: [SLOPE/W](#)
 Method: [Bishop](#)
 Settings
 PWP Conditions Source: [\(none\)](#)
 Slip Surface
 Direction of movement: [Right to Left](#)
 Use Passive Mode: [No](#)
 Slip Surface Option: [Entry and Exit](#)
 Critical slip surfaces saved: [1](#)
 Resisting Side Maximum Convex Angle: [1°](#)
 Driving Side Maximum Convex Angle: [5°](#)
 Optimize Critical Slip Surface Location: [No](#)
 Tension Crack
 Tension Crack Option: [\(none\)](#)
 F of S Distribution
 F of S Calculation Option: [Constant](#)
 Advanced
 Number of Slices: [30](#)
 F of S Tolerance: [0.01](#)
 Minimum Slip Surface Depth: [0.1 ft](#)

file:///P:/FINAL%20PROJECTS/PARDEE/Skyline%20Ranch/SLOPE%20RESULTS/Sect... 3/15/2016

Materials

TQs 11°

Model: [Anisotropic Fn.](#)
 Unit Weight: [120 pcf](#)
 Cohesion: [225 psf](#)
 Phi: [40°](#)
 Phi-Anisotropic Strength Fn.: [11° \(Along Bedding -10°-\(-25°\)\)](#)
 C-Anisotropic Strength Fn.: [150 pcf \(Along Bedding 10°-25°\)](#)
 Phi-B: [0°](#)

QIs

Model: [Mohr-Coulomb](#)
 Unit Weight: [100 pcf](#)
 Cohesion: [0 psf](#)
 Phi: [20°](#)
 Phi-B: [0°](#)

Fill

Model: [Mohr-Coulomb](#)
 Unit Weight: [120 pcf](#)
 Cohesion: [200 psf](#)
 Phi: [33°](#)
 Phi-B: [0°](#)

Clay

Model: [Mohr-Coulomb](#)
 Unit Weight: [100 pcf](#)
 Cohesion: [150 psf](#)
 Phi: [9°](#)
 Phi-B: [0°](#)

Tmc (-12°)

Model: [Anisotropic Fn.](#)
 Unit Weight: [120 pcf](#)
 Cohesion: [200 psf](#)
 Phi: [40°](#)
 Phi-Anisotropic Strength Fn.: [12° \(Along Bedding -10°-\(-25°\)\)](#)
 C-Anisotropic Strength Fn.: [150 pcf \(Along Bedding 10°-25°\)](#)
 Phi-B: [0°](#)

Tmc (12°)

Model: [Anisotropic Fn.](#)
 Unit Weight: [120 pcf](#)
 Cohesion: [200 psf](#)
 Phi: [40°](#)
 Phi-Anisotropic Strength Fn.: [12° \(Along Bedding 10°-25°\)](#)
 C-Anisotropic Strength Fn.: [150 pcf \(Along Bedding 10°-25°\)](#)
 Phi-B: [0°](#)

Slip Surface Entry and Exit

Left Projection: [Range](#)
 Left-Zone Left Coordinate: [\(1,155, 1,819\) ft](#)

file:///P:/FINAL%20PROJECTS/PARDEE/Skyline%20Ranch/SLOPE%20RESULTS/Sect... 3/15/2016

Left-Zone Right Coordinate: (1,534, 1,830.5333) ft
 Left-Zone Increment: 50
 Right Projection: Range
 Right-Zone Left Coordinate: (1,776, 1,843) ft
 Right-Zone Right Coordinate: (2,006, 1,862.2281) ft
 Right-Zone Increment: 50
 Radius Increments: 50

Slip Surface Limits

Left Coordinate: (-49, 1,301) ft
 Right Coordinate: (2,050, 1,863) ft

Seismic Coefficients

Horz Seismic Coef.: 0.15
 Vert Seismic Coef.: 0

Anisotropic Strength Functions

12° (Along Bedding 10°-25°)

Model: Spline Data Point Function
 Function: Modifier Factor vs. Inclination
 Curve Fit to Data: 100 %
 Segment Curvature: 0 %
 Y-Intercept: 1
 Data Points: Inclination (°), Modifier Factor
 Data Point: (-90, 1)
 Data Point: (9.9, 1)
 Data Point: (10, 0.3)
 Data Point: (25, 0.3)
 Data Point: (25.1, 1)

150 pcf (Along Bedding 10°-25°)

Model: Spline Data Point Function
 Function: Modifier Factor vs. Inclination
 Curve Fit to Data: 100 %
 Segment Curvature: 0 %
 Y-Intercept: 1
 Data Points: Inclination (°), Modifier Factor
 Data Point: (-90, 1)
 Data Point: (-25.1, 1)
 Data Point: (-25, 0.667)
 Data Point: (-10, 0.667)
 Data Point: (-9.9, 1)

11° (Along Bedding -10°-(-25°))

Model: Spline Data Point Function
 Function: Modifier Factor vs. Inclination
 Curve Fit to Data: 100 %
 Segment Curvature: 0 %
 Y-Intercept: 1
 Data Points: Inclination (°), Modifier Factor
 Data Point: (-90, 1)
 Data Point: (-25.1, 1)

Data Point: (-25, 0.275)
 Data Point: (-10, 0.275)
 Data Point: (-9.9, 1)

12° (Along Bedding -10°-(-25°))

Model: Spline Data Point Function
 Function: Modifier Factor vs. Inclination
 Curve Fit to Data: 100 %
 Segment Curvature: 0 %
 Y-Intercept: 1
 Data Points: Inclination (°), Modifier Factor
 Data Point: (-90, 1)
 Data Point: (-25.1, 1)
 Data Point: (-25, 0.3)
 Data Point: (-10, 0.3)
 Data Point: (-9.9, 1)

Points

	X (ft)	Y (ft)
Point 1	-47	1,822
Point 2	-7	1,838
Point 3	66	1,849
Point 4	218	1,873
Point 5	238	1,857
Point 6	292	1,830
Point 7	439	1,785
Point 8	634	1,739
Point 9	727	1,729
Point 10	793	1,729
Point 11	831	1,733
Point 12	872	1,737
Point 13	900	1,755
Point 14	929	1,767
Point 15	964	1,776
Point 16	1,022	1,779
Point 17	1,050	1,797
Point 18	1,069	1,809
Point 19	1,173	1,810
Point 20	1,224	1,777
Point 21	1,277	1,738
Point 22	1,312	1,753
Point 23	1,340	1,773
Point 24	1,429	1,777
Point 25	1,546	1,783
Point 26	1,643	1,792
Point 27	1,723	1,801
Point 28	1,769	1,808
Point 29	1,794	1,815
Point 30	1,830	1,823
Point 31	1,851	1,830
Point 32	1,862	1,841

Point 33	1,886	1,843
Point 34	1,913	1,853
Point 35	1,955	1,852
Point 36	1,993	1,862
Point 37	2,050	1,863
Point 38	2,049	1,295
Point 39	-49	1,301
Point 40	244	1,878
Point 41	276	1,871
Point 42	302	1,866
Point 43	324	1,861
Point 44	381	1,852
Point 45	402	1,847
Point 46	458	1,846
Point 47	477	1,845
Point 48	502	1,832
Point 49	531	1,823
Point 50	577	1,810
Point 51	601	1,800
Point 52	634	1,790
Point 53	696	1,771
Point 54	734	1,763
Point 55	805	1,769
Point 56	757	1,793
Point 57	890	1,789
Point 58	1,105	1,828
Point 59	1,137	1,828
Point 60	1,293	1,811
Point 61	1,397	1,816
Point 62	1,492	1,824
Point 63	1,449	1,812
Point 64	1,423	1,810
Point 65	1,372	1,791
Point 66	1,537	1,831
Point 67	1,593	1,846
Point 68	1,637	1,860
Point 69	1,671	1,876
Point 70	1,692	1,876
Point 71	1,720	1,864
Point 72	1,749	1,849
Point 73	1,769	1,843
Point 74	1,788	1,843
Point 75	1,809	1,855
Point 76	1,831	1,855
Point 77	1,839	1,857
Point 78	1,904	1,856
Point 79	1,971	1,856.2105
Point 80	293.0323	1,831
Point 81	311	1,826
Point 82	353	1,813

	439	1,787
Point 84	494	1,774
Point 85	634	1,741
Point 86	727	1,731
Point 87	793	1,731
Point 88	830.2778	1,734
Point 89	494.1087	1,772
Point 90	353	1,811.3265
Point 91	-47.6603	1,650
Point 92	1,343.5556	1,775
Point 93	1,368	1,776
Point 94	1,409	1,778
Point 95	1,429	1,779
Point 96	1,474	1,781
Point 97	1,546	1,785
Point 98	1,643	1,794
Point 99	1,723	1,803
Point 100	1,769	1,810
Point 101	1,793	1,816.12
Point 102	1,474	1,779.3077
Point 103	1,408	1,776.0562
Point 104	1,368	1,774.2584
Point 105	1,175	1,297.4995

Regions

	Material	Points	Area (ft ²)
Region 1	Tmc (12°)	38,37,36,79,35,34,33,32,31,30,29,28,27,26,25,102,24,103,104,23,22,21,20,19,105	4.4177e+005
Region 2	Fill	4,40,41,42,43,80,6,5	2,420
Region 3	Qls	43,80,81,82,83,84,85,86,87,88,55,54,53,52,51,50,49,48,47,46,45,44	24,238
Region 4	Fill	51,56,57,16,15,14,13,12,11,88,55,54,53,52	10,071
Region 5	Fill	19,60,61,62,63,64,65,92,23,22,21,20	9,582
Region 6	Qls	62,63,64,65,92,93,94,95,96,97,98,99,100,101,73,72,71,70,69,68,67,66	20,085
Region 7	Fill	73,74,75,76,77,78,79,35,34,33,32,31,30,29,101	3,204.9
Region 8	Clay	80,6,90,7,89,8,9,10,11,88,87,86,85,84,83,82,81	1,023.3
Region 9	TQs 11°	91,9,8,89,7,90,6,5,4,3,2,1	90,409
Region 10	Clay	92,23,104,103,24,102,25,26,27,28,29,101,100,99,98,97,96,95,94,93	864.17
Region 11	Tmc (-12°)	91,39,105,19,59,58,18,17,16,15,14,13,12,11,10,9	5.1344e+005

Current Slip Surface

Slip Surface: 79,822
 F of S: 1.25
 Volume: 20,666.136 ft³
 Weight: 2,150,374.1 lbs
 Resisting Moment: 5.8700498e+008 lbs-ft
 Activating Moment: 4.6976221e+008 lbs-ft
 F of S Rank (Analysis): 1 of 132,651 slip surfaces
 F of S Rank (Query): 1 of 10 slip surfaces
 Exit: (1,382.0225, 1,815.2799) ft
 Entry: (1,936.4936, 1,856.1021) ft
 Radius: 967.25342 ft
 Center: (1,591.2339, 2,759.6368) ft

Slip Slices

	X (ft)	Y (ft)	PWP (psf)	Base Normal Stress (psf)	Frictional Strength (psf)	Cohesive Strength (psf)
Slice 1	1,389.5113	1,813.683	0	302.46824	196.42517	200
Slice 2	1,407.3968	1,810.0732	0	942.00415	611.74465	200
Slice 3	1,420.3968	1,807.5932	0	1,283.5706	467.18149	0
Slice 4	1,436	1,805.0121	0	1,672.0621	608.58082	0
Slice 5	1,459.75	1,801.4231	0	2,199.6843	800.61963	0
Slice 6	1,481.25	1,798.7176	0	2,565.0977	933.61921	0
Slice 7	1,503.25	1,796.4595	0	3,009.0854	1,095.2175	0
Slice 8	1,525.75	1,794.6684	0	3,527.8679	1,284.0389	0
Slice 9	1,546.3333	1,793.4712	0	4,057.7864	1,476.9135	0
Slice 10	1,565	1,792.7842	0	4,607.9819	1,677.1683	0
Slice 11	1,583.6667	1,792.458	0	5,115.8578	1,862.0199	0
Slice 12	1,604	1,792.5302	0	5,675.1717	2,065.5936	0
Slice 13	1,626	1,793.071	0	6,277.1567	2,284.6982	0
Slice 14	1,637.2588	1,793.479	0	6,573.1048	2,392.4145	0
Slice 15	1,640.2588	1,793.6304	0	6,740.8743	1,067.6496	150
Slice 16	1,650	1,794.1956	0	7,129.9054	1,129.2661	150
Slice 17	1,664	1,795.1499	0	7,673.1976	1,215.3151	150
Slice 18	1,681.5	1,796.6622	0	7,829.5383	1,240.077	150
Slice 19	1,699	1,798.4313	0	7,339.1616	1,162.409	150
Slice 20	1,713	1,800.1044	0	6,568.7137	1,040.382	150
Slice 21	1,721.5	1,801.1966	0	6,081.7127	963.24867	150
Slice 22	1,736	1,803.3684	0	5,119.2065	810.80265	150

Slice 23	1,759	1,807.0977	0	3,784.6327	599.42693	150
Slice 24	1,773.8979	1,809.8009	0	3,325.5117	526.7093	150
Slice 25	1,783.3979	1,811.6757	0	3,315.3385	704.69696	200
Slice 26	1,790.5	1,813.135	0	3,498.3113	743.58902	200
Slice 27	1,793.5	1,813.7682	0	3,702.1245	786.91086	200
Slice 28	1,801.5	1,815.5455	0	4,031.921	857.01126	200
Slice 29	1,820	1,819.8937	0	4,007.9025	851.90597	200
Slice 30	1,835	1,823.6132	0	3,681.7091	782.57142	200
Slice 31	1,845	1,826.2862	0	3,470.6193	737.70291	200
Slice 32	1,856.5	1,829.486	0	3,074.6337	653.53356	200
Slice 33	1,874	1,834.7232	0	2,433.1881	517.19011	200
Slice 34	1,895	1,841.3691	0	1,627.8242	346.00471	200
Slice 35	1,908.5	1,845.9089	0	1,092.5696	232.23284	200
Slice 36	1,920.1717	1,850.0649	0	622.18265	132.249	200
Slice 37	1,931.9185	1,854.3803	0	121.01553	78.588401	200

Section 29-29 tran Static right SSA for Skyline Ranch.gsz

Section 29-29 tran Static right SSA for Skyline Ranch.gsz Run By: Dr. Alexander Bykovtsev, Ph.D., P.E. 3/15/2016 1:51:23 PM

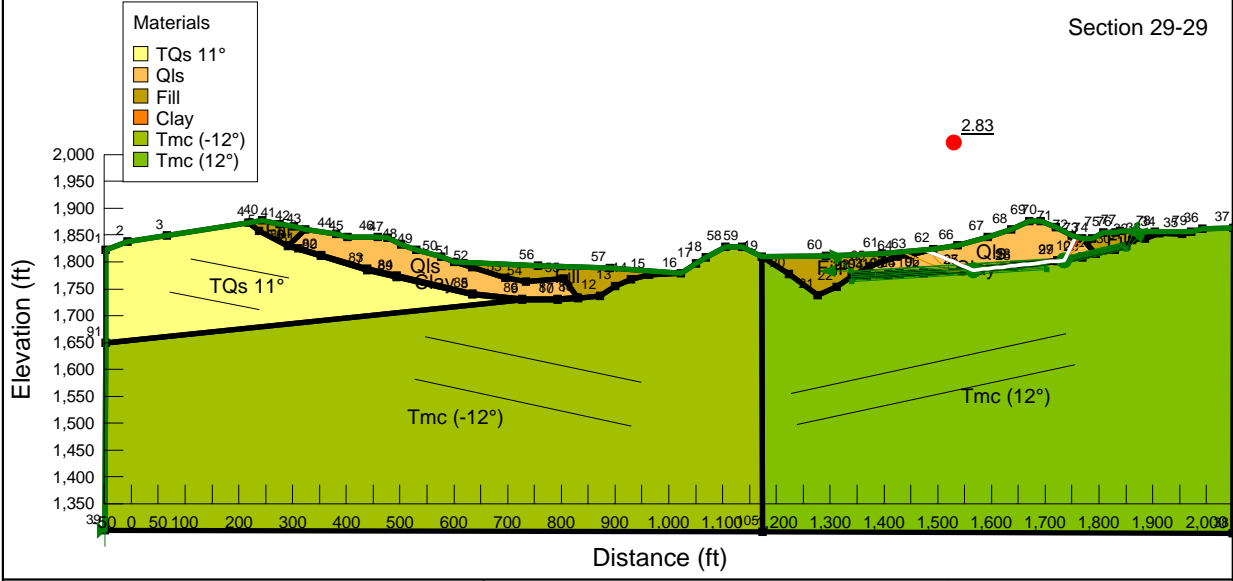

Section 29-29

- Materials**
- TQs 11°
 - Qls
 - Fill
 - Clay
 - Tmc (-12°)
 - Tmc (12°)

Name: TQs 11°
 Model: Anisotropic Fn.
 Unit Weight: 120 pcf
 Cohesion: 225 psf
 Phi: 40°
 Phi-Anisotropic Strength Fn.: 11° (Along Bedding -10°-(-25°)
 C-Anisotropic Strength Fn.: 150 pcf (Along Bedding 10°-25°)

Name: Qls
 Model: Mohr-Coulomb
 Unit Weight: 100 pcf
 Cohesion: 0 psf
 Phi: 20°

Name: Fill
 Model: Mohr-Coulomb
 Unit Weight: 120 pcf
 Cohesion: 200 psf
 Phi: 33°

Name: Clay
 Model: Mohr-Coulomb
 Unit Weight: 100 pcf
 Cohesion: 150 psf
 Phi: 9°

Name: Tmc (-12°)
 Model: Anisotropic Fn.
 Unit Weight: 120 pcf
 Cohesion: 200 psf
 Phi: 40°
 Phi-Anisotropic Strength Fn.: 12° (Along Bedding -10°-(-25°)
 C-Anisotropic Strength Fn.: 150 pcf (Along Bedding 10°-25°)

Name: Tmc (12°)
 Model: Anisotropic Fn.
 Unit Weight: 120 pcf
 Cohesion: 200 psf
 Phi: 40°
 Phi-Anisotropic Strength Fn.: 12° (Along Bedding 10°-25°)
 C-Anisotropic Strength Fn.: 150 pcf (Along Bedding 10°-25°)

LGC LGC Valley, Inc
 GEOTECHNICAL CONSULTING
 28532 Constellation Road, Valencia, CA 91355
 Phone 661-702-8474, Fax 661-702-8475

Skyline Ranch
 Development project, Tract 60922
 Los Angeles CA

Project No: **153035-01**
 Engineer: **BAS**
 Date: **March 2016**

2 - Translational

Report generated using GeoStudio 2012. Copyright © 1991-2016 GEO-SLOPE International Ltd.

File Information

File Version: 8.15
 Title: Static Slope Stability Analyses for Skyline Ranch Development project, Tract 60922, Los Angeles CA
 Comments: Run By: Dr. Alexander Bykovtsev, Ph.D., P.E.
 Last Edited By: Alexander Bykovtsev
 Revision Number: 150
 Date: 3/15/2016
 Time: 1:51:23 PM
 Tool Version: 8.15.5.11777
 File Name: Section 29-29 tran Static right SSA for Skyline Ranch.gsz
 Directory: P:\FINAL PROJECTS\PARDEE\Skyline Ranch\SLOPE RESULTS\Section 29-29 results\
 Last Solved Date: 3/15/2016
 Last Solved Time: 1:52:10 PM

Project Settings

Length(L) Units: Feet
 Time(t) Units: Seconds
 Force(F) Units: Pounds
 Pressure(p) Units: psf
 Strength Units: psf
 Unit Weight of Water: 62.4 pcf
 View: 2D
 Element Thickness: 1

Analysis Settings

2 - Translational

Kind: [SLOPE/W](#)
 Method: [Janbu](#)
 Settings
 PWP Conditions Source: [\(none\)](#)
 Slip Surface
 Direction of movement: [Right to Left](#)
 Use Passive Mode: [No](#)
 Slip Surface Option: [Block](#)
 Critical slip surfaces saved: [10](#)
 Resisting Side Maximum Convex Angle: [1°](#)
 Driving Side Maximum Convex Angle: [5°](#)
 Restrict Block Crossing: [No](#)
 Optimize Critical Slip Surface Location: [No](#)
 Tension Crack
 Tension Crack Option: [\(none\)](#)
 F of S Distribution
 F of S Calculation Option: [Constant](#)
 Advanced
 Number of Slices: [30](#)
 F of S Tolerance: [0.01](#)
 Minimum Slip Surface Depth: [0.1 ft](#)

file:///P:/FINAL%20PROJECTS/PARDEE/Skyline%20Ranch/SLOPE%20RESULTS/Sect... 3/15/2016

Materials

TQs 11°

Model: [Anisotropic Fn.](#)
 Unit Weight: [120 pcf](#)
 Cohesion: [225 psf](#)
 Phi: [40°](#)
 Phi-Anisotropic Strength Fn.: [11° \(Along Bedding -10°-\(-25°\)](#)
 C-Anisotropic Strength Fn.: [150 pcf \(Along Bedding 10°-25°\)](#)
 Phi-B: [0°](#)

QIs

Model: [Mohr-Coulomb](#)
 Unit Weight: [100 pcf](#)
 Cohesion: [0 psf](#)
 Phi: [20°](#)
 Phi-B: [0°](#)

Fill

Model: [Mohr-Coulomb](#)
 Unit Weight: [120 pcf](#)
 Cohesion: [200 psf](#)
 Phi: [33°](#)
 Phi-B: [0°](#)

Clay

Model: [Mohr-Coulomb](#)
 Unit Weight: [100 pcf](#)
 Cohesion: [150 psf](#)
 Phi: [9°](#)
 Phi-B: [0°](#)

Tmc (-12°)

Model: [Anisotropic Fn.](#)
 Unit Weight: [120 pcf](#)
 Cohesion: [200 psf](#)
 Phi: [40°](#)
 Phi-Anisotropic Strength Fn.: [12° \(Along Bedding -10°-\(-25°\)](#)
 C-Anisotropic Strength Fn.: [150 pcf \(Along Bedding 10°-25°\)](#)
 Phi-B: [0°](#)

Tmc (12°)

Model: [Anisotropic Fn.](#)
 Unit Weight: [120 pcf](#)
 Cohesion: [200 psf](#)
 Phi: [40°](#)
 Phi-Anisotropic Strength Fn.: [12° \(Along Bedding 10°-25°\)](#)
 C-Anisotropic Strength Fn.: [150 pcf \(Along Bedding 10°-25°\)](#)
 Phi-B: [0°](#)

Slip Surface Limits

Left Coordinate: [\(-49, 1,301\) ft](#)
 Right Coordinate: [\(2,050, 1,863\) ft](#)

file:///P:/FINAL%20PROJECTS/PARDEE/Skyline%20Ranch/SLOPE%20RESULTS/Sect... 3/15/2016

Slip Surface Block

Left Grid
 Upper Left: (1,339, 1,783) ft
 Lower Left: (1,340, 1,763) ft
 Lower Right: (1,703, 1,786) ft
 X Increments: 8
 Y Increments: 8
 Starting Angle: 135 °
 Ending Angle: 180 °
 Angle Increments: 2

Right Grid
 Upper Left: (1,735, 1,810) ft
 Lower Left: (1,737, 1,797) ft
 Lower Right: (1,850, 1,824) ft
 X Increments: 8
 Y Increments: 8
 Starting Angle: 45 °
 Ending Angle: 65 °
 Angle Increments: 2

Seismic Coefficients

Horz Seismic Coef.: 0
 Vert Seismic Coef.: 0

Anisotropic Strength Functions

12° (Along Bedding 10°-25°)

Model: Spline Data Point Function
 Function: Modifier Factor vs. Inclination
 Curve Fit to Data: 100 %
 Segment Curvature: 0 %
 Y-Intercept: 1
 Data Points: Inclination (°), Modifier Factor
 Data Point: (-90, 1)
 Data Point: (9.9, 1)
 Data Point: (10, 0.3)
 Data Point: (25, 0.3)
 Data Point: (25.1, 1)

150 pcf (Along Bedding 10°-25°)

Model: Spline Data Point Function
 Function: Modifier Factor vs. Inclination
 Curve Fit to Data: 100 %
 Segment Curvature: 0 %
 Y-Intercept: 1
 Data Points: Inclination (°), Modifier Factor
 Data Point: (-90, 1)
 Data Point: (-25.1, 1)
 Data Point: (-25, 0.667)
 Data Point: (-10, 0.667)
 Data Point: (-9.9, 1)

11° (Along Bedding -10°-(-25°))

Model: Spline Data Point Function
 Function: Modifier Factor vs. Inclination
 Curve Fit to Data: 100 %
 Segment Curvature: 0 %
 Y-Intercept: 1
 Data Points: Inclination (°), Modifier Factor
 Data Point: (-90, 1)
 Data Point: (-25.1, 1)
 Data Point: (-25, 0.275)
 Data Point: (-10, 0.275)
 Data Point: (-9.9, 1)

12° (Along Bedding -10°-(-25°))

Model: Spline Data Point Function
 Function: Modifier Factor vs. Inclination
 Curve Fit to Data: 100 %
 Segment Curvature: 0 %
 Y-Intercept: 1
 Data Points: Inclination (°), Modifier Factor
 Data Point: (-90, 1)
 Data Point: (-25.1, 1)
 Data Point: (-25, 0.3)
 Data Point: (-10, 0.3)
 Data Point: (-9.9, 1)

Points

	X (ft)	Y (ft)
Point 1	-47	1,822
Point 2	-7	1,838
Point 3	66	1,849
Point 4	218	1,873
Point 5	238	1,857
Point 6	292	1,830
Point 7	439	1,785
Point 8	634	1,739
Point 9	727	1,729
Point 10	793	1,729
Point 11	831	1,733
Point 12	872	1,737
Point 13	900	1,755
Point 14	929	1,767
Point 15	964	1,776
Point 16	1,022	1,779
Point 17	1,050	1,797
Point 18	1,069	1,809
Point 19	1,173	1,810
Point 20	1,224	1,777
Point 21	1,277	1,738
Point 22	1,312	1,753
Point 23	1,340	1,773

Point 24	1,429	1,777
Point 25	1,546	1,783
Point 26	1,643	1,792
Point 27	1,723	1,801
Point 28	1,769	1,808
Point 29	1,794	1,815
Point 30	1,830	1,823
Point 31	1,851	1,830
Point 32	1,862	1,841
Point 33	1,886	1,843
Point 34	1,913	1,853
Point 35	1,955	1,852
Point 36	1,993	1,862
Point 37	2,050	1,863
Point 38	2,049	1,295
Point 39	-49	1,301
Point 40	244	1,878
Point 41	276	1,871
Point 42	302	1,866
Point 43	324	1,861
Point 44	381	1,852
Point 45	402	1,847
Point 46	458	1,846
Point 47	477	1,845
Point 48	502	1,832
Point 49	531	1,823
Point 50	577	1,810
Point 51	601	1,800
Point 52	634	1,790
Point 53	696	1,771
Point 54	734	1,763
Point 55	805	1,769
Point 56	757	1,793
Point 57	890	1,789
Point 58	1,105	1,828
Point 59	1,137	1,828
Point 60	1,293	1,811
Point 61	1,397	1,816
Point 62	1,492	1,824
Point 63	1,449	1,812
Point 64	1,423	1,810
Point 65	1,372	1,791
Point 66	1,537	1,831
Point 67	1,593	1,846
Point 68	1,637	1,860
Point 69	1,671	1,876
Point 70	1,692	1,876
Point 71	1,720	1,864
Point 72	1,749	1,849
Point 73	1,769	1,843

	1,788	1,843
Point 75	1,809	1,855
Point 76	1,831	1,855
Point 77	1,839	1,857
Point 78	1,904	1,856
Point 79	1,971	1,856.2105
Point 80	293.0323	1,831
Point 81	311	1,826
Point 82	353	1,813
Point 83	439	1,787
Point 84	494	1,774
Point 85	634	1,741
Point 86	727	1,731
Point 87	793	1,731
Point 88	830.2778	1,734
Point 89	494.1087	1,772
Point 90	353	1,811.3265
Point 91	-47.6603	1,650
Point 92	1,343.5556	1,775
Point 93	1,368	1,776
Point 94	1,409	1,778
Point 95	1,429	1,779
Point 96	1,474	1,781
Point 97	1,546	1,785
Point 98	1,643	1,794
Point 99	1,723	1,803
Point 100	1,769	1,810
Point 101	1,793	1,816.12
Point 102	1,474	1,779.3077
Point 103	1,408	1,776.0562
Point 104	1,368	1,774.2584
Point 105	1,175	1,297.4995

Regions

	Material	Points	Area (ft ²)
Region 1	Tmc (12")	38,37,36,79,35,34,33,32,31,30,29,28,27,26,25,102,24,103,104,23,22,21,20,19,105	4.4177e+005
Region 2	Fill	4,40,41,42,43,80,6,5	2,420
Region 3	Qls	43,80,81,82,83,84,85,86,87,88,55,54,53,52,51,50,49,48,47,46,45,44	24,238
Region 4	Fill	51,56,57,16,15,14,13,12,11,88,55,54,53,52	10,071
Region 5	Fill	19,60,61,62,63,64,65,92,23,22,21,20	9,582
Region 6	Qls	62,63,64,65,92,93,94,95,96,97,98,99,100,101,73,72,71,70,69,68,67,66	20,085
Region 7	Fill	73,74,75,76,77,78,79,35,34,33,32,31,30,29,101	3,204.9
Region			

8	Clay	80,6,90,7,89,8,9,10,11,88,87,86,85,84,83,82,81	1,023.3
Region 9	TQs 11*	91,9,8,89,7,90,6,5,4,3,2,1	90,409
Region 10	Clay	92,23,104,103,24,102,25,26,27,28,29,101,100,99,98,97,96,95,94,93	864.17
Region 11	Tmc (-12*)	91,39,105,19,59,58,18,17,16,15,14,13,12,11,10,9	5.1344e+005

Current Slip Surface

Slip Surface: 23,682
 F of S: 2.83
 Volume: 14,099.861 ft³
 Weight: 1,410,371.5 lbs
 Resisting Force: 309,180.06 lbs
 Activating Force: 109,309.83 lbs
 F of S Rank (Analysis): 1 of 59,049 slip surfaces
 F of S Rank (Query): 1 of 10 slip surfaces
 Exit: (1,475.4155, 1,822.6034) ft
 Entry: (1,756.2086, 1,846.8374) ft
 Radius: 115.60361 ft
 Center: (1,614.2434, 1,852.8959) ft

Slip Slices

	X (ft)	Y (ft)	PWP (psf)	Base Normal Stress (psf)	Frictional Strength (psf)	Cohesive Strength (psf)
Slice 1	1,477.7462	1,821.638	0	186.56553	121.15707	200
Slice 2	1,486.0384	1,818.2033	0	583.91652	212.52823	0
Slice 3	1,496.5	1,813.8699	0	1,144.1647	416.4419	0
Slice 4	1,505.5	1,810.142	0	1,685.9154	613.62304	0
Slice 5	1,514.5	1,806.4141	0	2,227.6661	810.80417	0
Slice 6	1,523.5	1,802.6862	0	2,769.4168	1,007.9853	0
Slice 7	1,532.5	1,798.9583	0	3,311.1675	1,205.1664	0
Slice 8	1,541.2503	1,795.3338	0	3,888.3151	1,415.2309	0
Slice 9	1,549.7509	1,791.8127	0	4,500.8594	1,638.1788	0
Slice 10	1,558.2515	1,788.2916	0	5,113.4037	1,861.1267	0
Slice 11	1,564.4742	1,785.7141	0	5,412.4329	857.24515	150
Slice 12	1,567.2647	1,784.973	0	5,261.5893	4,414.9976	200
Slice 13	1,572.2356	1,785.5052	0	5,453.7896	863.79542	150
Slice 14	1,580.5414	1,786.4179	0	5,584.1954	884.44967	150
Slice 15	1,588.8471	1,787.3305	0	5,714.6012	905.10391	150
Slice 16	1,597.4	1,788.2704	0	5,870.8939	929.85825	150
Slice 17	1,606.2	1,789.2373	0	6,053.0736	958.71267	150
Slice 18	1,615	1,790.2043	0	6,235.2533	987.5671	150
Slice						

19	1,623.8	1,791.1712	0	6,417.433	1,016.4215	150
Slice 20	1,632.6	1,792.1382	0	6,599.6126	1,045.276	150
Slice 21	1,640	1,792.9513	0	6,798.2507	1,076.7371	150
Slice 22	1,647.6667	1,793.7938	0	7,073.0962	1,120.2684	150
Slice 23	1,657	1,794.8193	0	7,407.6907	1,173.2629	150
Slice 24	1,666.3333	1,795.8449	0	7,742.2852	1,226.2575	150
Slice 25	1,676.25	1,796.9345	0	7,852.2482	1,243.6739	150
Slice 26	1,686.75	1,798.0883	0	7,737.5797	1,225.5122	150
Slice 27	1,696.6667	1,799.178	0	7,430.5081	1,176.8769	150
Slice 28	1,706	1,800.2035	0	6,931.0337	1,097.7679	150
Slice 29	1,715.3333	1,801.2291	0	6,431.5592	1,018.6589	150
Slice 30	1,721.5	1,801.9067	0	6,088.3303	964.29679	150
Slice 31	1,729.5	1,802.7858	0	5,589.7084	885.32283	150
Slice 32	1,736.371	1,804.2956	0	4,471.162	708.1625	150
Slice 33	1,742.871	1,818.2349	0	2,657.9544	967.4163	0
Slice 34	1,752.6043	1,839.108	0	690.09124	251.17267	0

Section 29-29 pseudostatic right SSA for Skyline Ranch.gsz

Section 29-29 pseudostatic right SSA for Skyline Ranch.gsz Run By: Dr. Alexander Bykovtsev, Ph.D., P.E. 3/15/2016 2:04:00 PM

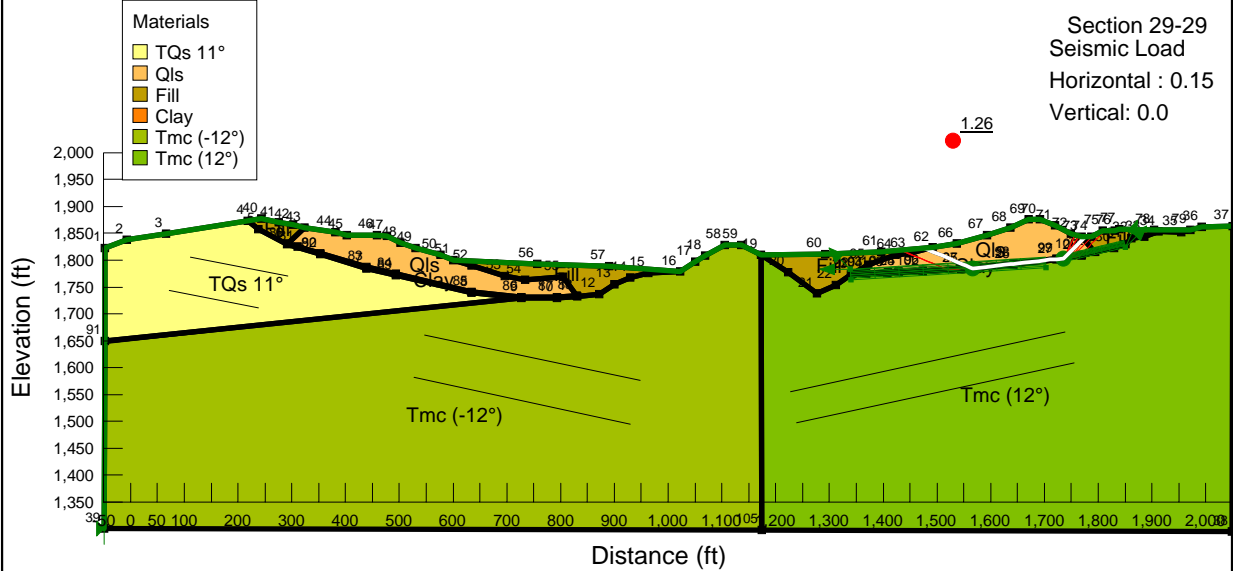

**Section 29-29
Seismic Load**
Horizontal : 0.15
Vertical: 0.0

Name: TQs 11°
Model: Anisotropic Fn.
Unit Weight: 120 pcf
Cohesion: 225 psf
Phi: 40°
Phi-Anisotropic Strength Fn.: 11° (Along Bedding -10°-(-2)
C-Anisotropic Strength Fn.: 150 pcf (Along Bedding 10°-2

Name: Qls
Model: Mohr-Coulomb
Unit Weight: 100 pcf
Cohesion: 0 psf
Phi: 20°

Name: Fill
Model: Mohr-Coulomb
Unit Weight: 120 pcf
Cohesion: 200 psf
Phi: 33°

Name: Clay
Model: Mohr-Coulomb
Unit Weight: 100 pcf
Cohesion: 150 psf
Phi: 9°

Name: Tmc (-12°)
Model: Anisotropic Fn.
Unit Weight: 120 pcf
Cohesion: 200 psf
Phi: 40°
Phi-Anisotropic Strength Fn.: 12° (Along Bedding -10°-(-2)
C-Anisotropic Strength Fn.: 150 pcf (Along Bedding 10°-2

Name: Tmc (12°)
Model: Anisotropic Fn.
Unit Weight: 120 pcf
Cohesion: 200 psf
Phi: 40°
Phi-Anisotropic Strength Fn.: 12° (Along Bedding 10°-25°)
C-Anisotropic Strength Fn.: 150 pcf (Along Bedding 10°-2

LGC LGC Valley, Inc
GEOTECHNICAL CONSULTING
28532 Constellation Road, Valencia, CA 91355
Phone 661-702-8474, Fax 661-702-8475

Skyline Ranch
Development project, Tract 60922
Los Angeles CA

Project No: **153035-01**
Engineer: **BAS**
Date: **March 2016**

2 - Translational

Report generated using GeoStudio 2012. Copyright © 1991-2016 GEO-SLOPE International Ltd.

File Information

File Version: 8.15
 Title: Static Slope Stability Analyses for Skyline Ranch Development project, Tract 60922, Los Angeles CA
 Comments: Run By: Dr. Alexander Bykovtsev, Ph.D., P.E.
 Last Edited By: Alexander Bykovtsev
 Revision Number: 155
 Date: 3/15/2016
 Time: 2:04:00 PM
 Tool Version: 8.15.5.11777
 File Name: Section 29-29 pseudostatic right SSA for Skyline Ranch.gsz
 Directory: P:\FINAL PROJECTS\PARDEE\Skyline Ranch\SLOPE RESULTS\Section 29-29 results\
 Last Solved Date: 3/15/2016
 Last Solved Time: 2:05:19 PM

Project Settings

Length(L) Units: Feet
 Time(t) Units: Seconds
 Force(F) Units: Pounds
 Pressure(p) Units: psf
 Strength Units: psf
 Unit Weight of Water: 62.4 pcf
 View: 2D
 Element Thickness: 1

Analysis Settings

2 - Translational

Kind: SLOPE/W
 Method: Spencer
 Settings
 PWP Conditions Source: (none)
 Slip Surface
 Direction of movement: Right to Left
 Use Passive Mode: No
 Slip Surface Option: Block
 Critical slip surfaces saved: 10
 Resisting Side Maximum Convex Angle: 1 °
 Driving Side Maximum Convex Angle: 5 °
 Restrict Block Crossing: No
 Optimize Critical Slip Surface Location: No
 Tension Crack
 Tension Crack Option: (none)
 F of S Distribution
 F of S Calculation Option: Constant
 Advanced
 Number of Slices: 30
 F of S Tolerance: 0.01
 Minimum Slip Surface Depth: 0.1 ft
 Search Method: Root Finder

file:///P:/FINAL%20PROJECTS/PARDEE/Skyline%20Ranch/SLOPE%20RESULTS/Sect... 3/15/2016

Tolerable difference between starting and converged F of S: 3
 Maximum iterations to calculate converged lambda: 20
 Max Absolute Lambda: 2

Materials

TQs 11°

Model: Anisotropic Fn.
 Unit Weight: 120 pcf
 Cohesion: 225 psf
 Phi: 40 °
 Phi-Anisotropic Strength Fn.: 11° (Along Bedding -10°-(-25°)
 C-Anisotropic Strength Fn.: 150 pcf (Along Bedding 10°-25°)
 Phi-B: 0 °

QIs

Model: Mohr-Coulomb
 Unit Weight: 100 pcf
 Cohesion: 0 psf
 Phi: 20 °
 Phi-B: 0 °

Fill

Model: Mohr-Coulomb
 Unit Weight: 120 pcf
 Cohesion: 200 psf
 Phi: 33 °
 Phi-B: 0 °

Clay

Model: Mohr-Coulomb
 Unit Weight: 100 pcf
 Cohesion: 150 psf
 Phi: 9 °
 Phi-B: 0 °

Tmc (-12°)

Model: Anisotropic Fn.
 Unit Weight: 120 pcf
 Cohesion: 200 psf
 Phi: 40 °
 Phi-Anisotropic Strength Fn.: 12° (Along Bedding -10°-(-25°)
 C-Anisotropic Strength Fn.: 150 pcf (Along Bedding 10°-25°)
 Phi-B: 0 °

Tmc (12°)

Model: Anisotropic Fn.
 Unit Weight: 120 pcf
 Cohesion: 200 psf
 Phi: 40 °
 Phi-Anisotropic Strength Fn.: 12° (Along Bedding 10°-25°)
 C-Anisotropic Strength Fn.: 150 pcf (Along Bedding 10°-25°)
 Phi-B: 0 °

file:///P:/FINAL%20PROJECTS/PARDEE/Skyline%20Ranch/SLOPE%20RESULTS/Sect... 3/15/2016

Slip Surface Limits

Left Coordinate: (-49, 1,301) ft
 Right Coordinate: (2,050, 1,863) ft

Slip Surface Block

Left Grid
 Upper Left: (1,339, 1,783) ft
 Lower Left: (1,340, 1,763) ft
 Lower Right: (1,703, 1,786) ft
 X Increments: 8
 Y Increments: 8
 Starting Angle: 135 °
 Ending Angle: 180 °
 Angle Increments: 2

Right Grid
 Upper Left: (1,735, 1,810) ft
 Lower Left: (1,737, 1,797) ft
 Lower Right: (1,850, 1,824) ft
 X Increments: 8
 Y Increments: 8
 Starting Angle: 45 °
 Ending Angle: 65 °
 Angle Increments: 2

Seismic Coefficients

Horz Seismic Coef.: 0.15
 Vert Seismic Coef.: 0

Anisotropic Strength Functions

12° (Along Bedding 10°-25°)

Model: Spline Data Point Function
 Function: Modifier Factor vs. Inclination
 Curve Fit to Data: 100 %
 Segment Curvature: 0 %
 Y-Intercept: 1
 Data Points: Inclination (*), Modifier Factor
 Data Point: (-90, 1)
 Data Point: (9.9, 1)
 Data Point: (10, 0.3)
 Data Point: (25, 0.3)
 Data Point: (25.1, 1)

150 pcf (Along Bedding 10°-25°)

Model: Spline Data Point Function
 Function: Modifier Factor vs. Inclination
 Curve Fit to Data: 100 %
 Segment Curvature: 0 %
 Y-Intercept: 1
 Data Points: Inclination (*), Modifier Factor
 Data Point: (-90, 1)

Data Point: (-25.1, 1)
 Data Point: (-25, 0.667)
 Data Point: (-10, 0.667)
 Data Point: (-9.9, 1)

11° (Along Bedding -10°-(-25°))

Model: Spline Data Point Function
 Function: Modifier Factor vs. Inclination
 Curve Fit to Data: 100 %
 Segment Curvature: 0 %
 Y-Intercept: 1
 Data Points: Inclination (*), Modifier Factor
 Data Point: (-90, 1)
 Data Point: (-25.1, 1)
 Data Point: (-25, 0.275)
 Data Point: (-10, 0.275)
 Data Point: (-9.9, 1)

12° (Along Bedding -10°-(-25°))

Model: Spline Data Point Function
 Function: Modifier Factor vs. Inclination
 Curve Fit to Data: 100 %
 Segment Curvature: 0 %
 Y-Intercept: 1
 Data Points: Inclination (*), Modifier Factor
 Data Point: (-90, 1)
 Data Point: (-25.1, 1)
 Data Point: (-25, 0.3)
 Data Point: (-10, 0.3)
 Data Point: (-9.9, 1)

Points

	X (ft)	Y (ft)
Point 1	-47	1,822
Point 2	-7	1,838
Point 3	66	1,849
Point 4	218	1,873
Point 5	238	1,857
Point 6	292	1,830
Point 7	439	1,785
Point 8	634	1,739
Point 9	727	1,729
Point 10	793	1,729
Point 11	831	1,733
Point 12	872	1,737
Point 13	900	1,755
Point 14	929	1,767
Point 15	964	1,776
Point 16	1,022	1,779
Point 17	1,050	1,797
Point 18	1,069	1,809
Point 19	1,173	1,810
Point 20	1,224	1,777

Point 21	1,277	1,738
Point 22	1,312	1,753
Point 23	1,340	1,773
Point 24	1,429	1,777
Point 25	1,546	1,783
Point 26	1,643	1,792
Point 27	1,723	1,801
Point 28	1,769	1,808
Point 29	1,794	1,815
Point 30	1,830	1,823
Point 31	1,851	1,830
Point 32	1,862	1,841
Point 33	1,886	1,843
Point 34	1,913	1,853
Point 35	1,955	1,852
Point 36	1,993	1,862
Point 37	2,050	1,863
Point 38	2,049	1,295
Point 39	-49	1,301
Point 40	244	1,878
Point 41	276	1,871
Point 42	302	1,866
Point 43	324	1,861
Point 44	381	1,852
Point 45	402	1,847
Point 46	458	1,846
Point 47	477	1,845
Point 48	502	1,832
Point 49	531	1,823
Point 50	577	1,810
Point 51	601	1,800
Point 52	634	1,790
Point 53	696	1,771
Point 54	734	1,763
Point 55	805	1,769
Point 56	757	1,793
Point 57	890	1,789
Point 58	1,105	1,828
Point 59	1,137	1,828
Point 60	1,293	1,811
Point 61	1,397	1,816
Point 62	1,492	1,824
Point 63	1,449	1,812
Point 64	1,423	1,810
Point 65	1,372	1,791
Point 66	1,537	1,831
Point 67	1,593	1,846
Point 68	1,637	1,860
Point 69	1,671	1,876
Point 70	1,692	1,876

	1,720	1,864
Point 72	1,749	1,849
Point 73	1,769	1,843
Point 74	1,788	1,843
Point 75	1,809	1,855
Point 76	1,831	1,855
Point 77	1,839	1,857
Point 78	1,904	1,856
Point 79	1,971	1,856.2105
Point 80	293.0323	1,831
Point 81	311	1,826
Point 82	353	1,813
Point 83	439	1,787
Point 84	494	1,774
Point 85	634	1,741
Point 86	727	1,731
Point 87	793	1,731
Point 88	830.2778	1,734
Point 89	494.1087	1,772
Point 90	353	1,811.3265
Point 91	-47.6603	1,650
Point 92	1,343.5556	1,775
Point 93	1,368	1,776
Point 94	1,409	1,778
Point 95	1,429	1,779
Point 96	1,474	1,781
Point 97	1,546	1,785
Point 98	1,643	1,794
Point 99	1,723	1,803
Point 100	1,769	1,810
Point 101	1,793	1,816.12
Point 102	1,474	1,779.3077
Point 103	1,408	1,776.0562
Point 104	1,368	1,774.2584
Point 105	1,175	1,297.4995

Regions

	Material	Points	Area (ft ²)
Region 1	Tmc (12")	38,37,36,79,35,34,33,32,31,30,29,28,27,26,25,102,24,103,104,23,22,21,20,19,105	4.4177e+005
Region 2	Fill	4,40,41,42,43,80,6,5	2,420
Region 3	Qls	43,80,81,82,83,84,85,86,87,88,55,54,53,52,51,50,49,48,47,46,45,44	24,238
Region 4	Fill	51,56,57,16,15,14,13,12,11,88,55,54,53,52	10,071
Region 5	Fill	19,60,61,62,63,64,65,92,23,22,21,20	9,582
Region 6	Qls	62,63,64,65,92,93,94,95,96,97,98,99,100,101,73,72,71,70,69,68,67,66	20,085

Region 7	Fill	73,74,75,76,77,78,79,35,34,33,32,31,30,29,101	3,204.9
Region 8	Clay	80,6,90,7,89,8,9,10,11,88,87,86,85,84,83,82,81	1,023.3
Region 9	TQs 11°	91,9,8,89,7,90,6,5,4,3,2,1	90,409
Region 10	Clay	92,23,104,103,24,102,25,26,27,28,29,101,100,99,98,97,96,95,94,93	864.17
Region 11	Tmc (-12°)	91,39,105,19,59,58,18,17,16,15,14,13,12,11,10,9	5.1344e+005

Current Slip Surface

Slip Surface: 23,680
 F of S: 1.26
 Volume: 14,544,184 ft³
 Weight: 1,455,027 lbs
 Resisting Moment: 24,828,372 lbs-ft
 Activating Moment: 19,734,169 lbs-ft
 Resisting Force: 337,183.67 lbs
 Activating Force: 268,468.8 lbs
 F of S Rank (Analysis): 1 of 59,049 slip surfaces
 F of S Rank (Query): 1 of 10 slip surfaces
 Exit: (1,475.4155, 1,822.6034) ft
 Entry: (1,775.5, 1,843) ft
 Radius: 119.6971 ft
 Center: (1,624.418, 1,848.0991) ft

Slip Slices

	X (ft)	Y (ft)	PWP (psf)	Base Normal Stress (psf)	Frictional Strength (psf)	Cohesive Strength (psf)
Slice 1	1,477.7462	1,821.638	0	438.53267	284.78645	200
Slice 2	1,486.0384	1,818.2033	0	759.72367	276.5168	0
Slice 3	1,497.625	1,813.404	0	1,576.7607	573.89397	0
Slice 4	1,508.875	1,808.7441	0	2,457.8388	894.58016	0
Slice 5	1,520.125	1,804.0842	0	3,338.9169	1,215.2664	0
Slice 6	1,531.375	1,799.4243	0	4,219.9949	1,535.9525	0
Slice 7	1,541.2503	1,795.3338	0	5,059.0194	1,841.3325	0
Slice 8	1,549.7509	1,791.8127	0	5,855.9902	2,131.4061	0
Slice 9	1,558.2515	1,788.2916	0	6,652.961	2,421.4798	0
Slice 10	1,564.4742	1,785.7141	0	6,355.0757	1,006.5451	150
Slice 11	1,567.2647	1,784.973	0	5,725.9629	4,804.6533	200
Slice 12	1,574.312	1,785.7334	0	5,280.3356	836.323	150
Slice 13	1,586.7707	1,787.1024	0	5,467.7746	866.01042	150
Slice 14	1,598.5	1,788.3912	0	5,670.6009	898.13495	150
Slice 15	1,609.5	1,789.5999	0	5,888.8145	932.69659	150
Slice 16	1,620.5	1,790.8086	0	6,107.0281	967.25823	150

Slice 17	1,631.5	1,792.0173	0	6,325.2417	1,001.8199	150
Slice 18	1,640	1,792.9513	0	6,537.405	1,035.4232	150
Slice 19	1,647.6667	1,793.7938	0	6,800.7715	1,077.1364	150
Slice 20	1,657	1,794.8193	0	7,121.3915	1,127.9176	150
Slice 21	1,666.3333	1,795.8449	0	7,442.0116	1,178.6988	150
Slice 22	1,676.25	1,796.9345	0	7,547.382	1,195.3879	150
Slice 23	1,686.75	1,798.0883	0	7,437.5026	1,177.9847	150
Slice 24	1,696.6667	1,799.178	0	7,143.256	1,131.3806	150
Slice 25	1,706	1,800.2035	0	6,664.6422	1,055.5756	150
Slice 26	1,715.3333	1,801.2291	0	6,186.0284	979.77065	150
Slice 27	1,721.5	1,801.9067	0	5,857.1346	927.67899	150
Slice 28	1,729.5	1,802.7858	0	5,379.3378	852.0034	150
Slice 29	1,736.8718	1,804.3718	0	3,554.7949	563.02421	150
Slice 30	1,743.3718	1,810.8718	0	2,680.63	975.66955	0
Slice 31	1,754	1,821.5	0	1,698.282	618.12409	0
Slice 32	1,764	1,831.5	0	849.14099	309.06204	0
Slice 33	1,770.533	1,838.033	0	346.86608	126.24893	0
Slice 34	1,773.783	1,841.283	0	49.030317	31.84066	200

Section 32-32 Static Circular SSA for Skyline Ranch.gsz

Section 32-32 Static Circular SSA for Skyline Ranch.gsz Run By: Dr. Alexander Bykovtsev, Ph.D., P.E. 3/14/2016 7:30:41 PM

- Materials**
- TQs
 - QIs
 - Fill
 - Clay

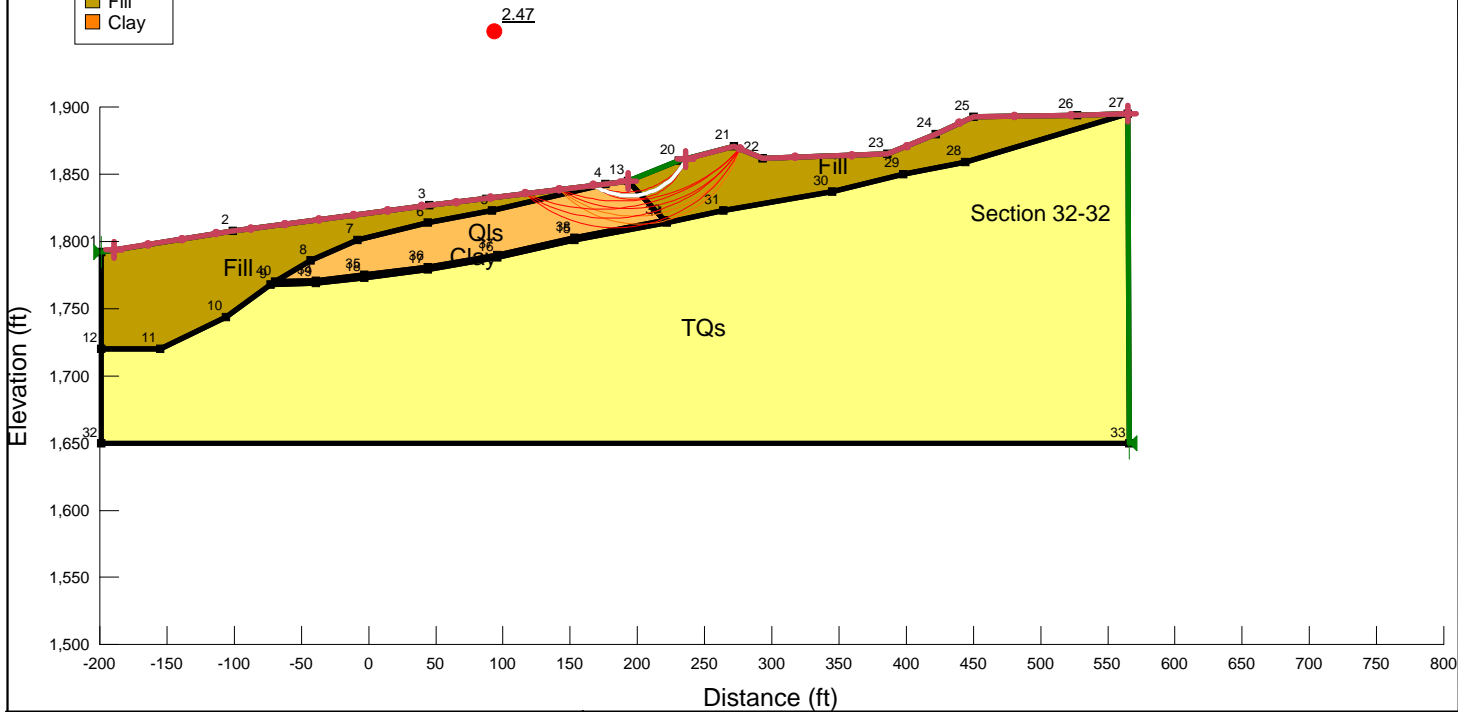

Name: TQs
 Model: Anisotropic Fn.
 Unit Weight: 120 pcf
 Cohesion!: 225 psf
 Phi!: 40 °
 Phi-Anisotropic Strength Fn.: 11° (Along Bedding 10-25°)
 C-Anisotropic Strength Fn.: 150 pcf (Along Bedding 10-25°)

Name: QIs
 Model: Mohr-Coulomb
 Unit Weight: 100 pcf
 Cohesion!: 0 psf
 Phi!: 20 °

Name: Fill
 Model: Mohr-Coulomb
 Unit Weight: 120 pcf
 Cohesion!: 200 psf
 Phi!: 33 °

Name: Clay
 Model: Mohr-Coulomb
 Unit Weight: 100 pcf
 Cohesion!: 150 psf
 Phi!: 9 °

LGC **LGC Valley, Inc**
 GEOTECHNICAL CONSULTING
 28532 Constellation Road, Valencia, CA 91355
 Phone 661-702-8474, Fax 661-702-8475

Skyline Ranch
 Development project, Tract 60922
 Los Angeles CA

Project No: **153035-01**
 Engineer: **BAS**
 Date: **March 2016**

2 - Circular

Report generated using GeoStudio 2012. Copyright © 1991-2016 GEO-SLOPE International Ltd.

File Information

File Version: 8.15
 Title: *Static Slope Stability Analyses for Skyline Ranch Development project, Tract 60922, Los Angeles CA*
 Comments: Run By: Dr. Alexander Bykovtsev, Ph.D., P.E.
 Last Edited By: Alexander Bykovtsec
 Revision Number: 145
 Date: 3/14/2016
 Time: 7:30:41 PM
 Tool Version: 8.15.5.11777
 File Name: Section 32-32 Static Circular SSA for Skyline Ranch.gsz
 Directory: P:\FINAL PROJECTS\PARDEE\Skyline Ranch\SLOPE RESULTS\Section 32-32 results\
 Last Solved Date: 3/14/2016
 Last Solved Time: 7:30:43 PM

Project Settings

Length(L) Units: Feet
 Time(t) Units: Seconds
 Force(F) Units: Pounds
 Pressure(p) Units: psf
 Strength Units: psf
 Unit Weight of Water: 62.4 pcf
 View: 2D
 Element Thickness: 1

Analysis Settings

2 - Circular

Kind: *SLOPE/W*
 Method: *Bishop*
 Settings
 PWP Conditions Source: *(none)*
 Slip Surface
 Direction of movement: *Right to Left*
 Use Passive Mode: *No*
 Slip Surface Option: *Entry and Exit*
 Critical slip surfaces saved: 10
 Resisting Side Maximum Convex Angle: *1 °*
 Driving Side Maximum Convex Angle: *5 °*
 Optimize Critical Slip Surface Location: *No*
 Tension Crack
 Tension Crack Option: *(none)*
 F of S Distribution

file:///P:/FINAL%20PROJECTS/PARDEE/Skyline%20Ranch/SLOPE%20RESULTS/Sect... 3/14/2016

F of S Calculation Option: *Constant*
 Advanced
 Number of Slices: 30
 F of S Tolerance: 0.01
 Minimum Slip Surface Depth: 0.1 ft

Materials

TQs

Model: *Anisotropic Fn.*
 Unit Weight: 120 pcf
 Cohesion': 225 psf
 Phi': 40 °
 Phi-Anisotropic Strength Fn.: 11° (Along Bedding 10-25°)
 C-Anisotropic Strength Fn.: 150 pcf (Along Bedding 10-25°)
 Phi-B: 0 °

QIs

Model: *Mohr-Coulomb*
 Unit Weight: 100 pcf
 Cohesion': 0 psf
 Phi': 20 °
 Phi-B: 0 °

Fill

Model: *Mohr-Coulomb*
 Unit Weight: 120 pcf
 Cohesion': 200 psf
 Phi': 33 °
 Phi-B: 0 °

Clay

Model: *Mohr-Coulomb*
 Unit Weight: 100 pcf
 Cohesion': 150 psf
 Phi': 9 °
 Phi-B: 0 °

Slip Surface Entry and Exit

Left Projection: *Range*
 Left-Zone Left Coordinate: (-189.3733, 1,793.5717) ft
 Left-Zone Right Coordinate: (193, 1,845) ft
 Left-Zone Increment: 15
 Right Projection: *Range*
 Right-Zone Left Coordinate: (236, 1,861.3415) ft
 Right-Zone Right Coordinate: (565, 1,895) ft
 Right-Zone Increment: 8
 Radius Increments: 8

file:///P:/FINAL%20PROJECTS/PARDEE/Skyline%20Ranch/SLOPE%20RESULTS/Sect... 3/14/2016

Slip Surface Limits

Left Coordinate: (-199, 1,792) ft
 Right Coordinate: (566, 1,650) ft

Seismic Coefficients

Horz Seismic Coef.: 0
 Vert Seismic Coef.: 0

Anisotropic Strength Functions

11° (Along Bedding 10-25°)

Model: Spline Data Point Function
 Function: Modifier Factor vs. Inclination
 Curve Fit to Data: 100 %
 Segment Curvature: 0 %
 Y-Intercept: 1
 Data Points: Inclination (°), Modifier Factor
 Data Point: (-90, 1)
 Data Point: (9.9, 1)
 Data Point: (10, 0.275)
 Data Point: (25, 0.275)
 Data Point: (25.1, 1)

150 pcf (Along Bedding 10-25°)

Model: Spline Data Point Function
 Function: Modifier Factor vs. Inclination
 Curve Fit to Data: 100 %
 Segment Curvature: 0 %
 Y-Intercept: 1
 Data Points: Inclination (°), Modifier Factor
 Data Point: (-90, 1)
 Data Point: (9.9, 1)
 Data Point: (10, 0.667)
 Data Point: (25, 0.667)
 Data Point: (25.1, 1)

Points

	X (ft)	Y (ft)
Point 1	-199	1,792
Point 2	-101	1,808
Point 3	45	1,827
Point 4	176	1,843
Point 5	92	1,823

Point 6	44	1,814
Point 7	-8	1,801
Point 8	-43	1,786
Point 9	-73	1,768
Point 10	-106	1,744
Point 11	-155	1,720
Point 12	-199	1,720
Point 13	193	1,845
Point 14	222	1,814
Point 15	153	1,801
Point 16	96	1,788
Point 17	44	1,779
Point 18	-3	1,773
Point 19	-39	1,769
Point 20	231	1,860
Point 21	272	1,871
Point 22	293	1,862
Point 23	386	1,865
Point 24	422	1,880
Point 25	450	1,893
Point 26	527	1,894
Point 27	565	1,895
Point 28	444	1,859
Point 29	398	1,850
Point 30	345	1,837
Point 31	264	1,823
Point 32	-199	1,650
Point 33	566	1,650
Point 34	-39	1,771
Point 35	-3	1,775
Point 36	44	1,781
Point 37	96	1,790
Point 38	153	1,803
Point 39	220.129	1,816
Point 40	-69.6667	1,770

Regions

	Material	Points	Area (ft²)
Region 1	Fill	1,2,3,4,5,6,7,8,40,9,10,11,12	12,311
Region 2	Qls	4,5,6,7,8,40,34,35,36,37,38,39,13	8,037.7
Region 3	Fill	13,20,21,22,23,24,25,26,27,28,29,30,31,14,39	9,613
Region 4	TQs	12,32,33,27,28,29,30,31,14,15,16,17,18,19,9,10,11	1.1986e+005
Region 5	Clay	34,40,9,19,18,17,16,15,14,39,38,37,36,35	595.29

Current Slip Surface

Slip Surface: 1,140
 F of S: 2.47
 Volume: 683.94696 ft³
 Weight: 77,569.632 lbs
 Resisting Moment: 2,366,953.7 lbs-ft
 Activating Moment: 956,929.48 lbs-ft
 F of S Rank (Analysis): 1 of 1,296 slip surfaces
 F of S Rank (Query): 1 of 10 slip surfaces
 Exit: (167.45638, 1,841.9565) ft
 Entry: (236.00001, 1,861.3415) ft
 Radius: 46.6877 ft
 Center: (193.51323, 1,880.6964) ft

Slip Slices

	X (ft)	Y (ft)	PWP (psf)	Base Normal Stress (psf)	Frictional Strength (psf)	Cohesive Strength (psf)
Slice 1	168.01281	1,841.5936	0	125.6967	81.628394	200
Slice 2	169.8077	1,840.5004	0	206.55409	75.179541	0
Slice 3	172.28462	1,839.1374	0	377.79763	137.50709	0
Slice 4	174.76154	1,837.9614	0	525.41828	191.23661	0
Slice 5	177.21429	1,836.9654	0	653.46478	237.84173	0
Slice 6	179.64286	1,836.1348	0	764.25891	278.1675	0
Slice 7	182.07143	1,835.4498	0	858.27573	312.38682	0
Slice 8	184.5	1,834.9037	0	936.66198	340.91708	0
Slice 9	186.92857	1,834.4917	0	1,000.308	364.08235	0
Slice 10	189.35714	1,834.2101	0	1,049.9006	382.13257	0
Slice 11	191.78571	1,834.0565	0	1,085.9596	395.25695	0
Slice 12	194.18384	1,834.0286	0	1,176.0515	428.04774	0
Slice 13	196.55153	1,834.1228	0	1,319.2579	480.17062	0
Slice 14	198.91922	1,834.3381	0	1,448.3558	527.15842	0
Slice	201.2869	1,834.6761	0	1,563.3683	569.01951	0

15						
Slice 16	203.65946	1,835.1408	0	1,578.1098	1,024.8365	200
Slice 17	206.0369	1,835.7367	0	1,590.747	1,033.0432	200
Slice 18	208.41434	1,836.4683	0	1,586.9123	1,030.5529	200
Slice 19	210.79178	1,837.3426	0	1,566.2181	1,017.1139	200
Slice 20	213.16922	1,838.3684	0	1,528.0941	992.35594	200
Slice 21	215.54665	1,839.557	0	1,471.7568	955.77003	200
Slice 22	217.92409	1,840.9233	0	1,396.162	906.67819	200
Slice 23	220.30153	1,842.4862	0	1,299.9364	844.18857	200
Slice 24	222.67897	1,844.2714	0	1,181.2736	767.12808	200
Slice 25	225.05641	1,846.3138	0	1,037.7743	673.93853	200
Slice 26	227.43384	1,848.6631	0	866.1895	562.51004	200
Slice 27	229.81128	1,851.3944	0	661.98714	429.89947	200
Slice 28	232.25	1,854.7318	0	397.1737	257.92762	200
Slice 29	234.75001	1,858.9691	0	61.14504	39.708053	200

Section 32-32 Pseudostatic Circular SSA for Skyline Ranch.gsz

Section 32-32 Pseudostatic Circular SSA for Skyline Ranch.gsz Run By: Dr. Alexander Bykovtsev, Ph.D., P.E. 3/14/2016 7:33:45 PM

- Materials
- TQs
 - Qls
 - Fill
 - Clay

1.50

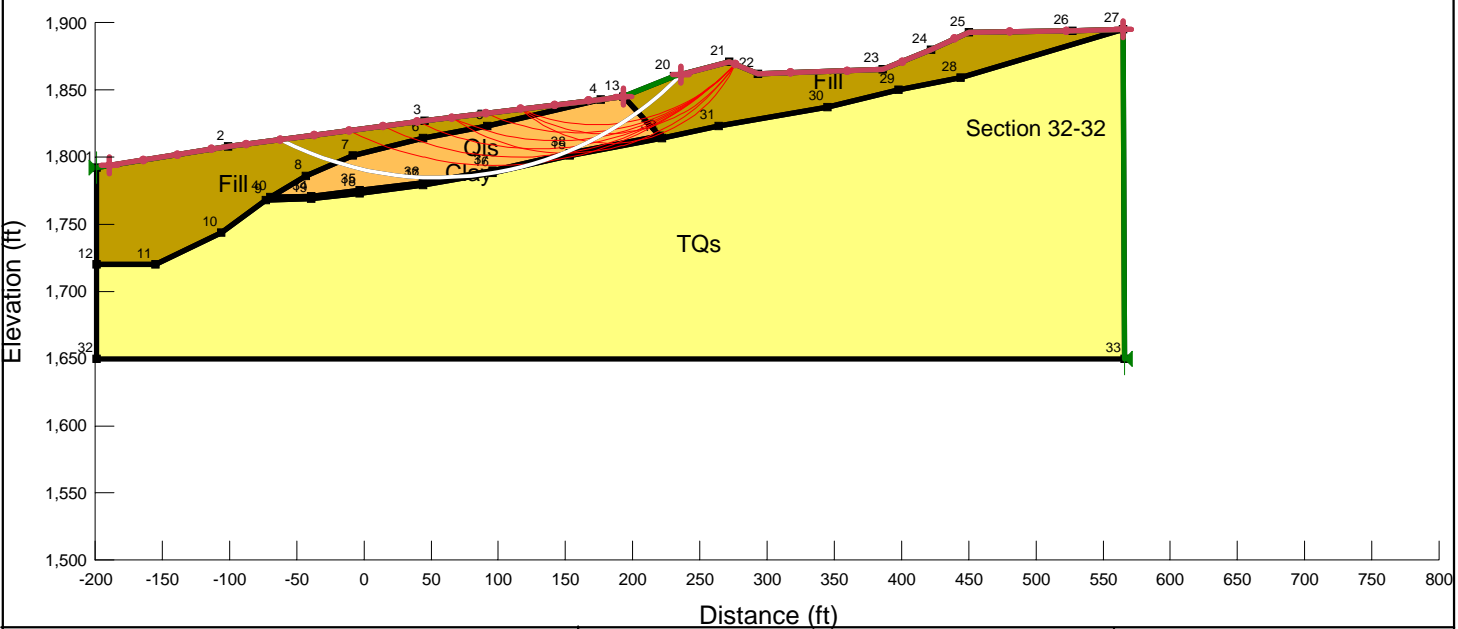

Name: TQs
 Model: Anisotropic Fn.
 Unit Weight: 120 pcf
 Cohesion': 225 psf
 Phi': 40 °
 Phi-Anisotropic Strength Fn.: 11° (Along Bedding 10-25°)
 C-Anisotropic Strength Fn.: 150 pcf (Along Bedding 10-25°)

Name: Qls
 Model: Mohr-Coulomb
 Unit Weight: 100 pcf
 Cohesion': 0 psf
 Phi': 20 °

Name: Fill
 Model: Mohr-Coulomb
 Unit Weight: 120 pcf
 Cohesion': 200 psf
 Phi': 33 °

Name: Clay
 Model: Mohr-Coulomb
 Unit Weight: 100 pcf
 Cohesion': 150 psf
 Phi': 9 °

LGC Valley, Inc
 GEOTECHNICAL CONSULTING
 28532 Constellation Road, Valencia, CA 91355
 Phone 661-702-8474, Fax 661-702-8475

Skyline Ranch
 Development project, Tract 60922
 Los Angeles CA

Project No: **153035-01**
 Engineer: **BAS**
 Date: **March 2016**

2 - Circular

Report generated using GeoStudio 2012. Copyright © 1991-2016 GEO-SLOPE International Ltd.

File Information

File Version: 8.15
 Title: *Static Slope Stability Analyses for Skyline Ranch Development project, Tract 60922, Los Angeles CA*
 Comments: Run By: Dr. Alexander Bykovtsev, Ph.D., P.E.
 Last Edited By: Alexander Bykovtsec
 Revision Number: 148
 Date: 3/14/2016
 Time: 7:33:45 PM
 Tool Version: 8.15.5.11777
 File Name: Section 32-32 Pseudostatic Circular SSA for Skyline Ranch.gsz
 Directory: P:\FINAL PROJECTS\PARDEE\Skyline Ranch\SLOPE RESULTS\Section 32-32 results\
 Last Solved Date: 3/14/2016
 Last Solved Time: 7:35:00 PM

Project Settings

Length(L) Units: Feet
 Time(t) Units: Seconds
 Force(F) Units: Pounds
 Pressure(p) Units: psf
 Strength Units: psf
 Unit Weight of Water: 62.4 pcf
 View: 2D
 Element Thickness: 1

Analysis Settings

2 - Circular

Kind: *SLOPE/W*
 Method: *Bishop*
 Settings
 PWP Conditions Source: *(none)*
 Slip Surface
 Direction of movement: *Right to Left*
 Use Passive Mode: *No*
 Slip Surface Option: *Entry and Exit*
 Critical slip surfaces saved: 10
 Resisting Side Maximum Convex Angle: 1 °
 Driving Side Maximum Convex Angle: 5 °
 Optimize Critical Slip Surface Location: *No*
 Tension Crack
 Tension Crack Option: *(none)*
 F of S Distribution

file:///P:/FINAL%20PROJECTS/PARDEE/Skyline%20Ranch/SLOPE%20RESULTS/Sect... 3/14/2016

F of S Calculation Option: *Constant*
 Advanced
 Number of Slices: 30
 F of S Tolerance: 0.01
 Minimum Slip Surface Depth: 0.1 ft

Materials

TQs

Model: *Anisotropic Fn.*
 Unit Weight: 120 pcf
 Cohesion': 225 psf
 Phi': 40 °
 Phi-Anisotropic Strength Fn.: 11° (Along Bedding 10-25°)
 C-Anisotropic Strength Fn.: 150 pcf (Along Bedding 10-25°)
 Phi-B: 0 °

QIs

Model: *Mohr-Coulomb*
 Unit Weight: 100 pcf
 Cohesion': 0 psf
 Phi': 20 °
 Phi-B: 0 °

Fill

Model: *Mohr-Coulomb*
 Unit Weight: 120 pcf
 Cohesion': 200 psf
 Phi': 33 °
 Phi-B: 0 °

Clay

Model: *Mohr-Coulomb*
 Unit Weight: 100 pcf
 Cohesion': 150 psf
 Phi': 9 °
 Phi-B: 0 °

Slip Surface Entry and Exit

Left Projection: *Range*
 Left-Zone Left Coordinate: (-189.3733, 1,793.5717) ft
 Left-Zone Right Coordinate: (193, 1,845) ft
 Left-Zone Increment: 15
 Right Projection: *Range*
 Right-Zone Left Coordinate: (236, 1,861.3415) ft
 Right-Zone Right Coordinate: (565, 1,895) ft
 Right-Zone Increment: 8
 Radius Increments: 8

file:///P:/FINAL%20PROJECTS/PARDEE/Skyline%20Ranch/SLOPE%20RESULTS/Sect... 3/14/2016

Slip Surface Limits

Left Coordinate: (-199, 1,792) ft
 Right Coordinate: (566, 1,650) ft

Seismic Coefficients

Horz Seismic Coef.: 0.15
 Vert Seismic Coef.: 0

Anisotropic Strength Functions

11° (Along Bedding 10-25°)

Model: Spline Data Point Function
 Function: Modifier Factor vs. Inclination
 Curve Fit to Data: 100 %
 Segment Curvature: 0 %
 Y-Intercept: 1
 Data Points: Inclination (°), Modifier Factor
 Data Point: (-90, 1)
 Data Point: (9.9, 1)
 Data Point: (10, 0.275)
 Data Point: (25, 0.275)
 Data Point: (25.1, 1)

150 pcf (Along Bedding 10-25°)

Model: Spline Data Point Function
 Function: Modifier Factor vs. Inclination
 Curve Fit to Data: 100 %
 Segment Curvature: 0 %
 Y-Intercept: 1
 Data Points: Inclination (°), Modifier Factor
 Data Point: (-90, 1)
 Data Point: (9.9, 1)
 Data Point: (10, 0.667)
 Data Point: (25, 0.667)
 Data Point: (25.1, 1)

Points

	X (ft)	Y (ft)
Point 1	-199	1,792
Point 2	-101	1,808
Point 3	45	1,827
Point 4	176	1,843
Point 5	92	1,823

Point 6	44	1,814
Point 7	-8	1,801
Point 8	-43	1,786
Point 9	-73	1,768
Point 10	-106	1,744
Point 11	-155	1,720
Point 12	-199	1,720
Point 13	193	1,845
Point 14	222	1,814
Point 15	153	1,801
Point 16	96	1,788
Point 17	44	1,779
Point 18	-3	1,773
Point 19	-39	1,769
Point 20	231	1,860
Point 21	272	1,871
Point 22	293	1,862
Point 23	386	1,865
Point 24	422	1,880
Point 25	450	1,893
Point 26	527	1,894
Point 27	565	1,895
Point 28	444	1,859
Point 29	398	1,850
Point 30	345	1,837
Point 31	264	1,823
Point 32	-199	1,650
Point 33	566	1,650
Point 34	-39	1,771
Point 35	-3	1,775
Point 36	44	1,781
Point 37	96	1,790
Point 38	153	1,803
Point 39	220.129	1,816
Point 40	-69.6667	1,770

Regions

	Material	Points	Area (ft²)
Region 1	Fill	1,2,3,4,5,6,7,8,40,9,10,11,12	12,311
Region 2	Qls	4,5,6,7,8,40,34,35,36,37,38,39,13	8,037.7
Region 3	Fill	13,20,21,22,23,24,25,26,27,28,29,30,31,14,39	9,613
Region 4	TQs	12,32,33,27,28,29,30,31,14,15,16,17,18,19,9,10,11	1.1986e+005
Region 5	Clay	34,40,9,19,18,17,16,15,14,39,38,37,36,35	595.29

Current Slip Surface

Slip Surface: 409
 F of S: 1.50
 Volume: 8,922.7997 ft³
 Weight: 950,631.04 lbs
 Resisting Moment: 89,120,255 lbs-ft
 Activating Moment: 59,457,999 lbs-ft
 F of S Rank (Analysis): 1 of 1,296 slip surfaces
 F of S Rank (Query): 1 of 10 slip surfaces
 Exit: (-62.248402, 1,813.043) ft
 Entry: (236.00001, 1,861.3415) ft
 Radius: 253.94132 ft
 Center: (54.245628, 2,038.6873) ft

Slip Slices

	X (ft)	Y (ft)	PWP (psf)	Base Normal Stress (psf)	Frictional Strength (psf)	Cohesive Strength (psf)
Slice 1	-56.969911	1,810.4707	0	578.22517	375.50382	200
Slice 2	-46.412931	1,805.6186	0	1,471.1247	955.35957	200
Slice 3	-35.85595	1,801.3352	0	2,235.4162	1,451.6963	200
Slice 4	-25.298969	1,797.5899	0	2,888.2895	1,875.6771	200
Slice 5	-14.010239	1,794.1706	0	3,146.189	1,145.1191	0
Slice 6	-2.8	1,791.2938	0	3,514.9653	1,279.3427	0
Slice 7	7.6	1,789.1229	0	3,818.9909	1,389.999	0
Slice 8	18	1,787.4009	0	4,070.8519	1,481.6689	0
Slice 9	28.4	1,786.1187	0	4,273.0767	1,555.2727	0
Slice 10	38.8	1,785.2697	0	4,427.7433	1,611.5668	0
Slice 11	44.5	1,784.9335	0	4,498.9212	1,637.4734	0
Slice 12	50.676482	1,784.8345	0	4,550.2441	1,656.1534	0
Slice 13	62.029447	1,784.9288	0	4,614.7252	1,679.6226	0
Slice 14	73.779447	1,785.5717	0	4,667.1826	739.20911	150
Slice	85.926482	1,786.8043	0	4,647.8258	736.14329	150

15						
Slice 16	94	1,787.8852	0	4,607.0939	729.69198	150
Slice 17	97.885731	1,788.5312	0	4,572.2288	724.1699	150
Slice 18	105.21448	1,789.9756	0	4,465.3719	867.98037	150.075
Slice 19	116.10051	1,792.4584	0	4,298.8008	835.60222	150.075
Slice 20	126.83516	1,795.4046	0	4,113.5171	651.5171	150
Slice 21	137.41843	1,798.8183	0	3,860.2757	611.4076	150
Slice 22	148.25838	1,802.8651	0	3,408.9882	1,240.7702	0
Slice 23	159.35503	1,807.6006	0	3,039.5252	1,106.2967	0
Slice 24	170.45168	1,812.9808	0	2,619.5193	953.42707	0
Slice 25	180.25	1,818.2669	0	2,215.7282	806.4591	0
Slice 26	188.75	1,823.3511	0	1,836.3519	668.37741	0
Slice 27	198.39963	1,829.7309	0	1,625.7714	591.7324	0
Slice 28	208.33272	1,836.9181	0	1,197.8709	777.90643	200
Slice 29	217.39963	1,844.1829	0	837.51494	543.88856	200
Slice 30	226.46654	1,852.1717	0	429.58776	278.97755	200
Slice 31	233.5	1,858.8496	0	59.738781	38.794818	200

Section 32-32 Static SSA for Skyline Ranch.gsz

Section 32-32 Static SSA for Skyline Ranch.gsz Run By: Dr. Alexander Bykovtsev, Ph.D., P.E. 3/14/2016 7:10:28 PM

- Materials**
- TQs
 - QIs
 - Fill
 - Clay

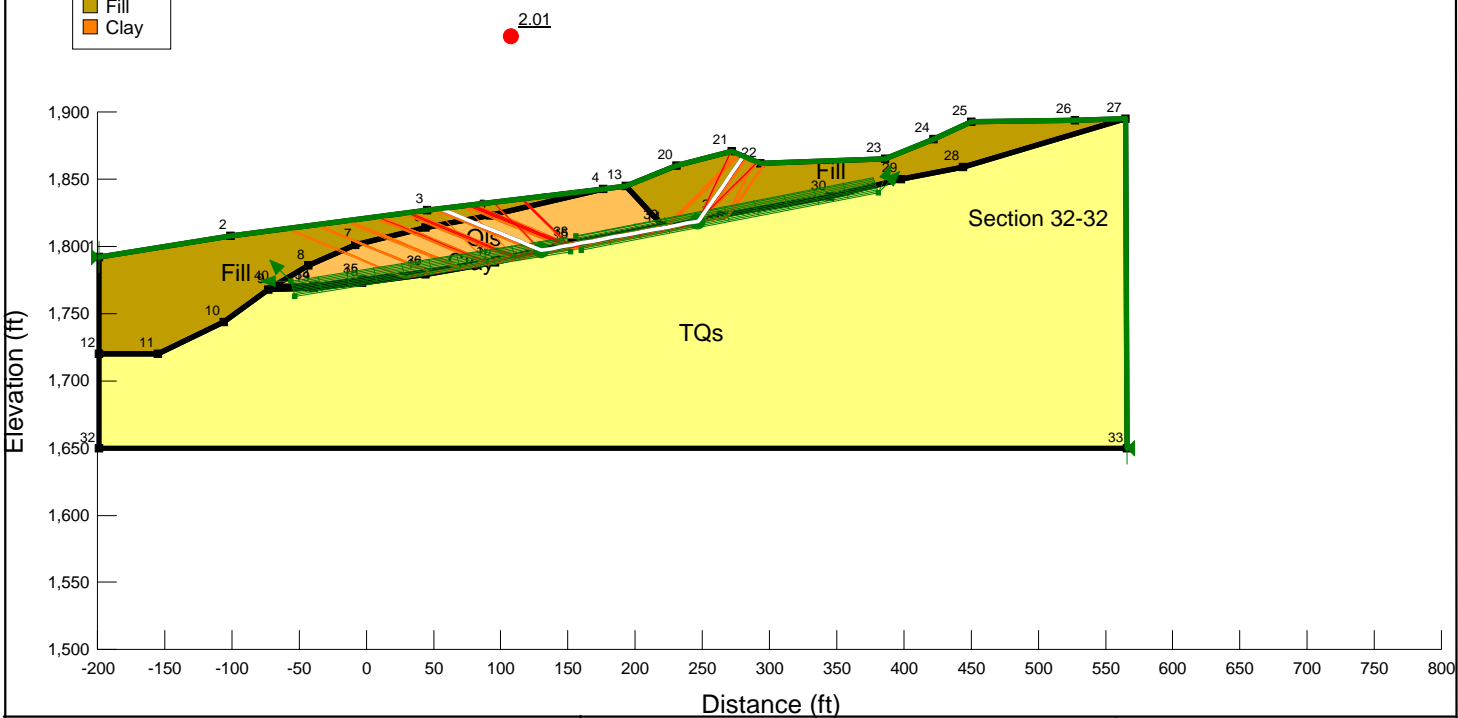

Name: TQs
 Model: Anisotropic Fn.
 Unit Weight: 120 pcf
 Cohesion': 225 psf
 Phi': 40 °
 Phi-Anisotropic Strength Fn.: 11° (Along Bedding 10-25°)
 C-Anisotropic Strength Fn.: 150 pcf (Along Bedding 10-25°)

Name: QIs
 Model: Mohr-Coulomb
 Unit Weight: 100 pcf
 Cohesion': 0 psf
 Phi': 20 °

Name: Fill
 Model: Mohr-Coulomb
 Unit Weight: 120 pcf
 Cohesion': 200 psf
 Phi': 33 °

Name: Clay
 Model: Mohr-Coulomb
 Unit Weight: 100 pcf
 Cohesion': 150 psf
 Phi': 9 °

LGC **LGC Valley, Inc**
 GEOTECHNICAL CONSULTING
 28532 Constellation Road, Valencia, CA 91355
 Phone 661-702-8474, Fax 661-702-8475

Skyline Ranch
 Development project, Tract 60922
 Los Angeles CA

Project No: **153035-01**
 Engineer: **BAS**
 Date: **March 2016**

2 - Translational

Report generated using GeoStudio 2012. Copyright © 1991-2016 GEO-SLOPE International Ltd.

File Information

File Version: 8.15
 Title: Static Slope Stability Analyses for Skyline Ranch Development project, Tract 60922, Los Angeles CA
 Comments: Run By: Dr. Alexander Bykovtsev, Ph.D., P.E.
 Last Edited By: Alexander Bykovtsec
 Revision Number: 142
 Date: 3/14/2016
 Time: 7:10:28 PM
 Tool Version: 8.15.5.11777
 File Name: Section 32-32 Static SSA for Skyline Ranch.gsz
 Directory: P:\FINAL PROJECTS\PARDEE\Skyline Ranch\SLOPE RESULTS\Section 32-32 results\
 Last Solved Date: 3/14/2016
 Last Solved Time: 7:10:40 PM

Project Settings

Length(L) Units: Feet
 Time(t) Units: Seconds
 Force(F) Units: Pounds
 Pressure(p) Units: psf
 Strength Units: psf
 Unit Weight of Water: 62.4 pcf
 View: 2D
 Element Thickness: 1

Analysis Settings

2 - Translational

Kind: SLOPE/W
 Method: Janbu
 Settings
 PWP Conditions Source: (none)
 Slip Surface
 Direction of movement: Right to Left
 Use Passive Mode: No
 Slip Surface Option: Block
 Critical slip surfaces saved: 10
 Resisting Side Maximum Convex Angle: 1 °
 Driving Side Maximum Convex Angle: 5 °
 Restrict Block Crossing: No
 Optimize Critical Slip Surface Location: No
 Tension Crack
 Tension Crack Option: (none)

file:///P:/FINAL%20PROJECTS/PARDEE/Skyline%20Ranch/SLOPE%20RESULTS/Sect... 3/14/2016

F of S Distribution
 F of S Calculation Option: Constant
 Advanced
 Number of Slices: 30
 F of S Tolerance: 0.01
 Minimum Slip Surface Depth: 0.1 ft

Materials

TQs

Model: Anisotropic Fn.
 Unit Weight: 120 pcf
 Cohesion': 225 psf
 Phi': 40 °
 Phi-Anisotropic Strength Fn.: 11° (Along Bedding 10-25°)
 C-Anisotropic Strength Fn.: 150 pcf (Along Bedding 10-25°)
 Phi-B: 0 °

QIs

Model: Mohr-Coulomb
 Unit Weight: 100 pcf
 Cohesion': 0 psf
 Phi': 20 °
 Phi-B: 0 °

Fill

Model: Mohr-Coulomb
 Unit Weight: 120 pcf
 Cohesion': 200 psf
 Phi': 33 °
 Phi-B: 0 °

Clay

Model: Mohr-Coulomb
 Unit Weight: 100 pcf
 Cohesion': 150 psf
 Phi': 9 °
 Phi-B: 0 °

Slip Surface Limits

Left Coordinate: (-199, 1,792) ft
 Right Coordinate: (566, 1,650) ft

Slip Surface Block

Left Grid
 Upper Left: (-56, 1,774) ft

file:///P:/FINAL%20PROJECTS/PARDEE/Skyline%20Ranch/SLOPE%20RESULTS/Sect... 3/14/2016

Lower Left: (-53, 1,763) ft
 Lower Right: (152, 1,796) ft
 X Increments: 10
 Y Increments: 10
 Starting Angle: 135 °
 Ending Angle: 180 °
 Angle Increments: 2

Right Grid

Upper Left: (156, 1,808) ft
 Lower Left: (160, 1,797) ft
 Lower Right: (381, 1,840) ft
 X Increments: 10
 Y Increments: 10
 Starting Angle: 45 °
 Ending Angle: 65 °
 Angle Increments: 2

Seismic Coefficients

Horz Seismic Coef.: 0
 Vert Seismic Coef.: 0

Anisotropic Strength Functions

11° (Along Bedding 10-25°)

Model: Spline Data Point Function
 Function: Modifier Factor vs. Inclination
 Curve Fit to Data: 100 %
 Segment Curvature: 0 %

Y-Intercept: 1

Data Points: Inclination (°), Modifier Factor

- Data Point: (-90, 1)
- Data Point: (9.9, 1)
- Data Point: (10, 0.275)
- Data Point: (25, 0.275)
- Data Point: (25.1, 1)

150 pcf (Along Bedding 10-25°)

Model: Spline Data Point Function
 Function: Modifier Factor vs. Inclination
 Curve Fit to Data: 100 %
 Segment Curvature: 0 %

Y-Intercept: 1

Data Points: Inclination (°), Modifier Factor

- Data Point: (-90, 1)
- Data Point: (9.9, 1)
- Data Point: (10, 0.667)
- Data Point: (25, 0.667)
- Data Point: (25.1, 1)

Points

	X (ft)	Y (ft)
Point 1	-199	1,792
Point 2	-101	1,808
Point 3	45	1,827
Point 4	176	1,843
Point 5	92	1,823
Point 6	44	1,814
Point 7	-8	1,801
Point 8	-43	1,786
Point 9	-73	1,768
Point 10	-106	1,744
Point 11	-155	1,720
Point 12	-199	1,720
Point 13	193	1,845
Point 14	222	1,814
Point 15	153	1,801
Point 16	96	1,788
Point 17	44	1,779
Point 18	-3	1,773
Point 19	-39	1,769
Point 20	231	1,860
Point 21	272	1,871
Point 22	293	1,862
Point 23	386	1,865
Point 24	422	1,880
Point 25	450	1,893
Point 26	527	1,894
Point 27	565	1,895
Point 28	444	1,859
Point 29	398	1,850
Point 30	345	1,837
Point 31	264	1,823
Point 32	-199	1,650
Point 33	566	1,650
Point 34	-39	1,771
Point 35	-3	1,775
Point 36	44	1,781
Point 37	96	1,790
Point 38	153	1,803
Point 39	220.129	1,816
Point 40	-69.6667	1,770

Regions

	Material	Points	Area (ft²)
Region 1	Fill	1,2,3,4,5,6,7,8,40,9,10,11,12	12,311
Region 2	Qls	4,5,6,7,8,40,34,35,36,37,38,39,13	8,037.7
Region 3	Fill	13,20,21,22,23,24,25,26,27,28,29,30,31,14,39	9,613
Region 4	TQs	12,32,33,27,28,29,30,31,14,15,16,17,18,19,9,10,11	1.1986e+005
Region 5	Clay	34,40,9,19,18,17,16,15,14,39,38,37,36,35	595.29

Current Slip Surface

Slip Surface: 58,226
 F of S: 2.01
 Volume: 7,017.266 ft³
 Weight: 766,942.76 lbs
 Resisting Force: 224,845.48 lbs
 Activating Force: 112,133.11 lbs
 F of S Rank (Analysis): 1 of 131,769 slip surfaces
 F of S Rank (Query): 1 of 150 slip surfaces
 Exit: (55.128474, 1,828.2371) ft
 Entry: (280.83853, 1,867.2121) ft
 Radius: 103.22832 ft
 Center: (162.93593, 1,876.9558) ft

Slip Slices

	X (ft)	Y (ft)	PWP (psf)	Base Normal Stress (psf)	Frictional Strength (psf)	Cohesive Strength (psf)
Slice 1	58.493995	1,826.843	0	298.11963	193.60115	200
Slice 2	65.225036	1,824.0549	0	798.65605	518.6533	200
Slice 3	71.956078	1,821.2668	0	1,299.1925	843.70546	200
Slice 4	79.491199	1,818.1457	0	1,641.5874	597.48896	0
Slice 5	87.8304	1,814.6915	0	2,113.531	769.26236	0
Slice 6	95.717463	1,811.4246	0	2,555.8182	930.24174	0
Slice 7	103.15239	1,808.3449	0	2,968.449	1,080.4271	0
Slice 8	110.58731	1,805.2653	0	3,381.0799	1,230.6124	0
Slice 9	118.02224	1,802.1856	0	3,793.7107	1,380.7978	0
Slice	125.45717	1,799.106	0	4,206.3416	1,530.9831	0

10						
Slice 11	129.73731	1,797.3331	0	4,280.3957	677.94808	150
Slice 12	134.08333	1,797.7982	0	4,032.6616	638.71085	150
Slice 13	141.65	1,799.1946	0	3,968.8212	628.59953	150
Slice 14	149.21667	1,800.5911	0	3,904.9808	618.4882	150
Slice 15	156.83333	1,801.9967	0	3,840.7185	608.31005	150
Slice 16	164.5	1,803.4116	0	3,776.0344	598.06509	150
Slice 17	172.16667	1,804.8265	0	3,711.3503	587.82013	150
Slice 18	180.25	1,806.3182	0	3,650.9842	578.25909	150
Slice 19	188.75	1,807.8869	0	3,594.9363	569.38198	150
Slice 20	196.39112	1,809.2971	0	3,735.0052	591.56671	150
Slice 21	203.17337	1,810.5487	0	4,071.191	644.81331	150
Slice 22	209.95563	1,811.8004	0	4,407.3768	698.0599	150
Slice 23	216.73788	1,813.0521	0	4,743.5625	751.3065	150
Slice 24	221.05526	1,813.8488	0	4,957.5681	785.20165	150
Slice 25	222.38045	1,814.0934	0	4,794.7604	3,113.7538	200
Slice 26	226.88969	1,814.9256	0	5,108.7652	993.04336	150.075
Slice 27	234.95	1,816.4131	0	5,249.6059	1,020.42	150.075
Slice 28	242.85	1,817.871	0	5,327.5959	1,035.5797	150.075
Slice 29	247.09422	1,819.0202	0	3,298.7701	2,767.9968	225
Slice 30	251.49037	1,825.2985	0	3,198.1739	2,076.9184	200
Slice 31	259.69422	1,837.0149	0	2,418.0563	1,570.3041	200
Slice 32	267.89807	1,848.7312	0	1,637.9386	1,063.6898	200
Slice 33	276.41926	1,860.9007	0	575.15923	373.51277	200

Section 32-32 Pseudostatic SSA for Skyline Ranch.gsz

Section 32-32 Pseudostatic SSA for Skyline Ranch.gsz Run By: Dr. Alexander Bykovtsev, Ph.D., P.E. 3/14/2016 7:18:27 PM

- Materials**
- TQs
 - Qls
 - Fill
 - Clay

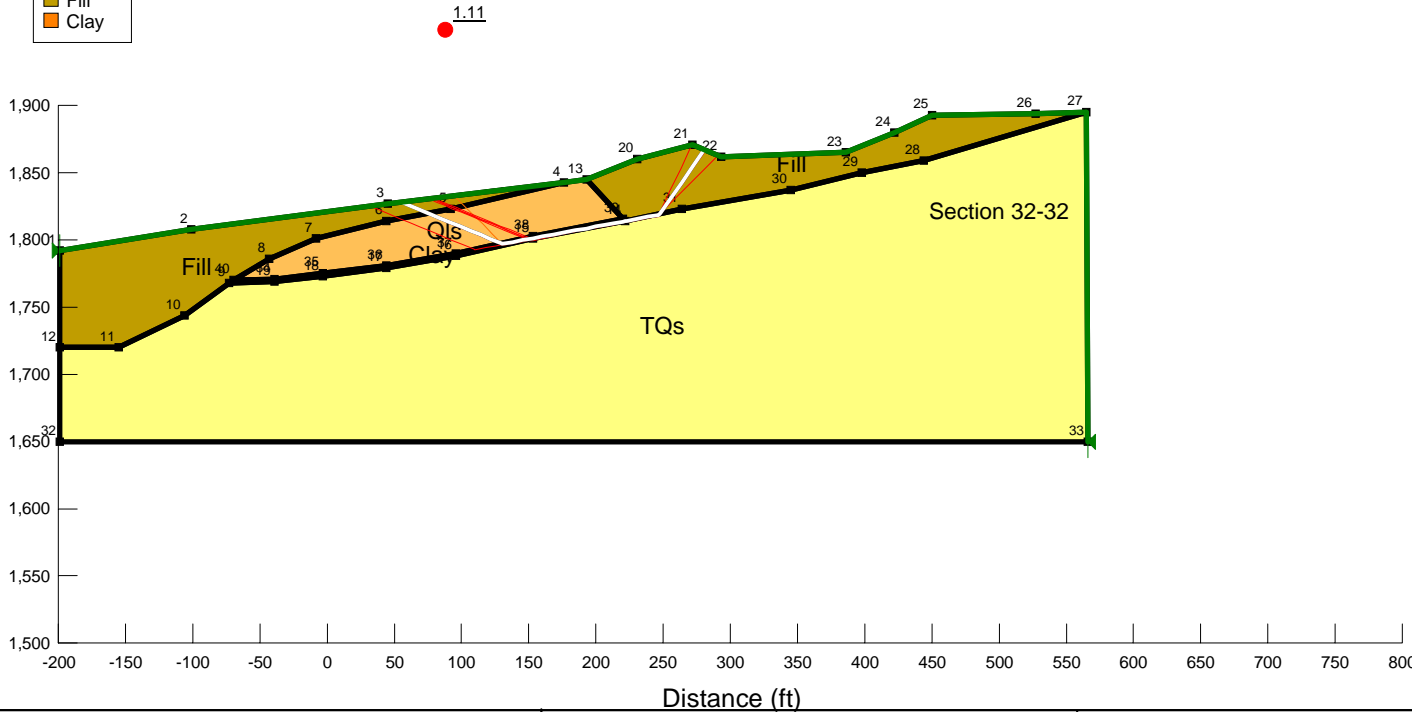

Name: TQs
 Model: Anisotropic Fn.
 Unit Weight: 120 pcf
 Cohesion: 225 psf
 Phi: 40 °
 Phi-Anisotropic Strength Fn.: 11° (Along Bedding 10-25°)
 C-Anisotropic Strength Fn.: 150 pcf (Along Bedding 10-25°)

Name: Qls
 Model: Mohr-Coulomb
 Unit Weight: 100 pcf
 Cohesion: 0 psf
 Phi: 20 °

Name: Fill
 Model: Mohr-Coulomb
 Unit Weight: 120 pcf
 Cohesion: 200 psf
 Phi: 33 °

Name: Clay
 Model: Mohr-Coulomb
 Unit Weight: 100 pcf
 Cohesion: 150 psf
 Phi: 9 °

LGC **LGC Valley, Inc**
 GEOTECHNICAL CONSULTING
 28532 Constellation Road, Valencia, CA 91355
 Phone 661-702-8474, Fax 661-702-8475

Skyline Ranch
 Development project, Tract 60922
 Los Angeles CA

Project No: **153035-01**
 Engineer: **BAS**
 Date: **March 2016**

2 - Translational

Report generated using GeoStudio 2012. Copyright © 1991-2016 GEO-SLOPE International Ltd.

File Information

File Version: 8.15
 Title: Static Slope Stability Analyses for Skyline Ranch Development project, Tract 60922, Los Angeles CA
 Comments: Run By: Dr. Alexander Bykovtsev, Ph.D., P.E.
 Last Edited By: Alexander Bykovtsec
 Revision Number: 145
 Date: 3/14/2016
 Time: 7:18:27 PM
 Tool Version: 8.15.5.11777
 File Name: Section 32-32 Pseudostatic SSA for Skyline Ranch.gsz
 Directory: P:\FINAL PROJECTS\PARDEE\Skyline Ranch\SLOPE RESULTS\Section 32-32 results\
 Last Solved Date: 3/14/2016
 Last Solved Time: 7:18:30 PM

Project Settings

Length(L) Units: Feet
 Time(t) Units: Seconds
 Force(F) Units: Pounds
 Pressure(p) Units: psf
 Strength Units: psf
 Unit Weight of Water: 62.4 pcf
 View: 2D
 Element Thickness: 1

Analysis Settings

2 - Translational

Kind: [SLOPE/W](#)
 Method: [Janbu](#)
 Settings
 PWP Conditions Source: [\(none\)](#)
 Initial Slip Surface Source: [Other GeoStudio Analysis](#)
 Slip Surface Other Analysis: ".\Section 32-32 Static SSA for Skyline Ranch.gsz" - 2 - Translational [(last)]
 Slip Surface
 Direction of movement: [Right to Left](#)
 Use Passive Mode: [No](#)
 Slip Surface Option: [Critical Slip Surfaces from Other](#)
 Critical slip surfaces saved: 10
 Resisting Side Maximum Convex Angle: 1 °
 Driving Side Maximum Convex Angle: 5 °
 Optimize Critical Slip Surface Location: [No](#)
 Tension Crack

file:///P:/FINAL%20PROJECTS/PARDEE/Skyline%20Ranch/SLOPE%20RESULTS/Sect... 3/14/2016

Tension Crack Option: [\(none\)](#)
 F of S Distribution
 F of S Calculation Option: [Constant](#)
 Advanced
 Number of Slices: 30
 F of S Tolerance: 0.01
 Minimum Slip Surface Depth: 0.1 ft

Materials

TQs

Model: [Anisotropic Fn.](#)
 Unit Weight: 120 pcf
 Cohesion': 225 psf
 Phi': 40 °
 Phi-Anisotropic Strength Fn.: 11° (Along Bedding 10-25°)
 C-Anisotropic Strength Fn.: 150 pcf (Along Bedding 10-25°)
 Phi-B: 0 °

QIs

Model: [Mohr-Coulomb](#)
 Unit Weight: 100 pcf
 Cohesion': 0 psf
 Phi': 20 °
 Phi-B: 0 °

Fill

Model: [Mohr-Coulomb](#)
 Unit Weight: 120 pcf
 Cohesion': 200 psf
 Phi': 33 °
 Phi-B: 0 °

Clay

Model: [Mohr-Coulomb](#)
 Unit Weight: 100 pcf
 Cohesion': 150 psf
 Phi': 9 °
 Phi-B: 0 °

Slip Surface Limits

Left Coordinate: (-199, 1,792) ft
 Right Coordinate: (566, 1,650) ft

Seismic Coefficients

Horz Seismic Coef.: 0.15

file:///P:/FINAL%20PROJECTS/PARDEE/Skyline%20Ranch/SLOPE%20RESULTS/Sect... 3/14/2016

Vert Seismic Coef.: 0

Anisotropic Strength Functions

11° (Along Bedding 10-25°)

Model: Spline Data Point Function

Function: Modifier Factor vs. Inclination

Curve Fit to Data: 100 %

Segment Curvature: 0 %

Y-Intercept: 1

Data Points: Inclination (°), Modifier Factor

Data Point: (-90, 1)

Data Point: (9.9, 1)

Data Point: (10, 0.275)

Data Point: (25, 0.275)

Data Point: (25.1, 1)

150 pcf (Along Bedding 10-25°)

Model: Spline Data Point Function

Function: Modifier Factor vs. Inclination

Curve Fit to Data: 100 %

Segment Curvature: 0 %

Y-Intercept: 1

Data Points: Inclination (°), Modifier Factor

Data Point: (-90, 1)

Data Point: (9.9, 1)

Data Point: (10, 0.667)

Data Point: (25, 0.667)

Data Point: (25.1, 1)

Points

	X (ft)	Y (ft)
Point 1	-199	1,792
Point 2	-101	1,808
Point 3	45	1,827
Point 4	176	1,843
Point 5	92	1,823
Point 6	44	1,814
Point 7	-8	1,801
Point 8	-43	1,786
Point 9	-73	1,768
Point 10	-106	1,744
Point 11	-155	1,720
Point 12	-199	1,720
Point 13	193	1,845

Point 14	222	1,814
Point 15	153	1,801
Point 16	96	1,788
Point 17	44	1,779
Point 18	-3	1,773
Point 19	-39	1,769
Point 20	231	1,860
Point 21	272	1,871
Point 22	293	1,862
Point 23	386	1,865
Point 24	422	1,880
Point 25	450	1,893
Point 26	527	1,894
Point 27	565	1,895
Point 28	444	1,859
Point 29	398	1,850
Point 30	345	1,837
Point 31	264	1,823
Point 32	-199	1,650
Point 33	566	1,650
Point 34	-39	1,771
Point 35	-3	1,775
Point 36	44	1,781
Point 37	96	1,790
Point 38	153	1,803
Point 39	220.129	1,816
Point 40	-69.6667	1,770

Regions

	Material	Points	Area (ft ²)
Region 1	Fill	1,2,3,4,5,6,7,8,40,9,10,11,12	12,311
Region 2	Qls	4,5,6,7,8,40,34,35,36,37,38,39,13	8,037.7
Region 3	Fill	13,20,21,22,23,24,25,26,27,28,29,30,31,14,39	9,613
Region 4	TQs	12,32,33,27,28,29,30,31,14,15,16,17,18,19,9,10,11	1.1986e+005
Region 5	Clay	34,40,9,19,18,17,16,15,14,39,38,37,36,35	595.29

Current Slip Surface

Slip Surface: 1

F of S: 1.11

Volume: 7,017.266 ft³

Weight: 766,942.76 lbs

Resisting Force: 219,345.96 lbs

Activating Force: 197,437.04 lbs
 F of S Rank (Analysis): 1 of 10 slip surfaces
 F of S Rank (Query): 1 of 10 slip surfaces
 Exit: (55.128474, 1,828.2371) ft
 Entry: (280.83853, 1,867.2121) ft
 Radius: 103.22832 ft
 Center: (162.93593, 1,876.9558) ft

Slip Slices

	X (ft)	Y (ft)	PWP (psf)	Base Normal Stress (psf)	Frictional Strength (psf)	Cohesive Strength (psf)
Slice 1	58.493995	1,826.843	0	384.74201	249.85438	200
Slice 2	65.225036	1,824.0549	0	956.81481	621.3628	200
Slice 3	71.956078	1,821.2668	0	1,528.8874	992.87105	200
Slice 4	79.491199	1,818.1457	0	1,756.8443	639.43901	0
Slice 5	87.8304	1,814.6915	0	2,261.9234	823.27279	0
Slice 6	95.717463	1,811.4246	0	2,735.2638	995.5546	0
Slice 7	103.15239	1,808.3449	0	3,176.8657	1,156.2845	0
Slice 8	110.58731	1,805.2653	0	3,618.4676	1,317.0145	0
Slice 9	118.02224	1,802.1856	0	4,060.0695	1,477.7444	0
Slice 10	125.45717	1,799.106	0	4,501.6714	1,638.4744	0
Slice 11	129.73731	1,797.3331	0	4,427.065	701.17821	150
Slice 12	134.08333	1,797.7982	0	3,975.6012	629.67337	150
Slice 13	141.65	1,799.1946	0	3,912.4922	619.67789	150
Slice 14	149.21667	1,800.5911	0	3,849.3834	609.68244	150
Slice 15	156.83333	1,801.9967	0	3,785.8574	599.6209	150
Slice 16	164.5	1,803.4116	0	3,721.9145	589.49335	150
Slice 17	172.16667	1,804.8265	0	3,657.9715	579.36577	150
Slice 18	180.25	1,806.3182	0	3,598.2973	569.9143	150
Slice						

19	188.75	1,807.8869	0	3,542.8915	561.13889	150
Slice 20	196.39112	1,809.2971	0	3,681.3554	583.06942	150
Slice 21	203.17337	1,810.5487	0	4,013.6891	635.70591	150
Slice 22	209.95563	1,811.8004	0	4,346.0226	688.34236	150
Slice 23	216.73788	1,813.0521	0	4,678.3562	740.97882	150
Slice 24	221.05526	1,813.8488	0	4,889.9094	774.48557	150
Slice 25	222.38045	1,814.0934	0	4,572.7126	2,969.5543	200
Slice 26	226.88969	1,814.9256	0	5,026.5448	977.06132	150.075
Slice 27	234.95	1,816.4131	0	5,165.4164	1,004.0552	150.075
Slice 28	242.85	1,817.871	0	5,242.316	1,019.003	150.075
Slice 29	247.09422	1,819.0202	0	2,472.4263	2,074.612	225
Slice 30	251.49037	1,825.2985	0	2,485.8764	1,614.347	200
Slice 31	259.69422	1,837.0149	0	1,864.2451	1,210.6549	200
Slice 32	267.89807	1,848.7312	0	1,242.6135	806.96266	200
Slice 33	276.41927	1,860.9007	0	395.74496	256.99978	200

Section 34-34 Static Circular SSA for Skyline Ranch.gsz

Section 34-34 Static Circular SSA for Skyline Ranch.gsz Run By: Dr. Alexander Bykovtsev, Ph.D., P.E. 3/14/2016 6:22:47 PM

- Materials**
- TQs
 - Qls
 - Fill
 - Clay
 - Tmc

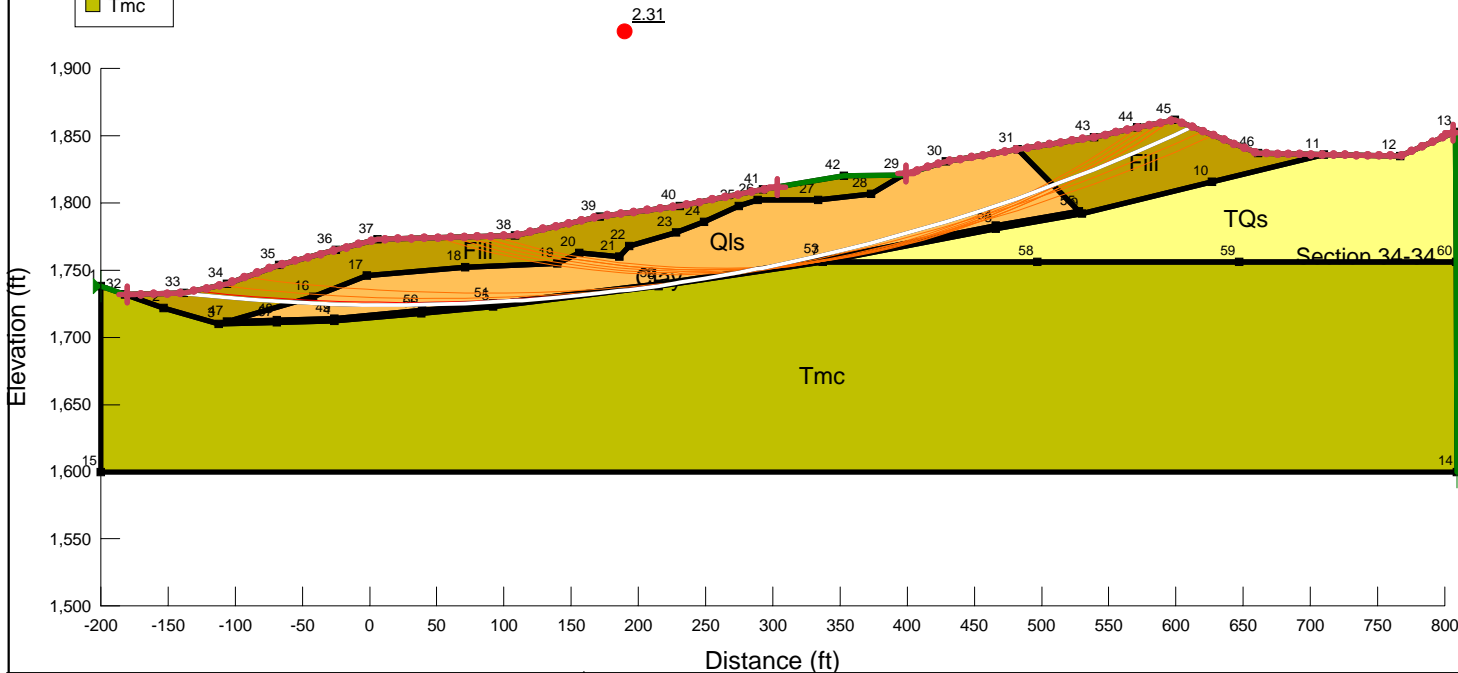

- Name: TQs
Model: Anisotropic Fn.
Unit Weight: 120 pcf
Cohesion: 225 psf
Phi: 40 °
Phi-Anisotropic Strength Fn.: 11 °(TQs Along Bedding 10 °-25 °)
C-Anisotropic Strength Fn.: 150 pcf (TQs Along Bedding 10-25°)
- Name: Qls
Model: Mohr-Coulomb
Unit Weight: 100 pcf
Cohesion: 0 psf
Phi: 20 °
- Name: Fill
Model: Mohr-Coulomb
Unit Weight: 120 pcf
Cohesion: 200 psf
Phi: 33 °
- Name: Clay
Model: Mohr-Coulomb
Unit Weight: 100 pcf
Cohesion: 150 psf
Phi: 9 °
- Name: Tmc
Model: Anisotropic Fn.
Unit Weight: 120 pcf
Cohesion: 200 psf
Phi: 40 °
Phi-Anisotropic Strength Fn.: 12° (Tmc Along Bedding 10-25°)
C-Anisotropic Strength Fn.: 150 pcf (Tmc Along Bedding 10-25°)

LGC Valley, Inc
GEOTECHNICAL CONSULTING
 28532 Constellation Road, Valencia, CA 91355
 Phone 661-702-8474, Fax 661-702-8475

Skyline Ranch
Development project, Tract 60922
Los Angeles CA

Project No: **153035-01**
 Engineer: **BAS**
 Date: **March 2016**

1 - Circular

Report generated using GeoStudio 2012. Copyright © 1991-2016 GEO-SLOPE International Ltd.

File Information

File Version: 8.15
 Title: Static Slope Stability Analyses for Skyline Ranch Development project, Tract 60922, Los Angeles CA
 Comments: Run By: Dr. Alexander Bykovtsev, Ph.D., P.E.
 Last Edited By: Alexander Bykovtsec
 Revision Number: 164
 Date: 3/14/2016
 Time: 6:22:47 PM
 Tool Version: 8.15.5.11777
 File Name: Section 34-34 Static Circular SSA for Skyline Ranch.gsz
 Directory: P:\FINAL PROJECTS\PARDEE\Skyline Ranch\SLOPE RESULTS\Section 34-34 results\

Project Settings

Length(L) Units: Feet
 Time(t) Units: Seconds
 Force(F) Units: Pounds
 Pressure(p) Units: psf
 Strength Units: psf
 Unit Weight of Water: 62.4 pcf
 View: 2D
 Element Thickness: 1

Analysis Settings

1 - Circular

Kind: SLOPE/W
 Method: Bishop
 Settings
 PWP Conditions Source: (none)
 Slip Surface
 Direction of movement: Right to Left
 Use Passive Mode: No
 Slip Surface Option: Entry and Exit
 Critical slip surfaces saved: 10
 Resisting Side Maximum Convex Angle: 1 °
 Driving Side Maximum Convex Angle: 5 °
 Optimize Critical Slip Surface Location: No
 Tension Crack
 Tension Crack Option: (none)
 F of S Distribution
 F of S Calculation Option: Constant
 Advanced
 Number of Slices: 30
 F of S Tolerance: 0.01
 Minimum Slip Surface Depth: 0.1 ft

Materials

file:///P:/FINAL%20PROJECTS/PARDEE/Skyline%20Ranch/SLOPE%20RESULTS/Sect... 3/14/2016

TQs

Model: Anisotropic Fn.
 Unit Weight: 120 pcf
 Cohesion': 225 psf
 Phi': 40 °
 Phi-Anisotropic Strength Fn.: 11 °(TQs Along Bedding 10 °-25 °)
 C-Anisotropic Strength Fn.: 150 pcf (TQs Along Bedding 10-25°)
 Phi-B: 0 °

QIs

Model: Mohr-Coulomb
 Unit Weight: 100 pcf
 Cohesion': 0 psf
 Phi': 20 °
 Phi-B: 0 °

Fill

Model: Mohr-Coulomb
 Unit Weight: 120 pcf
 Cohesion': 200 psf
 Phi': 33 °
 Phi-B: 0 °

Clay

Model: Mohr-Coulomb
 Unit Weight: 100 pcf
 Cohesion': 150 psf
 Phi': 9 °
 Phi-B: 0 °

Tmc

Model: Anisotropic Fn.
 Unit Weight: 120 pcf
 Cohesion': 200 psf
 Phi': 40 °
 Phi-Anisotropic Strength Fn.: 12° (Tmc Along Bedding 10-25°)
 C-Anisotropic Strength Fn.: 150 pcf (Tmc Along Bedding 10-25°)
 Phi-B: 0 °

Slip Surface Entry and Exit

Left Projection: Range
 Left-Zone Left Coordinate: (-180.0022, 1,731.9235) ft
 Left-Zone Right Coordinate: (303.4238, 1,811.7373) ft
 Left-Zone Increment: 50
 Right Projection: Range
 Right-Zone Left Coordinate: (399.3113, 1,821.7223) ft
 Right-Zone Right Coordinate: (806.1524, 1,852.1889) ft
 Right-Zone Increment: 50
 Radius Increments: 8

Slip Surface Limits

Left Coordinate: (-200, 1,738) ft
 Right Coordinate: (809, 1,600) ft

file:///P:/FINAL%20PROJECTS/PARDEE/Skyline%20Ranch/SLOPE%20RESULTS/Sect... 3/14/2016

Seismic Coefficients

Horz Seismic Coef.: 0
 Vert Seismic Coef.: 0

Anisotropic Strength Functions

12° (Tmc Along Bedding 10-25°)

Model: Spline Data Point Function
 Function: Modifier Factor vs. Inclination
 Curve Fit to Data: 100 %
 Segment Curvature: 0 %
 Y-Intercept: 1
 Data Points: Inclination (*), Modifier Factor
 Data Point: (-90, 1)
 Data Point: (9.9, 1)
 Data Point: (10, 0.3)
 Data Point: (25, 0.3)
 Data Point: (25.1, 1)

150 pcf (Tmc Along Bedding 10-25°)

Model: Spline Data Point Function
 Function: Modifier Factor vs. Inclination
 Curve Fit to Data: 100 %
 Segment Curvature: 0 %
 Y-Intercept: 1
 Data Points: Inclination (*), Modifier Factor
 Data Point: (-90, 1)
 Data Point: (9.9, 1)
 Data Point: (10, 0.75)
 Data Point: (25, 0.75)
 Data Point: (25.1, 1)

11°(TQs Along Bedding 10°-25°)

Model: Spline Data Point Function
 Function: Modifier Factor vs. Inclination
 Curve Fit to Data: 100 %
 Segment Curvature: 0 %
 Y-Intercept: 1
 Data Points: Inclination (*), Modifier Factor
 Data Point: (-90, 1)
 Data Point: (9.9, 1)
 Data Point: (10, 0.275)
 Data Point: (25, 0.275)
 Data Point: (25.1, 1)

150 pcf (TQs Along Bedding 10-25°)

Model: Spline Data Point Function
 Function: Modifier Factor vs. Inclination
 Curve Fit to Data: 100 %
 Segment Curvature: 0 %
 Y-Intercept: 1
 Data Points: Inclination (*), Modifier Factor
 Data Point: (-90, 1)
 Data Point: (9.9, 1)

Data Point: (10, 0.667)
 Data Point: (25, 0.667)
 Data Point: (25.1, 1)

Points

	X (ft)	Y (ft)
Point 1	-200	1,738
Point 2	-153	1,722
Point 3	-112	1,710
Point 4	-26	1,712
Point 5	92	1,723
Point 6	215	1,738
Point 7	337	1,756
Point 8	466	1,781
Point 9	530	1,792
Point 10	627	1,816
Point 11	710	1,836
Point 12	767	1,835
Point 13	808	1,853
Point 14	809	1,600
Point 15	-200	1,600
Point 16	-42	1,730
Point 17	-2	1,746
Point 18	71	1,752
Point 19	140	1,755
Point 20	156	1,763
Point 21	186	1,760
Point 22	193	1,768
Point 23	228	1,778
Point 24	249	1,786
Point 25	275	1,798
Point 26	289	1,802
Point 27	334	1,802
Point 28	373	1,807
Point 29	397	1,821
Point 30	429	1,831
Point 31	482	1,840
Point 32	-182	1,731.8723
Point 33	-138	1,733
Point 34	-106	1,740
Point 35	-67	1,754
Point 36	-25	1,765
Point 37	6	1,773
Point 38	108	1,776
Point 39	171	1,790
Point 40	231	1,798
Point 41	293	1,810
Point 42	353	1,820
Point 43	539	1,849
Point 44	571	1,856

Point 45	599	1,862
Point 46	661	1,837
Point 47	-106	1,711.7143
Point 48	-69	1,713
Point 49	-26	1,714
Point 50	39	1,720
Point 51	92	1,725
Point 52	215	1,740
Point 53	337	1,758
Point 54	466	1,783
Point 55	528	1,794
Point 56	38.3636	1,718
Point 57	-69	1,711
Point 58	497	1,756
Point 59	647	1,756
Point 60	808.3834	1,756

Regions

	Material	Points	Area (ft ²)
Region 1	TQs	13,12,11,10,9,8,7,58,59,60	22,189
Region 2	Qls	31,30,29,28,27,26,25,24,23,22,21,20,19,18,17,16,47,48,49,50,51,52,53,54,55	21,534
Region 3	Fill	32,33,34,35,36,37,38,39,40,41,42,29,28,27,26,25,24,23,22,21,20,19,18,17,16,47,3,2	11,851
Region 4	Fill	31,43,44,45,46,11,10,9,55	7,412
Region 5	Clay	47,3,57,4,56,5,6,7,8,9,55,54,53,52,51,50,49,48	1,274.4
Region 6	Tmc	7,6,5,56,4,57,3,2,32,1,15,14,60,59,58	1.4185e+005

Section 34-34 Pseudostatic Circular SSA for Skyline Ranch.gsz

Section 34-34 Pseudostatic Circular SSA for Skyline Ranch.gsz Run By: Dr. Alexander Bykovtsev, Ph.D., P.E. 3/14/2016 6:31:32 PM

- Materials
- TQs
 - Qls
 - Fill
 - Clay
 - Tmc

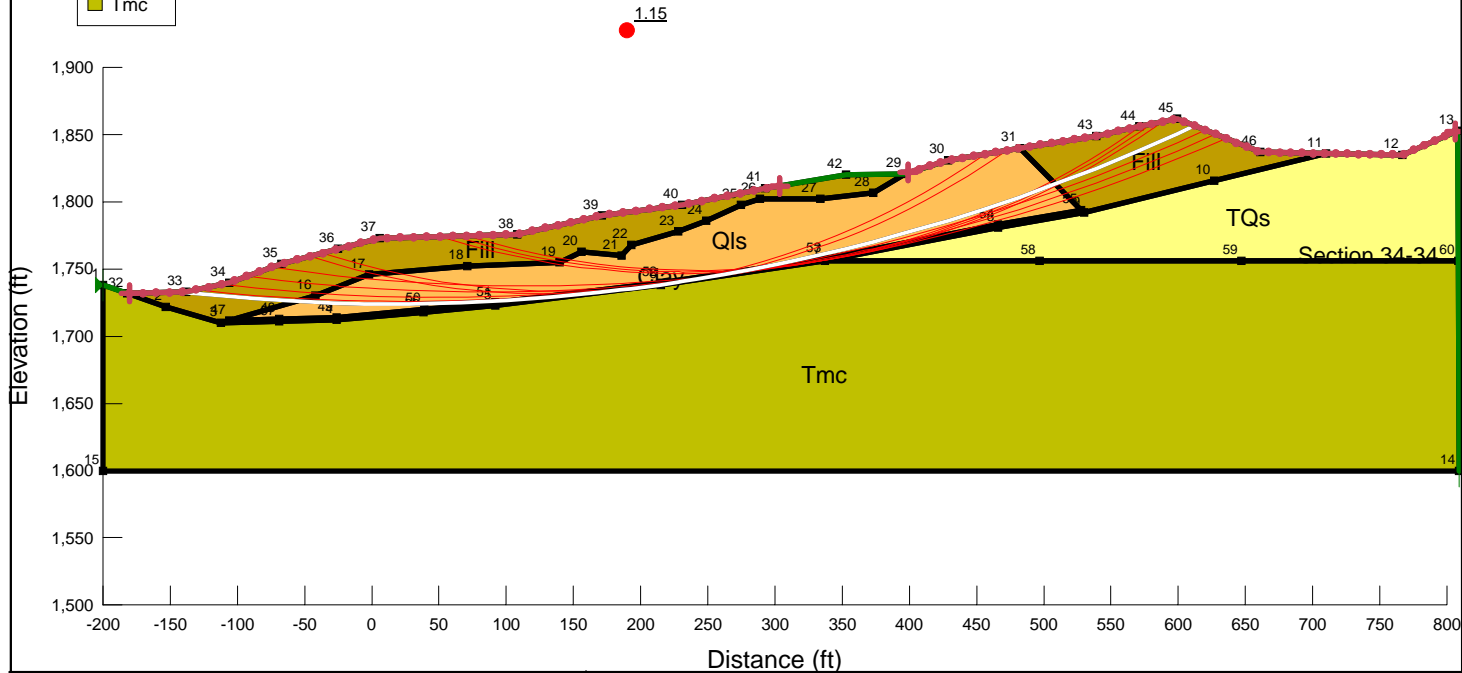

Name: TQs
 Model: Anisotropic Fn.
 Unit Weight: 120 pcf
 Cohesion: 225 psf
 Phi: 40 °
 Phi-Anisotropic Strength Fn.: 11 °(TQs Along Bedding 10 °-25 °)
 C-Anisotropic Strength Fn.: 150 pcf (TQs Along Bedding 10-25°)

Name: Qls
 Model: Mohr-Coulomb
 Unit Weight: 100 pcf
 Cohesion: 0 psf
 Phi: 20 °

Name: Fill
 Model: Mohr-Coulomb
 Unit Weight: 120 pcf
 Cohesion: 200 psf
 Phi: 33 °

Name: Clay
 Model: Mohr-Coulomb
 Unit Weight: 100 pcf
 Cohesion: 150 psf
 Phi: 9 °

Name: Tmc
 Model: Anisotropic Fn.
 Unit Weight: 120 pcf
 Cohesion: 200 psf
 Phi: 40 °
 Phi-Anisotropic Strength Fn.: 12° (Tmc Along Bedding 10-25°)
 C-Anisotropic Strength Fn.: 150 pcf (Tmc Along Bedding 10-25°)

LGC **LGC Valley, Inc**
 GEOTECHNICAL CONSULTING
 28532 Constellation Road, Valencia, CA 91355
 Phone 661-702-8474, Fax 661-702-8475

Skyline Ranch
 Development project, Tract 60922
 Los Angeles CA

Project No: **153035-01**
 Engineer: **BAS**
 Date: **March 2016**

1 - Circular

Report generated using GeoStudio 2012. Copyright © 1991-2016 GEO-SLOPE International Ltd.

File Information

File Version: 8.15
 Title: Static Slope Stability Analyses for Skyline Ranch Development project, Tract 60922, Los Angeles CA
 Comments: Run By: Dr. Alexander Bykovtsev, Ph.D., P.E.
 Last Edited By: Alexander Bykovtsec
 Revision Number: 166
 Date: 3/14/2016
 Time: 6:31:32 PM
 Tool Version: 8.15.5.11777
 File Name: Section 34-34 Pseudostatic Circular SSA for Skyline Ranch.gsz
 Directory: P:\FINAL PROJECTS\PARDEE\Skyline Ranch\SLOPE RESULTS\Section 34-34 results\
 Last Solved Date: 3/14/2016
 Last Solved Time: 6:31:38 PM

Project Settings

Length(L) Units: Feet
 Time(t) Units: Seconds
 Force(F) Units: Pounds
 Pressure(p) Units: psf
 Strength Units: psf
 Unit Weight of Water: 62.4 pcf
 View: 2D
 Element Thickness: 1

Analysis Settings

1 - Circular

Kind: SLOPE/W
 Method: Bishop
 Settings
 PWP Conditions Source: (none)
 Slip Surface
 Direction of movement: Right to Left
 Use Passive Mode: No
 Slip Surface Option: Entry and Exit
 Critical slip surfaces saved: 10
 Resisting Side Maximum Convex Angle: 1 °
 Driving Side Maximum Convex Angle: 5 °
 Optimize Critical Slip Surface Location: No
 Tension Crack
 Tension Crack Option: (none)
 F of S Distribution
 F of S Calculation Option: Constant
 Advanced
 Number of Slices: 30
 F of S Tolerance: 0.01
 Minimum Slip Surface Depth: 0.1 ft

file:///P:/FINAL%20PROJECTS/PARDEE/Skyline%20Ranch/SLOPE%20RESULTS/Sect... 3/14/2016

Materials

TQs

Model: Anisotropic Fn.
 Unit Weight: 120 pcf
 Cohesion: 225 psf
 Phi: 40 °
 Phi-Anisotropic Strength Fn.: 11 °(TQs Along Bedding 10 °-25 °)
 C-Anisotropic Strength Fn.: 150 pcf (TQs Along Bedding 10-25°)
 Phi-B: 0 °

QIs

Model: Mohr-Coulomb
 Unit Weight: 100 pcf
 Cohesion: 0 psf
 Phi: 20 °
 Phi-B: 0 °

Fill

Model: Mohr-Coulomb
 Unit Weight: 120 pcf
 Cohesion: 200 psf
 Phi: 33 °
 Phi-B: 0 °

Clay

Model: Mohr-Coulomb
 Unit Weight: 100 pcf
 Cohesion: 150 psf
 Phi: 9 °
 Phi-B: 0 °

Tmc

Model: Anisotropic Fn.
 Unit Weight: 120 pcf
 Cohesion: 200 psf
 Phi: 40 °
 Phi-Anisotropic Strength Fn.: 12° (Tmc Along Bedding 10-25°)
 C-Anisotropic Strength Fn.: 150 pcf (Tmc Along Bedding 10-25°)
 Phi-B: 0 °

Slip Surface Entry and Exit

Left Projection: Range
 Left-Zone Left Coordinate: (-180.0022, 1,731.9235) ft
 Left-Zone Right Coordinate: (303.4238, 1,811.7373) ft
 Left-Zone Increment: 50
 Right Projection: Range
 Right-Zone Left Coordinate: (399.3113, 1,821.7223) ft
 Right-Zone Right Coordinate: (806.1524, 1,852.1889) ft
 Right-Zone Increment: 50
 Radius Increments: 8

Slip Surface Limits

file:///P:/FINAL%20PROJECTS/PARDEE/Skyline%20Ranch/SLOPE%20RESULTS/Sect... 3/14/2016

Left Coordinate: (-200, 1,738) ft
 Right Coordinate: (809, 1,600) ft

Seismic Coefficients

Horz Seismic Coef.: 0.15
 Vert Seismic Coef.: 0

Anisotropic Strength Functions

12° (Tmc Along Bedding 10-25°)

Model: Spline Data Point Function
 Function: Modifier Factor vs. Inclination
 Curve Fit to Data: 100 %
 Segment Curvature: 0 %
 Y-Intercept: 1
 Data Points: Inclination (°), Modifier Factor
 Data Point: (-90, 1)
 Data Point: (9.9, 1)
 Data Point: (10, 0.3)
 Data Point: (25, 0.3)
 Data Point: (25.1, 1)

150 pcf (Tmc Along Bedding 10-25°)

Model: Spline Data Point Function
 Function: Modifier Factor vs. Inclination
 Curve Fit to Data: 100 %
 Segment Curvature: 0 %
 Y-Intercept: 1
 Data Points: Inclination (°), Modifier Factor
 Data Point: (-90, 1)
 Data Point: (9.9, 1)
 Data Point: (10, 0.75)
 Data Point: (25, 0.75)
 Data Point: (25.1, 1)

11° (TQs Along Bedding 10°-25°)

Model: Spline Data Point Function
 Function: Modifier Factor vs. Inclination
 Curve Fit to Data: 100 %
 Segment Curvature: 0 %
 Y-Intercept: 1
 Data Points: Inclination (°), Modifier Factor
 Data Point: (-90, 1)
 Data Point: (9.9, 1)
 Data Point: (10, 0.275)
 Data Point: (25, 0.275)
 Data Point: (25.1, 1)

150 pcf (TQs Along Bedding 10-25°)

Model: Spline Data Point Function
 Function: Modifier Factor vs. Inclination
 Curve Fit to Data: 100 %
 Segment Curvature: 0 %
 Y-Intercept: 1
 Data Points: Inclination (°), Modifier Factor

Data Point: (-90, 1)
 Data Point: (9.9, 1)
 Data Point: (10, 0.667)
 Data Point: (25, 0.667)
 Data Point: (25.1, 1)

Points

	X (ft)	Y (ft)
Point 1	-200	1,738
Point 2	-153	1,722
Point 3	-112	1,710
Point 4	-26	1,712
Point 5	92	1,723
Point 6	215	1,738
Point 7	337	1,756
Point 8	466	1,781
Point 9	530	1,792
Point 10	627	1,816
Point 11	710	1,836
Point 12	767	1,835
Point 13	808	1,853
Point 14	809	1,600
Point 15	-200	1,600
Point 16	-42	1,730
Point 17	-2	1,746
Point 18	71	1,752
Point 19	140	1,755
Point 20	156	1,763
Point 21	186	1,760
Point 22	193	1,768
Point 23	228	1,778
Point 24	249	1,786
Point 25	275	1,798
Point 26	289	1,802
Point 27	334	1,802
Point 28	373	1,807
Point 29	397	1,821
Point 30	429	1,831
Point 31	482	1,840
Point 32	-182	1,731.8723
Point 33	-138	1,733
Point 34	-106	1,740
Point 35	-67	1,754
Point 36	-25	1,765
Point 37	6	1,773
Point 38	108	1,776
Point 39	171	1,790
Point 40	231	1,798
Point 41	293	1,810
Point 42	353	1,820

31						
Slice 32	385	1,773.51	0	4,474.106	1,628.4414	0
Slice 33	413	1,781.4709	0	4,076.1201	1,483.5864	0
Slice 34	442.25	1,790.3816	0	3,897.4706	1,418.5633	0
Slice 35	468.75	1,799.0893	0	3,493.0032	1,271.3492	0
Slice 36	495.36643	1,808.4278	0	3,301.8007	1,201.7572	0
Slice 37	523.86643	1,819.1192	0	2,655.782	1,724.685	200
Slice 38	555	1,831.6004	0	1,976.7156	1,283.6941	200
Slice 39	585	1,844.4137	0	1,341.458	871.15303	200
Slice 40	605.59662	1,853.639	0	480.20556	311.84914	200

Section 34-34 Static SSA for Skyline Ranch.gsz

Section 34-34 Static SSA for Skyline Ranch.gsz Run By: Dr. Alexander Bykovtsev, Ph.D., P.E. 3/14/2016 5:56:57 PM

- Materials**
- TQs
 - Qls
 - Fill
 - Clay
 - Tmc

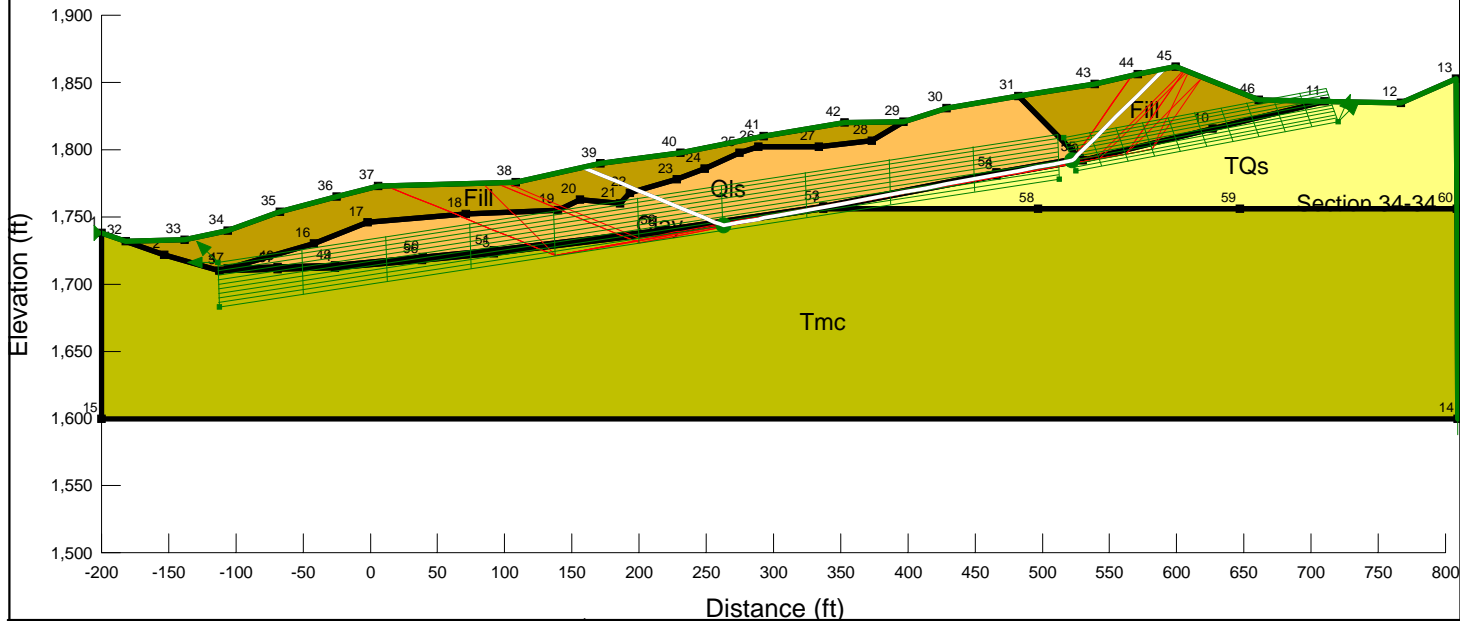

- Name: TQs
Model: Anisotropic Fn.
Unit Weight: 120 pcf
Cohesion: 225 psf
Phi: 40 °
Phi-Anisotropic Strength Fn.: 11 °(TQs Along Bedding 10 °-25 °)
C-Anisotropic Strength Fn.: 150 pcf (TQs Along Bedding 10-25°)
- Name: Qls
Model: Mohr-Coulomb
Unit Weight: 100 pcf
Cohesion: 0 psf
Phi: 20 °
- Name: Fill
Model: Mohr-Coulomb
Unit Weight: 120 pcf
Cohesion: 200 psf
Phi: 33 °
- Name: Clay
Model: Mohr-Coulomb
Unit Weight: 100 pcf
Cohesion: 150 psf
Phi: 9 °
- Name: Tmc
Model: Anisotropic Fn.
Unit Weight: 120 pcf
Cohesion: 200 psf
Phi: 40 °
Phi-Anisotropic Strength Fn.: 12° (Tmc Along Bedding 10-25°)
C-Anisotropic Strength Fn.: 150 pcf (Tmc Along Bedding 10-25°)

LGC **LGC Valley, Inc**
 GEOTECHNICAL CONSULTING
 28532 Constellation Road, Valencia, CA 91355
 Phone 661-702-8474, Fax 661-702-8475

Skyline Ranch
 Development project, Tract 60922
 Los Angeles CA

Project No: **153035-01**
 Engineer: **BAS**
 Date: **March 2016**

2 - Translational

Report generated using GeoStudio 2012. Copyright © 1991-2016 GEO-SLOPE International Ltd.

File Information

File Version: 8.15
 Title: Static Slope Stability Analyses for Skyline Ranch Development project, Tract 60922, Los Angeles CA
 Comments: Run By: Dr. Alexander Bykovtsev, Ph.D., P.E.
 Last Edited By: Alexander Bykovtsec
 Revision Number: 160
 Date: 3/14/2016
 Time: 5:56:57 PM
 Tool Version: 8.15.5.11777
 File Name: Section 34-34 Static SSA for Skyline Ranch.gsz
 Directory: P:\FINAL PROJECTS\PARDEE\Skyline Ranch\SLOPE RESULTS\Section 34-34 results\
 Last Solved Date: 3/14/2016
 Last Solved Time: 6:27:12 PM

Project Settings

Length(L) Units: Feet
 Time(t) Units: Seconds
 Force(F) Units: Pounds
 Pressure(p) Units: psf
 Strength Units: psf
 Unit Weight of Water: 62.4 pcf
 View: 2D
 Element Thickness: 1

Analysis Settings

2 - Translational

Kind: SLOPE/W
 Method: Janbu

Settings

PWP Conditions Source: (none)
 Slip Surface
 Direction of movement: Right to Left
 Use Passive Mode: No
 Slip Surface Option: Block
 Critical slip surfaces saved: 10
 Resisting Side Maximum Convex Angle: 1 °
 Driving Side Maximum Convex Angle: 5 °
 Restrict Block Crossing: No
 Optimize Critical Slip Surface Location: No
 Tension Crack
 Tension Crack Option: (none)
 F of S Distribution
 F of S Calculation Option: Constant
 Advanced
 Number of Slices: 30
 F of S Tolerance: 0.01
 Minimum Slip Surface Depth: 0.1 ft

file:///P:/FINAL%20PROJECTS/PARDEE/Skyline%20Ranch/SLOPE%20RESULTS/Sect... 3/14/2016

Materials

TQs

Model: Anisotropic Fn.
 Unit Weight: 120 pcf
 Cohesion: 225 psf
 Phi: 40 °
 Phi-Anisotropic Strength Fn.: 11 °(TQs Along Bedding 10 °-25 °)
 C-Anisotropic Strength Fn.: 150 pcf (TQs Along Bedding 10-25°)
 Phi-B: 0 °

QIs

Model: Mohr-Coulomb
 Unit Weight: 100 pcf
 Cohesion: 0 psf
 Phi: 20 °
 Phi-B: 0 °

Fill

Model: Mohr-Coulomb
 Unit Weight: 120 pcf
 Cohesion: 200 psf
 Phi: 33 °
 Phi-B: 0 °

Clay

Model: Mohr-Coulomb
 Unit Weight: 100 pcf
 Cohesion: 150 psf
 Phi: 9 °
 Phi-B: 0 °

Tmc

Model: Anisotropic Fn.
 Unit Weight: 120 pcf
 Cohesion: 200 psf
 Phi: 40 °
 Phi-Anisotropic Strength Fn.: 12° (Tmc Along Bedding 10-25°)
 C-Anisotropic Strength Fn.: 150 pcf (Tmc Along Bedding 10-25°)
 Phi-B: 0 °

Slip Surface Limits

Left Coordinate: (-200, 1,738) ft
 Right Coordinate: (809, 1,600) ft

Slip Surface Block

Left Grid
 Upper Left: (-113.3841, 1,716.1673) ft
 Lower Left: (-112.1694, 1,683.1928) ft
 Lower Right: (512.8207, 1,778.1756) ft
 X Increments: 10
 Y Increments: 10
 Starting Angle: 135 °

file:///P:/FINAL%20PROJECTS/PARDEE/Skyline%20Ranch/SLOPE%20RESULTS/Sect... 3/14/2016

Ending Angle: 180 °
 Angle Increments: 2
Right Grid
 Upper Left: (515.9588, 1,809.2079) ft
 Lower Left: (524.9799, 1,784.4482) ft
 Lower Right: (719.9715, 1,820.9519) ft
 X Increments: 10
 Y Increments: 10
 Starting Angle: 45 °
 Ending Angle: 65 °
 Angle Increments: 2

Seismic Coefficients

Horz Seismic Coef.: 0
 Vert Seismic Coef.: 0

Anisotropic Strength Functions

12° (Tmc Along Bedding 10-25°)

Model: Spline Data Point Function
 Function: Modifier Factor vs. Inclination
 Curve Fit to Data: 100 %
 Segment Curvature: 0 %
 Y-Intercept: 1
 Data Points: Inclination (°), Modifier Factor
 Data Point: (-90, 1)
 Data Point: (9.9, 1)
 Data Point: (10, 0.3)
 Data Point: (25, 0.3)
 Data Point: (25.1, 1)

150 pcf (Tmc Along Bedding 10-25°)

Model: Spline Data Point Function
 Function: Modifier Factor vs. Inclination
 Curve Fit to Data: 100 %
 Segment Curvature: 0 %
 Y-Intercept: 1
 Data Points: Inclination (°), Modifier Factor
 Data Point: (-90, 1)
 Data Point: (9.9, 1)
 Data Point: (10, 0.75)
 Data Point: (25, 0.75)
 Data Point: (25.1, 1)

11° (TQs Along Bedding 10 °-25 °)

Model: Spline Data Point Function
 Function: Modifier Factor vs. Inclination
 Curve Fit to Data: 100 %
 Segment Curvature: 0 %
 Y-Intercept: 1
 Data Points: Inclination (°), Modifier Factor
 Data Point: (-90, 1)
 Data Point: (9.9, 1)
 Data Point: (10, 0.275)
 Data Point: (25, 0.275)

Data Point: (25.1, 1)

150 pcf (TQs Along Bedding 10-25°)

Model: Spline Data Point Function
 Function: Modifier Factor vs. Inclination
 Curve Fit to Data: 100 %
 Segment Curvature: 0 %
 Y-Intercept: 1
 Data Points: Inclination (°), Modifier Factor
 Data Point: (-90, 1)
 Data Point: (9.9, 1)
 Data Point: (10, 0.667)
 Data Point: (25, 0.667)
 Data Point: (25.1, 1)

Points

	X (ft)	Y (ft)
Point 1	-200	1,738
Point 2	-153	1,722
Point 3	-112	1,710
Point 4	-26	1,712
Point 5	92	1,723
Point 6	215	1,738
Point 7	337	1,756
Point 8	466	1,781
Point 9	530	1,792
Point 10	627	1,816
Point 11	710	1,836
Point 12	767	1,835
Point 13	808	1,853
Point 14	809	1,600
Point 15	-200	1,600
Point 16	-42	1,730
Point 17	-2	1,746
Point 18	71	1,752
Point 19	140	1,755
Point 20	156	1,763
Point 21	186	1,760
Point 22	193	1,768
Point 23	228	1,778
Point 24	249	1,786
Point 25	275	1,798
Point 26	289	1,802
Point 27	334	1,802
Point 28	373	1,807
Point 29	397	1,821
Point 30	429	1,831
Point 31	482	1,840
Point 32	-182	1,731.8723
Point 33	-138	1,733
Point 34	-106	1,740

Point 35	-67	1,754
Point 36	-25	1,765
Point 37	6	1,773
Point 38	108	1,776
Point 39	171	1,790
Point 40	231	1,798
Point 41	293	1,810
Point 42	353	1,820
Point 43	539	1,849
Point 44	571	1,856
Point 45	599	1,862
Point 46	661	1,837
Point 47	-106	1,711.7143
Point 48	-69	1,713
Point 49	-26	1,714
Point 50	39	1,720
Point 51	92	1,725
Point 52	215	1,740
Point 53	337	1,758
Point 54	466	1,783
Point 55	528	1,794
Point 56	38.3636	1,718
Point 57	-69	1,711
Point 58	497	1,756
Point 59	647	1,756
Point 60	808.3834	1,756

Regions

	Material	Points	Area (ft²)
Region 1	TQs	13,12,11,10,9,8,7,58,59,60	22,189
Region 2	Qjs	31,30,29,28,27,26,25,24,23,22,21,20,19,18,17,16,47,48,49,50,51,52,53,54,55	21,534
Region 3	Fill	32,33,34,35,36,37,38,39,40,41,42,29,28,27,26,25,24,23,22,21,20,19,18,17,16,47,3,2	11,851
Region 4	Fill	31,43,44,45,46,11,10,9,55	7,412
Region 5	Clay	47,3,57,4,56,5,6,7,8,9,55,54,53,52,51,50,49,48	1,274.4
Region 6	Tmc	7,6,5,56,4,57,3,2,32,1,15,14,60,59,58	1.4185e+005

Current Slip Surface

Slip Surface: 18,976
 F of S: 2.03
 Volume: 19,868.061 ft³
 Weight: 2,106,112.2 lbs
 Resisting Force: 580,155.77 lbs
 Activating Force: 285,492.6 lbs
 F of S Rank (Analysis): 1 of 131,769 slip surfaces

F of S Rank (Query): 1 of 15 slip surfaces
 Exit: (157.5888, 1,787.0197) ft
 Entry: (590.59677, 1,860.1993) ft
 Radius: 189.22041 ft
 Center: (364.81712, 1,878.4942) ft

Slip Slices

	X (ft)	Y (ft)	PWP (psf)	Base Normal Stress (psf)	Frictional Strength (psf)	Cohesive Strength (psf)
Slice 1	164.2944	1,784.2422	0	637.4732	413.97993	200
Slice 2	178.05442	1,778.5426	0	1,762.2363	1,144.4096	200
Slice 3	192.16327	1,772.6985	0	2,830.9633	1,838.4491	200
Slice 4	206.41327	1,766.796	0	3,511.2869	1,278.0039	0
Slice 5	220.80442	1,760.835	0	4,315.1451	1,570.5844	0
Slice 6	229.5	1,757.2331	0	4,797.7743	1,746.2471	0
Slice 7	240	1,752.8839	0	5,432.9284	1,977.4242	0
Slice 8	252.68451	1,747.6298	0	6,207.9552	2,259.5109	0
Slice 9	258.14916	1,745.3663	0	6,283.2813	995.17399	150
Slice 10	261.31624	1,744.0544	0	7,579.9393	6,360.3242	200
Slice 11	268.85159	1,744.6263	0	6,165.4235	1,310.5012	150
Slice 12	282	1,747.0778	0	6,119.5675	1,300.7542	150
Slice 13	291	1,748.7558	0	6,113.9048	1,299.5506	150
Slice 14	297.87724	1,750.038	0	6,124.1259	1,301.7232	150
Slice 15	310.56586	1,752.4038	0	6,167.3856	976.81791	150
Slice 16	326.18862	1,755.3166	0	6,188.255	980.1233	150
Slice 17	335.5	1,757.0527	0	6,196.9024	981.49293	150
Slice 18	345	1,758.8239	0	6,185.5834	979.70016	150
Slice 19	363	1,762.18	0	5,993.8874	949.3385	150
Slice 20	379	1,765.1631	0	5,648.593	894.64924	150
Slice 21	391	1,767.4005	0	5,322.3324	842.97463	150
Slice 22	405	1,770.0108	0	5,258.5975	832.88003	150
Slice 23	421	1,772.9939	0	5,457.3885	864.36543	150
Slice 24	435.16667	1,775.6353	0	5,546.6724	878.5066	150
Slice 25	447.5	1,777.9348	0	5,526.4491	875.30355	150
Slice 26	459.83333	1,780.2343	0	5,506.2258	872.10049	150
Slice 27	474	1,782.8756	0	5,482.9964	868.42131	150

Slice 28	488.71226	1,785.6187	0	5,604.2002	887.61811	150
Slice 29	502.13678	1,788.1217	0	5,872.8433	930.167	150
Slice 30	515.56131	1,790.6246	0	6,141.4865	972.7159	150
Slice 31	522.94701	1,792.5495	0	5,812.1572	920.55526	150
Slice 32	524.90959	1,794.5121	0	5,273.882	1,919.5361	0
Slice 33	532.59937	1,802.2019	0	4,087.5481	2,654.4848	200
Slice 34	547	1,816.6025	0	3,029.4351	1,967.3381	200
Slice 35	563	1,832.6025	0	1,893.1461	1,229.4235	200
Slice 36	580.79838	1,850.4009	0	625.1631	405.98566	200

Section 34-34 Pseudostatic SSA for Skyline Ranch.gsz

Section 34-34 Pseudostatic SSA for Skyline Ranch.gsz Run By: Dr. Alexander Bykovtsev, Ph.D., P.E. 3/14/2016 6:48:09 PM

- Materials**
- TQs
 - Qls
 - Fill
 - Clay
 - Tmc

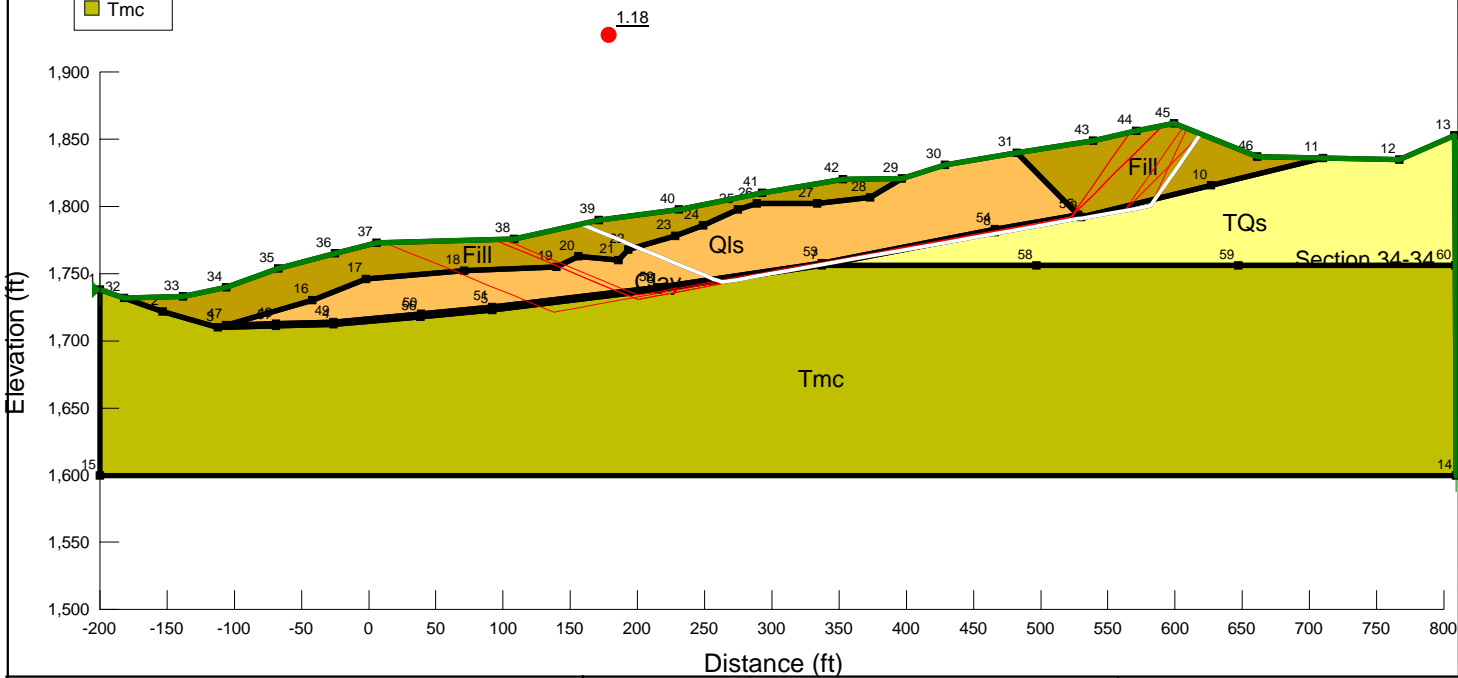

- Name: TQs**
 Model: Anisotropic Fn.
 Unit Weight: 120 pcf
 Cohesion: 225 psf
 Phi: 40 °
 Phi-Anisotropic Strength Fn.: 11 °(TQs Along Bedding 10 °-25 °)
 C-Anisotropic Strength Fn.: 150 pcf (TQs Along Bedding 10-25°)
- Name: Qls**
 Model: Mohr-Coulomb
 Unit Weight: 100 pcf
 Cohesion: 0 psf
 Phi: 20 °
- Name: Fill**
 Model: Mohr-Coulomb
 Unit Weight: 120 pcf
 Cohesion: 200 psf
 Phi: 33 °
- Name: Clay**
 Model: Mohr-Coulomb
 Unit Weight: 100 pcf
 Cohesion: 150 psf
 Phi: 9 °
- Name: Tmc**
 Model: Anisotropic Fn.
 Unit Weight: 120 pcf
 Cohesion: 200 psf
 Phi: 40 °
 Phi-Anisotropic Strength Fn.: 12° (Tmc Along Bedding 10-25°)
 C-Anisotropic Strength Fn.: 150 pcf (Tmc Along Bedding 10-25°)

	LGC Valley, Inc GEOTECHNICAL CONSULTING 28532 Constellation Road, Valencia, CA 91355 Phone 661-702-8474, Fax 661-702-8475	Skyline Ranch Development project, Tract 60922 Los Angeles CA	Project No: 153035-01 Engineer: BAS Date: March 2016
	Section 34-34		

2 - Translational

Report generated using GeoStudio 2012. Copyright © 1991-2016 GEO-SLOPE International Ltd.

File Information

File Version: 8.15
 Title: Static Slope Stability Analyses for Skyline Ranch Development project, Tract 60922, Los Angeles CA
 Comments: Run By: Dr. Alexander Bykovtsev, Ph.D., P.E.
 Last Edited By: Alexander Bykovtsec
 Revision Number: 169
 Date: 3/14/2016
 Time: 6:48:09 PM
 Tool Version: 8.15.5.11777
 File Name: Section 34-34 Pseudostatic SSA for Skyline Ranch.gsz
 Directory: P:\FINAL PROJECTS\PARDEE\Skyline Ranch\SLOPE RESULTS\Section 34-34 results\
 Last Solved Date: 3/14/2016
 Last Solved Time: 6:48:11 PM

Project Settings

Length(L) Units: Feet
 Time(t) Units: Seconds
 Force(F) Units: Pounds
 Pressure(p) Units: psf
 Strength Units: psf
 Unit Weight of Water: 62.4 pcf
 View: 2D
 Element Thickness: 1

Analysis Settings

2 - Translational

Kind: SLOPE/W
 Method: Spencer

Settings

PWP Conditions Source: (none)
 Initial Slip Surface Source: Other GeoStudio Analysis
 Slip Surface Other Analysis: ".\Section 34-34 Static SSA for Skyline Ranch.gsz" - 2 - Translational [(last)]

Slip Surface

Direction of movement: Right to Left
 Use Passive Mode: No
 Slip Surface Option: Critical Slip Surfaces from Other
 Critical slip surfaces saved: 10
 Resisting Side Maximum Convex Angle: 1 °
 Driving Side Maximum Convex Angle: 5 °
 Optimize Critical Slip Surface Location: No
 Tension Crack
 Tension Crack Option: (none)

F of S Distribution

F of S Calculation Option: Constant

Advanced

Number of Slices: 30
 F of S Tolerance: 0.001
 Minimum Slip Surface Depth: 0.1 ft

file:///P:/FINAL%20PROJECTS/PARDEE/Skyline%20Ranch/SLOPE%20RESULTS/Sect... 3/14/2016

Search Method: Root Finder
 Tolerable difference between starting and converged F of S: 3
 Maximum iterations to calculate converged lambda: 20
 Max Absolute Lambda: 2

Materials

TQs

Model: Anisotropic Fn.
 Unit Weight: 120 pcf
 Cohesion: 225 psf
 Phi: 40 °
 Phi-Anisotropic Strength Fn.: 11 °(TQs Along Bedding 10 °-25 °)
 C-Anisotropic Strength Fn.: 150 pcf (TQs Along Bedding 10-25°)
 Phi-B: 0 °

QIs

Model: Mohr-Coulomb
 Unit Weight: 100 pcf
 Cohesion: 0 psf
 Phi: 20 °
 Phi-B: 0 °

Fill

Model: Mohr-Coulomb
 Unit Weight: 120 pcf
 Cohesion: 200 psf
 Phi: 33 °
 Phi-B: 0 °

Clay

Model: Mohr-Coulomb
 Unit Weight: 100 pcf
 Cohesion: 150 psf
 Phi: 9 °
 Phi-B: 0 °

Tmc

Model: Anisotropic Fn.
 Unit Weight: 120 pcf
 Cohesion: 200 psf
 Phi: 40 °
 Phi-Anisotropic Strength Fn.: 12° (Tmc Along Bedding 10-25°)
 C-Anisotropic Strength Fn.: 150 pcf (Tmc Along Bedding 10-25°)
 Phi-B: 0 °

Slip Surface Limits

Left Coordinate: (-200, 1,738) ft
 Right Coordinate: (809, 1,600) ft

Seismic Coefficients

Horz Seismic Coef.: 0.15
 Vert Seismic Coef.: 0

file:///P:/FINAL%20PROJECTS/PARDEE/Skyline%20Ranch/SLOPE%20RESULTS/Sect... 3/14/2016

Anisotropic Strength Functions

12° (Tmc Along Bedding 10-25°)

Model: Spline Data Point Function
 Function: Modifier Factor vs. Inclination
 Curve Fit to Data: 100 %
 Segment Curvature: 0 %

Y-Intercept: 1

Data Points: Inclination (*), Modifier Factor

- Data Point: (-90, 1)
- Data Point: (9.9, 1)
- Data Point: (10, 0.3)
- Data Point: (25, 0.3)
- Data Point: (25.1, 1)

150 pcf (Tmc Along Bedding 10-25°)

Model: Spline Data Point Function
 Function: Modifier Factor vs. Inclination
 Curve Fit to Data: 100 %
 Segment Curvature: 0 %

Y-Intercept: 1

Data Points: Inclination (*), Modifier Factor

- Data Point: (-90, 1)
- Data Point: (9.9, 1)
- Data Point: (10, 0.75)
- Data Point: (25, 0.75)
- Data Point: (25.1, 1)

11° (TQs Along Bedding 10°-25°)

Model: Spline Data Point Function
 Function: Modifier Factor vs. Inclination
 Curve Fit to Data: 100 %
 Segment Curvature: 0 %

Y-Intercept: 1

Data Points: Inclination (*), Modifier Factor

- Data Point: (-90, 1)
- Data Point: (9.9, 1)
- Data Point: (10, 0.275)
- Data Point: (25, 0.275)
- Data Point: (25.1, 1)

150 pcf (TQs Along Bedding 10-25°)

Model: Spline Data Point Function
 Function: Modifier Factor vs. Inclination
 Curve Fit to Data: 100 %
 Segment Curvature: 0 %

Y-Intercept: 1

Data Points: Inclination (*), Modifier Factor

- Data Point: (-90, 1)
- Data Point: (9.9, 1)
- Data Point: (10, 0.667)
- Data Point: (25, 0.667)
- Data Point: (25.1, 1)

Points

	X (ft)	Y (ft)
Point 1	-200	1,738
Point 2	-153	1,722
Point 3	-112	1,710
Point 4	-26	1,712
Point 5	92	1,723
Point 6	215	1,738
Point 7	337	1,756
Point 8	466	1,781
Point 9	530	1,792
Point 10	627	1,816
Point 11	710	1,836
Point 12	767	1,835
Point 13	808	1,853
Point 14	809	1,600
Point 15	-200	1,600
Point 16	-42	1,730
Point 17	-2	1,746
Point 18	71	1,752
Point 19	140	1,755
Point 20	156	1,763
Point 21	186	1,760
Point 22	193	1,768
Point 23	228	1,778
Point 24	249	1,786
Point 25	275	1,798
Point 26	289	1,802
Point 27	334	1,802
Point 28	373	1,807
Point 29	397	1,821
Point 30	429	1,831
Point 31	482	1,840
Point 32	-182	1,731.8723
Point 33	-138	1,733
Point 34	-106	1,740
Point 35	-67	1,754
Point 36	-25	1,765
Point 37	6	1,773
Point 38	108	1,776
Point 39	171	1,790
Point 40	231	1,798
Point 41	293	1,810
Point 42	353	1,820
Point 43	539	1,849
Point 44	571	1,856
Point 45	599	1,862
Point 46	661	1,837

Point 47	-106	1,711.7143
Point 48	-69	1,713
Point 49	-26	1,714
Point 50	39	1,720
Point 51	92	1,725
Point 52	215	1,740
Point 53	337	1,758
Point 54	466	1,783
Point 55	528	1,794
Point 56	38.3636	1,718
Point 57	-69	1,711
Point 58	497	1,756
Point 59	647	1,756
Point 60	808.3834	1,756

Regions

Region	Material	Points	Area (ft²)
Region 1	TQs	13,12,11,10,9,8,7,58,59,60	22,189
Region 2	Qjs	31,30,29,28,27,26,25,24,23,22,21,20,19,18,17,16,47,48,49,50,51,52,53,54,55	21,534
Region 3	Fill	32,33,34,35,36,37,38,39,40,41,42,29,28,27,26,25,24,23,22,21,20,19,18,17,16,47,3,2	11,851
Region 4	Fill	31,43,44,45,46,11,10,9,55	7,412
Region 5	Clay	47,3,57,4,56,5,6,7,8,9,55,54,53,52,51,50,49,48	1,274.4
Region 6	Tmc	7,6,5,56,4,57,3,2,32,1,15,14,60,59,58	1.4185e+005

Current Slip Surface

Slip Surface: 4
 F of S: 1.18
 Volume: 22,880.08 ft³
 Weight: 2,464,111.4 lbs
 Resisting Moment: 1.0284906e+008 lbs-ft
 Activating Moment: 86,923,335 lbs-ft
 Resisting Force: 688,887.88 lbs
 Activating Force: 582,224.48 lbs
 F of S Rank (Analysis): 1 of 10 slip surfaces
 F of S Rank (Query): 1 of 10 slip surfaces
 Exit: (157.5888, 1,787.0197) ft
 Entry: (619.1507, 1,853.8747) ft
 Radius: 194.07119 ft
 Center: (381.10704, 1,870.5885) ft

Slip Slices

	X (ft)	Y (ft)	PWP (psf)	Base Normal Stress (psf)	Frictional Strength (psf)	Cohesive Strength (psf)
Slice 1	164.2944	1,784.2422	0	1,047.907	680.51874	200
Slice 2	178.05442	1,778.5426	0	2,695.7509	1,750.6411	200

Slice 3	192.16327	1,772.6985	0	4,261.4981	2,767.4492	200
Slice 4	206.41327	1,766.796	0	4,353.7437	1,584.6331	0
Slice 5	220.80442	1,760.835	0	5,350.4701	1,947.4119	0
Slice 6	229.5	1,757.2331	0	5,948.8962	2,165.2212	0
Slice 7	240	1,752.8839	0	6,736.4412	2,451.8641	0
Slice 8	252.68451	1,747.6298	0	7,697.4185	2,801.6312	0
Slice 9	258.14916	1,745.3663	0	7,146.1451	1,131.8382	150
Slice 10	261.31624	1,744.0544	0	12,962.851	10,877.123	200
Slice 11	268.85159	1,744.5762	0	5,925.6355	1,259.5327	150
Slice 12	282	1,746.9205	0	5,893.805	1,252.7669	150
Slice 13	291	1,748.5252	0	5,896.6499	1,253.3716	150
Slice 14	303.18414	1,750.6976	0	5,920.5055	1,258.4423	150
Slice 15	323.68414	1,754.3526	0	5,948.9415	942.21978	150
Slice 16	335.5	1,756.4594	0	5,969.3885	945.45825	150
Slice 17	345	1,758.1532	0	5,965.8792	944.90243	150
Slice 18	363	1,761.3625	0	5,797.2114	918.18809	150
Slice 19	378.44304	1,764.116	0	5,494.8265	870.29501	150
Slice 20	390.44304	1,766.2555	0	5,199.7517	1,010.7293	150.075
Slice 21	405	1,768.851	0	5,139.9996	999.11471	150.075
Slice 22	421	1,771.7037	0	5,346.2378	1,039.2034	150.075
Slice 23	438.25	1,774.7794	0	5,444.6804	1,058.3387	150.075
Slice 24	456.75	1,778.0779	0	5,435.3277	1,056.5207	150.075
Slice 25	474	1,781.1535	0	5,423.3141	1,054.1855	150.075
Slice 26	489.66667	1,783.9468	0	5,567.044	1,082.1237	150.075
Slice 27	505	1,786.6807	0	5,869.1789	1,140.8528	150.075
Slice 28	520.33333	1,789.4146	0	6,171.3137	1,199.5819	150.075
Slice 29	529	1,790.9598	0	6,342.085	1,232.7764	150.075
Slice 30	534.5	1,791.9404	0	6,351.4472	1,234.5963	150.075
Slice 31	547	1,794.1691	0	6,377.5625	1,239.6726	150.075
Slice 32	563	1,797.0219	0	6,450.4781	1,253.8459	150.075
Slice	576.33658	1,799.3998	0	6,508.5723	1,265.1383	150.075

33						
Slice 34	583.55076	1,803.0327	0	2,887.3957	2,422.8127	225
Slice 35	592.21418	1,815.4054	0	2,566.0884	1,666.4373	200
Slice 36	609.07535	1,839.4856	0	986.83337	640.85708	200

APPENDIX E

LGC VALLEY, INC.

General Earthwork and Grading Specifications For Rough Grading

1.0 General

1.1 Intent: These General Earthwork and Grading Specifications are for the grading and earthwork shown on the approved grading plan(s) and/or indicated in the geotechnical report(s). These Specifications are a part of the recommendations contained in the geotechnical report(s). In case of conflict, the specific recommendations in the geotechnical report shall supersede these more general Specifications. Observations of the earthwork by the project Geotechnical Consultant during the course of grading may result in new or revised recommendations that could supersede these specifications or the recommendations in the geotechnical report(s).

1.2 The Geotechnical Consultant of Record: Prior to commencement of work, the owner shall employ a qualified Geotechnical Consultant of Record (Geotechnical Consultant). The Geotechnical Consultant shall be responsible for reviewing the approved geotechnical report(s) and accepting the adequacy of the preliminary geotechnical findings, conclusions, and recommendations prior to the commencement of the grading.

Prior to commencement of grading, the Geotechnical Consultant shall review the "work plan" prepared by the Earthwork Contractor (Contractor) and schedule sufficient personnel to perform the appropriate level of observation, mapping, and compaction testing.

During the grading and earthwork operations, the Geotechnical Consultant shall observe, map, and document the subsurface exposures to verify the geotechnical design assumptions. If the observed conditions are found to be significantly different than the interpreted assumptions during the design phase, the Geotechnical Consultant shall inform the owner, recommend appropriate changes in design to accommodate the observed conditions, and notify the review agency where required.

The Geotechnical Consultant shall observe the moisture-conditioning and processing of the subgrade and fill materials and perform relative compaction testing of fill to confirm that the attained level of compaction is being accomplished as specified. The Geotechnical Consultant shall provide the test results to the owner and the Contractor on a routine and frequent basis.

1.3 The Earthwork Contractor: The Earthwork Contractor (Contractor) shall be qualified, experienced, and knowledgeable in earthwork logistics, preparation and processing of ground to receive fill, moisture-conditioning and processing of fill, and compacting fill. The Contractor shall review and accept the plans, geotechnical report(s), and these Specifications prior to commencement of grading. The Contractor shall be solely responsible for performing the grading in accordance with the project plans and specifications. The Contractor shall prepare and submit to the owner and the Geotechnical Consultant a work plan that indicates the sequence of earthwork grading, the number of “equipment” of work and the estimated quantities of daily earthwork contemplated for the site prior to commencement of grading. The Contractor shall inform the owner and the Geotechnical Consultant of changes in work schedules and updates to the work plan at least 24 hours in advance of such changes so that appropriate personnel will be available for observation and testing. . The Contractor shall not assume that the Geotechnical Consultant is aware of all grading operations.

The Contractor shall have the sole responsibility to provide adequate equipment and methods to accomplish the earthwork in accordance with the applicable grading codes and agency ordinances, these Specifications, and the recommendations in the approved geotechnical report(s) and grading plan(s). If, in the opinion of the Geotechnical Consultant, unsatisfactory conditions, such as unsuitable soil, improper moisture condition, inadequate compaction, insufficient buttress key size, adverse weather, etc., are resulting in a quality of work less than required in these specifications, the Geotechnical Consultant shall reject the work and may recommend to the owner that construction be stopped until the conditions are rectified. It is the contractor’s sole responsibility to provide proper fill compaction.

2.0 Preparation of Areas to be Filled

2.1 Clearing and Grubbing: Vegetation, such as brush, grass, roots, and other deleterious material shall be sufficiently removed and properly disposed of in a method acceptable to the owner, governing agencies, and the Geotechnical Consultant.

The Geotechnical Consultant shall evaluate the extent of these removals depending on specific site conditions. Earth fill material shall not contain more than 1 percent of organic materials (by volume). No fill lift shall contain more than 10 percent of organic matter. Nesting of the organic materials shall not be allowed.

If potentially hazardous materials are encountered, the Contractor shall stop work in the affected area, and a hazardous material specialist shall be informed immediately for proper evaluation and handling of these materials prior to continuing to work in that area.

As presently defined by the State of California, most refined petroleum products (gasoline, diesel fuel, motor oil, grease, coolant, etc.) have chemical constituents that are considered to be hazardous waste. As such, the indiscriminate dumping or spillage of these fluids onto the ground may constitute a misdemeanor, punishable by fines and/or imprisonment, and shall not be allowed. The contractor is responsible for all hazardous waste relating to his work. The Geotechnical Consultant does not have expertise in this area. If hazardous waste is a concern, then the Client should acquire the services of a qualified environmental assessor.

- 2.2 Processing:** Existing ground that has been declared satisfactory for support of fill by the Geotechnical Consultant shall be scarified to a minimum depth of 6 inches. Existing ground that is not satisfactory shall be overexcavated as specified in the following section. Scarification shall continue until soils are broken down and free from oversize material and the working surface is reasonably uniform, flat, and free from uneven features that would inhibit uniform compaction.
- 2.3 Overexcavation:** In addition to removals and overexcavations recommended in the approved geotechnical report(s) and the grading plan, soft, loose, dry, saturated, spongy, organic-rich, highly fractured or otherwise unsuitable ground shall be overexcavated to competent ground as evaluated by the Geotechnical Consultant during grading.
- 2.4 Benching:** Where fills are to be placed on ground with slopes steeper than 5:1 (horizontal to vertical units), the ground shall be stepped or benched. Please see the Standard Details for a graphic illustration. The lowest bench or key shall be a minimum of 15 feet wide and at least 2 feet deep, into competent material as evaluated by the Geotechnical Consultant. Other benches shall be excavated a minimum height of 4 feet into competent material or as otherwise recommended by the Geotechnical Consultant. Fill placed on ground sloping flatter than 5:1 shall also be benched or otherwise overexcavated to provide a flat subgrade for the fill.
- 2.5 Evaluation/Acceptance of Fill Areas:** All areas to receive fill, including removal and processed areas, key bottoms, and benches, shall be observed, mapped, elevations recorded, and/or tested prior to being accepted by the Geotechnical Consultant as suitable to receive fill. The Contractor shall obtain a written acceptance from the Geotechnical Consultant prior to fill placement. A licensed surveyor shall provide the survey control for determining elevations of processed areas, keys, and benches.

3.0 Fill Material

- 3.1 **General:** Material to be used as fill shall be essentially free from organic matter and other deleterious substances evaluated and accepted by the Geotechnical Consultant prior to placement. Soils of poor quality, such as those with unacceptable gradation, high expansion potential, or low strength shall be placed in areas acceptable to the Geotechnical Consultant or mixed with other soils to achieve satisfactory fill material.
- 3.2 **Oversize:** Oversize material defined as rock, or other irreducible material with a maximum dimension greater than 8 inches, shall not be buried or placed in fill unless location, materials, and placement methods are specifically accepted by the Geotechnical Consultant. Placement operations shall be such that nesting of oversized material does not occur and such that oversize material is completely surrounded by compacted or densified fill. Oversize material shall not be placed within 10 vertical feet of finish grade or within 2 feet of future utilities or underground construction.
- 3.3 **Import:** If importing of fill material is required for grading, proposed import material shall meet the requirements of Section 3.1. The potential import source shall be given to the Geotechnical Consultant at least 48 hours (2 working days) before importing begins so that its suitability can be determined and appropriate tests performed.

4.0 Fill Placement and Compaction

- 4.1 **Fill Layers:** Approved fill material shall be placed in areas prepared to receive fill (per Section 3.0) in near-horizontal layers not exceeding 8 inches in loose thickness. The Geotechnical Consultant may accept thicker layers if testing indicates the grading procedures can adequately compact the thicker layers. Each layer shall be spread evenly and mixed thoroughly to attain relative uniformity of material and moisture throughout.
- 4.2 **Fill Moisture Conditioning:** Fill soils shall be watered, dried back, blended, and/or mixed, as necessary to attain a relatively uniform moisture content at or slightly over optimum. Maximum density and optimum soil moisture content tests shall be performed in accordance with the American Society of Testing and Materials (ASTM Test Method D1557-12).
- 4.3 **Compaction of Fill:** After each layer has been moisture-conditioned, mixed, and evenly spread, it shall be uniformly compacted to not less than 90 percent of maximum dry density (ASTM Test Method D1557-12). Compaction equipment shall be adequately sized and be either specifically designed for soil compaction or of proven reliability to efficiently achieve the specified level of compaction with uniformity.

4.4 Compaction of Fill Slopes: In addition to normal compaction procedures specified above, compaction of slopes shall be accomplished by backrolling of slopes with sheepsfoot rollers at increments of 3 to 4 feet in fill elevation, or by other methods producing satisfactory results acceptable to the Geotechnical Consultant. Upon completion of grading, relative compaction of the fill, out to the slope face, shall be at least 90 percent of maximum density per ASTM Test Method D1557-12.

4.5 Compaction Testing: Field tests for moisture content and relative compaction of the fill soils shall be performed by the Geotechnical Consultant. Location and frequency of tests shall be at the Consultant's discretion based on field conditions encountered. Compaction test locations will not necessarily be selected on a random basis. Test locations shall be selected to verify adequacy of compaction levels in areas that are judged to be prone to inadequate compaction (such as close to slope faces and at the fill/bedrock benches).

4.6 Frequency of Compaction Testing: Tests shall be taken at intervals not exceeding 2 feet in vertical rise and/or 1,000 cubic yards of compacted fill soils embankment. In addition, as a guideline, at least one test shall be taken on slope faces for each 5,000 square feet of slope face and/or each 10 feet of vertical height of slope. The Contractor shall assure that fill construction is such that the testing schedule can be accomplished by the Geotechnical Consultant. The Contractor shall stop or slow down the earthwork construction if these minimum standards are not met.

4.7 Compaction Test Locations: The Geotechnical Consultant shall document the approximate elevation and horizontal coordinates of each test location. The Contractor shall coordinate with the project surveyor to assure that sufficient grade stakes are established so that the Geotechnical Consultant can determine the test locations with sufficient accuracy. At a minimum, two grade stakes within a horizontal distance of 100 feet and vertically less than 5 feet apart from potential test locations shall be provided.

5.0 Subdrain Installation

Subdrain systems shall be installed in accordance with the approved geotechnical report(s), the grading plan, and the Standard Details. The Geotechnical Consultant may recommend additional subdrains and/or changes in subdrain extent, location, grade, or material depending on conditions encountered during grading. All subdrains shall be surveyed by a land surveyor/civil engineer for line and grade after installation and prior to burial. Sufficient time should be allowed by the Contractor for these surveys.

6.0 Excavation

Excavations, as well as over-excavation for remedial purposes, shall be evaluated by the Geotechnical Consultant during grading. Remedial removal depths shown on geotechnical plans are estimates only. The actual extent of removal shall be determined by the Geotechnical Consultant based on the field evaluation of exposed conditions during grading. Where fill-over-cut slopes are to be graded, the cut portion of the slope shall be made, evaluated, and accepted by the Geotechnical Consultant prior to placement of materials for construction of the fill portion of the slope, unless otherwise recommended by the Geotechnical Consultant.

7.0 Trench Backfills

- 7.1** The Contractor shall follow all OSHA and Cal/OSHA requirements for safety of trench excavations.
- 7.2** All bedding and backfill of utility trenches shall be done in accordance with the applicable provisions of Standard Specifications of Public Works Construction. Bedding material shall have a Sand Equivalent greater than 30 (SE>30). The bedding shall be placed to 1 foot over the top of the conduit and densified by jetting. Backfill shall be placed and densified to a minimum of 90 percent of maximum from 1 foot above the top of the conduit to the surface.
- 7.3** The jetting of the bedding around the conduits shall be observed by the Geotechnical Consultant.
- 7.4** The Geotechnical Consultant shall test the trench backfill for relative compaction. At least one test should be made for every 300 feet of trench and 2 feet of fill.
- 7.5** Lift thickness of trench backfill shall not exceed those allowed in the Standard Specifications of Public Works Construction unless the Contractor can demonstrate to the Geotechnical Consultant that the fill lift can be compacted to the minimum relative compaction by his alternative equipment and method.

Cut Lot
(Exposing Unsuitable Soils at Design Grade)

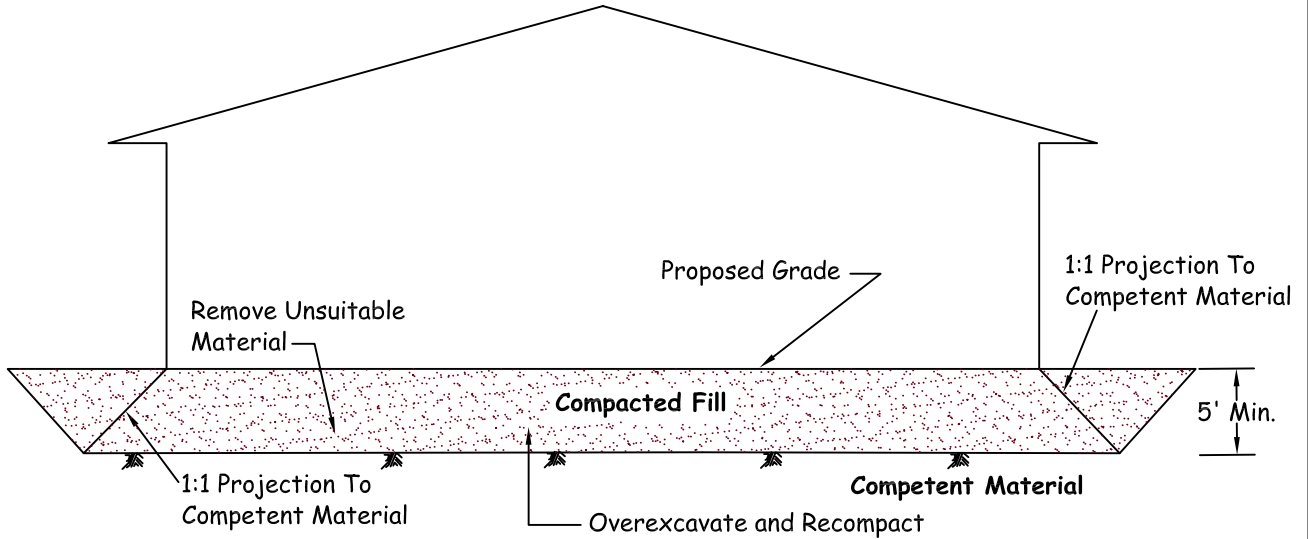

Note 1: Removal Bottom Should be Graded With Minimum 2% Fall Towards Street or Other Suitable Area (as Determined by Soils Engineer) to Avoid Ponding Below Building

Note 2: Where Design Cut Lots are Excavated Entirely Into Competent Material, Overexcavation May Still be Required for Hard-Rock Conditions or for Materials With Variable Expansion Characteristics.

Cut/Fill Transition Lot

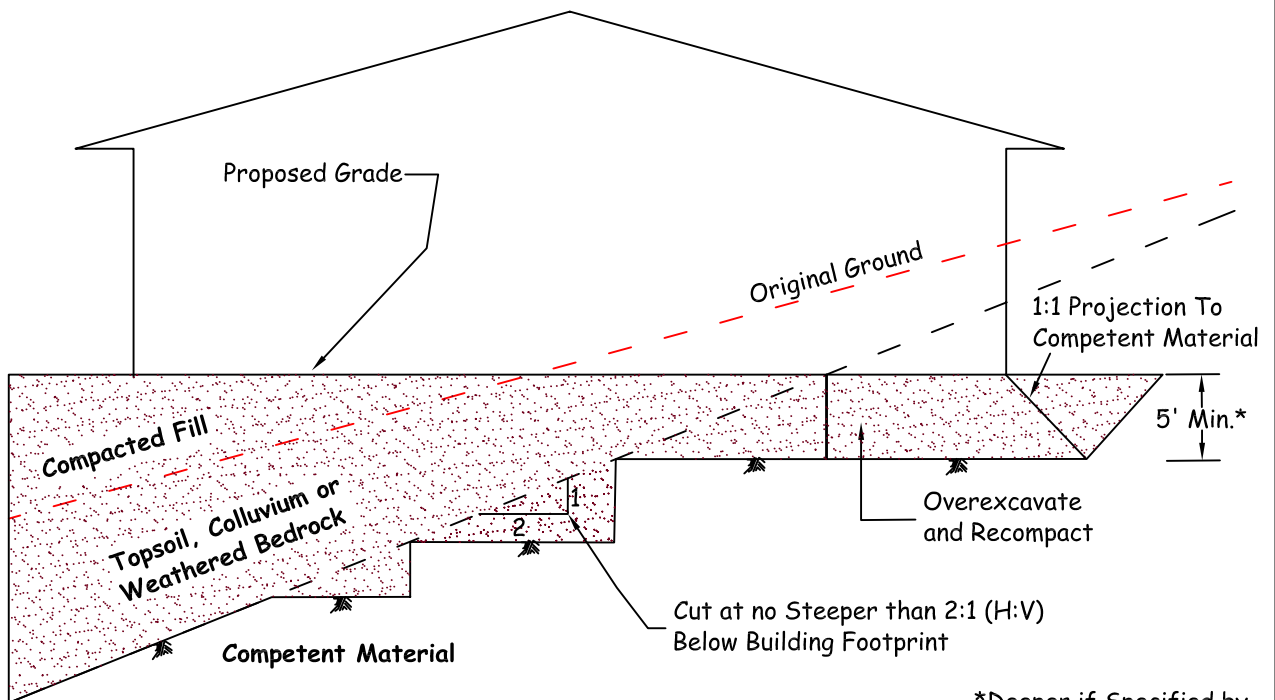

*Deeper if Specified by Soils Engineer

LGC

**CUT AND TRANSITION
LOT OVEREXCAVATION
DETAIL**

Fill Slope

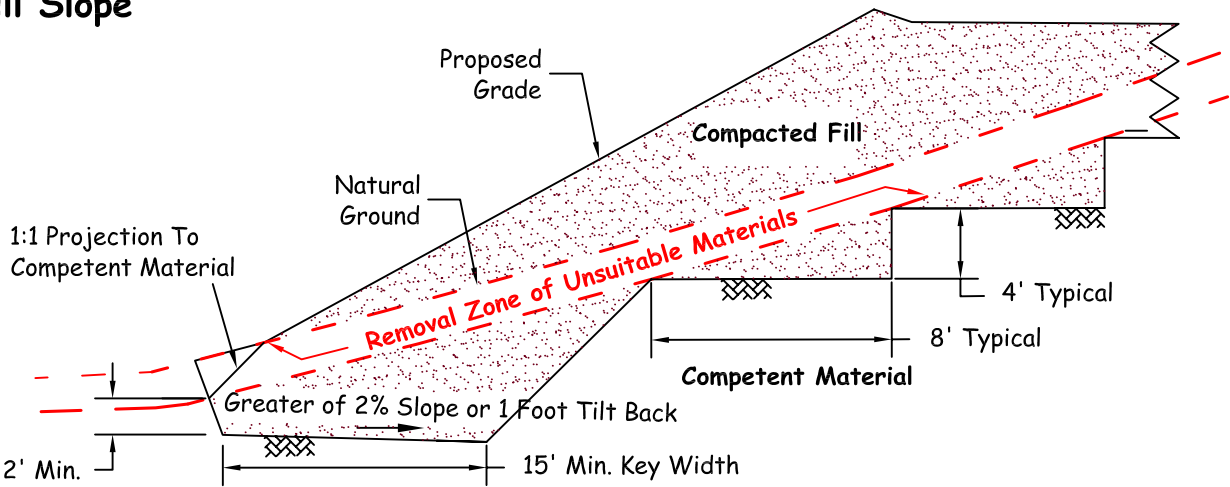

Fill-Over-Cut Slope

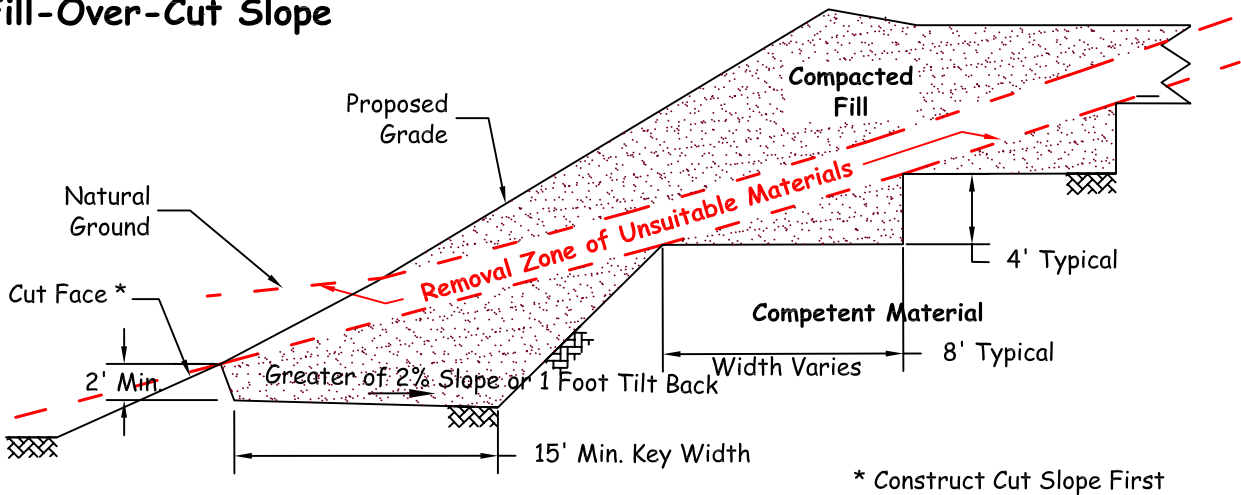

Cut-Over-Fill Slope

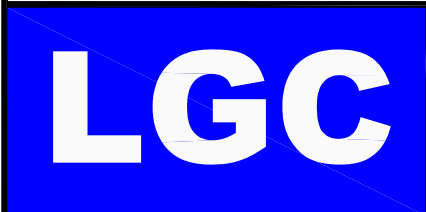
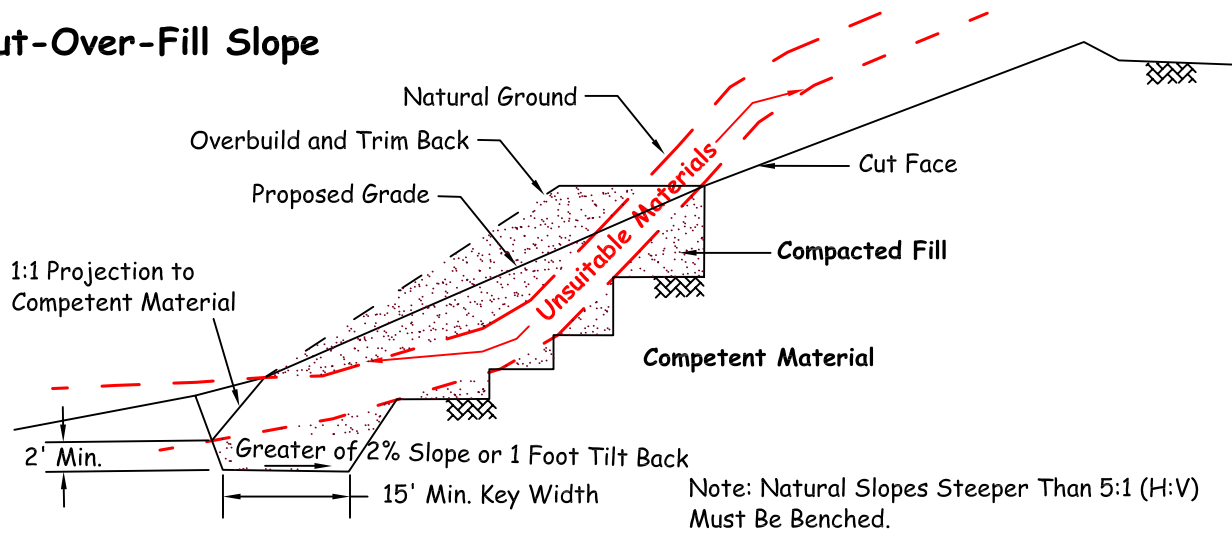

KEYING AND BENCHING

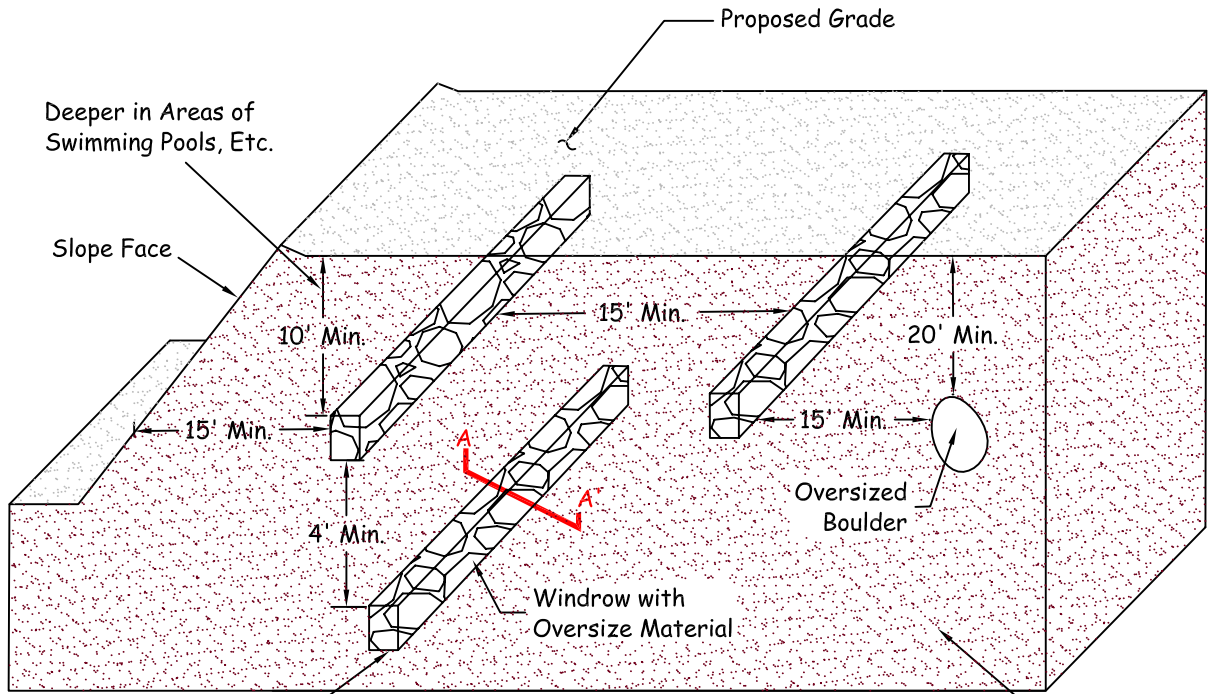

Windrow Parallel to Slope Face

Compacted Fill

Jetted or Flooded Approved Granular Material

Excavated Trench or Dozer V-cut

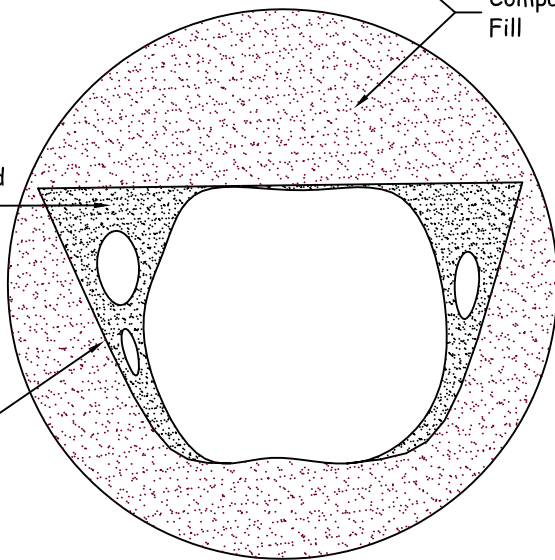

Note: Oversize Rock is Larger than 8" in Maximum Dimension.

Section A-A'

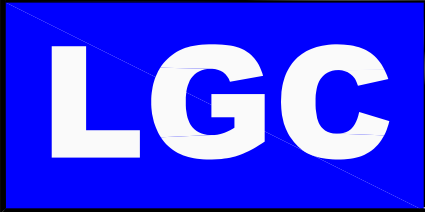

OVERSIZE ROCK DISPOSAL DETAIL

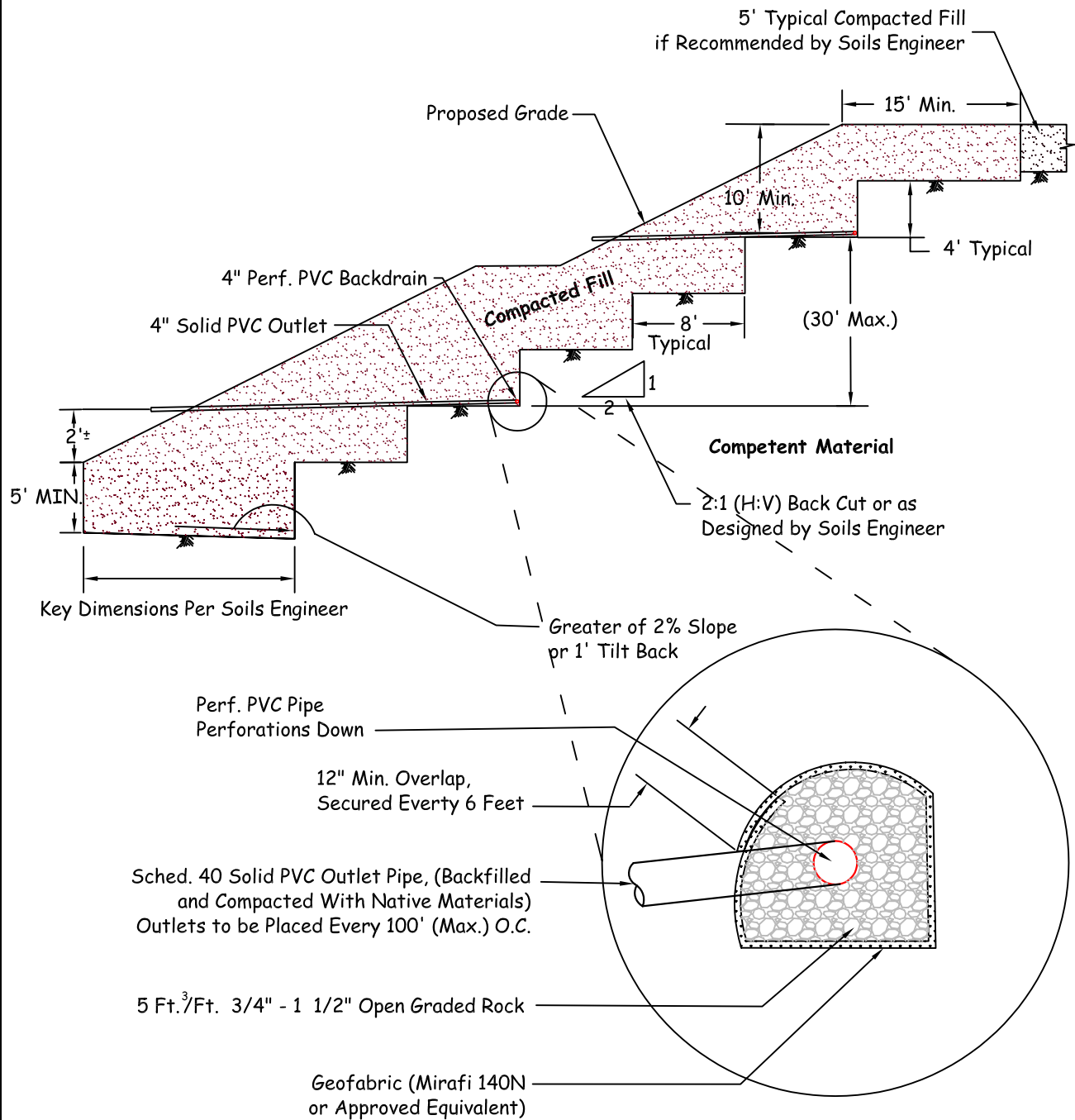

LGC

**TYPICAL BUTTRESS
DETAIL**

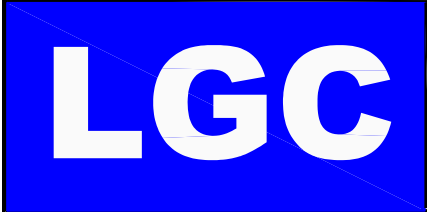
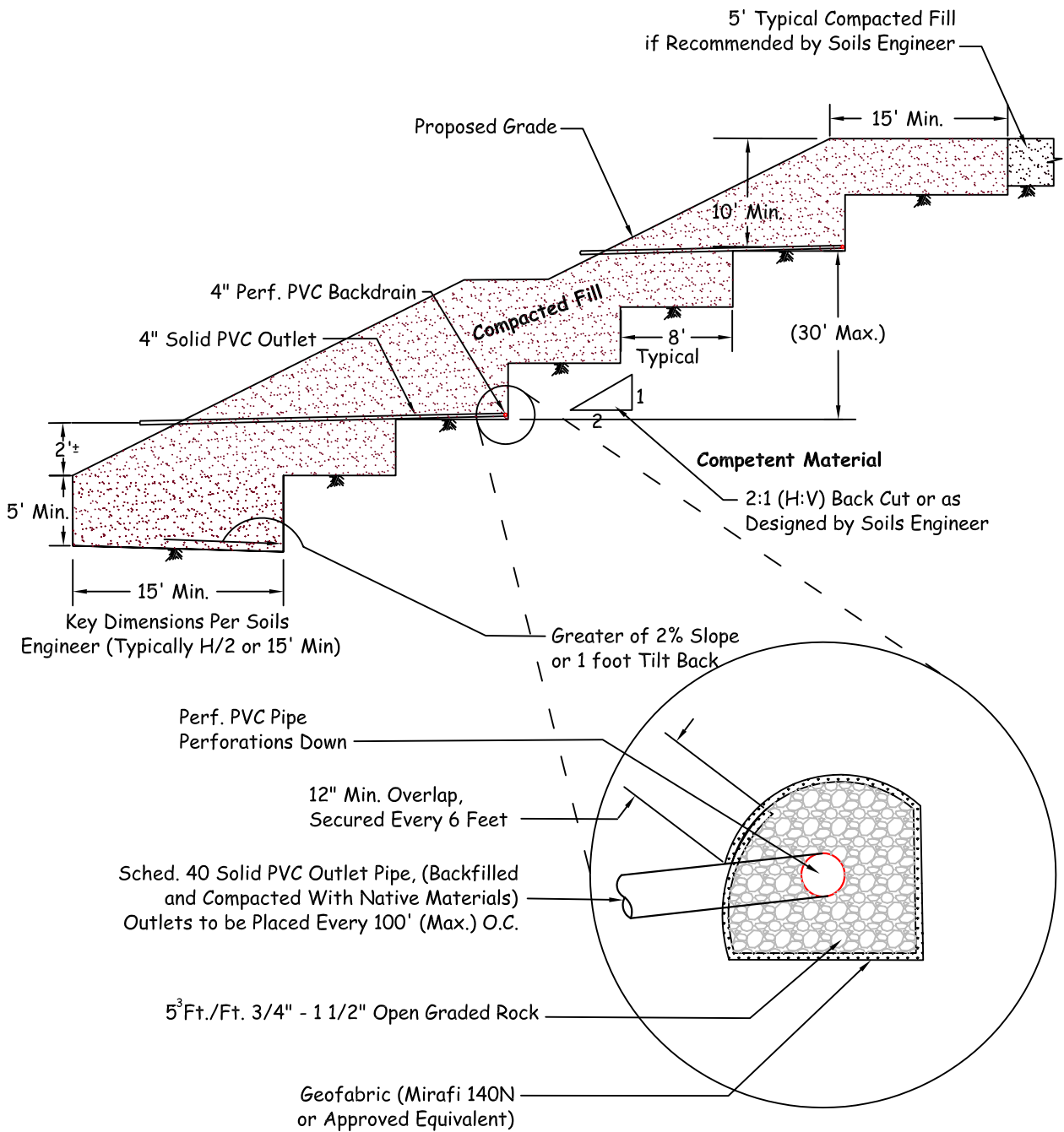

TYPICAL STABILIZATION FILL DETAIL

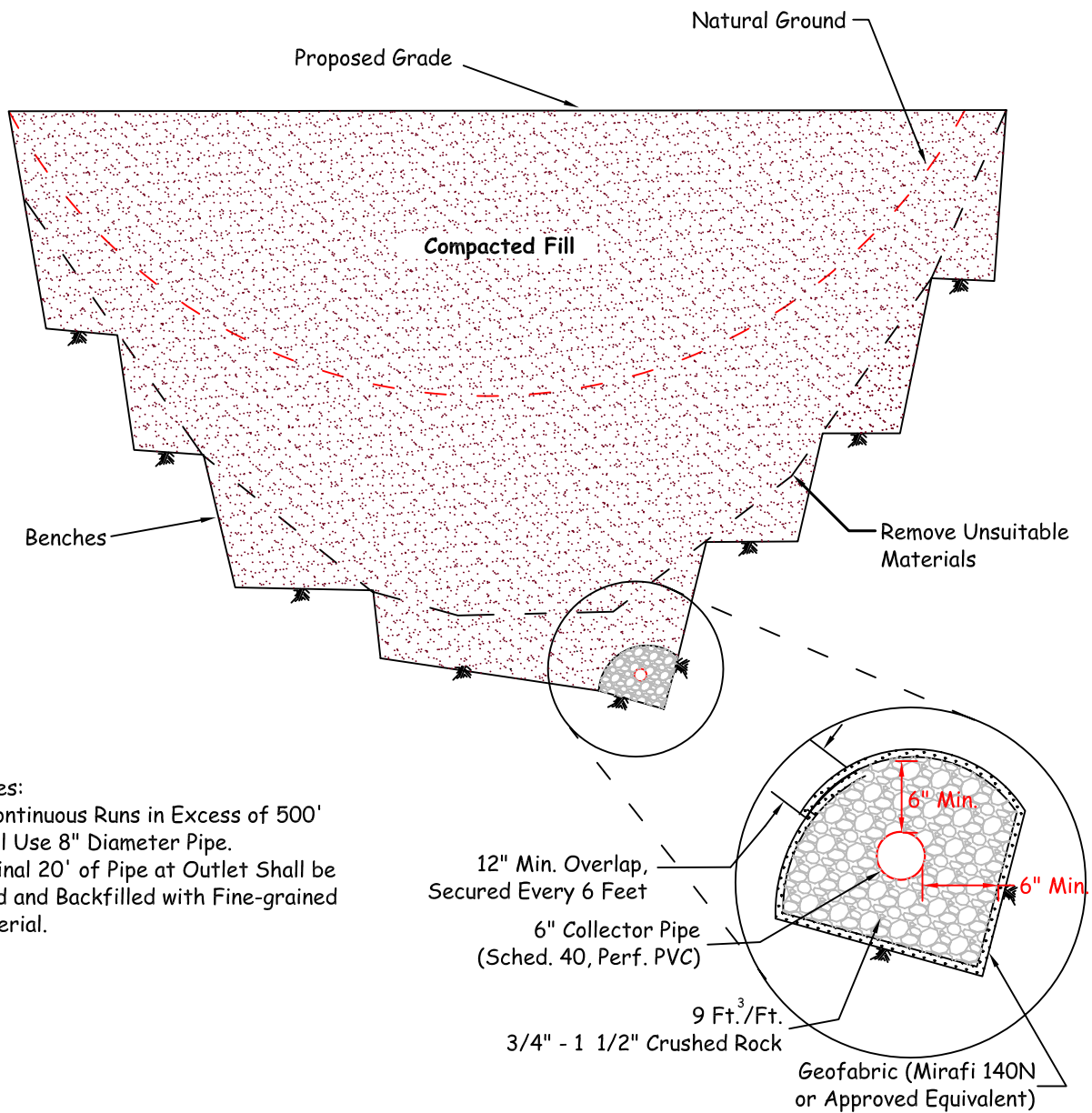

- Notes:
- 1) Continuous Runs in Excess of 500' Shall Use 8" Diameter Pipe.
 - 2) Final 20' of Pipe at Outlet Shall be Solid and Backfilled with Fine-grained Material.

Proposed Outlet Detail

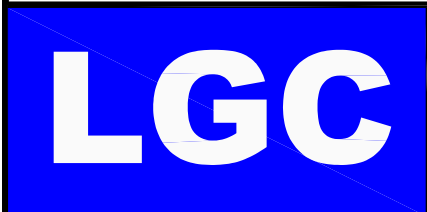
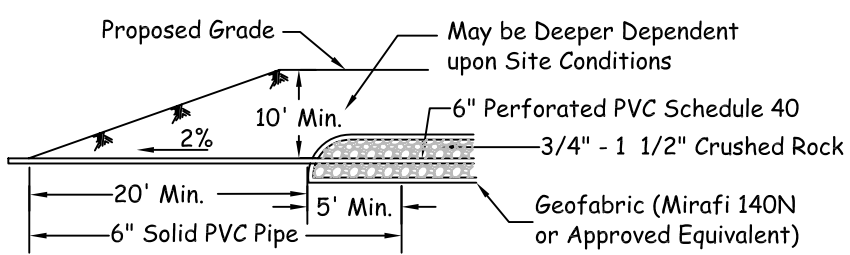

CANYON SUBDRAINS

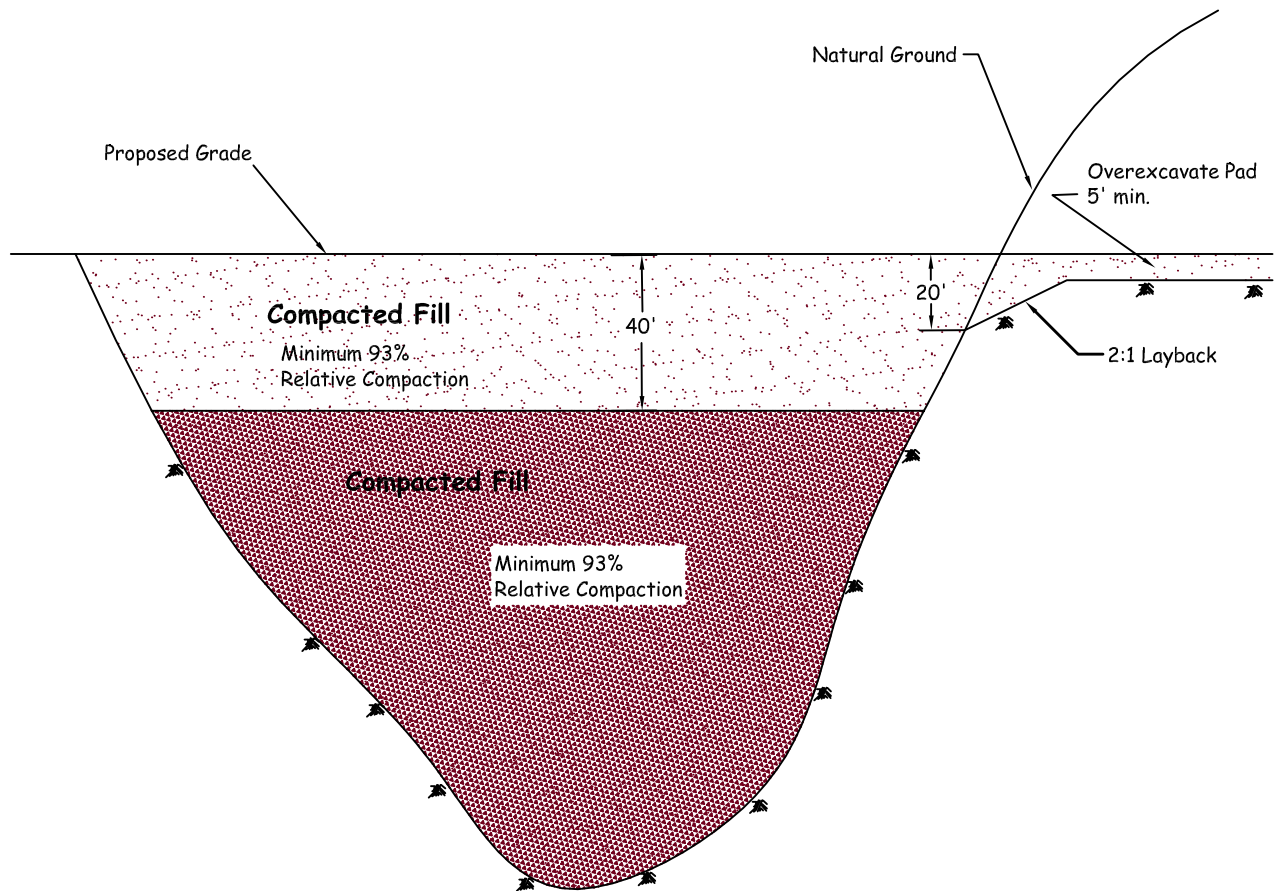

LGC

**DETAIL FOR DEEP FILLS AND 2:1
LAYBACK OF STEEP NATIVE SLOPE
AT PAD GRADE TRANSITION**

MATCH LINE SEE SHEET 2

MATCH LINE SEE SHEET 3

MATCH LINE SEE SHEET 3

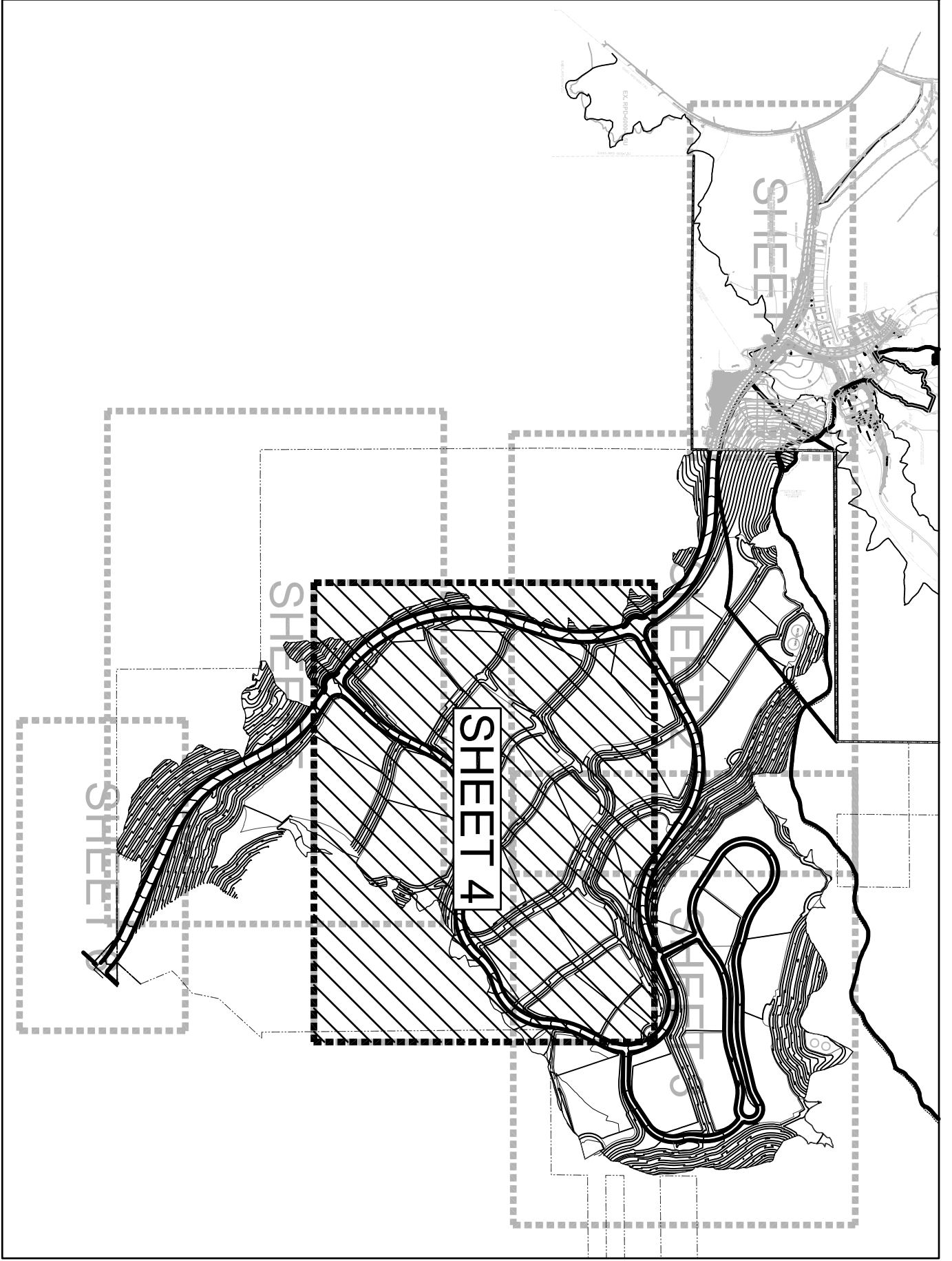

KEY MAP
SCALE: 1" = 1200'

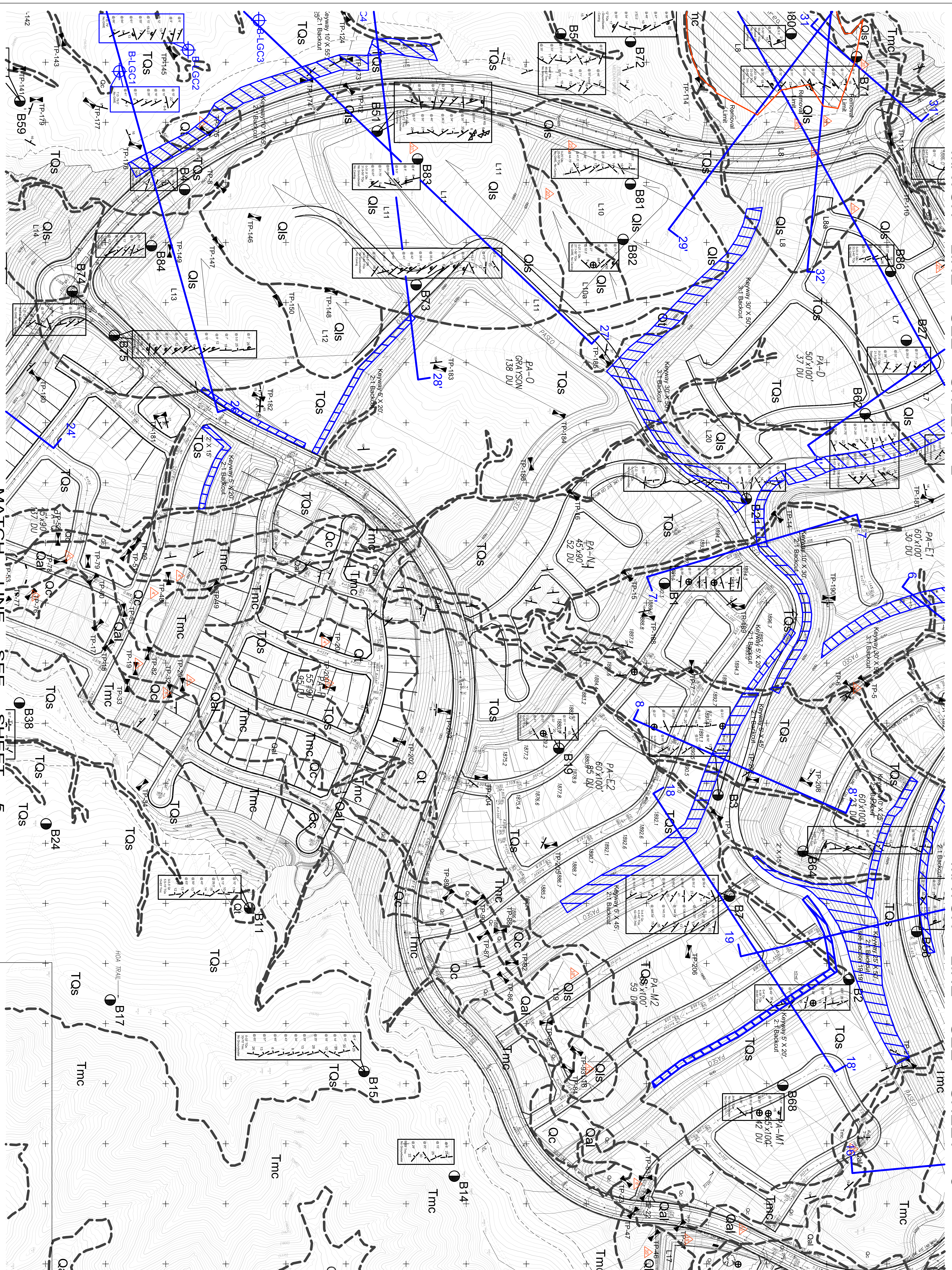

LGC	Geotechnical Map	PLATE	1C
	Tentative Tract 06022 County of Los Angeles, California LGC Valley, Inc.		
DATE	10/20/2015	PROJECT NO.	060922
SCALE	AS SHOWN	SHEET	4 OF 9

LEGEND:

- PROJECT BOUNDARY
- DITCH
- CUT/FILL LINE
- SQUARE FOOT
- PAID EASEMENT
- FUTURE STREET
- ONE LINE
- TYPICAL DRAINAGE AND APPROX. GRADE
- TYPICAL RETAINING WALL
- SCENT LINE
- STORM DRAIN
- WATERLINE
- GROUND BASIN
- FLOODING AREA F
- RETAINING WALL
- FENCED ROAD
- HOA ROAD
- HOA BOUNDARY
- OPENING BARRIER LINE

1:10" = 1" (See Note 1.1) (Vertical Scale)
 19540 JAMBROFFEE ROAD SUITE 300, IRVINE, CA 92612
 ATTN: MICHAEL A. McMillen
 (949) 438-1440

REVISIONS:

NO.	DATE	APPROVED BY	REASON
1	10/20/2015		INITIAL DESIGN
2	10/20/2015		REVISED DESIGN

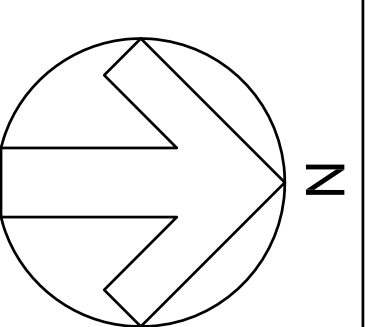

NO.	DATE	APPROVED BY	REASON
1	10/20/2015		INITIAL DESIGN
2	10/20/2015		REVISED DESIGN



REVISED MAP
 X: NewLib Logo SkandLogo.jp MAJOR LAND DIVISION
 VESTING TENTATIVE TRACT NO. 060922
 LOCATED IN THE UNINCORPORATED TERRITORY OF
 THE COUNTY OF LOS ANGELES, STATE OF CALIFORNIA

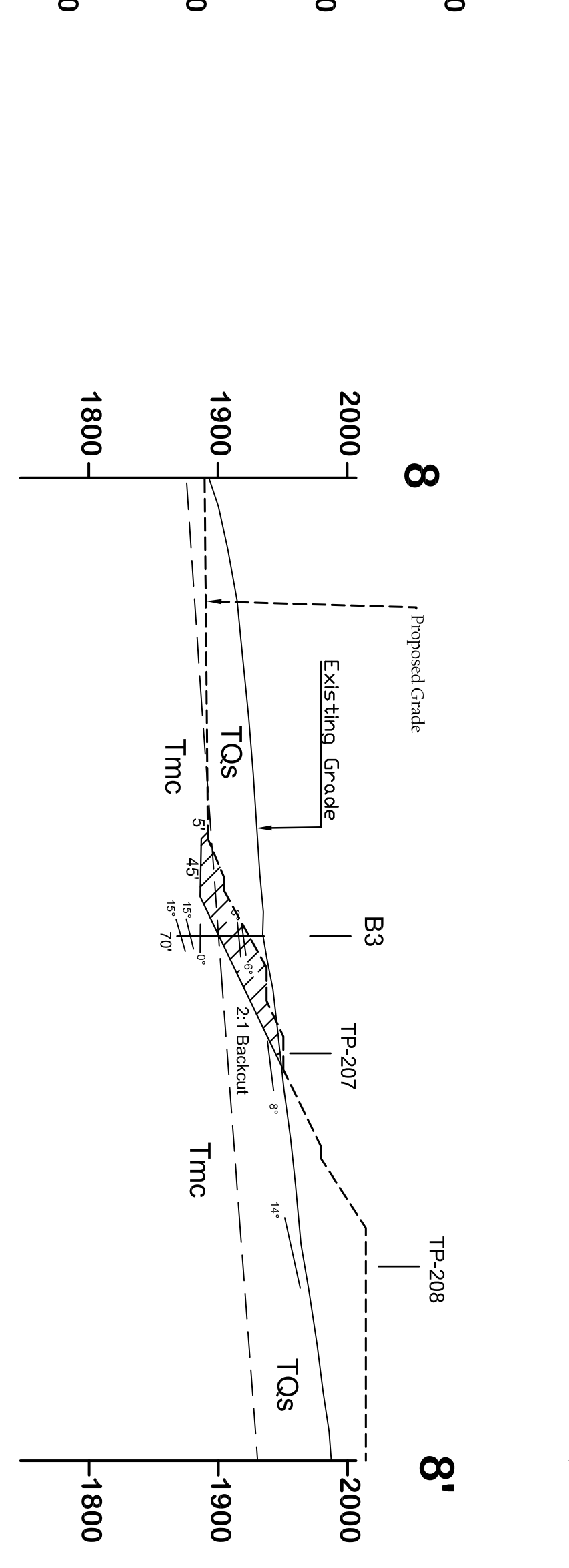
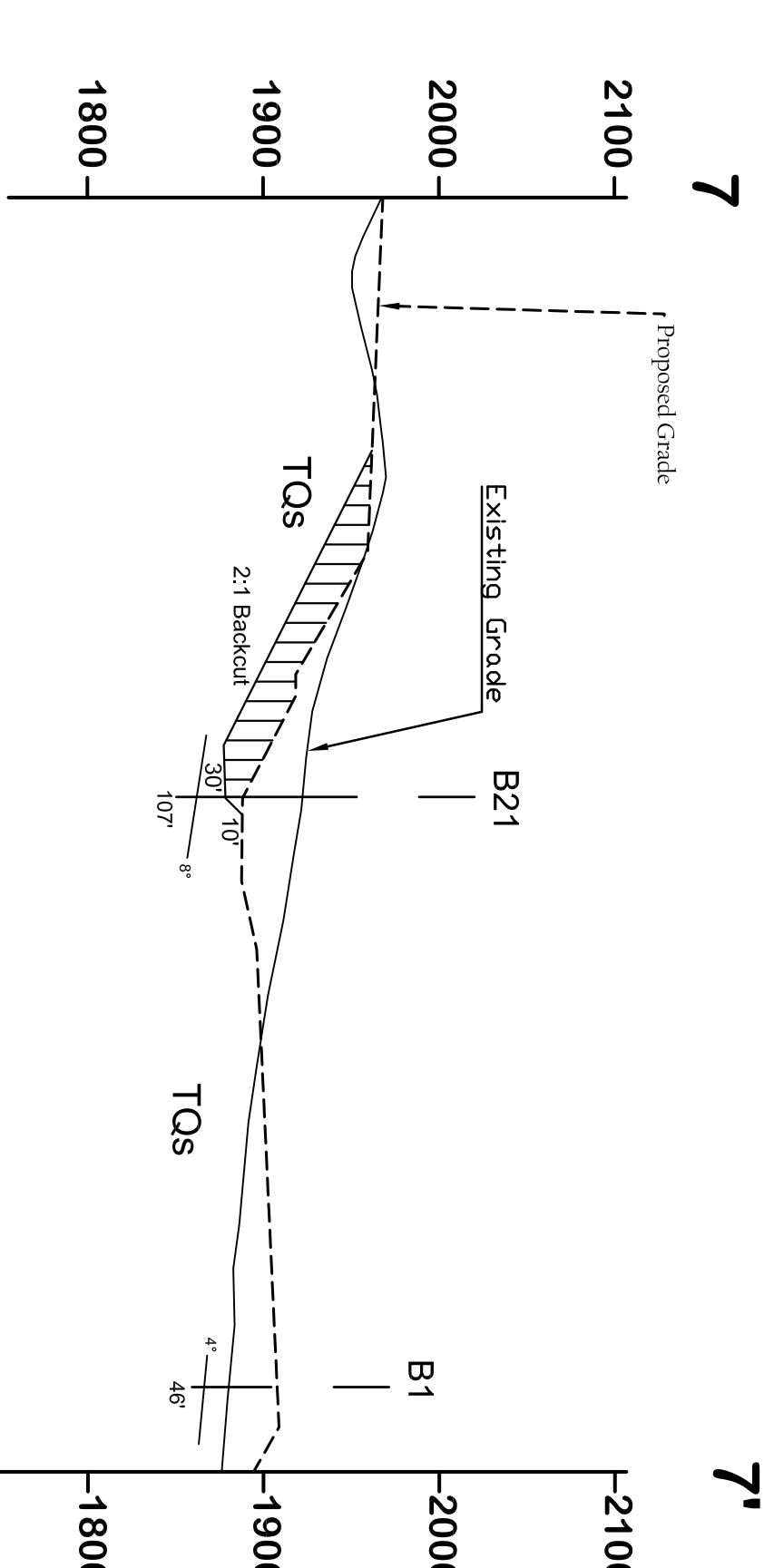
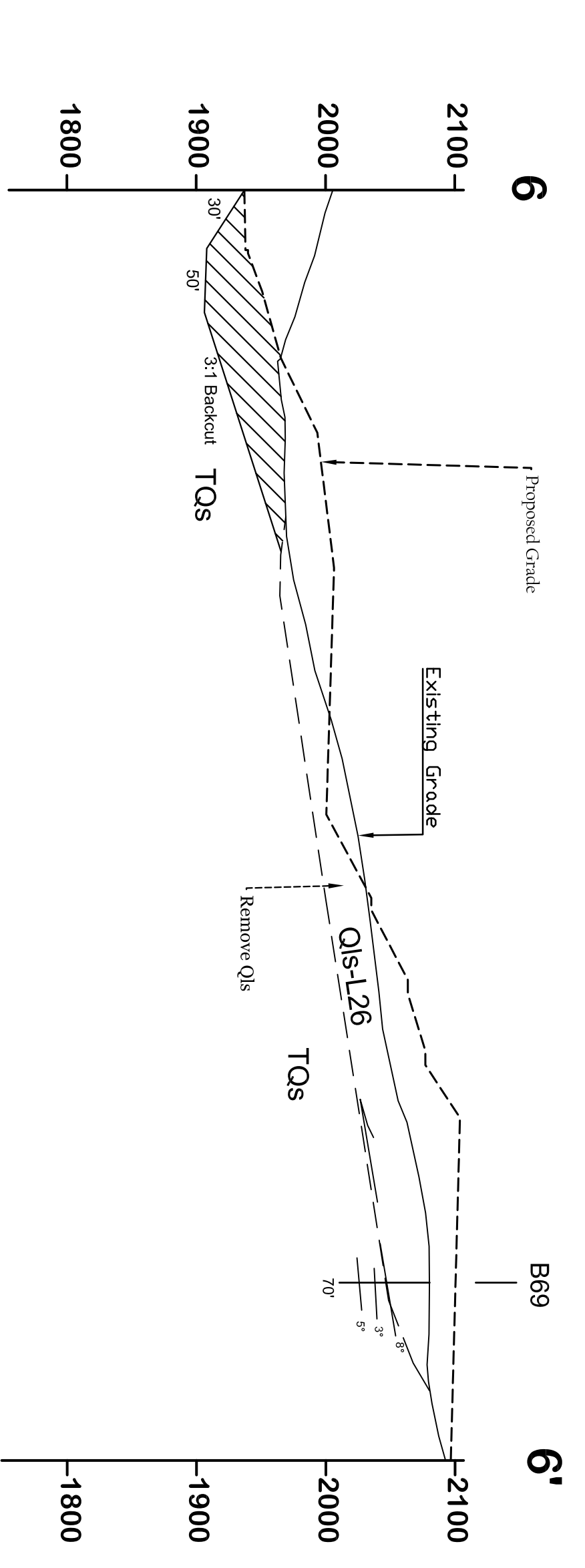
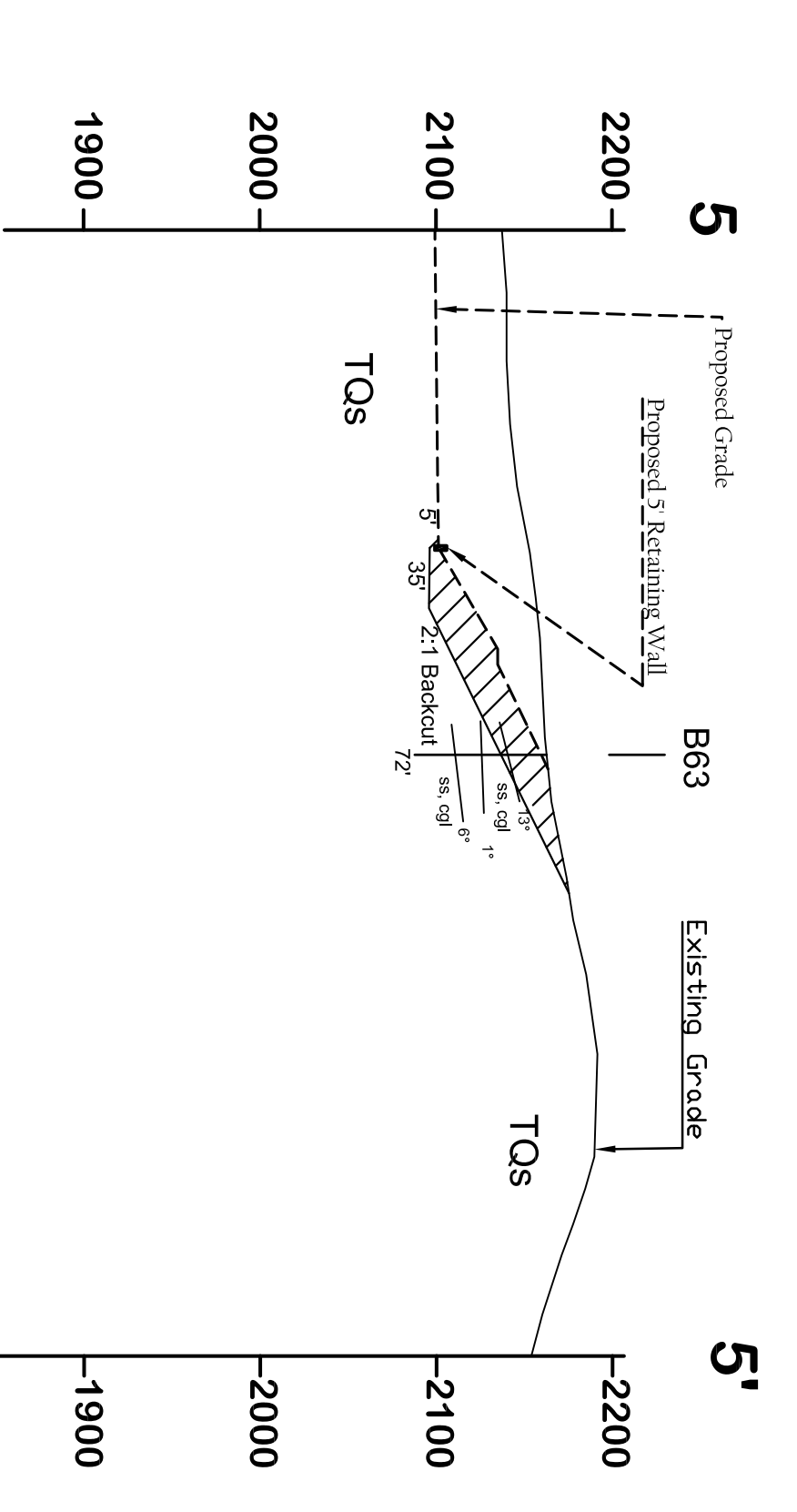
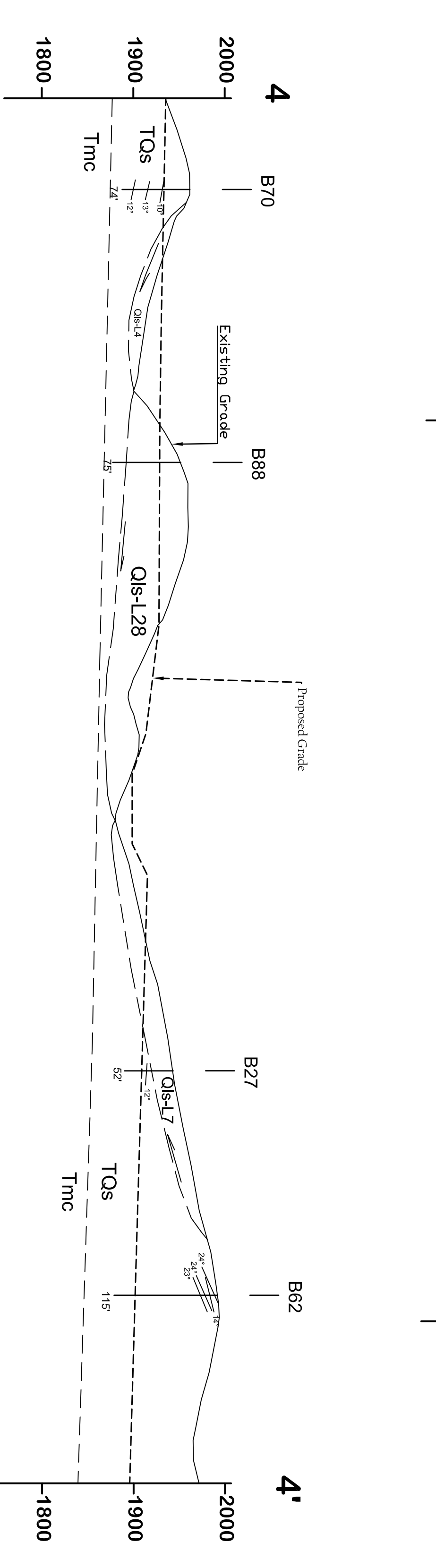
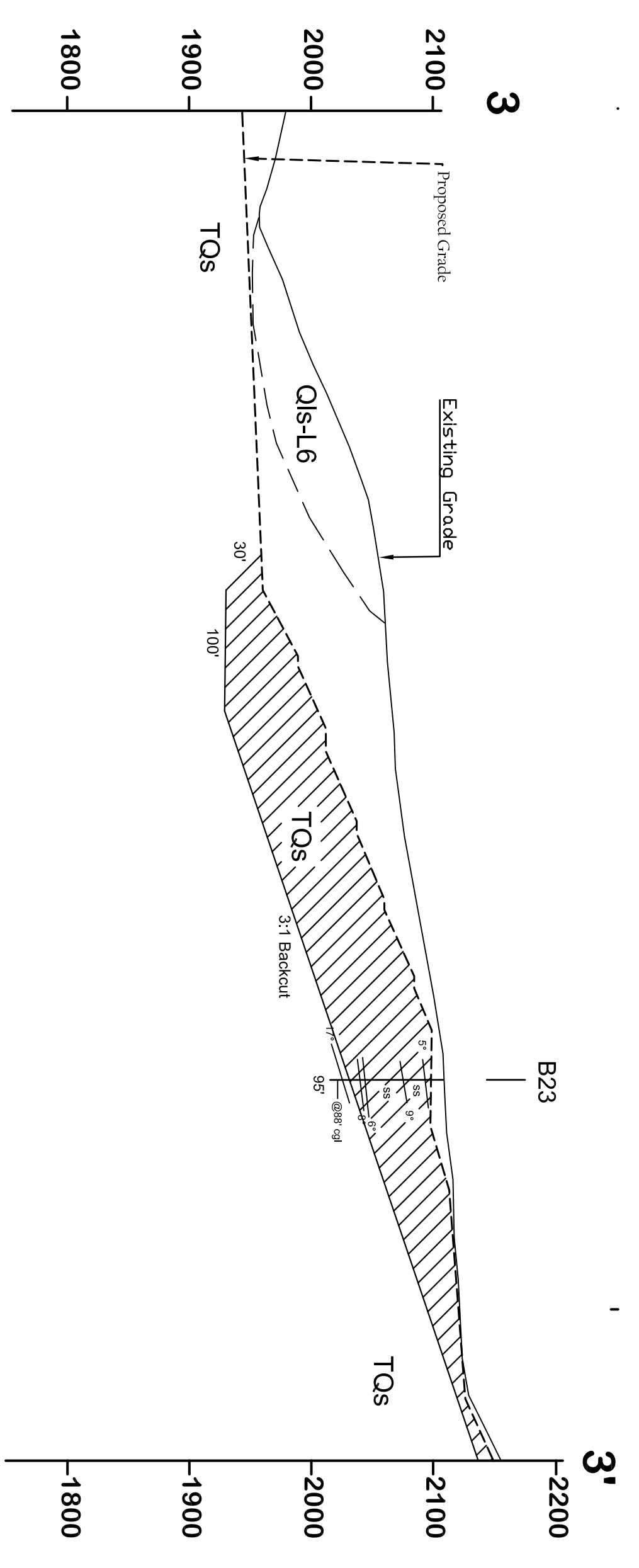
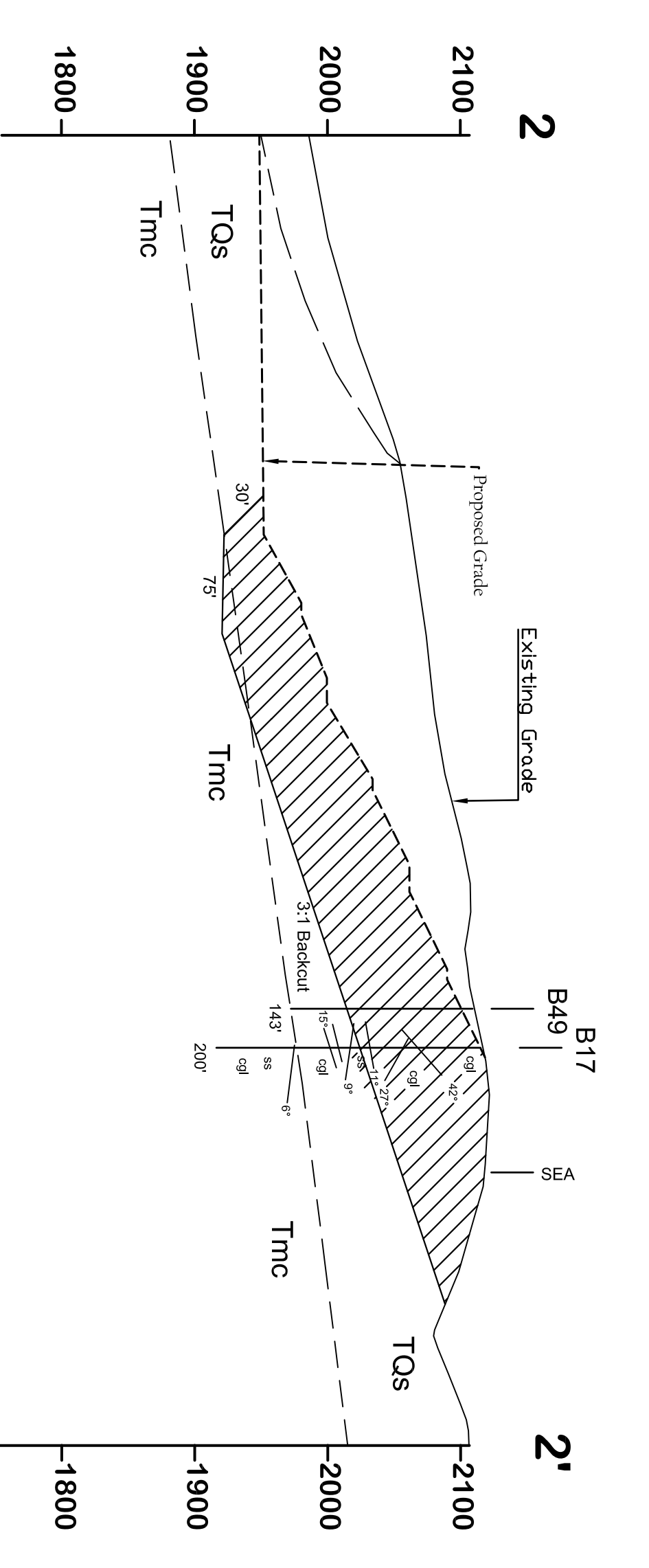
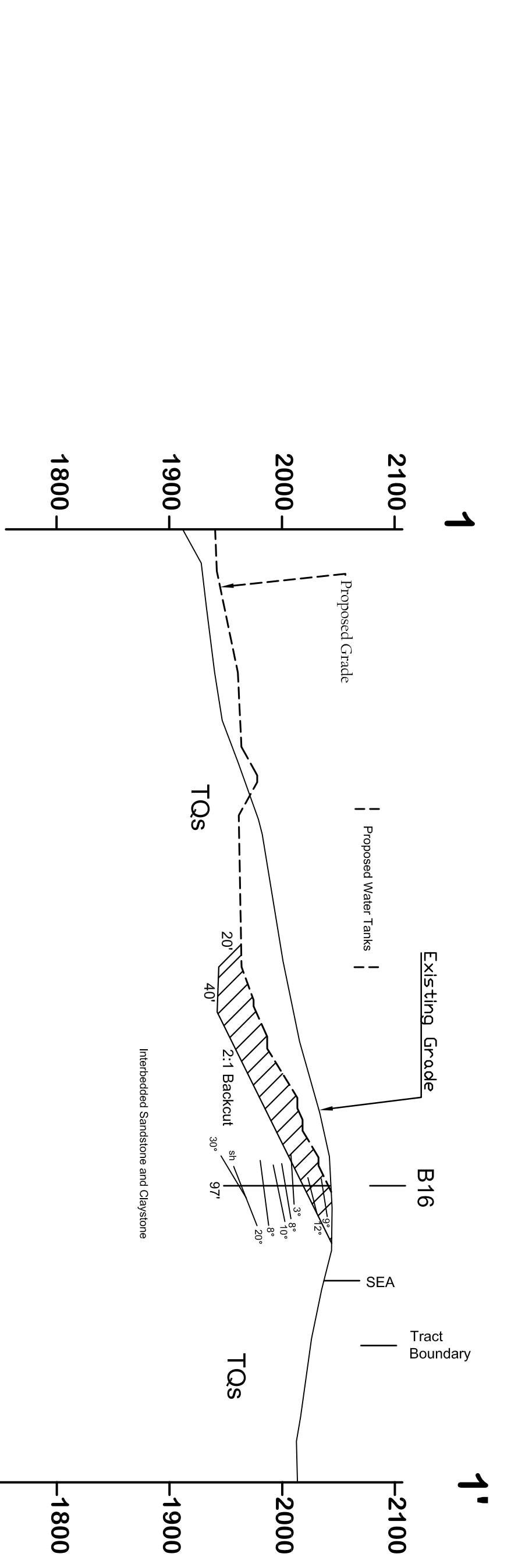

LGC Valley, Inc.
 28532 Constellation Road
 Valencia, CA 91355
 TEL. (661) 702-8474 FAX (661) 702-8475

Geologic Cross Sections
 1-1' through 8-8'

CLIENT:
 Pardee Homes

CIVIL ENGINEER:
 SIKAND Engineering

PROJECT NAME	Skyline Ranch
PROJECT NO.	153035-01
ENG. / GEOL.	BIH / SMB
SCALE	1" = 100'
DATE	March 2016

PLATE
 2a

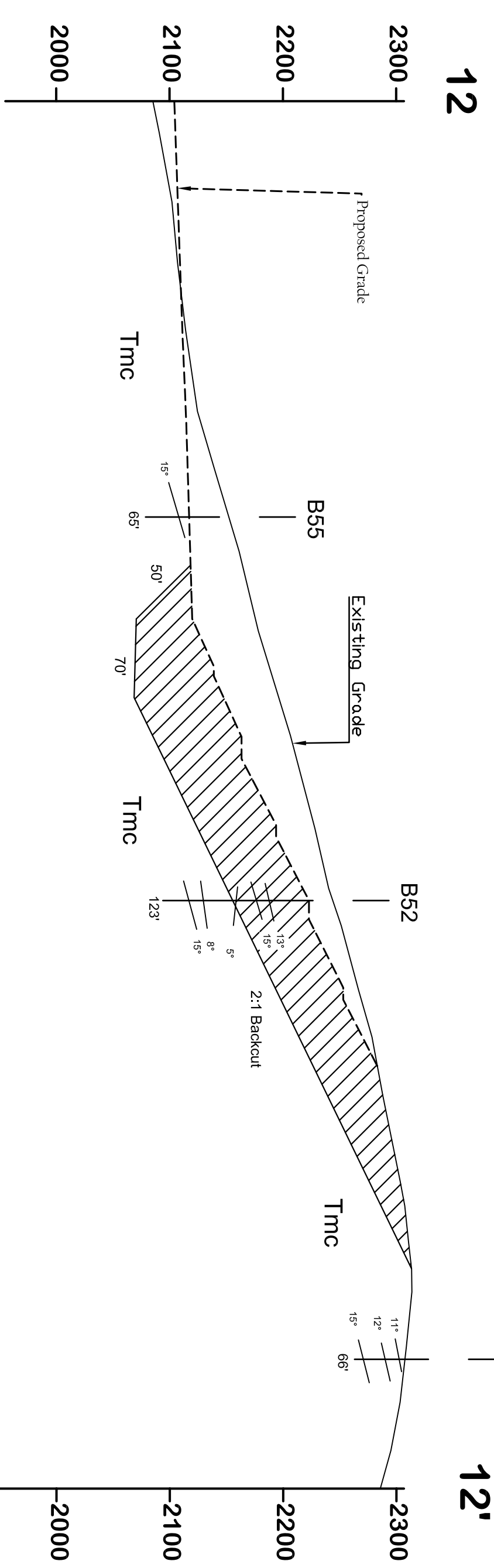
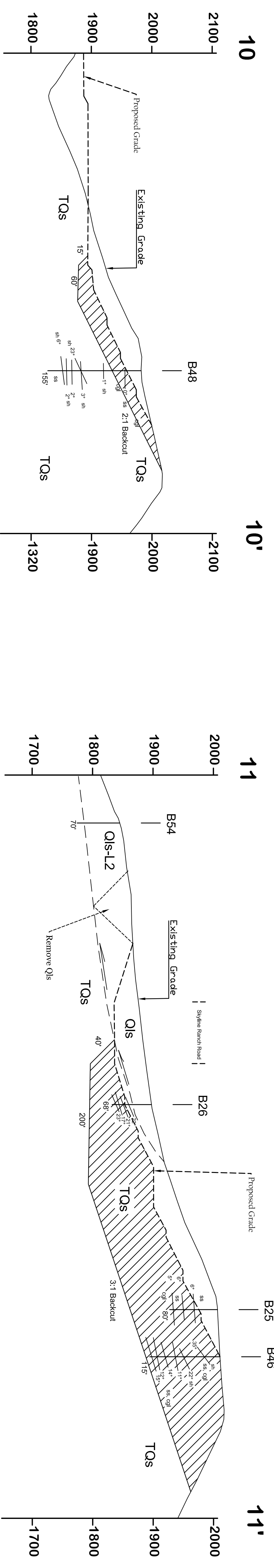
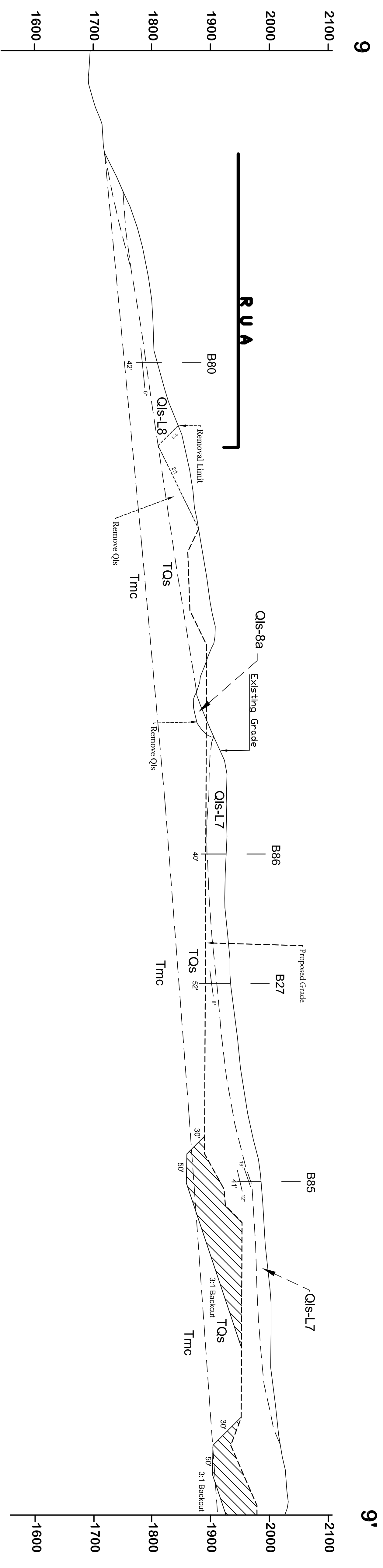

LGC Valley, Inc.

28332 Constellation Road
Valencia, CA 91355
TEL. (661) 702-9474 FAX (661) 702-9475

Geologic Cross Sections
9-9' through 12-12'

CLIENT:
Pardee Homes

CIVIL ENGINEER:
SIKAND Engineering

PROJECT NAME	Skyline Ranch
PROJECT NO.	133035-01
ENG / GEOL.	BH / SMB
SCALE	1" = 100'
DATE	March 2016

PLATE
2b

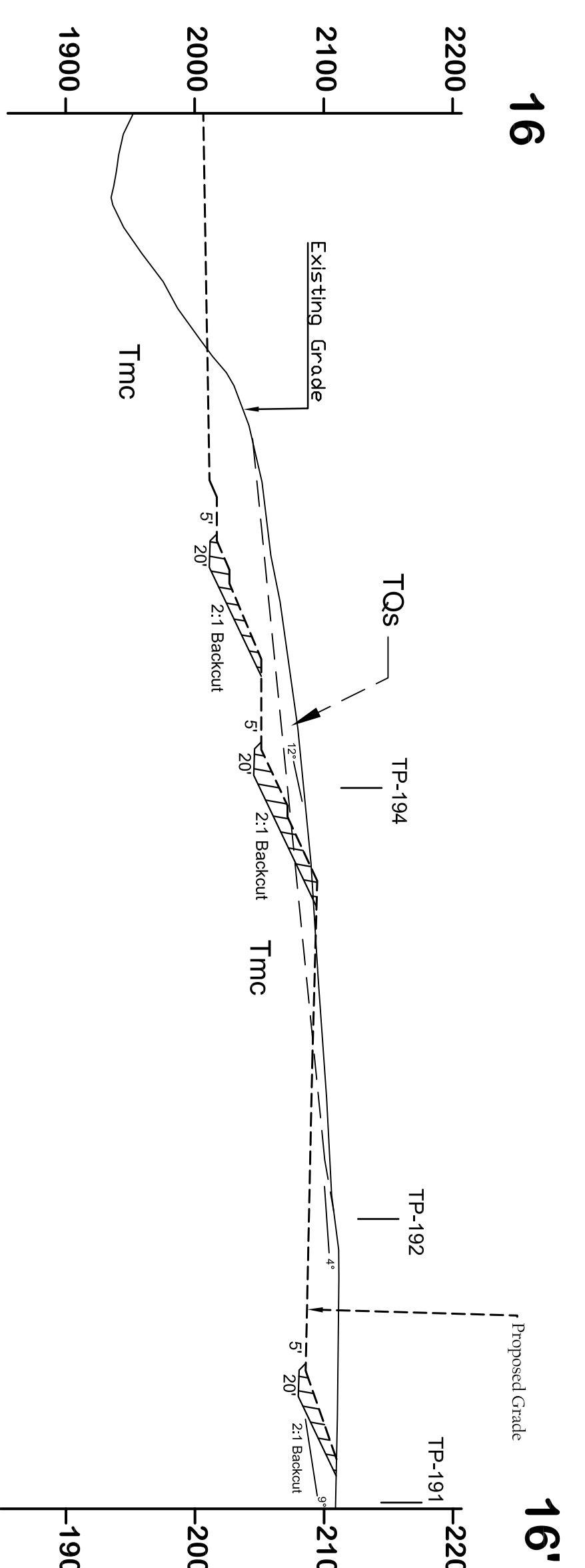
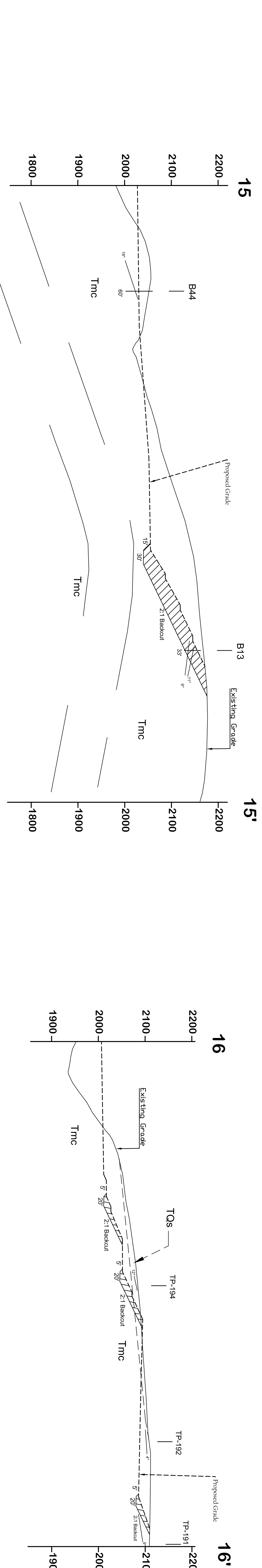
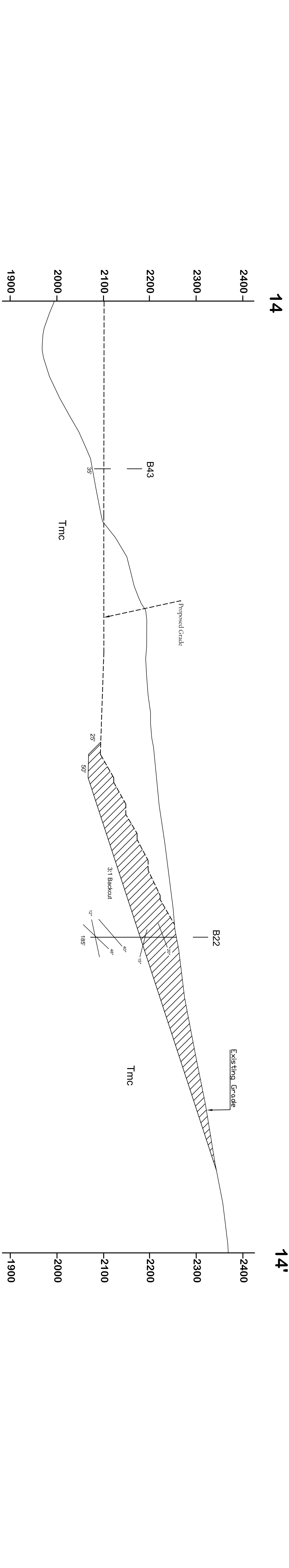
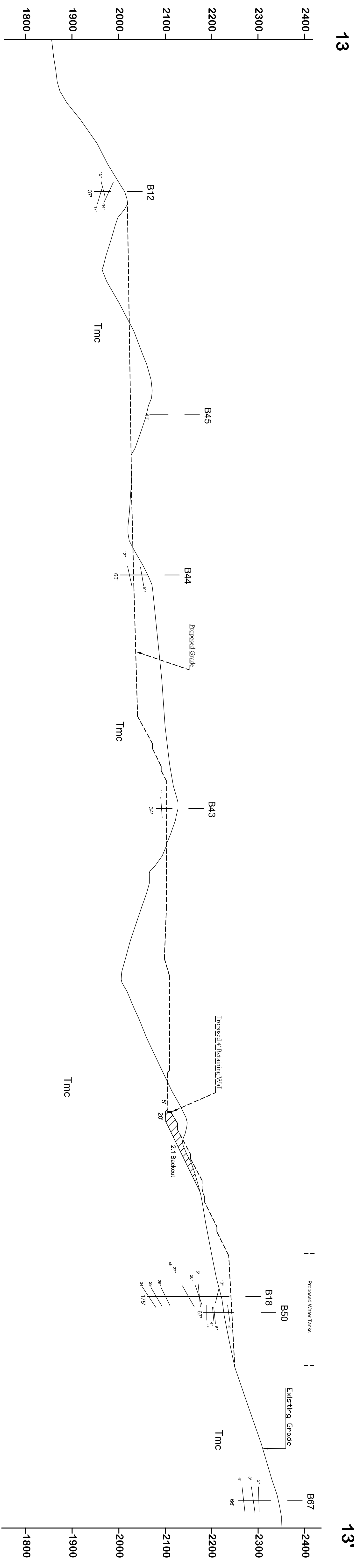

LGC Valley, Inc.
 28632 Constellation Road
 Valencia, CA 91355
 TEL. (661) 702-8474 FAX (661) 702-8475

Geologic Cross Sections
13-13' through 16-16'

CLIENT:
 Pardee Homes

CIVIL ENGINEER:
 SIKAND Engineering

PROJECT NAME	Skyline Ranch
PROJECT NO.	153035-01
ENG. / GEOL.	BIH / SMB
SCALE	1" = 100'
DATE	March 2016

PLATE
2c

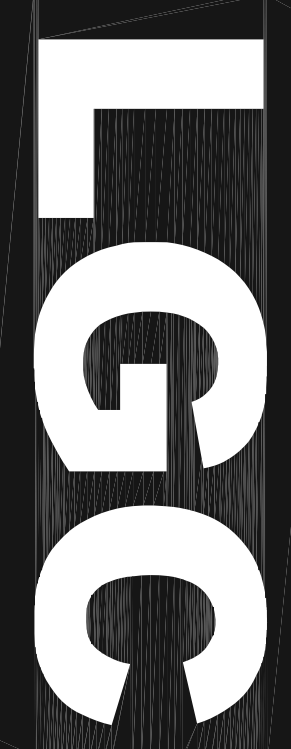
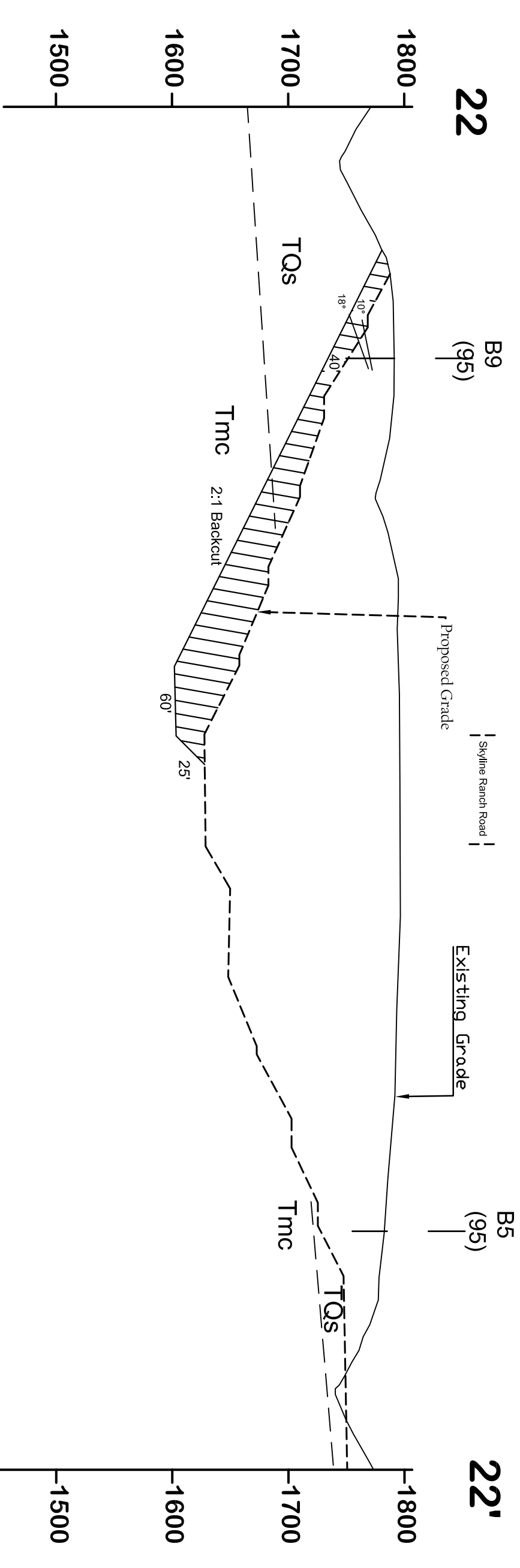
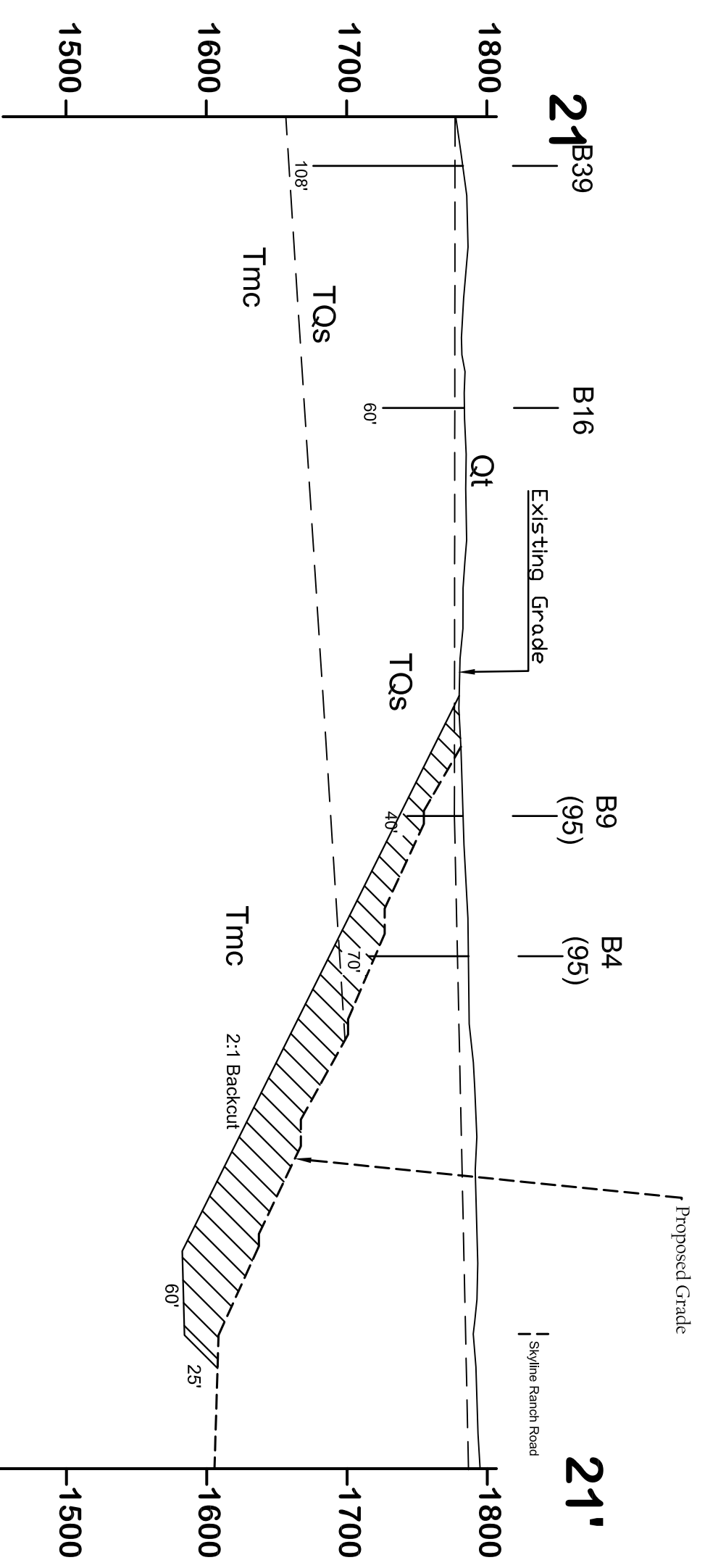
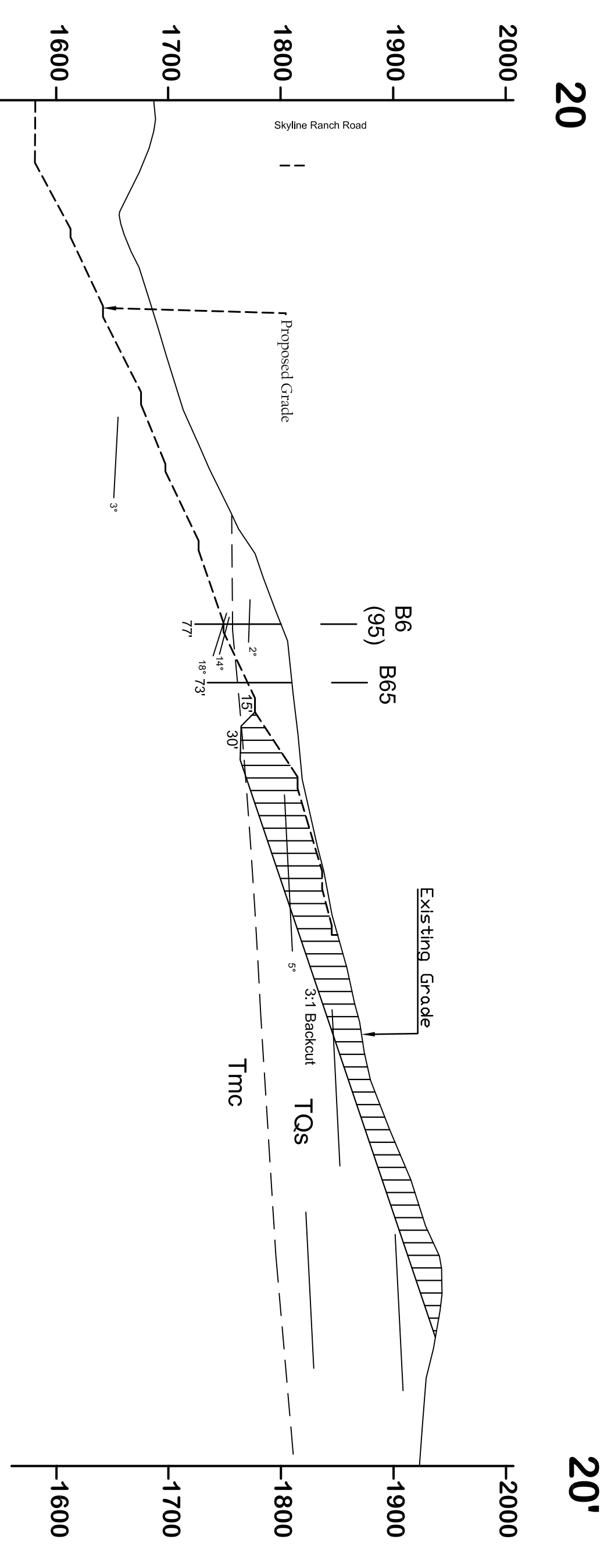
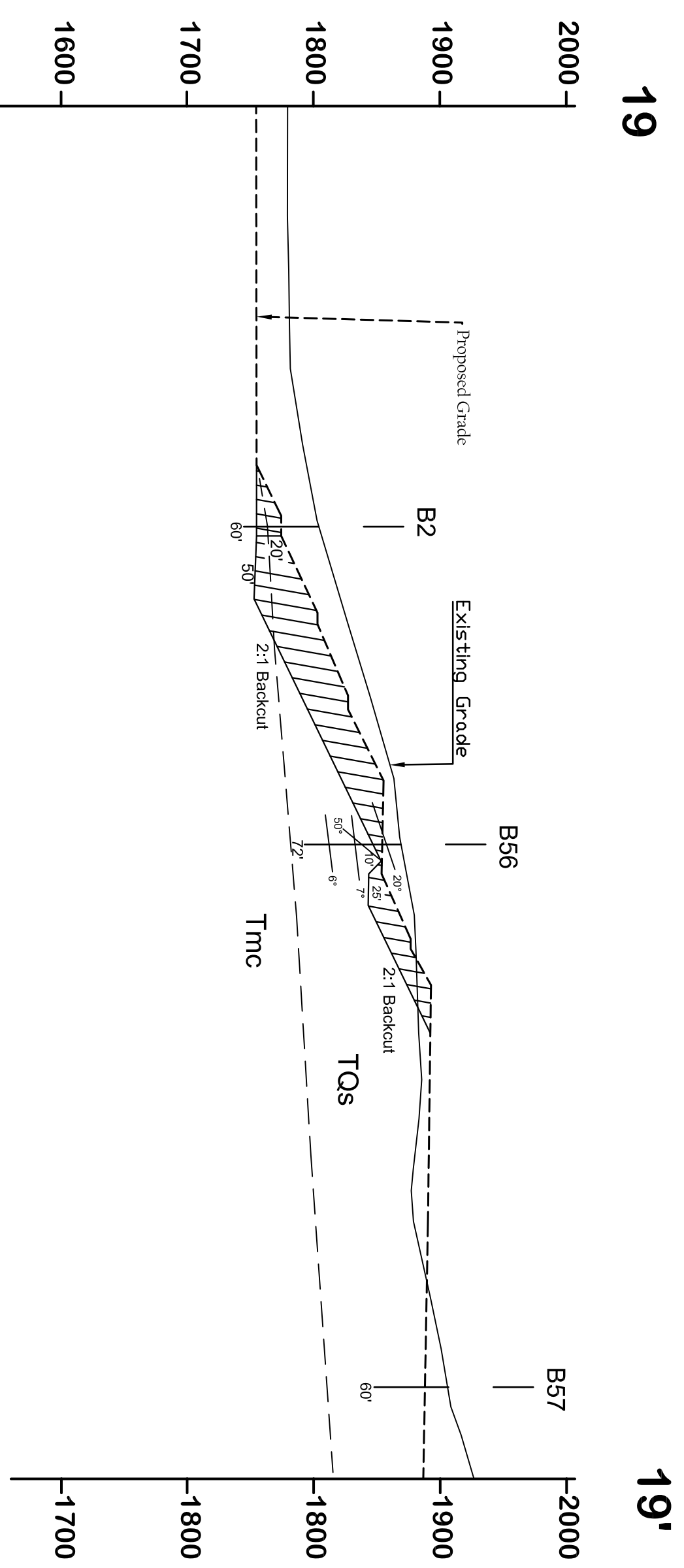
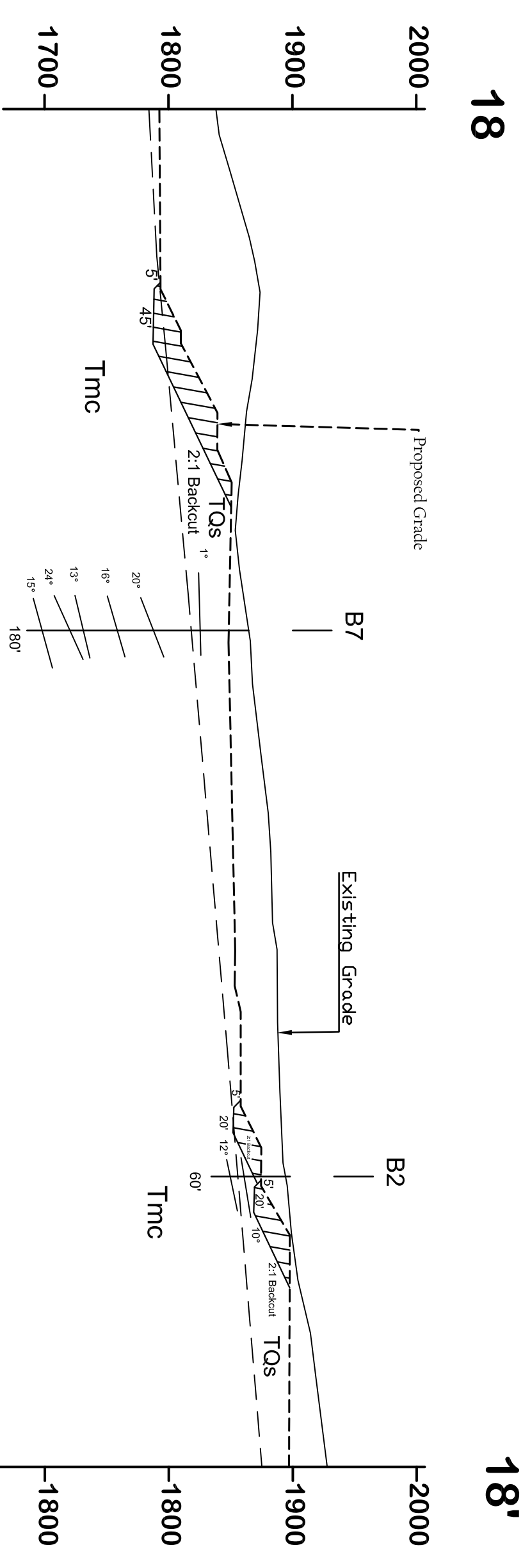
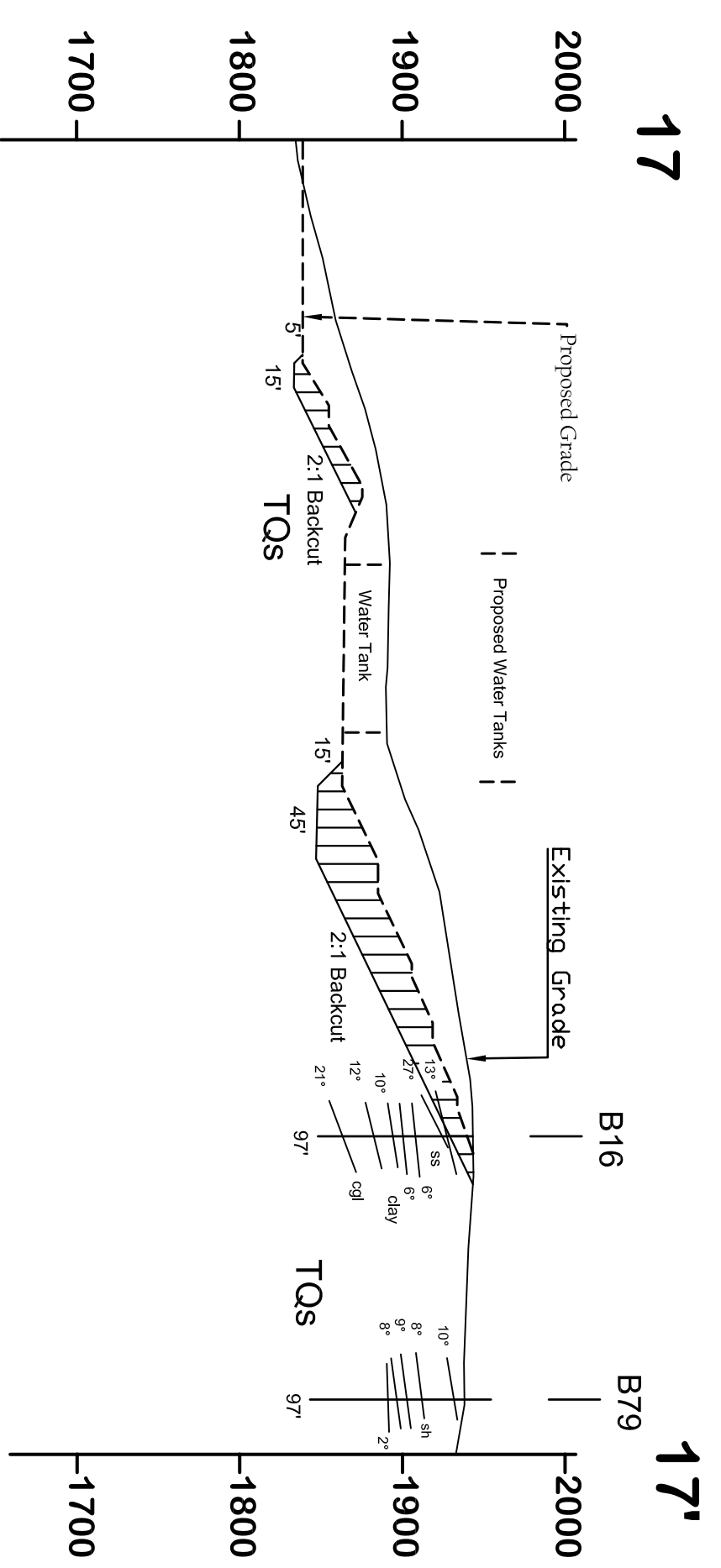

LGC Valley, Inc.

28532 Constellation Road
Valencia, CA 91355
TEL. (661) 702-8474 FAX (661) 702-8475

Geologic Cross Sections
17-17' through 22-22'

CLIENT:
Pardee Homes

CIVIL ENGINEER:
SIKAND Engineering

PROJECT NAME	Skyline Ranch
PROJECT NO.	153035-01
ENG. / GEOL.	BIH / SMB
SCALE	1" = 100'
DATE	March 2016

PLATE
2d

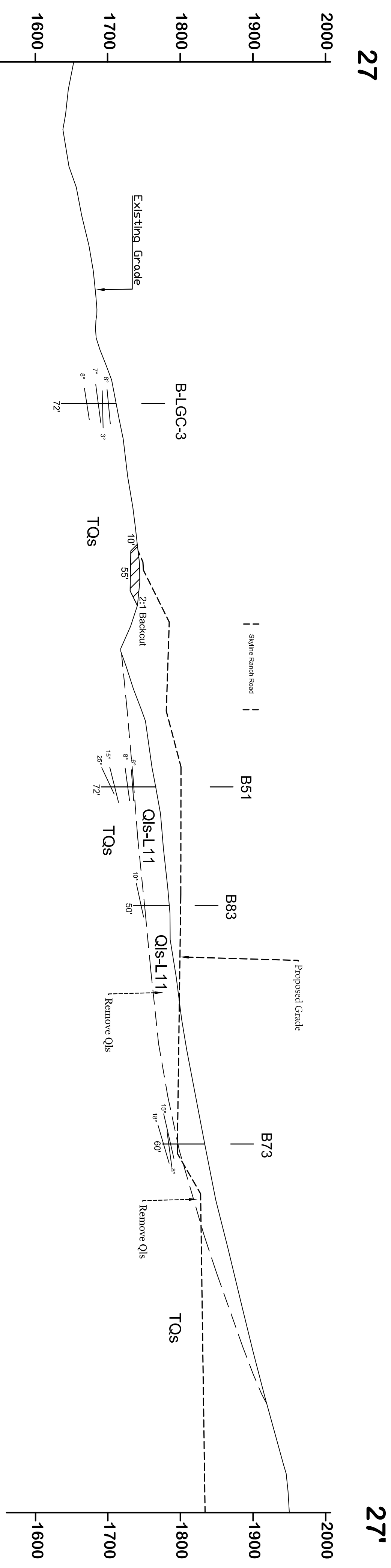
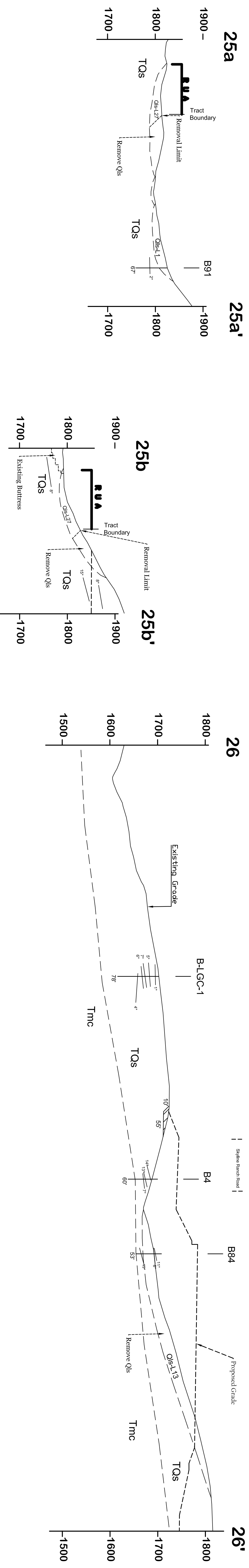
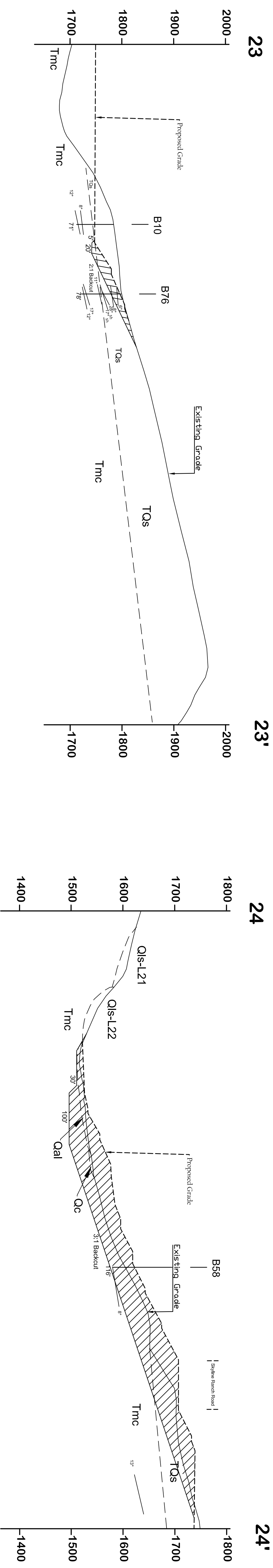

LGC Valley, Inc.

28532 Constellation Road
Valencia, CA 91355
TEL. (661) 702-8474 FAX (661) 702-8475

**Geologic Cross Sections
23-23' through 27-27'**

CLIENT:
Pardee Homes

CIVIL ENGINEER:
SIKAND Engineering

PROJECT NAME	Skyline Ranch
PROJECT NO.	153035-01
ENG. / GEOL.	BIH / SMB
SCALE	1" = 100'
DATE	March 2016

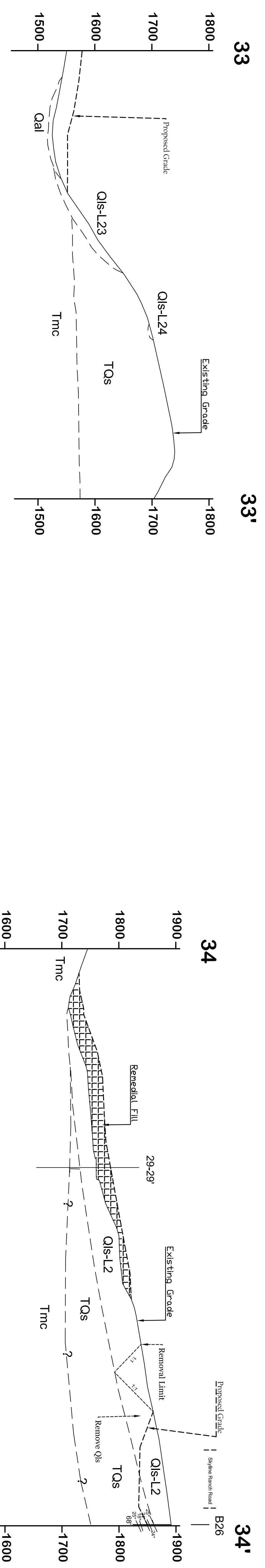
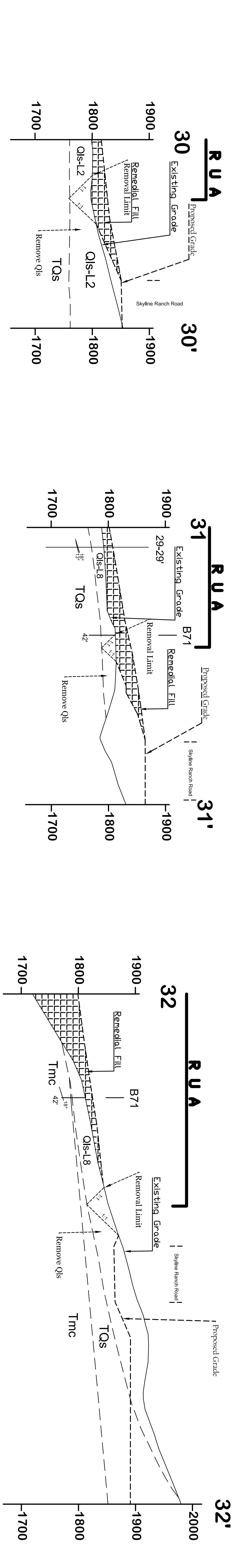
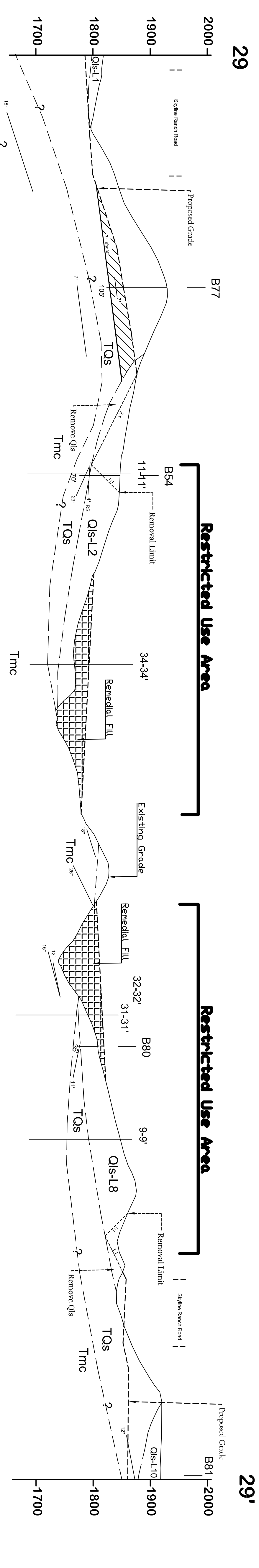
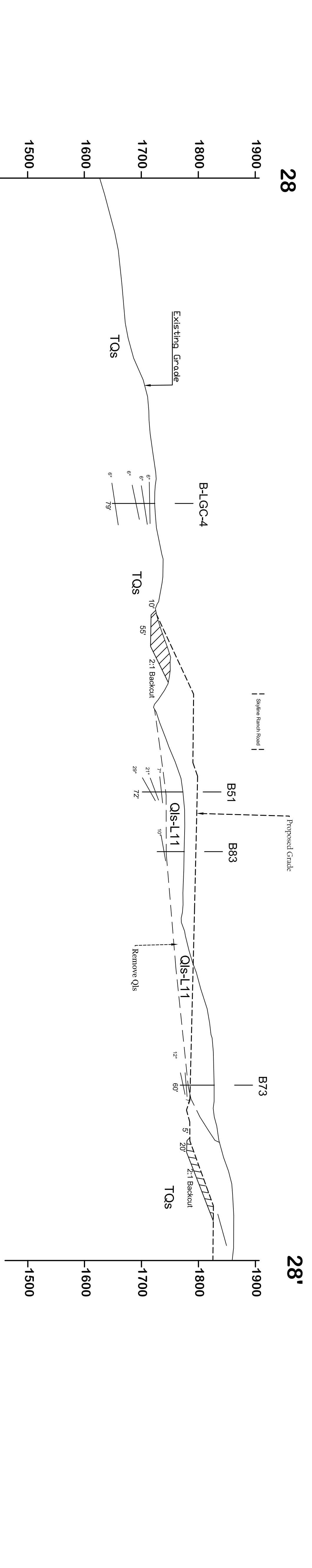

28

29

30

31

32

33

28'

29'

30'

31'

32'

33'

34

34'



LGC Valley, Inc.
28532 Constellation Road
Valencia, CA 91355
TEL. (661) 702-8474 FAX (661) 702-8475

Geologic Cross Sections
28-28' through 34-34'

CLIENT:
Pardee Homes

CIVIL ENGINEER:
SIKAND Engineering

PROJECT NAME	Skyline Ranch
PROJECT NO.	153035-01
ENG. / GEOL.	BH / SMB
SCALE	1" = 100'
DATE	March 2016

PLATE
2f

Appendix B. Traffic Study and Memo

Appendices

This page intentionally left blank.

**Skyline Ranch (Revised VTTM
060922) On-Site Roadway
Analysis**



Prepared for:
TRI Pointe Group

Prepared by:
Stantec Consulting Services Inc.

October 18, 2016

Sign-off Sheet

This document entitled Skyline Ranch (Revised VTTM 060922) On-Site Roadway Analysis was prepared by Stantec Consulting Services Inc. ("Stantec") for the account of TRI Pointe Group (the "Client").

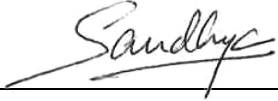
Prepared by 
(signature)

Sandhya Perumalla
(949) 923-6074

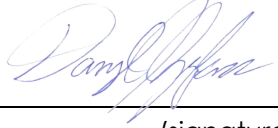
Reviewed by 
(signature)

Daryl Zerfass, PE, PTP
(949) 923-6058

Table of Contents

1.0	INTRODUCTION	1
2.0	TRIP GENERATION	1
3.0	CONCLUSION	10

LIST OF TABLES

Table 1	Land Use and Trip Generation Summary - Current Project.....	3
Table 2	Land Use and Trip Generation Summary - Previously Approved (2008)	3
Table 3	LOS & Delay Summary at Roundabouts.....	8
Table 4	Queue Lengths for Each Leg of Roundabouts	9
Table 5	LOS, Delay & Queue Summary at School and Park.....	9

LIST OF FIGURES

Figure 1	Proposed Conceptual Site Plan	2
Figure 2	Conceptual Striping Exhibit	5
Figure 3	AM Peak Hour Turning Movement Volumes	6
Figure 4	PM Peak Hour Turning Movement Volumes	7
Figure 5	Peak Hour Signal Warrant	8

LIST OF APPENDICES

APPENDIX A	SIDRA WORKSHEETS	A.1
APPENDIX B	SYNCHRO/SIMTRAFFIC WORKSHEET	B.1

SKYLINE RANCH (REVISED VTTM 060922) ON-SITE ROADWAY ANALYSIS

INTRODUCTION

October, 2016

1.0 INTRODUCTION

This report presents the traffic study evaluation of access to the Skyline Ranch (VTTM 060922) development, including a new elementary school intersection. The project is located in the Santa Clarita Valley area of unincorporated Los Angeles County, immediately north of the City of Santa Clarita. More specifically, the project site is located in an undeveloped area generally between Whites Canyon Road/Plum Canyon Road and Sierra Highway. The project is submitting a revised tentative map and this study evaluates an on-site roadway system that has been changed subsequent to the approval of VTTM 060922 in 2008.

The proposed project consists of 1,035 single-family residential units, 165 detached condominium units (for a total of 1,200 residential units), an elementary school and a public park. Figure 1 illustrates the proposed conceptual site plan for the project. The project site is currently vacant with no prior land usage. The site is zoned for residential use and the proposed project is consistent with the land use designations under the Santa Clarita One Valley One Vision (OVOV) Area Plan.

A Traffic Impact Analysis was approved by the County of Los Angeles Department of Public Works in October 2008 for a project description that included slightly more residential units and a different roadway layout on-site.

2.0 TRIP GENERATION

Table 1 summarizes the anticipated trip generation of the proposed project. Vehicle trip generation estimates for the site have been calculated using the Institute of Transportation Engineers (ITE) "Trip Generation" rates for Single Family Residential and the Elementary School, and the LA County trip generation rates have been used for the Townhouse/Condominium uses.

For the residential land use, the proposed project consists of fewer dwelling units than the approved traffic study. The proposed project is forecast to generate a total of approximately 11,173 vehicle trips per day, with 865 occurring in the AM peak hour (661 outbound), and 1,156 occurring in the PM peak hour (730 inbound). In comparison, the projects approved traffic study evaluated 12,154 ADT, 953 AM peak hour trips (711 outbound), and 1,283 PM peak hour trips (813 inbound). See Table 2 for trip generation summary from previously (October 2008) approved land use traffic study. As shown, the revised project generates less traffic than what was approved.



SKYLINE RANCH (REVISED VTTM 060922) ON-SITE ROADWAY ANALYSIS

TRIP GENERATION

October, 2016

Table 1 Land Use and Trip Generation Summary - Current Project

Land Use	Amount	Units	AM Peak Hour			PM Peak Hour			ADT
			IB	OB	Total	IB	OB	Total	
Trip Rates									
Single Family (210)		DU	0.19	0.56	0.75	0.63	0.37	1.00	9.52
Detached Condominium		DU	0.06	0.48	0.54	0.47	0.26	0.73	8.00
Elementary School (520)		STU	0.25	0.20	0.45	--	--	--	1.29
Trip Generation									
Single Family	1035	DU	194	582	776	652	383	1,035	9,853
Detached Condominium	165	DU	10	79	89	78	43	121	1,320
Sub-Total			204	661	865	730	426	1,156	11,173
Elementary School	750	STU	186	152	338	--	--	--	968
Total			390	813	1,203	730	426	1,156	12,141
<p><u>Trip Rate Source:</u> Single Family & Elementary School: Institute of Transportation Engineers (ITE), 9th Edition, 2012. Condominium: Los Angeles County Department of Public Works Traffic Impact Analysis Report Guidelines, 1997.</p> <p><u>Notes:</u> 1. DU - Dwelling Units 2. STU – Students 3. ADT – Average Daily Trips The volume of off-off site elementary school traffic in the PM peak hour was considered negligible in the 2008 traffic study.</p>									

Table 2 Land Use and Trip Generation Summary - Previously Approved (2008)

Land Use	Amount	Units	AM Peak Hour			PM Peak Hour			ADT
			IB	OB	Total	IB	OB	Total	
Trip Rates									
Single Family (210)		DU	0.19	0.56	0.75	0.64	0.37	1.01	9.57
Elementary School (520)		STU	0.23	0.19	0.42	--	--	--	1.29
Trip Generation									
Single Family Residential	1,270	DU	241	711	953	813	470	1,283	12,154
Elementary School	750	STU	173	143	315	--	--	--	968
Total			414	854	1,268	813	470	1,283	13,121
<p><u>Trip Rate Sources:</u> Single Family & Elementary School: Institute of Transportation Engineers (ITE), 7th Edition, 2003.</p> <p><u>Notes:</u> 1. DU - Dwelling Units 2. STU – Students 3. ADT – Average Daily Trips The volume of off-off site elementary school traffic in the PM peak hour was considered negligible in the 2008 traffic study.</p>									

SKYLINE RANCH (REVISED VTTM 060922) ON-SITE ROADWAY ANALYSIS

TRIP GENERATION

October, 2016

Access to the project site will be via a new roadway referred to here as Skyline Ranch Road. The project site has been redesigned such that Skyline Ranch Road is aligned along the west of the proposed project. It provides access to the development through two roundabouts—one on the north end of the development and the other towards the south end of the development—approximately 3,500 feet apart. The use of a single-lane roundabout can be very effective as a traffic management tool. It provides better speed control opportunities and a better safety record than traffic signals.

The elementary school, which will be part of the Sulphur Springs School District, will predominantly serve students from the project site. The access to the school is located approximately 1,100 feet north of the south roundabout. The public park, which is adjacent to the school, has access approximately 600 feet north of the school intersection.

Figure 2 shows a conceptual striping plan for Skyline Ranch Road. See Figure 3 and Figure 4 for AM and PM peak hour turning movements volumes at the site access locations. This traffic analysis evaluates long-range cumulative conditions, which are derived from the Santa Clarita Valley Consolidated Traffic Model (SCVCTM) for a scenario that includes build-out of the area consistent with the OVOV Area Plan.

Initially, four concepts were explored for traffic management at the school in draft reports dated May 17 and July 21, 2016.

1. Full access unsignalized intersection
2. A roundabout at the school entrance
3. A right/left-in and right-out only access at school with a roundabout at the park
4. A right/left-in and right-out only access at school with a U-turn at the park

A fifth alternative was subsequently developed through consultation with the LA County Public Works staff and the findings of that analysis is discussed in this report. This preferred alternative consists of a full access unsignalized intersection at the school with a channelized/dedicated right-turn lane into the school. A dedicated acceleration/merge lane will be provided for the exiting school traffic turning left onto southbound Skyline Ranch Road. A U-turn at the park will also be allowed as a secondary means for traffic to head south on Skyline Ranch Road. County Public Works anticipates prohibiting left-turn into the school during the peak times, preferring instead to have the inbound traffic proceed to the southerly roundabout to make a U-turn and return to the school in the northbound direction and enter as right-turns.

Based on the peak hour signal warrant analysis, a traffic signal is not warranted at the school intersection (see Figure 5 for the peak hour traffic signal warrant analysis). A traffic signal is not recommended for the school entrance due to the close proximity to the south roundabout and because the traffic signal would not meet the minimum volume warrants.

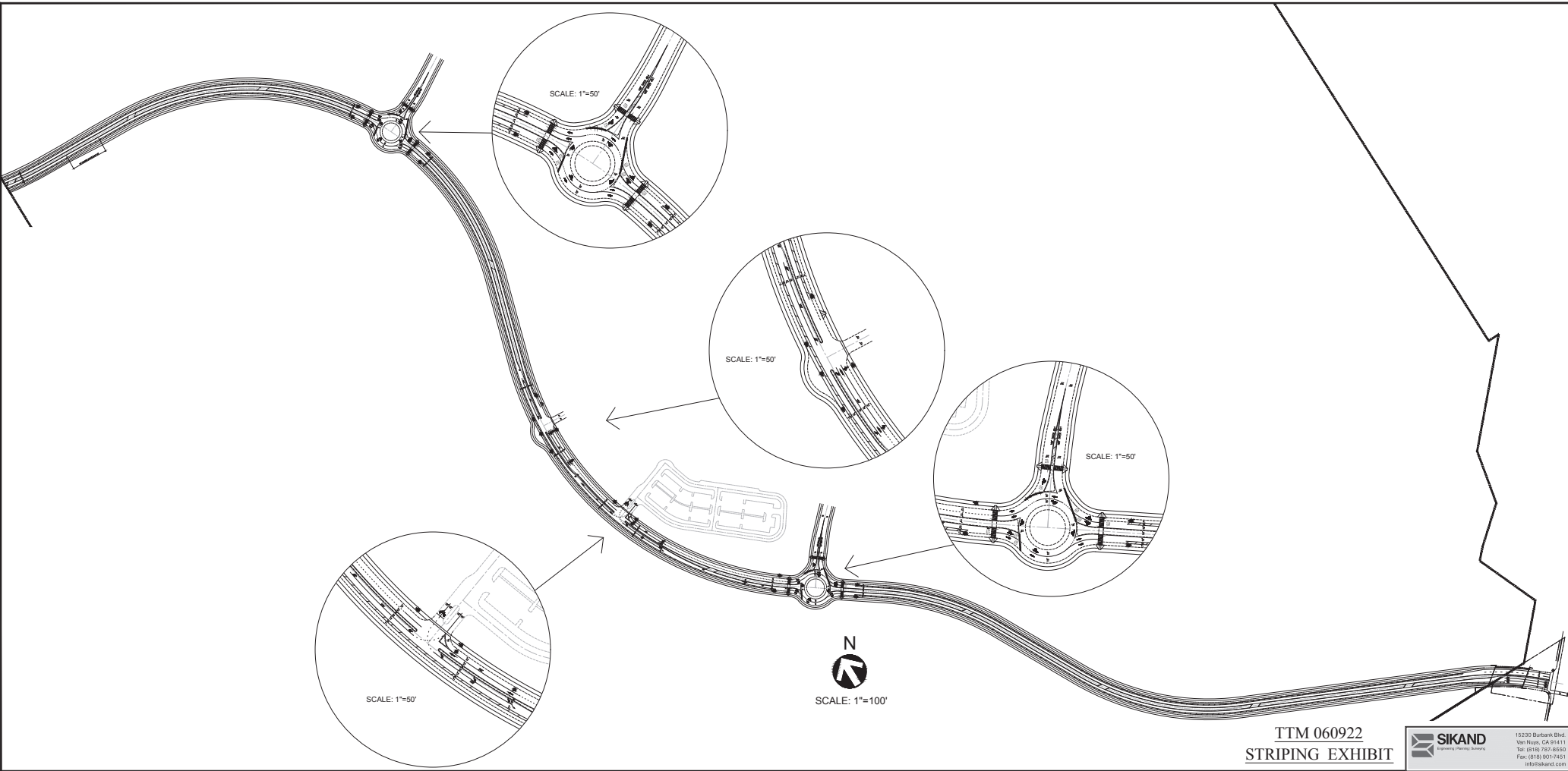

TTM 060922
 STRIPING EXHIBIT



15230 Burbank Blvd
 Van Nuys, CA 91411
 Tel: (818) 782-8850
 Fax: (818) 901-7451
 info@sikand.com

10/20/2016

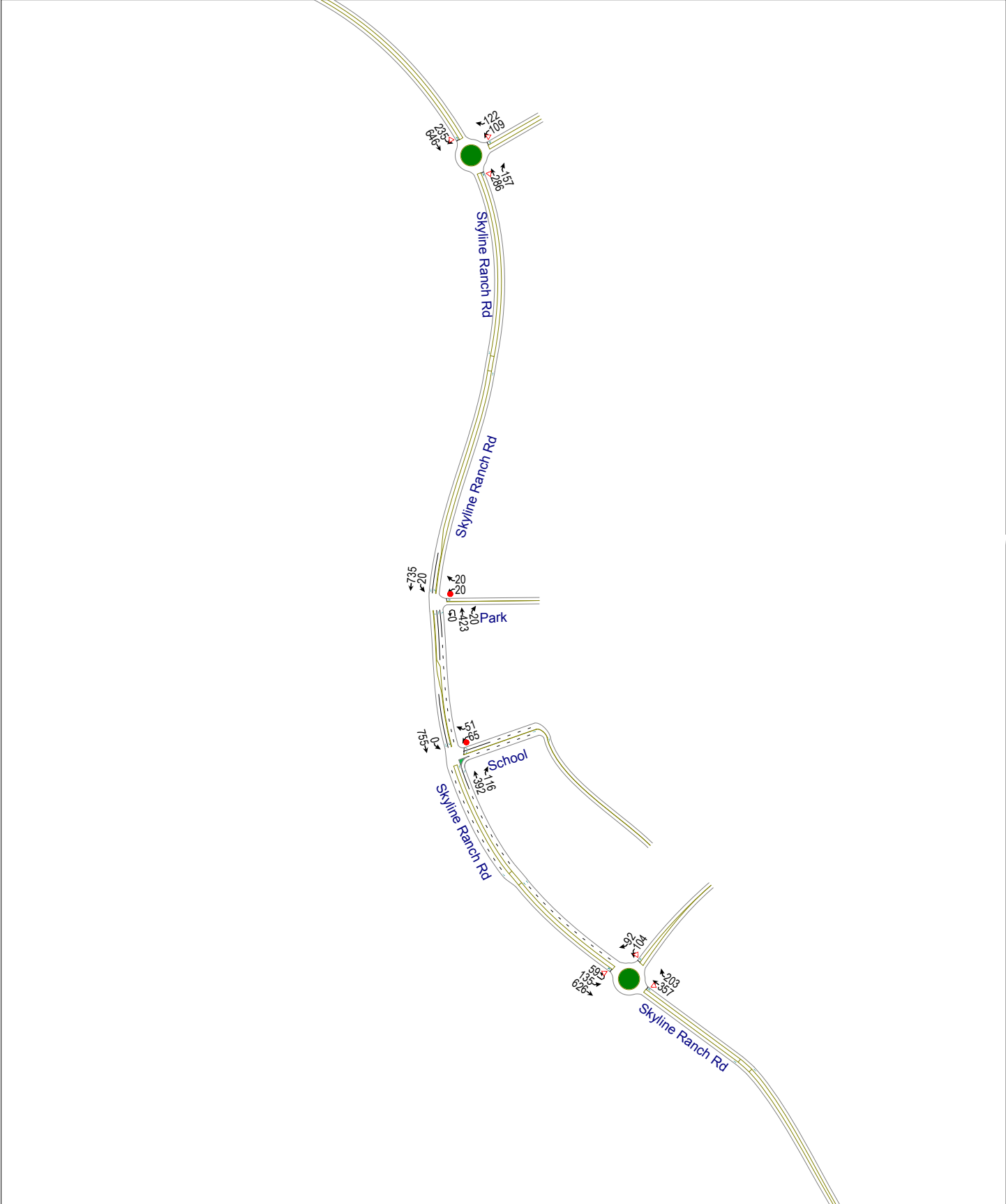

SKYLINE RANCH (REVISED VTTM 060922) ON-SITE ROADWAY ANALYSIS

TRIP GENERATION
October, 2016

Figure 5 Peak Hour Signal Warrant

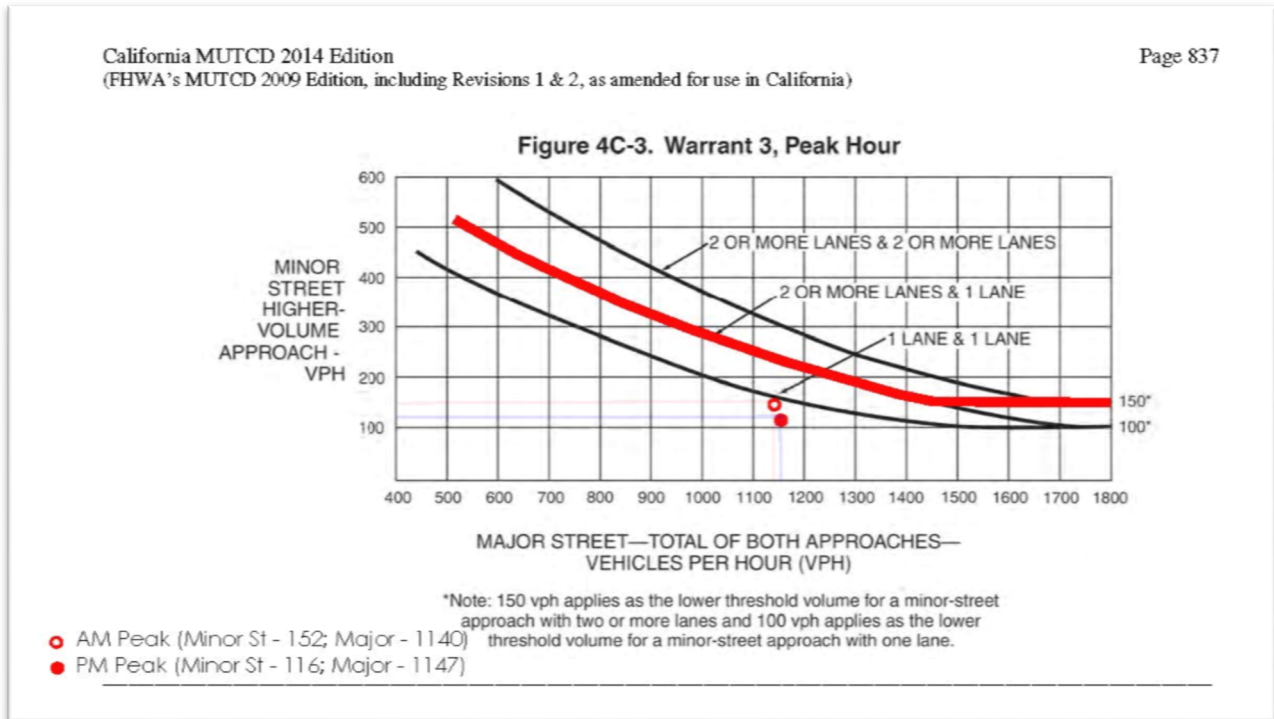

An evaluation of the roundabout concepts has been prepared with SIDRA software. Appendix A contains summary worksheets for the SIDRA analysis. The analysis indicates that both the north and the south roundabouts would operate at good LOS based on a single-lane roundabout configuration, as shown in Table 3, below.

Table 3 LOS & Delay Summary at Roundabouts

Roundabout Locations	AM		PM	
	LOS	Average Delay (sec)	LOS	Average Delay (sec)
Skyline Ranch Rd & North Roundabout	A	9.7	B	13.0
Skyline Ranch Rd & South Roundabout	B	10.6	B	10.4

SKYLINE RANCH (REVISED VTTM 060922) ON-SITE ROADWAY ANALYSIS

TRIP GENERATION

October, 2016

The queue lengths for each leg of the north and south roundabouts on Skyline Ranch Road are shown in Table 4, below

Table 4 Queue Lengths for Each Leg of Roundabouts

	North Roundabout Queue Length (Ft.)		South Roundabout Queue Length (Ft.)	
	AM	PM	AM	PM
South Leg (Skyline Ranch Rd)	85.9	101.1	79.1	118.3
East Leg (Loop Road)	97.7	45.5	66.9	39.5
North Leg (Skyline Ranch Rd)	139.7	277.5	204.7	196.0

To evaluate the operation of the Skyline Ranch Road intersections, a Synchro/SimTraffic simulation model was prepared for Skyline Ranch Road and the north, south, park and school intersections. Worksheets with delay calculations are included in Appendix B.

Simulation results for the school driveway shows that the average vehicle, after dropped off students, would take approximately 24.1 seconds and 12.7 seconds to exit left and right, respectively, out of the school driveway during the AM peak.

The park intersection also provides a convenient location for exiting traffic to make a U-turn and proceed south on Skyline Ranch Road. Table 5 summarizes the lane LOS and approach delay at the school and park intersections during both AM and PM peak. The analysis indicates that the school site access would operate at LOS C or better during both AM & PM peak hour with a maximum queue length of 136 feet during the AM peak.

Table 5 LOS, Delay & Queue Summary at School and Park

Location		AM			PM		
		LOS	Delay (sec)	Queue (95th)	LOS	Delay (sec)	Queue (95th)
Skyline Ranch Rd & School	WBL	C	24.1	136	B	14.2	71
	WBR	B	12.7	52	B	12.6	59
Skyline Ranch Rd & Park	WBL/R	C	20.8	39	C	21.0	43
	SBL	A	8.6	27	A	8.4	21

SKYLINE RANCH (REVISED VTTM 060922) ON-SITE ROADWAY ANALYSIS

CONCLUSION
October, 2016

3.0 CONCLUSION

The revised project consists of fewer dwelling units than the approved traffic study. The revised project is forecast to generate a total of approximately 11,173 vehicle trips per day, with 865 occurring in the AM peak hour (661 outbound), and 1,156 occurring in the PM peak hour (730 inbound). In comparison, the project's approved 2008 traffic study evaluated 12,154 ADT, 953 AM peak hour trips (711 outbound), and 1,283 PM peak hour trips (813 inbound). Therefore, the revised project generates less traffic than what was approved.

An analysis of the proposed roundabouts on Skyline Ranch Road indicates that each would operate acceptably during the peak hours. Specifically, each roundabout would operate at LOS B or better under long-range cumulative conditions.

Through consultation with County Department of Public Works Traffic and Lighting staff, a preferred alternative for the school access driveway was developed. The preferred configuration consists of a full access unsignalized intersection for the school driveway with a channelized/dedicated right-turn lane into the school. A dedicated acceleration/merge lane will be provided for the exiting school traffic turning left onto southbound Skyline Ranch Road. A U-turn at the park will also be allowed as a secondary means for traffic to head south on Skyline Ranch Road. County Public Works anticipates prohibiting left-turn into the school during the peak times, preferring instead to have the inbound traffic proceed to the southerly roundabout to make a U-turn and return to the school in the northbound direction and enter as right-turns.

Given the preferred school driveway configuration described above, the full access unsignalized intersection would result in LOS C conditions with average vehicular delay of 24.1 and 12.7 seconds for exiting left and right turning vehicles, respectively, during the AM peak hour.

A traffic signal is not recommended for the school entrance due to the close proximity to the south roundabout, and because the traffic signal would not meet the minimum volume warrants. A review of pedestrian access routes to the school also indicates that a traffic signal would not be necessary for pedestrian crossings of Skyline Ranch Road at the school driveway since there will be no development on the west side of Skyline Ranch Road (i.e., opposite of the school). Pedestrians will access the school from the neighborhood trail system that connects directly to the school site and from Skyline Ranch Road via sidewalks along the school frontage that connect to the site's internal roadway system.

SKYLINE RANCH (REVISED VTTM 060922) ON-SITE ROADWAY ANALYSIS

Appendix A Sidra Worksheets
October, 2016

Appendix A SIDRA WORKSHEETS

LEVEL OF SERVICE

Site: SkylineRanchRd-North - AM

New Site
Roundabout

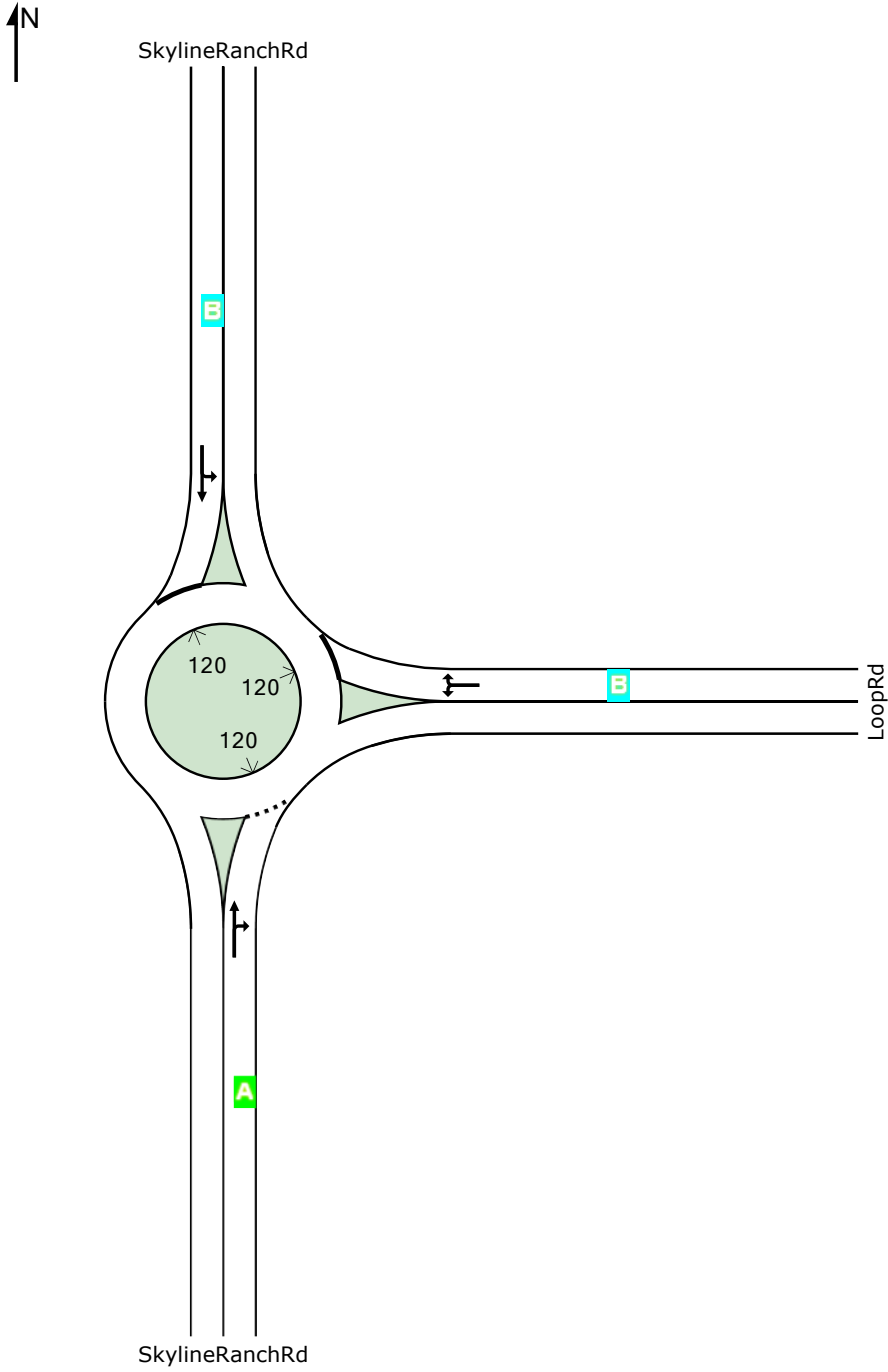

	South	East	North	Intersection
LOS	A	B	B	A

Level of Service (LOS) Method: Delay & v/c (HCM 2010).
 Roundabout LOS Method: Same as Signalised Intersections.
 Lane LOS values are based on average delay and v/c ratio (degree of saturation) per lane.
 LOS F will result if v/c > irrespective of lane delay value (does not apply for approaches and intersection).

INTERSECTION SUMMARY

 Site: SkylineRanchRd-North - AM

New Site
Roundabout

Intersection Performance - Hourly Values		
Performance Measure	Vehicles	Persons
Demand Flows (Total)	1558 veh/h	1869 pers/h
Percent Heavy Vehicles (Demand)	3.0 %	
Degree of Saturation	0.588	
Practical Spare Capacity	44.5 %	
Effective Intersection Capacity	2648 veh/h	
Control Delay (Total)	4.21 veh-h/h	5.05 pers-h/h
Control Delay (Average)	9.7 sec	9.7 sec
Control Delay (Worst Lane)	11.6 sec	
Control Delay (Worst Movement)	11.6 sec	11.6 sec
Geometric Delay (Average)	0.0 sec	
Stop-Line Delay (Average)	9.7 sec	
Idling Time (Average)	6.1 sec	
Intersection Level of Service (LOS)	LOS A	
95% Back of Queue - Vehicles (Worst Lane)	5.5 veh	
95% Back of Queue - Distance (Worst Lane)	139.7 ft	
Queue Storage Ratio (Worst Lane)	0.09	
Total Effective Stops	660 veh/h	792 pers/h
Effective Stop Rate	0.42 per veh	0.42 per pers
Proportion Queued	0.58	0.58
Performance Index	49.5	49.5
Travel Distance (Total)	721.2 veh-mi/h	865.5 pers-mi/h
Travel Distance (Average)	2445 ft	2445 ft
Travel Time (Total)	27.6 veh-h/h	33.2 pers-h/h
Travel Time (Average)	63.9 sec	63.9 sec
Travel Speed	26.1 mph	26.1 mph
Cost (Total)	459.57 \$/h	459.57 \$/h
Fuel Consumption (Total)	18.2 gal/h	
Carbon Dioxide (Total)	162.8 kg/h	
Hydrocarbons (Total)	0.070 kg/h	
Carbon Monoxide (Total)	0.535 kg/h	
NOx (Total)	0.297 kg/h	

Level of Service (LOS) Method: Delay & v/c (HCM 2010).

Roundabout LOS Method: Same as Signalised Intersections.

Intersection LOS value for Vehicles is based on average delay for all vehicle movements.

Roundabout Capacity Model: SIDRA Standard.

HCM Delay Formula option is used. Control Delay does not include Geometric Delay since Exclude Geometric Delay option applies.

Intersection Performance - Annual Values		
Performance Measure	Vehicles	Persons
Demand Flows (Total)	747,652 veh/y	897,183 pers/y
Delay	2,019 veh-h/y	2,423 pers-h/y
Effective Stops	316,667 veh/y	380,000 pers/y
Travel Distance	346,188 veh-mi/y	415,425 pers-mi/y
Travel Time	13,261 veh-h/y	15,913 pers-h/y
Cost	220,593 \$/y	220,593 \$/y
Fuel Consumption	8,752 gal/y	
Carbon Dioxide	78,134 kg/y	
Hydrocarbons	33 kg/y	
Carbon Monoxide	257 kg/y	
NOx	142 kg/y	

MOVEMENT SUMMARY

 Site: SkylineRanchRd-North - AM

New Site
Roundabout

Movement Performance - Vehicles											
Mov ID	OD Mov	Demand Flows Total veh/h	Flows HV %	Deg. Satn v/c	Average Delay sec	Level of Service	95% Back of Queue Vehicles veh	Queue Distance ft	Prop. Queued	Effective Stop Rate per veh	Average Speed mph
South: SkylineRanchRd											
8	T1	483	3.0	0.416	6.9	LOS A	3.4	85.9	0.35	0.33	22.4
18	R2	50	3.0	0.416	6.9	LOS A	3.4	85.9	0.35	0.33	22.4
Approach		533	3.0	0.416	6.9	LOS A	3.4	85.9	0.35	0.16	22.4
East: LoopRd											
1	L2	184	3.0	0.500	11.6	LOS B	3.8	97.7	0.77	1.46	27.2
16	R2	207	3.0	0.500	11.6	LOS B	3.8	97.7	0.77	1.46	27.2
Approach		390	3.0	0.500	11.6	LOS B	3.8	97.7	0.77	0.73	27.2
North: SkylineRanchRd											
7	L2	74	3.0	0.588	10.9	LOS B	5.5	139.7	0.66	0.90	28.8
4	T1	561	3.0	0.588	10.9	LOS B	5.5	139.7	0.66	0.90	28.8
Approach		635	3.0	0.588	10.9	LOS B	5.5	139.7	0.66	0.45	28.8
All Vehicles		1558	3.0	0.588	9.7	LOS A	5.5	139.7	0.58	0.42	26.1

Level of Service (LOS) Method: Delay & v/c (HCM 2010).

Roundabout LOS Method: Same as Signalised Intersections.

Vehicle movement LOS values are based on average delay and v/c ratio (degree of saturation) per movement

LOS F will result if v/c > 1 irrespective of movement delay value (does not apply for approaches and intersection).

Intersection and Approach LOS values are based on average delay for all movements (v/c not used as specified in HCM 2010).

Roundabout Capacity Model: SIDRA Standard.

HCM Delay Formula option is used. Control Delay does not include Geometric Delay since Exclude Geometric Delay option applies.

Gap-Acceptance Capacity: SIDRA Standard (Akçelik M3D).

HV (%) values are calculated for All Movement Classes of All Heavy Vehicle Model Designation.

Processed: Friday, March 18, 2016 2:35:14 PM
SIDRA INTERSECTION 6.0.11.3995

Project: C:\Users\sperumalla\Documents\SkylineRanch.sip6
8001309, STANTEC CONSULTING SVCS INC, PLUS / 1PC

Copyright © 2000-2013 Akcelik and Associates Pty Ltd
www.sidrasolutions.com

**SIDRA
INTERSECTION 6**

LEVEL OF SERVICE

Site: SkylineRanchRd-North - PM

New Site
Roundabout

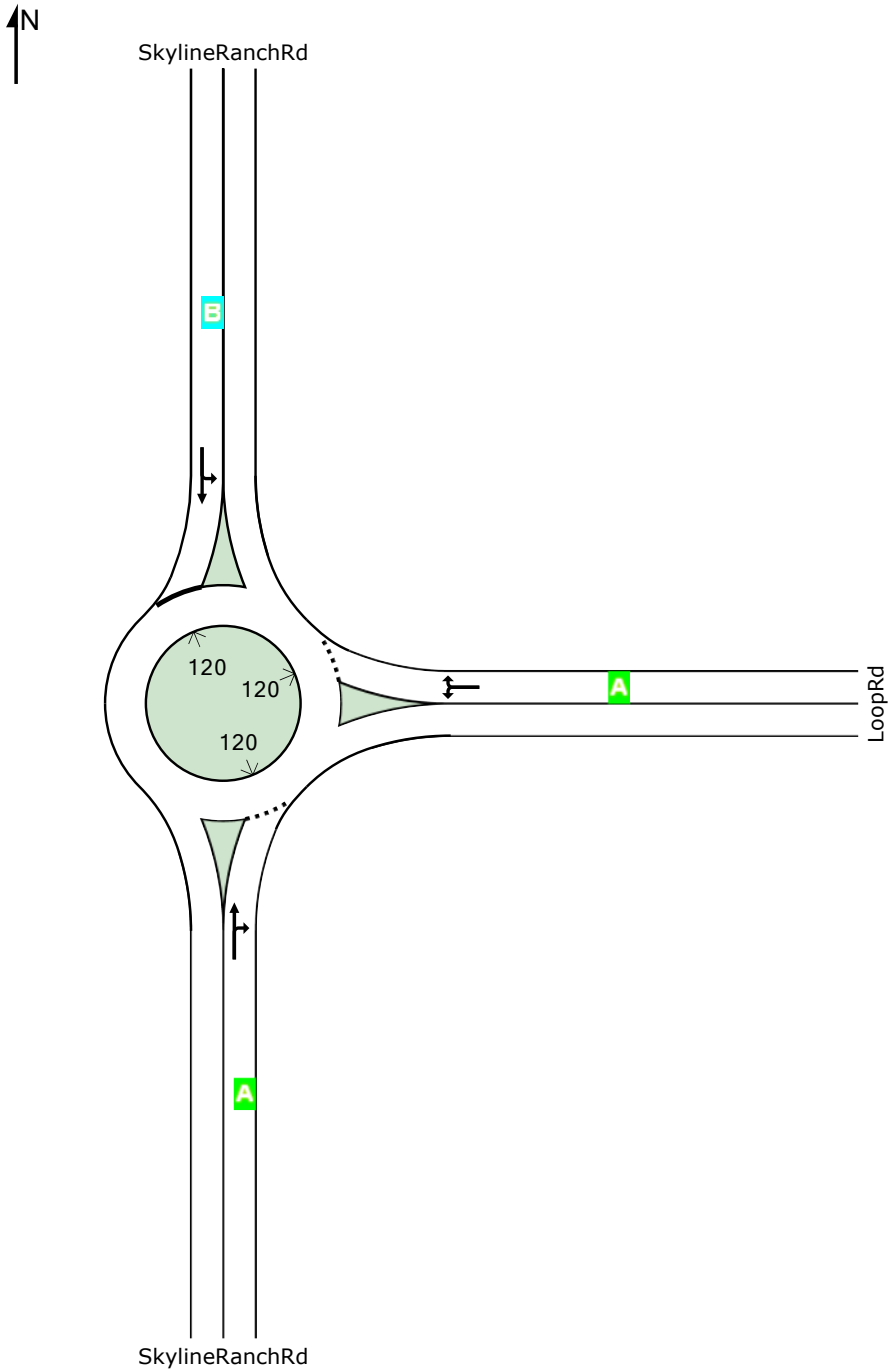

	South	East	North	Intersection
LOS	A	A	B	B

Level of Service (LOS) Method: Delay & v/c (HCM 2010).

Roundabout LOS Method: Same as Signalised Intersections.

Lane LOS values are based on average delay and v/c ratio (degree of saturation) per lane.

LOS F will result if v/c > irrespective of lane delay value (does not apply for approaches and intersection).

INTERSECTION SUMMARY

 Site: SkylineRanchRd-North - PM

New Site
Roundabout

Intersection Performance - Hourly Values		
Performance Measure	Vehicles	Persons
Demand Flows (Total)	1692 veh/h	2031 pers/h
Percent Heavy Vehicles (Demand)	3.0 %	
Degree of Saturation	0.778	
Practical Spare Capacity	9.3 %	
Effective Intersection Capacity	2176 veh/h	
Control Delay (Total)	6.13 veh-h/h	7.35 pers-h/h
Control Delay (Average)	13.0 sec	13.0 sec
Control Delay (Worst Lane)	16.2 sec	
Control Delay (Worst Movement)	16.2 sec	16.2 sec
Geometric Delay (Average)	0.0 sec	
Stop-Line Delay (Average)	13.0 sec	
Idling Time (Average)	8.9 sec	
Intersection Level of Service (LOS)	LOS B	
95% Back of Queue - Vehicles (Worst Lane)	10.8 veh	
95% Back of Queue - Distance (Worst Lane)	277.5 ft	
Queue Storage Ratio (Worst Lane)	0.18	
Total Effective Stops	792 veh/h	951 pers/h
Effective Stop Rate	0.47 per veh	0.47 per pers
Proportion Queued	0.70	0.70
Performance Index	60.0	60.0
Travel Distance (Total)	793.7 veh-mi/h	952.5 pers-mi/h
Travel Distance (Average)	2476 ft	2476 ft
Travel Time (Total)	31.6 veh-h/h	37.9 pers-h/h
Travel Time (Average)	67.2 sec	67.2 sec
Travel Speed	25.1 mph	25.1 mph
Cost (Total)	523.83 \$/h	523.83 \$/h
Fuel Consumption (Total)	20.6 gal/h	
Carbon Dioxide (Total)	183.9 kg/h	
Hydrocarbons (Total)	0.080 kg/h	
Carbon Monoxide (Total)	0.603 kg/h	
NOx (Total)	0.337 kg/h	

Level of Service (LOS) Method: Delay & v/c (HCM 2010).

Roundabout LOS Method: Same as Signalised Intersections.

Intersection LOS value for Vehicles is based on average delay for all vehicle movements.

Roundabout Capacity Model: SIDRA Standard.

HCM Delay Formula option is used. Control Delay does not include Geometric Delay since Exclude Geometric Delay option applies.

Intersection Performance - Annual Values		
Performance Measure	Vehicles	Persons
Demand Flows (Total)	812,348 veh/y	974,817 pers/y
Delay	2,941 veh-h/y	3,529 pers-h/y
Effective Stops	380,326 veh/y	456,392 pers/y
Travel Distance	380,999 veh-mi/y	457,199 pers-mi/y
Travel Time	15,160 veh-h/y	18,192 pers-h/y
Cost	251,437 \$/y	251,437 \$/y
Fuel Consumption	9,885 gal/y	
Carbon Dioxide	88,248 kg/y	
Hydrocarbons	38 kg/y	
Carbon Monoxide	289 kg/y	
NOx	162 kg/y	

MOVEMENT SUMMARY

 Site: SkylineRanchRd-North - PM

New Site
Roundabout

Movement Performance - Vehicles											
Mov ID	OD Mov	Demand Flows Total veh/h	Flows HV %	Deg. Satn v/c	Average Delay sec	Level of Service	95% Back of Queue Vehicles veh	Queue Distance ft	Prop. Queued	Effective Stop Rate per veh	Average Speed mph
South: SkylineRanchRd											
8	T1	312	3.0	0.501	9.9	LOS A	3.9	101.1	0.67	1.02	21.3
18	R2	171	3.0	0.501	9.9	LOS A	3.9	101.1	0.67	1.02	21.3
Approach		483	3.0	0.501	9.9	LOS A	3.9	101.1	0.67	0.51	21.3
East: LoopRd											
1	L2	118	3.0	0.283	7.1	LOS A	1.8	45.5	0.59	0.91	29.2
16	R2	133	3.0	0.283	7.1	LOS A	1.8	45.5	0.59	0.91	29.2
Approach		251	3.0	0.283	7.1	LOS A	1.8	45.5	0.59	0.46	29.2
North: SkylineRanchRd											
7	L2	255	3.0	0.778	16.2	LOS B	10.8	277.5	0.75	0.90	26.1
4	T1	703	3.0	0.778	16.2	LOS B	10.8	277.5	0.75	0.90	26.1
Approach		959	3.0	0.778	16.2	LOS B	10.8	277.5	0.75	0.45	26.1
All Vehicles		1692	3.0	0.778	13.0	LOS B	10.8	277.5	0.70	0.47	25.1

Level of Service (LOS) Method: Delay & v/c (HCM 2010).

Roundabout LOS Method: Same as Signalised Intersections.

Vehicle movement LOS values are based on average delay and v/c ratio (degree of saturation) per movement

LOS F will result if v/c > 1 irrespective of movement delay value (does not apply for approaches and intersection).

Intersection and Approach LOS values are based on average delay for all movements (v/c not used as specified in HCM 2010).

Roundabout Capacity Model: SIDRA Standard.

HCM Delay Formula option is used. Control Delay does not include Geometric Delay since Exclude Geometric Delay option applies.

Gap-Acceptance Capacity: SIDRA Standard (Akçelik M3D).

HV (%) values are calculated for All Movement Classes of All Heavy Vehicle Model Designation.

Processed: Friday, March 18, 2016 6:08:57 PM
SIDRA INTERSECTION 6.0.11.3995

Copyright © 2000-2013 Akcelik and Associates Pty Ltd
www.sidrasolutions.com

Project: C:\Users\sperumalla\Documents\SkylineRanch_PM.sip6
8001309, STANTEC CONSULTING SVCS INC, PLUS / 1PC

**SIDRA
INTERSECTION 6**

LEVEL OF SERVICE

Site: SkylineRanchRd-South - AM

New Site
Roundabout

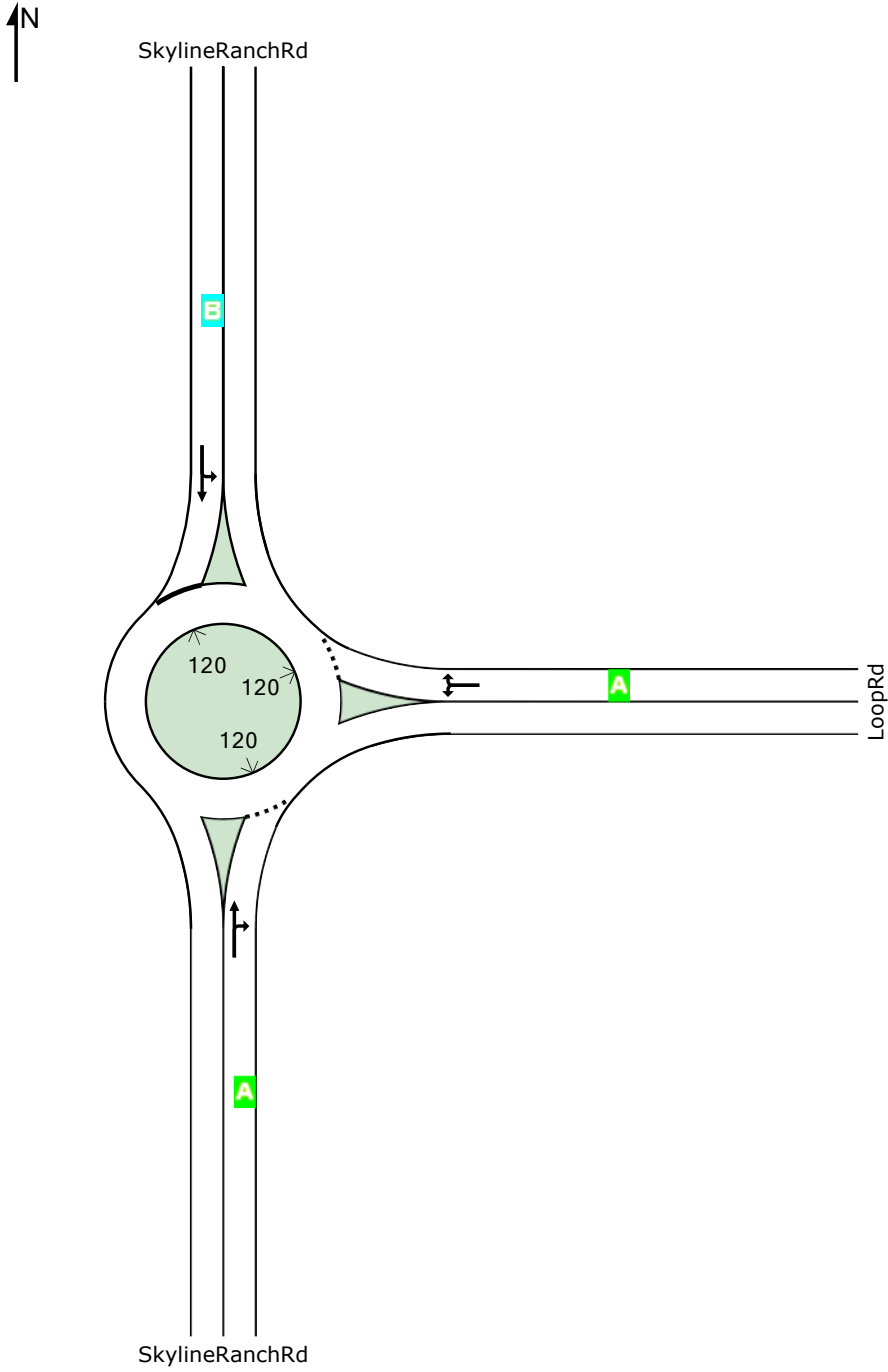

	South	East	North	Intersection
LOS	A	A	B	B

Level of Service (LOS) Method: Delay & v/c (HCM 2010).
 Roundabout LOS Method: Same as Signalised Intersections.
 Lane LOS values are based on average delay and v/c ratio (degree of saturation) per lane.
 LOS F will result if v/c > irrespective of lane delay value (does not apply for approaches and intersection).

INTERSECTION SUMMARY

 Site: SkylineRanchRd-South - AM

New Site
Roundabout

Intersection Performance - Hourly Values		
Performance Measure	Vehicles	Persons
Demand Flows (Total)	1632 veh/h	1958 pers/h
Percent Heavy Vehicles (Demand)	3.0 %	
Degree of Saturation	0.701	
Practical Spare Capacity	21.2 %	
Effective Intersection Capacity	2326 veh/h	
Control Delay (Total)	4.79 veh-h/h	5.74 pers-h/h
Control Delay (Average)	10.6 sec	10.6 sec
Control Delay (Worst Lane)	14.0 sec	
Control Delay (Worst Movement)	14.0 sec	14.0 sec
Geometric Delay (Average)	0.0 sec	
Stop-Line Delay (Average)	10.6 sec	
Idling Time (Average)	6.9 sec	
Intersection Level of Service (LOS)	LOS B	
95% Back of Queue - Vehicles (Worst Lane)	8.0 veh	
95% Back of Queue - Distance (Worst Lane)	204.7 ft	
Queue Storage Ratio (Worst Lane)	0.14	
Total Effective Stops	658 veh/h	790 pers/h
Effective Stop Rate	0.40 per veh	0.40 per pers
Proportion Queued	0.58	0.58
Performance Index	52.6	52.6
Travel Distance (Total)	755.5 veh-mi/h	906.6 pers-mi/h
Travel Distance (Average)	2445 ft	2445 ft
Travel Time (Total)	29.0 veh-h/h	34.8 pers-h/h
Travel Time (Average)	64.0 sec	64.0 sec
Travel Speed	26.1 mph	26.1 mph
Cost (Total)	482.89 \$/h	482.89 \$/h
Fuel Consumption (Total)	19.2 gal/h	
Carbon Dioxide (Total)	171.3 kg/h	
Hydrocarbons (Total)	0.073 kg/h	
Carbon Monoxide (Total)	0.561 kg/h	
NOx (Total)	0.315 kg/h	

Level of Service (LOS) Method: Delay & v/c (HCM 2010).

Roundabout LOS Method: Same as Signalised Intersections.

Intersection LOS value for Vehicles is based on average delay for all vehicle movements.

Roundabout Capacity Model: SIDRA Standard.

HCM Delay Formula option is used. Control Delay does not include Geometric Delay since Exclude Geometric Delay option applies.

Intersection Performance - Annual Values		
Performance Measure	Vehicles	Persons
Demand Flows (Total)	783,130 veh/y	939,757 pers/y
Delay	2,298 veh-h/y	2,757 pers-h/y
Effective Stops	315,829 veh/y	378,994 pers/y
Travel Distance	362,626 veh-mi/y	435,151 pers-mi/y
Travel Time	13,918 veh-h/y	16,702 pers-h/y
Cost	231,787 \$/y	231,787 \$/y
Fuel Consumption	9,208 gal/y	
Carbon Dioxide	82,212 kg/y	
Hydrocarbons	35 kg/y	
Carbon Monoxide	269 kg/y	
NOx	151 kg/y	

MOVEMENT SUMMARY

 Site: SkylineRanchRd-South - AM

New Site
Roundabout

Movement Performance - Vehicles											
Mov ID	OD Mov	Demand Flows Total veh/h	Flows HV %	Deg. Satn v/c	Average Delay sec	Level of Service	95% Back of Queue Vehicles veh	Queue Distance ft	Prop. Queued	Effective Stop Rate per veh	Average Speed mph
South: SkylineRanchRd											
8	T1	461	3.0	0.379	6.1	LOS A	3.1	79.1	0.25	0.18	22.6
18	R2	61	3.0	0.379	6.1	LOS A	3.1	79.1	0.25	0.18	22.6
Approach		522	3.0	0.379	6.1	LOS A	3.1	79.1	0.25	0.09	22.6
East: LoopRd											
1	L2	175	3.0	0.410	9.6	LOS A	2.6	66.9	0.70	1.24	27.9
16	R2	155	3.0	0.410	9.6	LOS A	2.6	66.9	0.70	1.24	27.9
Approach		330	3.0	0.410	9.6	LOS A	2.6	66.9	0.70	0.62	27.9
North: SkylineRanchRd											
7	L2	41	3.0	0.701	14.0	LOS B	8.0	204.7	0.75	1.04	27.6
4	T1	738	3.0	0.701	14.0	LOS B	8.0	204.7	0.75	1.04	27.6
Approach		779	3.0	0.701	14.0	LOS B	8.0	204.7	0.75	0.52	27.6
All Vehicles		1632	3.0	0.701	10.6	LOS B	8.0	204.7	0.58	0.40	26.1

Level of Service (LOS) Method: Delay & v/c (HCM 2010).

Roundabout LOS Method: Same as Signalised Intersections.

Vehicle movement LOS values are based on average delay and v/c ratio (degree of saturation) per movement

LOS F will result if v/c > 1 irrespective of movement delay value (does not apply for approaches and intersection).

Intersection and Approach LOS values are based on average delay for all movements (v/c not used as specified in HCM 2010).

Roundabout Capacity Model: SIDRA Standard.

HCM Delay Formula option is used. Control Delay does not include Geometric Delay since Exclude Geometric Delay option applies.

Gap-Acceptance Capacity: SIDRA Standard (Akçelik M3D).

HV (%) values are calculated for All Movement Classes of All Heavy Vehicle Model Designation.

Processed: Friday, March 18, 2016 2:33:27 PM
SIDRA INTERSECTION 6.0.11.3995

Project: C:\Users\sperumalla\Documents\SkylineRanch.sip6
8001309, STANTEC CONSULTING SVCS INC, PLUS / 1PC

Copyright © 2000-2013 Akcelik and Associates Pty Ltd
www.sidrasolutions.com

**SIDRA
INTERSECTION 6**

LEVEL OF SERVICE

Site: SkylineRanchRd-South - PM

New Site
Roundabout

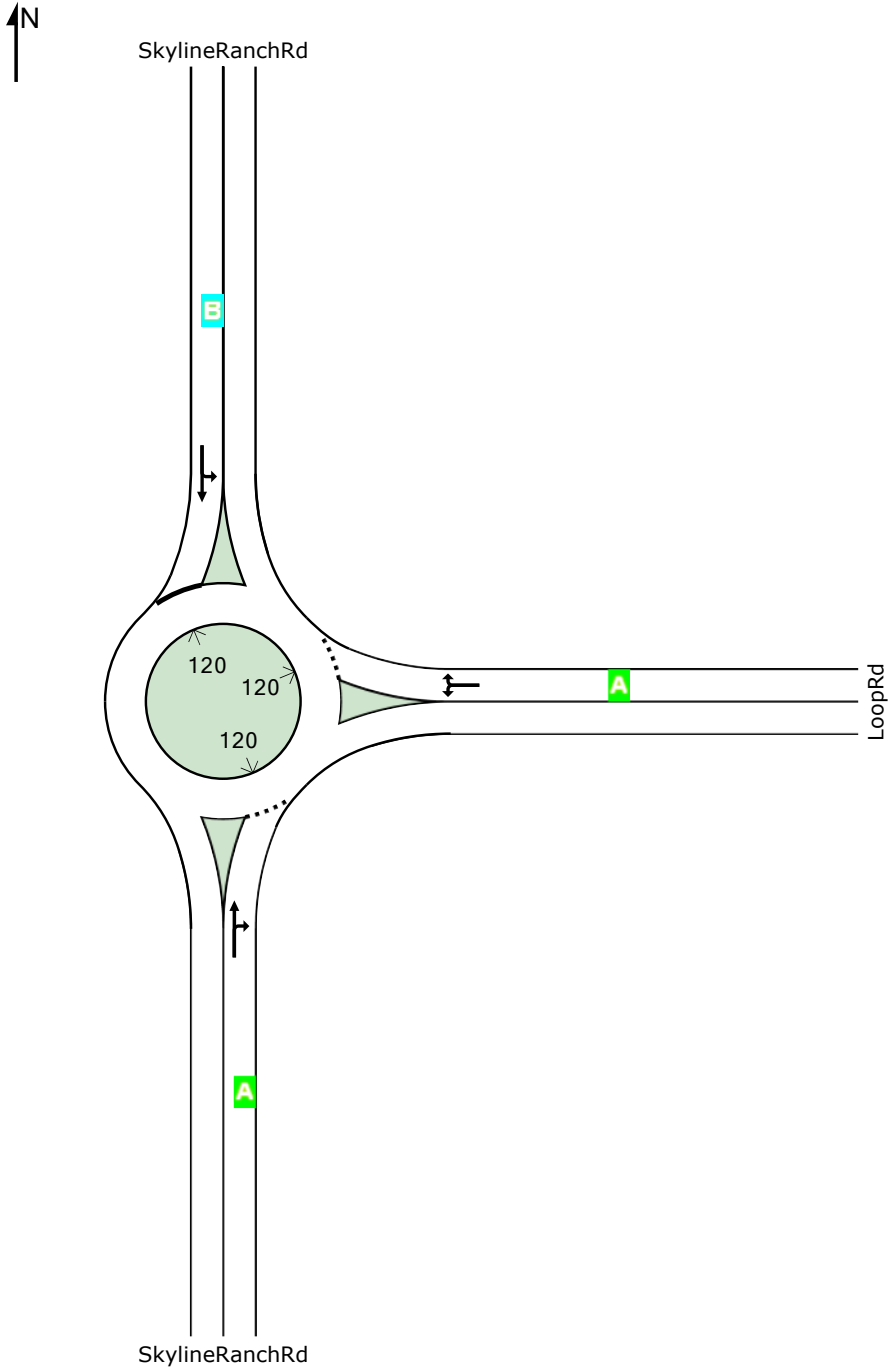

	South	East	North	Intersection
LOS	A	A	B	B

Level of Service (LOS) Method: Delay & v/c (HCM 2010).
 Roundabout LOS Method: Same as Signalised Intersections.
 Lane LOS values are based on average delay and v/c ratio (degree of saturation) per lane.
 LOS F will result if v/c > irrespective of lane delay value (does not apply for approaches and intersection).

INTERSECTION SUMMARY

 Site: SkylineRanchRd-South - PM

New Site
Roundabout

Intersection Performance - Hourly Values		
Performance Measure	Vehicles	Persons
Demand Flows (Total)	1650 veh/h	1980 pers/h
Percent Heavy Vehicles (Demand)	3.0 %	
Degree of Saturation	0.673	
Practical Spare Capacity	26.2 %	
Effective Intersection Capacity	2451 veh/h	
Control Delay (Total)	4.78 veh-h/h	5.74 pers-h/h
Control Delay (Average)	10.4 sec	10.4 sec
Control Delay (Worst Lane)	12.1 sec	
Control Delay (Worst Movement)	12.1 sec	12.1 sec
Geometric Delay (Average)	0.0 sec	
Stop-Line Delay (Average)	10.4 sec	
Idling Time (Average)	6.8 sec	
Intersection Level of Service (LOS)	LOS B	
95% Back of Queue - Vehicles (Worst Lane)	7.7 veh	
95% Back of Queue - Distance (Worst Lane)	196.0 ft	
Queue Storage Ratio (Worst Lane)	0.13	
Total Effective Stops	609 veh/h	731 pers/h
Effective Stop Rate	0.37 per veh	0.37 per pers
Proportion Queued	0.59	0.59
Performance Index	53.1	53.1
Travel Distance (Total)	759.9 veh-mi/h	911.9 pers-mi/h
Travel Distance (Average)	2432 ft	2432 ft
Travel Time (Total)	29.7 veh-h/h	35.6 pers-h/h
Travel Time (Average)	64.7 sec	64.7 sec
Travel Speed	25.6 mph	25.6 mph
Cost (Total)	491.09 \$/h	491.09 \$/h
Fuel Consumption (Total)	19.3 gal/h	
Carbon Dioxide (Total)	172.5 kg/h	
Hydrocarbons (Total)	0.075 kg/h	
Carbon Monoxide (Total)	0.568 kg/h	
NOx (Total)	0.310 kg/h	

Level of Service (LOS) Method: Delay & v/c (HCM 2010).

Roundabout LOS Method: Same as Signalised Intersections.

Intersection LOS value for Vehicles is based on average delay for all vehicle movements.

Roundabout Capacity Model: SIDRA Standard.

HCM Delay Formula option is used. Control Delay does not include Geometric Delay since Exclude Geometric Delay option applies.

Intersection Performance - Annual Values		
Performance Measure	Vehicles	Persons
Demand Flows (Total)	792,000 veh/y	950,400 pers/y
Delay	2,294 veh-h/y	2,753 pers-h/y
Effective Stops	292,223 veh/y	350,668 pers/y
Travel Distance	364,752 veh-mi/y	437,702 pers-mi/y
Travel Time	14,237 veh-h/y	17,084 pers-h/y
Cost	235,725 \$/y	235,725 \$/y
Fuel Consumption	9,274 gal/y	
Carbon Dioxide	82,799 kg/y	
Hydrocarbons	36 kg/y	
Carbon Monoxide	273 kg/y	
NOx	149 kg/y	

MOVEMENT SUMMARY

 Site: SkylineRanchRd-South - PM

New Site
Roundabout

Movement Performance - Vehicles											
Mov ID	OD Mov	Demand Flows Total veh/h	Flows HV %	Deg. Satn v/c	Average Delay sec	Level of Service	95% Back of Queue Vehicles veh	Queue Distance ft	Prop. Queued	Effective Stop Rate per veh	Average Speed mph
South: SkylineRanchRd											
8	T1	388	3.0	0.532	9.3	LOS A	4.6	118.3	0.55	0.69	21.5
18	R2	221	3.0	0.532	9.3	LOS A	4.6	118.3	0.55	0.69	21.5
Approach		609	3.0	0.532	9.3	LOS A	4.6	118.3	0.55	0.34	21.5
East: LoopRd											
1	L2	113	3.0	0.256	7.1	LOS A	1.5	39.5	0.62	1.01	29.0
16	R2	100	3.0	0.256	7.1	LOS A	1.5	39.5	0.62	1.01	29.0
Approach		213	3.0	0.256	7.1	LOS A	1.5	39.5	0.62	0.50	29.0
North: SkylineRanchRd											
7	L2	147	3.0	0.673	12.1	LOS B	7.7	196.0	0.61	0.71	28.1
4	T1	682	3.0	0.673	12.1	LOS B	7.7	196.0	0.61	0.71	28.1
Approach		828	3.0	0.673	12.1	LOS B	7.7	196.0	0.61	0.35	28.1
All Vehicles		1650	3.0	0.673	10.4	LOS B	7.7	196.0	0.59	0.37	25.6

Level of Service (LOS) Method: Delay & v/c (HCM 2010).

Roundabout LOS Method: Same as Signalised Intersections.

Vehicle movement LOS values are based on average delay and v/c ratio (degree of saturation) per movement

LOS F will result if v/c > 1 irrespective of movement delay value (does not apply for approaches and intersection).

Intersection and Approach LOS values are based on average delay for all movements (v/c not used as specified in HCM 2010).

Roundabout Capacity Model: SIDRA Standard.

HCM Delay Formula option is used. Control Delay does not include Geometric Delay since Exclude Geometric Delay option applies.

Gap-Acceptance Capacity: SIDRA Standard (Akçelik M3D).

HV (%) values are calculated for All Movement Classes of All Heavy Vehicle Model Designation.

Processed: Friday, March 18, 2016 6:11:31 PM

SIDRA INTERSECTION 6.0.11.3995

Project: C:\Users\sperumalla\Documents\SkylineRanch_PM.sip6

8001309, STANTEC CONSULTING SVCS INC, PLUS / 1PC

Copyright © 2000-2013 Akcelik and Associates Pty Ltd











www.sidrasolutions.com

**SIDRA
INTERSECTION 6**













SKYLINE RANCH (REVISED VTTM 060922) ON-SITE ROADWAY ANALYSIS











Appendix B Synchro/SimTraffic Worksheet
October, 2016

Appendix B SYNCHRO/SIMTRAFFIC WORKSHEET













						
Movement	WBL	WBR	NBT	NBR	SBL	SBT
Lane Configurations						
Traffic Volume (veh/h)	117	35	455	186	0	0 (1)
Future Volume (Veh/h)	117	35	455	186	0	0
Sign Control	Stop		Free		Free	
Grade	0%		0%		0%	
Peak Hour Factor	0.33	0.33	0.92	0.33	0.33	0.92
Hourly flow rate (vph)	355	106	495	564	0	0
Pedestrians						
Lane Width (ft)						
Walking Speed (ft/s)						
Percent Blockage						
Right turn flare (veh)						
Median type			None		None	
Median storage (veh)						
Upstream signal (ft)						
pX, platoon unblocked						
vC, conflicting volume	495	495			495	
vC1, stage 1 conf vol						
vC2, stage 2 conf vol						
vCu, unblocked vol	495	495			495	
tC, single (s)	6.4	6.2			4.1	
tC, 2 stage (s)						
tF (s)	3.5	3.3			2.2	
p0 queue free %	34	82			100	
cM capacity (veh/h)	534	575			1069	
Direction, Lane #	WB 1	WB 2	NB 1	NB 2	SB 1	
Volume Total	355	106	495	564	0	
Volume Left	355	0	0	0	0	
Volume Right	0	106	0	564	0	
cSH	534	575	1700	1700	1700	
Volume to Capacity	0.66	0.18	0.29	0.33	0.00	
Queue Length 95th (ft)	122	17	0	0	0	
Control Delay (s)	24.1	12.7	0.0	0.0	0.0	
Lane LOS	C	B				
Approach Delay (s)	21.5		0.0		0.0	
Approach LOS	C					
Intersection Summary						
Average Delay			6.5			
Intersection Capacity Utilization			37.1%		ICU Level of Service	A
Analysis Period (min)			15			

(1) Southbound through volume of 685 vph would be a non-conflicting movement due to the provision of a dedicated acceleration/merge lane for westbound left-turns.

								
Movement	WBL	WBR	NBU	NBT	NBR	SBL	SBT	
Lane Configurations								
Traffic Volume (veh/h)	20	20	0	470	20	20	665	
Future Volume (Veh/h)	20	20	0	470	20	20	665	
Sign Control	Stop			Free		Free		
Grade	0%			0%		0%		
Peak Hour Factor	0.92	0.92	0.33	0.92	0.92	0.92	0.92	
Hourly flow rate (vph)	22	22	0	511	22	22	723	
Pedestrians								
Lane Width (ft)								
Walking Speed (ft/s)								
Percent Blockage								
Right turn flare (veh)								
Median type				None				None
Median storage (veh)								
Upstream signal (ft)								
pX, platoon unblocked				0.00				
vC, conflicting volume	1278	511	0				533	
vC1, stage 1 conf vol								
vC2, stage 2 conf vol								
vCu, unblocked vol	1278	511	0				533	
tC, single (s)	6.4	6.2	0.0				4.1	
tC, 2 stage (s)								
tF (s)	3.5	3.3	0.0				2.2	
p0 queue free %	88	96	0				98	
cM capacity (veh/h)	180	563	0				1035	
Direction, Lane #	WB 1	NB 1	NB 2	NB 3	SB 1	SB 2		
Volume Total	44	511	22	0	22	723		
Volume Left	22	0	0	0	22	0		
Volume Right	22	0	22	0	0	0		
cSH	272	1700	1700	1700	1035	1700		
Volume to Capacity	0.16	0.30	0.01	0.00	0.02	0.43		
Queue Length 95th (ft)	14	0	0	0	2	0		
Control Delay (s)	20.8	0.0	0.0	0.0	8.6	0.0		
Lane LOS	C			A				
Approach Delay (s)	20.8	0.0				0.3		
Approach LOS	C							
Intersection Summary								
Average Delay				0.8				
Intersection Capacity Utilization				45.0%	ICU Level of Service	A		
Analysis Period (min)				15				

						
Movement	WBL	WBR	NBT	NBR	SBL	SBT
Lane Configurations						
Traffic Volume (veh/h)	65	51	392	116	0	0 (1)
Future Volume (Veh/h)	65	51	392	116	0	0
Sign Control	Stop		Free		Free	
Grade	0%		0%		0%	
Peak Hour Factor	0.33	0.33	0.92	0.33	0.33	0.92
Hourly flow rate (vph)	197	155	426	352	0	0
Pedestrians						
Lane Width (ft)						
Walking Speed (ft/s)						
Percent Blockage						
Right turn flare (veh)						
Median type	None			None		
Median storage (veh)						
Upstream signal (ft)						
pX, platoon unblocked						
vC, conflicting volume	426	426			426	
vC1, stage 1 conf vol						
vC2, stage 2 conf vol						
vCu, unblocked vol	426	426			426	
tC, single (s)	6.4	6.2			4.1	
tC, 2 stage (s)						
tF (s)	3.5	3.3			2.2	
p0 queue free %	66	75			100	
cM capacity (veh/h)	585	628			1133	
Direction, Lane #	WB 1	WB 2	NB 1	NB 2	SB 1	
Volume Total	197	155	426	352	0	
Volume Left	197	0	0	0	0	
Volume Right	0	155	0	352	0	
cSH	585	628	1700	1700	1700	
Volume to Capacity	0.34	0.25	0.25	0.21	0.00	
Queue Length 95th (ft)	37	24	0	0	0	
Control Delay (s)	14.2	12.6	0.0	0.0	0.0	
Lane LOS	B	B				
Approach Delay (s)	13.5		0.0		0.0	
Approach LOS	B					
Intersection Summary						
Average Delay			4.2			
Intersection Capacity Utilization			30.9%	ICU Level of Service	A	
Analysis Period (min)			15			

(1) Southbound through volume of 755 vph would be a non-conflicting movement due to the provision of a dedicated acceleration/merge lane for westbound left-turns.

								
Movement	WBL	WBR	NBU	NBT	NBR	SBL	SBT	
Lane Configurations								
Traffic Volume (veh/h)	20	20	0	423	20	20	735	
Future Volume (Veh/h)	20	20	0	423	20	20	735	
Sign Control	Stop			Free		Free		
Grade	0%			0%		0%		
Peak Hour Factor	0.92	0.92	0.33	0.92	0.92	0.92	0.92	
Hourly flow rate (vph)	22	22	0	460	22	22	799	
Pedestrians								
Lane Width (ft)								
Walking Speed (ft/s)								
Percent Blockage								
Right turn flare (veh)								
Median type				None				None
Median storage (veh)								
Upstream signal (ft)								
pX, platoon unblocked				0.00				
vC, conflicting volume	1303	460	0				482	
vC1, stage 1 conf vol								
vC2, stage 2 conf vol								
vCu, unblocked vol	1303	460	0				482	
tC, single (s)	6.4	6.2	0.0				4.1	
tC, 2 stage (s)								
tF (s)	3.5	3.3	0.0				2.2	
p0 queue free %	87	96	0				98	
cM capacity (veh/h)	174	601	0				1081	
Direction, Lane #	WB 1	NB 1	NB 2	NB 3	SB 1	SB 2		
Volume Total	44	460	22	0	22	799		
Volume Left	22	0	0	0	22	0		
Volume Right	22	0	22	0	0	0		
cSH	269	1700	1700	1700	1081	1700		
Volume to Capacity	0.16	0.27	0.01	0.00	0.02	0.47		
Queue Length 95th (ft)	14	0	0	0	2	0		
Control Delay (s)	21.0	0.0	0.0	0.0	8.4	0.0		
Lane LOS	C			A				
Approach Delay (s)	21.0	0.0				0.2		
Approach LOS	C							
Intersection Summary								
Average Delay				0.8				
Intersection Capacity Utilization				48.7%	ICU Level of Service	A		
Analysis Period (min)				15				

Queuing and Blocking Report
 Long-range Buildout - Alternative 5

AM Peak Hour

Intersection: 3: Skyline Ranch Rd

Movement	WB	NB	SB
Directions Served	LR	TR	LT
Maximum Queue (ft)	85	50	130
Average Queue (ft)	46	15	58
95th Queue (ft)	85	45	129
Link Distance (ft)	192	692	1416
Upstream Blk Time (%)			
Queuing Penalty (veh)			
Storage Bay Dist (ft)			
Storage Blk Time (%)			
Queuing Penalty (veh)			

Intersection: 7: Skyline Ranch Rd

Movement	SE	NW	SW
Directions Served	ULT	TR	LR
Maximum Queue (ft)	520	41	78
Average Queue (ft)	259	9	41
95th Queue (ft)	584	34	74
Link Distance (ft)	671	439	359
Upstream Blk Time (%)	0		
Queuing Penalty (veh)	0		
Storage Bay Dist (ft)			
Storage Blk Time (%)			
Queuing Penalty (veh)			

Intersection: 93: Skyline Ranch Rd & School

Movement	WB	WB
Directions Served	L	R
Maximum Queue (ft)	149	60
Average Queue (ft)	72	32
95th Queue (ft)	136	52
Link Distance (ft)	276	276
Upstream Blk Time (%)	0	
Queuing Penalty (veh)	0	
Storage Bay Dist (ft)		
Storage Blk Time (%)		
Queuing Penalty (veh)		

Queuing and Blocking Report
Long-range Buildout - Alternative 5

AM Peak Hour

Intersection: 97: Park

Movement	WB	SB
Directions Served	LR	L
Maximum Queue (ft)	44	35
Average Queue (ft)	19	6
95th Queue (ft)	39	27
Link Distance (ft)	315	
Upstream Blk Time (%)		
Queuing Penalty (veh)		
Storage Bay Dist (ft)		150
Storage Blk Time (%)		
Queuing Penalty (veh)		

Zone Summary

Zone wide Queuing Penalty: 0

Intersection: 3: Skyline Ranch Rd

Movement	WB	NB	SB
Directions Served	LR	TR	LT
Maximum Queue (ft)	47	75	1349
Average Queue (ft)	23	37	917
95th Queue (ft)	51	79	1646
Link Distance (ft)	192	692	1416
Upstream Blk Time (%)			21
Queuing Penalty (veh)			0
Storage Bay Dist (ft)			
Storage Blk Time (%)			
Queuing Penalty (veh)			

Intersection: 7: Skyline Ranch Rd

Movement	SE	NW	SW
Directions Served	ULT	TR	LR
Maximum Queue (ft)	250	68	57
Average Queue (ft)	97	27	28
95th Queue (ft)	242	65	56
Link Distance (ft)	671	439	359
Upstream Blk Time (%)			
Queuing Penalty (veh)			
Storage Bay Dist (ft)			
Storage Blk Time (%)			
Queuing Penalty (veh)			

Intersection: 93: Skyline Ranch Rd & School

Movement	WB	WB
Directions Served	L	R
Maximum Queue (ft)	77	63
Average Queue (ft)	38	37
95th Queue (ft)	71	59
Link Distance (ft)	276	276
Upstream Blk Time (%)		
Queuing Penalty (veh)		
Storage Bay Dist (ft)		
Storage Blk Time (%)		
Queuing Penalty (veh)		

Queuing and Blocking Report
Long-range Buildout - Alternative 5

PM Peak Hour

Intersection: 97: Park

Movement	WB	SB
Directions Served	LR	L
Maximum Queue (ft)	52	31
Average Queue (ft)	20	4
95th Queue (ft)	43	21
Link Distance (ft)	315	
Upstream Blk Time (%)		
Queuing Penalty (veh)		
Storage Bay Dist (ft)		150
Storage Blk Time (%)		
Queuing Penalty (veh)		

Zone Summary

Zone wide Queuing Penalty: 0

To:	Scott Ashlock	From:	Daryl Zerfass
	Placeworks		Stantec
File:	2073009990	Date:	December 5, 2016

Reference: Skyline Ranch (Revised VTTM 060922) Land Use and Trip Generation Update

This memorandum addresses updates to the residential unit mix and the total number of units for the Skyline Ranch Revised Tract Map No. 060922, and the resulting change in trip generation. Skyline Ranch (Revised VTTM 060922), is a development project located in the Santa Clarita Valley area of unincorporated Los Angeles County. In October 2008, a Traffic Impact Analysis was approved by the County of Los Angeles Department of Public works (LADPW) and in October 2016, the Skyline Ranch (Revised VTTM 060922) On-Site Roadway Analysis, prepared by Stantec, was approved by LADPW.

The On-Site Roadway Analysis evaluated the on-site roadway system for the revised VTTM 060922, and was based on 1,035 single-family residential units, 165 detached condominium units (a total of 1,200 residential units), an elementary school and a public park. The mix and total number of residential units have since changed slightly from a total of 1,200 units to 1,220 units, a net increase of 20 units. The attached Table 1 summarizes the land use and the corresponding trip generation and gives a comparison between the land use assumed in the approved On-Site Roadway Analysis, and the most recent VTTM 060922 land use.

Although the total number of residential units increased by 20 units, the change in the mix of residential units resulted in less net trips generated by VTTM 060922. Specifically, 82 less daily trips (ADT), 22 less AM peak hour trips, and 29 less PM peak hour trips. Therefore, the approved Skyline Ranch (Revised VTTM 060922) On-Site Roadway Analysis represents a conservative worst-case scenario and the subsequent change in net trips is negligible.

Stantec Consulting Services Inc.

Daryl Zerfass, PE, PTP
Principal, Transportation Planning & Traffic Engineering
Phone: (949) 923-6058
Daryl.Zerfass@stantec.com

Attachment: Table 1 Land Use and Trip Generation Comparison

Table 1: Land Use and Trip Generation Comparison

Land Use	Amount	Units	AM Peak Hour			PM Peak Hour			ADT
			IB	OB	Total	IB	OB	Total	
Trip Rates									
Single Family (210)		DU	0.19	0.56	0.75	0.63	0.37	1.00	9.52
Detached Condominium		DU	0.06	0.48	0.54	0.47	0.26	0.73	8.00
Elementary School (520)		STU	0.25	0.20	0.45	0.13	0.15	0.28	1.29
Land Use and Trip Generation in the On-Site Roadway Analysis (October 2016)									
Single Family	1,035	DU	194	582	776	652	383	1,035	9,853
Detached Condominium	165	DU	10	79	89	78	43	121	1,320
Total Residential			204	661	865	730	426	1,156	11,173
Elementary School	750	STU	186	152	338	--	--	--	968
Total			390	813	1,203	730	426	1,156	12,141
Revised Land Use and Trip Generation (VTM 060922)									
Single Family	876	DU	164	493	657	552	324	876	8,340
Detached Condominium	344	DU	21	165	186	162	89	251	2,752
Total Residential			185	658	843	714	413	1,127	11,092
Elementary School	750	STU	186	152	338	--	--	--	968
Total			371	810	1,181	714	413	1,127	12,059
Net Difference									
			-19	-3	-22	-16	-13	-29	-82
<p><u>Trip Rate Source:</u> Single Family & Elementary School: Institute of Transportation Engineers (ITE), 9th Edition, 2012. Condominium: Los Angeles County Department of Public Works Traffic Impact Analysis Report Guidelines, 1997.</p> <p><u>Notes:</u> DU = dwelling unit; STU = student; ADT = average daily trips; IB = inbound; OB = outbound</p> <p>The volume of off-off site elementary school traffic in the PM peak hour was considered negligible in the 2008 traffic study.</p>									